



MINECRAFT

21243





LEGO.com/sustainable-packaging



BUILDER



Apple and the Apple logo are trademarks of Apple Inc., registered in the U.S. and other countries and regions. App Store is a service mark of Apple Inc. Google Play and the Google Play logo are trademarks of Google LLC. Tencent and the Tencent logo are trademarks of Tencent Inc.

LEGO.com/devicecheck

EN Ask parents' permission before going online | DE Eltern um Erlaubnis bitten, bevor du online gehst | FR Demande l'autorisation d'un parent avant d'aller en ligne | IT Chiedi il permesso ai tuoi genitori prima di andare online | ES Pídeles permiso a tus papás antes de conectarte a Internet | PT pede autorização aos pais antes de acederes online | JA オンラインになる前にほご者の方のきよかをもらおう | ZH 上网前应先征得父母的同意 | KO 온라인 접속 전에 보호자 동의가 필요합니다 | RU Спроси разрешения у родителей, прежде чем заходить в интернет | PL Poproś rodziców o zgodę, zanim wejdiesz do Internetu | CS Než půjdeš na internet, požádej rodiče o svolení | SK Skôr než pôjdeš na internet, vypýtaj si povolenie od rodičov | HU Kérj szülői engedélyt, mielőtt online csatlakoznál! | RO Cere permisiunea părinților înainte de a te conecta online | BG Поискайте разрешение от родител, преди да влезете онлайн | LV Pirms došanās tiešsaistē palūdz atļauju vecākiem | ET Enne Interneti kasutamist küsi vanematelt luba | LT Prieš prisijungdami prie interneto, atsiklauskite tėvų

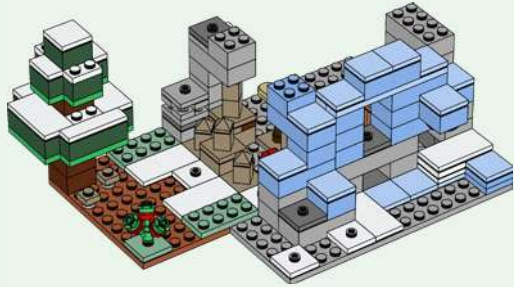
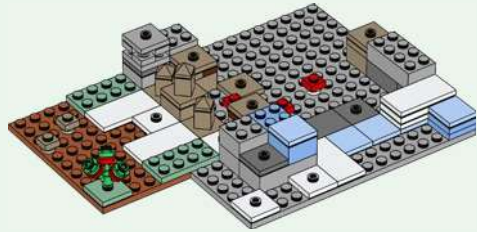

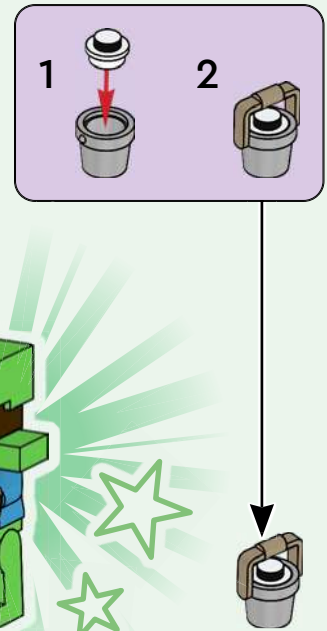
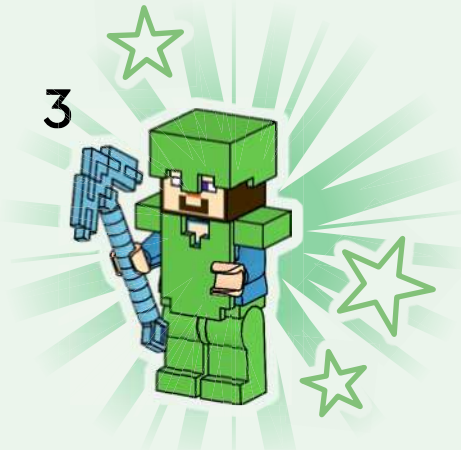
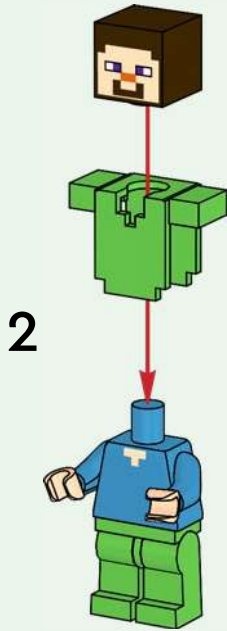
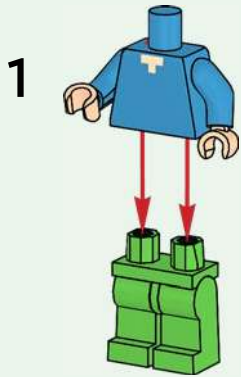
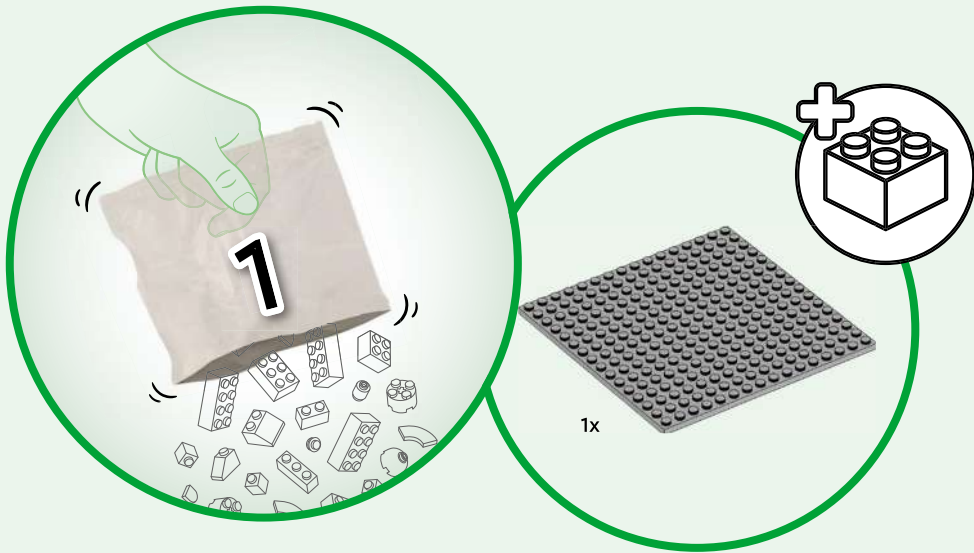



2x

1

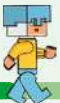
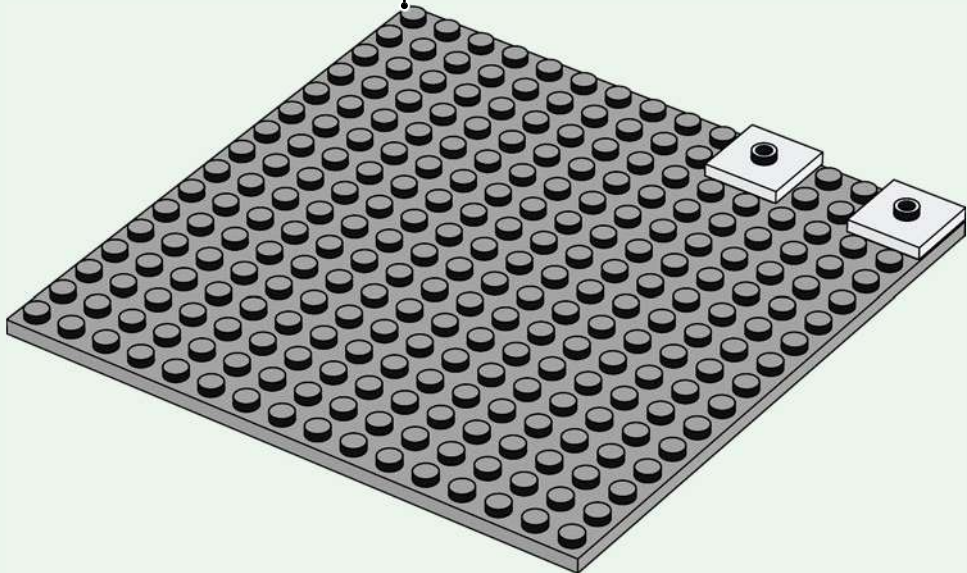
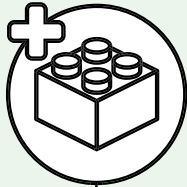

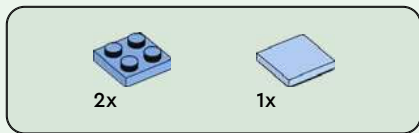

2

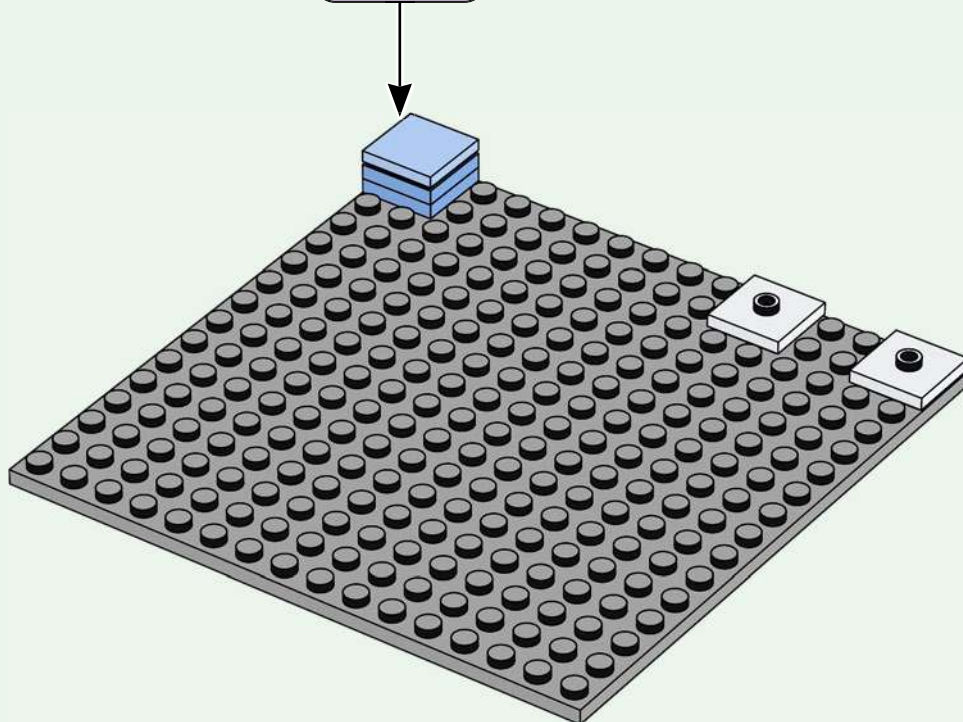
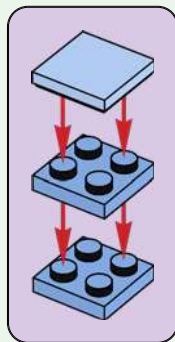

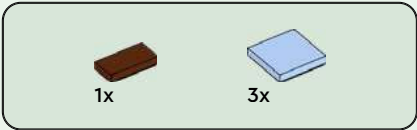

3

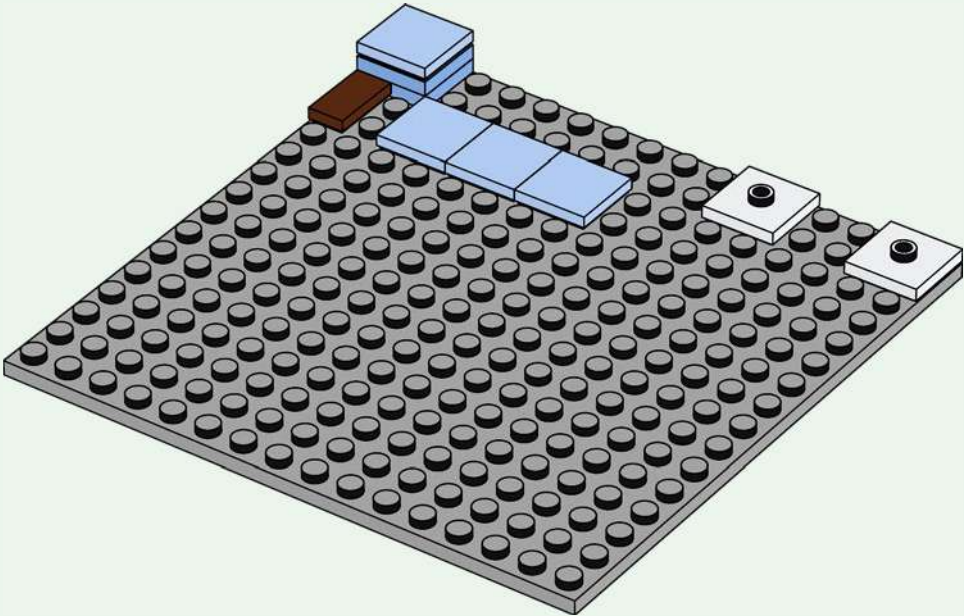

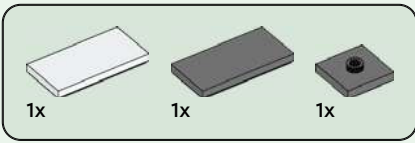

4

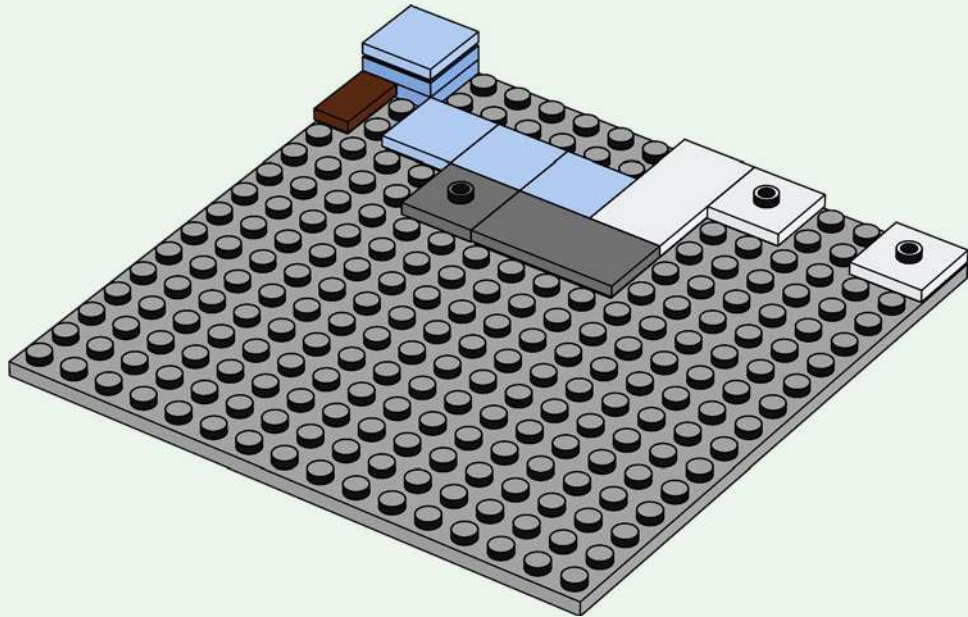



2x

5

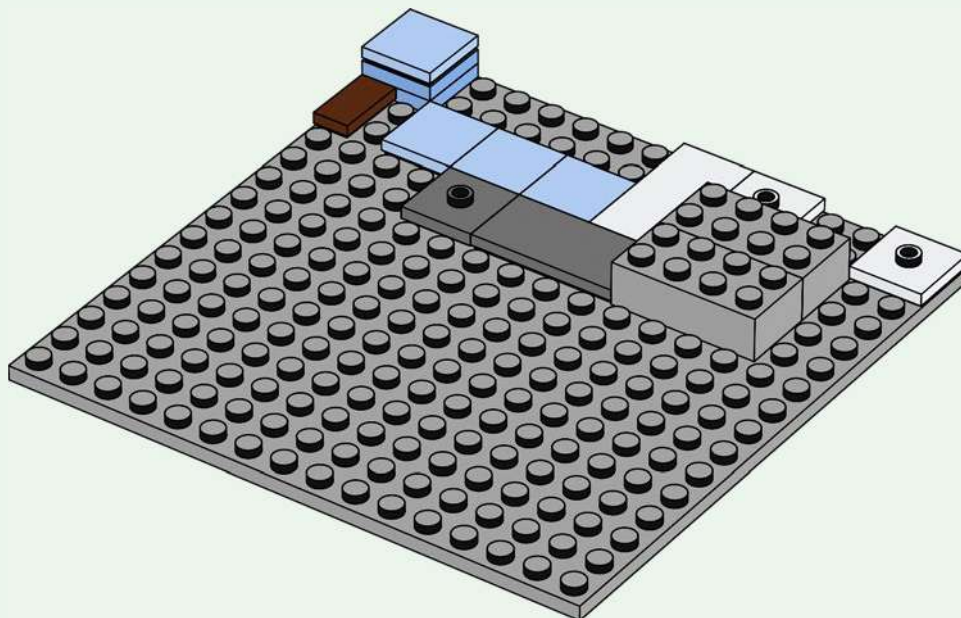

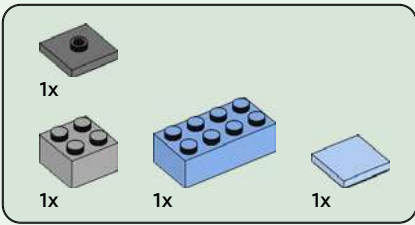

6

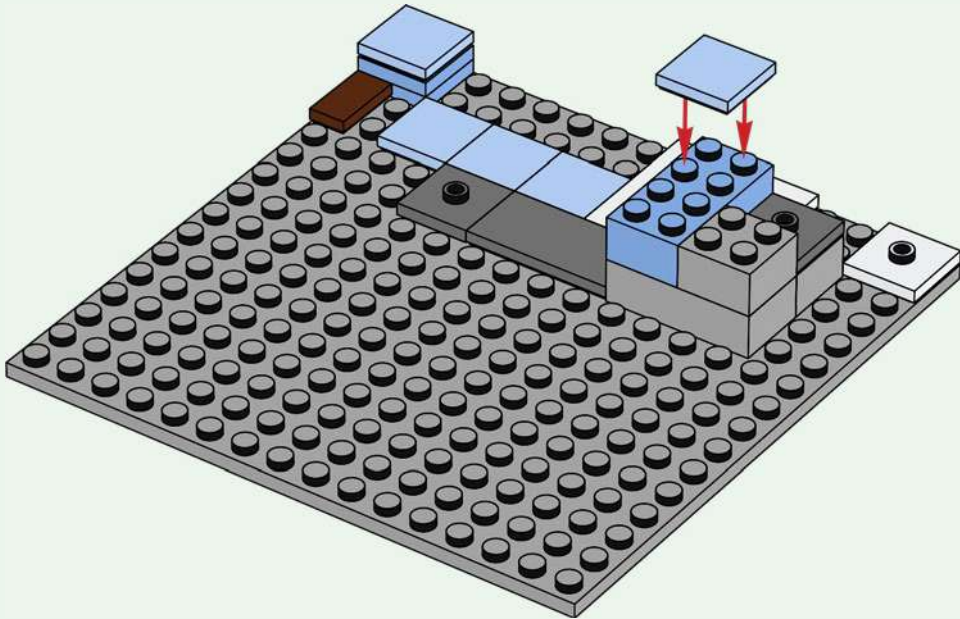

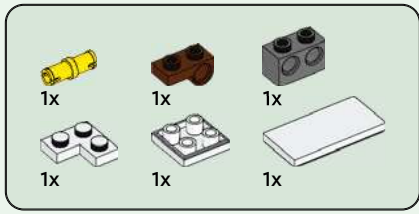

7

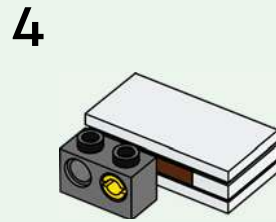
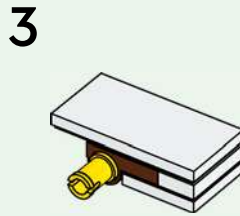
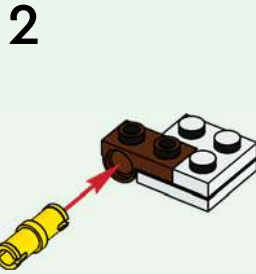
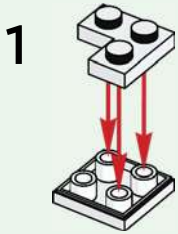

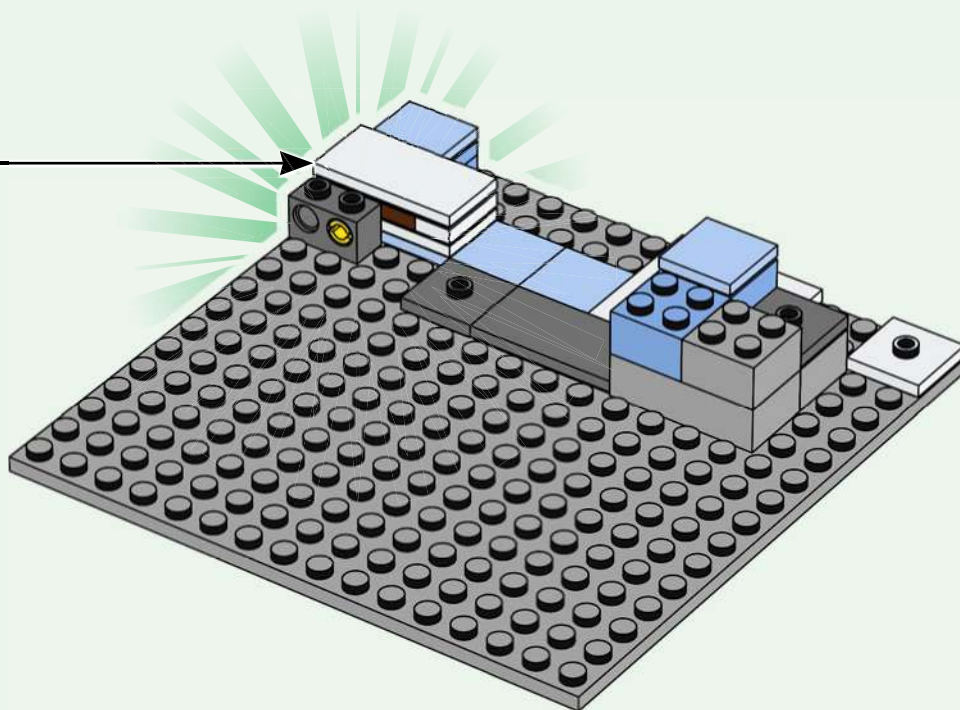



1x

8

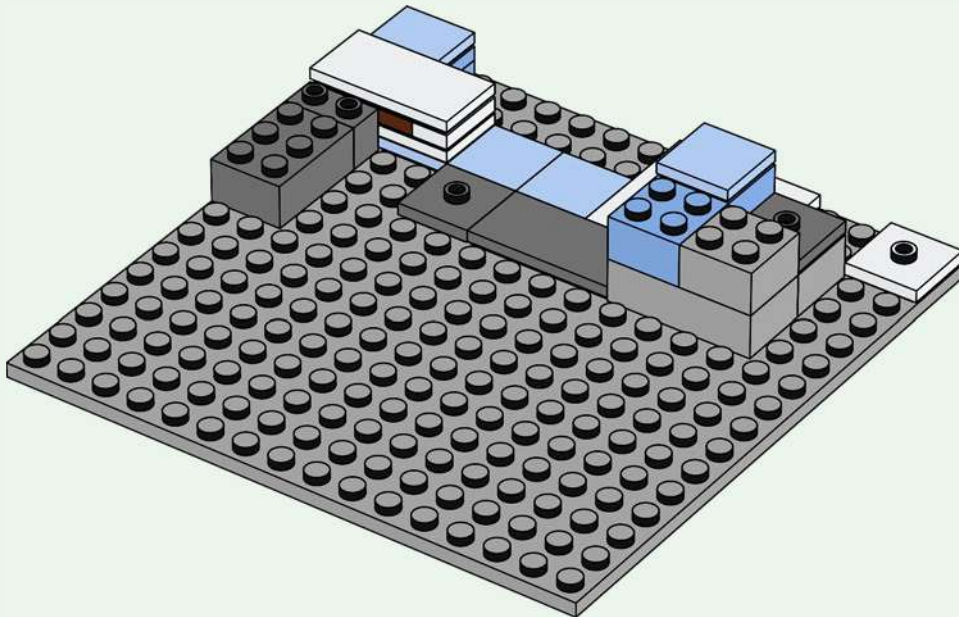

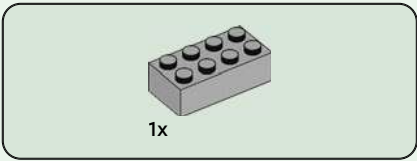

9

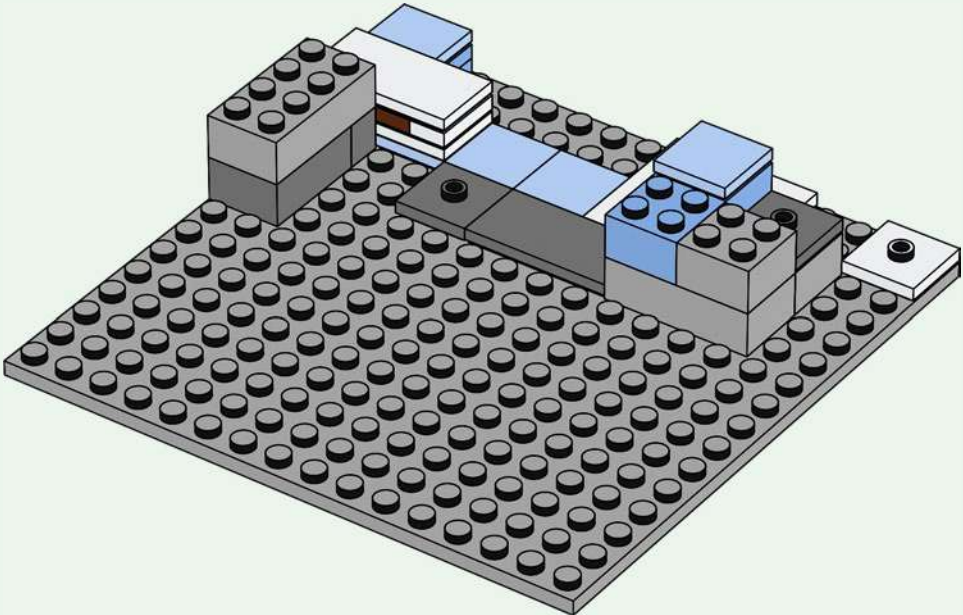

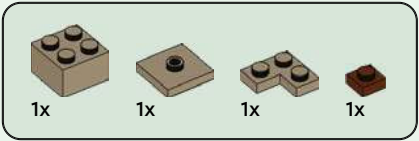

10

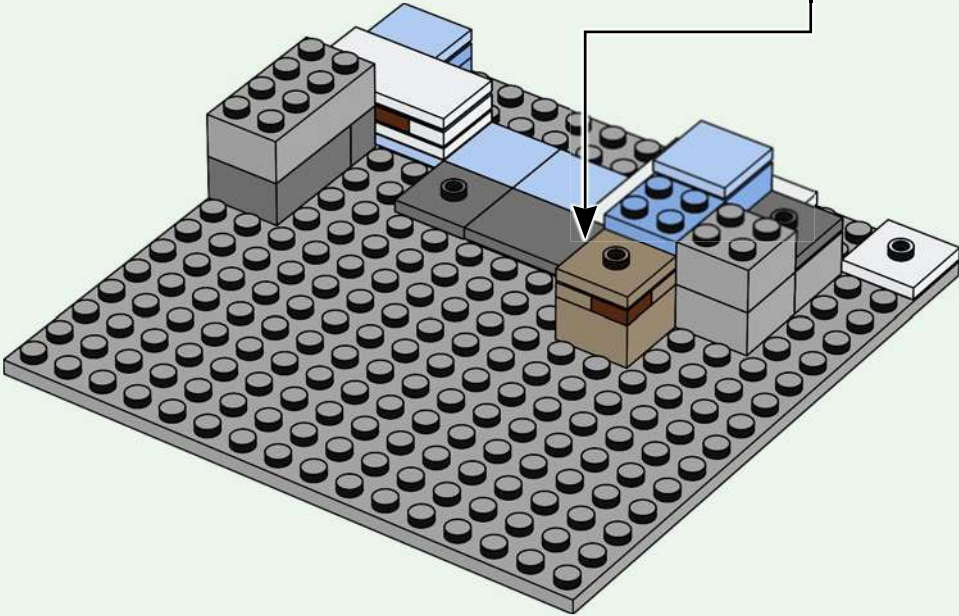
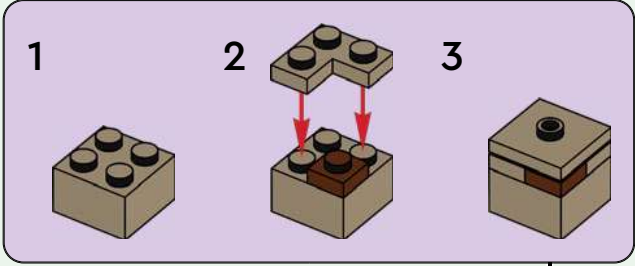



3x



3x

11

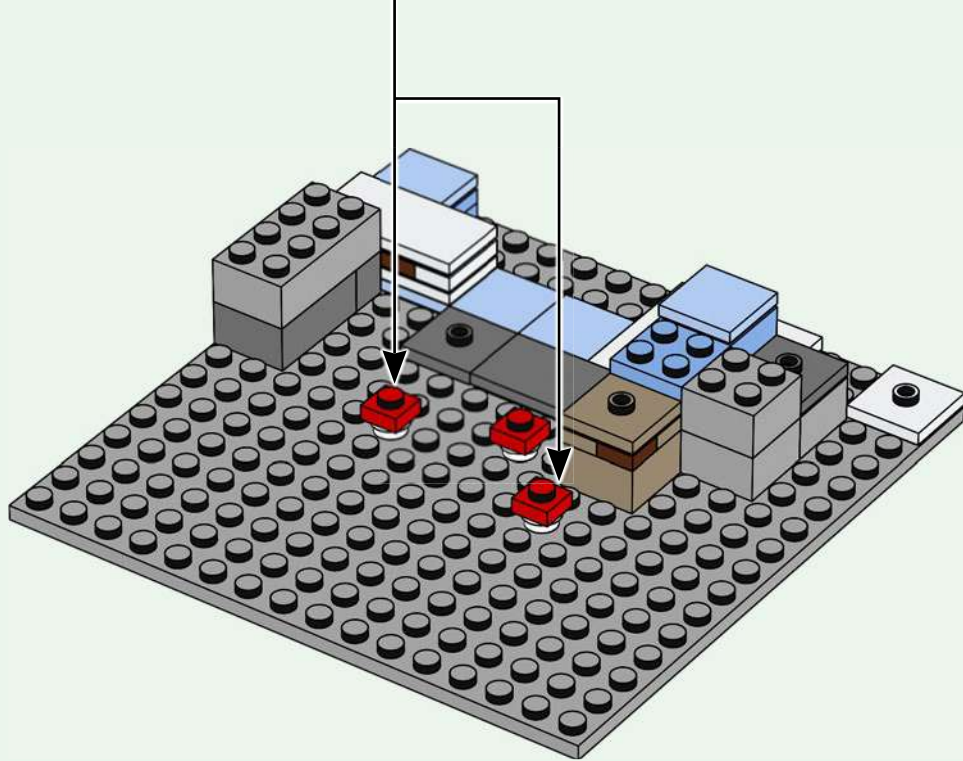
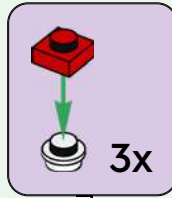



1x



1x

12

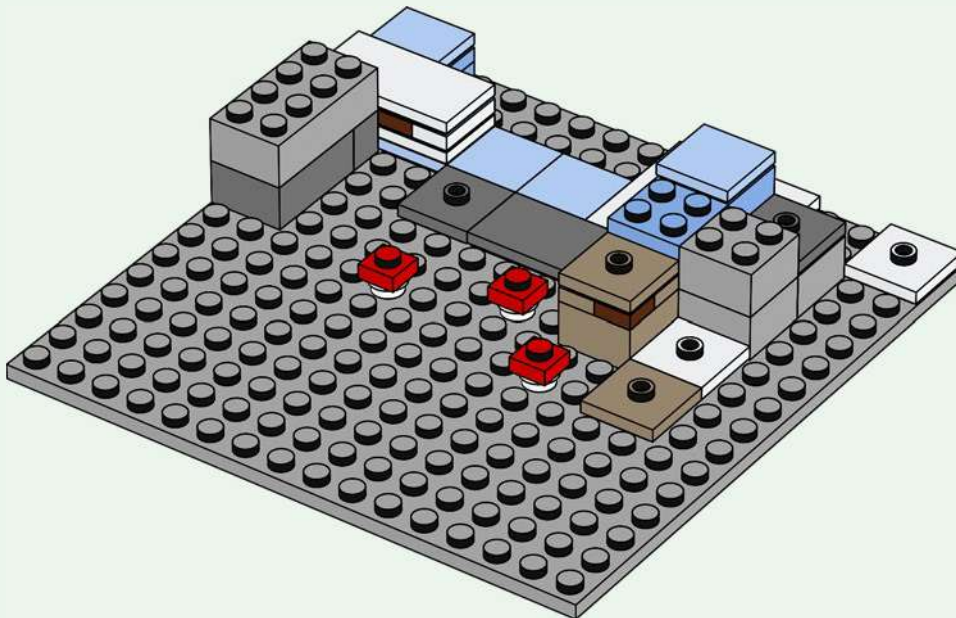

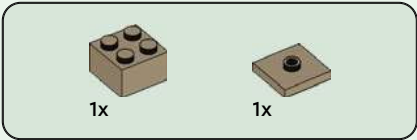

13

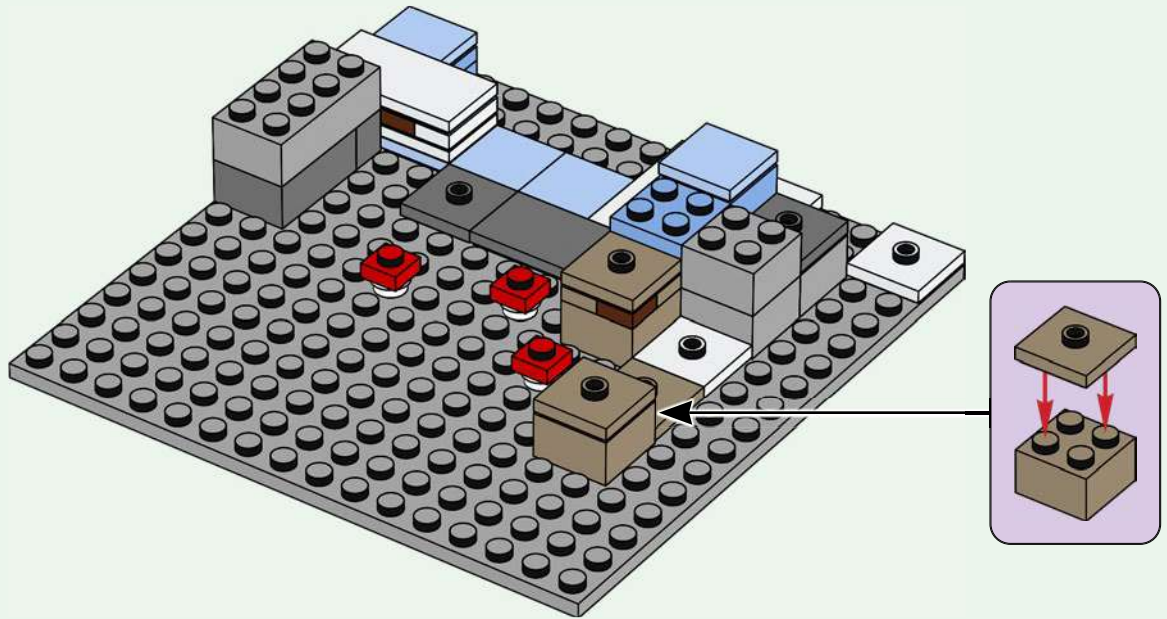



2x

14

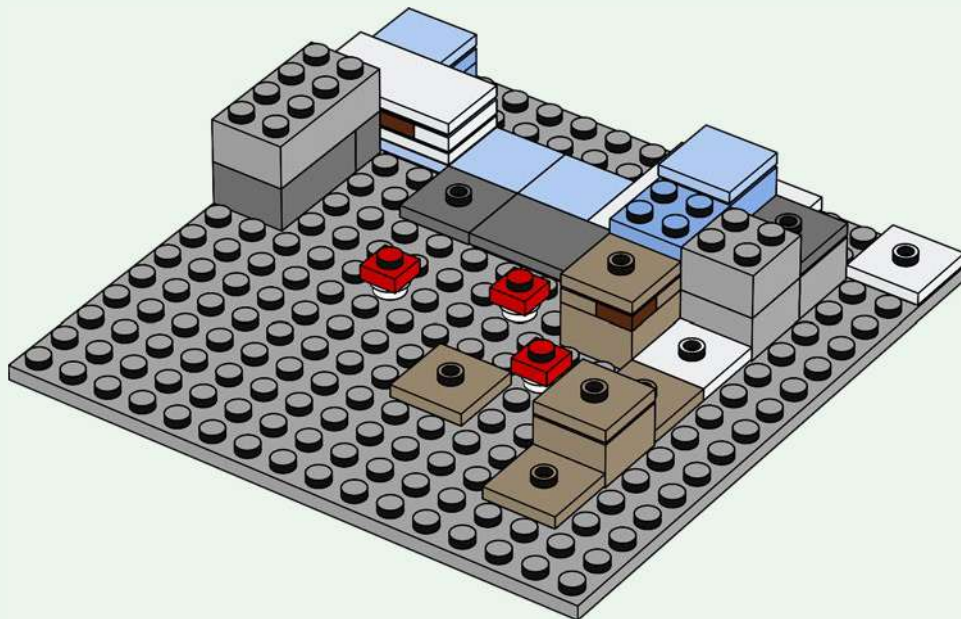

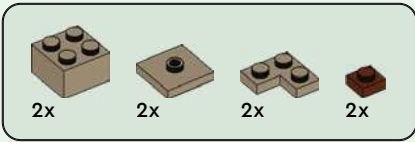

15

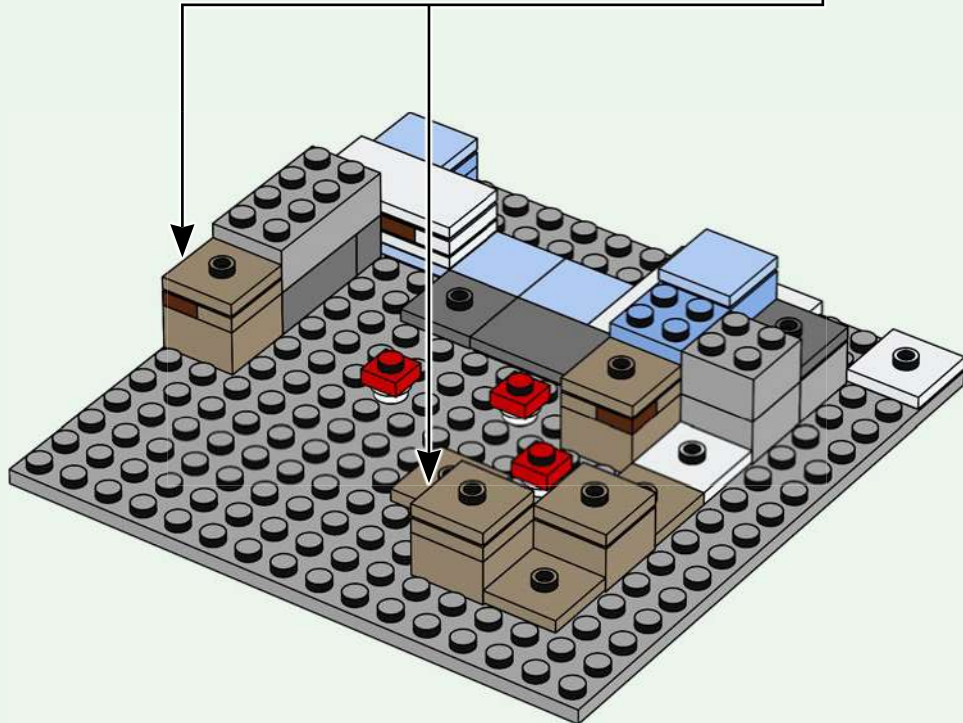
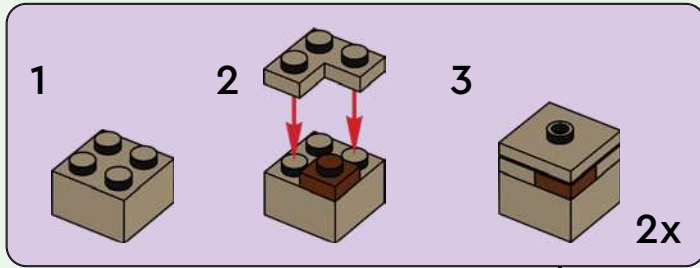



3x



3x

16

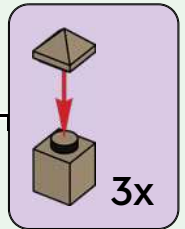
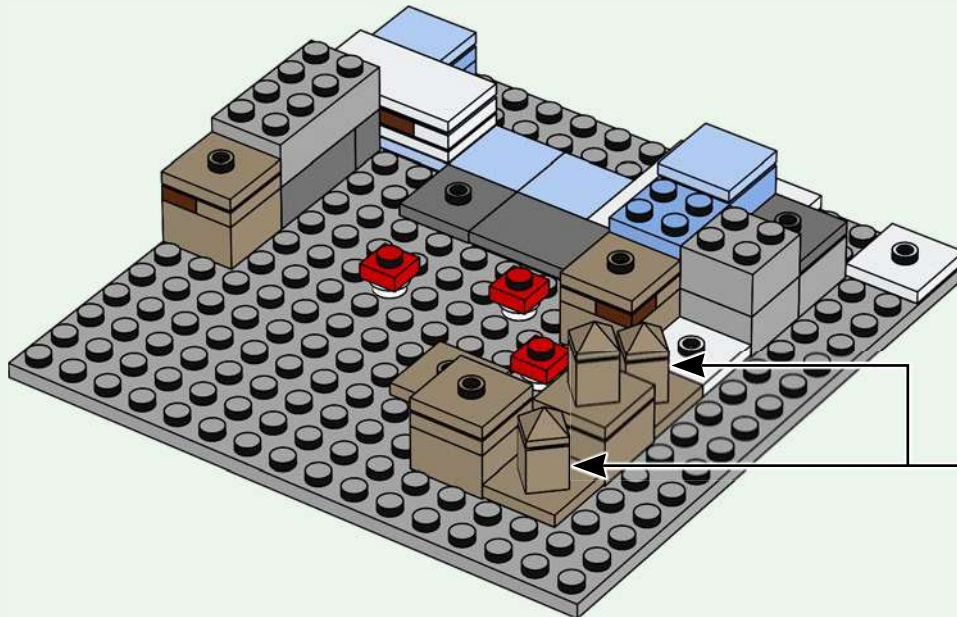

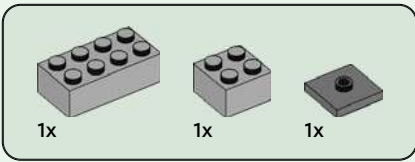

17

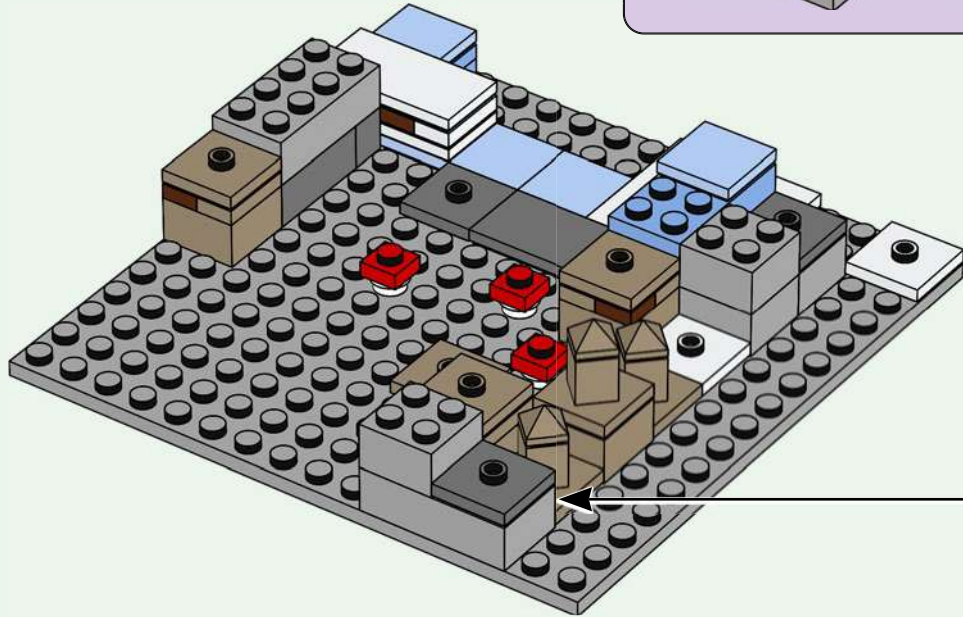
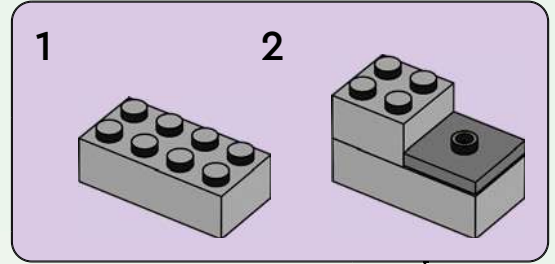

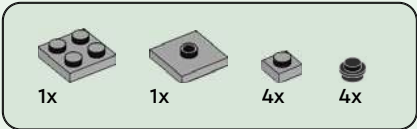

18

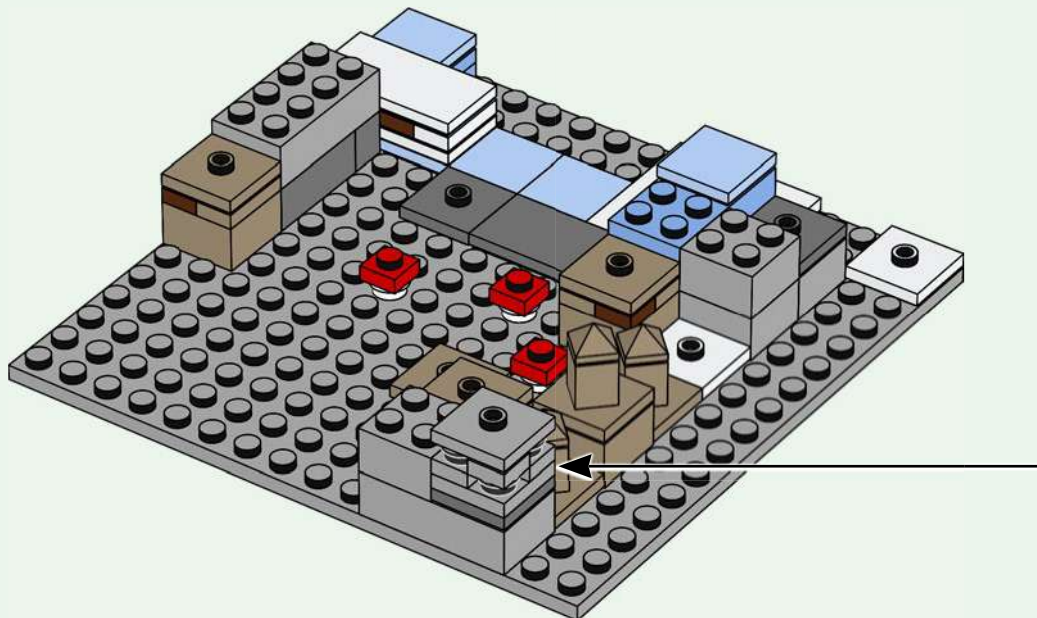
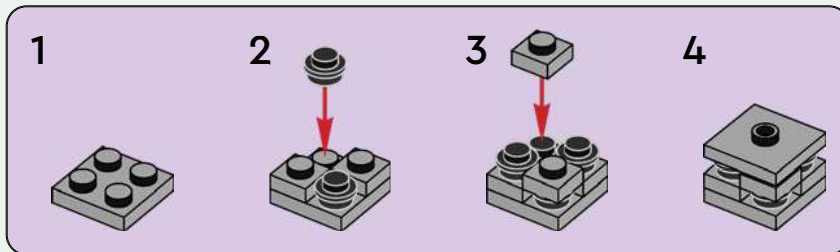

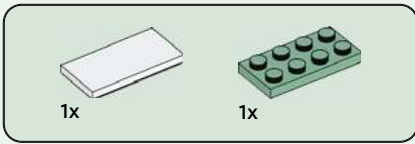

19

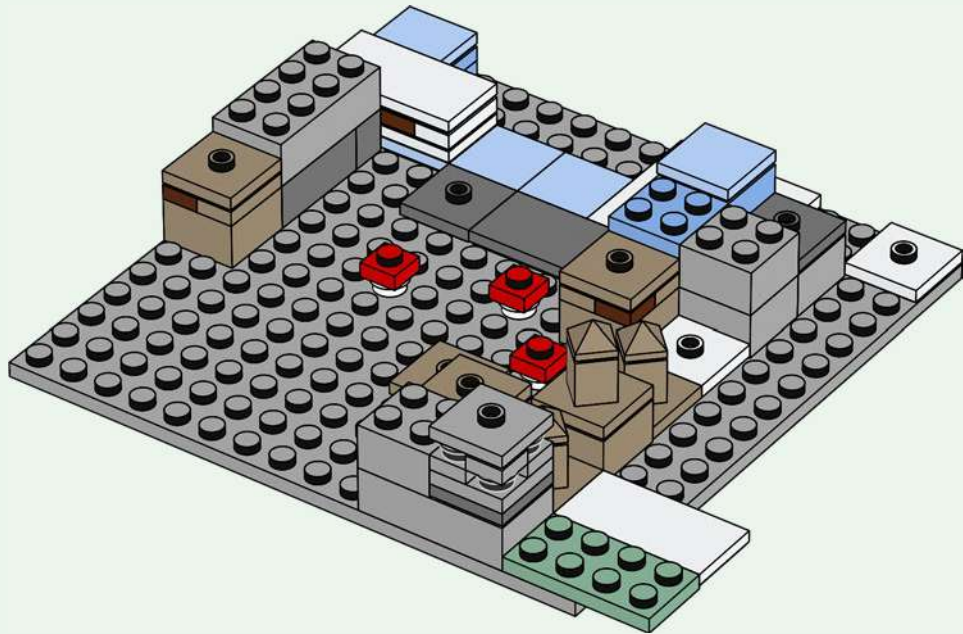

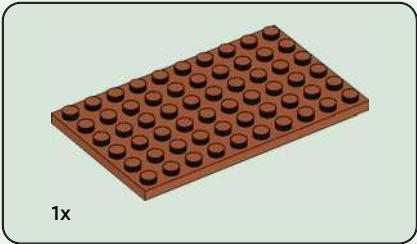

20

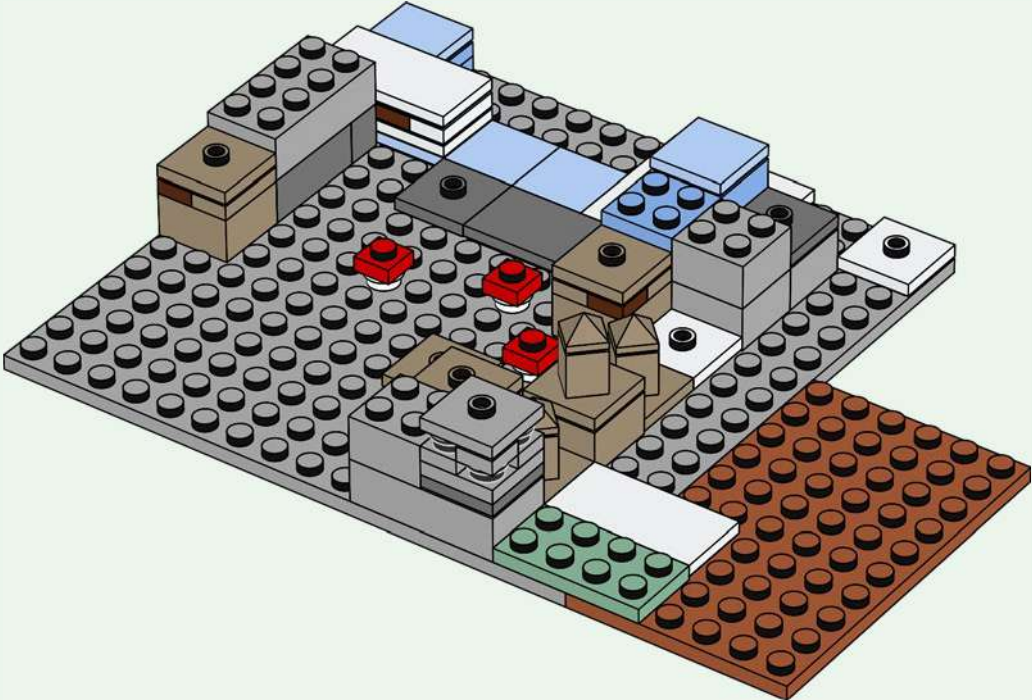

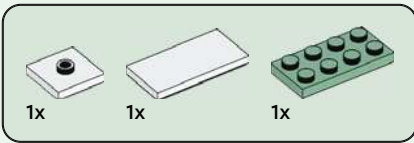

21

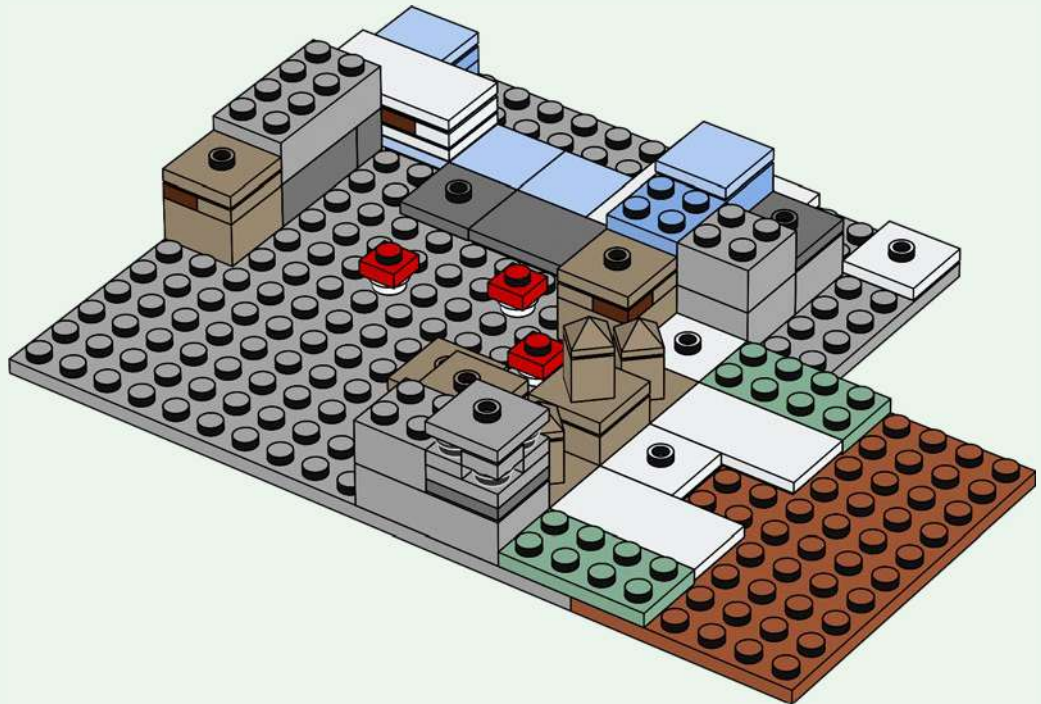

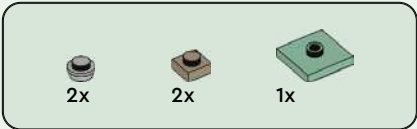

22

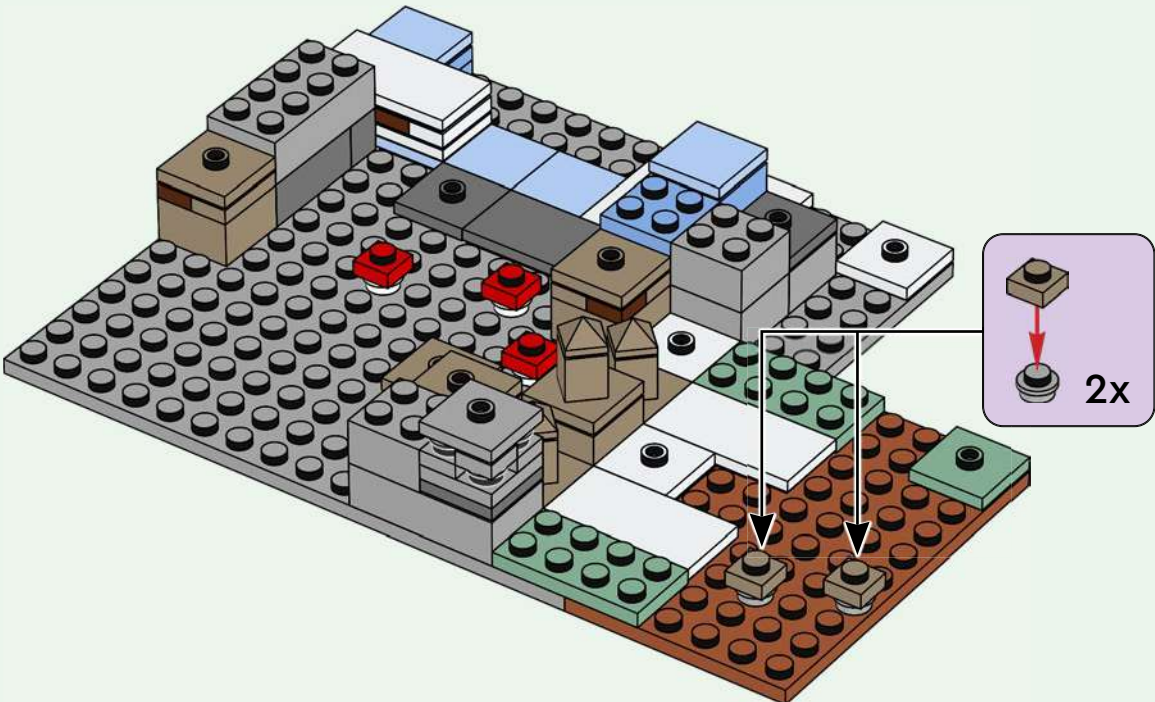



23

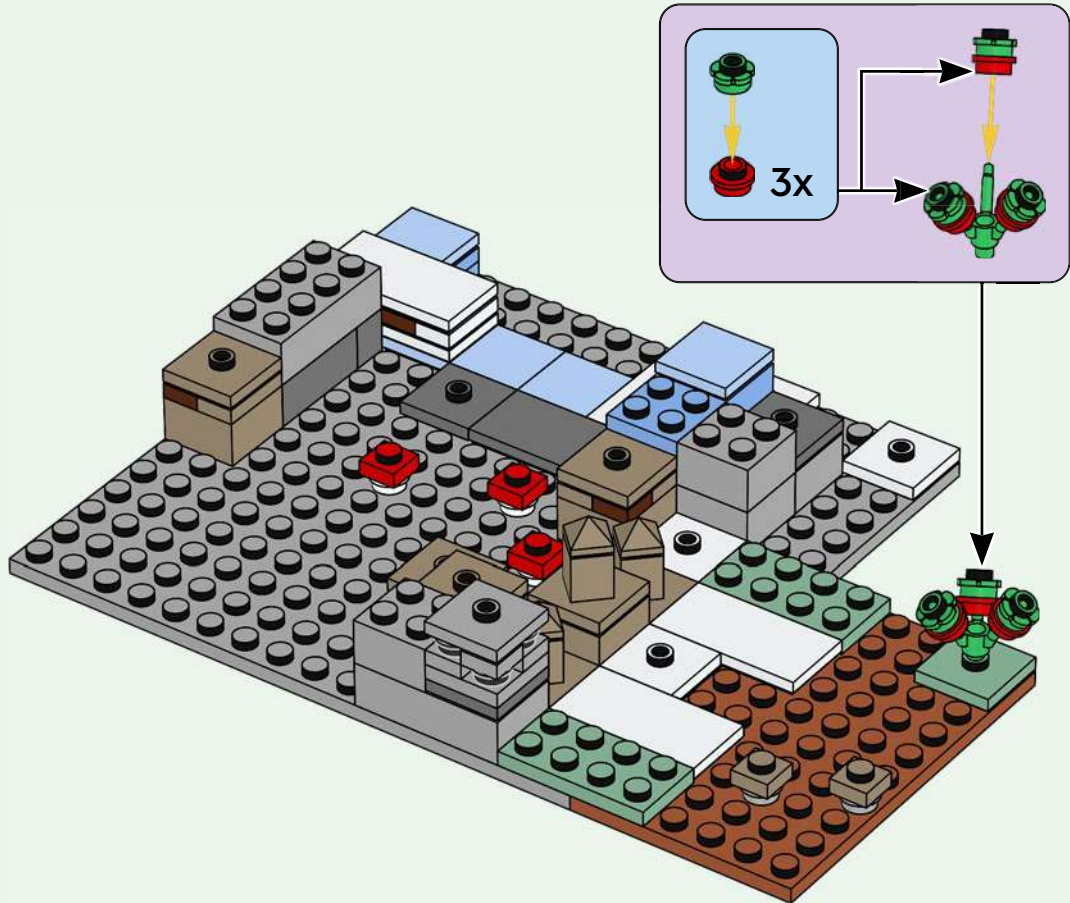

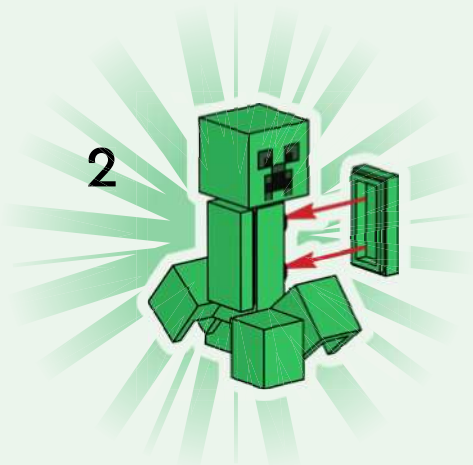
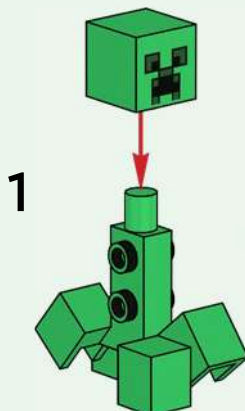

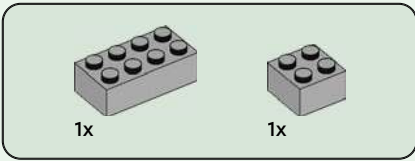

24

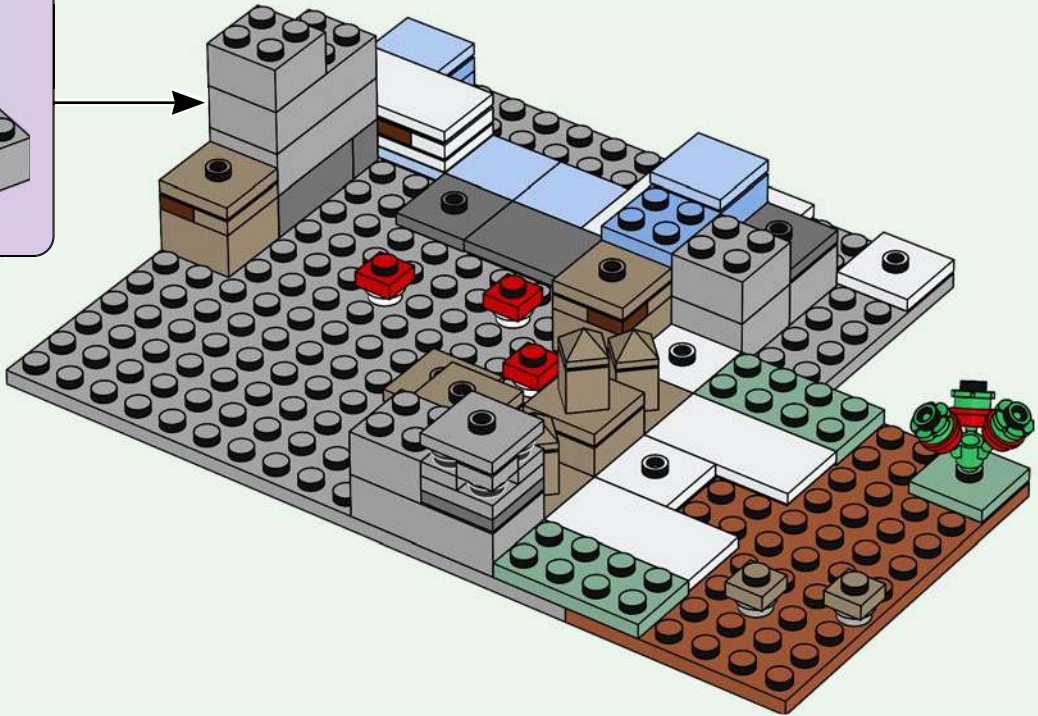
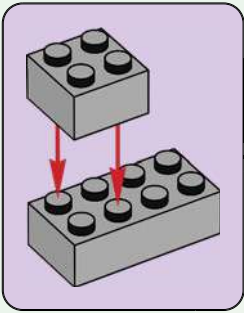

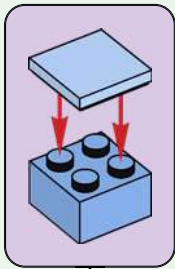
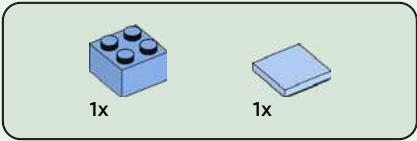

25

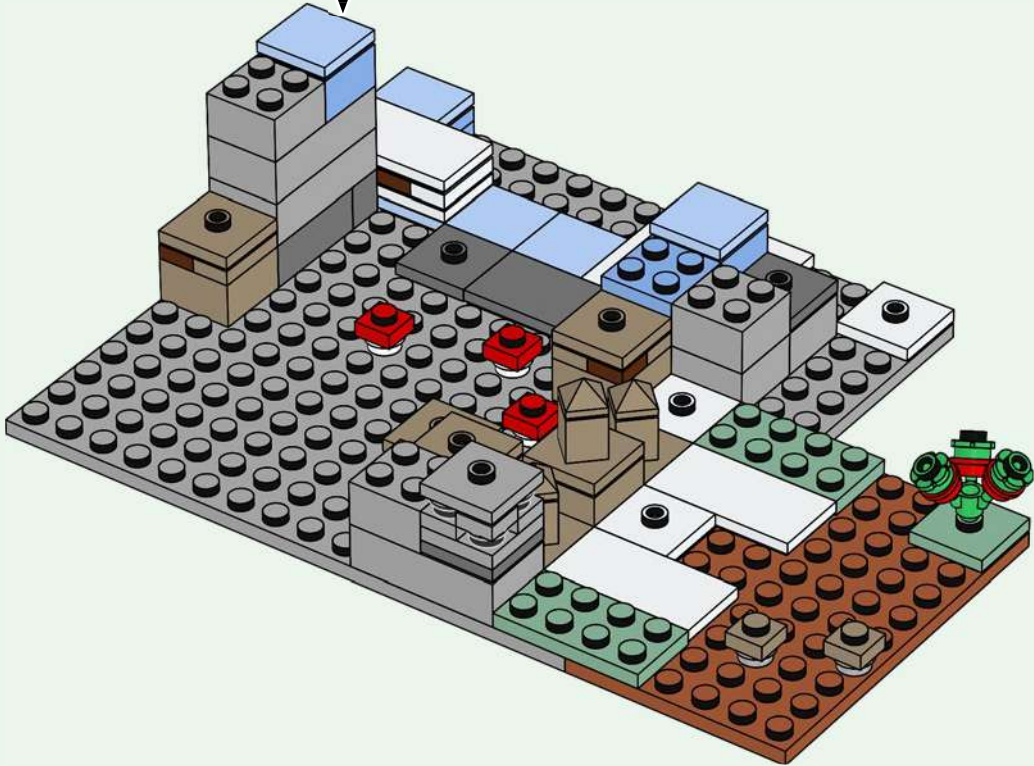

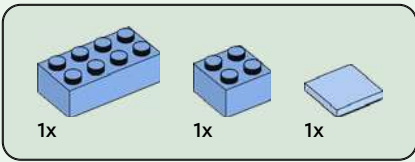

26

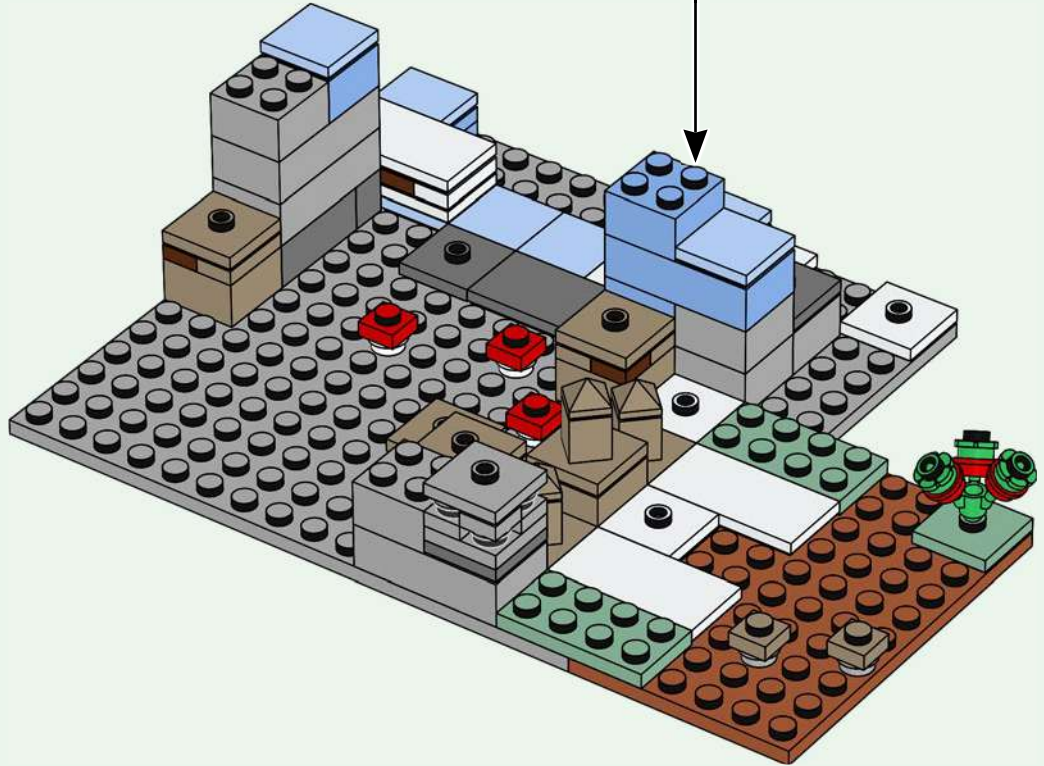
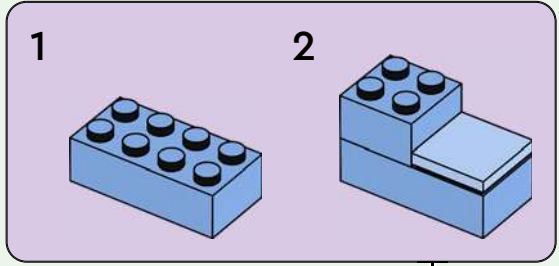

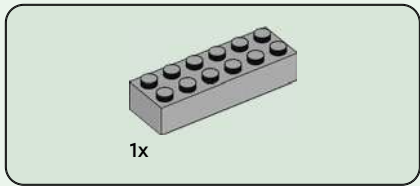

27

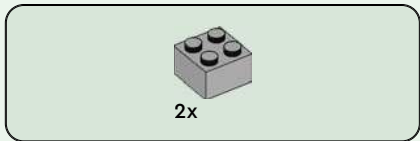
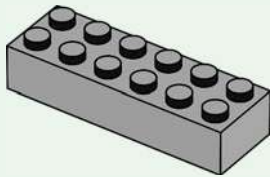

28

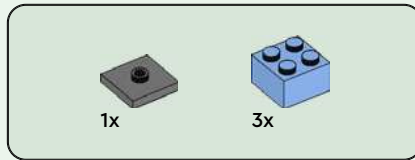
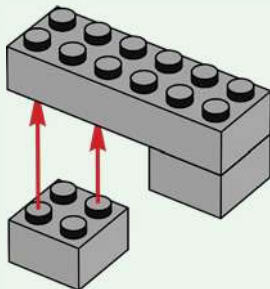

29

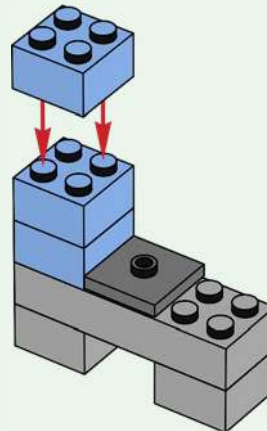

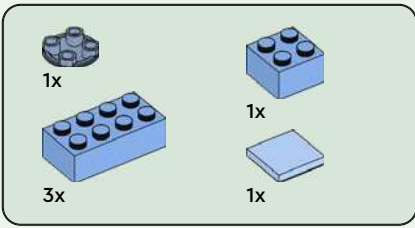

30

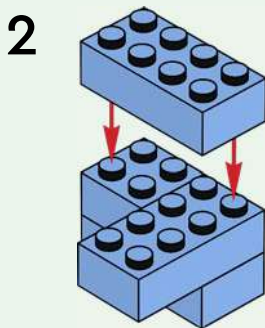
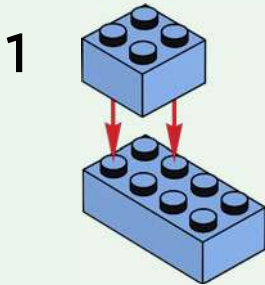

3

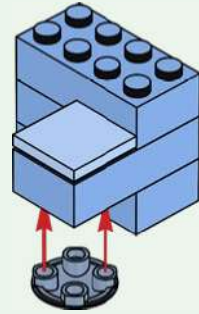

31

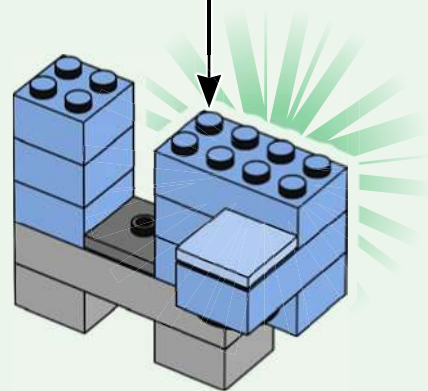

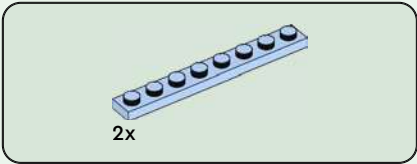

32

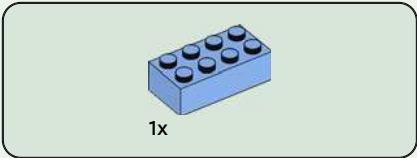
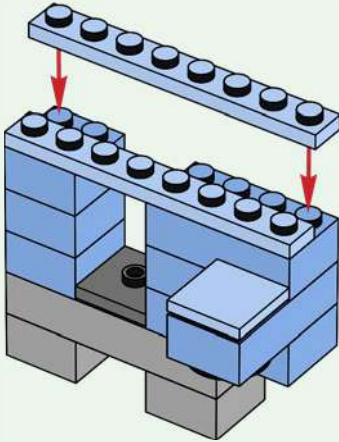

33

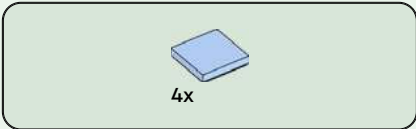
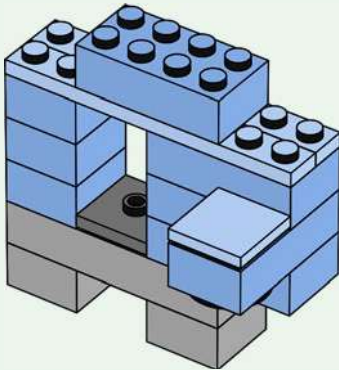

34

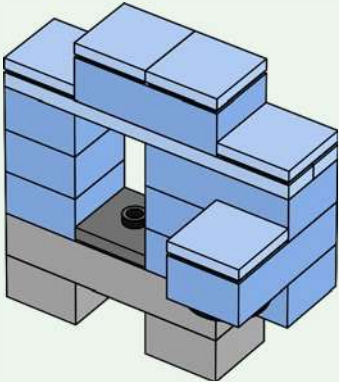

35

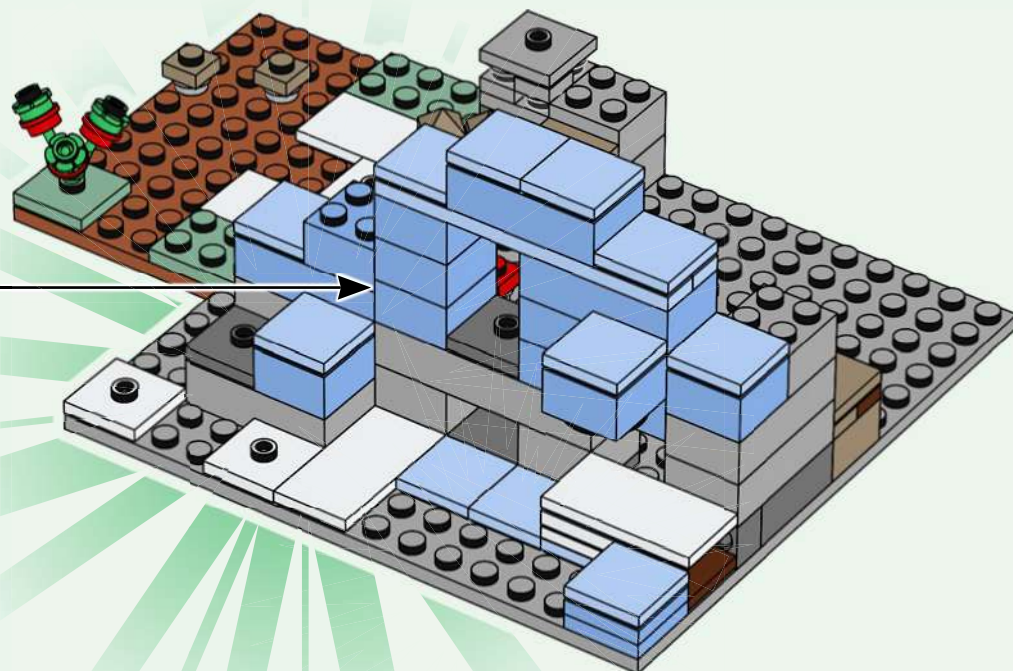



36

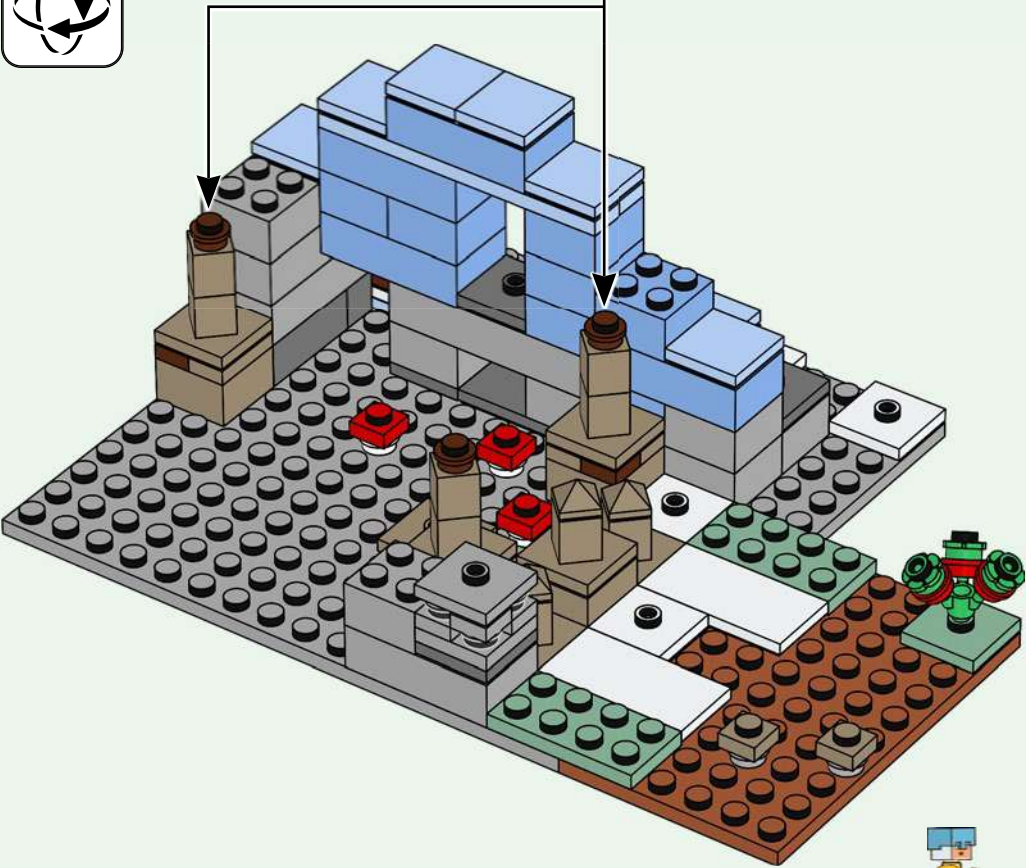
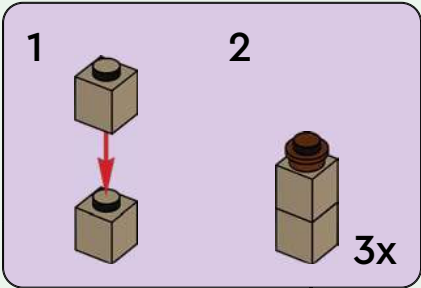

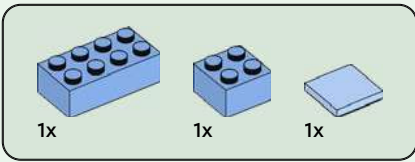

37

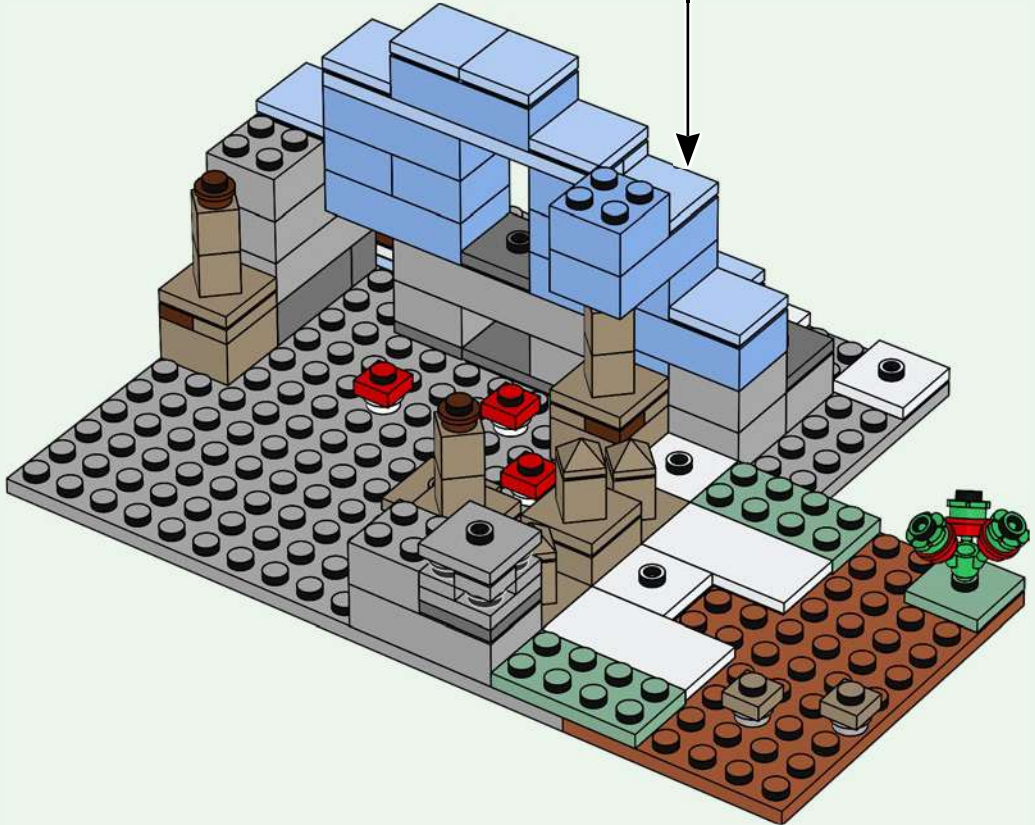
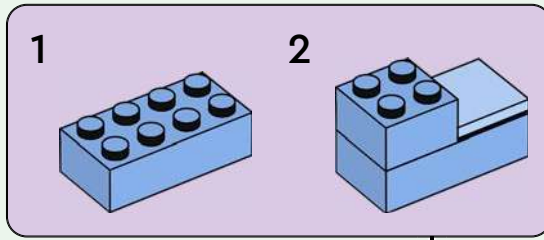



2x

38

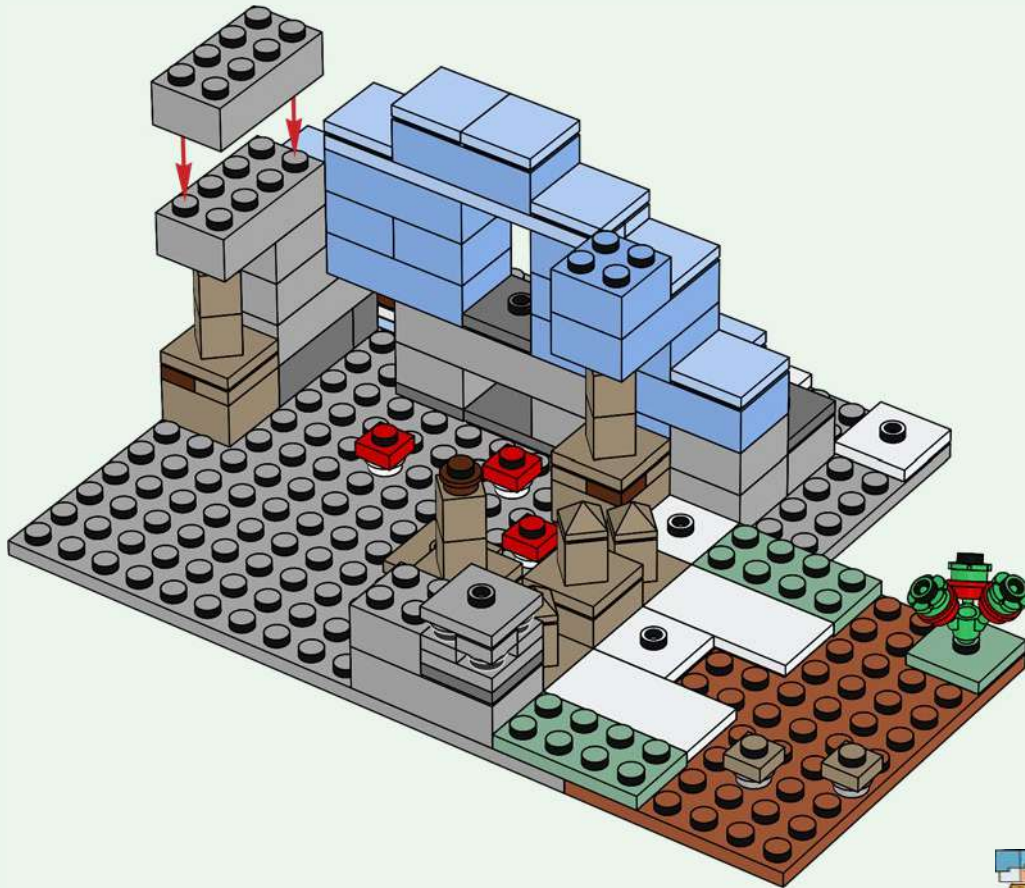



2x

39

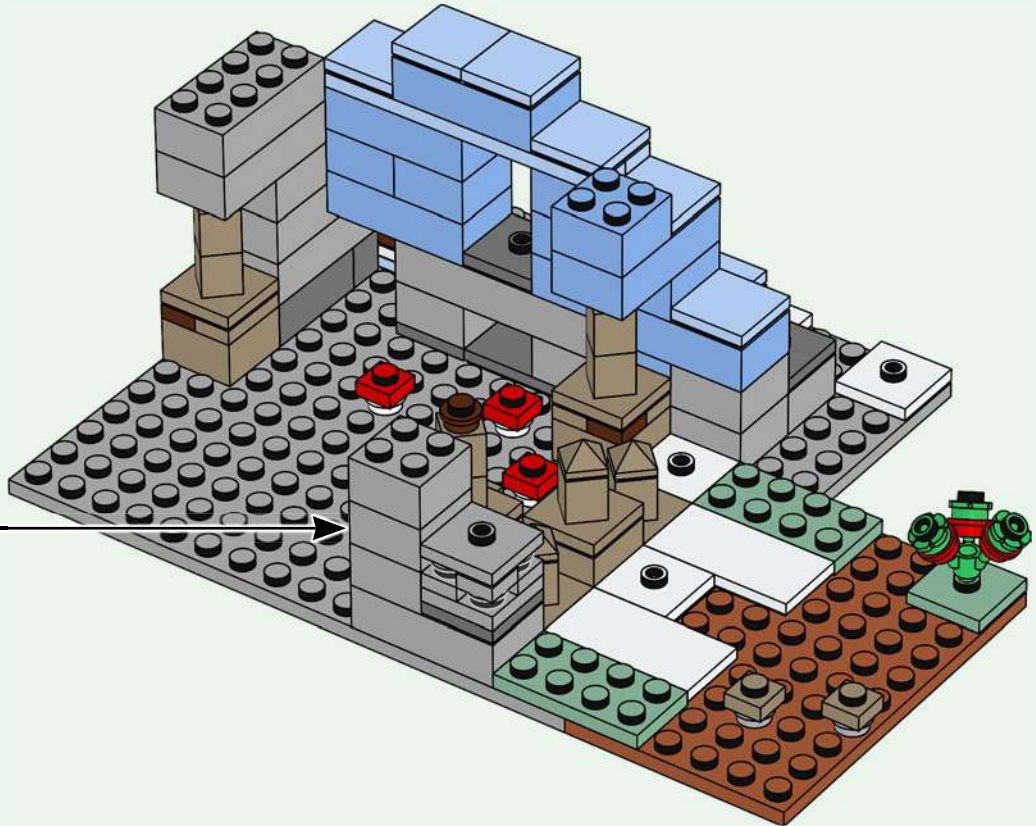
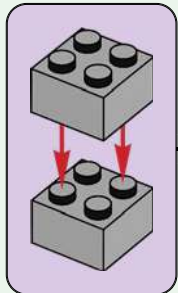

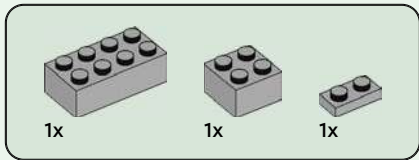

40

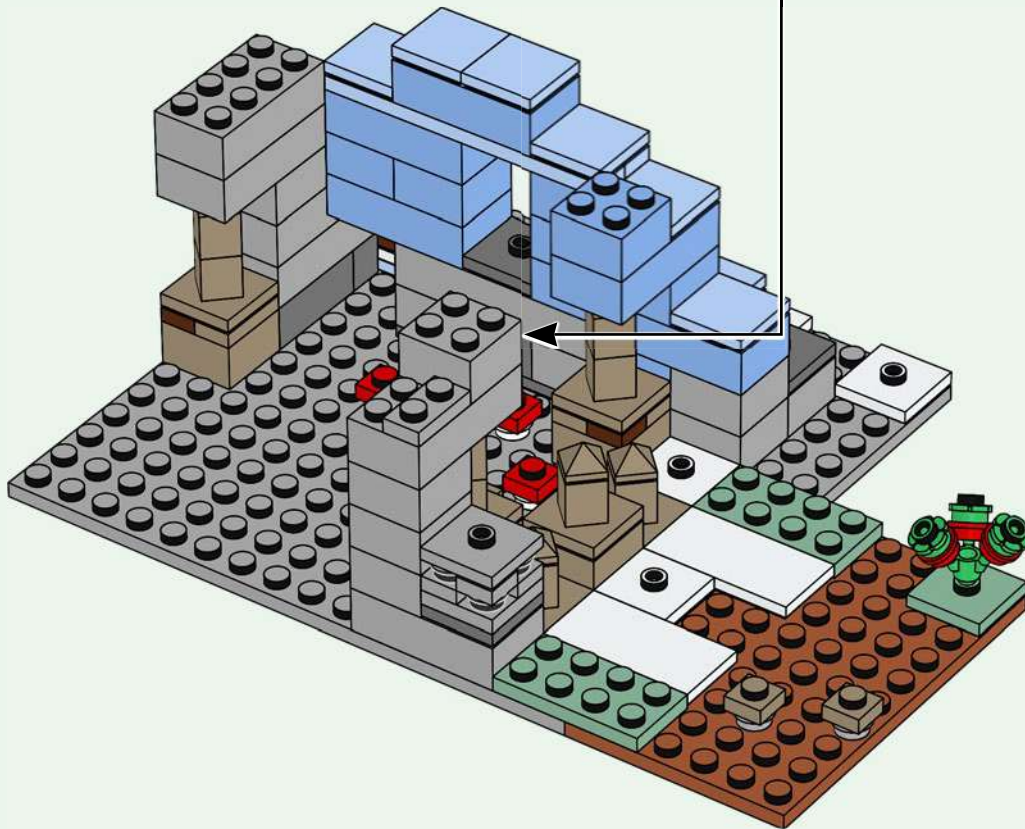
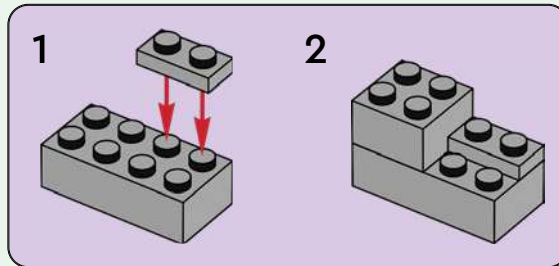

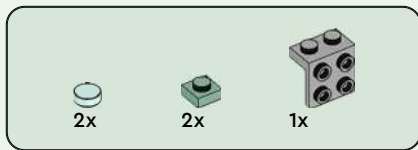

41

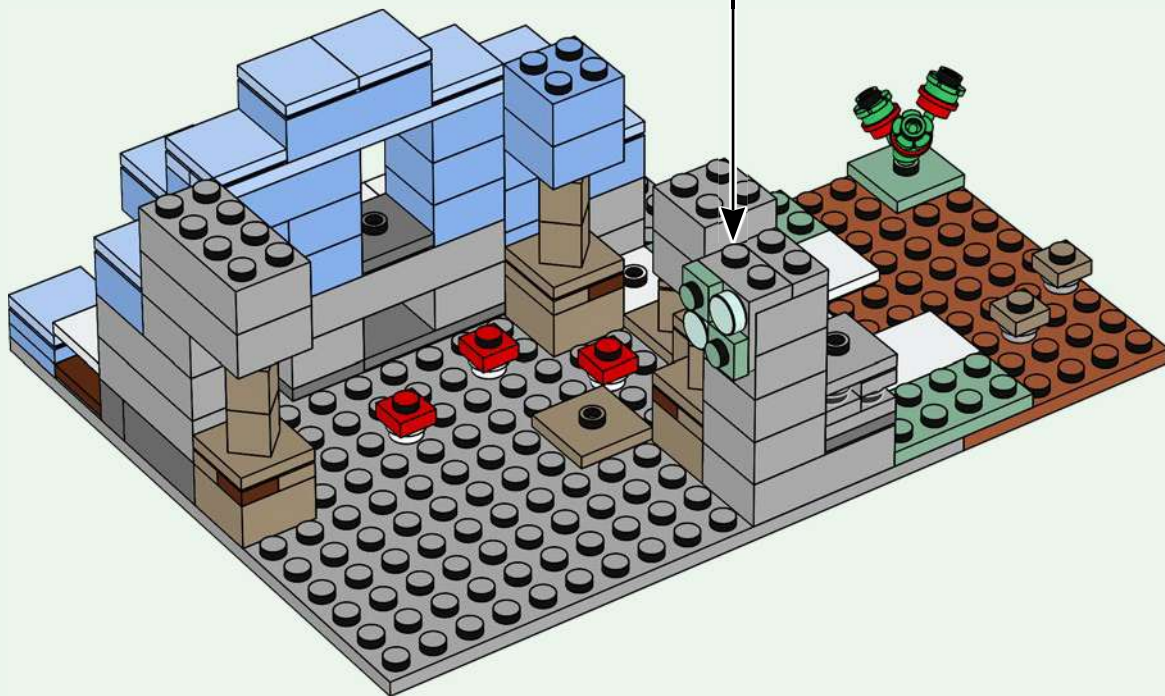
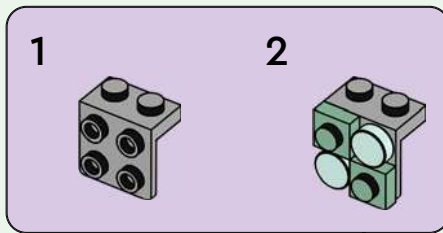



1x

42

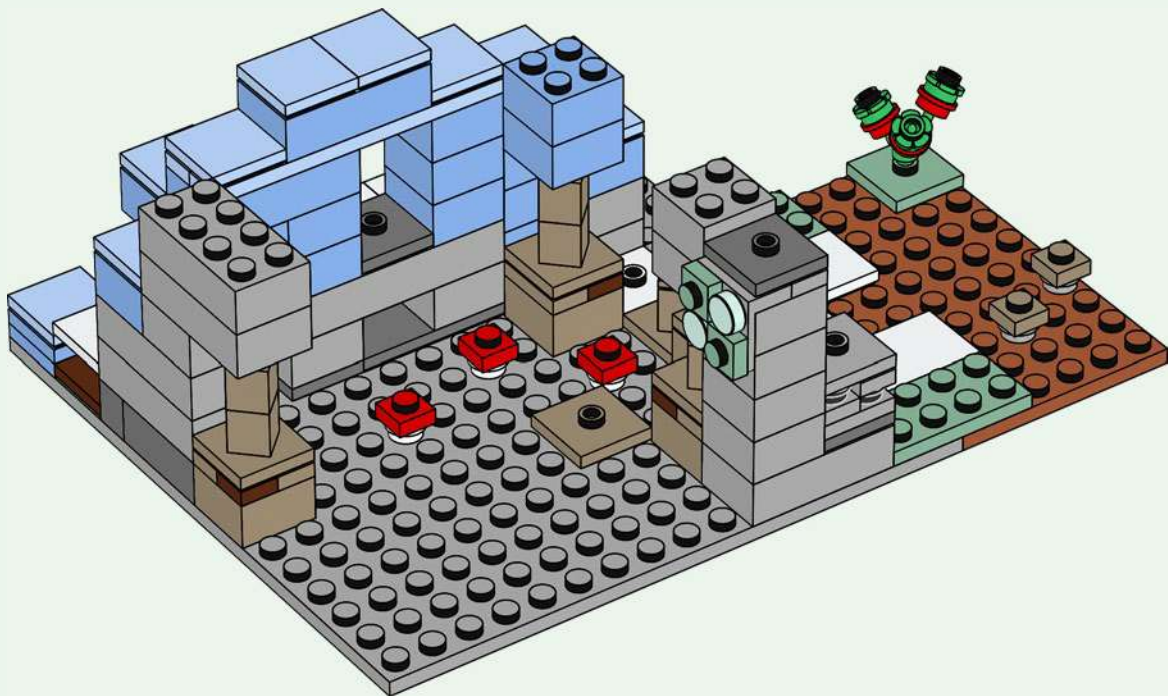



43

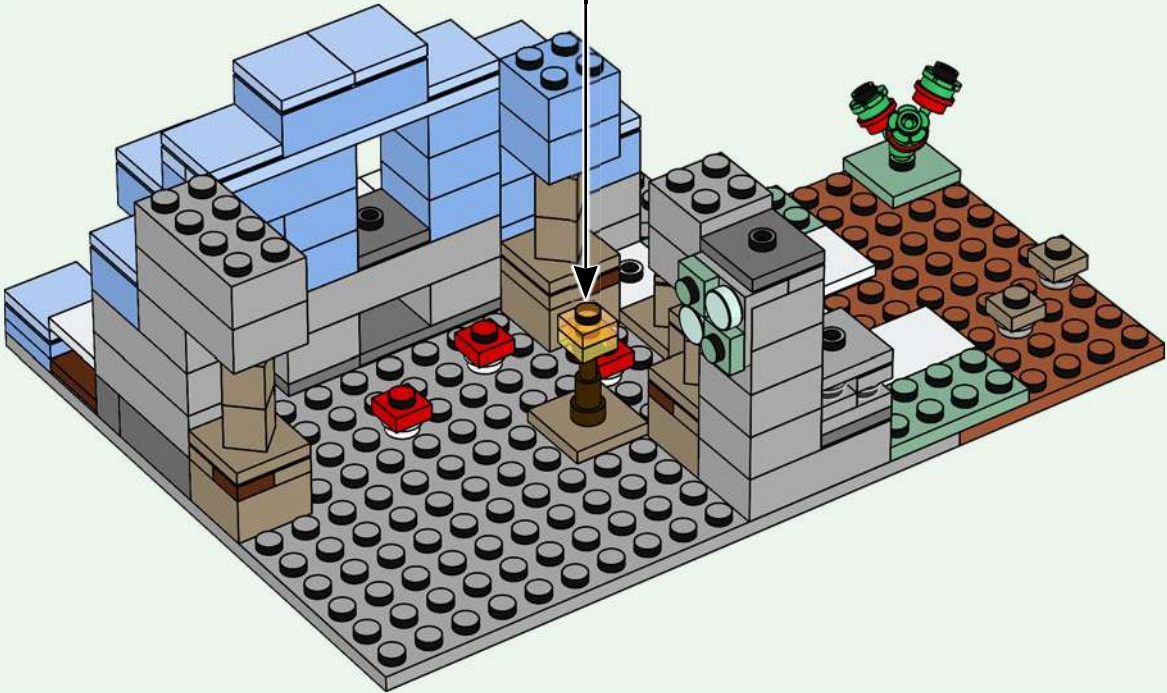
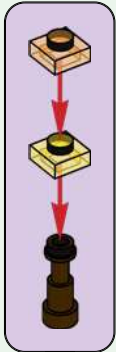

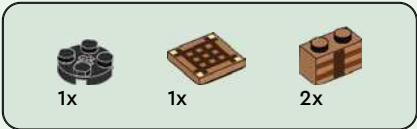

44

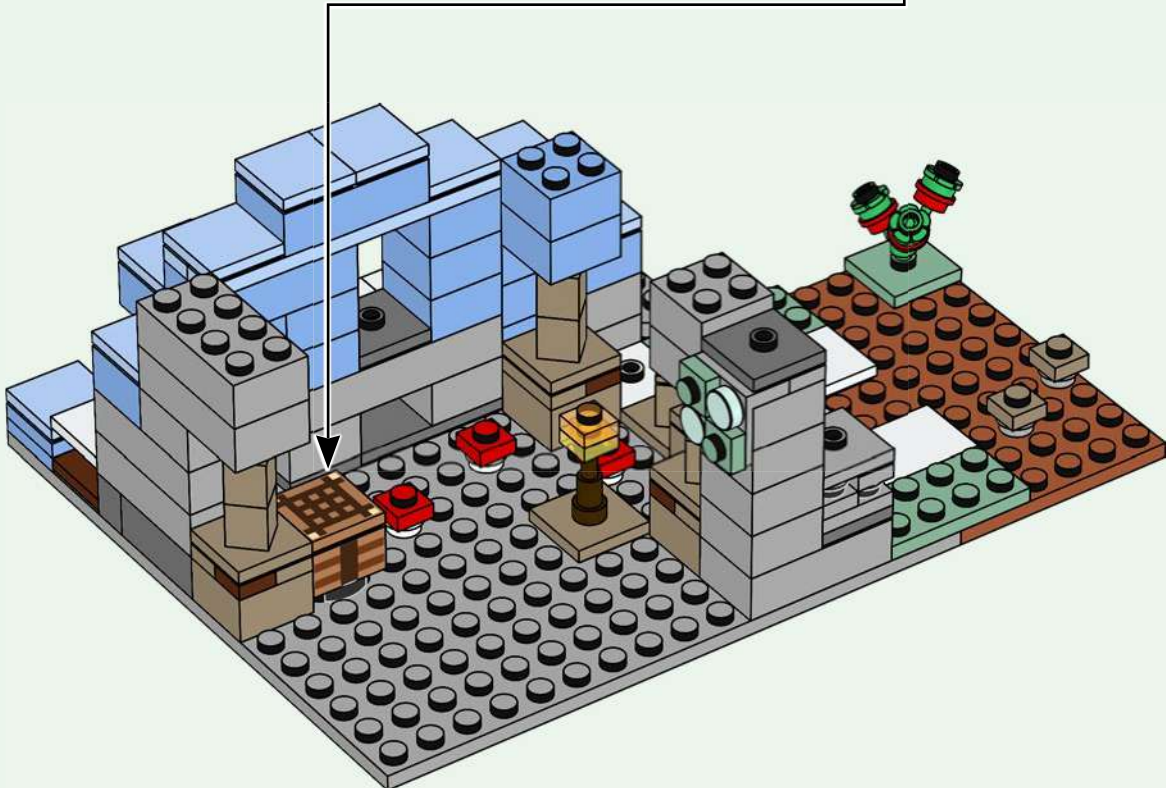
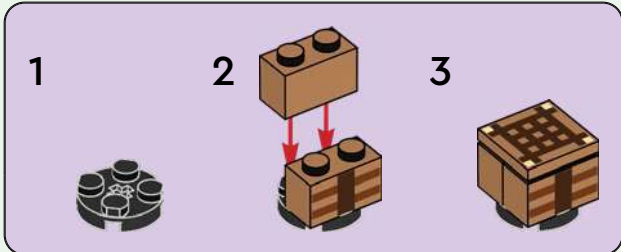

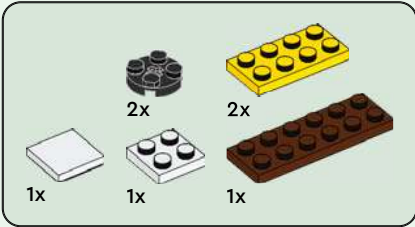

45

1



2

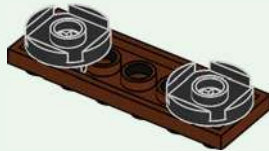

3

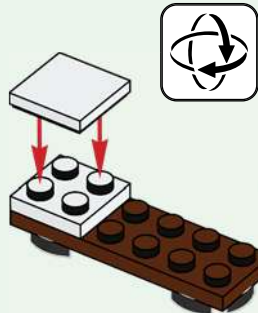

4

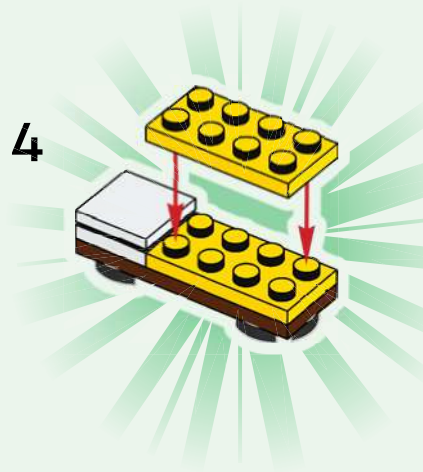

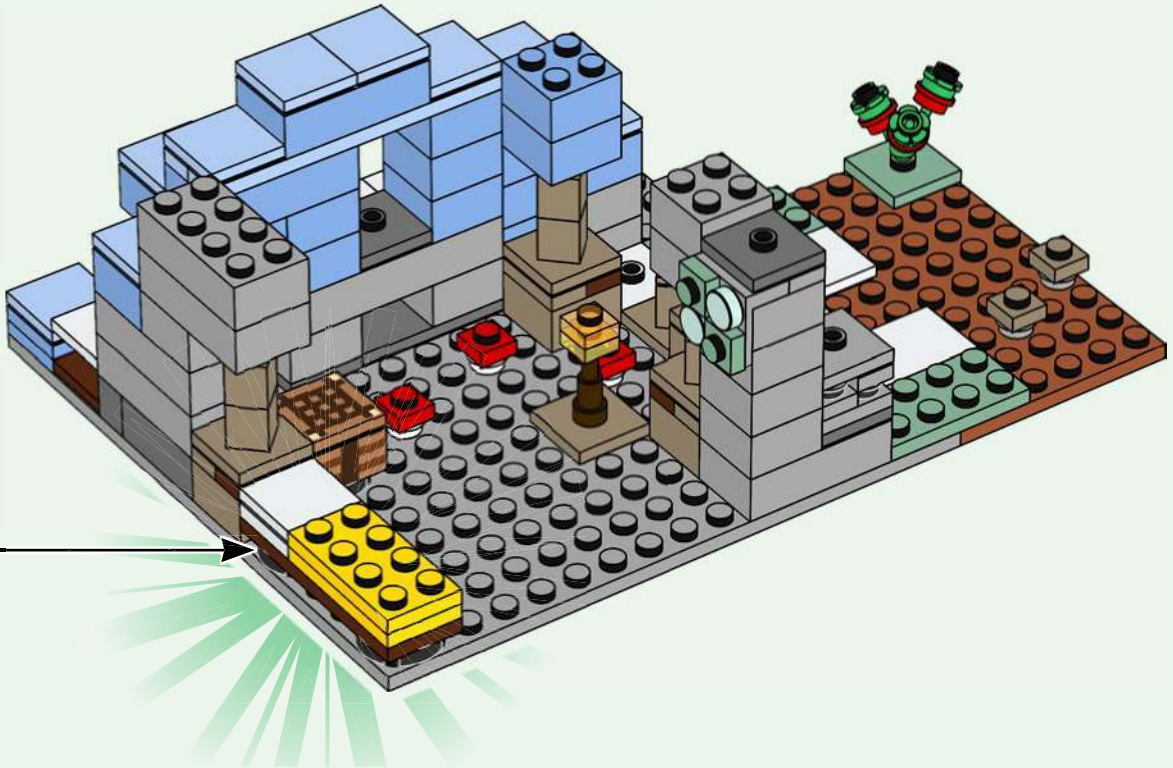

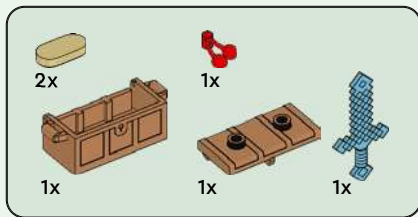

46

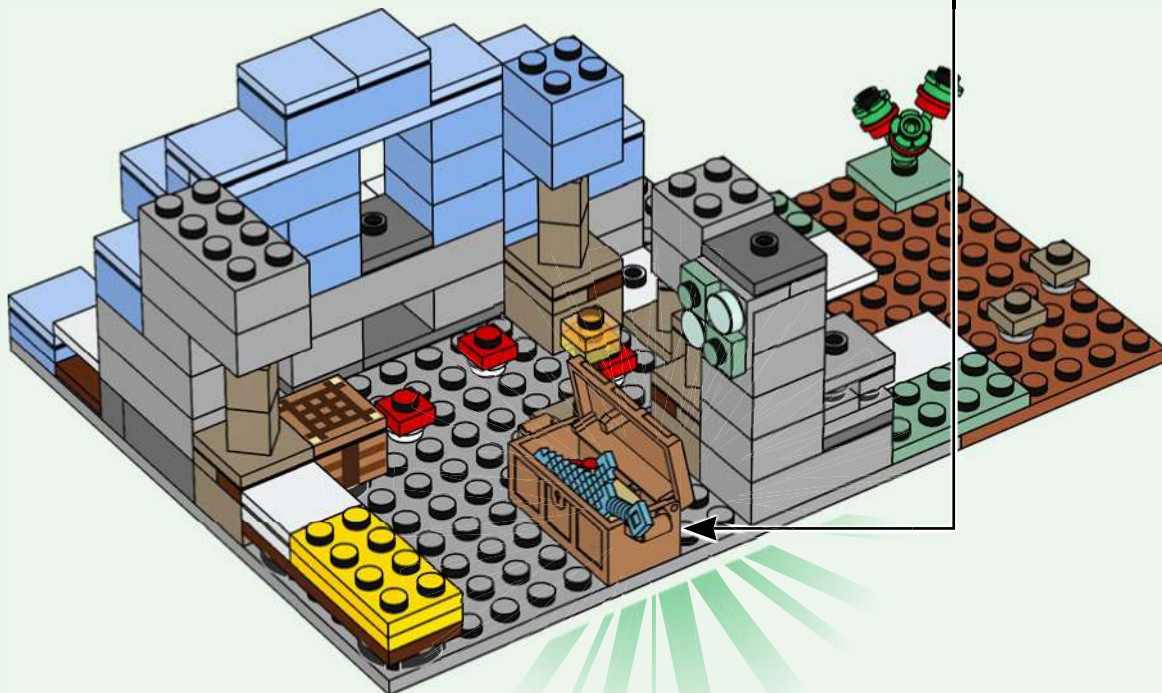
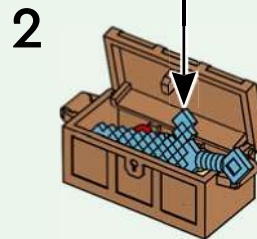
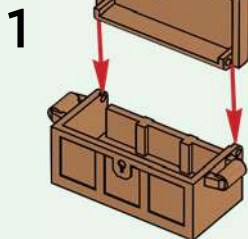

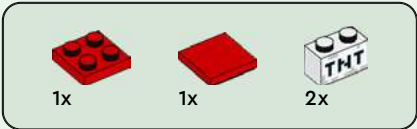

47

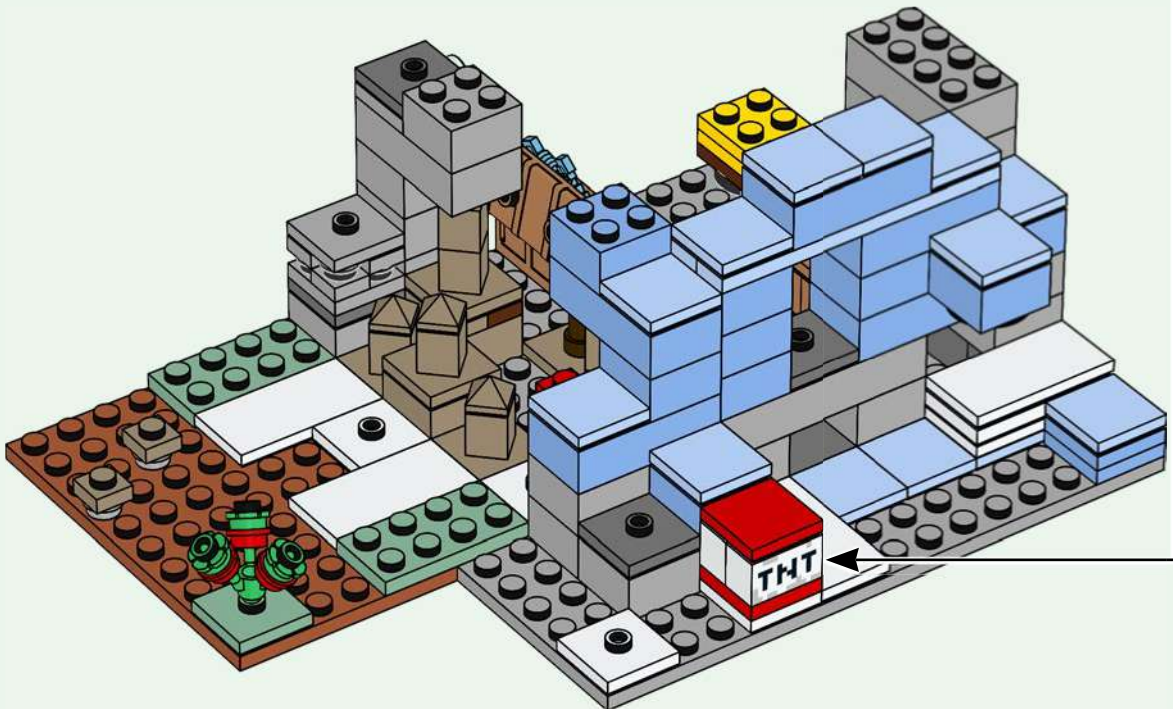
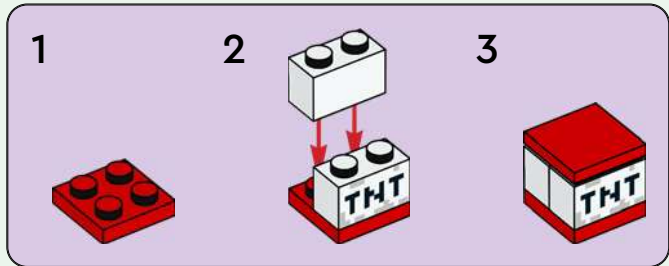
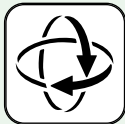

48

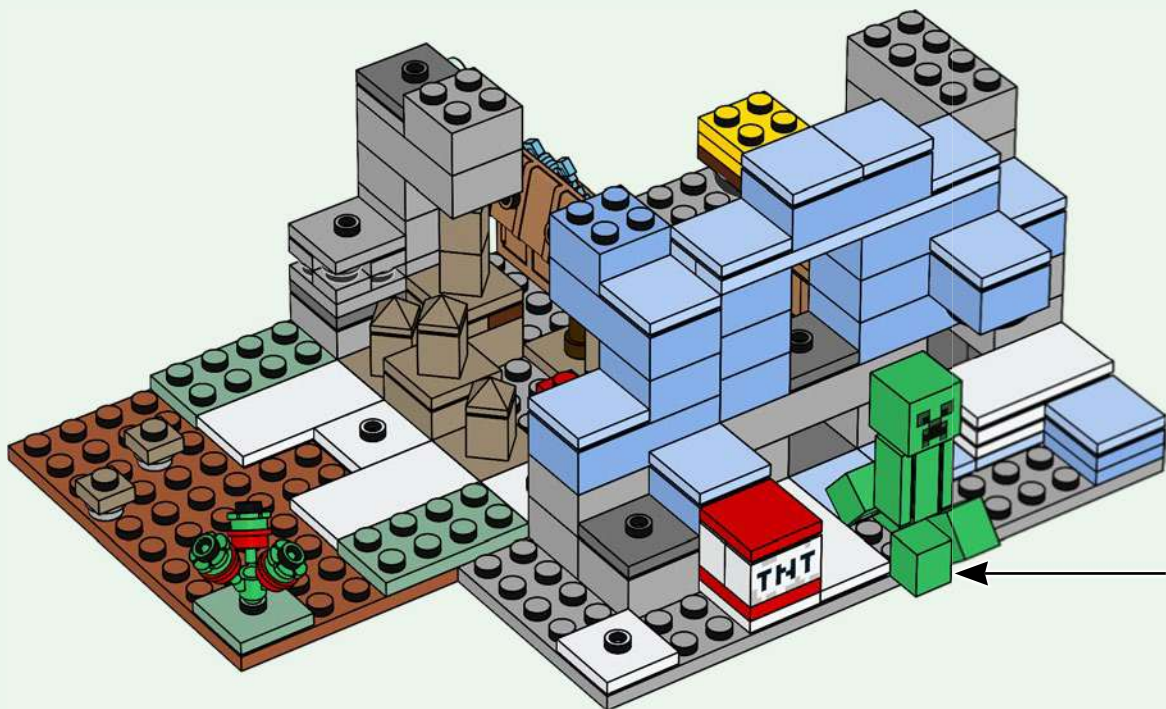
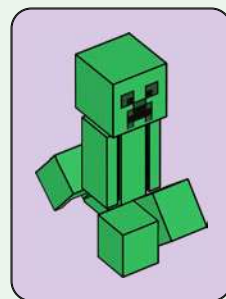

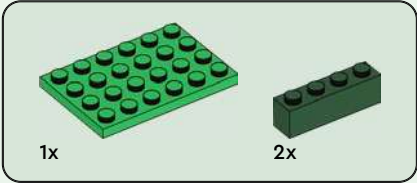
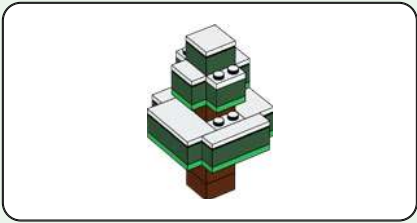

49

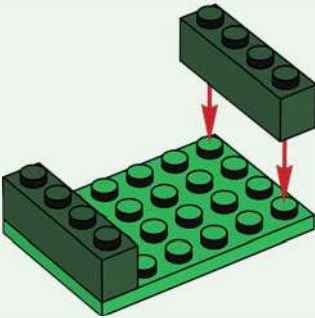

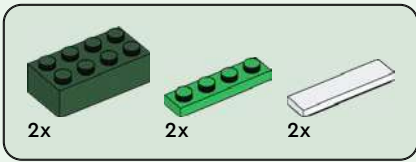

50

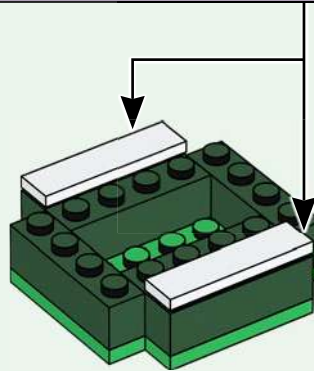
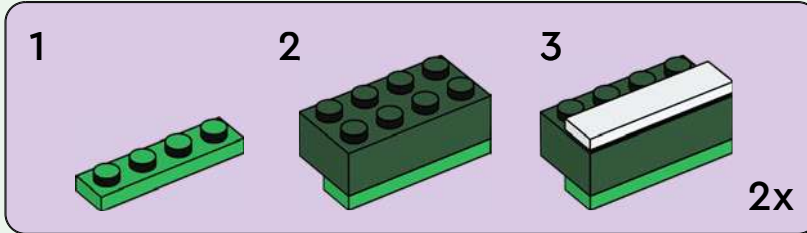

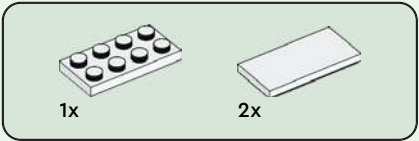

51

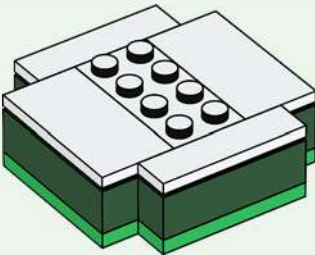



1x

52

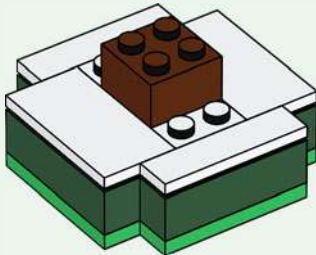

1x



2x

53

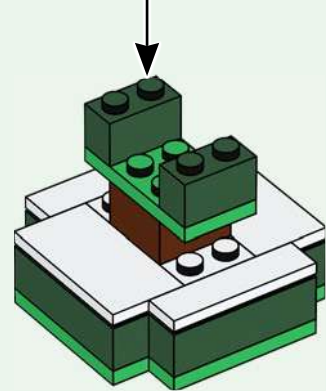
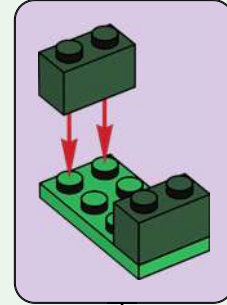

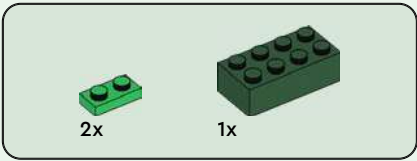

54

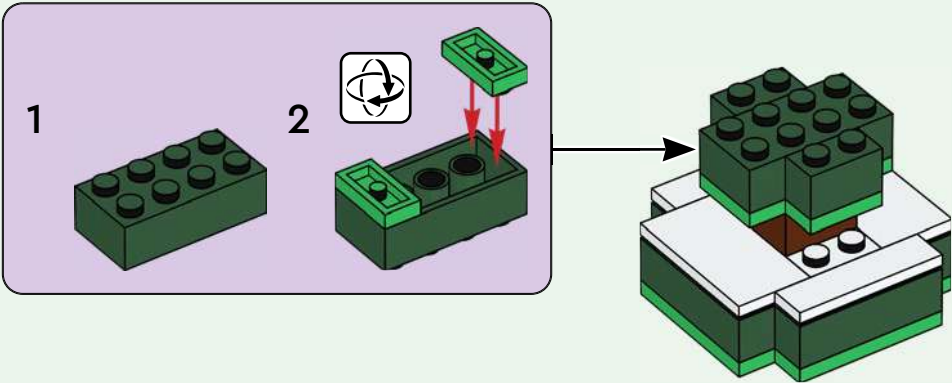

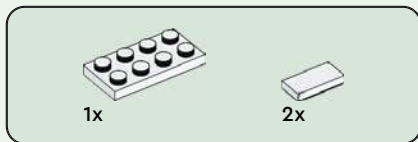

55

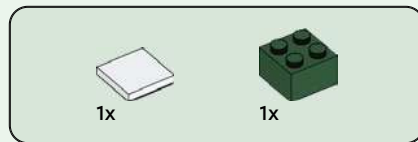
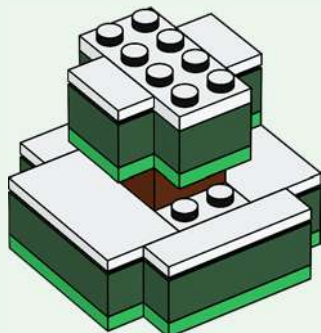

56

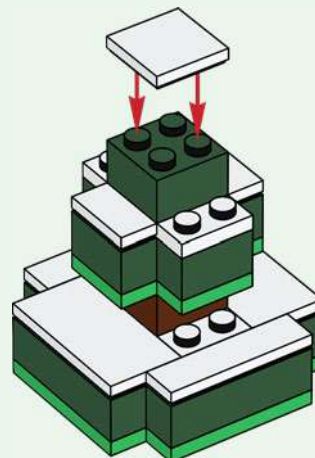



3x

57

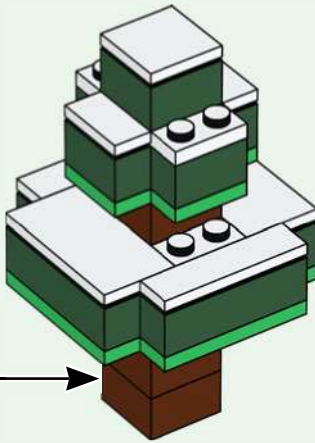
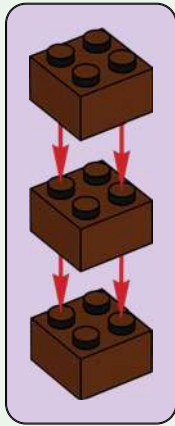

58

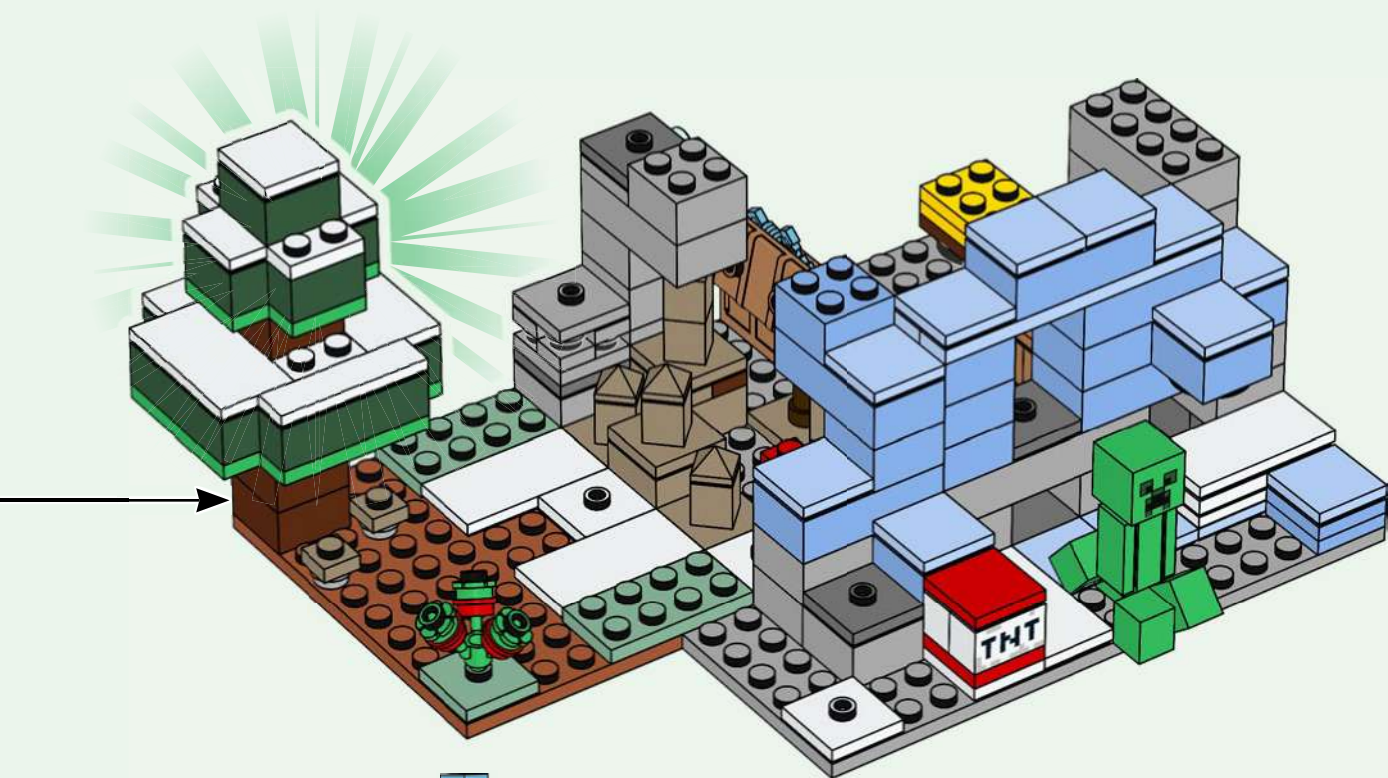



1

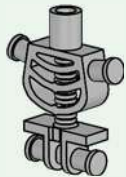

2

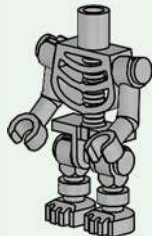

3



4

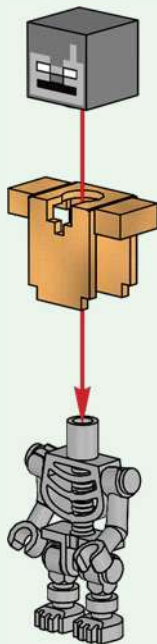
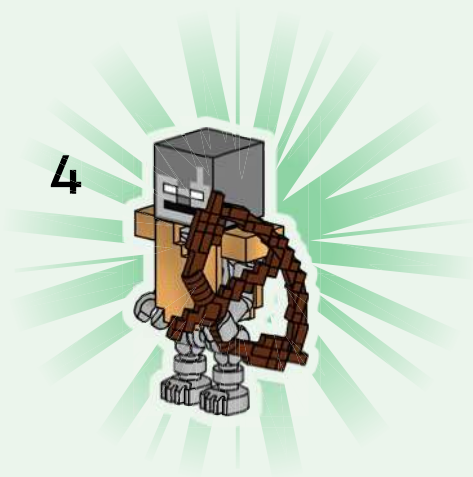

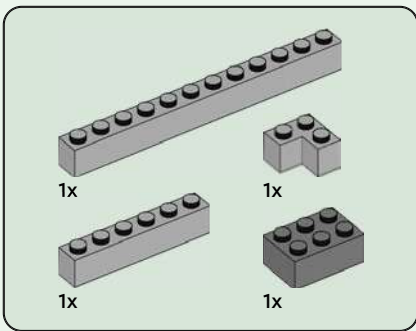

59

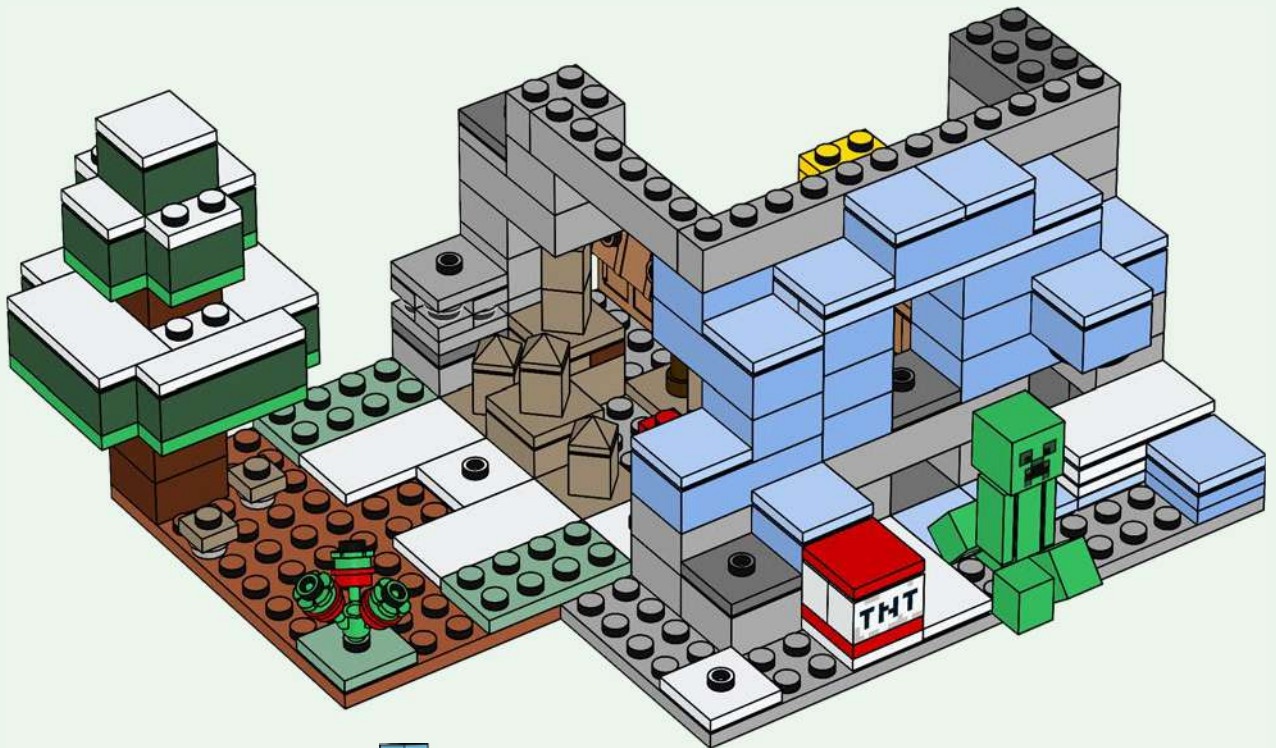

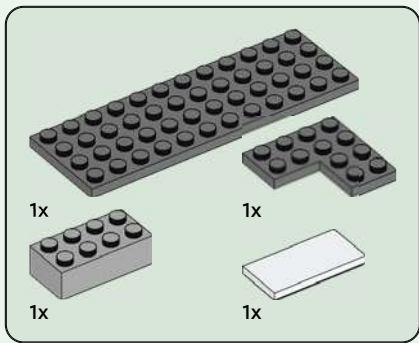

60

1

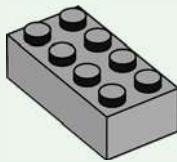

2

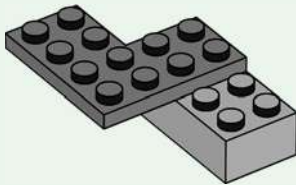

3

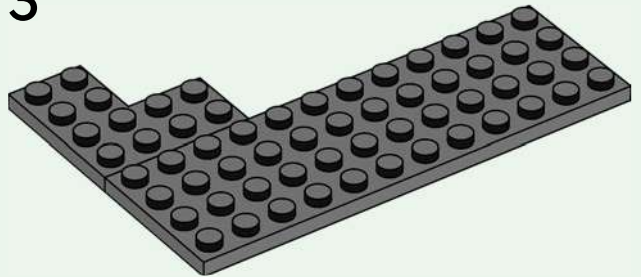

4

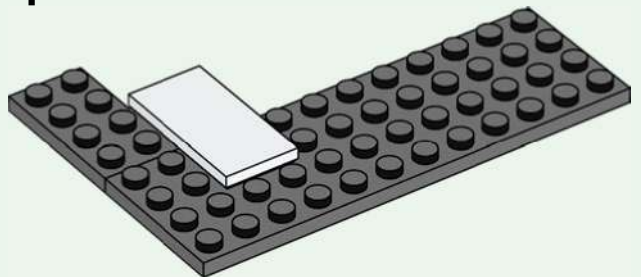

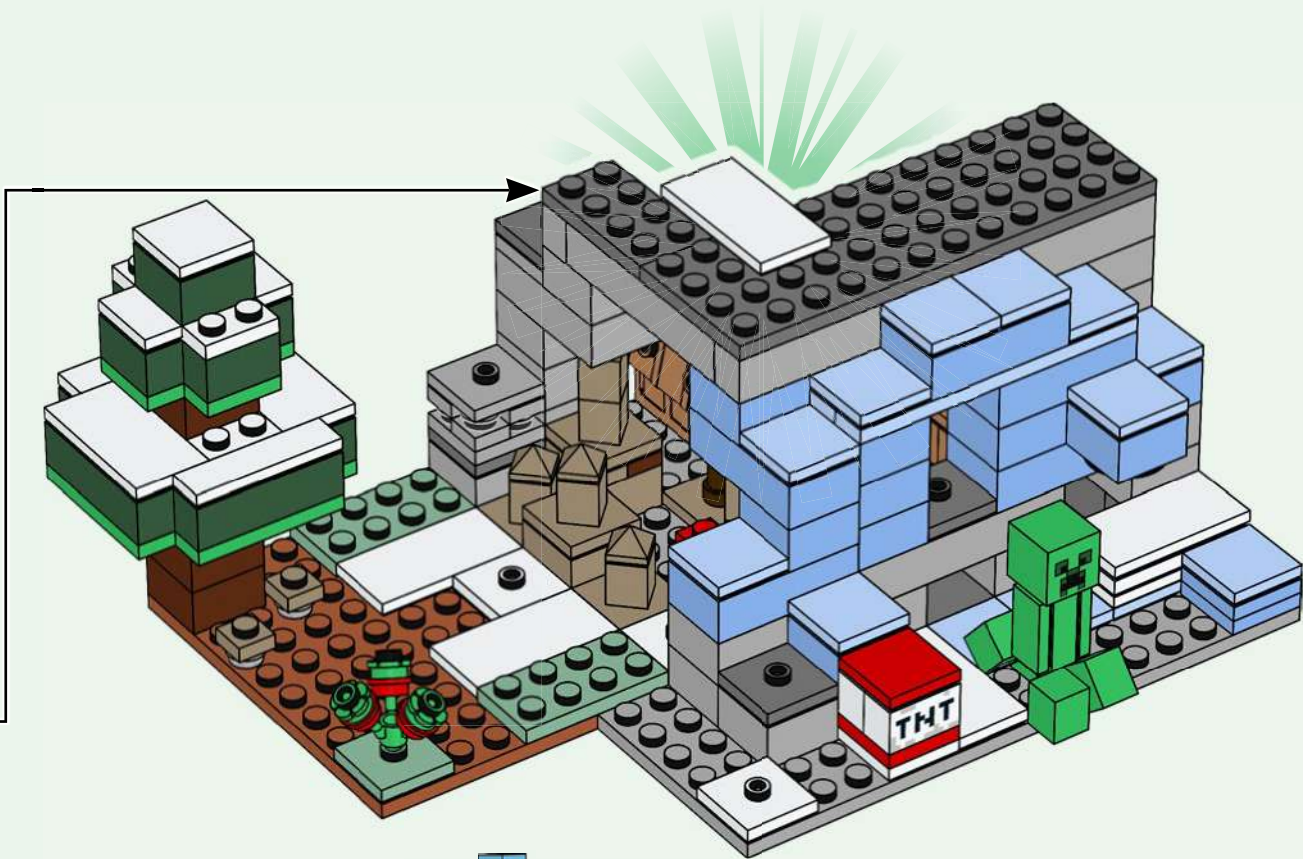

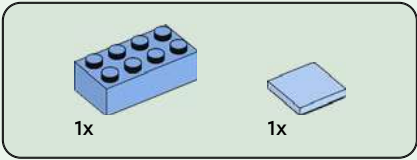

61

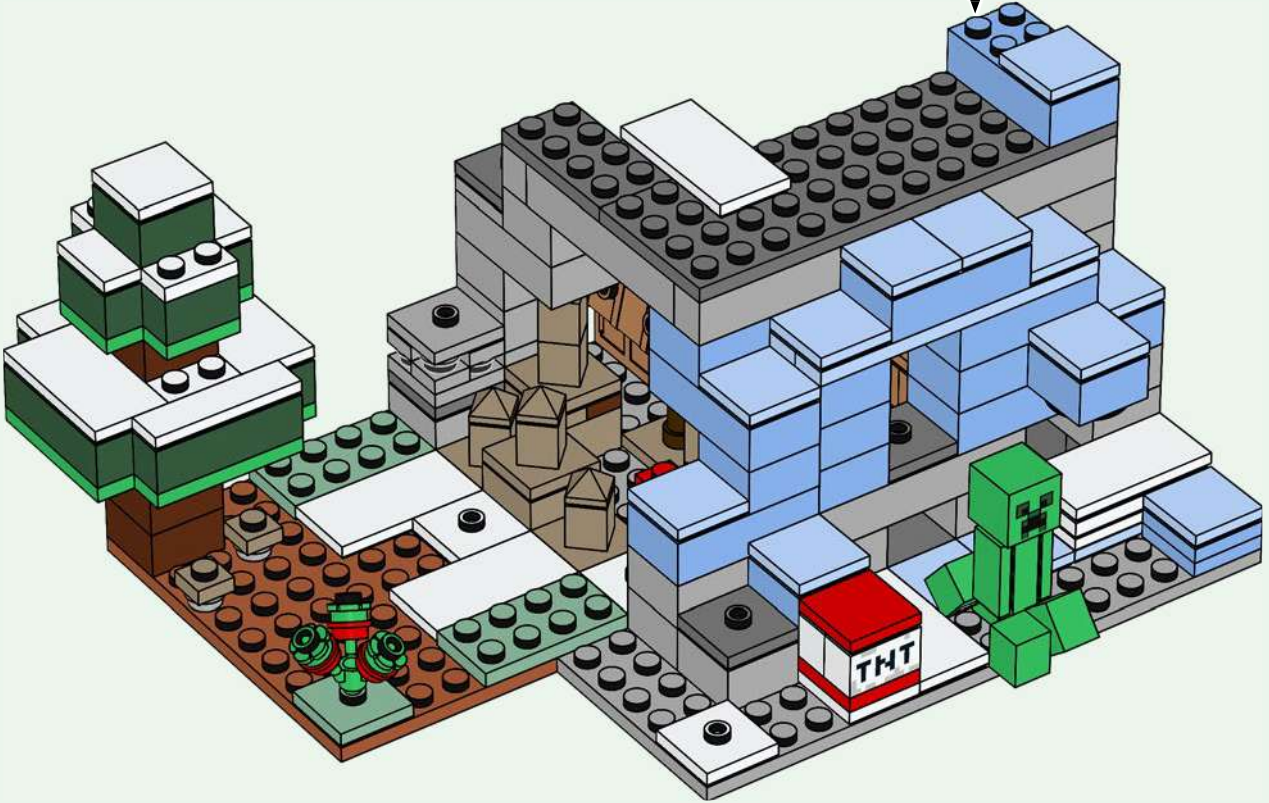
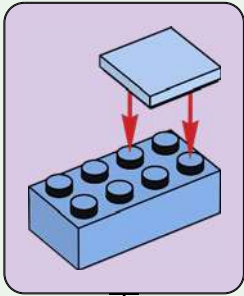

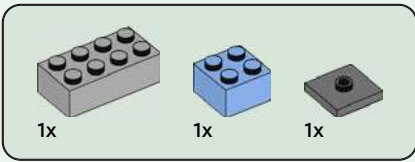

62

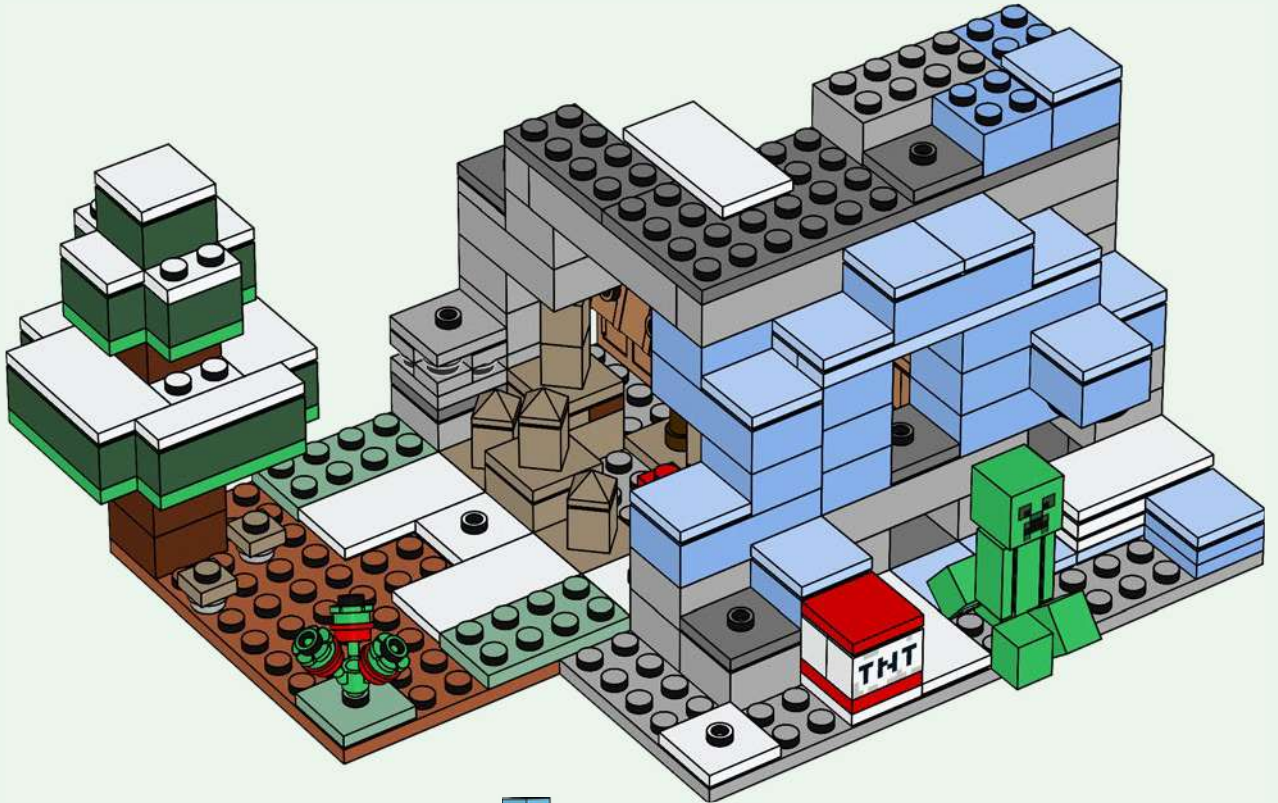

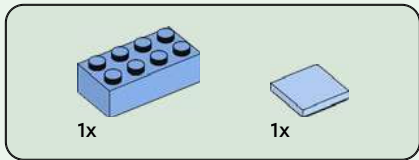

63

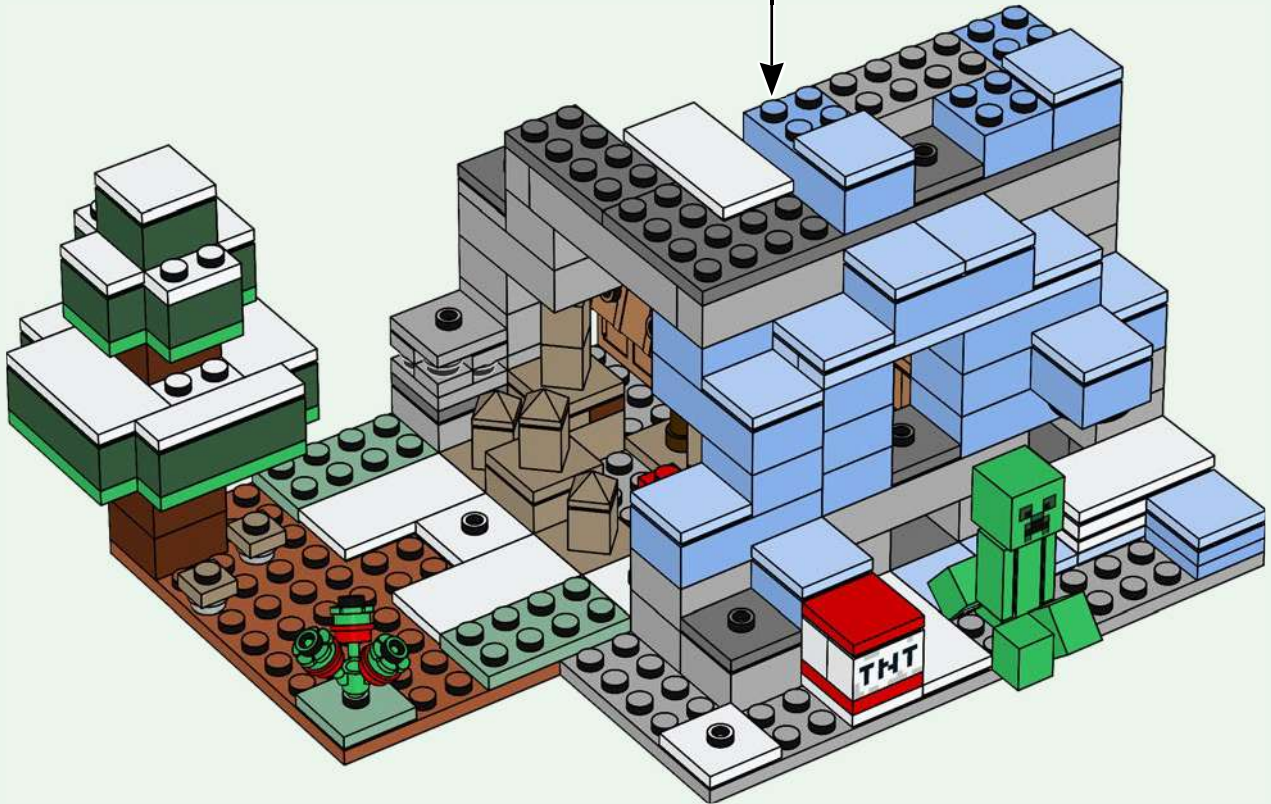
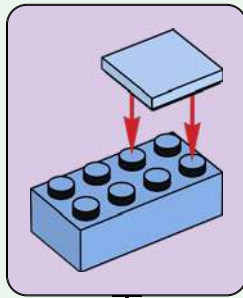



2x

64

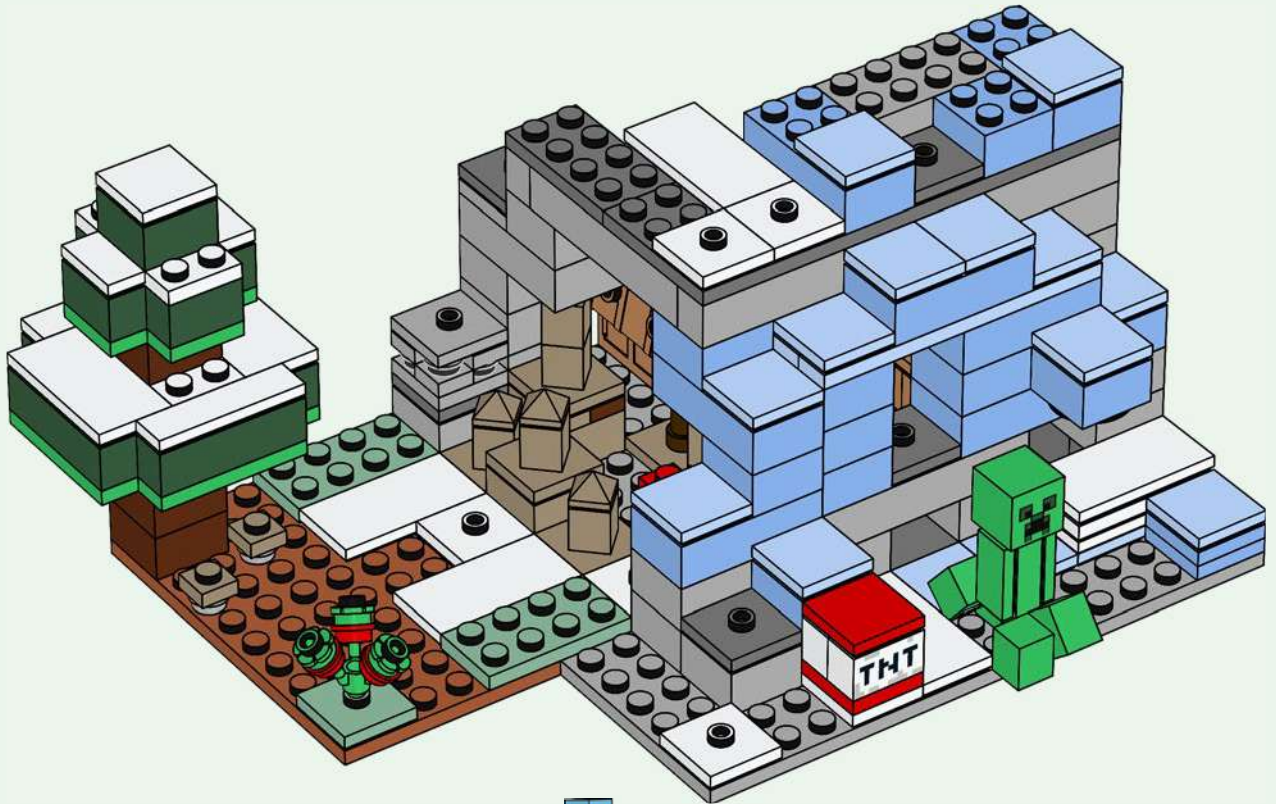

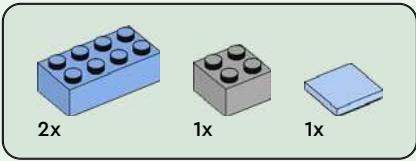

65

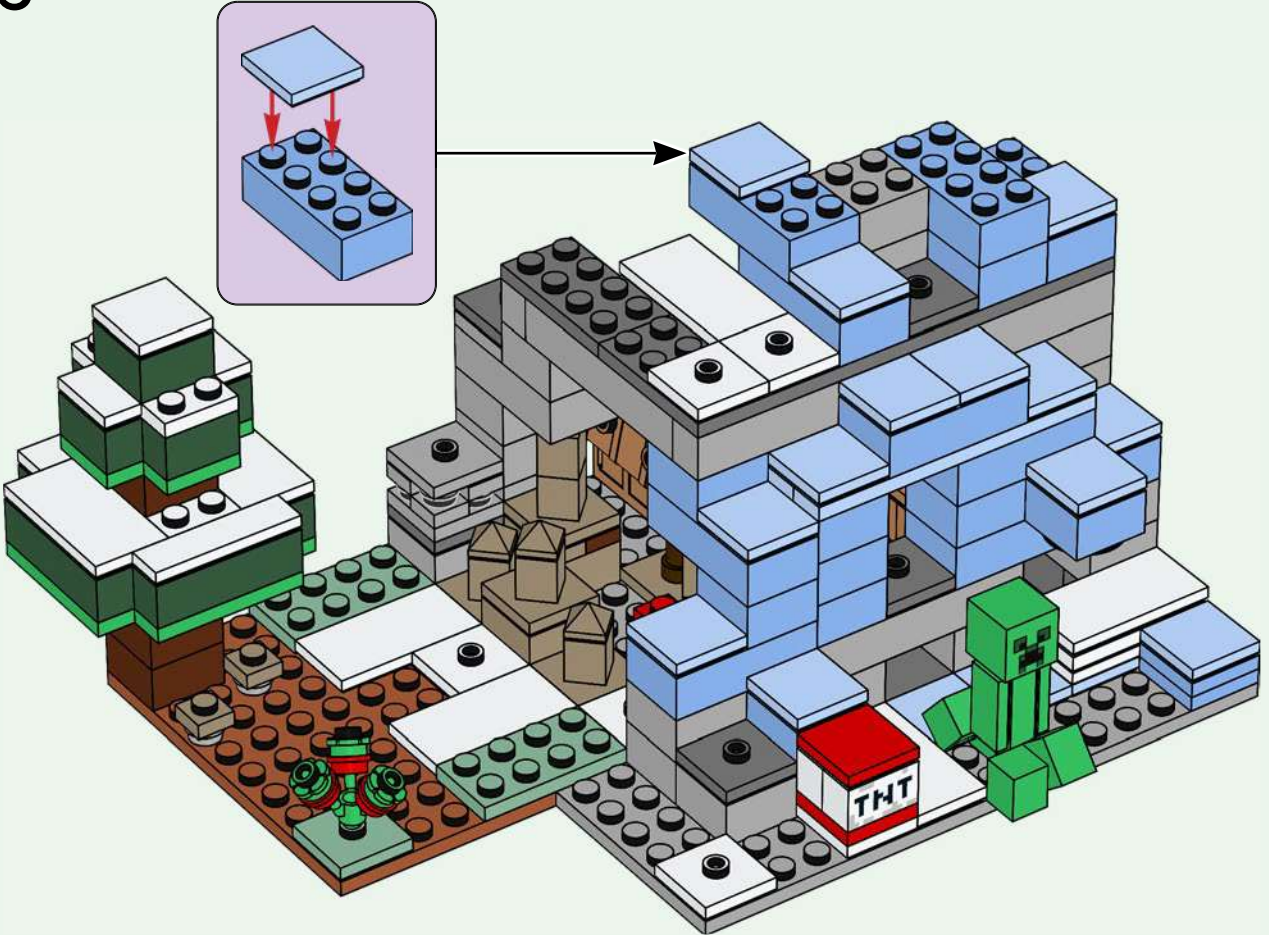

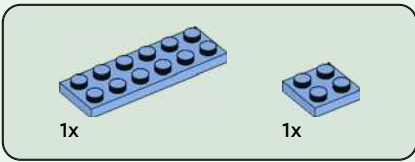

66

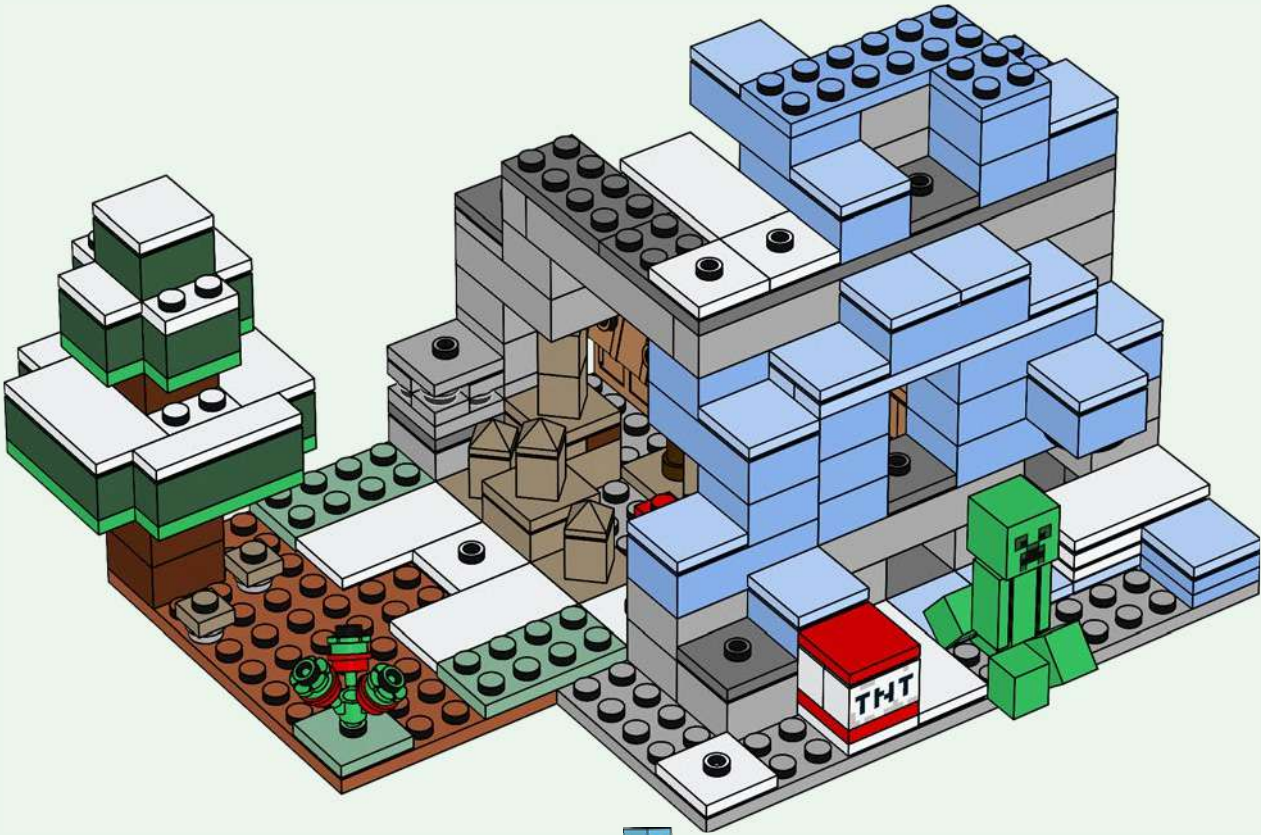

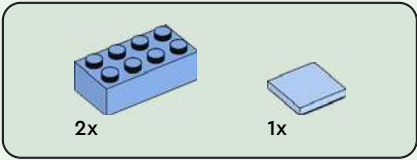

67

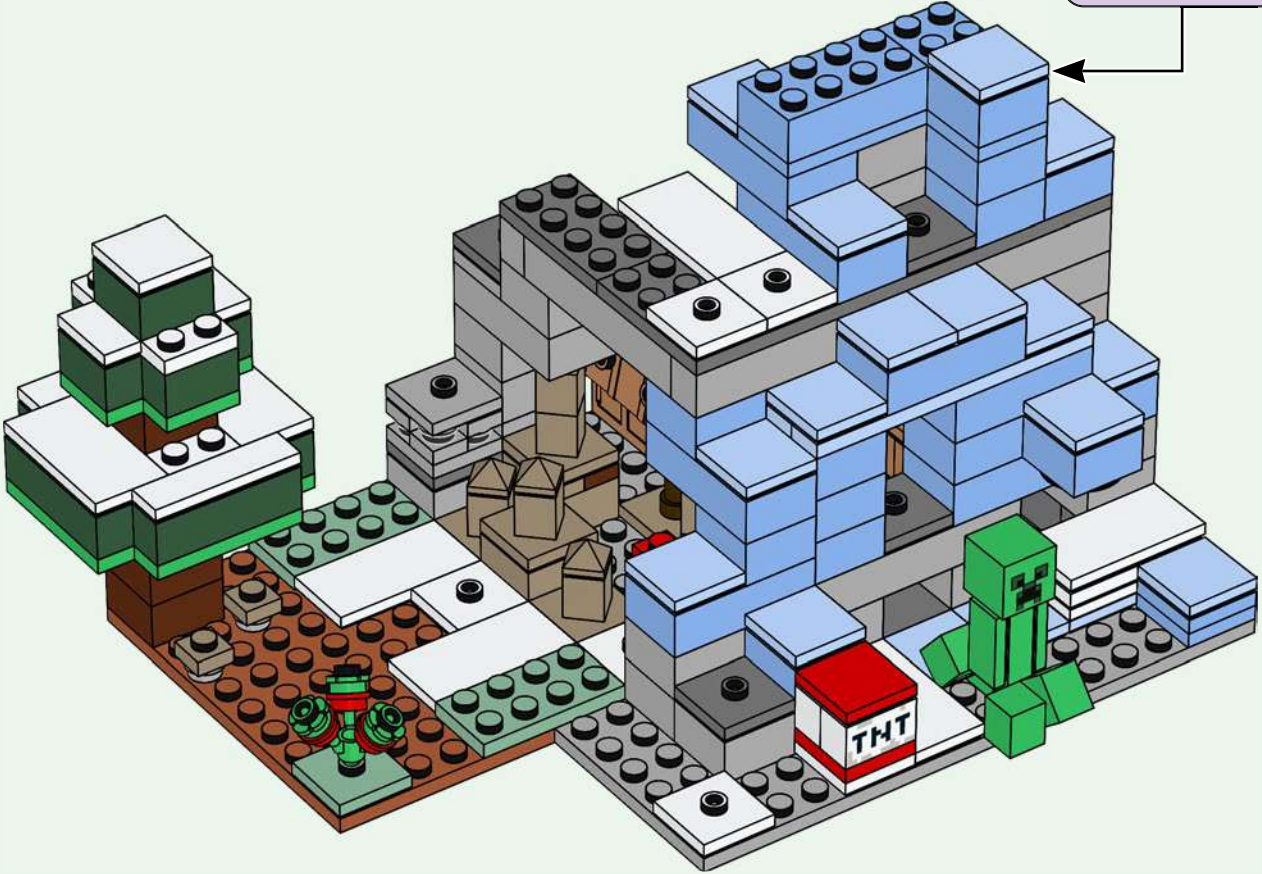
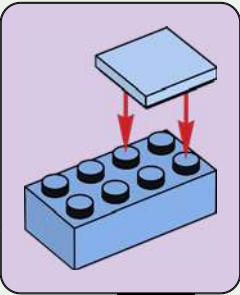



1x

68

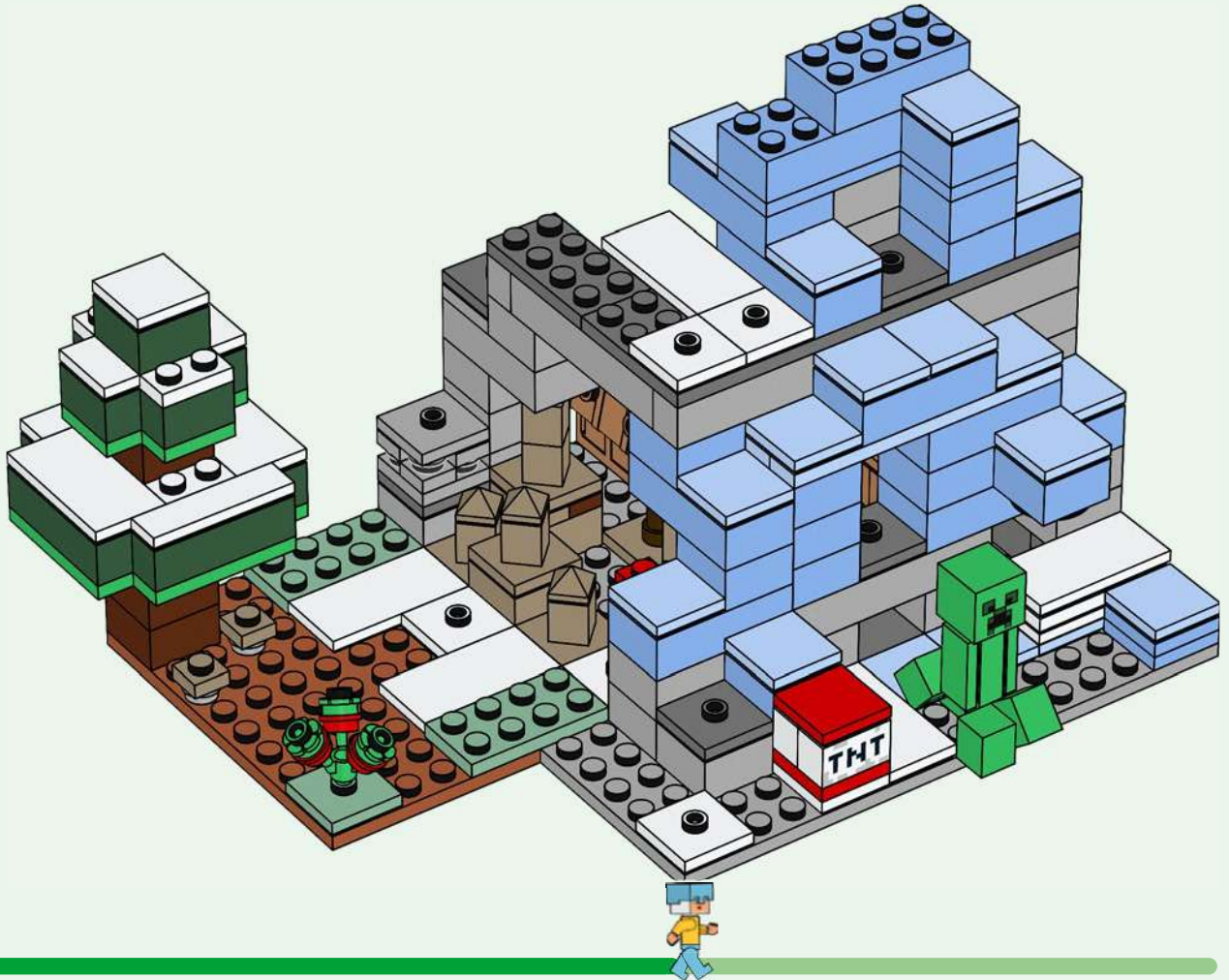



3x

69

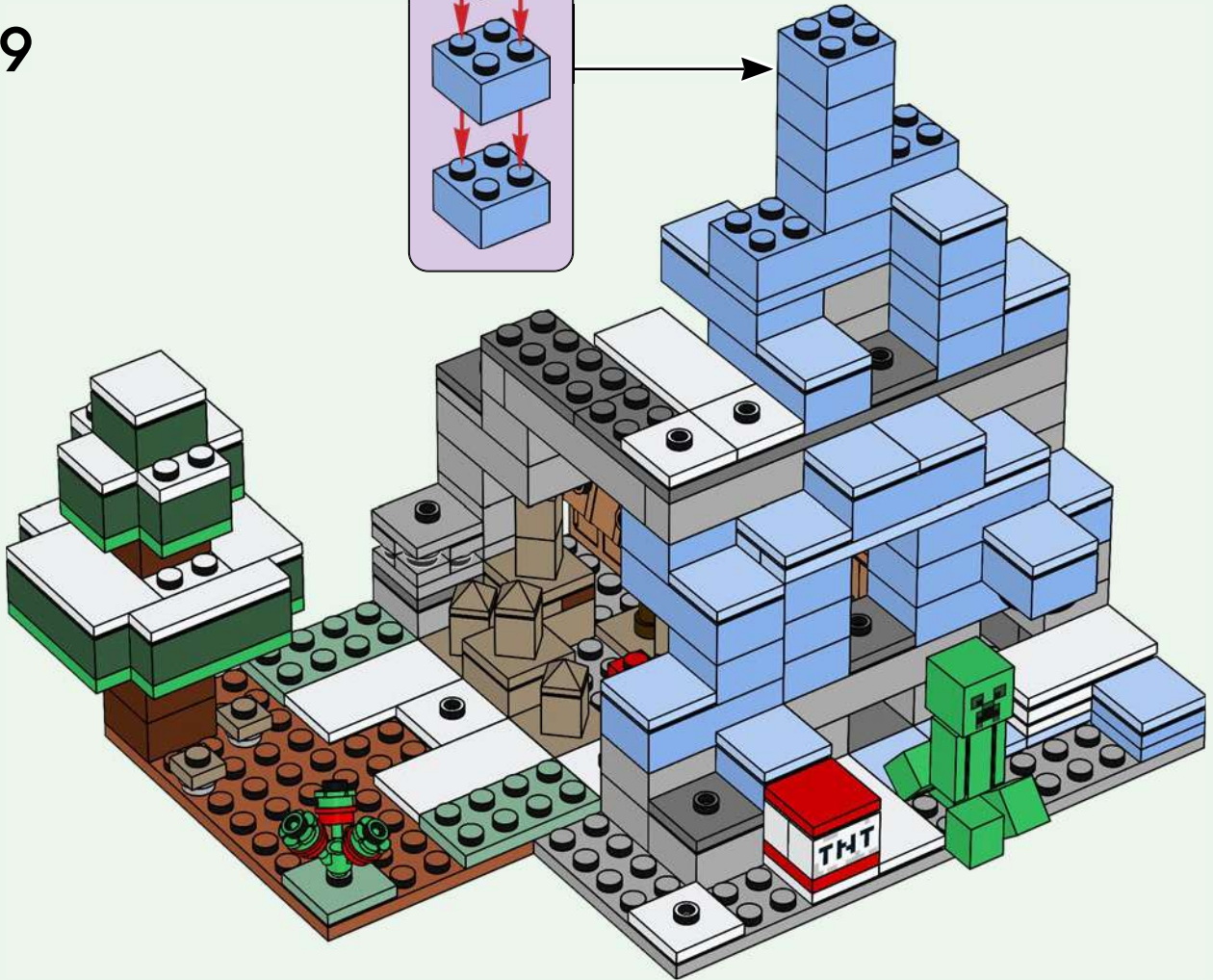
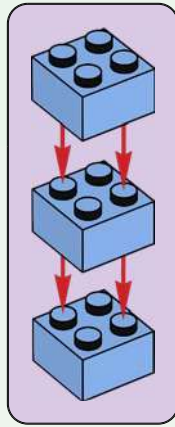

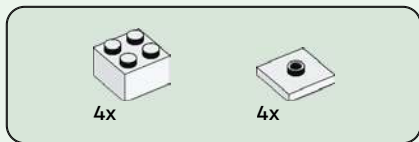

70

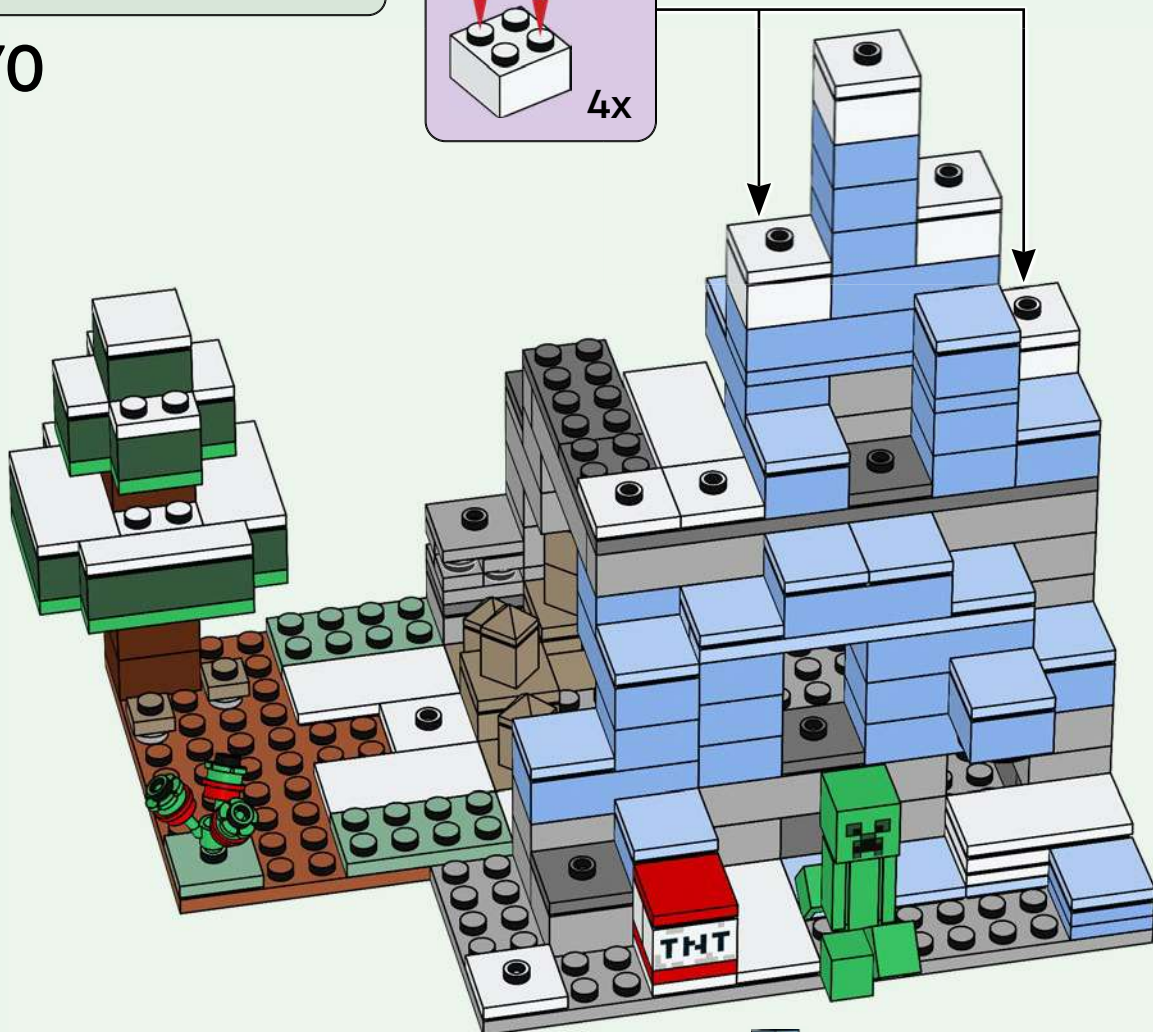
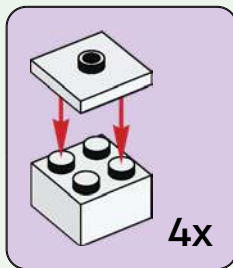

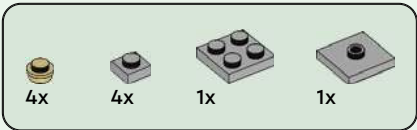

71

1



2

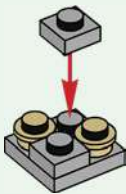

3

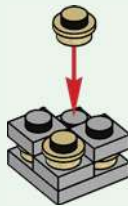

4

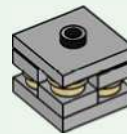



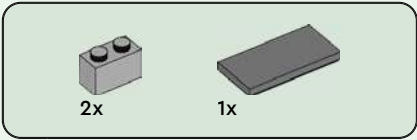

72

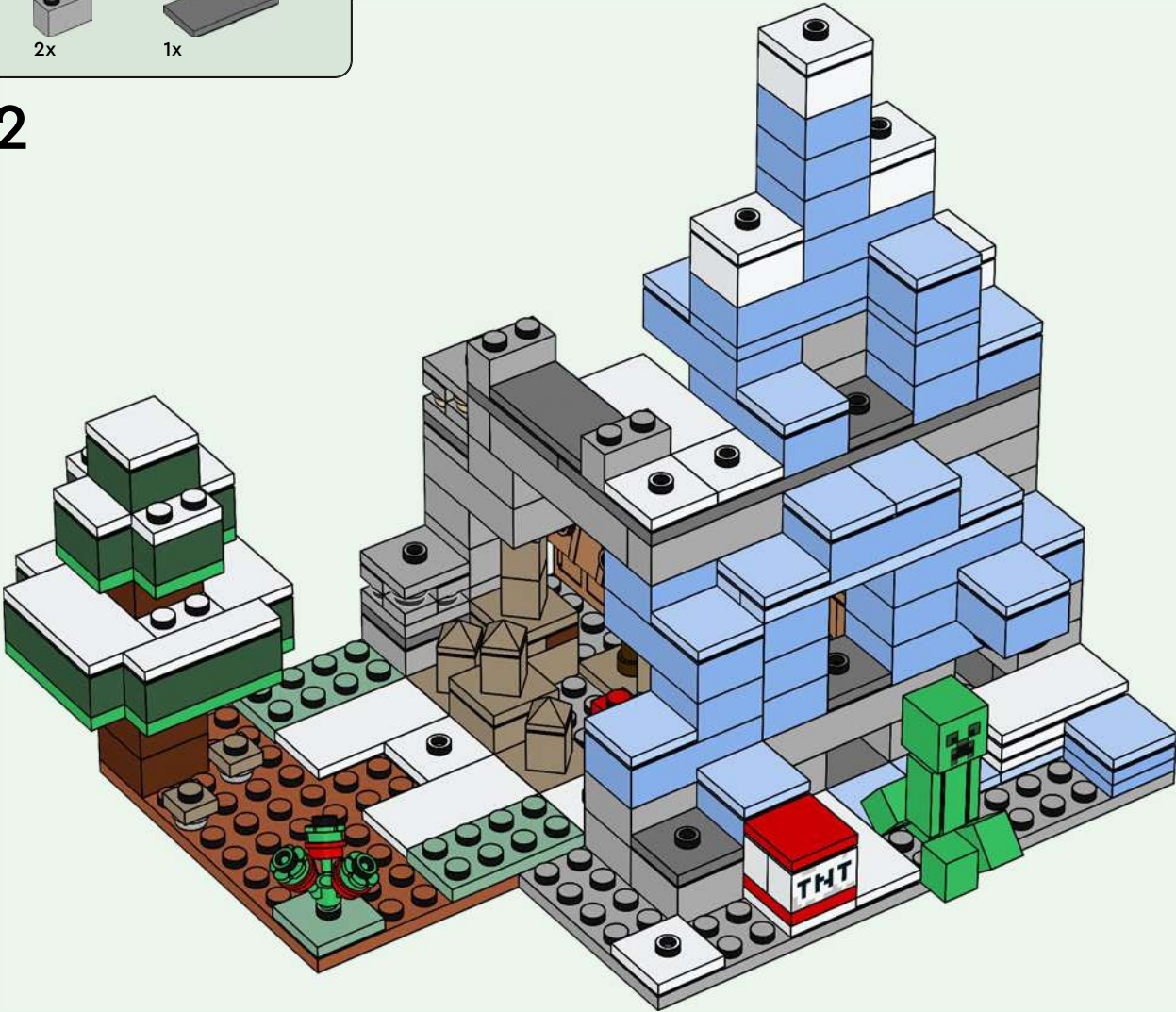



1x

73



3x

74

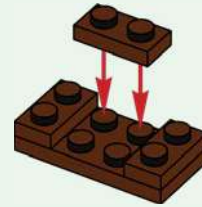

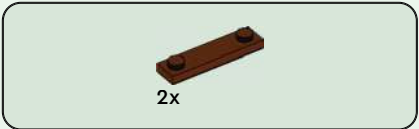

75

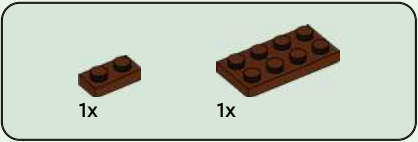
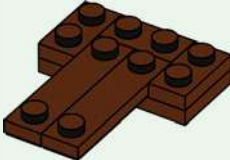

76

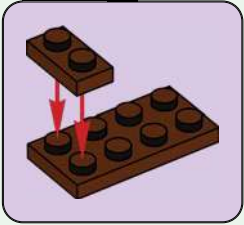
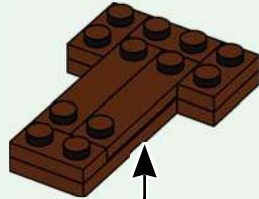



1x



1x

77

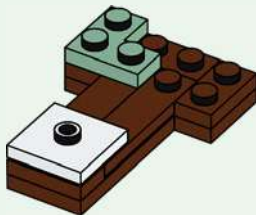

1x



2x

78

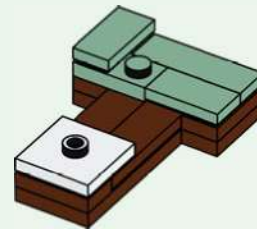

79

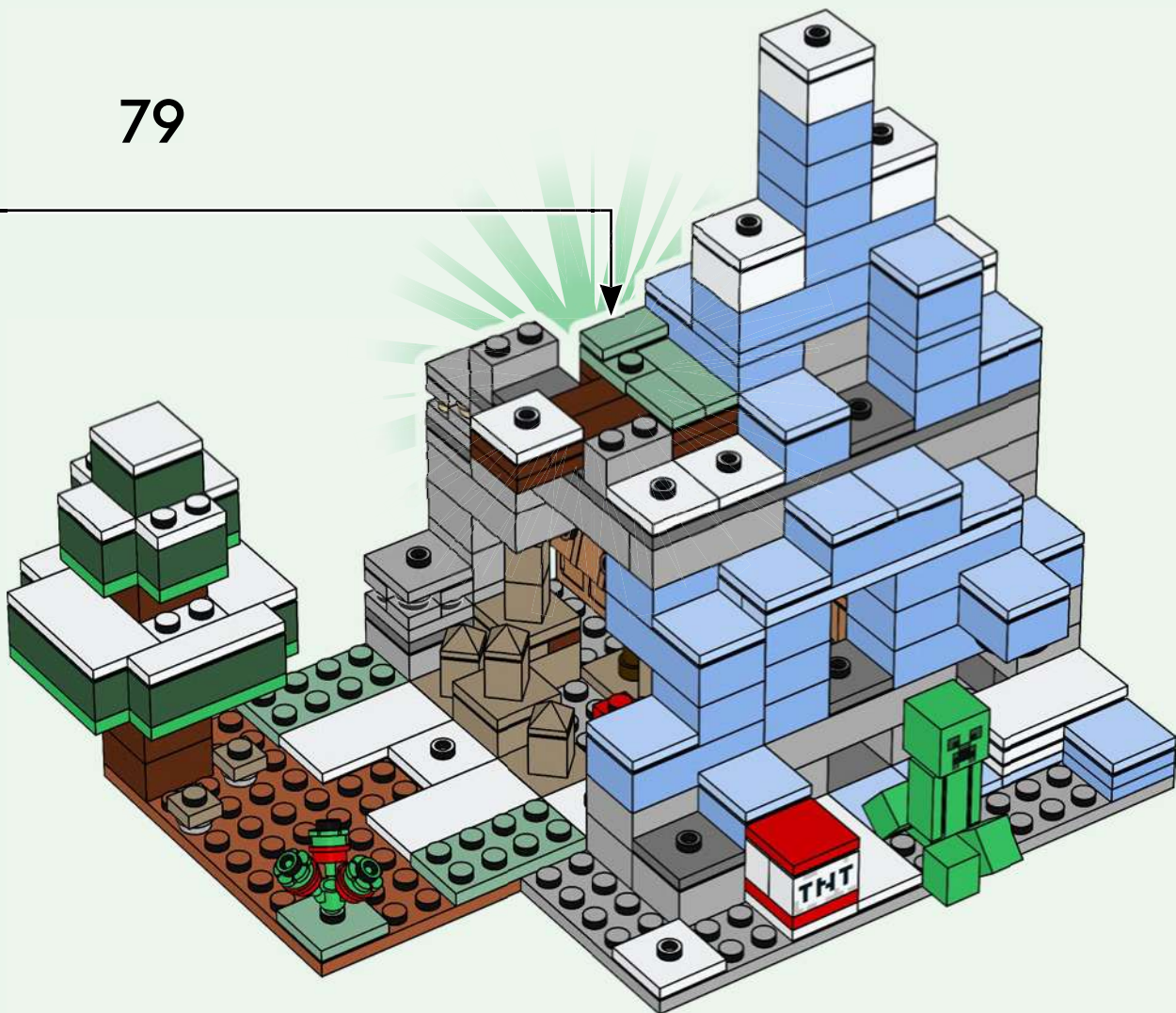



1x

80

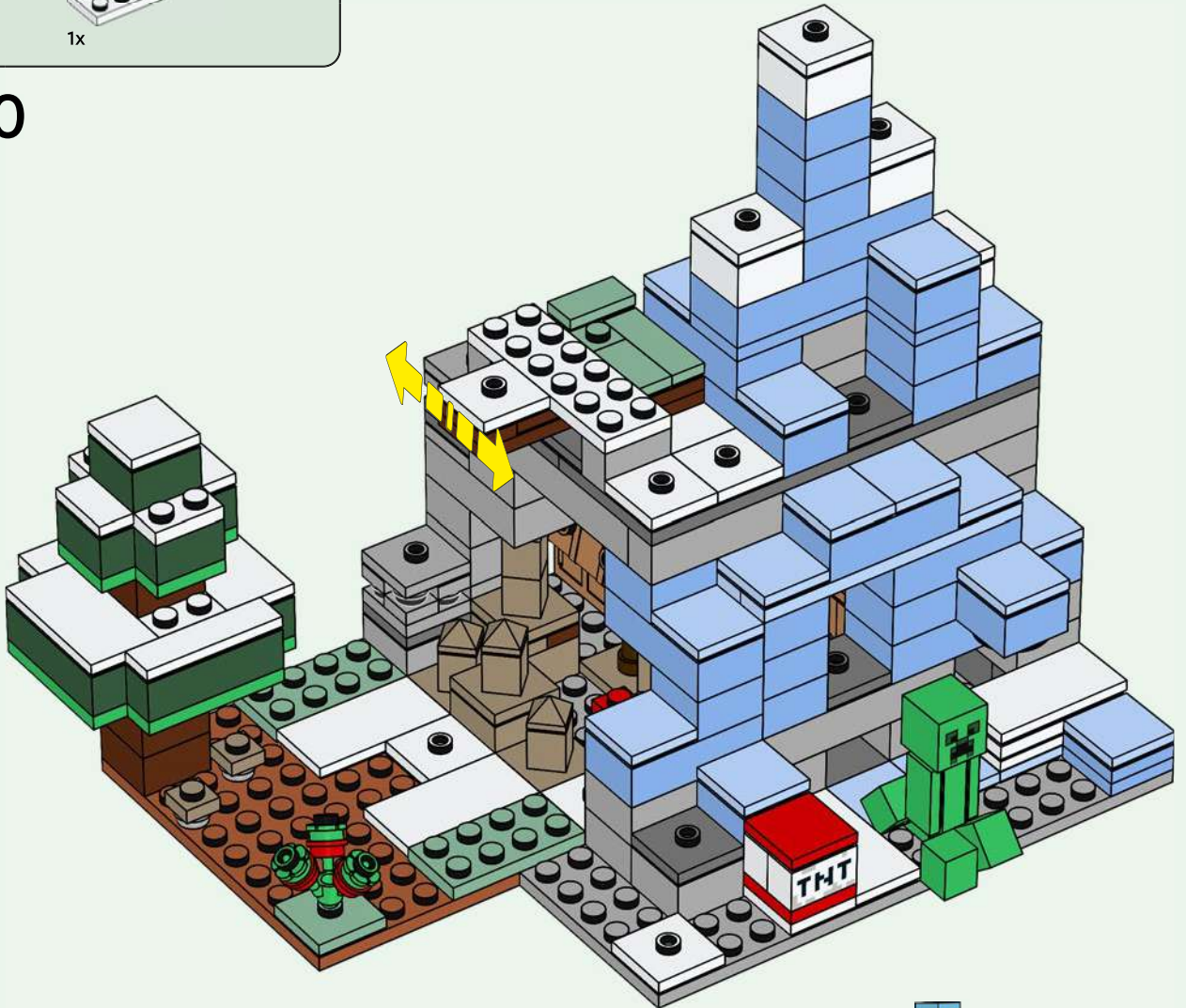

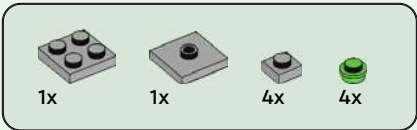

81

1



2

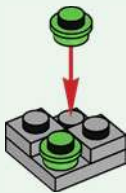

3

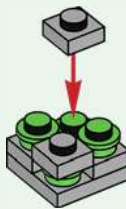

4

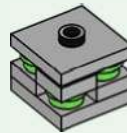

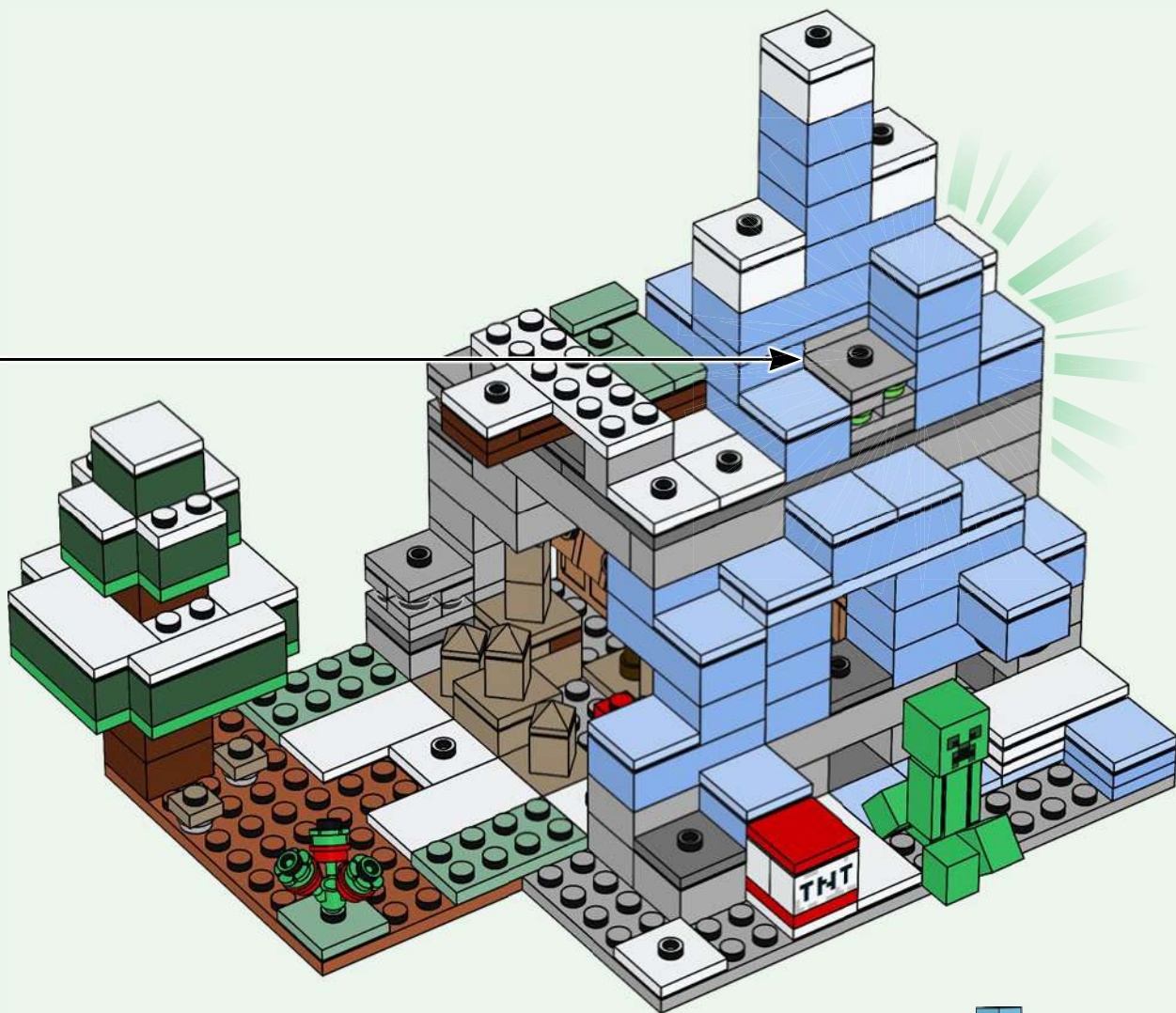



1x

82



2x

83

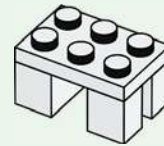

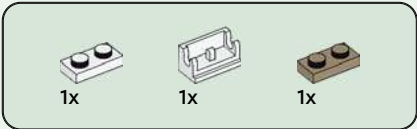

84

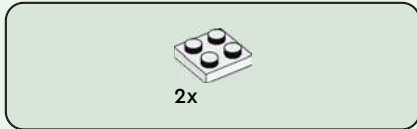
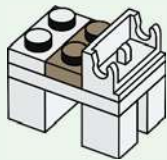

85

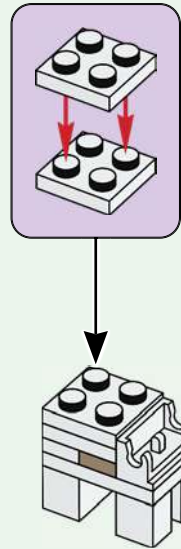

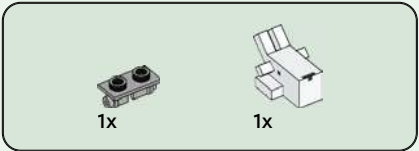

86

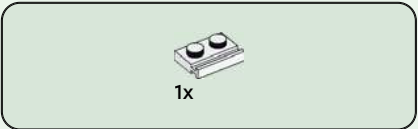
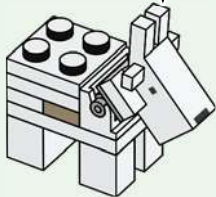
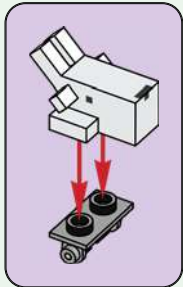

87

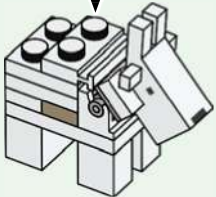
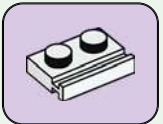

88

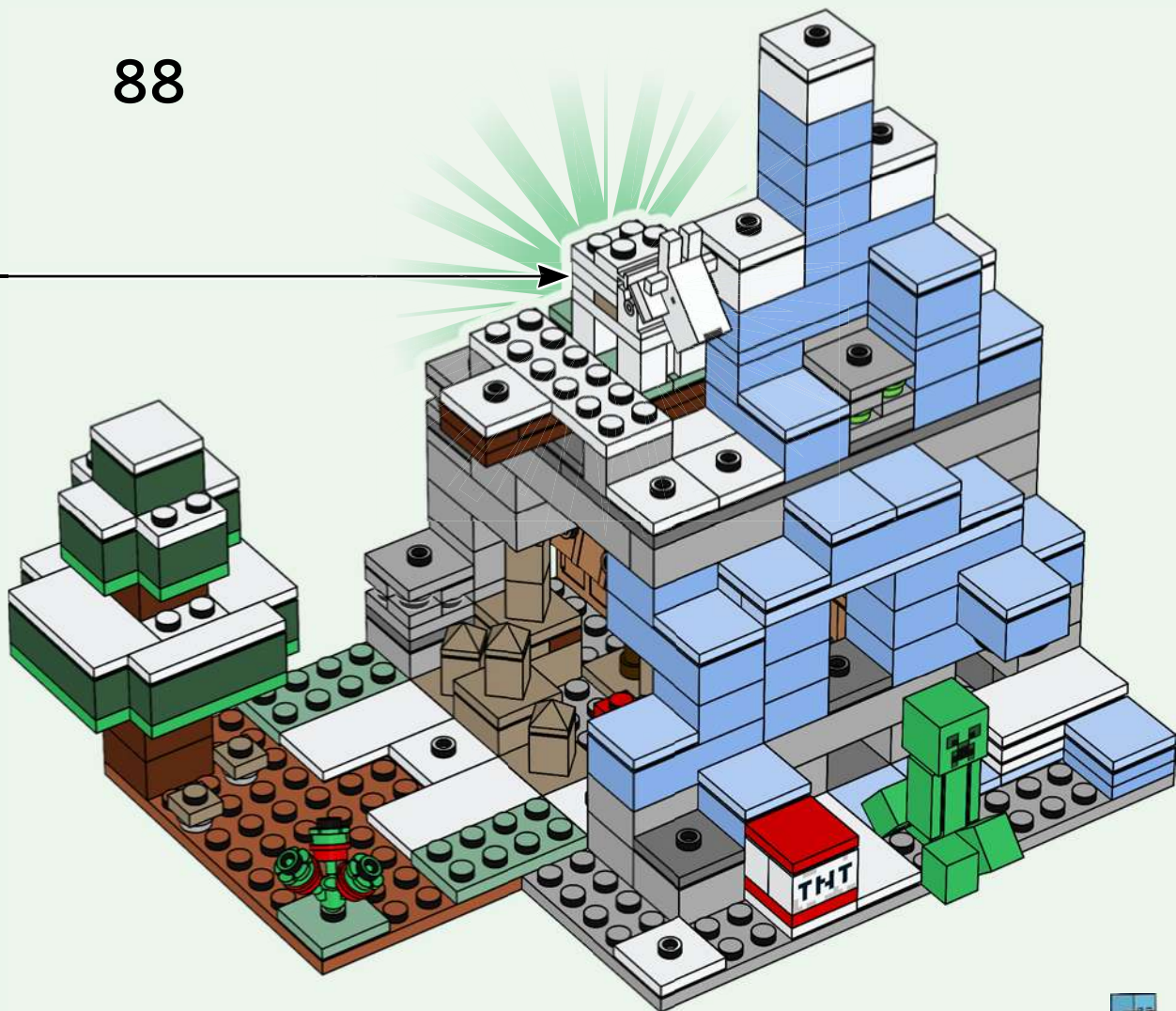



89

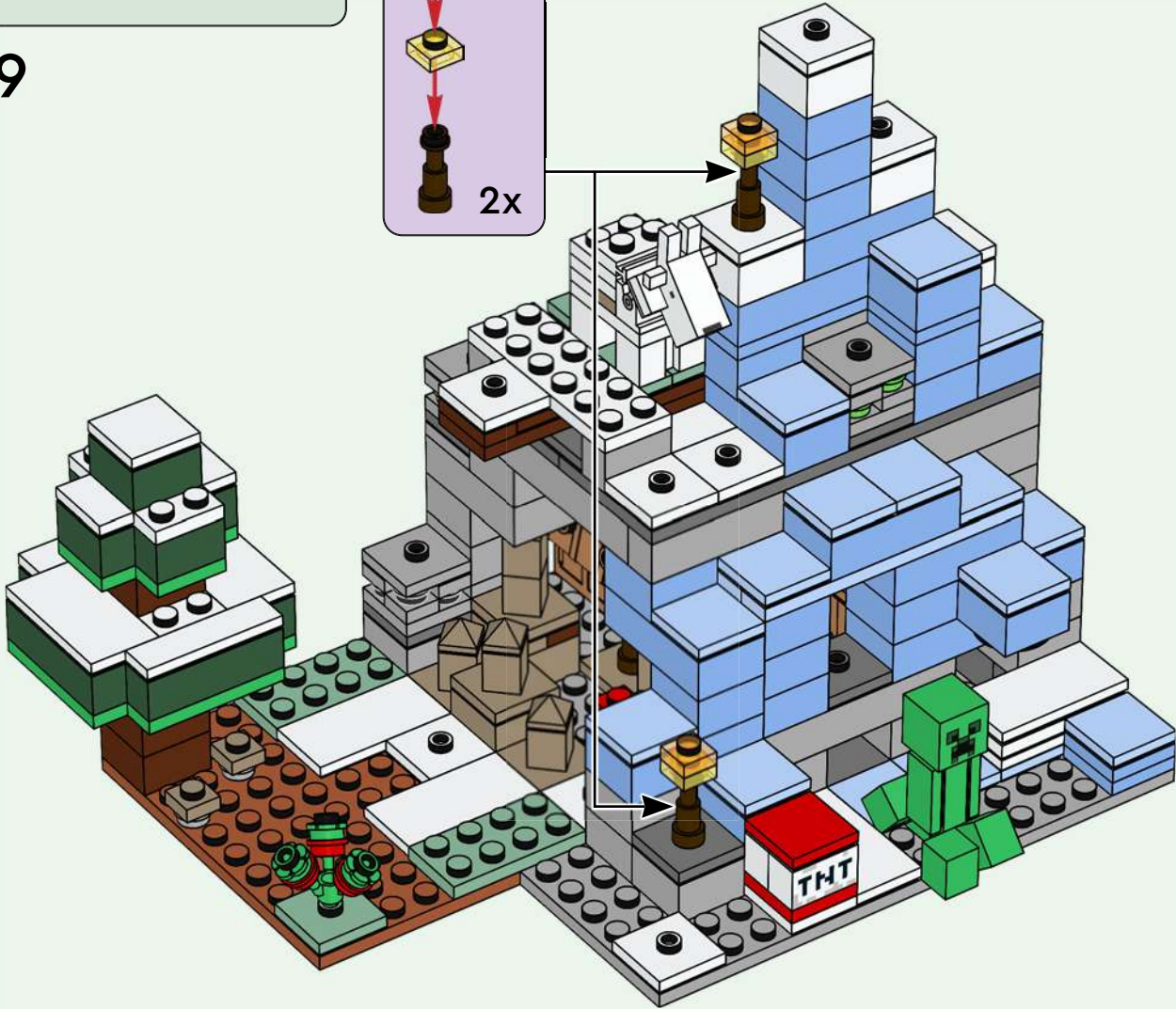
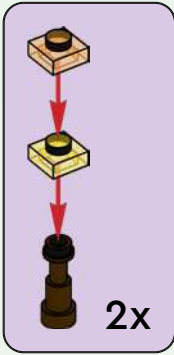





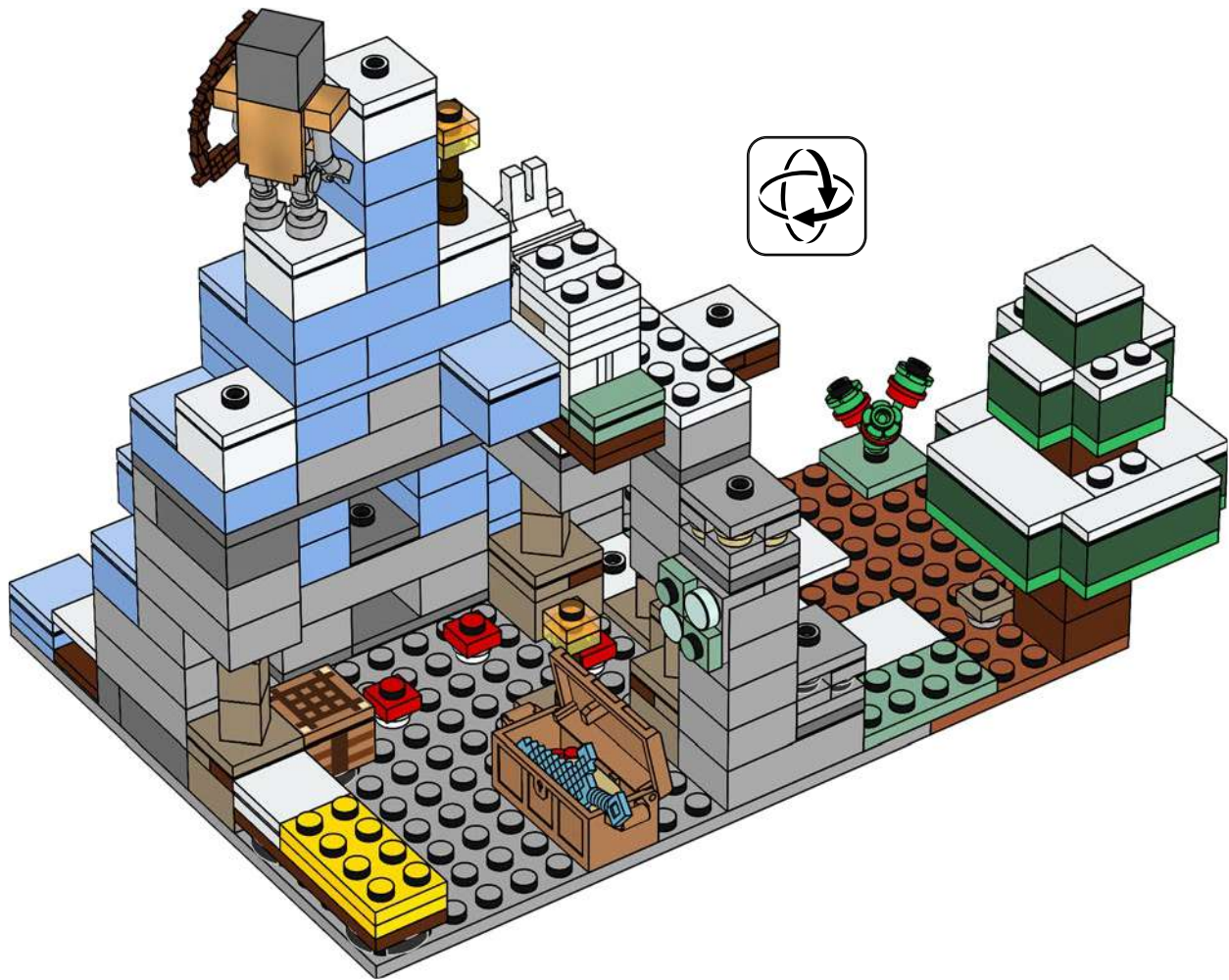



MINECRAFT

21243



21244



21241



21245





MINECRAFT

21242



21246



2x
6322818



1x
6104050



2x
6097024



1x
6097003



1x
6394960



1x
6102984



17x
6162894



2x
6372125



1x
6093623



1x
6426170



1x
4210762



6x
6126083



2x
4211105



2x
4560184



1x
4539429



1x
4210706

4x
614126



3x
403226



2x
6099189



2x
4616578



1x
6282619



1x
6186826



1x
6202626



2x
6249817



11x
4201235



3x
4653540



14x
4205058



1x
6101858



1x
6101858



1x
6263971



1x
6338355



1x
6400307



1x
6162384



3x
4538950



2x
4245570



1x
6214611



2x
4245571



3x
4260493



1x
4211795



1x
4211795



1x
4211522



1x
4211522



1x
4620130



1x
4620130



3x
6252045



3x
6405699



9x
6001824



2x
4549436



1x
6245275



1x
4528604



7x
6126075



4x
4255416



3x
4550168



3x
4550168



1x
6093629



 [LEGO.com/service](https://www.LEGO.com/service)

4x
614101

1x
302301

2x
4264360

1x
393701

2x
306901

2x
6097028

1x
6397842

1x
4249563

3x
302201

11x
6126046

2x
306801

4x
300301

1x
242001

1x
6013866

1x
302101

2x
243101

7x
4560178

2x
302001

1x
379501

4x
4161734

2x
6397819

3x
6223427

1x
6100565

3x
302421

1x
302221

1x
306821

1x
6331822

2x
302024

4x
6109808

3x
6135287

1x
6368255

1x
6162485

1x
6269971

2x
302328

2x
306928

1x
6336574

1x
6424003

1x
6192875

2x
371028

1x
302028

1x
4116671

3x
6252040

3x
4216581

3x
4221744

4x
4211150

1x
4211151

1x
6192310

1x
6089103

4x
4211210

2x
6257604

2x
4211186

1x
4211247

2x
6423983

2x
4211525

2x
6252203

1x
6057487

12x
4211399

1x
4211470

1x
4211398

2x
4211388

1x
6117967

1x
6435715

3x
4211397

3x
6126082

9x
4211387

1x
4211349

10x
4211385

1x
4211393

YOU COULD **WIN**



Scan this QR code or go to **LEGO.COM/PRODUCTFEEDBACK** and give us your short feedback about this LEGO® set for a chance to win a cool LEGO prize.

Terms and Conditions apply*

DE: Du könntest GEWINNEN. Es gelten die Teilnahmebedingungen* **FR: Tu pourrais GAGNER.** Des conditions s'appliquent* **IT: Potresti VINCERE tu.** Termini e condizioni sono applicabili* **ES: Puedes GANAR.** Aplican términos y condiciones* **PT: Poderá GANHAR.** Aplicam-se termos e condições* **JA: プレゼント付き! 利用規約が適用されます*** **ZH: 轻松获奖. 条款和条件适用*** **KO: 상품의 주인이 되어보세요. 소정의 약관이 적용됩니다*** **RU: Вы можете ВЫИГРАТЬ.** Действуют положения и условия* **PL: Szansa na WYGRANĄ.** Obowiązują warunki korzystania* **CS: Máte šanci VYHRÁT.** Platí všeobecné smluvní podmínky* **SK: Máte šancu VYHRAŤ.** Platia všeobecné zmluvné podmienky* **HU: TE IS NYERHETSZ.** Felhasználási feltételek érvényesek* **RO: Ai putea CÂȘTIGA.** Se aplică termeni și condiții* **BG: Можете да СПЕЧЕЛИТЕ.** Има определени правила и условия* **LV: Tu vari LAIMĒT.** Ir spēkā noteikumi un nosacījumi.* **ET: Sul on võimalus VÕITA.** Kehtivad tingimused* **LT: Jūs galite LAIMĖTI.** Taikomos sąlygos*

*LEGO.com/productfeedback-terms

LEGO and the LEGO logo are trademarks of the LEGO Group. ©2023 The LEGO Group.



© 2023 Mojang AB. All Rights Reserved. Minecraft, the Minecraft logo, the Mojang Studios logo and the Creeper logo are trademarks of the Microsoft group of companies.

6448773