

# GLOBO

LIGHTING

www.globo-lighting.com

41368-24

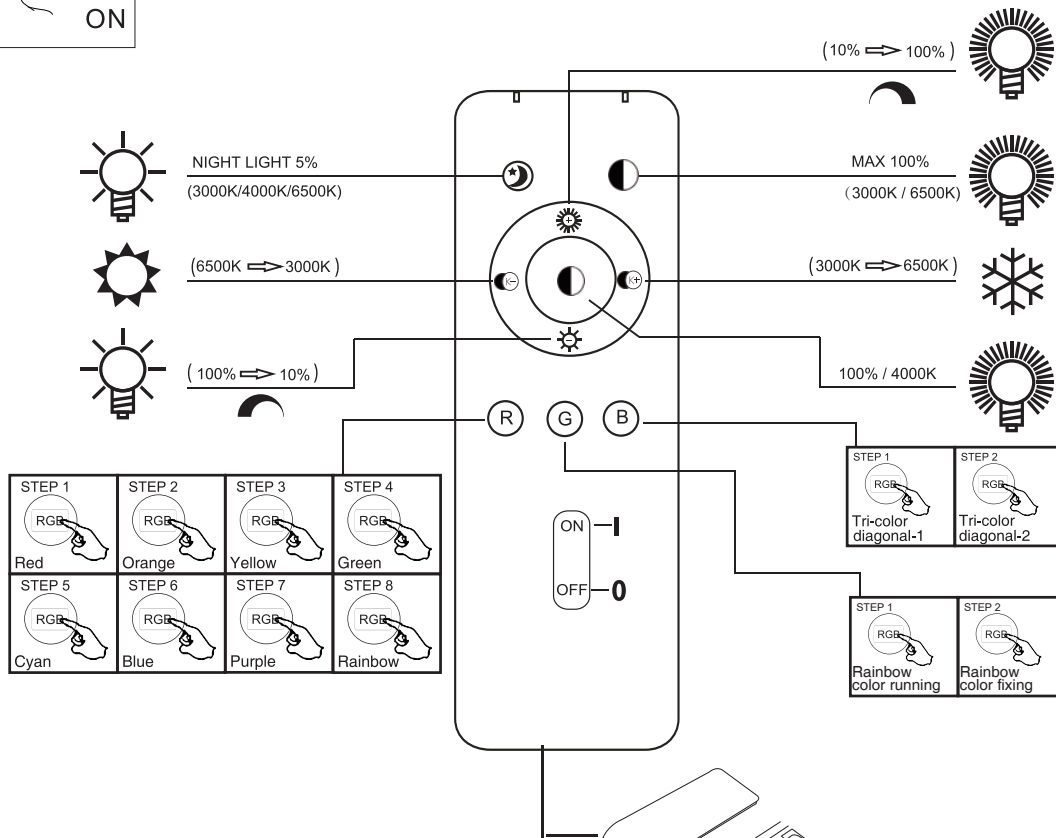
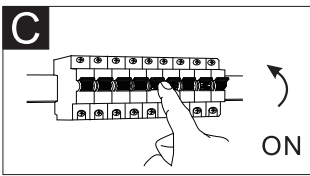
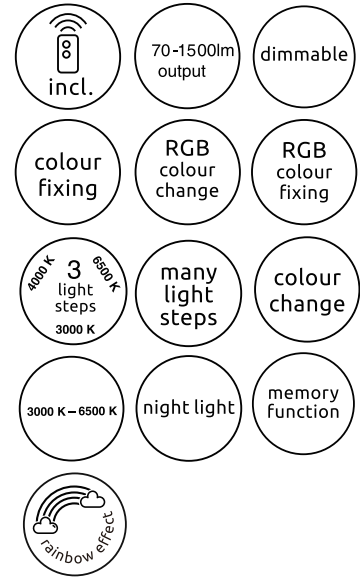
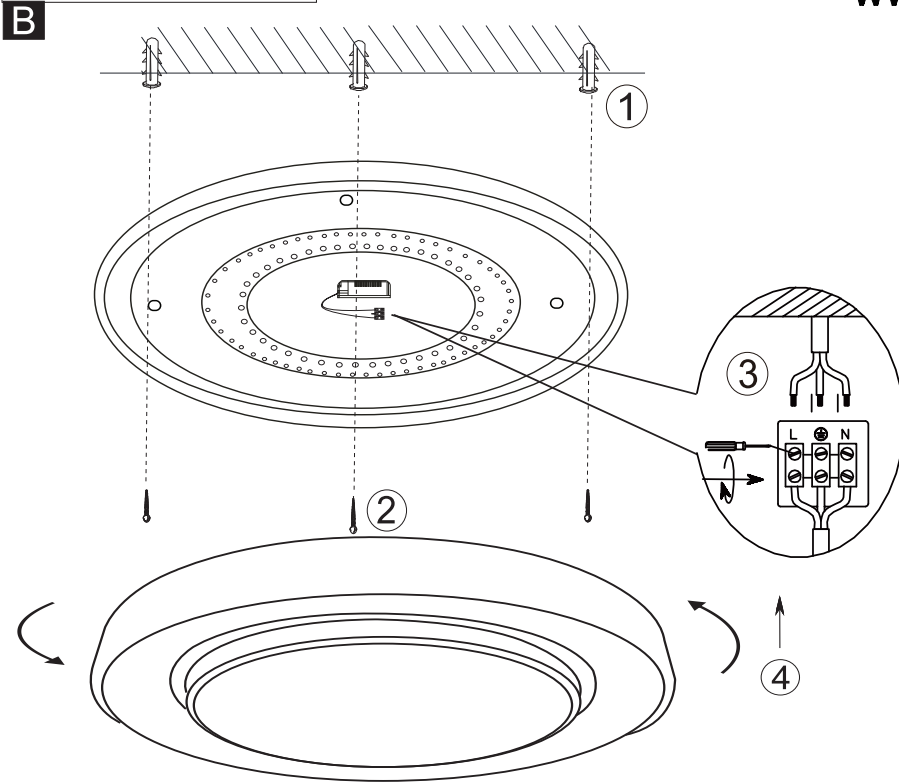
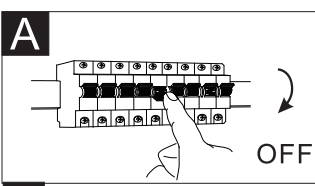

GLOBO Handels GmbH  
 Gewerbestr. 3  
 A-9184 Sankt Peter  
 Austria



**DEU:**  
Lichtquelle  
Die Lichtquelle ist nicht tauschbar, weil sie konstruktionsbedingt fest mit dem umgebenden Produkt verbunden ist.  
Dieses Produkt enthält eine Lichtquelle der Energieeffizienzklasse <F>.

 Austausch des Betriebsgeräts durch einen Professionisten.   Leuchtmittel nicht austauschbar.

**GBR:**  
Light source:  
The light source is not interchangeable because it is determined by the surrounding product design.  
This product contains a light source of energy efficiency class <F>.

 Replaceable control gear by a professional.   Non replaceable light source.



**BIH:**  
Izvor svjetla :  
Izvor svjetla nije zamjenjiv , jer je konstrukcijski pričvršćen na proizvod .  
Ovaj proizvod sadržiava izvor svjetlosti klase energetske učinkovitosti <F>.

 Izmjenu pogonskog uređaja smije izvršiti i samo profesionalna osoba.   LED žarulje nije moguće zamjenit.

**BG:**  
Източник на светлина:  
Източникът на светлина не може да се подменя, тъй като поради конструкцията си е трайно фиксиран към заобикалящия го продукт.  
Този продукт включва светлинен източник с клас на енергийна ефективност <F>.

 Смяна на управляващото устройство от професионалист.   Източникът на светлина не може да се подменя.



**CZ:**  
Zdroj světla:  
Světelný zdroj není možné vyměnit, protože je díky své konstrukci pevně spojený s produktem. Tento výrobek obsahuje světelný zdroj s třídou energetické účinnosti <F>.

 Výměna předřadníku jen odborníkem.   Světelný zdroj není vyměnitelný.



**DK:**  
Lyskilde:  
Lyskilden kan ikke udskiftes, fordi den er fast forbundet med det omgivende produkt.  
Dette produkt indeholder en lyskilde i energieffektivitetsklasse <F>.

 Enheden skal skiftes af en fagperson.   Lyskilden kan ikke udskiftes.



**ET:**  
Valgusallikas:  
Valgusallikas ei ole välja vahetatav, sest ta on tootega hituslikult kindlat seotud.  
Toode sisaldab energiatõhususe klassi <F> valgusallikat.

 Juhtimiseseadise välja vahetamine professionaali poolt.   Lamp ei ole välja vahetatav.



**FI:**  
Valonlähde:  
Valonlähdettä ei voi vaihtaa uuteen, sillä se on rakenteellisesti yhdistetty ympäröivään tuotteeseen.  
Tämä tuote sisältää valonlähteen, jonka energiatehokkuusluokka on <F>.

 Liitäntälaitteen vaihtaa ammattilainen.   Valonlähdettä ei voi vaihtaa.



**FR:**  
Source lumineuse:  
La source lumineuse n'est pas remplaçable car elle est, de par la construction du produit, liée de façon permanente à celui-ci.  
Ce produit contient une source lumineuse de classe d'efficacité énergétique <F>.

 Remplacement du dispositif de commande par un professionnel.   Ampoule non remplaçable.



**GR:**  
Φωτεινή πηγή:  
Η φωτεινή πηγή δεν μπορεί να αντικατασταθεί, επειδή είναι για κατασκευαστικούς λόγους σταθερά συνδεδεμένη με το προϊόν που την περιβάλλει.  
Το προϊόν αυτό περιέχει φωτεινή πηγή της τάξης ενεργειακής απόδοσης <F>.

 Αντικατάσταση της διάταξης λειτουργίας από έναν επαγγελματία.   Ο λαμπτήρας δεν μπορεί να αντικατασταθεί.

**HU:**  
Fényforrás:  
A fényforrás nem cserélhető, mert felépítése miatt szilárdan csatlakozik a termékhez Ez a termék egy <F> energiatékonysági osztályú fényforrást tartalmaz.

 Az előléteset csak szakértők cserélhetik ki.   A fényforrás nem cserélhető.

**Isländisch/IS:**  
Ljósgrafi:  
Ljósgrafinn er ekki útskiptanlegur vegna þess að hann er háður umliggjandi hönnun vörunnar.  
Varan inniheldur ljósgrafa í orkuflökki <F>.

 Útskiptanlegur stýribúnaður sem fagmaður á að framkvæma.   Ekki útskiptanlegur ljósgrafi.

**IT:**  
Sorgente luminosa:  
La sorgente luminosa non è intercambiabile perché è saldamente collegata al prodotto per via del suo design.  
Questo prodotto contiene una sorgente luminosa di classe di efficienza energetica <F>.

 Izmjenu pogonskog uređaja smije izvršiti i samo profesionalna osoba.   LED žarulje nije moguće zamjenit.

**HR :**  
Izvor svjetla :  
Izvor svjetla nije zamjenjiv , jer je konstrukcijski pričvršćen na proizvod .  
Ovaj proizvod sadržiava izvor svjetlosti klase energetske učinkovitosti <F>.

 Izmjenu pogonskog uređaja smije izvršiti i samo profesionalna osoba.   LED žarulje nije moguće zamjeniti.

**LV:**  
Gaismas avots:  
Gaismas avotu nevar nomainīt, jo tas konstrukcijā ir cieši savienots ar izstrādājuma apkārtnē daļu.  
Šis ražojums satur gaismas avotu, kura energoefektivitātes klase ir <F>.

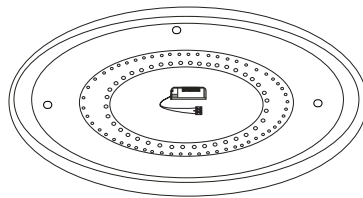

 Vadības ierīci var nomainīt speciālists.   Apgaismes līdzekļi nevar nomainīt.





**LT:**  
Šviesos šaltinis:  
Šis šviesos šaltinis yra nekeičiamas, nes jis prijungtas prie gaminio pagal jo konstrukciją.  
Šiame gaminyje yra šviesos šaltinis, kurio energijos vartojimo efektyvumo klasė <F>.

 Valdymo įtaisą keičia profesionalas.   Šviesos šaltinis yra nekeičiamas.



**NL:**  
Lichtbron:  
De lichtbron kan niet worden vervangen, omdat deze vanwege de constructie vast met het product eromheen verbonden is.  
Dit product bevat een lichtbron van energie-efficiëntieklasse <F>.

 Vervanging van het apparaat door een expert.   Verlichting kan niet worden vervangen.



**Norwegian/Norwegian / NO:**  
Lyskilde:  
Lyskilden kan ikke byttes fordi den sitter fast i produktet.  
Dette produktet inneholder en lyskilde i energiklasse <F>.

 Byte av driftsapparatet må gjøres av fagmann.   Lyskilden kan ikke byttes ut.



**PL:**  
Źródło światła:  
Źródła światła nie można wymienić, ponieważ jest zintegrowane z produktem ze względu na swoją konstrukcję.  
Ten produkt zawiera źródło światła o klasie efektywności energetycznej <F>.

 Wymiana osprzętu sterującego wyłącznie przez specjalistę.   Źródła światła nie można wymienić.

**PT:**  
Fonte de Luz:  
A fonte de luz não é substituível porque devido às suas características construtivas está fixada de forma permanente ao produto circundante.  
Este produto contém uma fonte de luz da classe de eficiência energética <F>.

 Substituição do dispositivo de comando por parte de um profissional.   Lâmpada não substituível.

**RO:**  
Sursa de lumina:  
Sursa de lumina nu este inlocuibilă ea fiind parte constructivă a produsului  
Acest produs conține o sursă de lumină cu clasa de eficiență energetică <F>.

 Schimbarea unitatii de control trebuie facuta doar de catre personal.   Sursa de lumina nu poate fi schimbata.

**RUS:**  
Источник света:  
Источник света не является взаимозаменяемым, поскольку это определяется конструкцией смежного продукта.  
Данный продукт содержит источник света класса энергоэффективности <F>.

 Замена регулировочного механизма специалистом.   Незаменяемый источник света.



**SRB:**  
Izvor svetlosti:  
Izvor svetlosti nije zamenjiv, jer je zbog svog dizajna čvrsto povezan sa proizvodom koji ga okružuje. Ovaj proizvod sadrži izvor svetlosti klase energetske efikasnosti <F>.

 Zamena upravljačkog uređaja od strane profesionalca.   Izvor svetlosti se ne može zameniti.

**SK:**  
Zdroj svetla:  
Světelný zdroj nie je možné vymeniť, pretože je vďaka svojej konštrukcii pevne spojený s produktom. Tento výrobok obsahuje svetelný zdroj triedy energetickej účinnosti <F>.

 Výměna předradníka len odborníkom.   Svetelný zdroj nie je vymeniteľný.



**SI:**  
Izvor svetlobe:  
Vir svetlobe ni zamenljiv, ker je določen z zasnovno izdelka v okolici.  
Ta izdelek vsebuje svetlobni vir razreda energijske učinkovitosti <F>.

 Zamenljiv krmlinik s strani strokovne osebe.   Nezamenljiv vir svetlobe.



**ES:**  
Fuente de luz:  
La fuente de luz no es sustituible porque está fija en el producto desde la construcción.  
Este producto contiene una fuente luminosa de la clase de eficiencia energética <F>.

 Sustitución del aparato por un profesional.   Bombilla no reemplazable.



**SE:**  
Ljuskälla:  
Ljuskällan är inte utbyttbar, eftersom den på grund av konstruktionen är fast integrerad i den omgivande produkten.  
Denna produkt innehåller en ljuskälla med energieffektivitetsklass <F>.

 Byte av driftdonet genom en fackman.   Ljuskällan är inte utbyttbar.

**TR:**  
Işık kaynağı:  
Konstrüksiyon gereği çevreleyen ürünü ile sabit bir şekilde bağlı olduğu için ışık kaynağı değiştirilemez.  
Bu ürün, <F> enerji sınıfından bir ışık kaynağına sahiptir.

 İşletme cihazının bir profesyonel tarafından değiştirilmesi.   Aydınlatma malzemesi değiştirilemez.

**UK:**  
Джерело світла:  
Джерело світла не можна обміняти, оскільки воно міцно пов'язане з навколишнім виробом завдяки своїй конструкції.  
Цей виріб містить джерело світла класу енергоефективності <F>.

 Заміна контрольної передачі професіоналом.   Цібулини не взаємозамінні.