



Architecture

21046

Empire State Building

New York, USA



Booklet available in English on
Heft in deutscher Sprache erhältlich auf
Livret disponible en français sur
Libretto disponibile in italiano su
Folleto disponible en español en
Folheto disponível em português em
A füzet magyarul ezen a honlapon olvasható:
Buklets latviešu valodā pieejams vietnē
如需中文版手册, 请访问

LEGO.com/architecture



An Icon of its Time

At 102 stories, the Empire State Building may no longer be the tallest skyscraper in New York, but it is undoubtedly one of the most significant. No visit to the city is complete without a trip to the building's observation deck to experience the unforgettable views of the city. Designed by Shreve, Lamb & Harmon and completed in 1931, a lot of the building's cultural significance lies within its great history. A sign of hope and optimism during the Great Depression, it was built in record time and became the tallest building in the world, a title it retained for almost 40 years.

The Empire State Building also embodies the refinement and evolution of steel construction and technological prowess, though its design and construction faced many technical problems at the time. But a spirit of innovation and determination prevailed, and the building has taken its place in architectural and cultural history as a symbol of power and grandeur.





The Creation of an Icon

Originally agricultural land, the prominent Astor family bought the area in 1827 and built the Waldorf-Astoria hotel on the site in the late 1890s. Eventually, businessman John Raskob and former governor Al Smith, who later became part of the Empire State Inc. group of investors, bought and demolished the outdated hotel, and contracted William Lamb to create the building design.

Before the designs were even finished, work started on the building's construction on March 17th, 1930. The pace of construction was phenomenal; with an average construction rate of four and a half stories a week. By September of the same year, 86 stories were built, and the mast was completed by November. The entire construction was finished, and the building officially opened by President Hoover on May 1st, 1931, 45 days ahead of schedule.

A Symbol of New York

After its construction, the Empire State Building became an instant tourist attraction, with visitors coming to see the spectacular views from the observation deck of the “World’s Tallest Building.” It became a National Historic Landmark in 1986 and was added to the National Register of Historic Places the year after. The American Society of Civil Engineers has also named it as one of the Seven Wonders of the Modern World, and in 2007 it was ranked at number one on the list of America’s Favorite Architecture by the American Institute of Architects. Aside from its many accolades and titles, the Empire State Building is a cultural symbol of New York, with starring roles in many movies, from the original King Kong to Sleepless in Seattle.



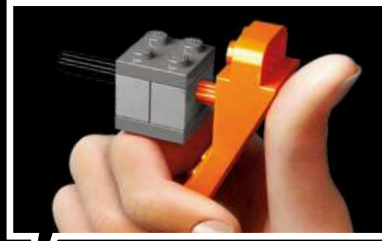
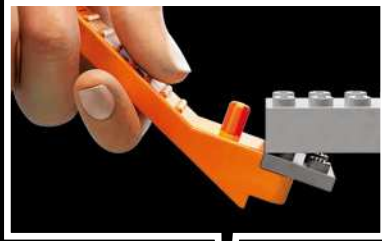

LEGO.com/brickseparator



- 1** Download the LEGO® Life App
 Lade dir die LEGO® Life App herunter
 Télécharge l'application LEGO® Life
 Télécharger l'application LEGO® Life
 Scarica l'app LEGO® Life
 Descarga la app LEGO® Life
 Descarrega a App LEGO® Life
 Töltsd le a LEGO® Life Appot!
 Lejupielādē lietotni LEGO® Life
 下載 LEGO® Life 应用程序



- 2** Scan the code on the front cover
 Scanne den Code auf der Titelseite
 Scanne le code sur la page de couverture
 Scanner le code sur la page couverture
 Scansiona il codice sulla copertina
 Escanea el código de la portada
 Faz scan do código na frente da capa
 Olvasd be a borítón látható kódot!
 Noskenē kodu uz priekšējā vāka
 扫描封面上的二维码



- 3** Get the Building Instructions
 Hol dir die Bauanleitung
 Obtens les instructions de montage
 Obtenir les instructions de montage
 Scarica le istruzioni per la costruzione
 Consulta las instrucciones de construcción
 Obtém as Instruções de Construção
 Szerezd be az építési útmutatókat!
 Saņem būvēšanas instrukcijas
 获取拼搭说明

LEGO.com/apps

Check for compatibility
 Kompatibilität prüfen
 Vérifier la compatibilité
 Controlla la compatibilità
 Comprueba tu compatibilidad

Verificar a compatibilidade
 Ellenőrizd a kompatibilitást
 Pārbaudīt saderību
 检查兼容性

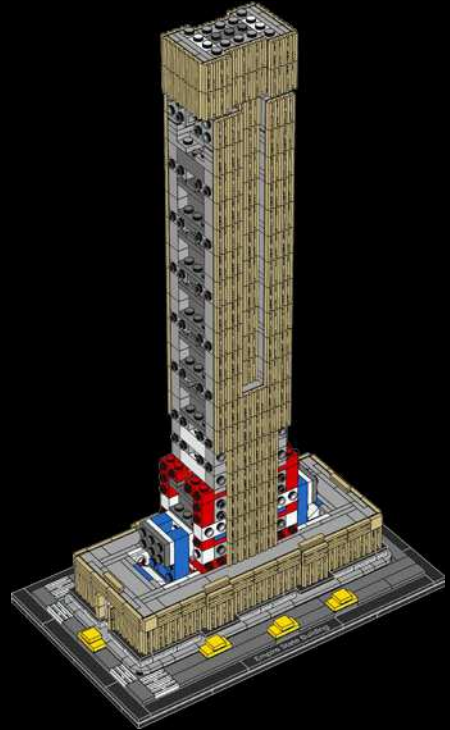
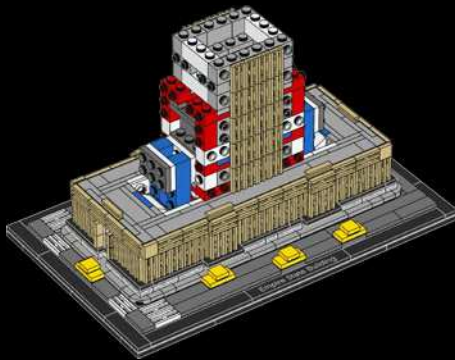
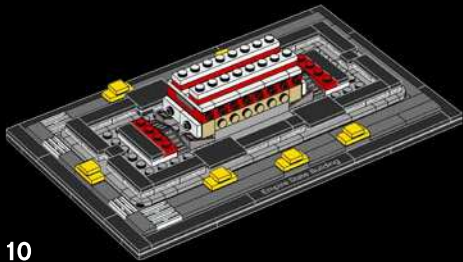

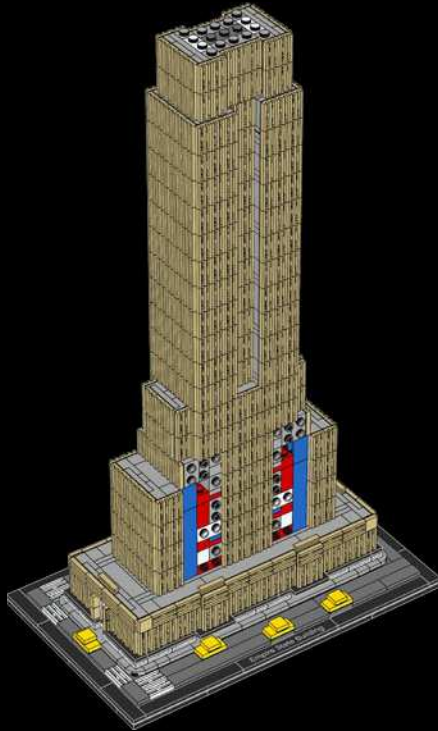

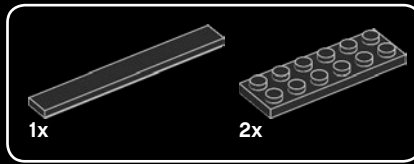

1

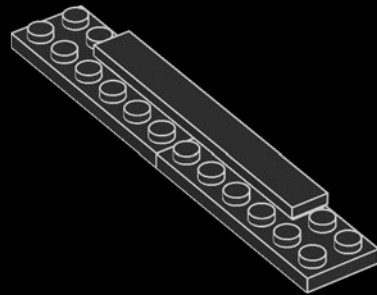
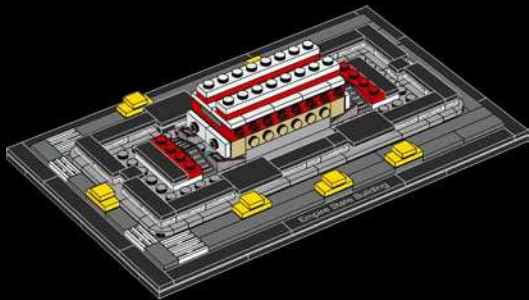

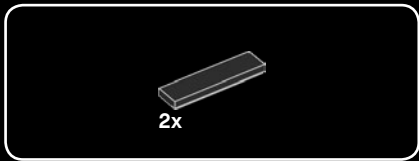

2

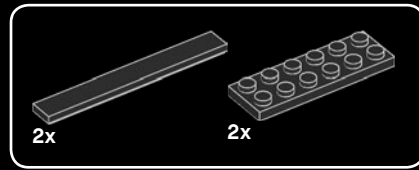
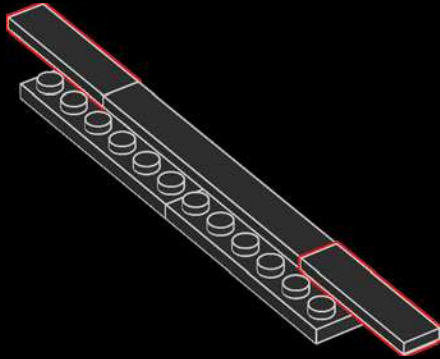

3

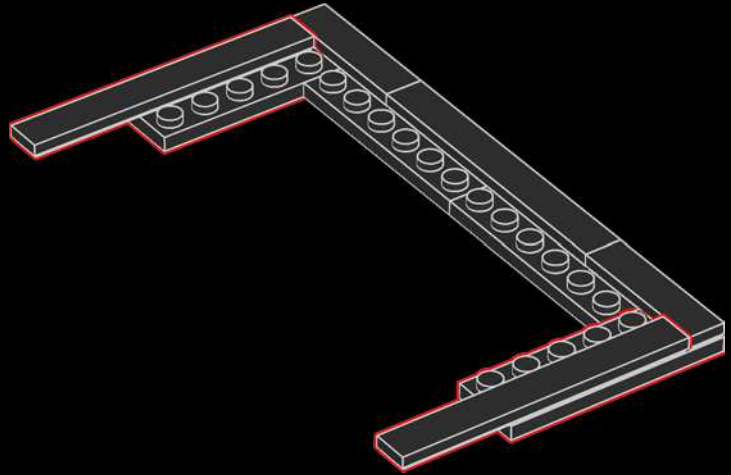

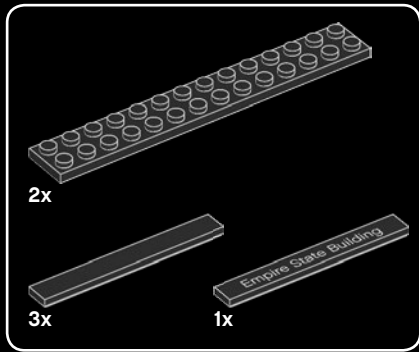

4

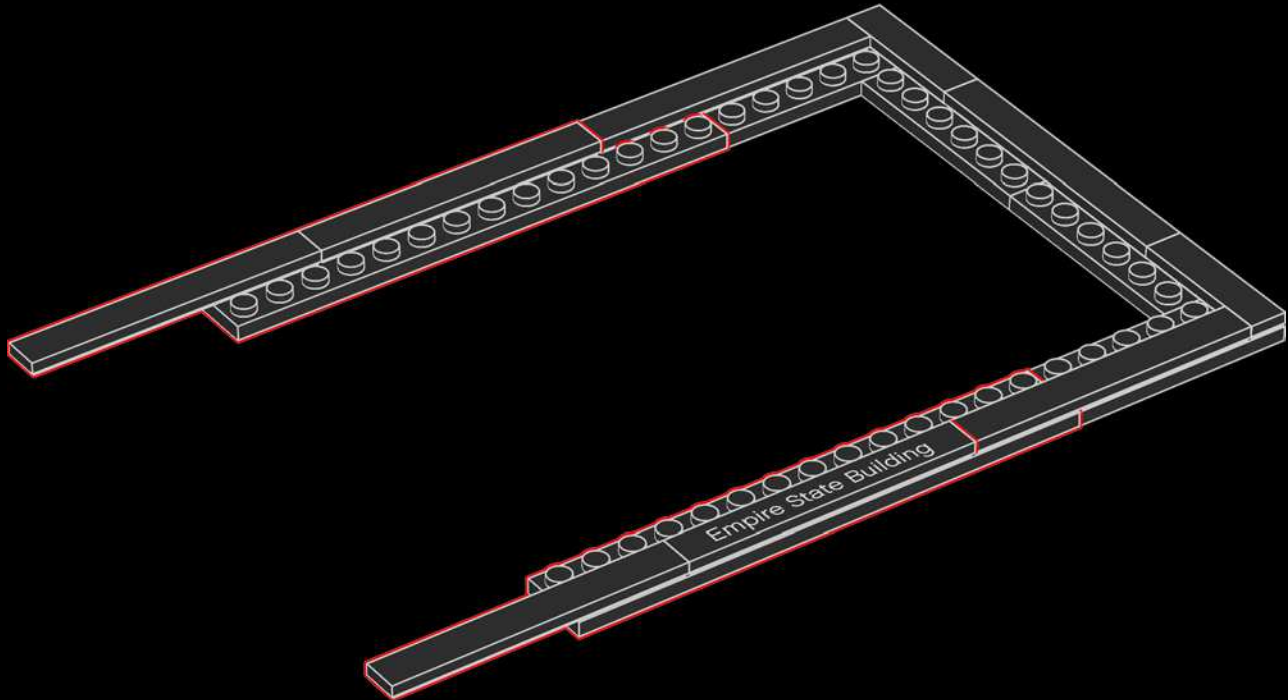

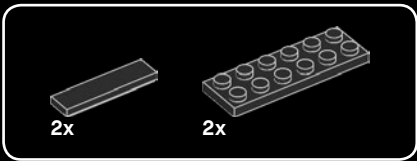

5

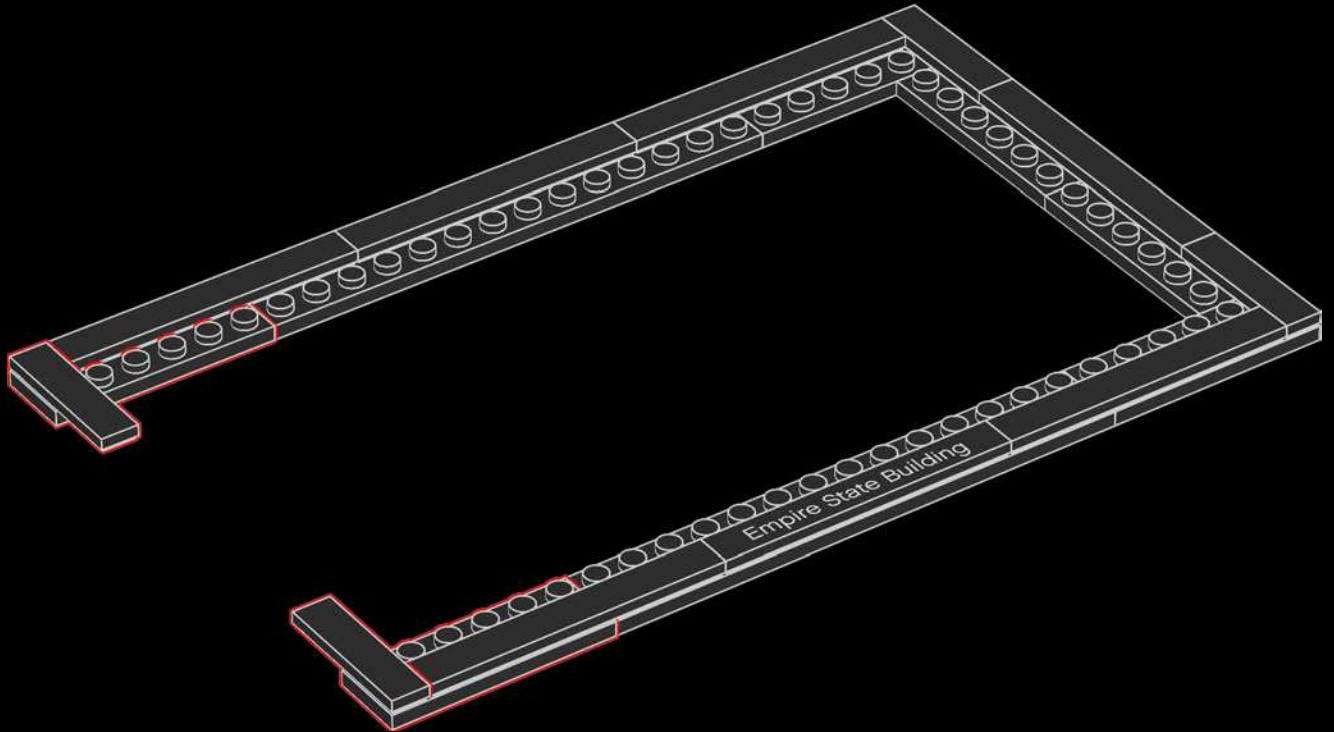

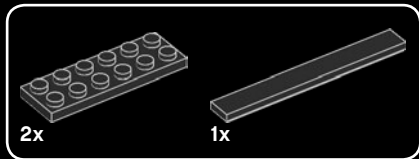

6

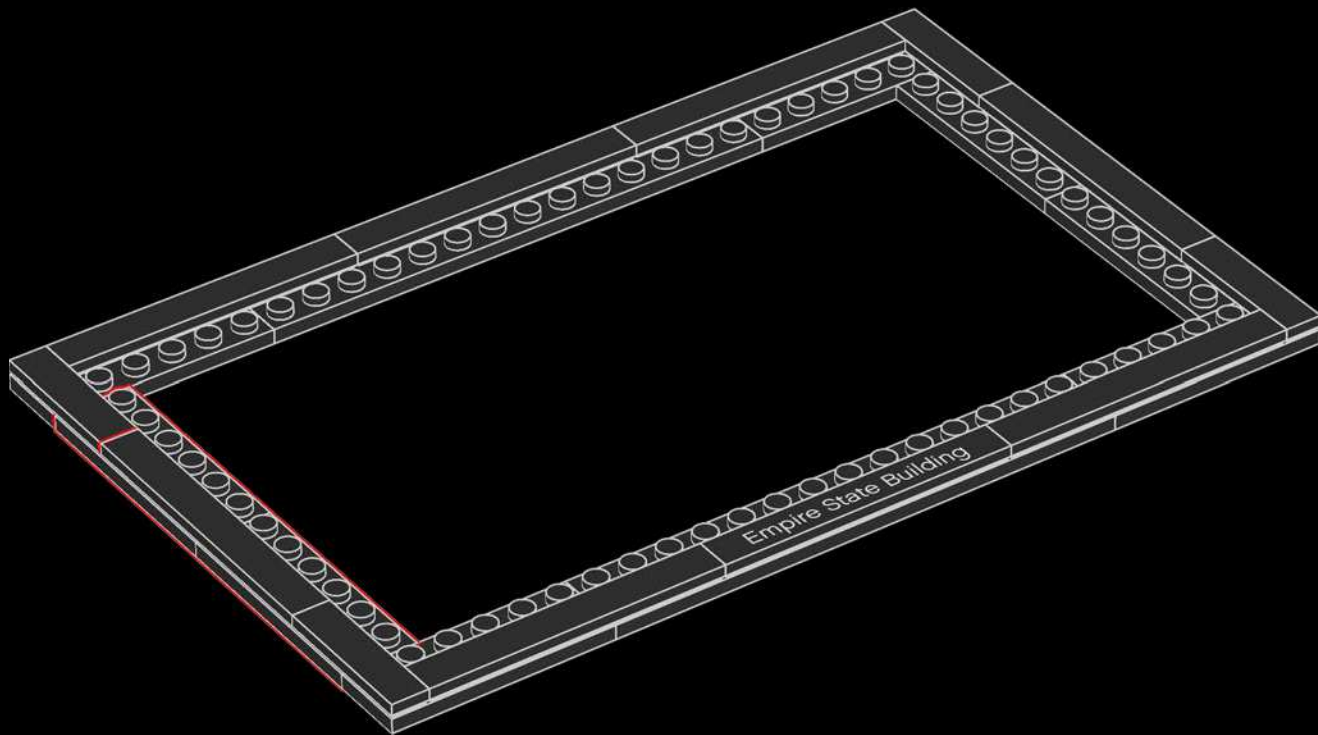

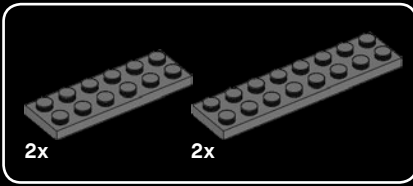

7

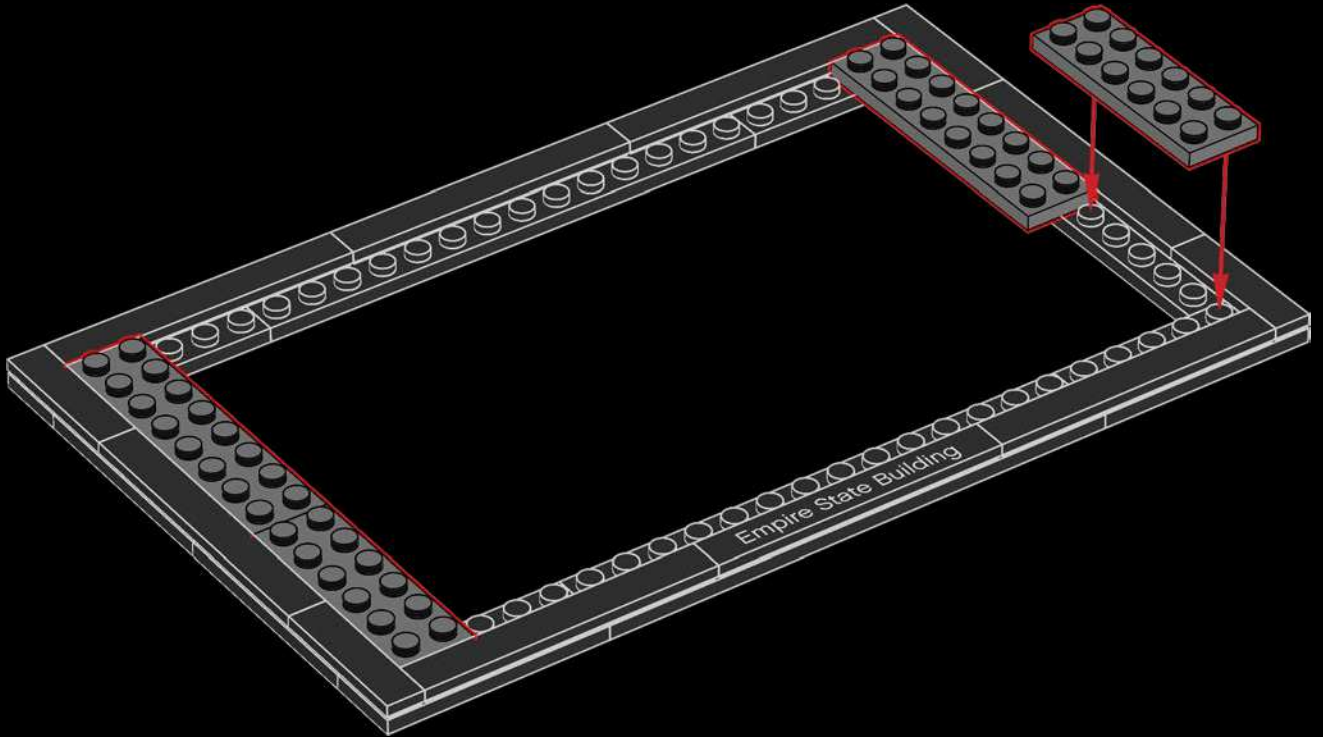

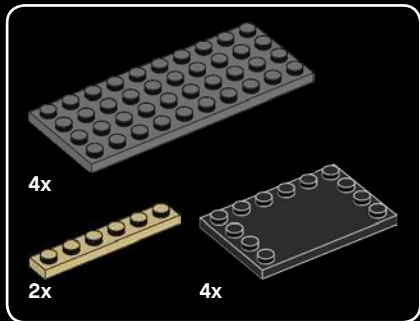
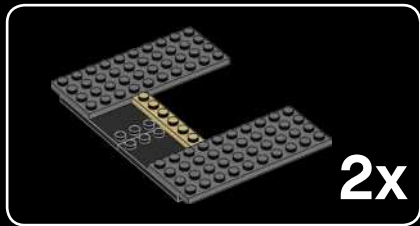

8

1

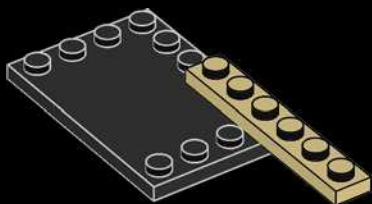

2

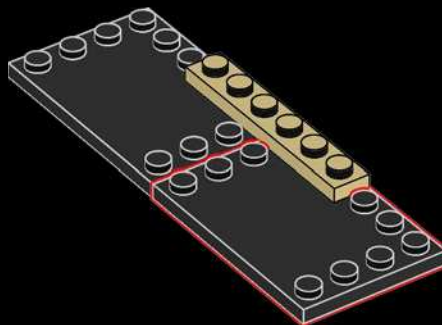

3

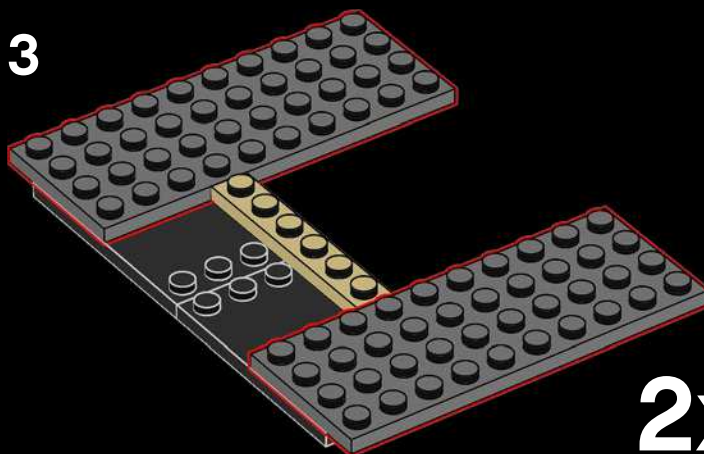

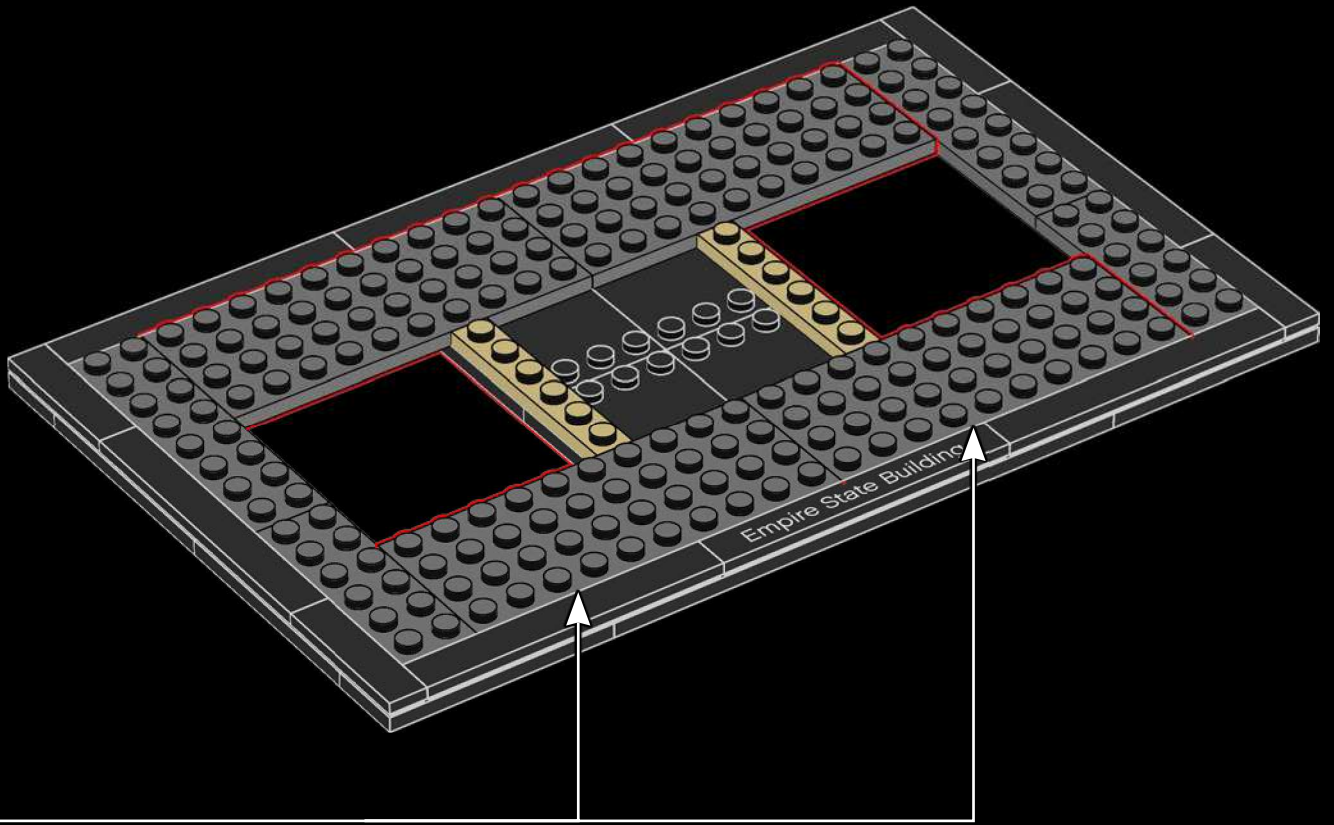



4x

9

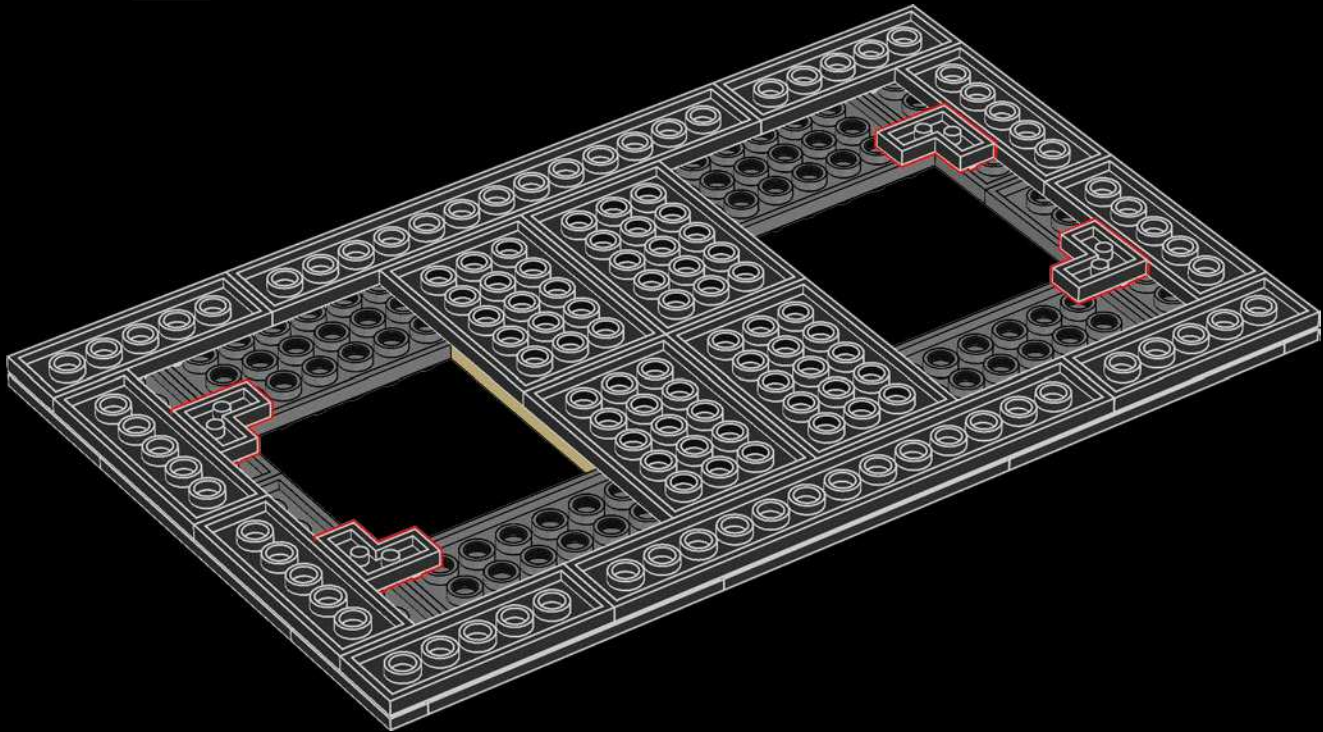

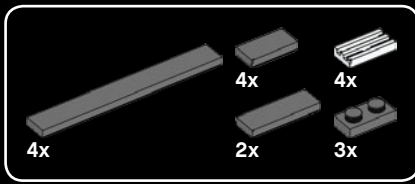

10

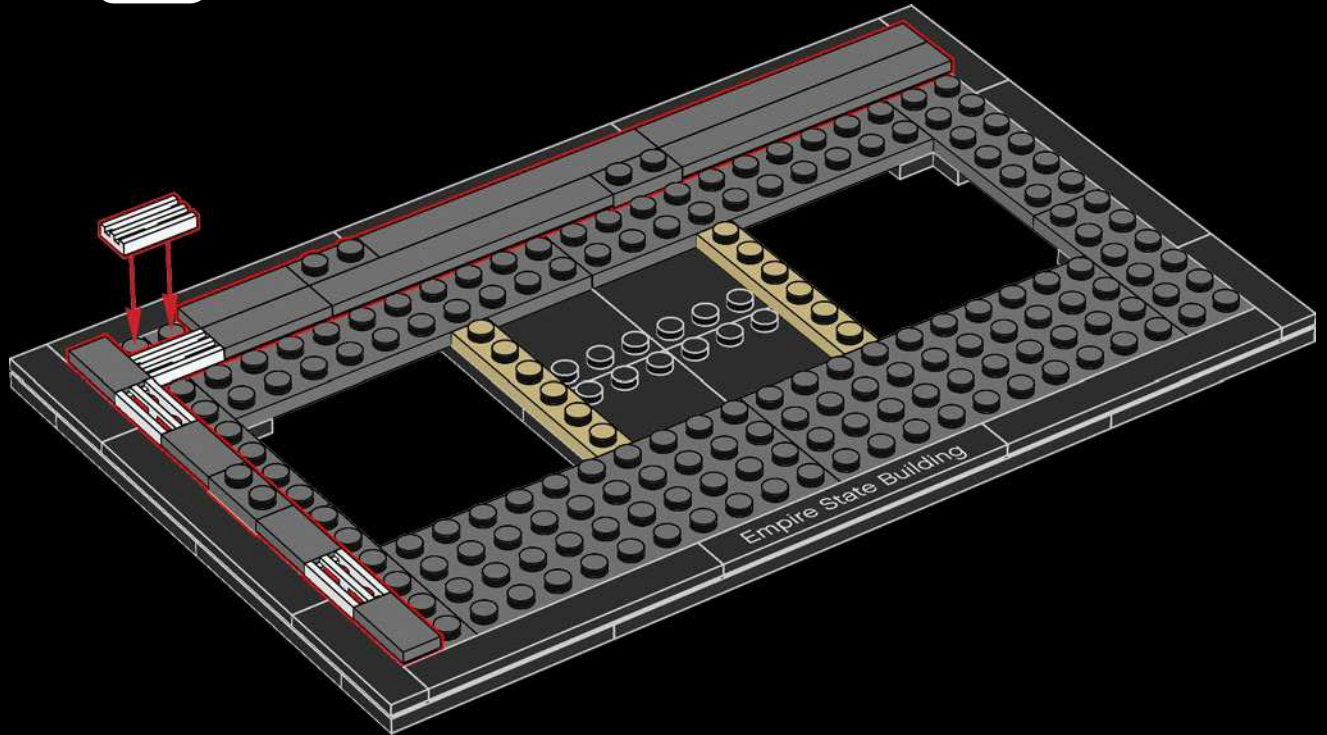

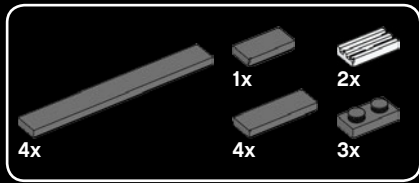

11

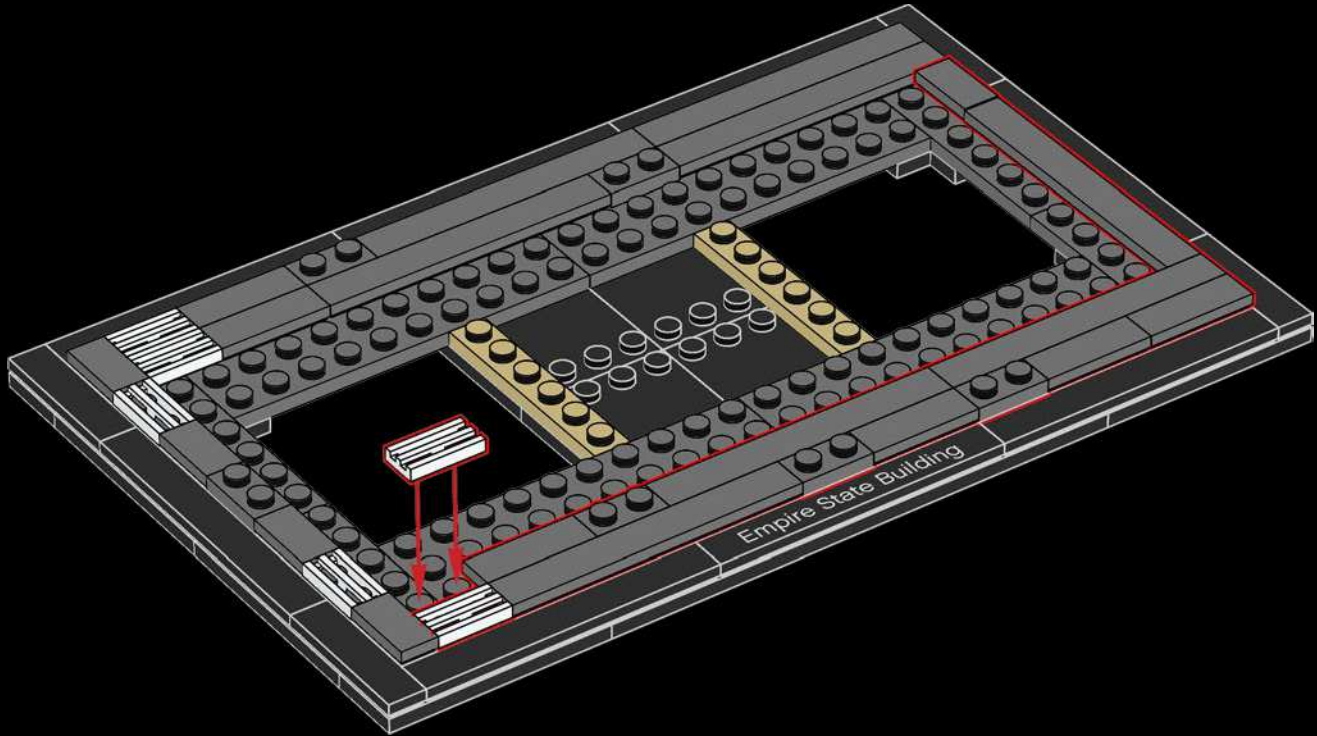

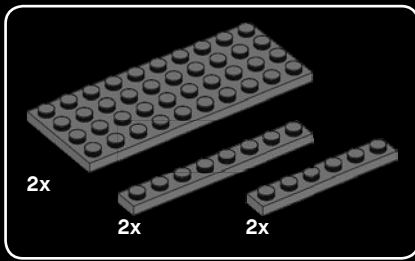

12

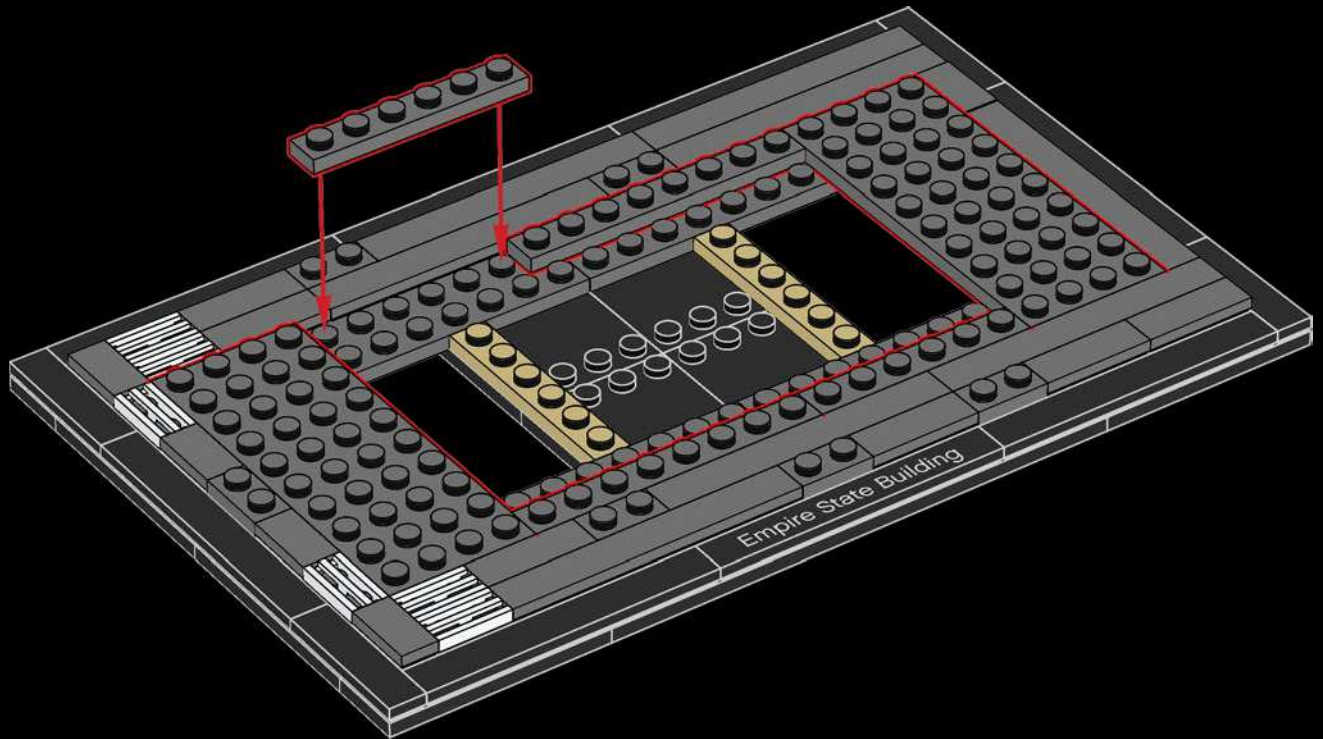

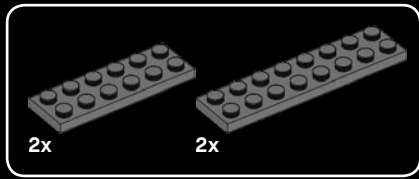

13

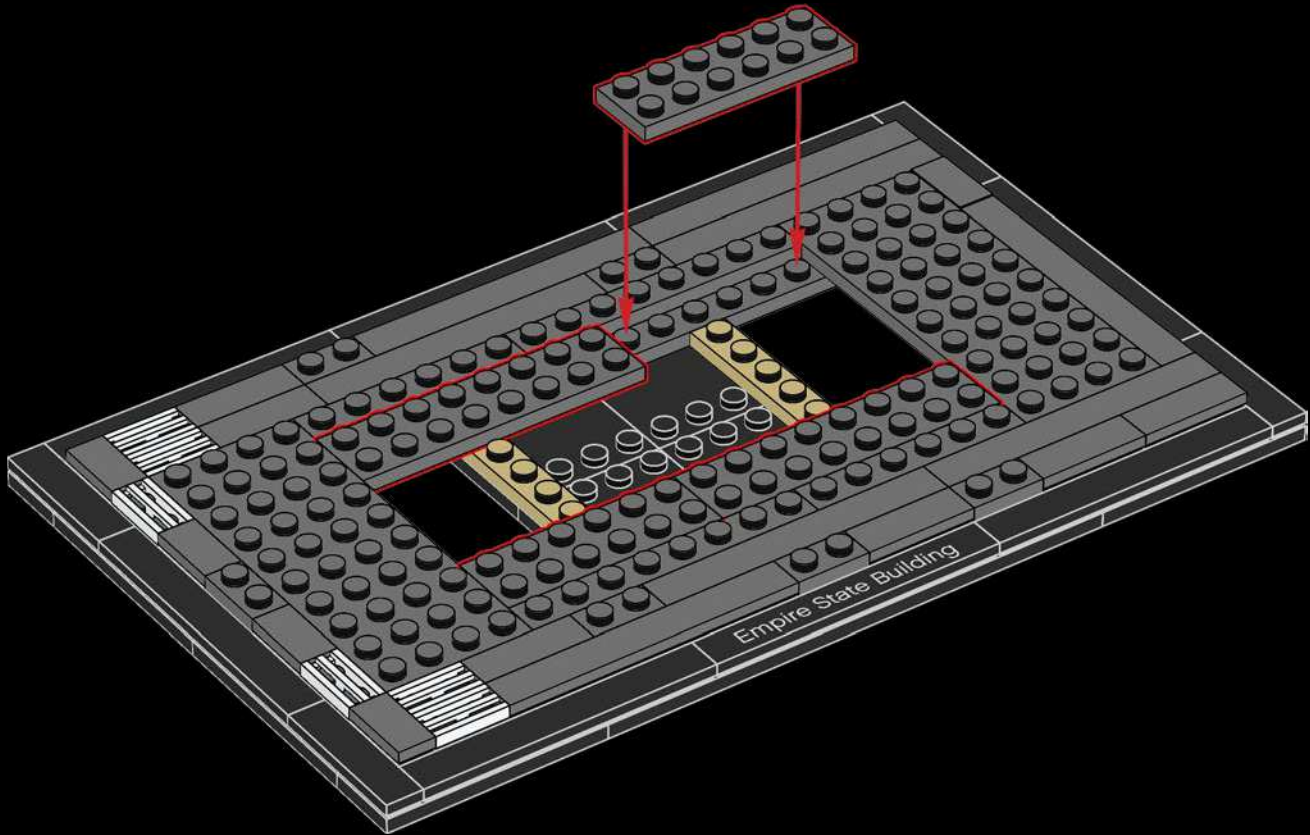

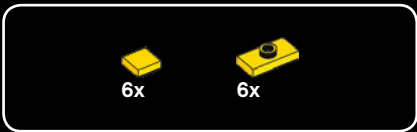

14

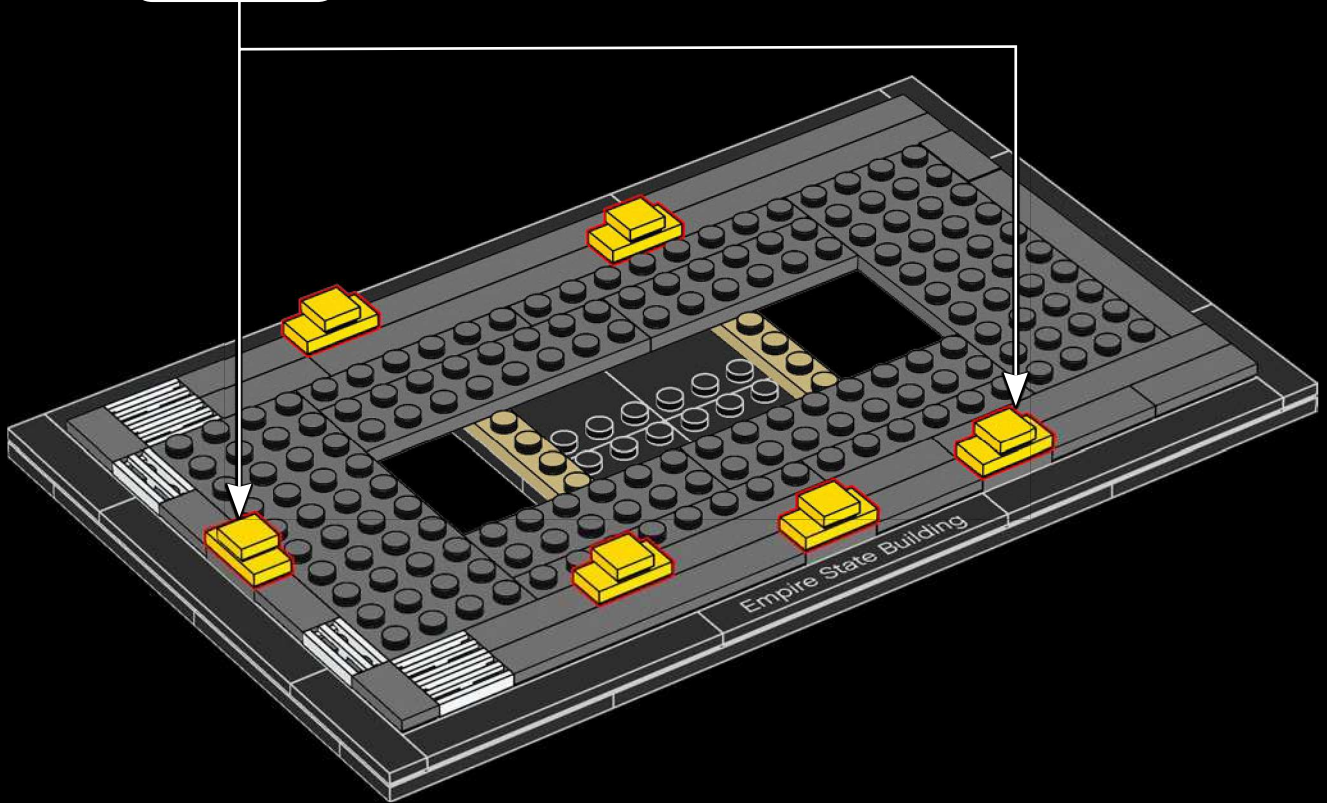
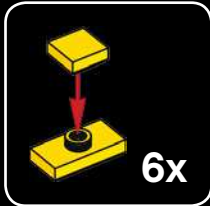

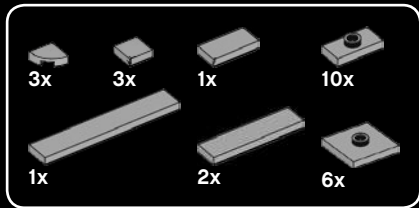

15

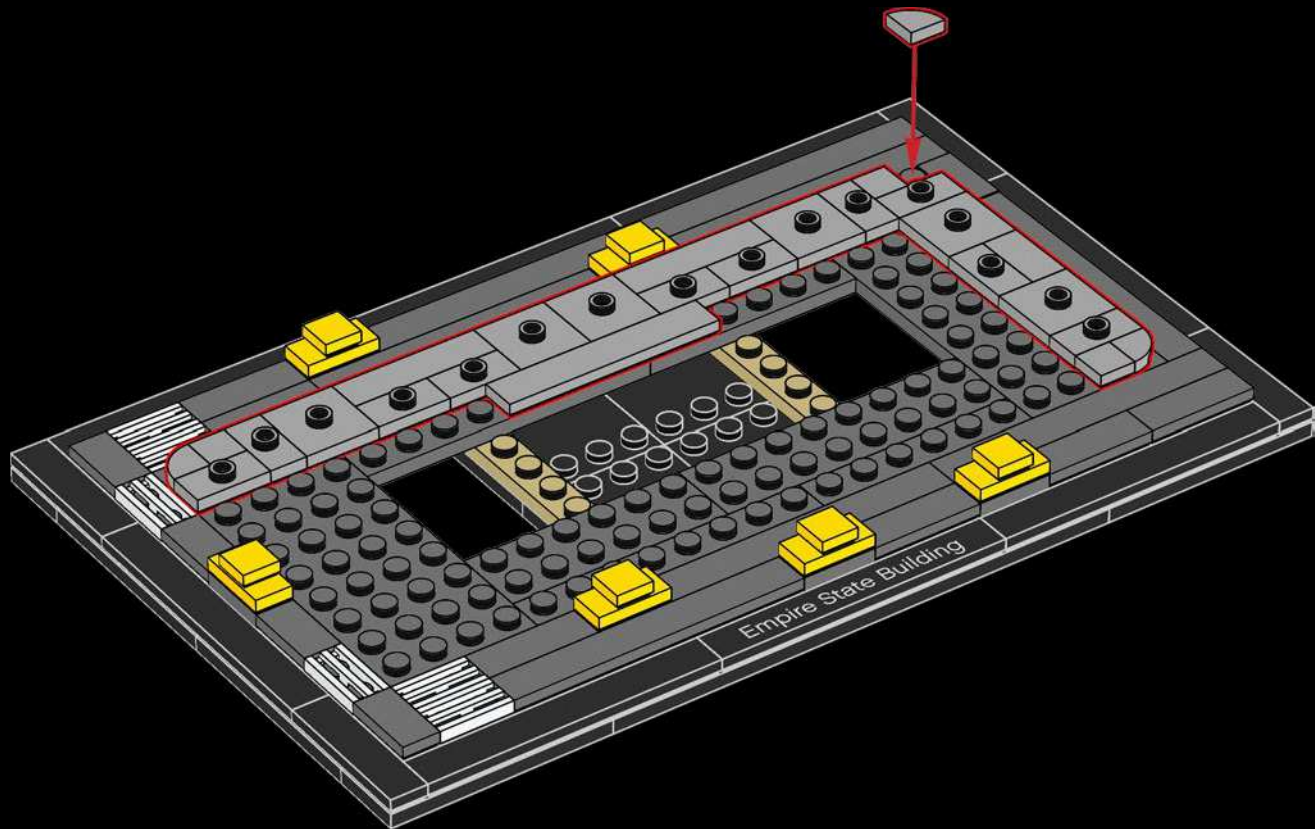

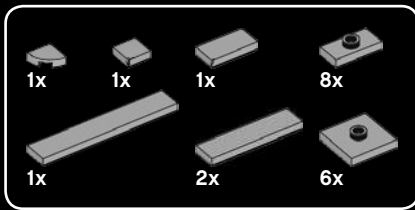

16

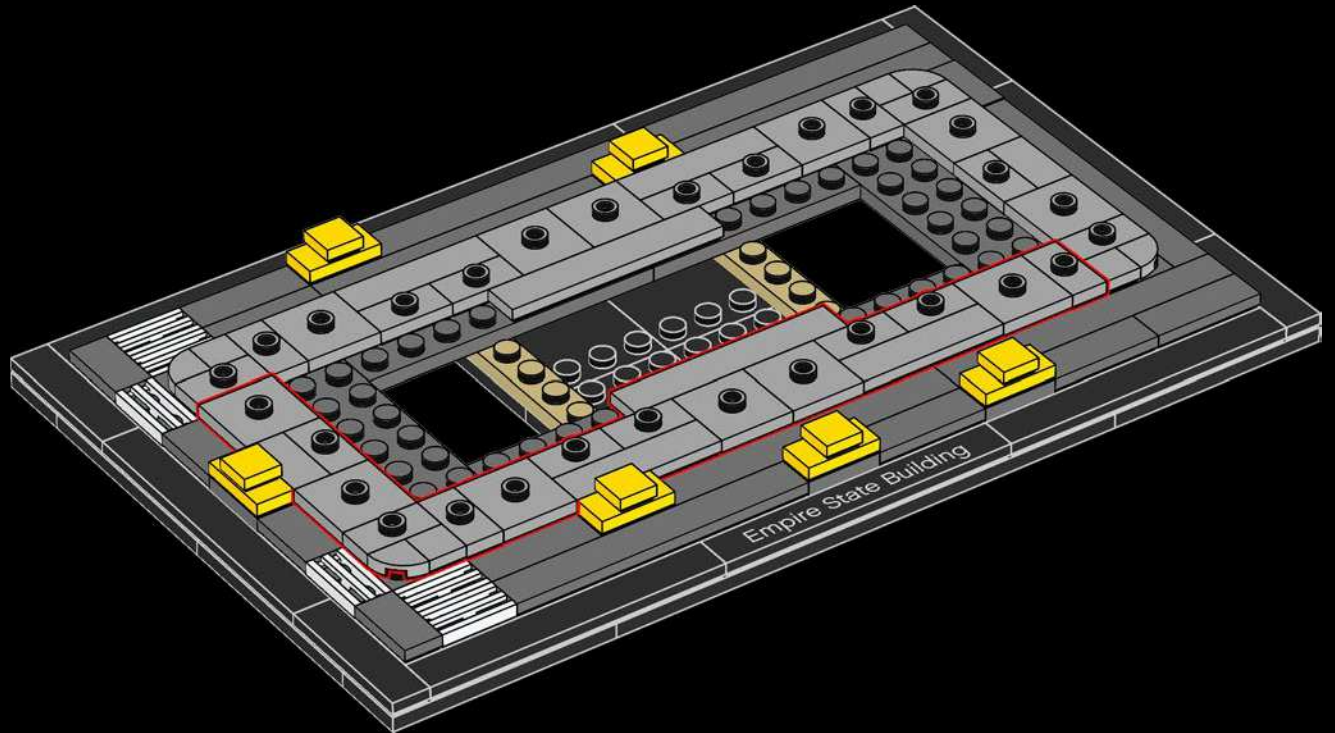



17

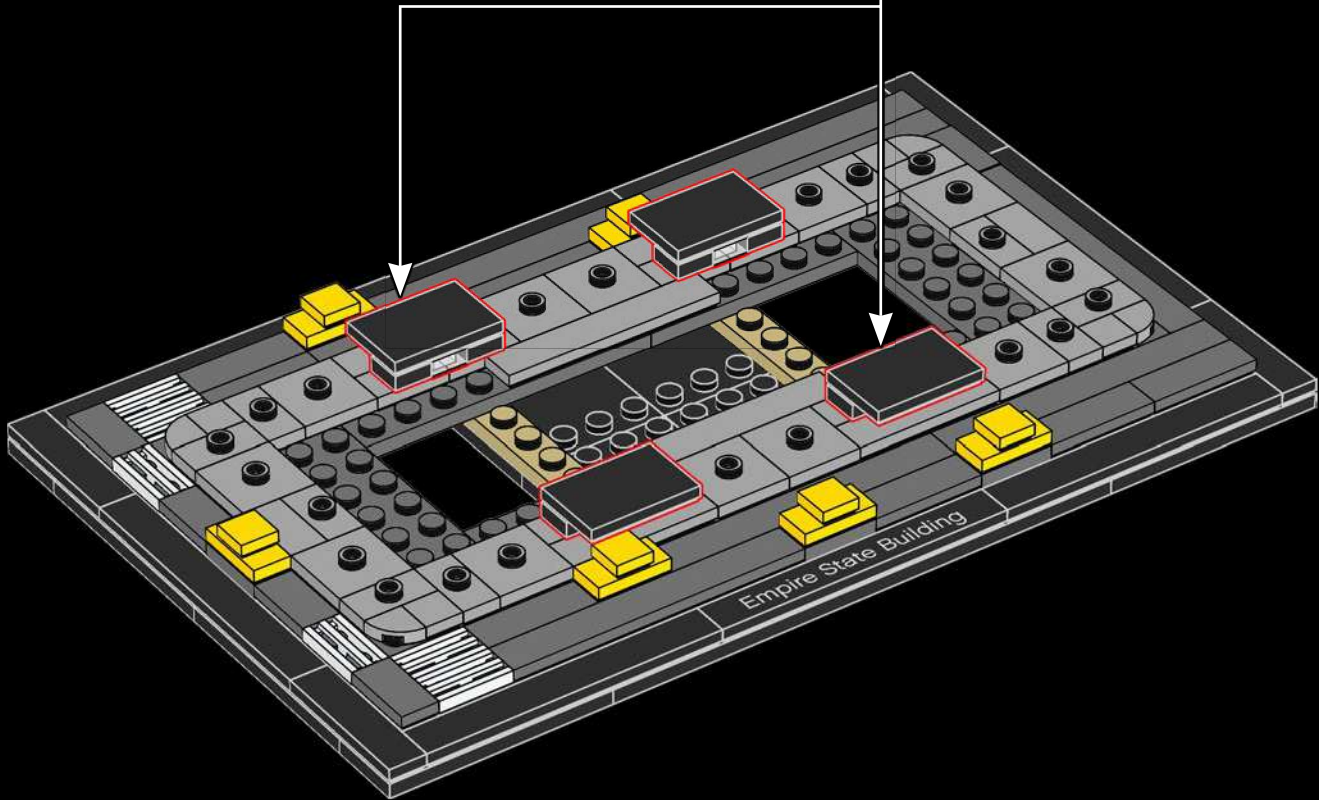
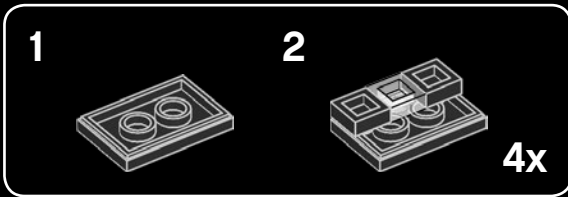

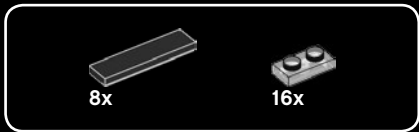

18

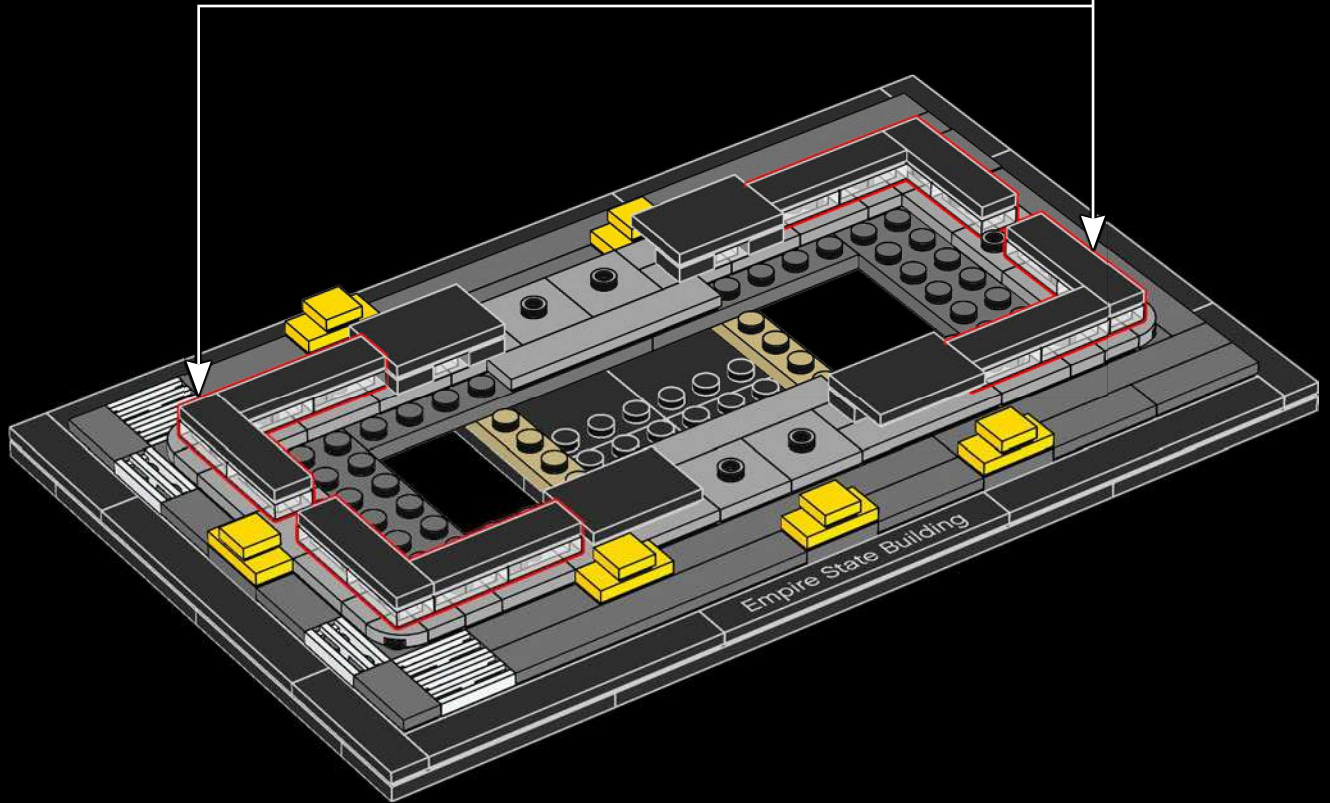
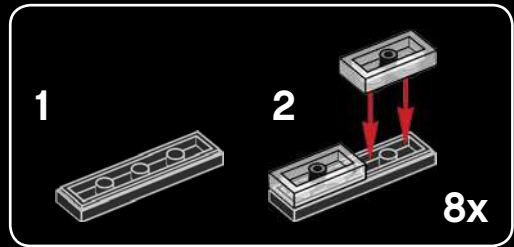



2x



2x

Running parallel to 33rd and 34th Streets, the chapel-like, three-story-high lobby has storefronts on its north and south sides.



19



2x

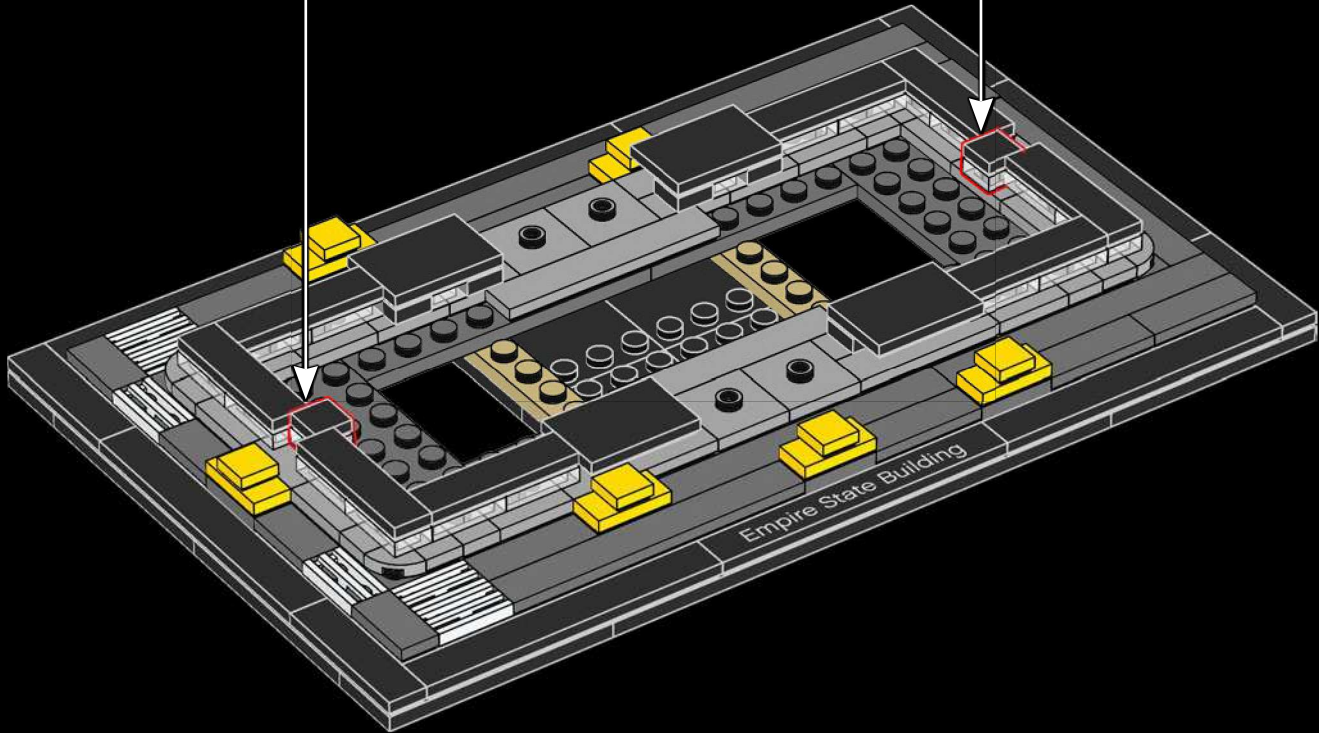

Empire State Building



20

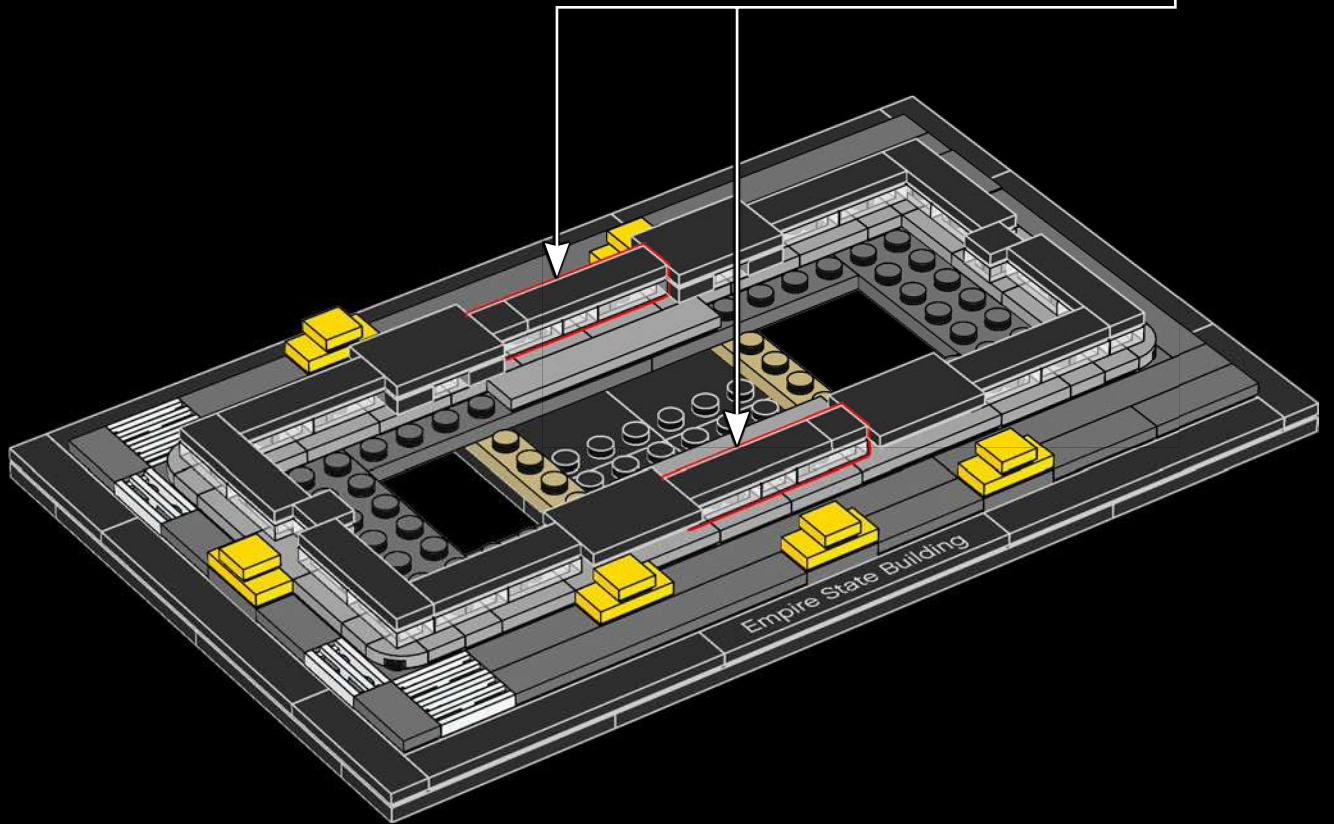
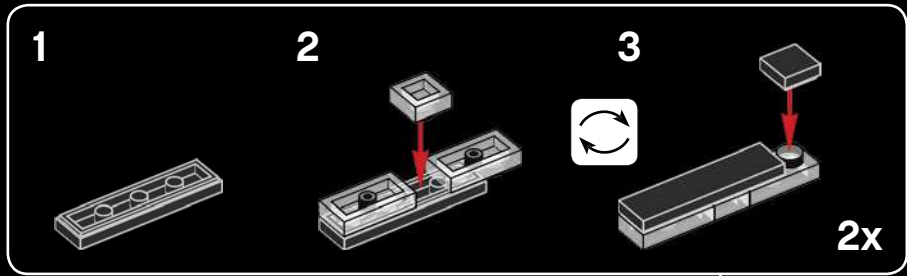

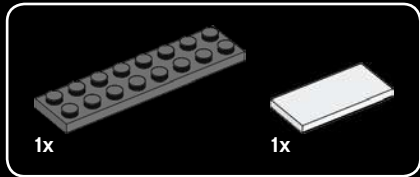

21

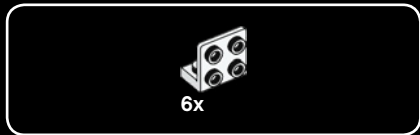
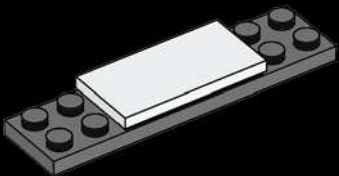

22

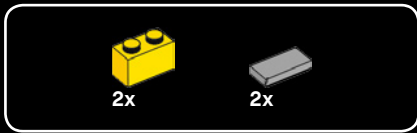
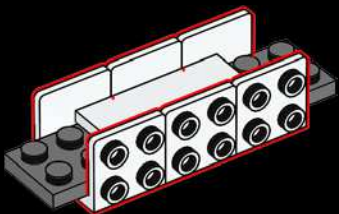

23

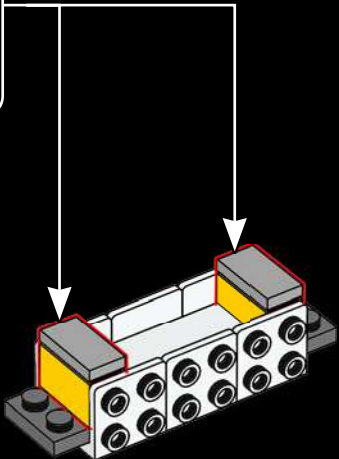
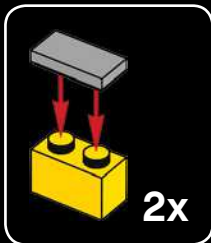



2x



6x

24

1



2

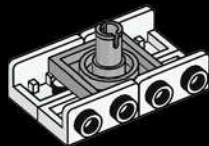

3

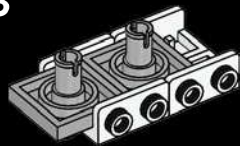

4

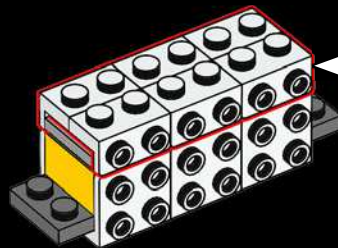
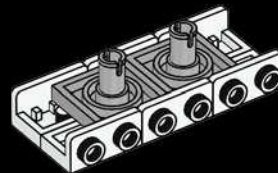

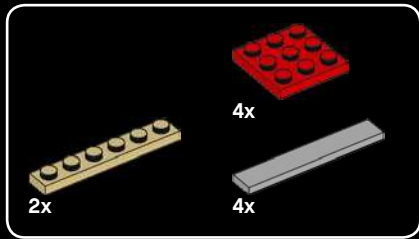

25

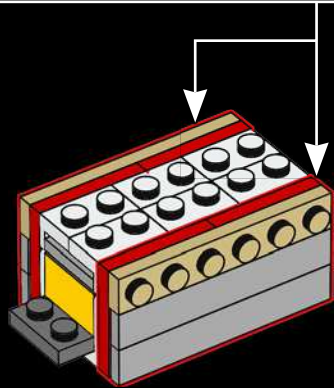
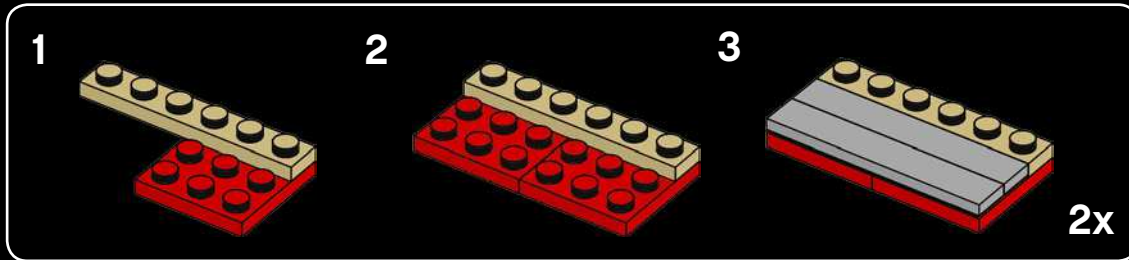

The Empire State Building has 68 modernized, high-speed elevators that transport passengers to their destinations up to 20-40% faster than conventional elevators in other modern commercial buildings. Using regenerated energy, as one elevator descends, the energy created powers the ascending elevators.



26

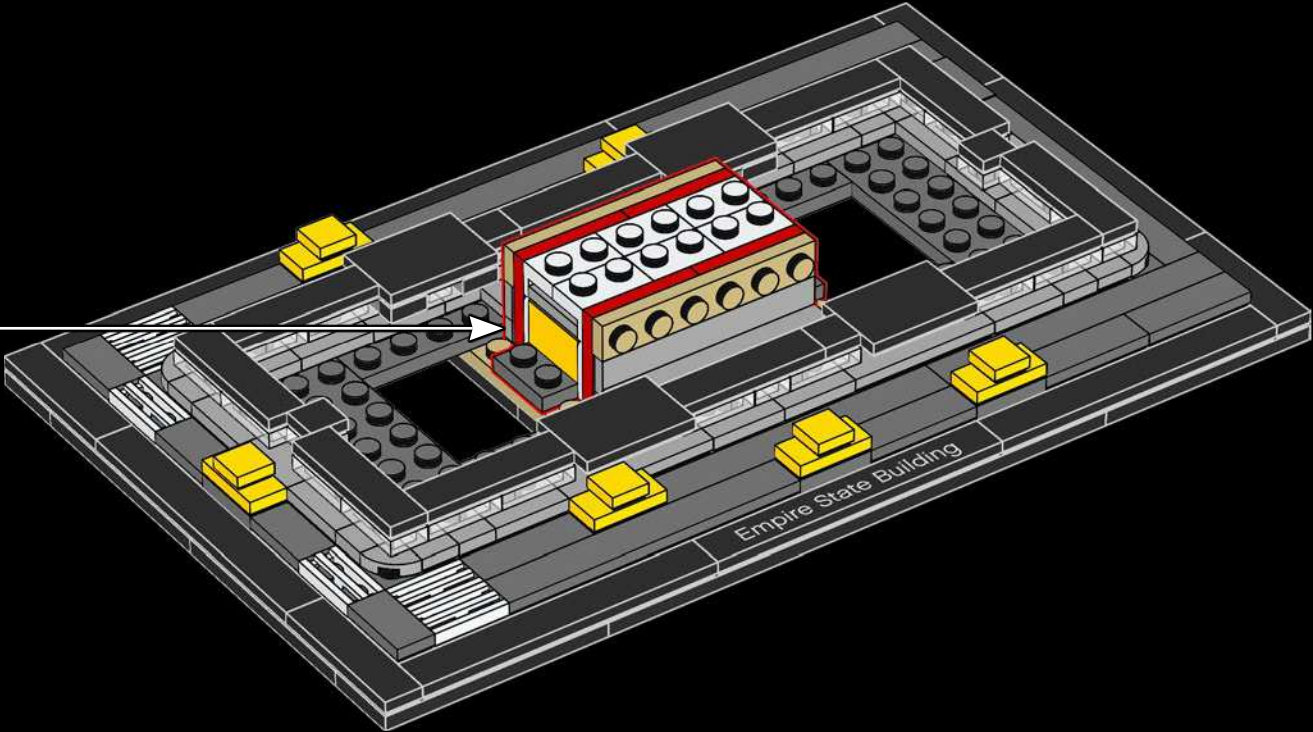

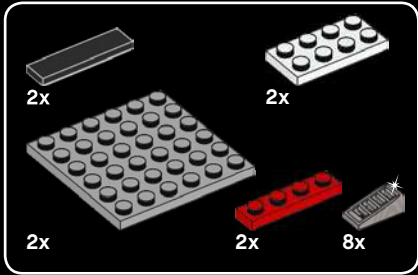

27

1

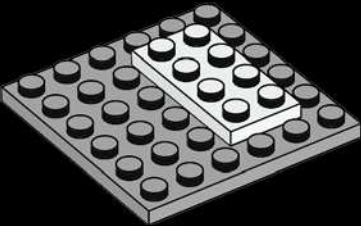

2

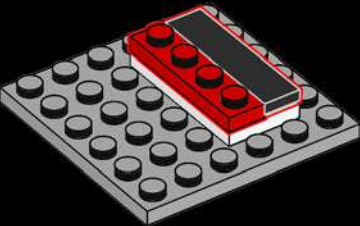

3

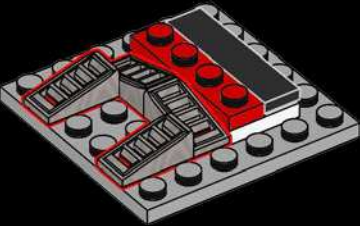

2x

There are eight high-speed escalators in the building's
concourse and second floor areas.

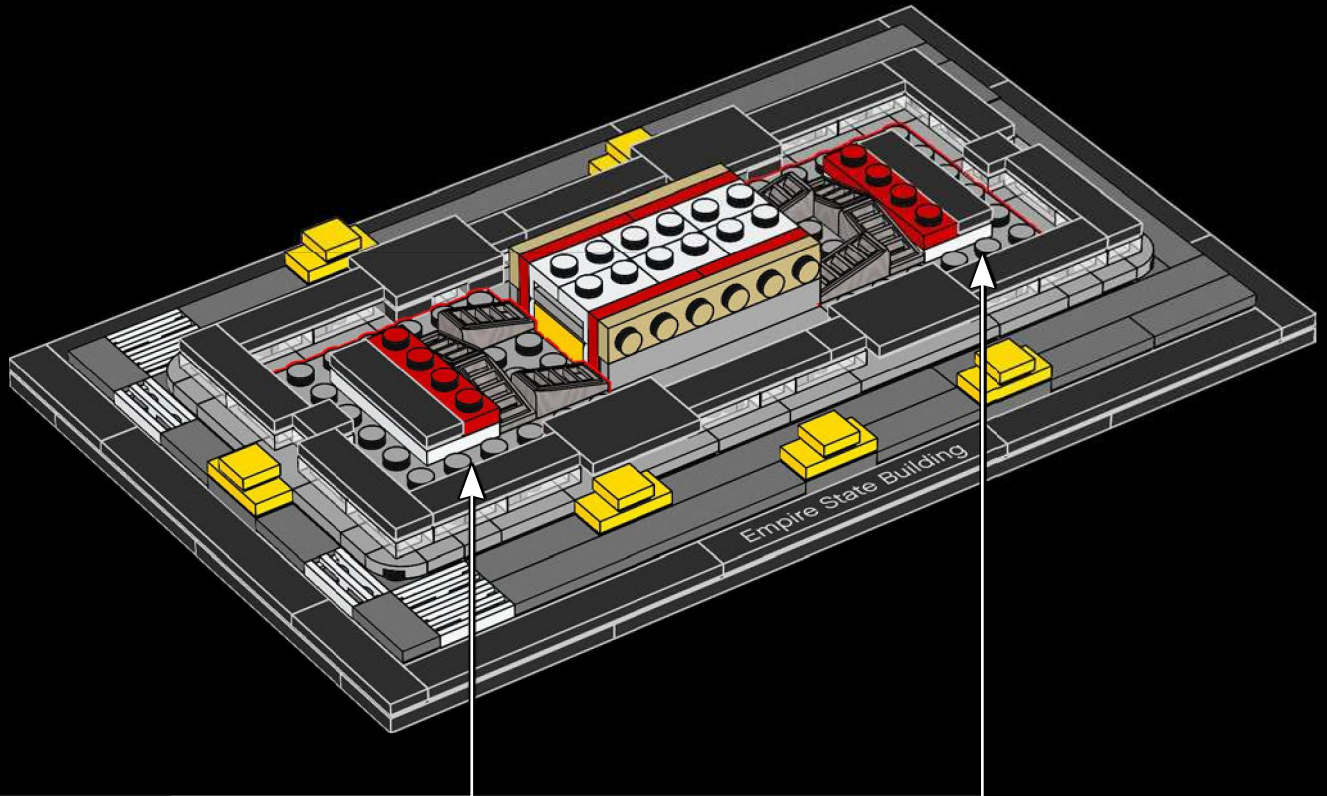

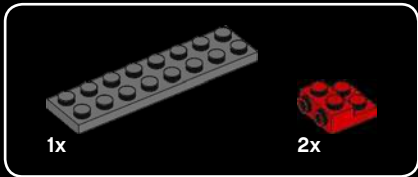

28

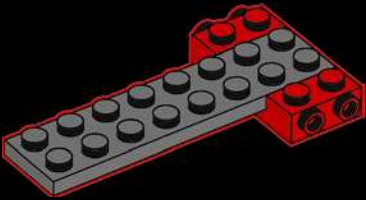

29

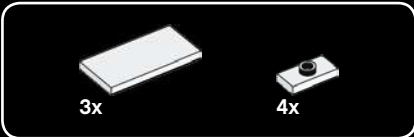
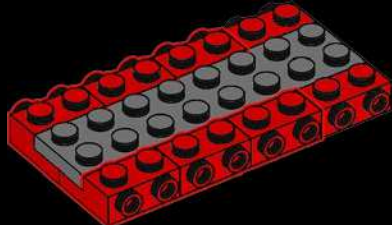

30

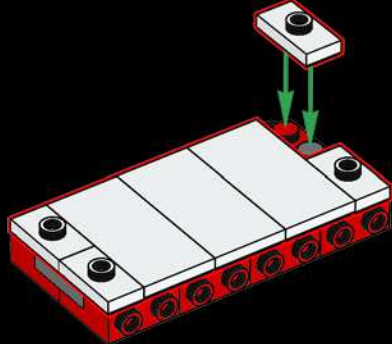

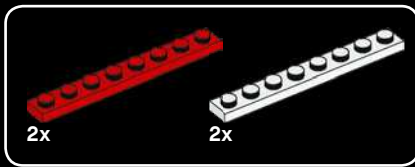

31

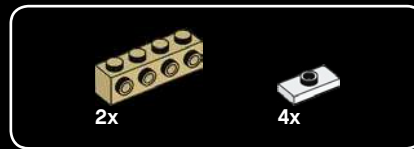
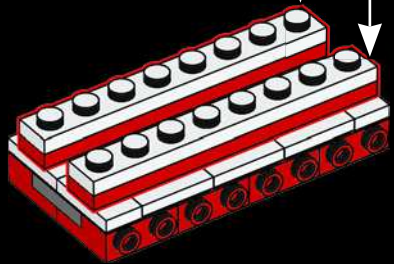
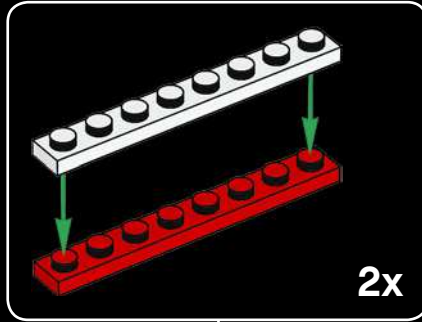

32

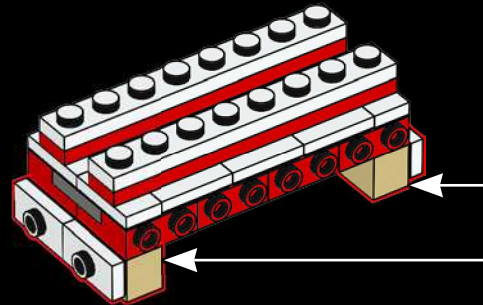
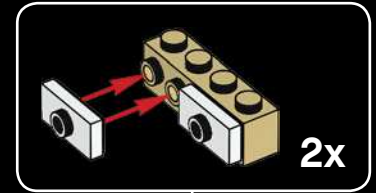

33

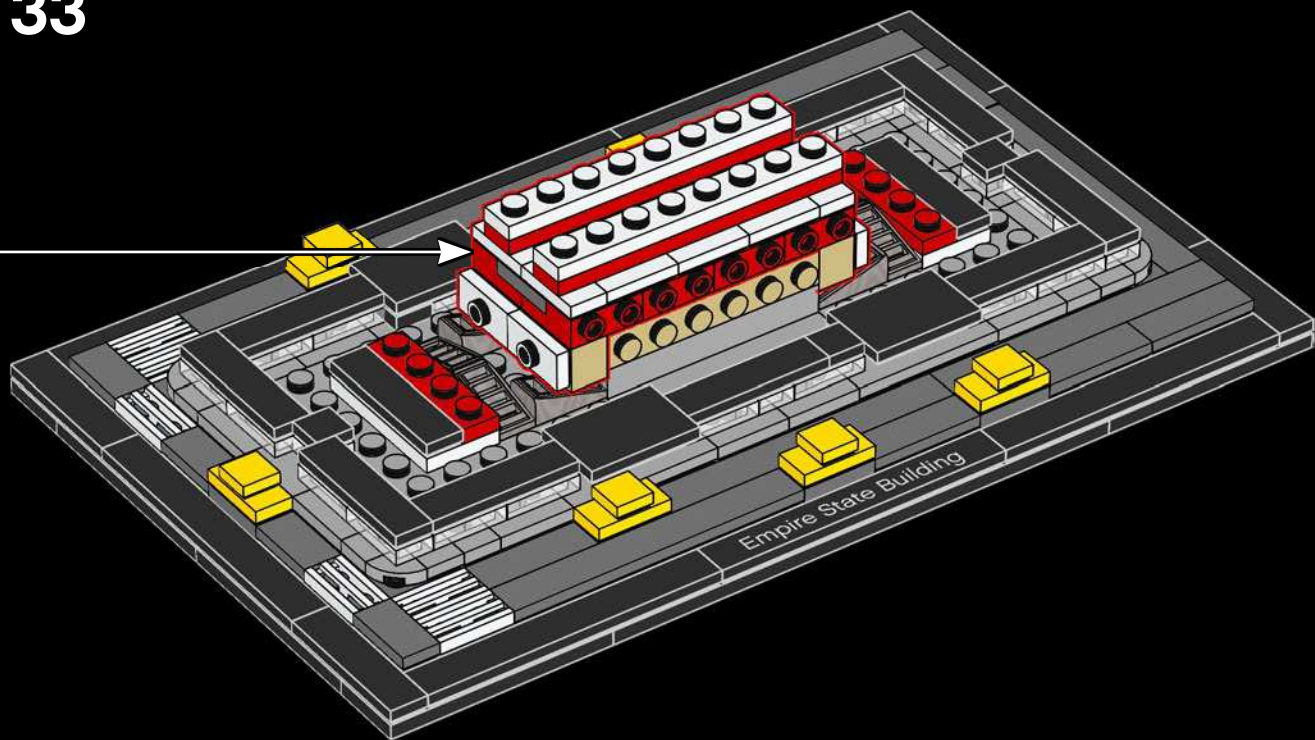

2

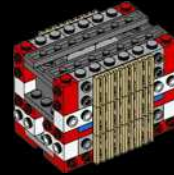
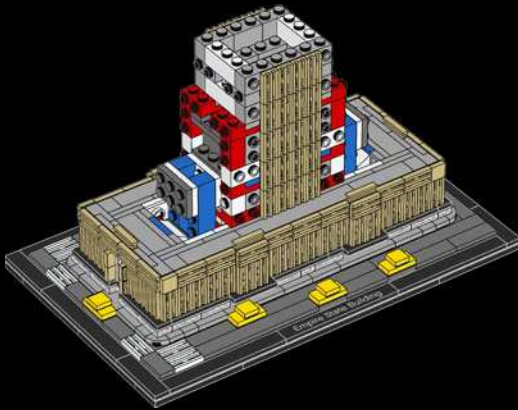

1x



2x

34



2x

35

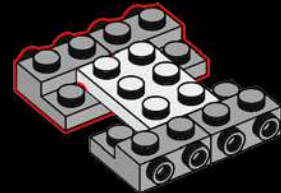



2x

36

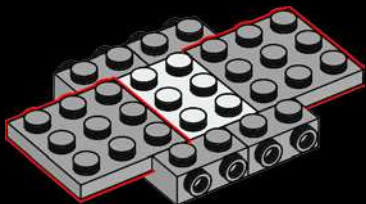

4x

37

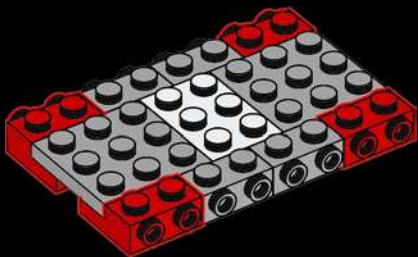

6x



4x

38

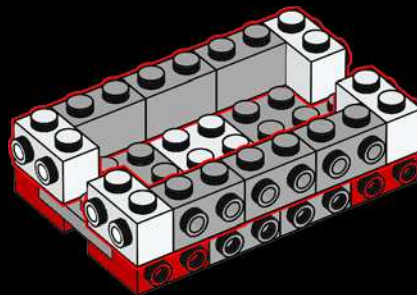

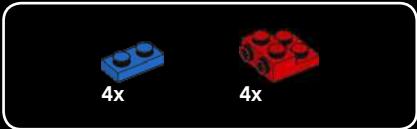

39

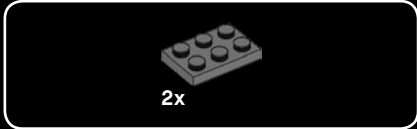
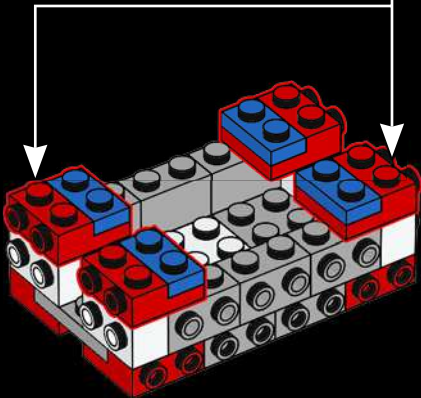
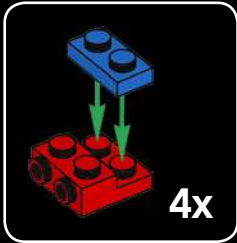

40

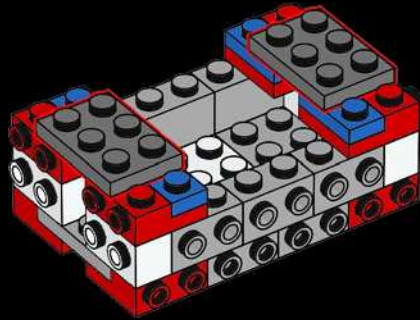



4x

41

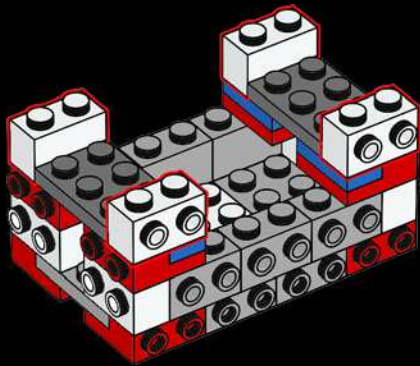

4x

42

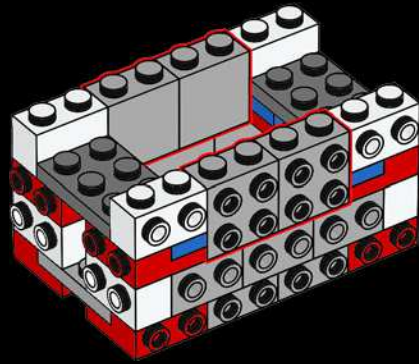

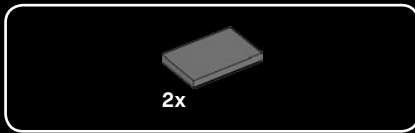

43

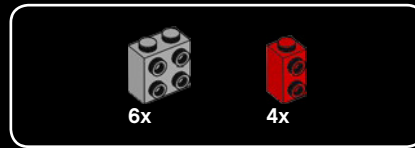
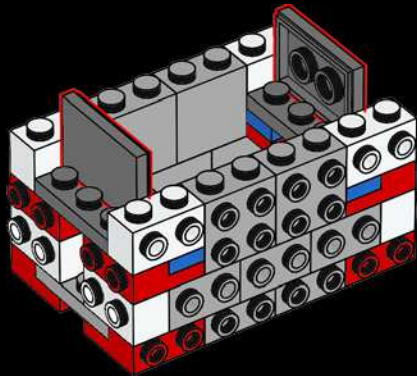

44

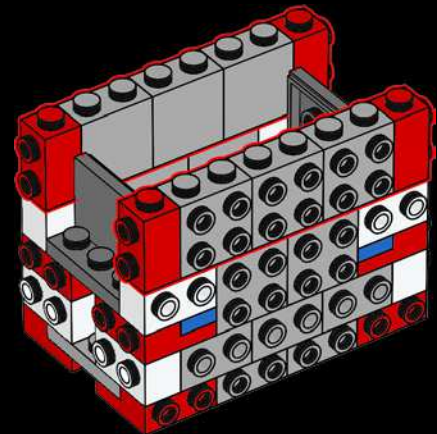

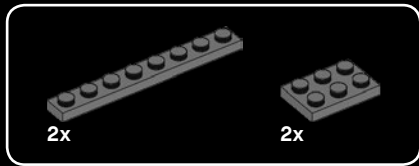

45

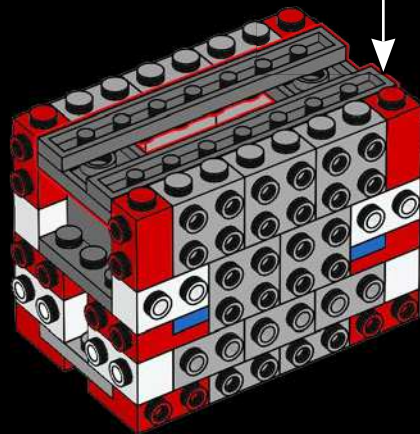
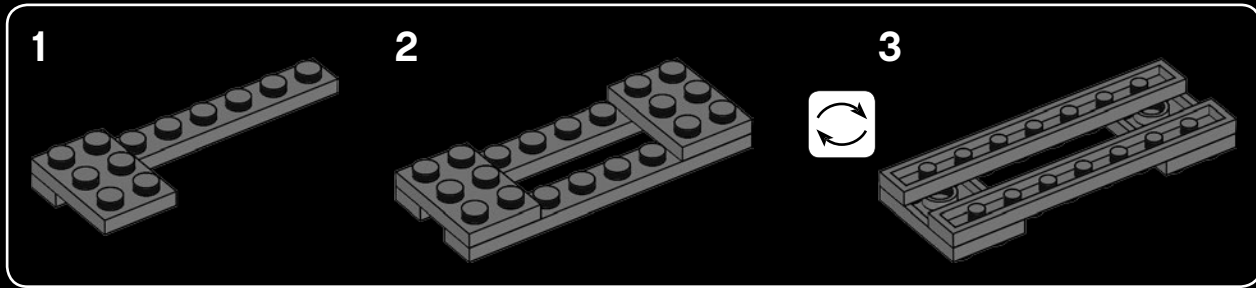



46

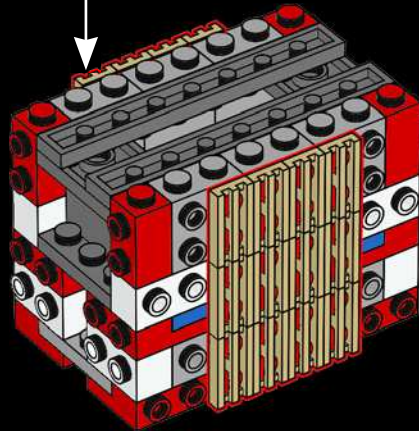

47

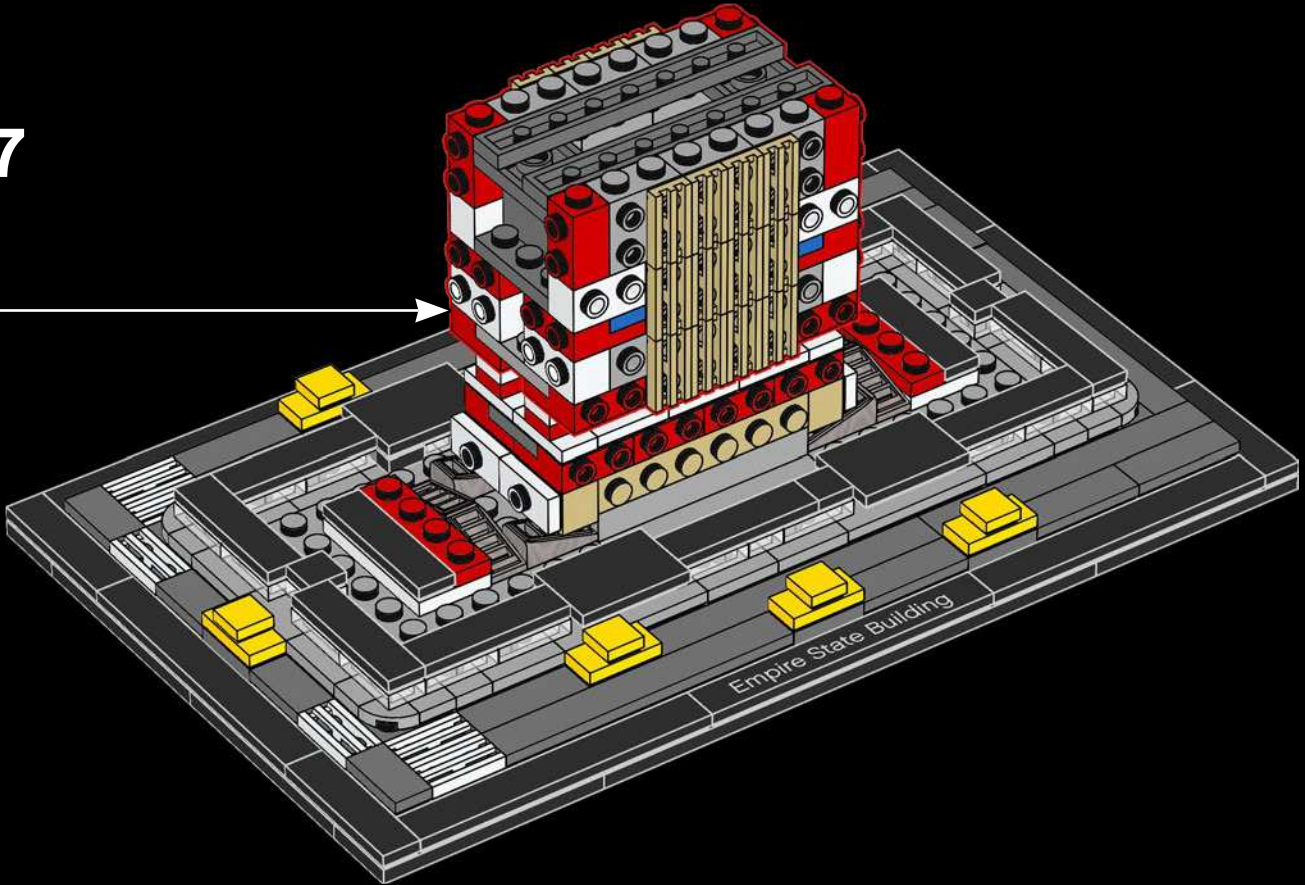

48

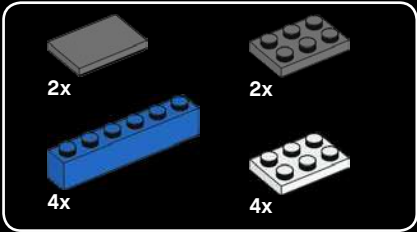

48

1

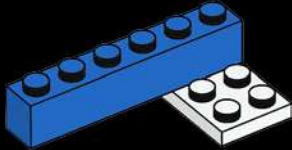

2

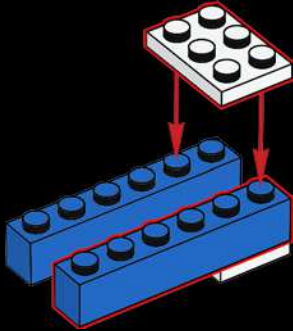

3

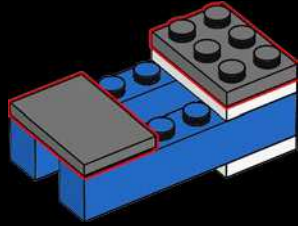

2x

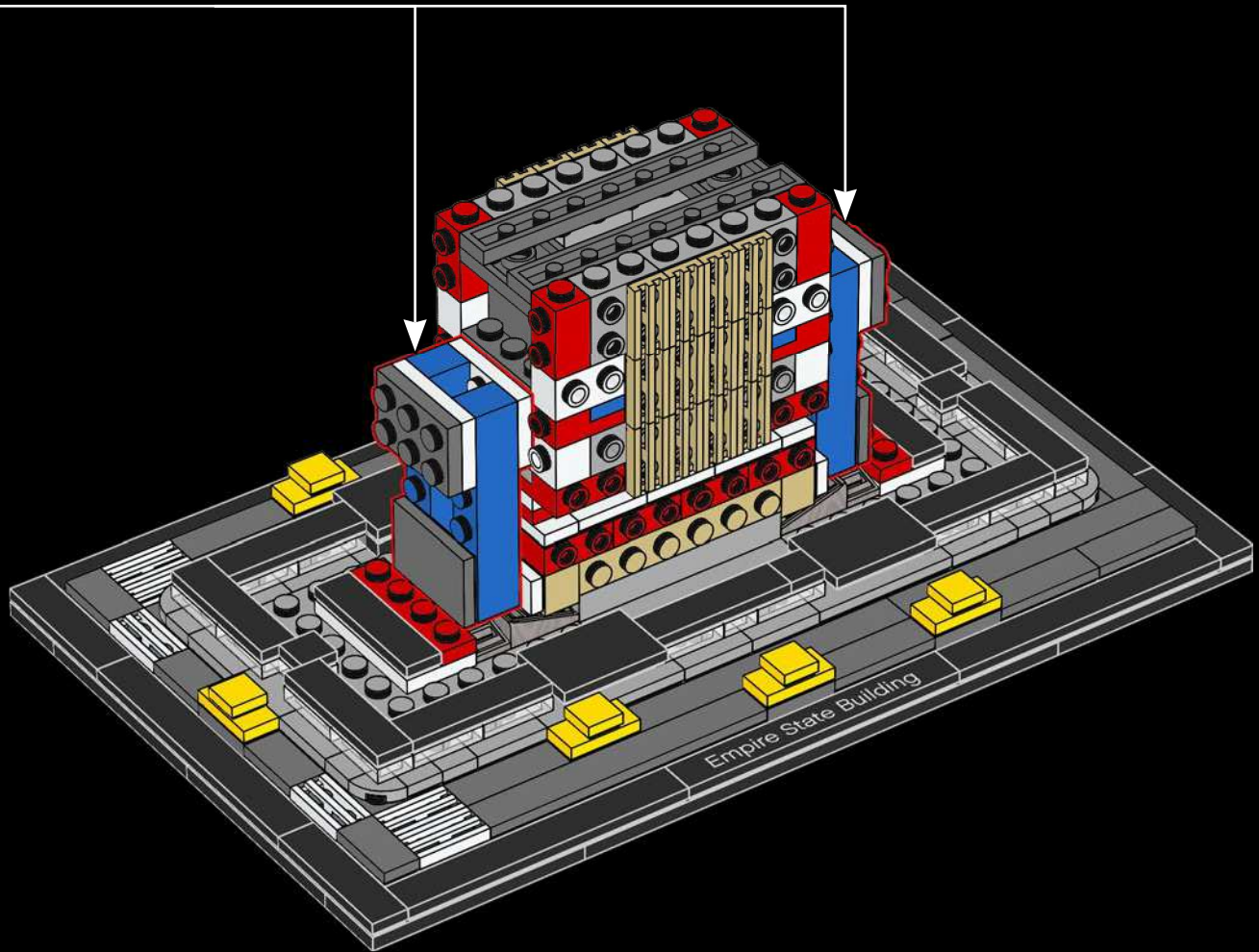

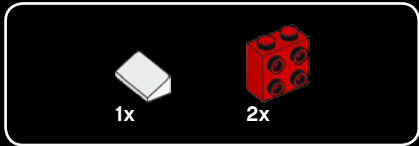
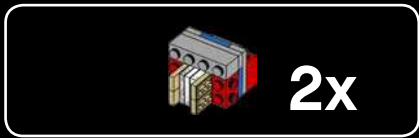

49

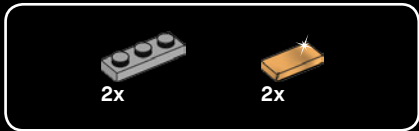
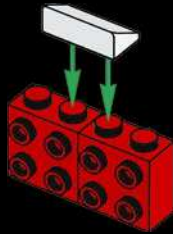

50

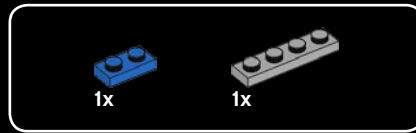
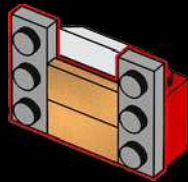

51

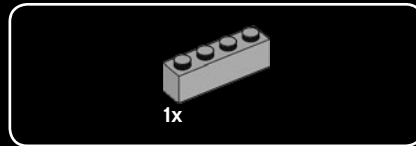
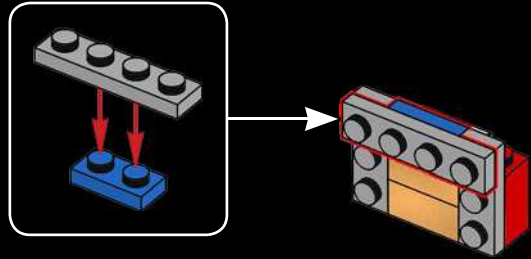

52

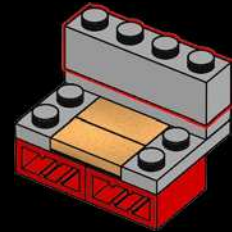
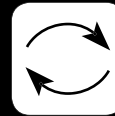

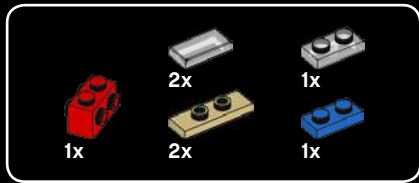

53

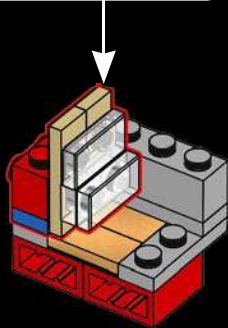
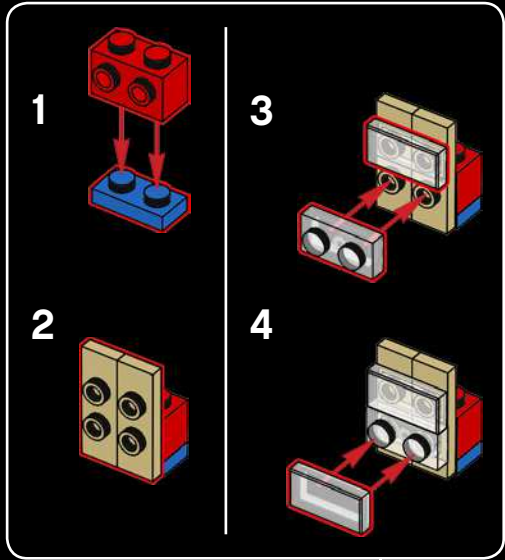

54

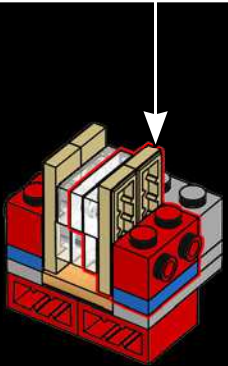
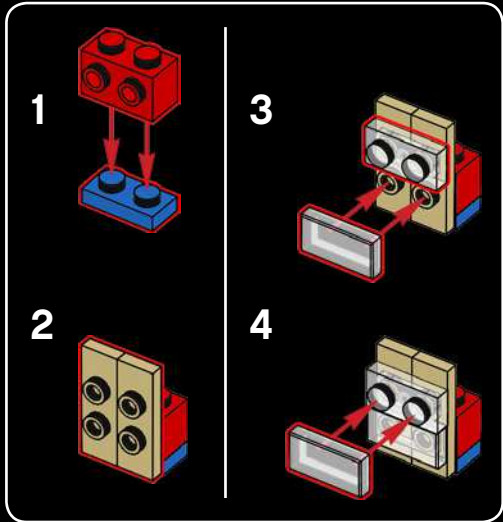

2x

The Famous Art Deco lobby includes an aluminum relief of the building. On the wall above the front desk in the Fifth Avenue lobby is one of the most famous images in New York City, a depiction of the building itself with beams of lights radiating from the mast.

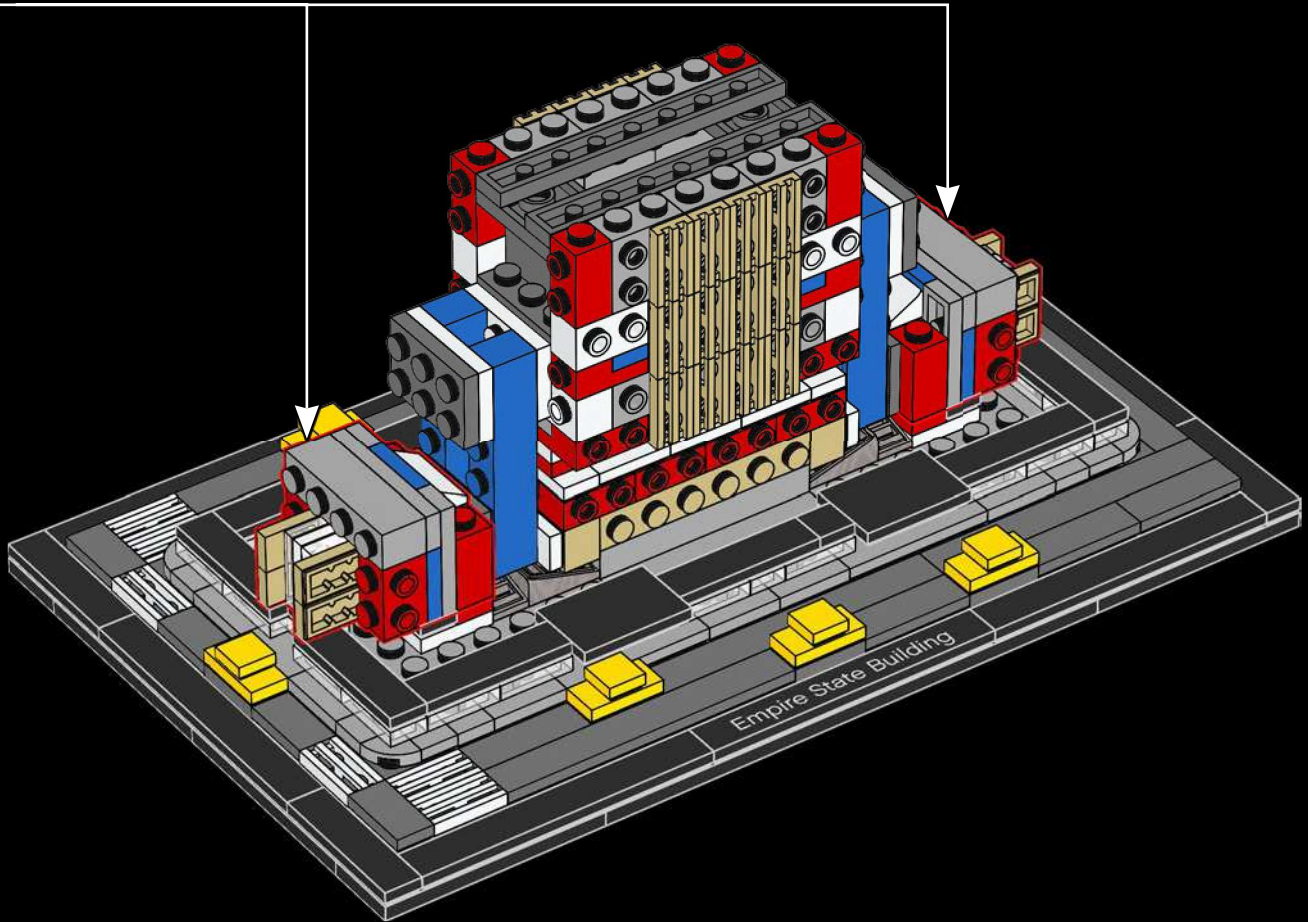

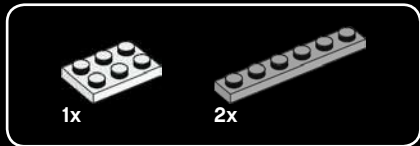
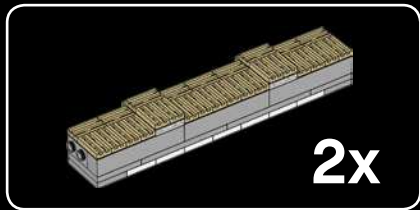

56

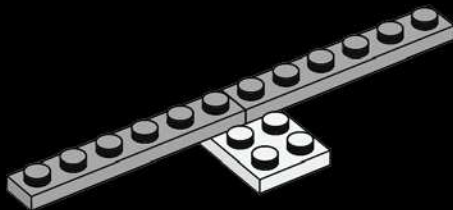

57

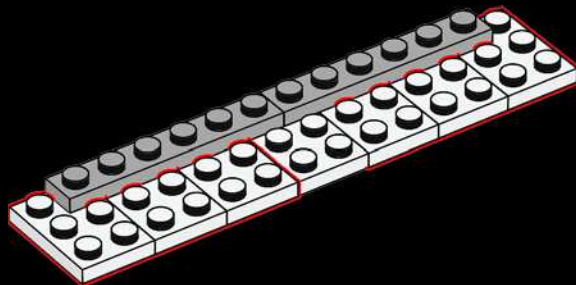

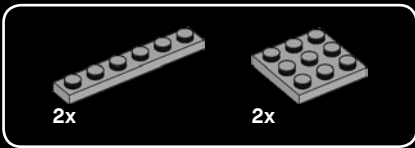

58

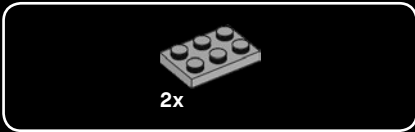
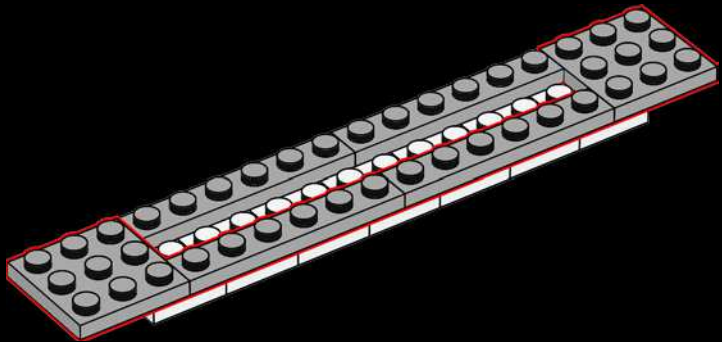

59

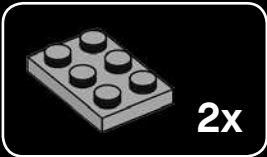
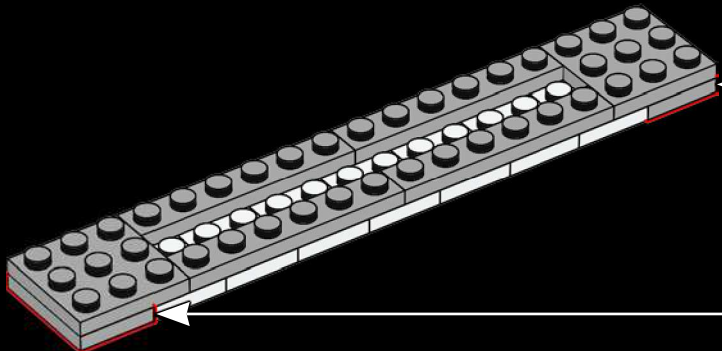

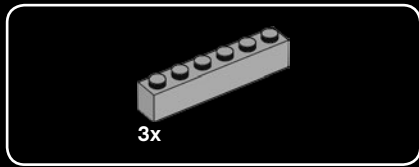

60

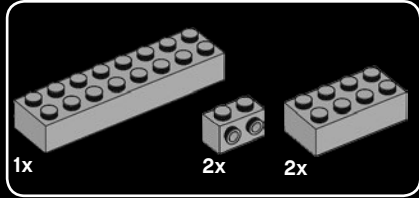
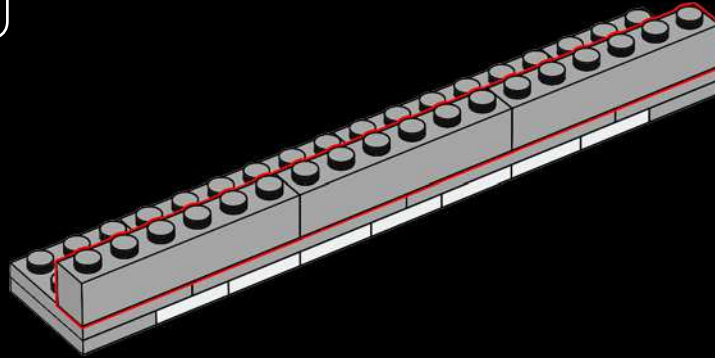

61

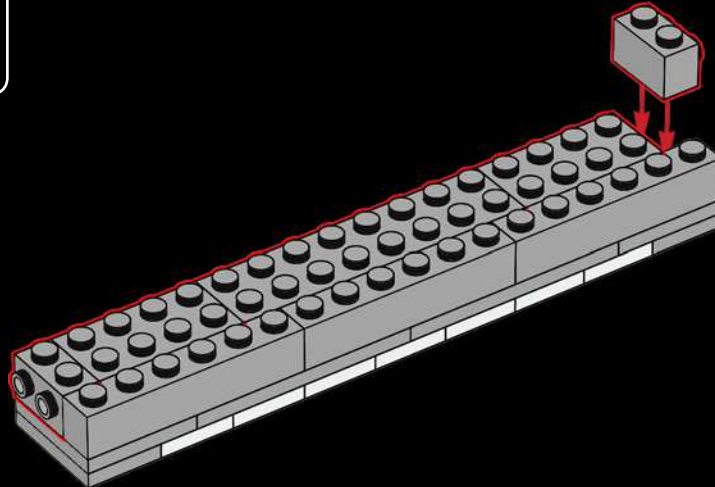

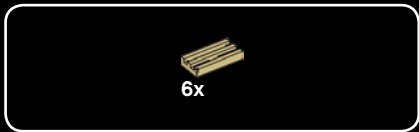

62

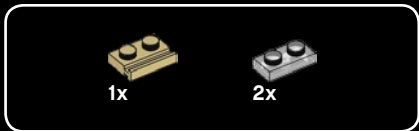
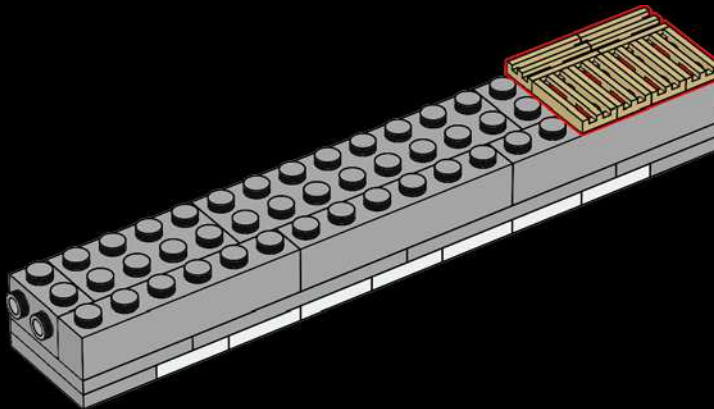

63

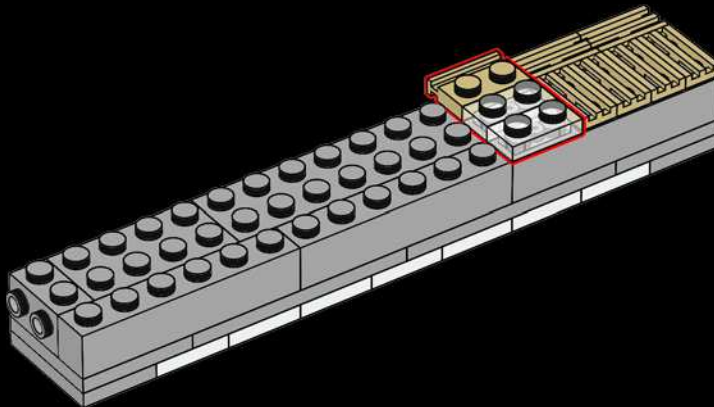



9x

64

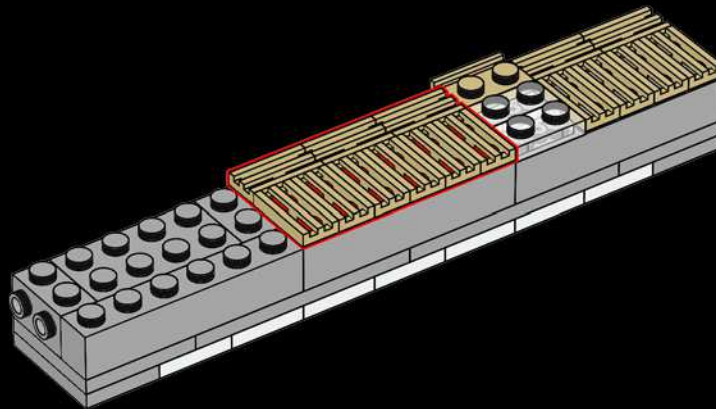

1x



2x

65

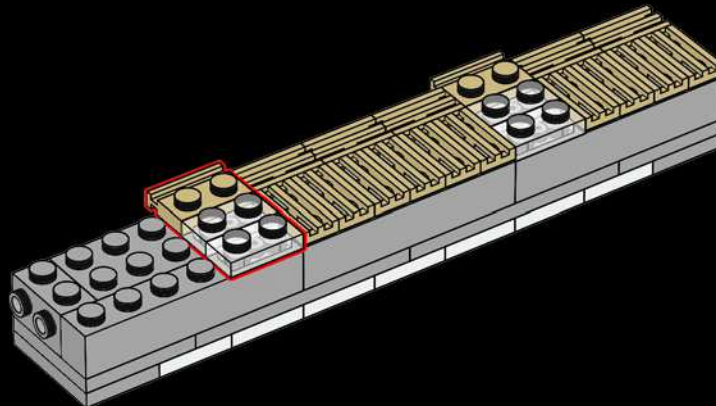



66

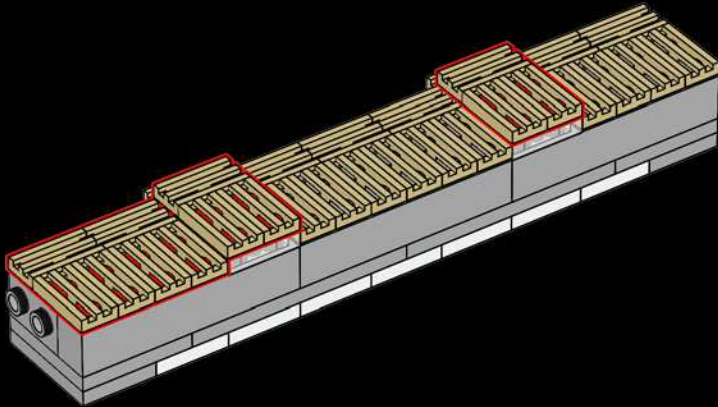

2x

67

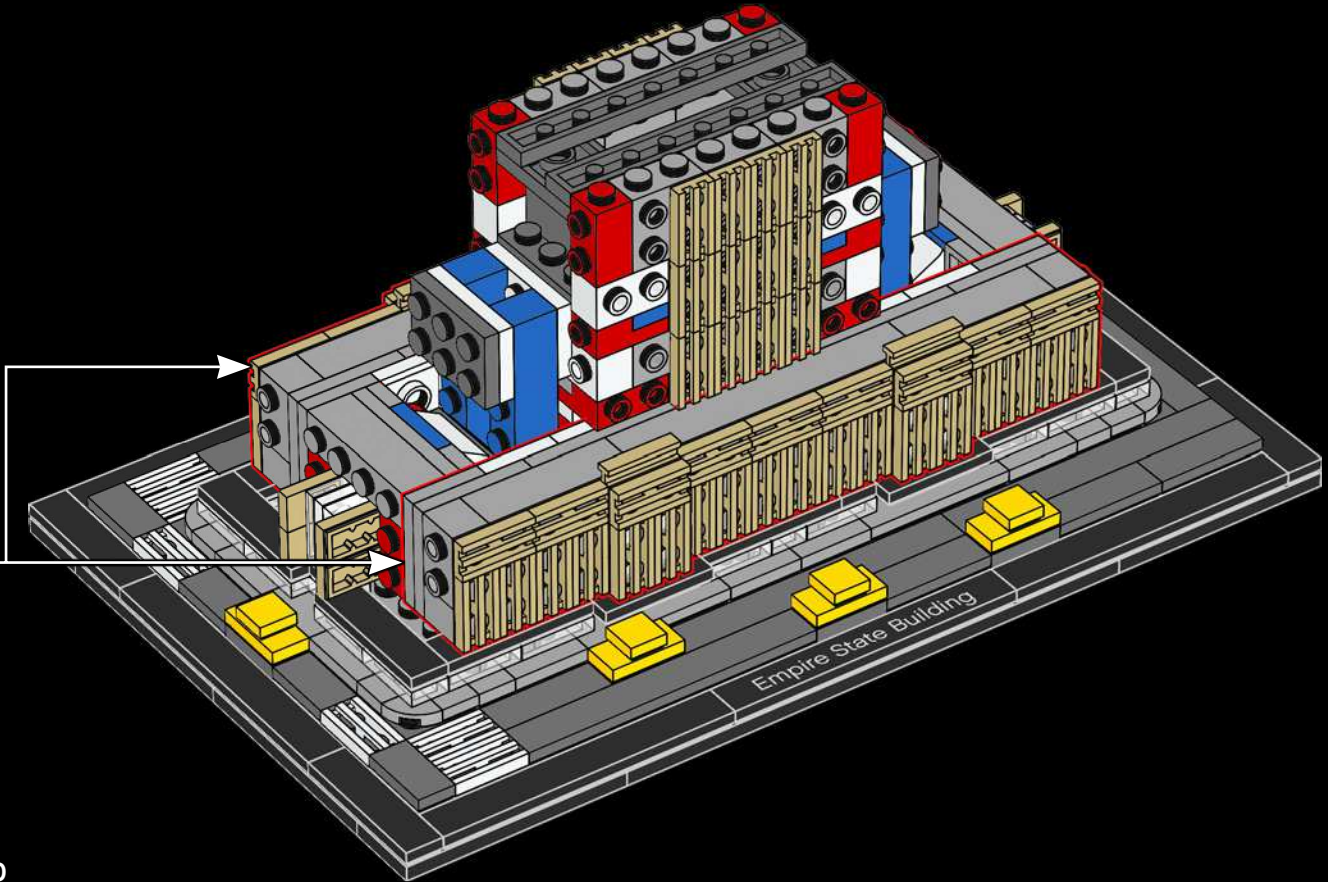

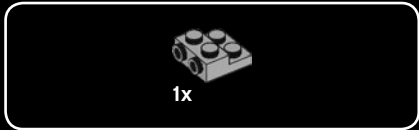
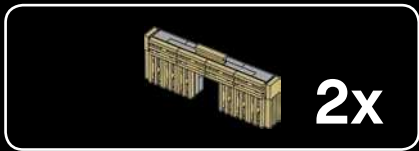

68

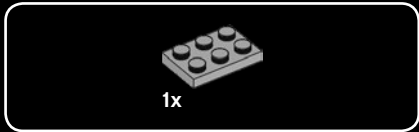

69

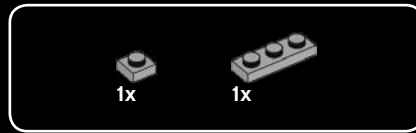

70

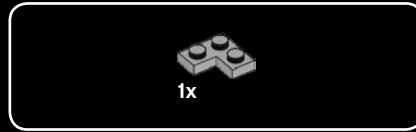
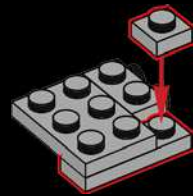

71

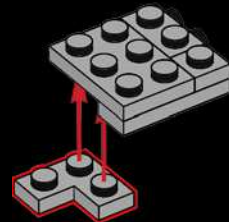



1x

72

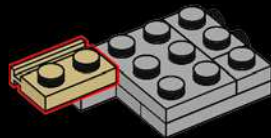

1x



1x



1x



1x



1x

73

1



2



3

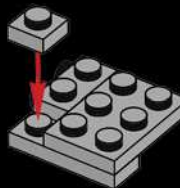

4

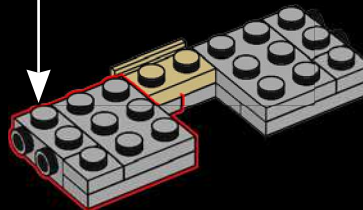
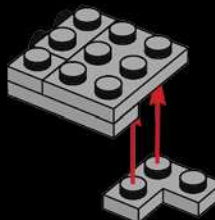



12x



2x

74

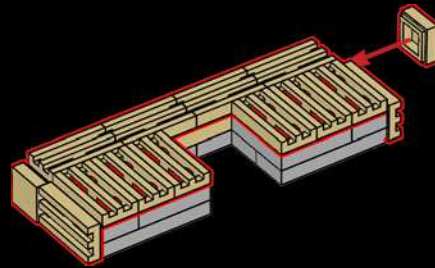

2x

75

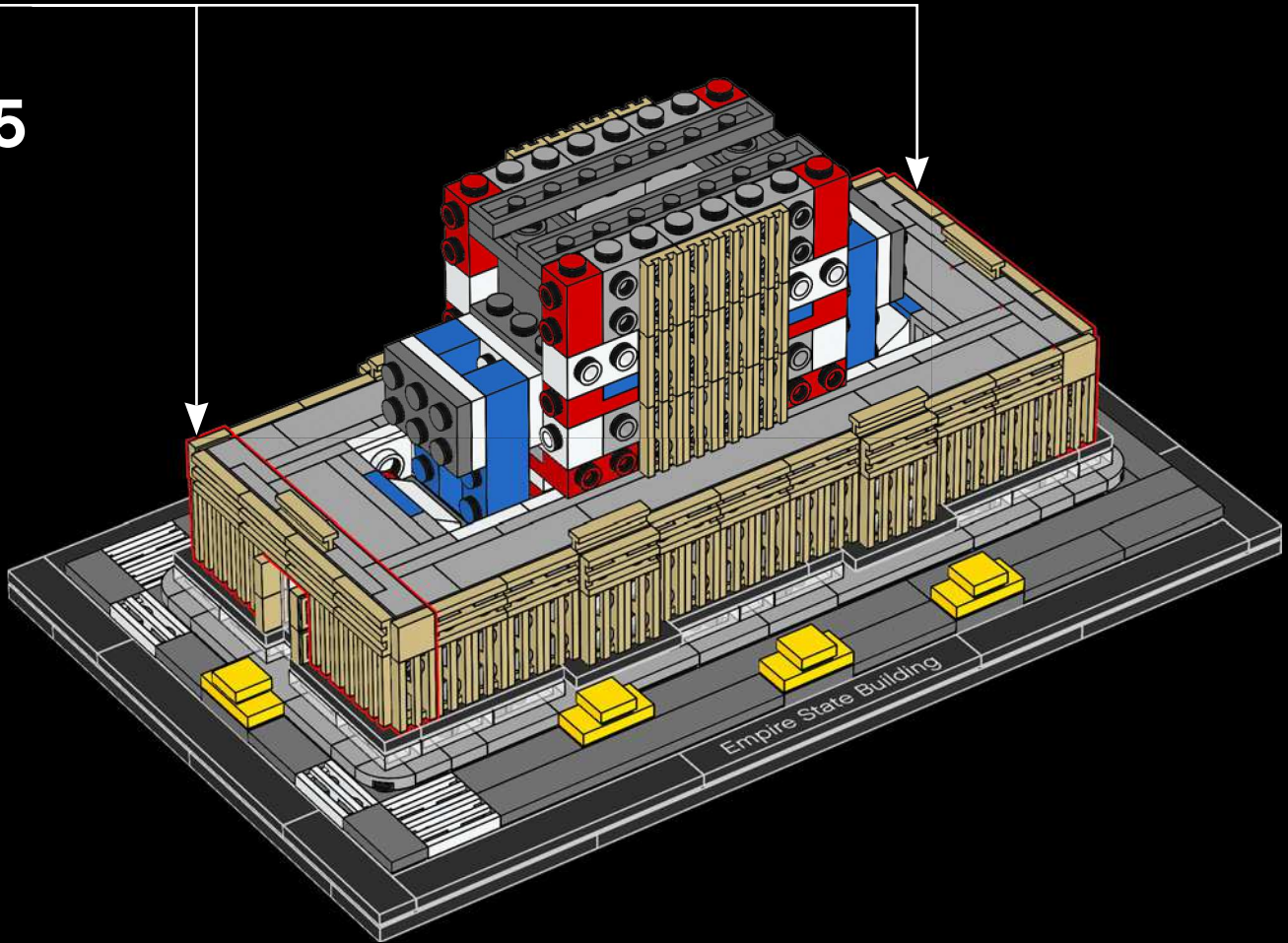

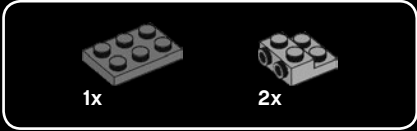
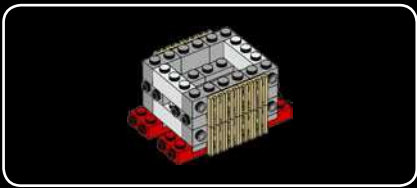

76

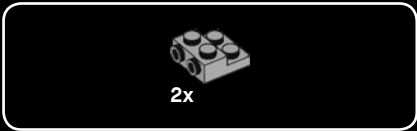
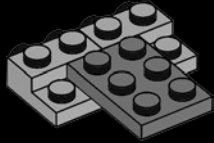

77

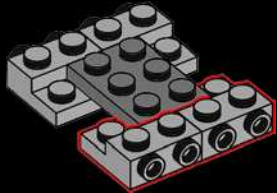

78

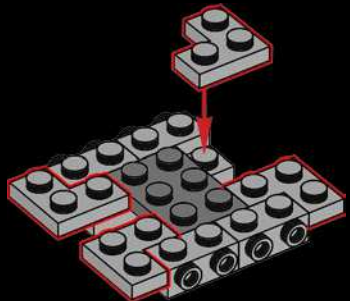

79

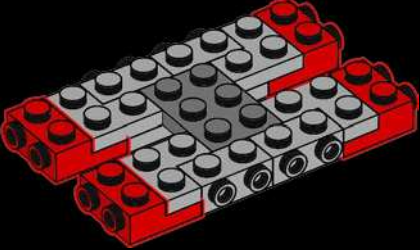

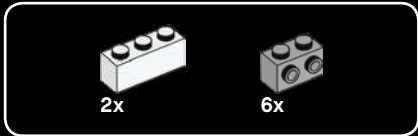

80

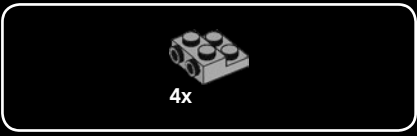
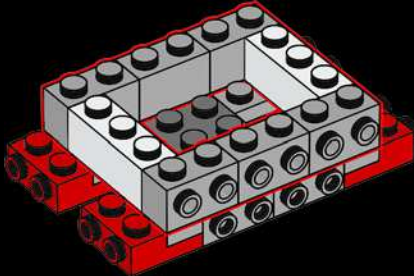

81

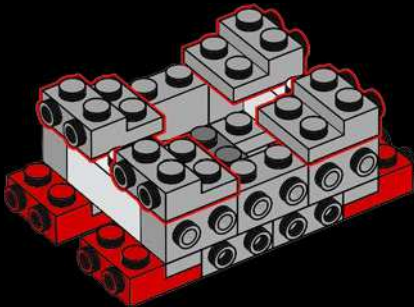



82

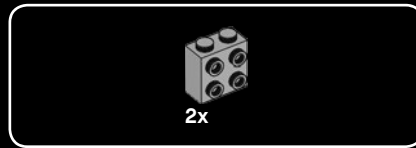
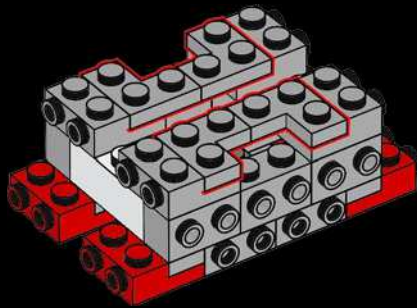

83

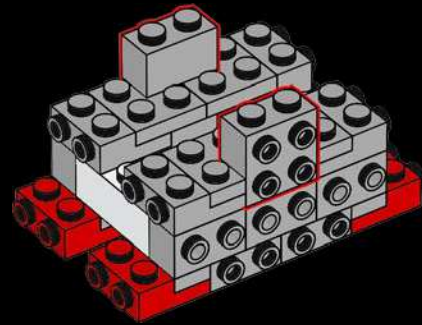

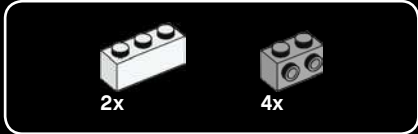

84

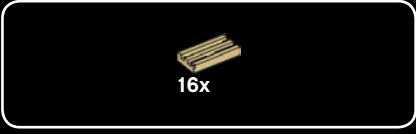
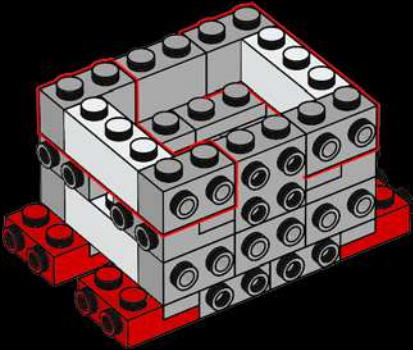

85

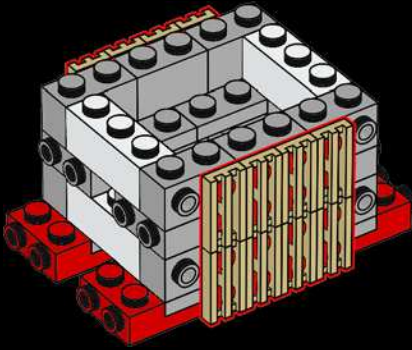

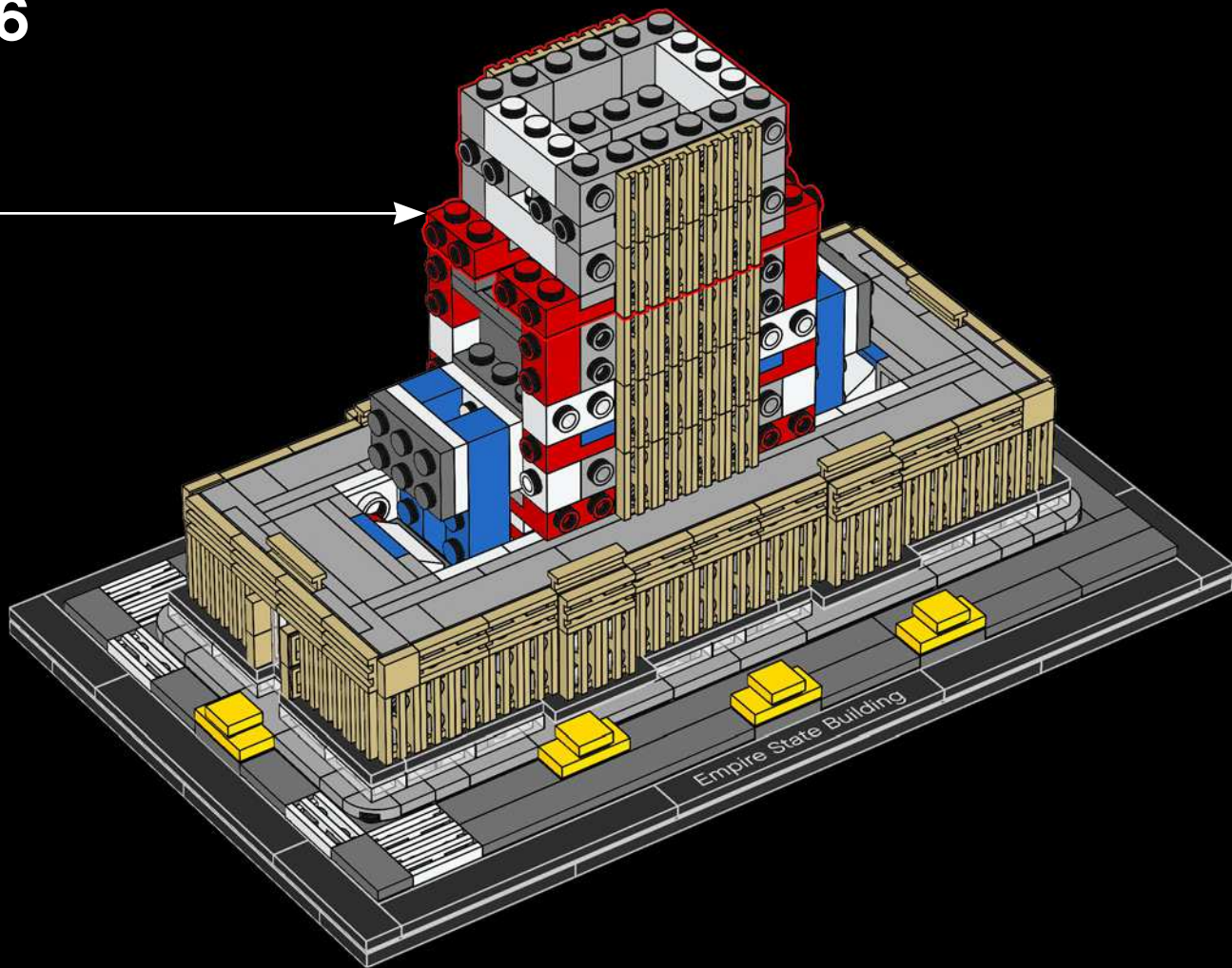

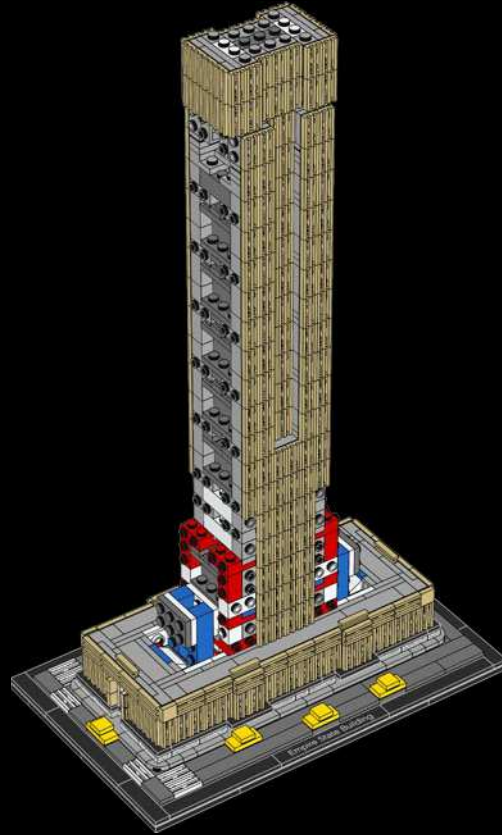

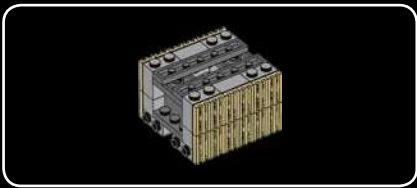

87

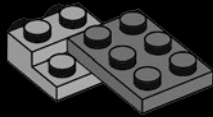

88



89

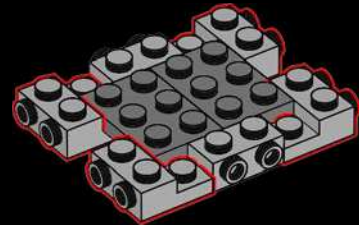

90

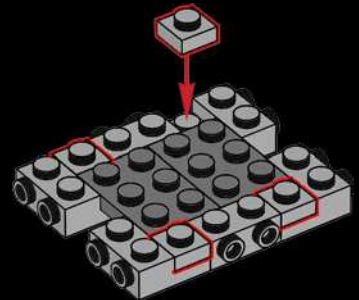



1x

91

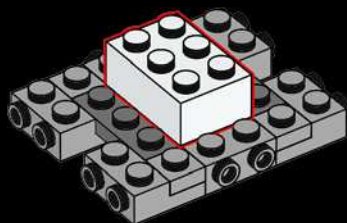

2x

92

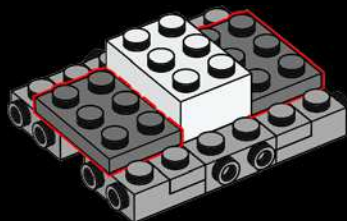

6x

93

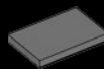
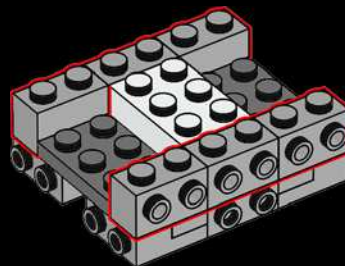

2x

94

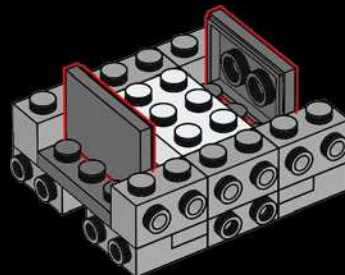

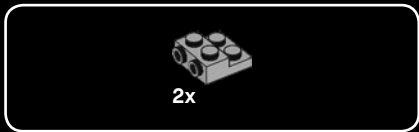

95

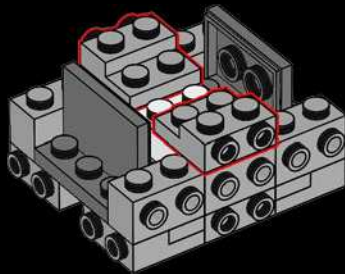

96

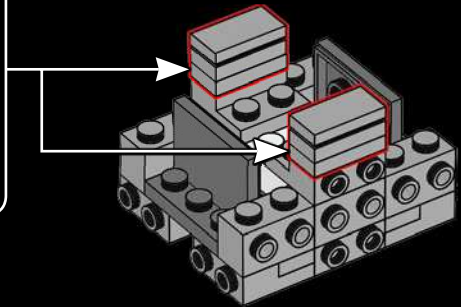
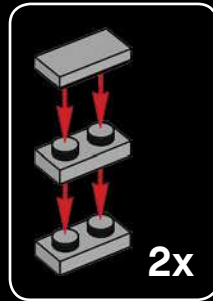



4x

97

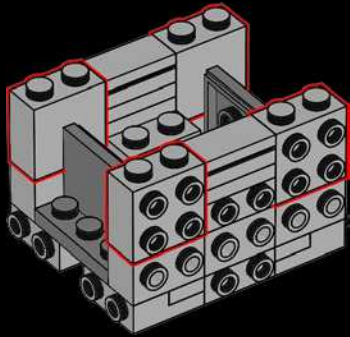

24x

98

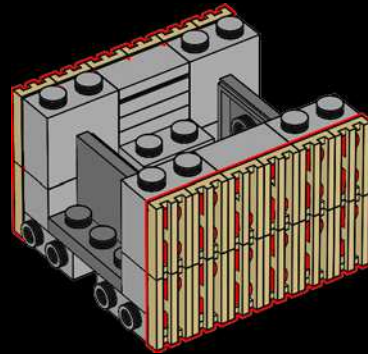

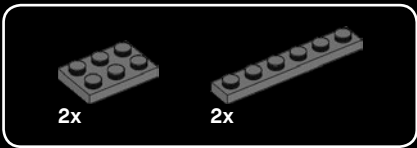

99

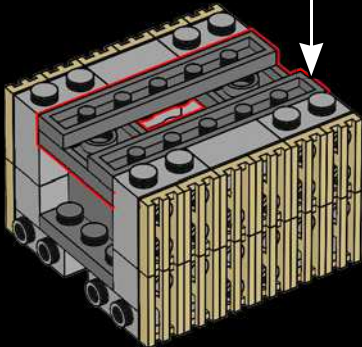
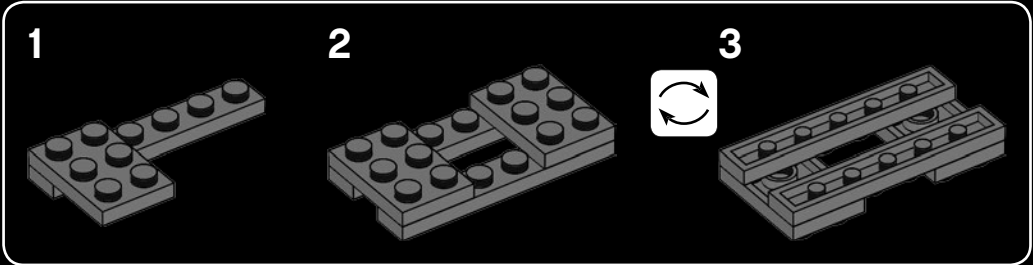

The steel frame construction of the building is made from riveted steel beams and girders.

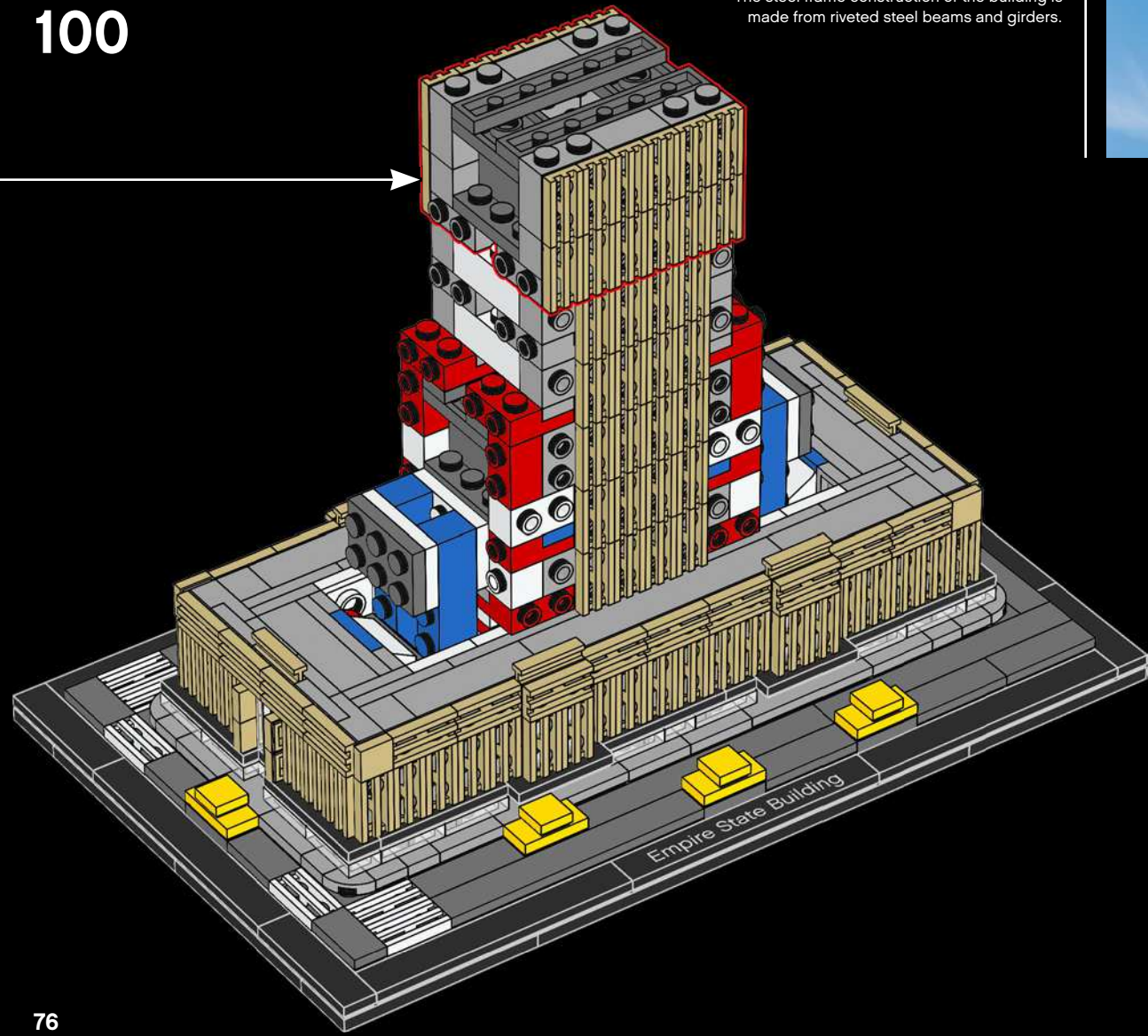

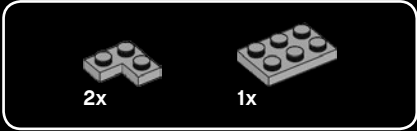
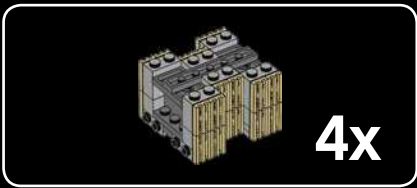

101

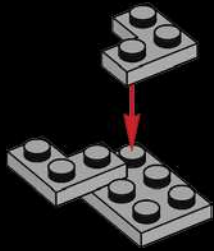

102

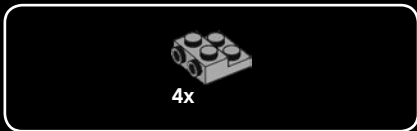
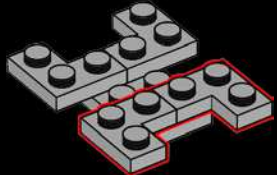

103

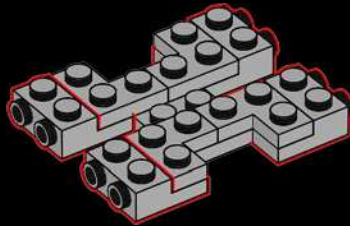

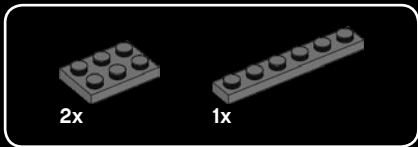

104

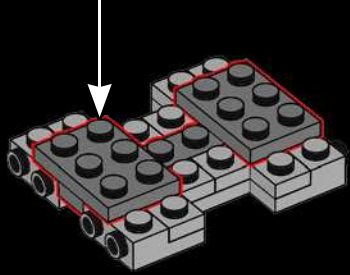
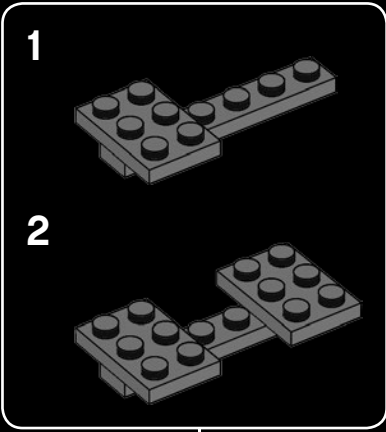

105

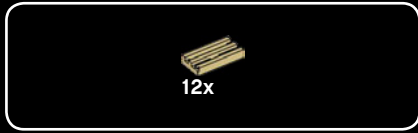
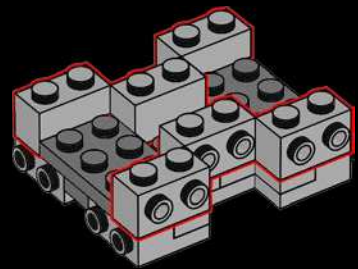

106

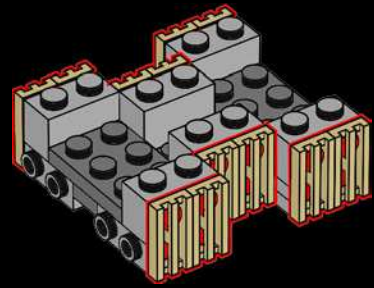

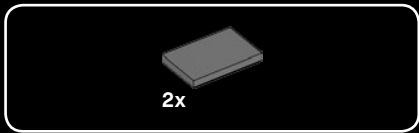

107

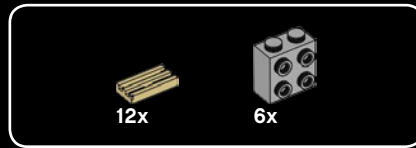
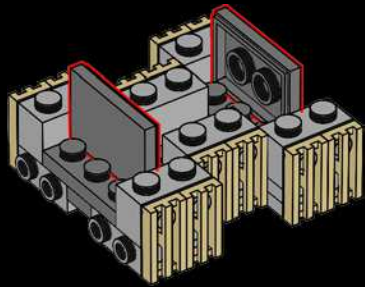

108

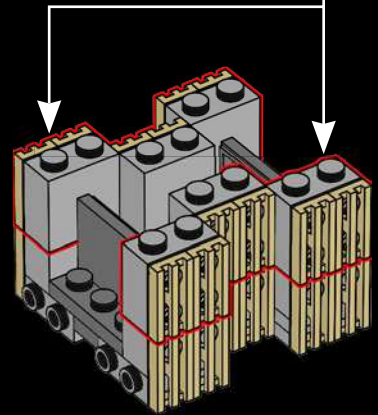
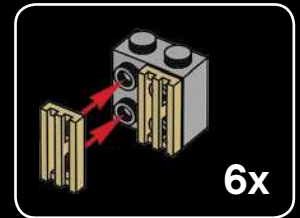

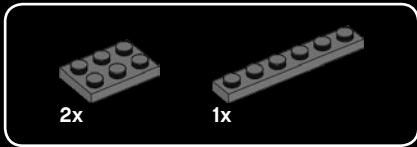

109

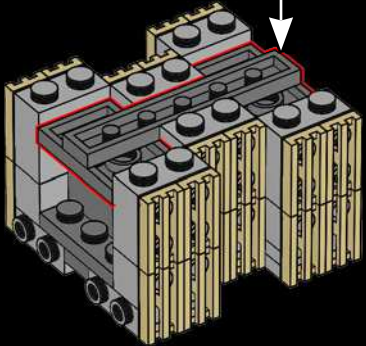
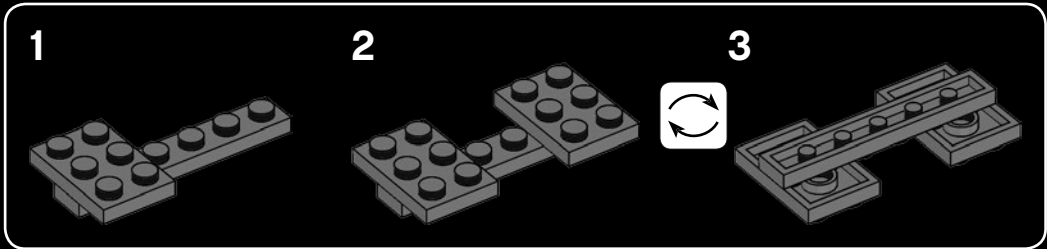

4x

110

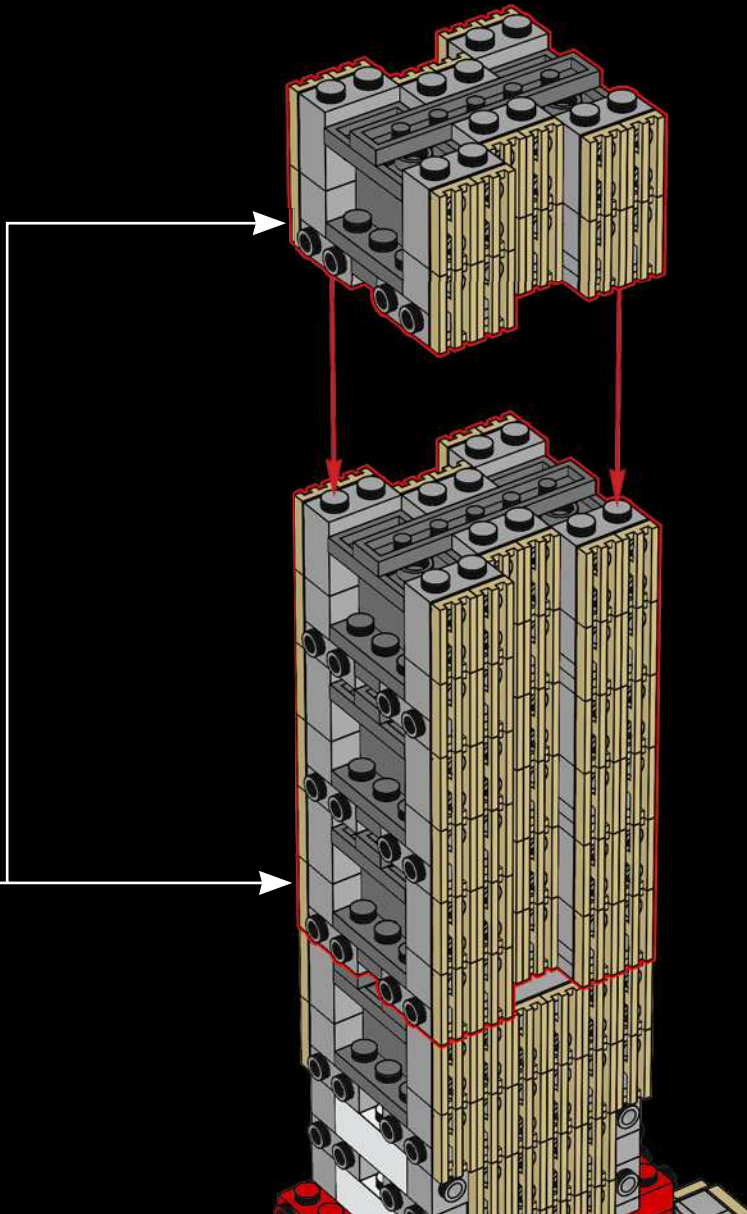

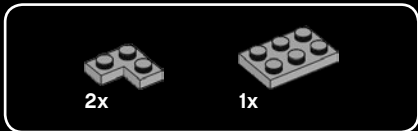
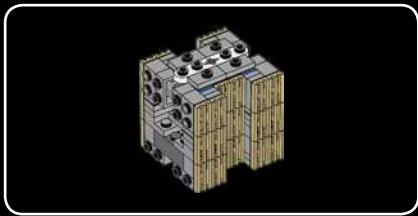

111

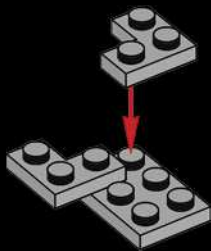

112

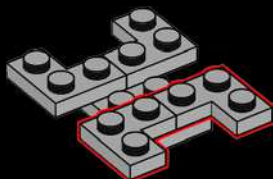

113

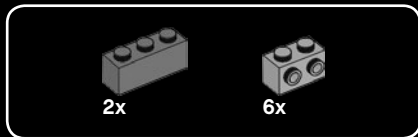
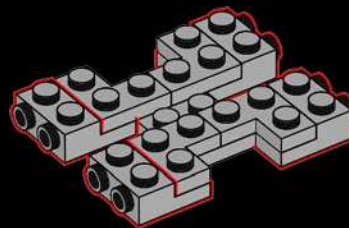

114

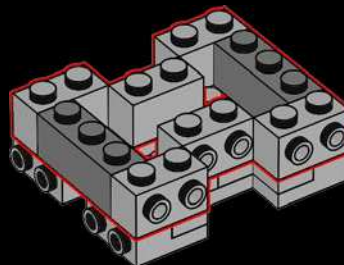



115

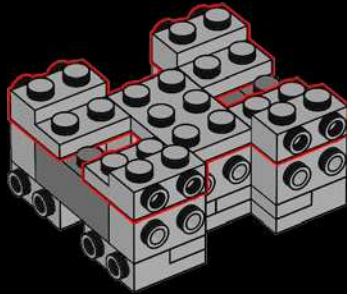

116

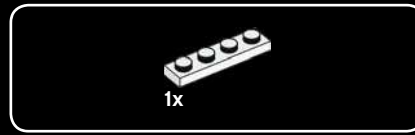
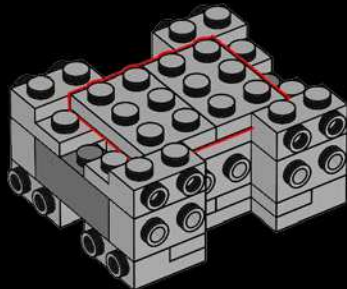

117

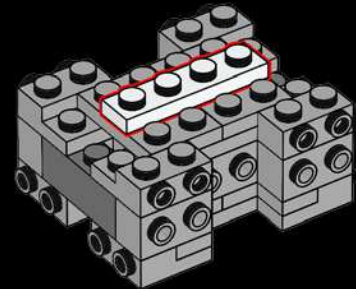

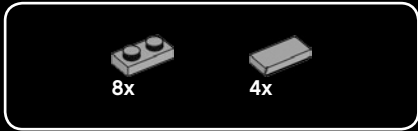

118

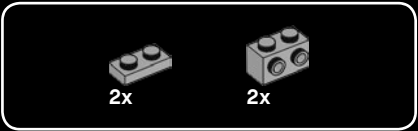
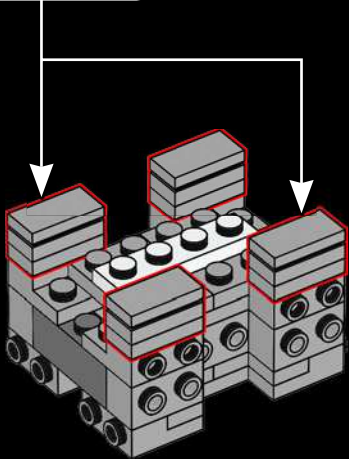
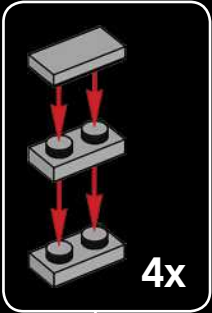

119

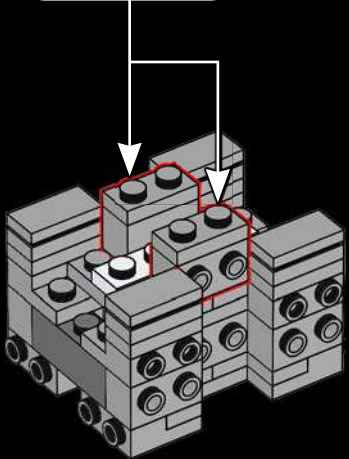
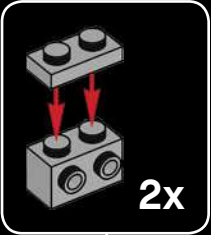

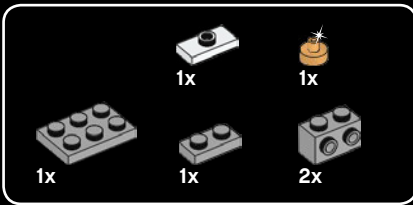

120

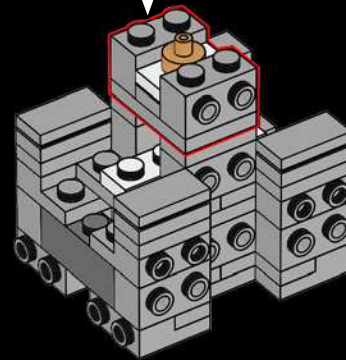
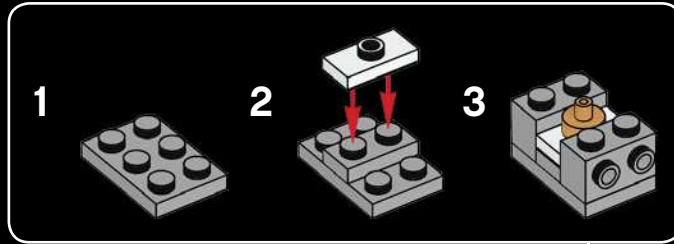



2x

121

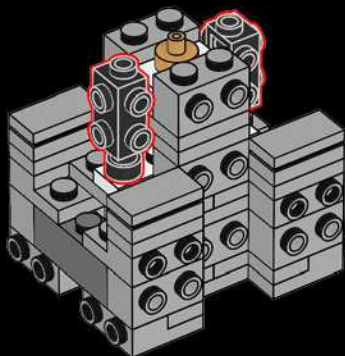

1x

122

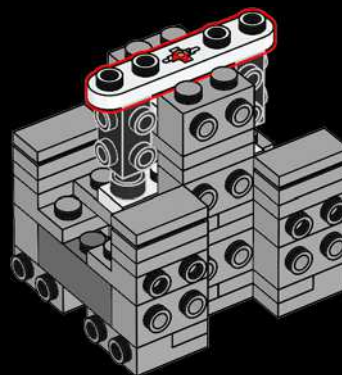

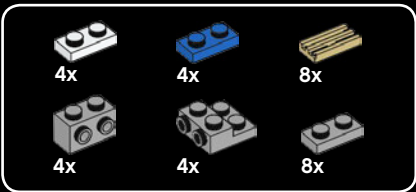

123

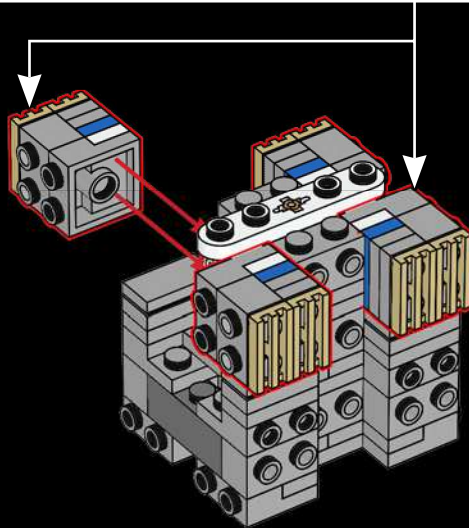
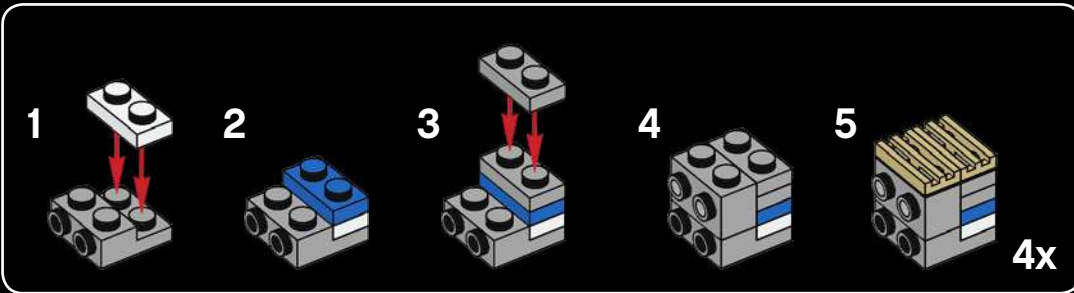



4x

124

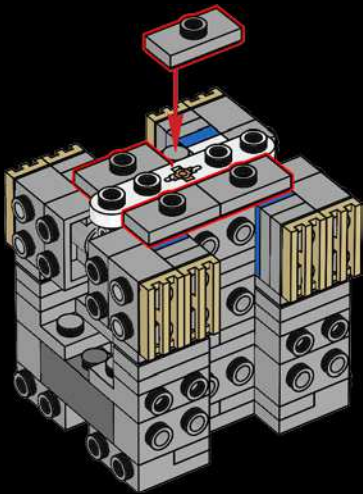

28x

125

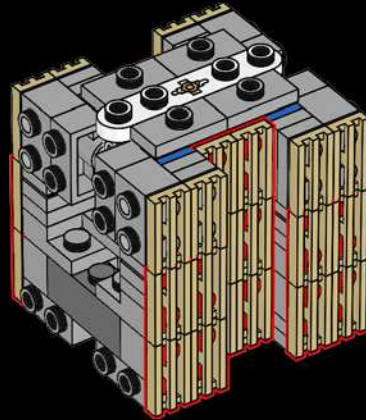

126

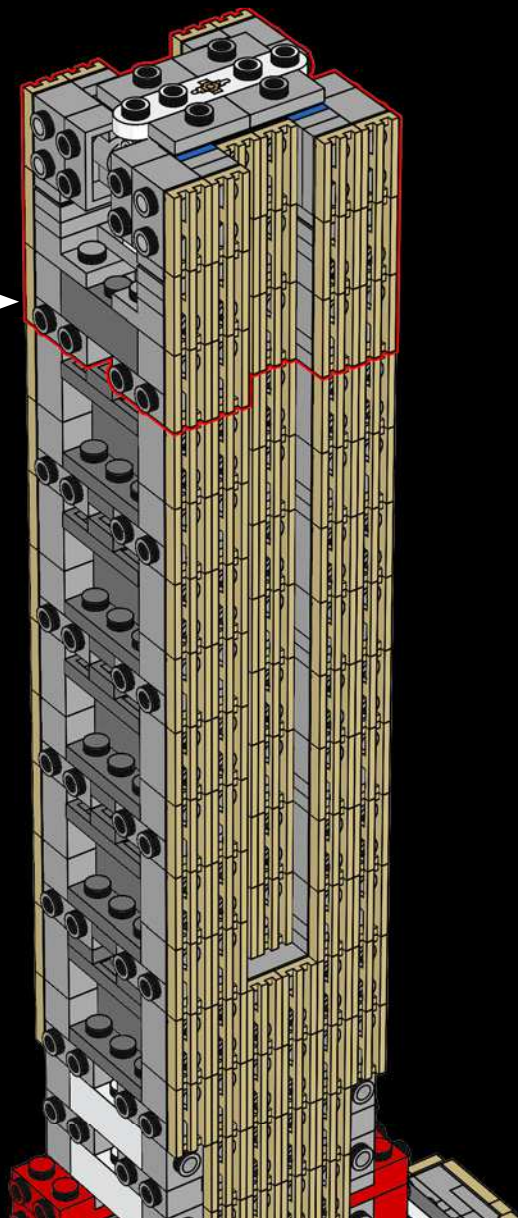

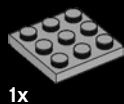

127

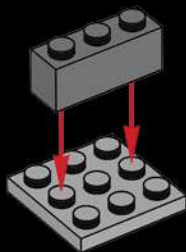

128

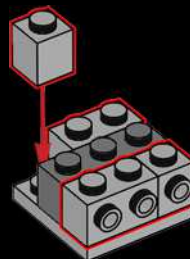

129

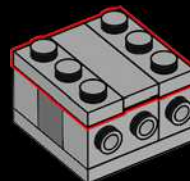



130

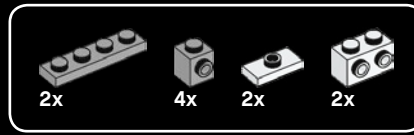
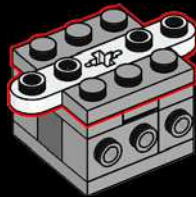

131

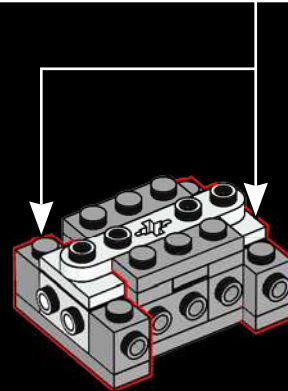
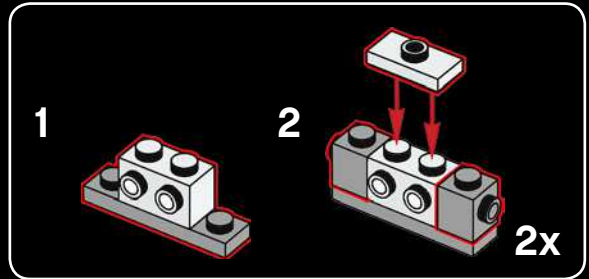



1x

132

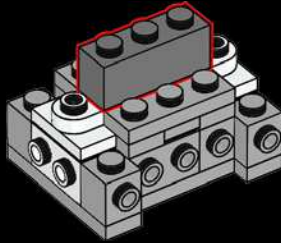

2x



2x

133

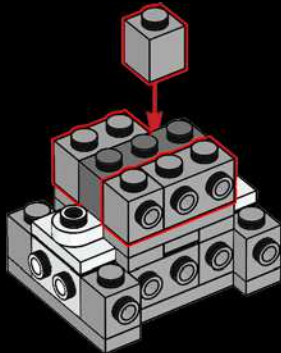

2x

134

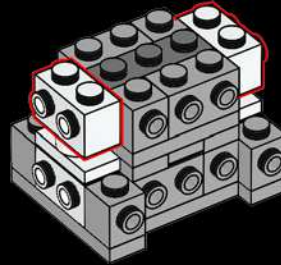



4x

135

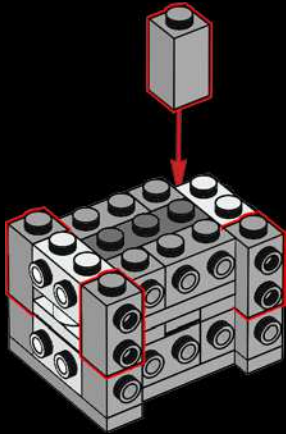

10x

136



137

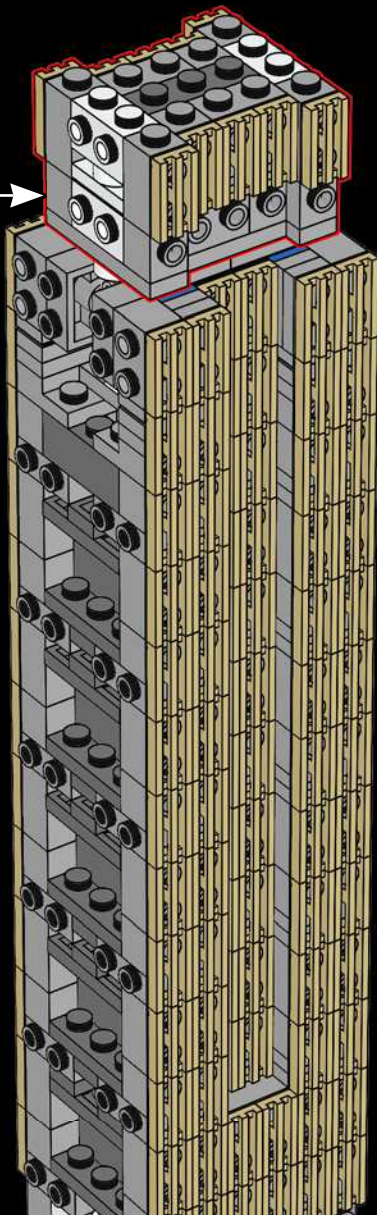



10x

138

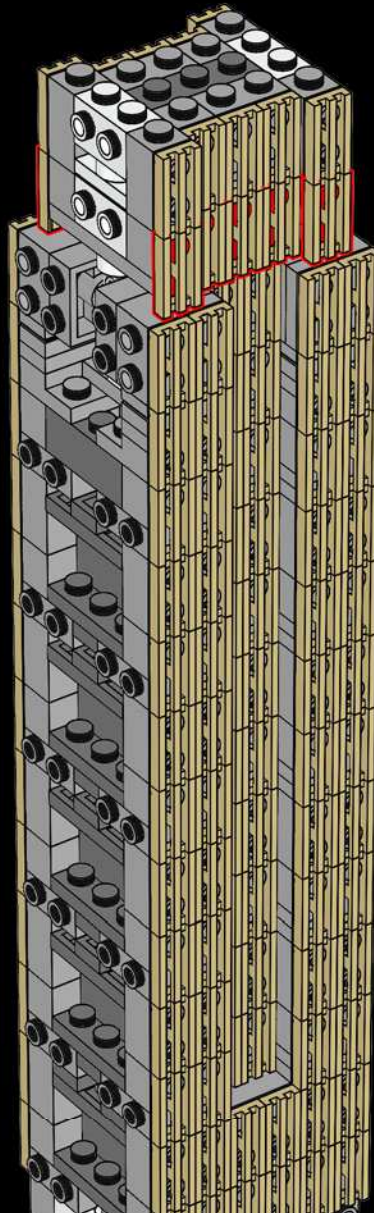

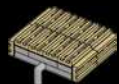

2x



1x



1x

139



2x

140

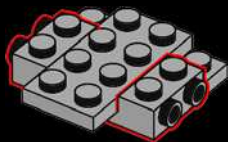

1x

141





142

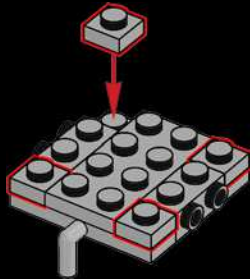

143

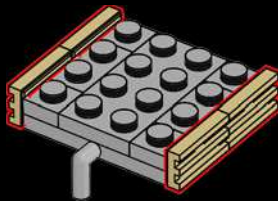

144

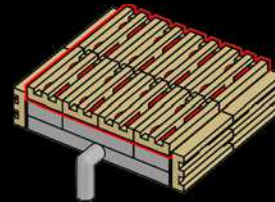

2x

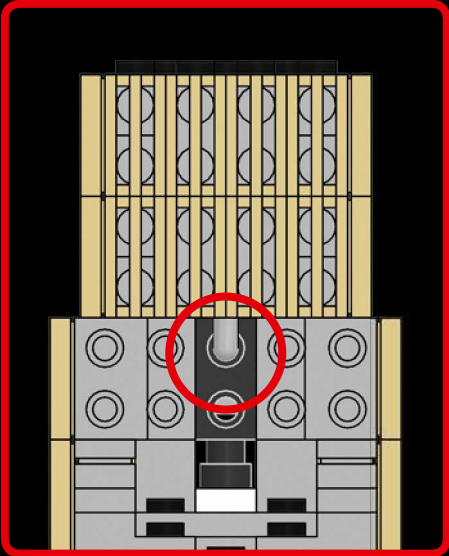
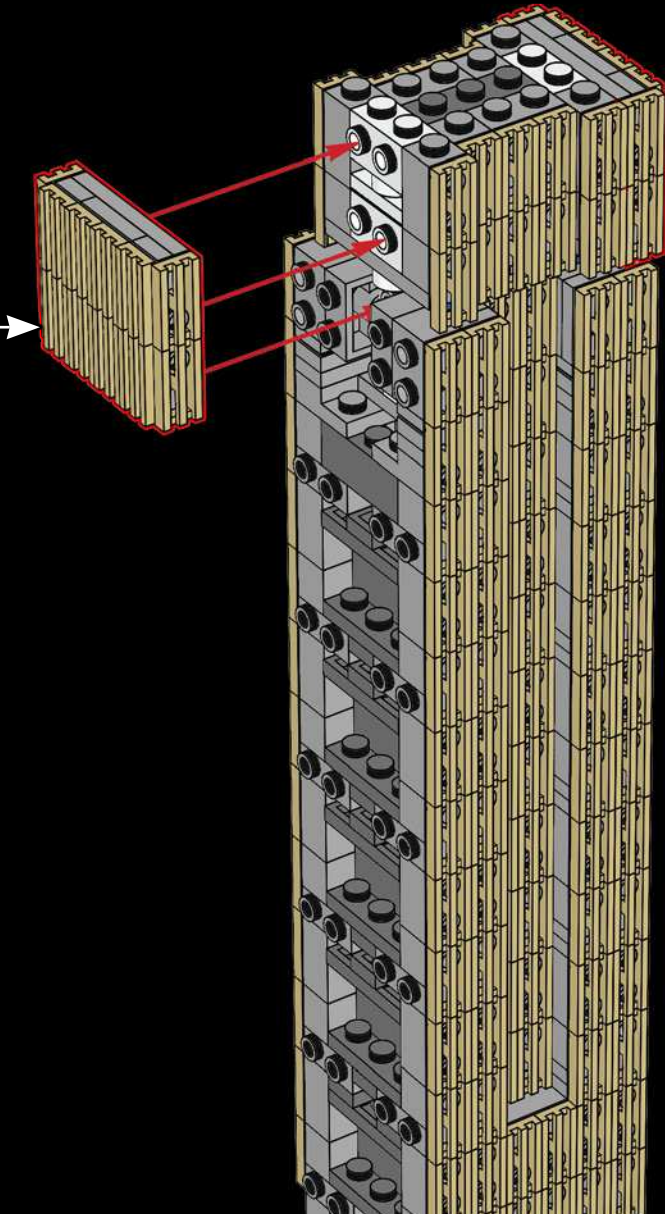

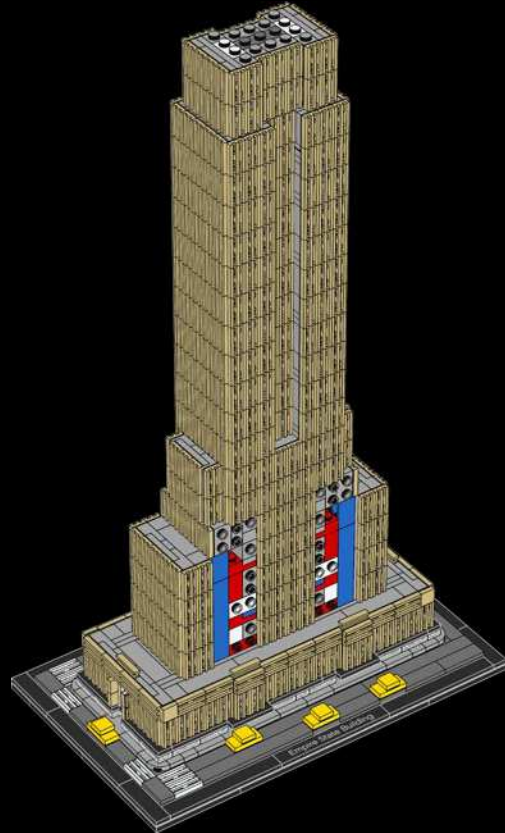
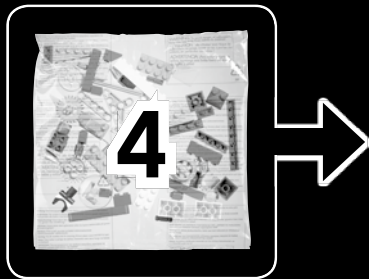



2x



1x

146



1x



1x

147



1x



4x

148

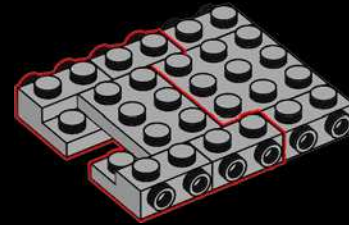

2x



1x

149

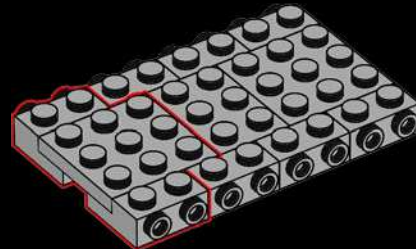

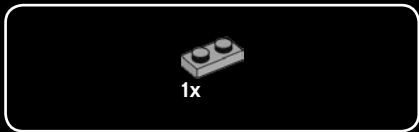

150

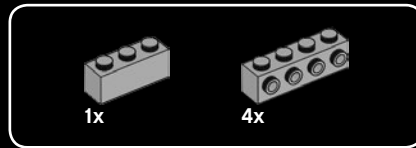
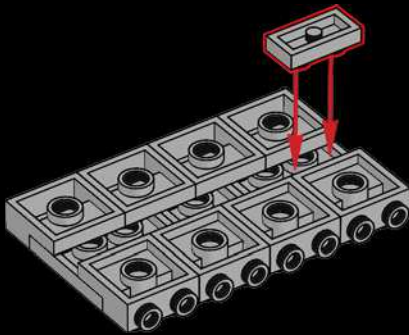

151

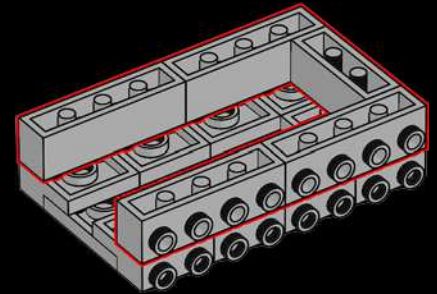

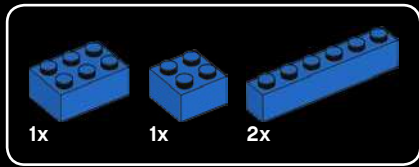

152

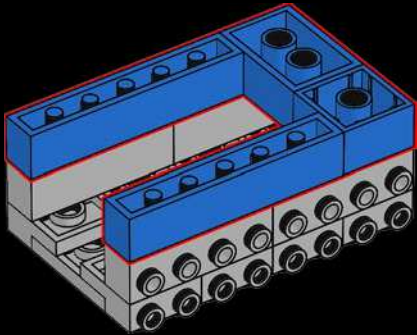

153

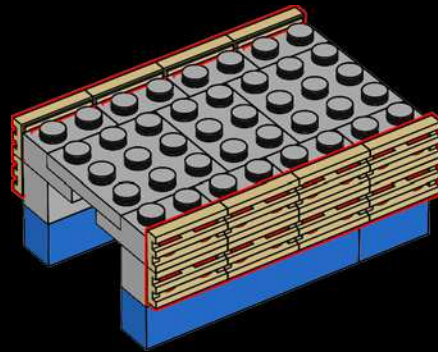
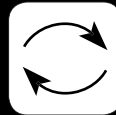

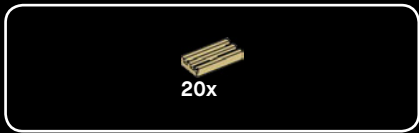

154

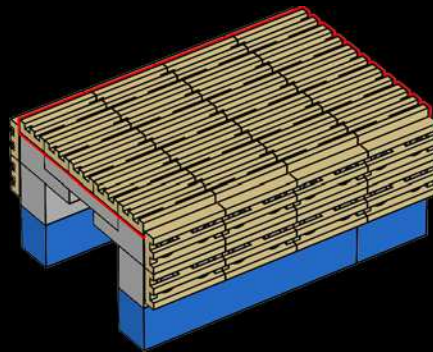

2x

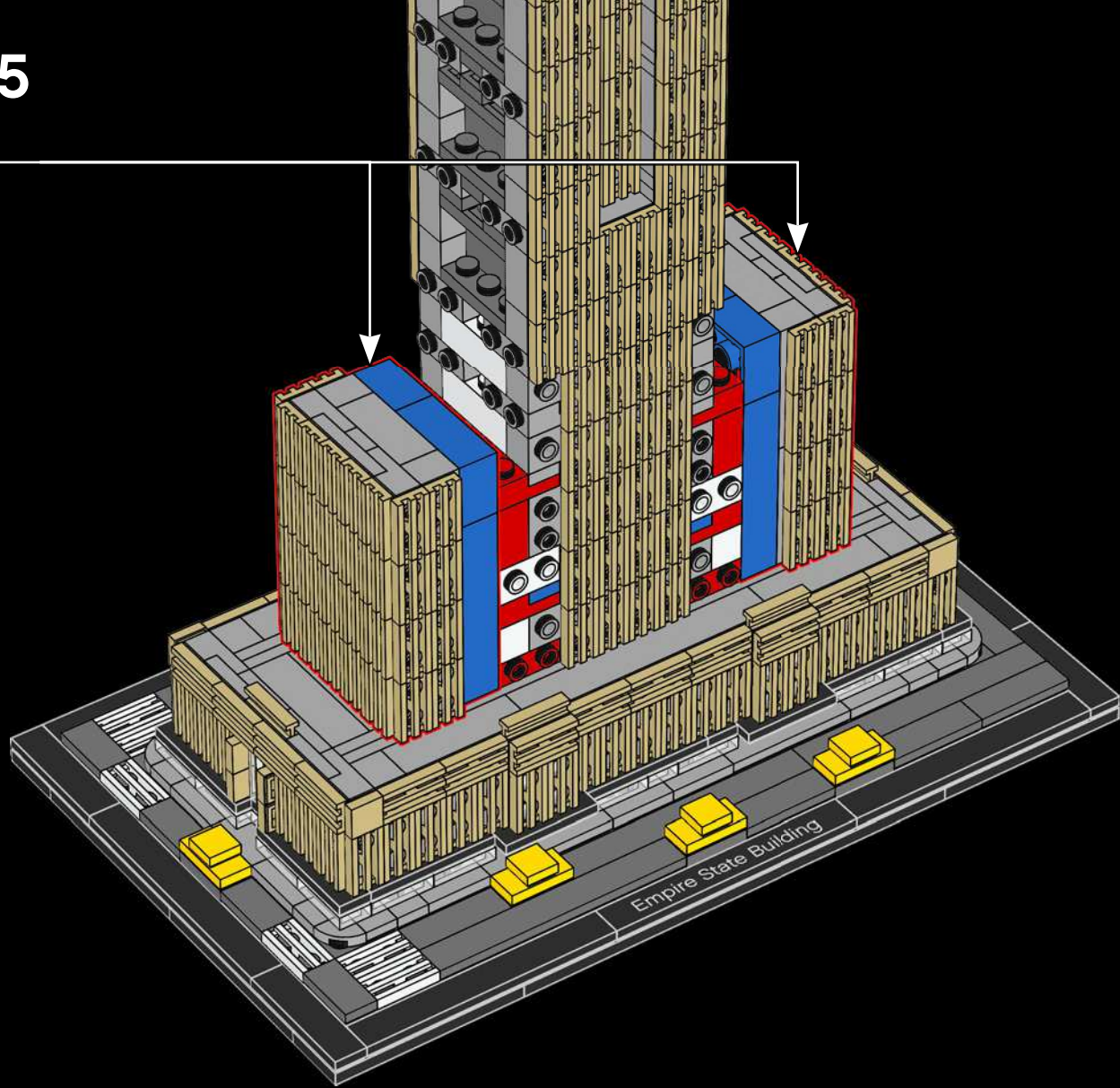

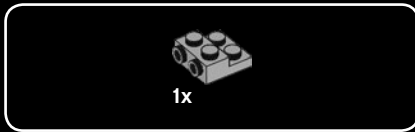
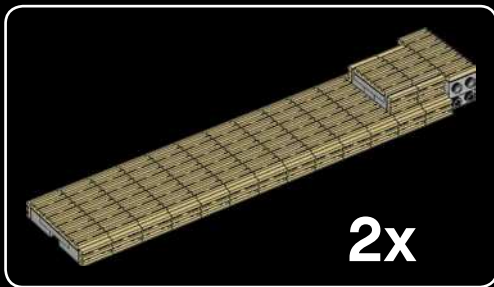

156

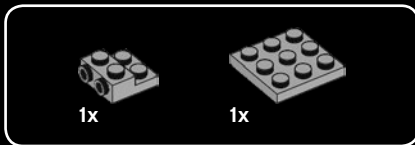

157



158

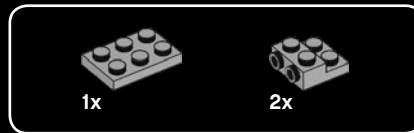

159

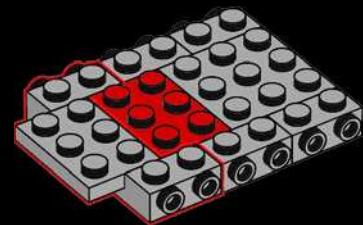

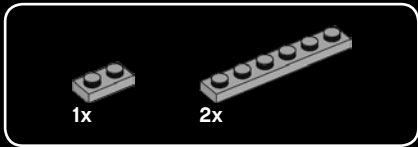

160

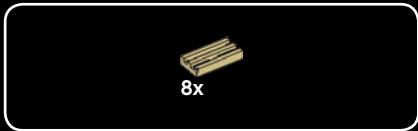
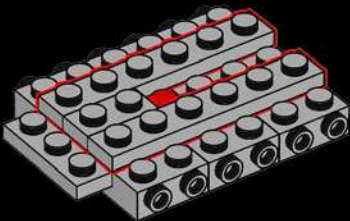

161

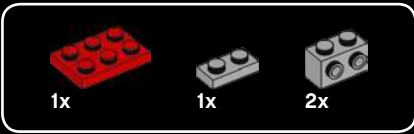
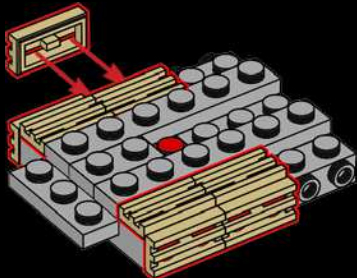

162

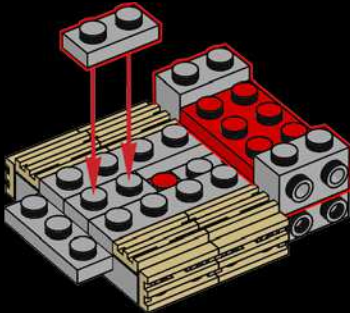

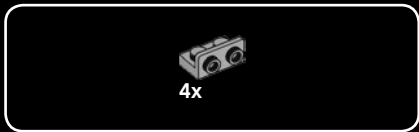

163

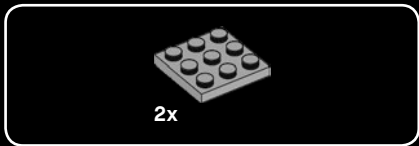
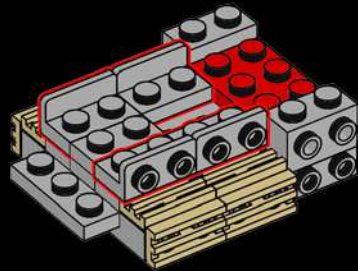

164

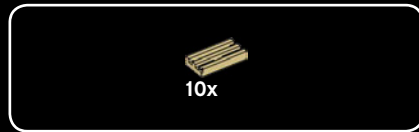
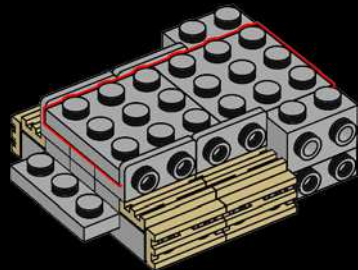

165

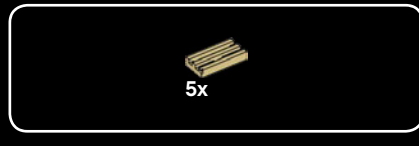
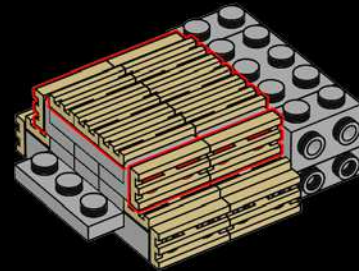

166

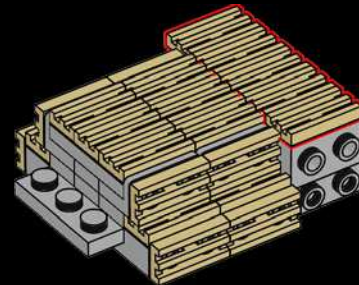

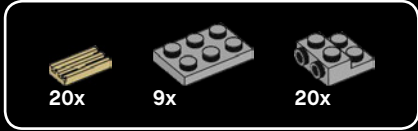

167

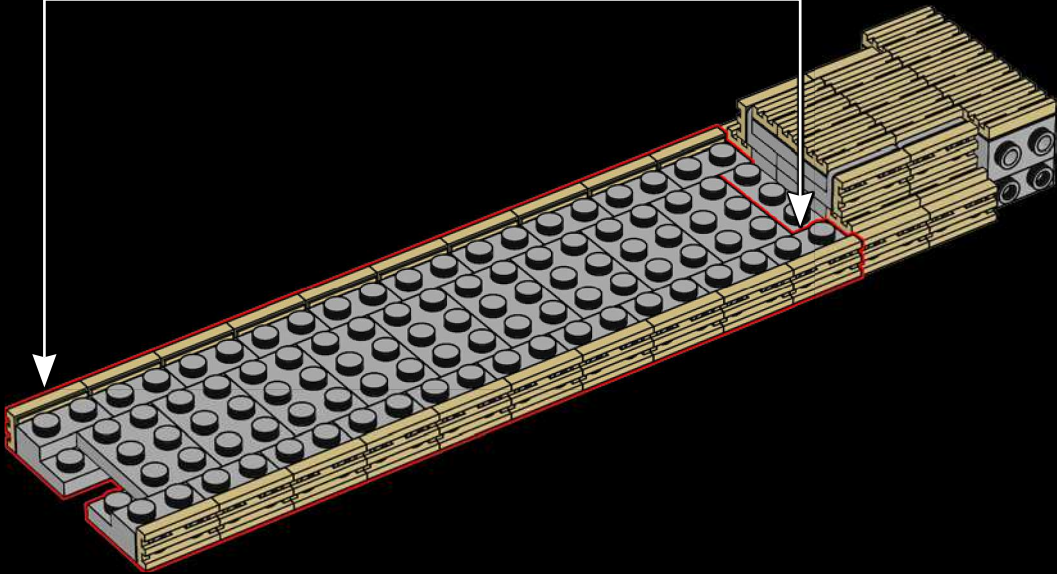
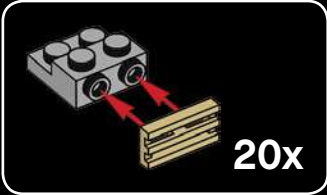

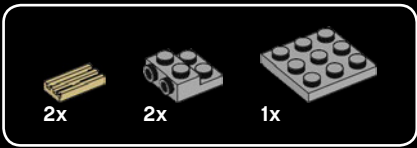

168

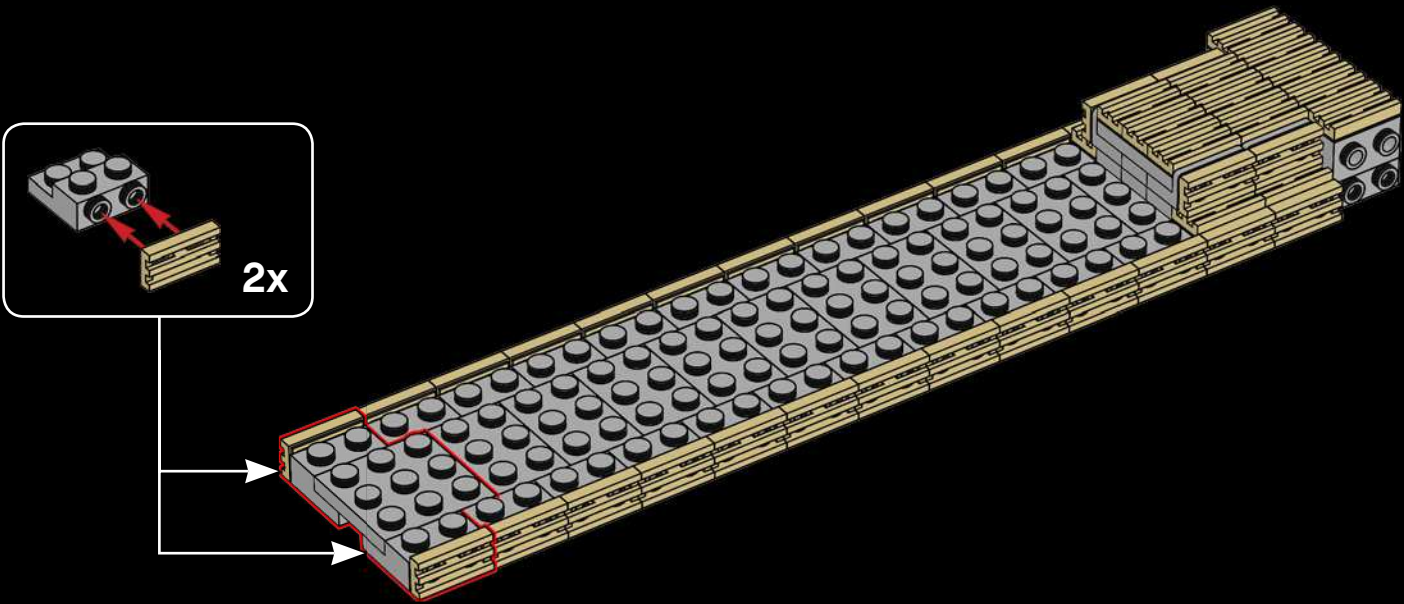



55x

169

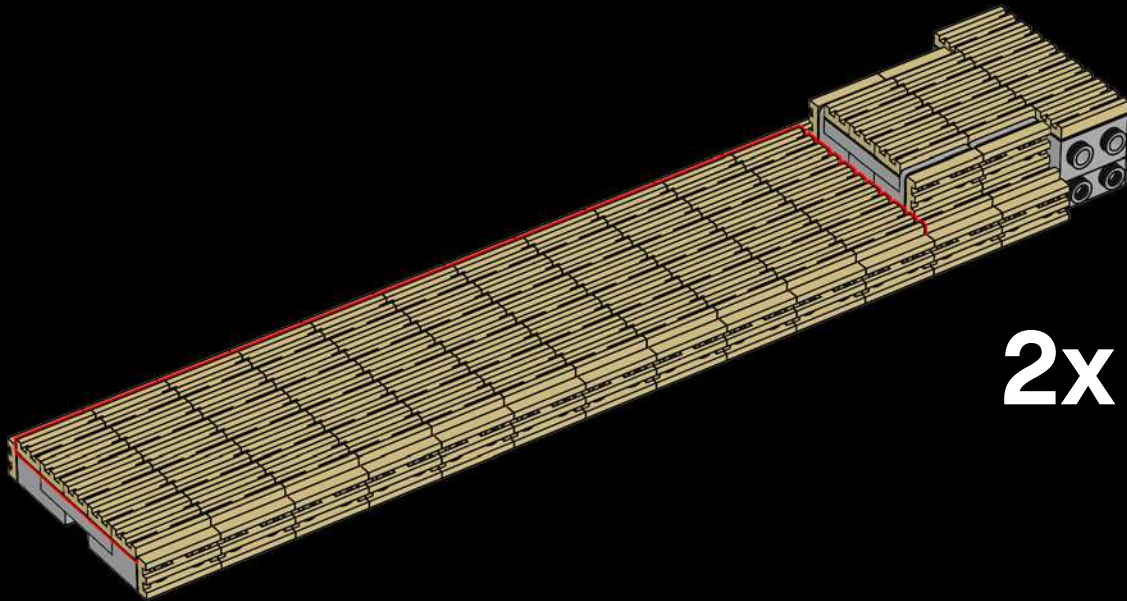

2x

170





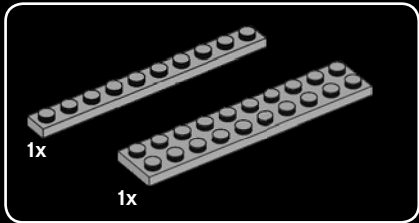

171

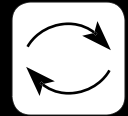
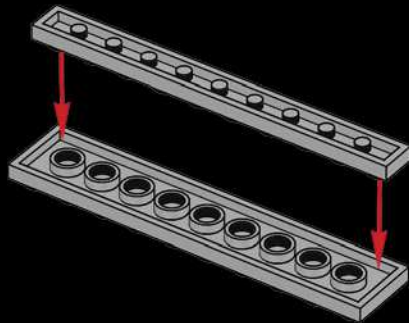

172

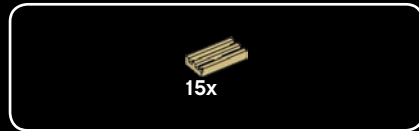
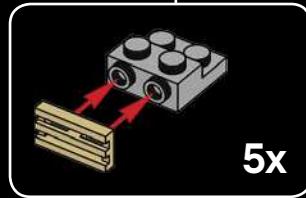
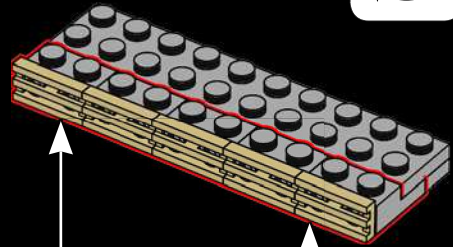

173

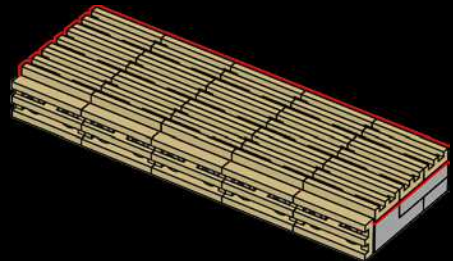

4x

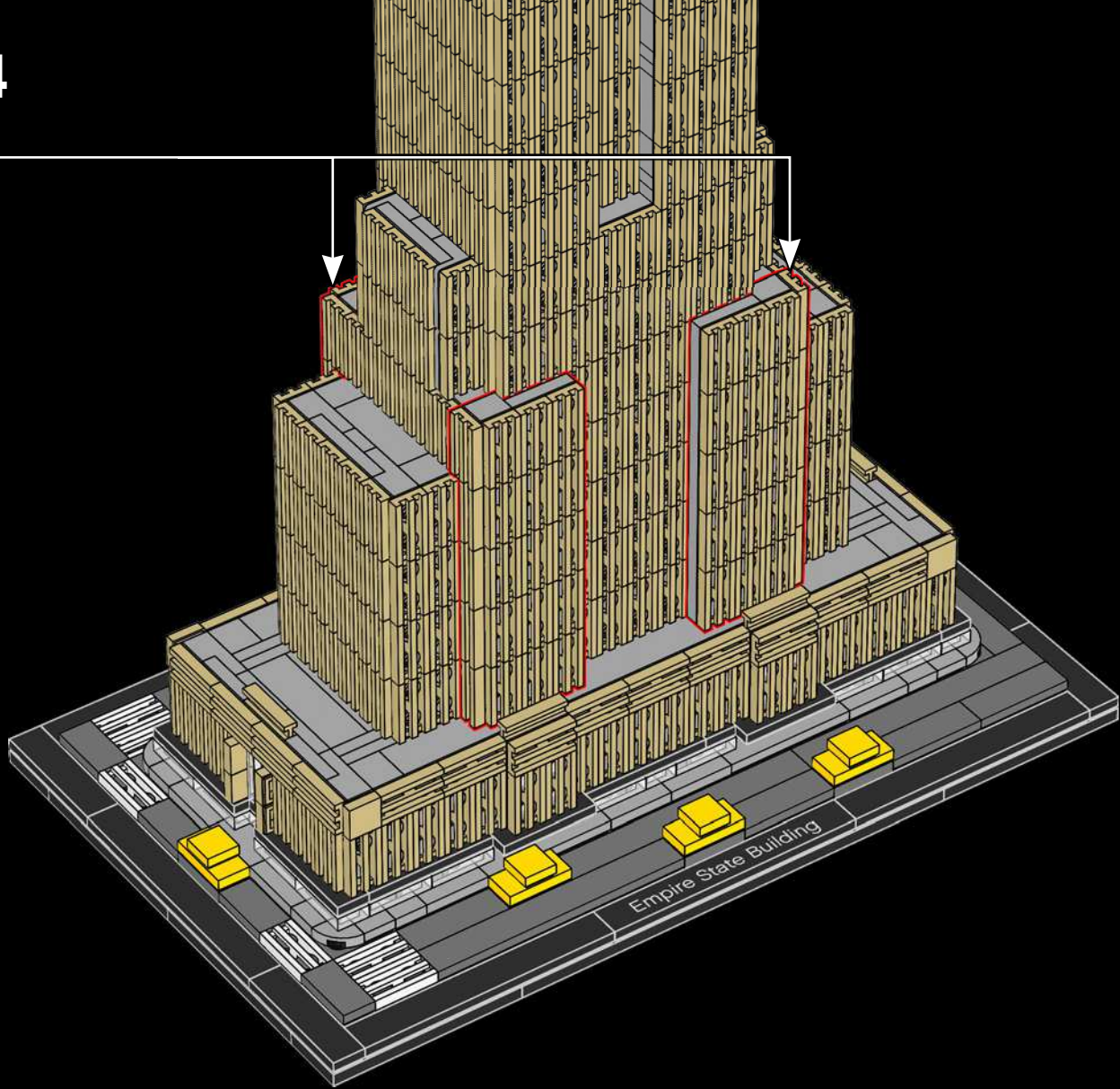

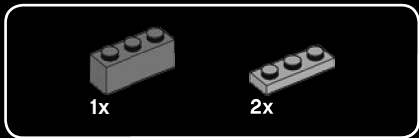

175

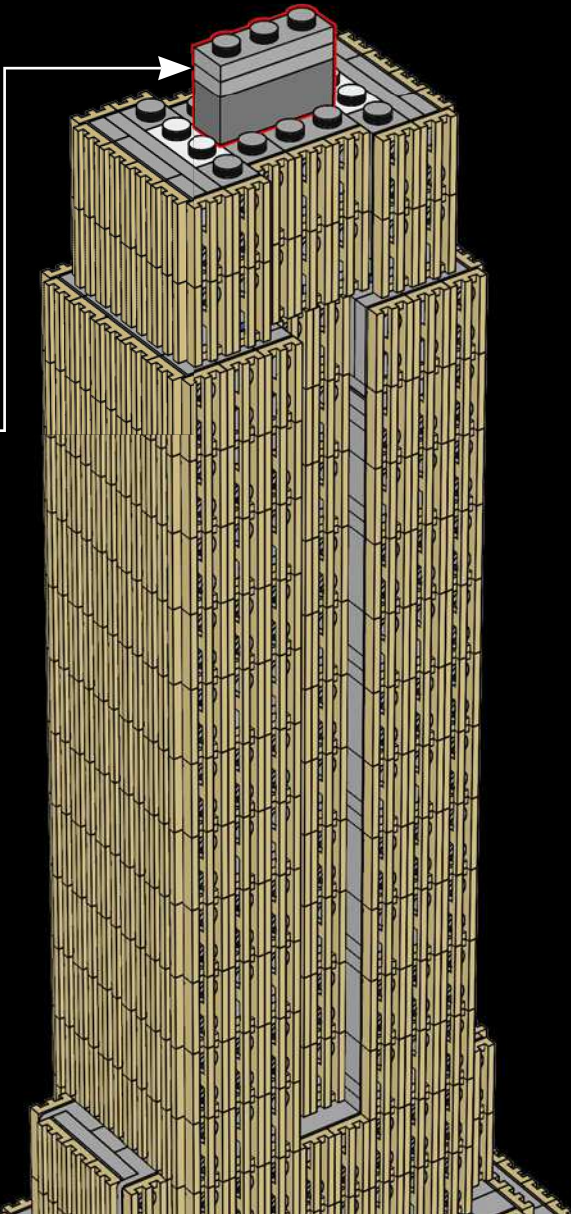
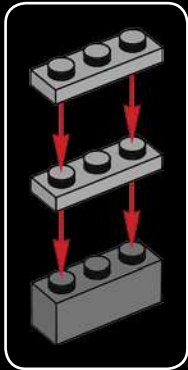



2x



2x

176

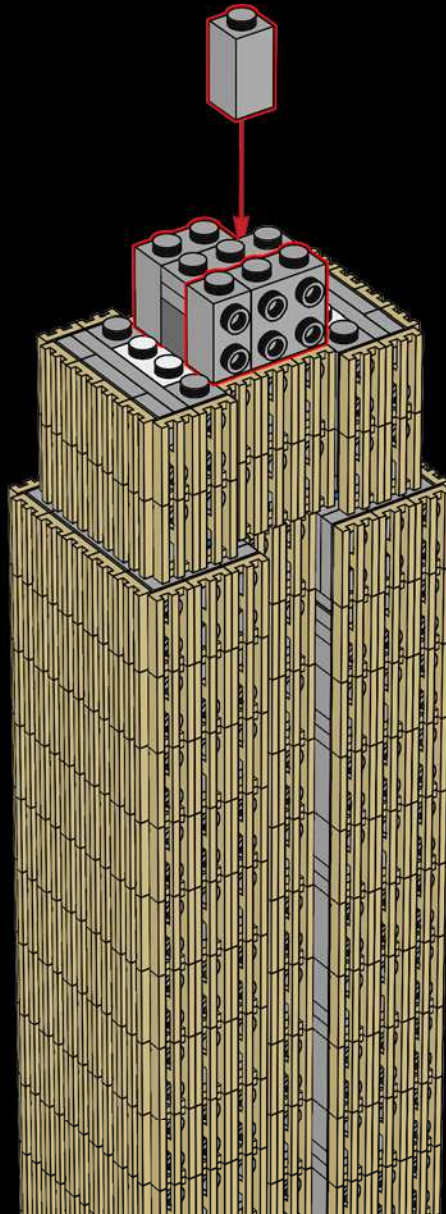



177

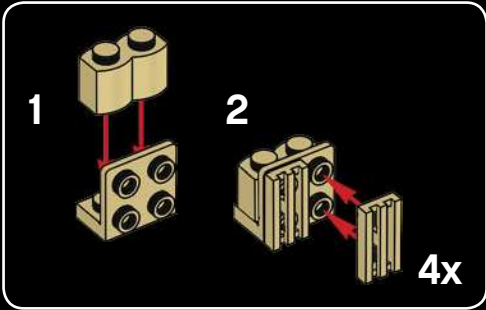



6x



2x



4x

178

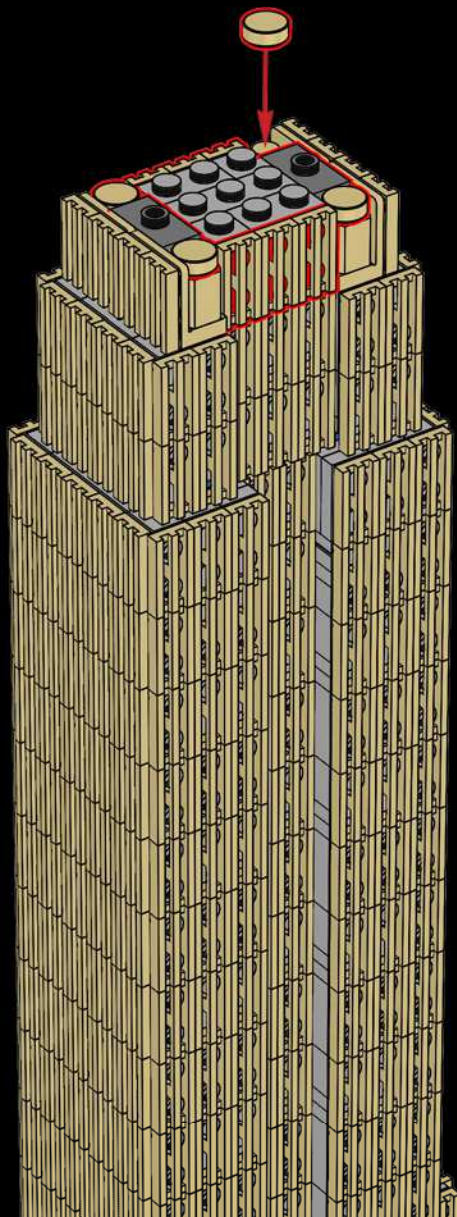



2x



1x

179

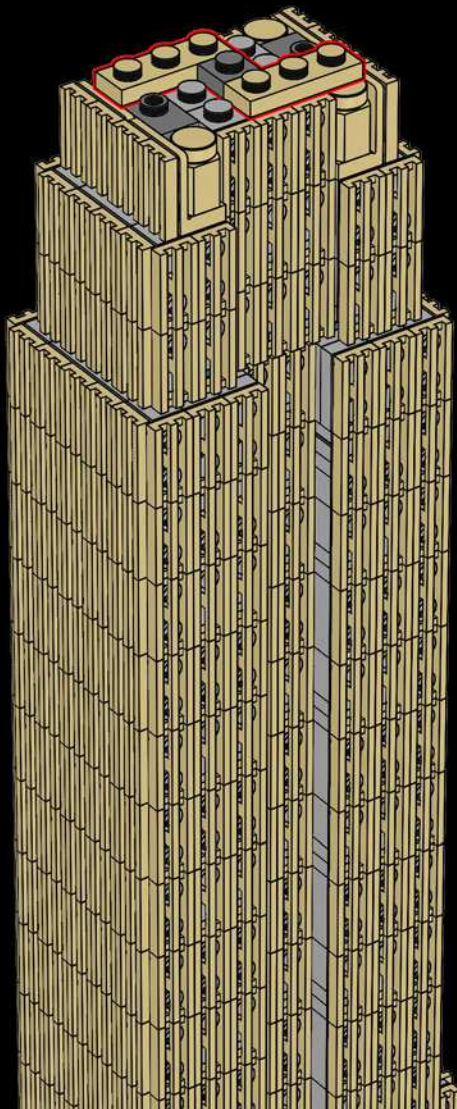



2x

180

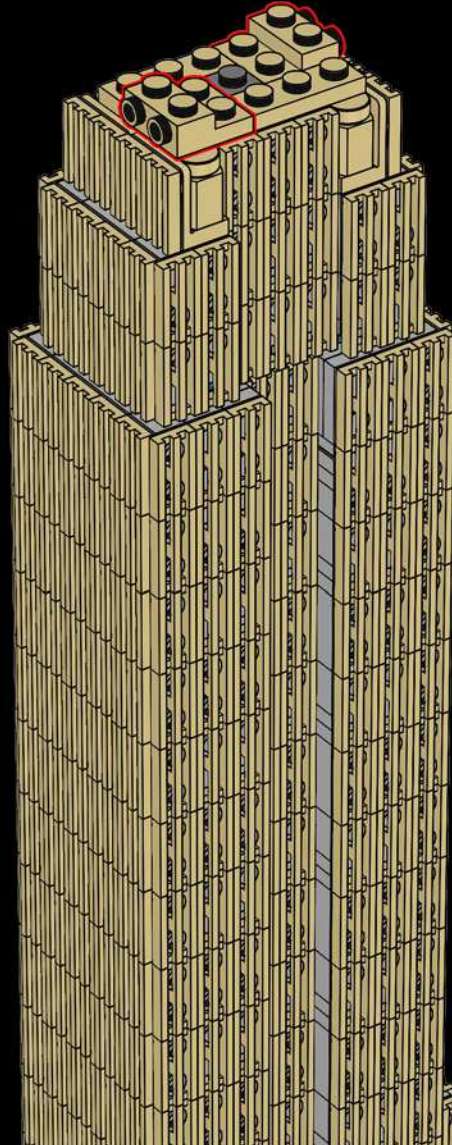

120

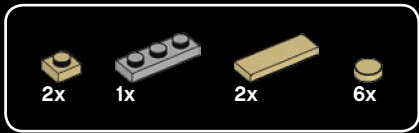

181

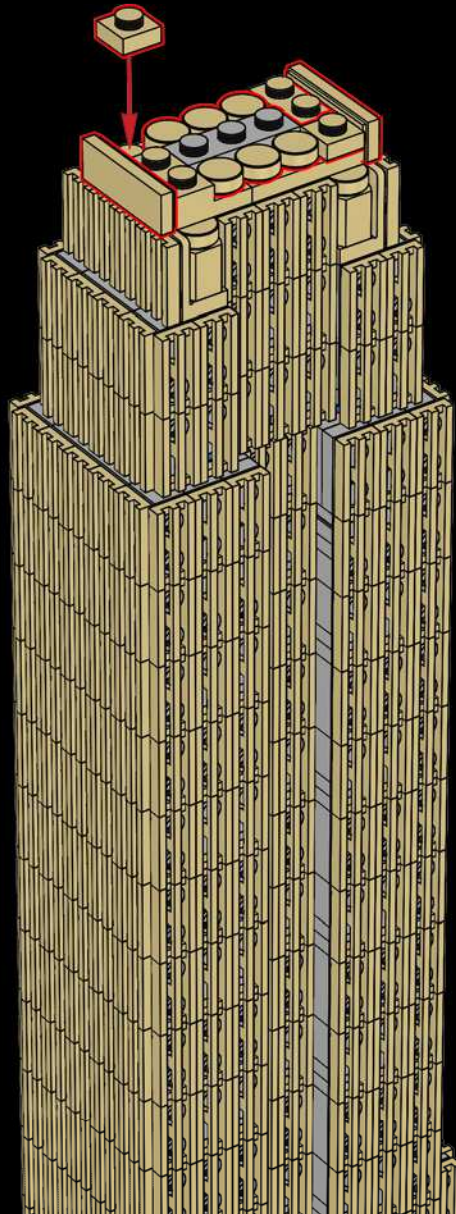

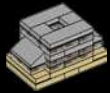

1x



1x

182

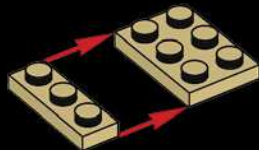

1x



1x

183

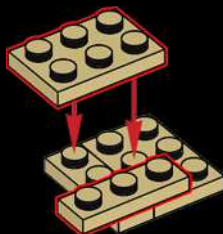

1x

184

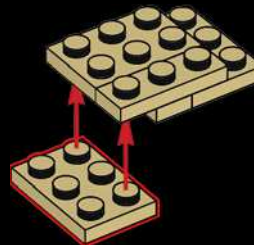

4x

185

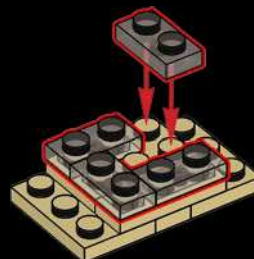



186

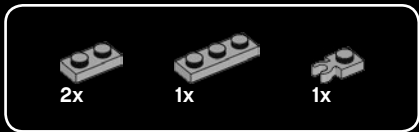
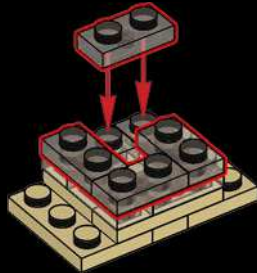

187

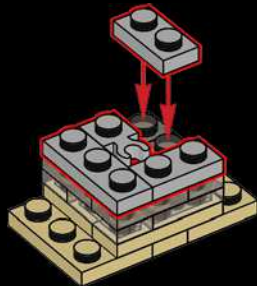

188

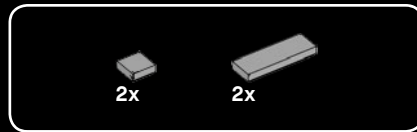
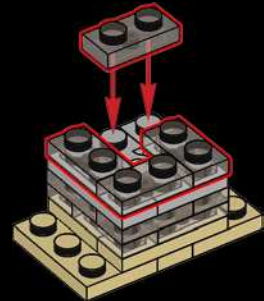

189

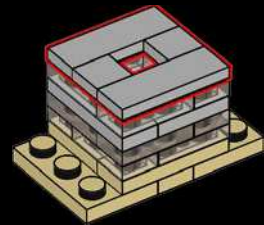



190

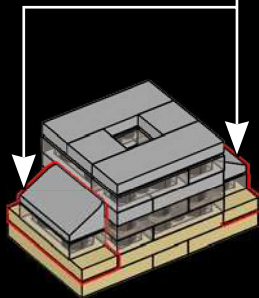
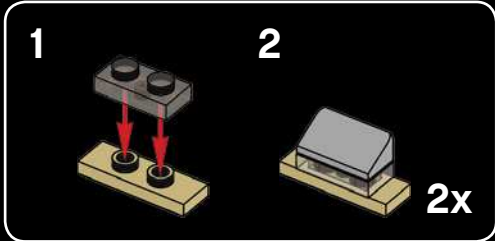

191

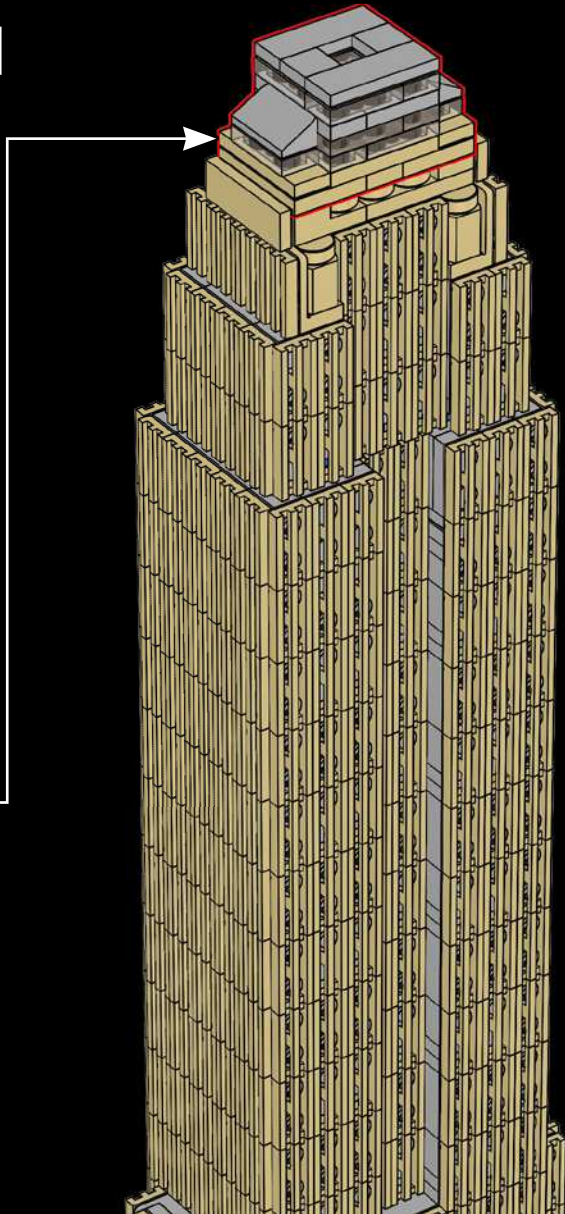



192

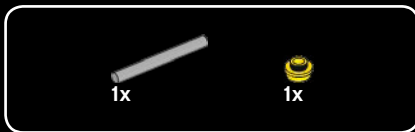
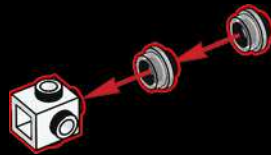

193

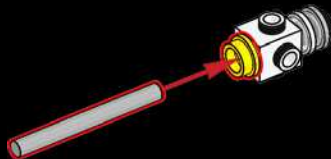

194

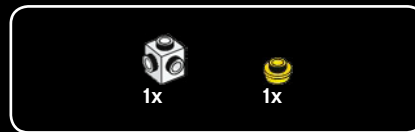
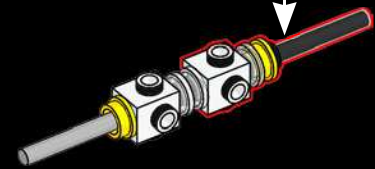
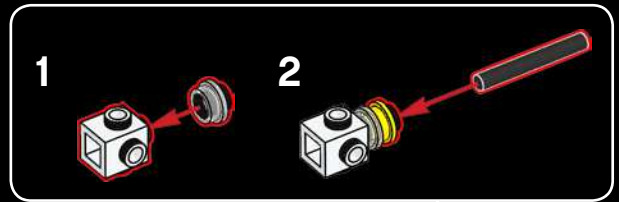

195

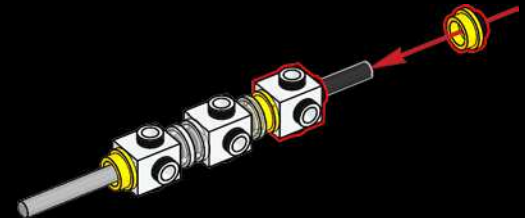



4x

196

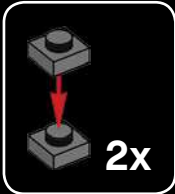

2x

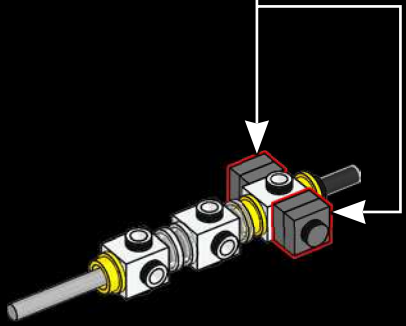

2x



2x



2x



4x



4x

197

1

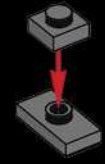

2



3

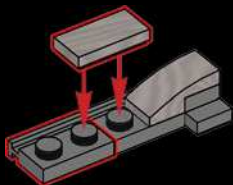

4

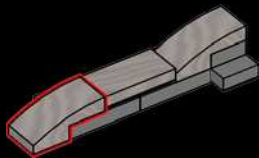

2x

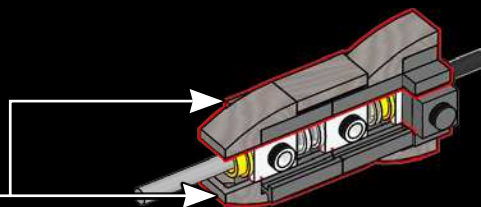



198

A 222 ft. (68 m) radio antenna was erected on top of the tower in 1950, allowing the area's television stations to broadcast from the building. Atop the tower is the 203 ft. (61.9 m) pinnacle, much of which is covered by broadcast antennas and surmounted with a lightning rod.

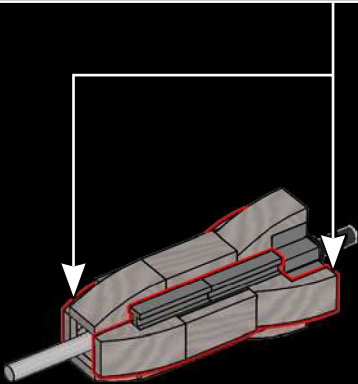
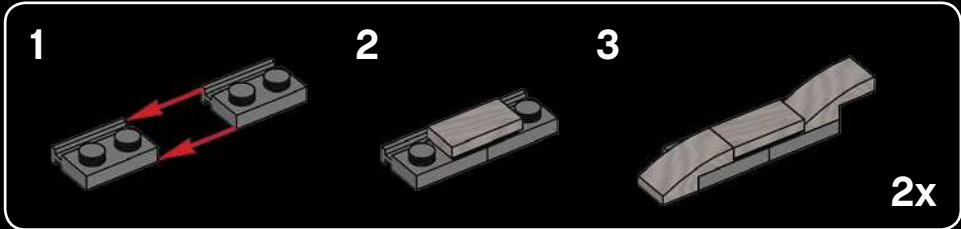



199

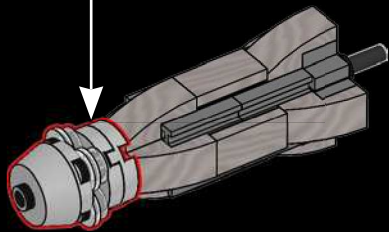
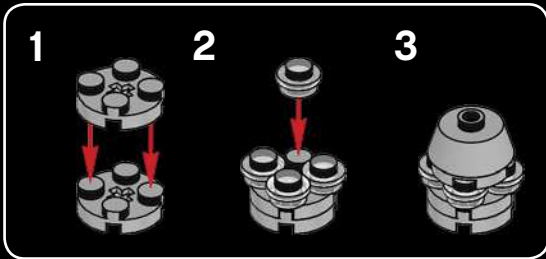

200

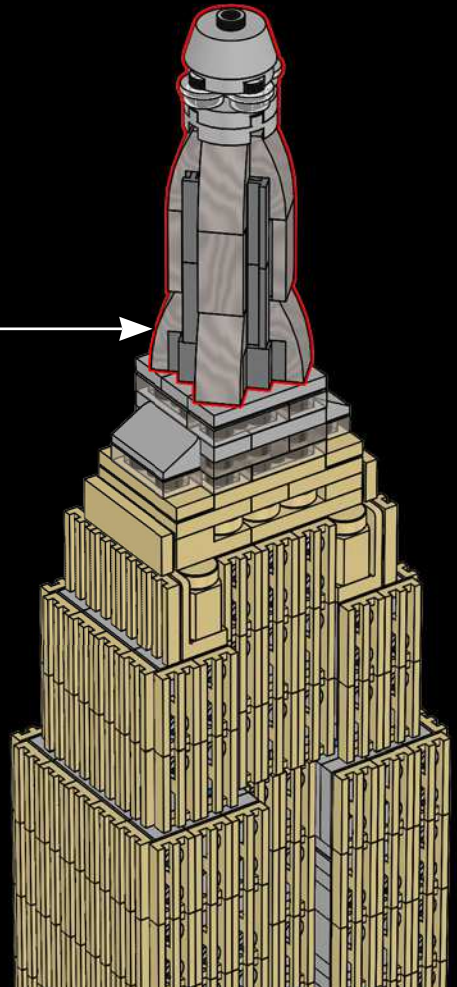

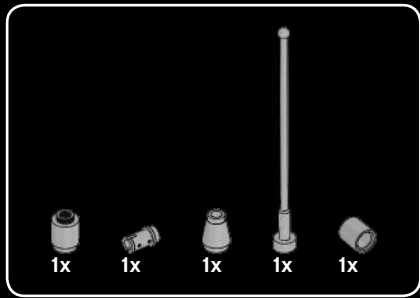

201

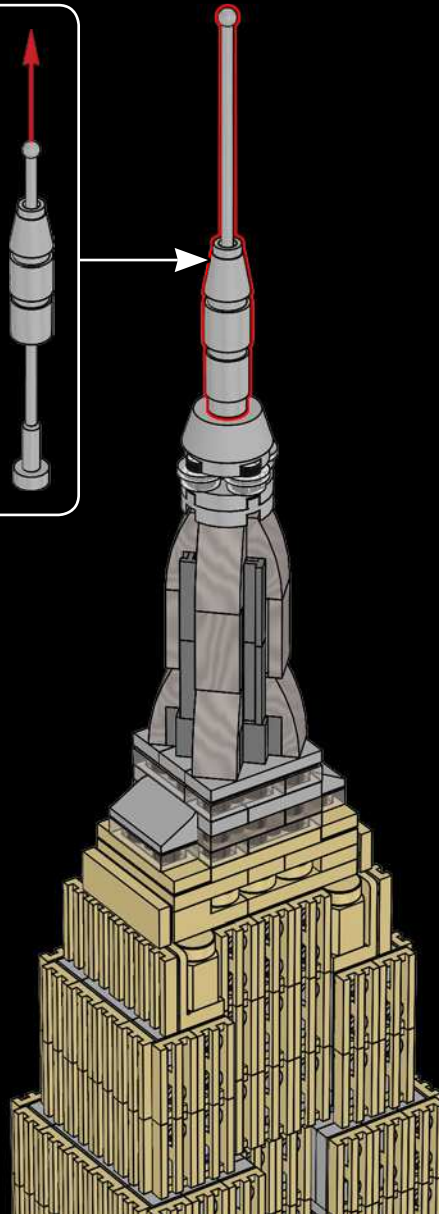
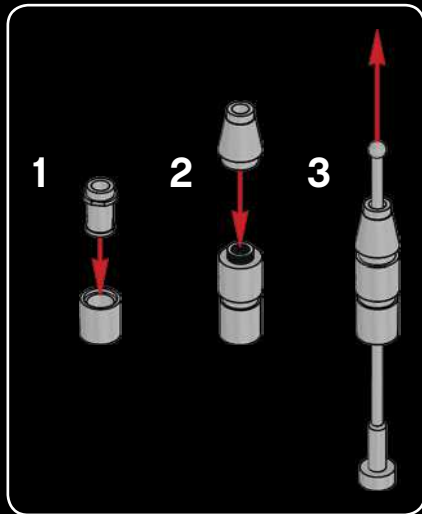

LEGO® Architecture – do you like it?

The LEGO Group would like your opinion on the new product you have just purchased. Your feedback will help shape the future development of this product series. Please visit:

[LEGO.com/productfeedback](https://www.lego.com/productfeedback)

By completing our short feedback survey, you will be automatically entered into a drawing to win a LEGO® prize.





Terms & Conditions apply.

LEGO® Architecture

The LEGO® Architecture series creatively captures the essence of many of the world's most iconic landmarks while giving you an enjoyable and engaging LEGO building experience.

Whether your interest is in travel, design, history or architecture, these sets are a physical memento of a great trip abroad, a famous building you know well, or a city you still dream of visiting.

Every LEGO Architecture set is designed to be displayed. Much more than just a photo, building and displaying your model on your desk, in the bookcase or on the shelf, lets you be transported every time you admire the view.

Follow us on  

Adam Reed Tucker is the co-developer of the LEGO Architecture product line.



Celebrate the world of architecture
and collect all the models



21045
Trafalgar Square



21041
Great Wall of China



21030
United States Capitol Building

21042
Statue of Liberty





21039
Shanghai



21034
London



21047
Las Vegas



21044
Paris
Paris



21028
New York City



21043
San Francisco

References

Pictures -

© GettyImages

Customer Service
Kundenservice
Service Consommateurs
Servicio Al Consumidor
LEGO.com/service or dial

 00800 5346 5555 ;
 1-800-422-5346 ;

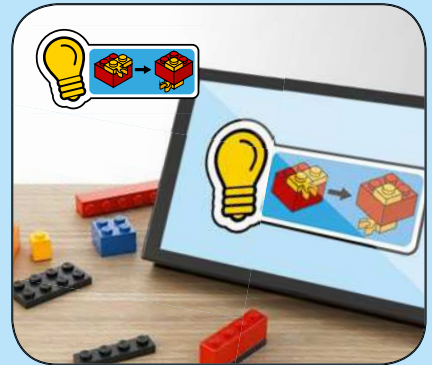



3x
4111971



2x
4547489



12x
6058177



6x
241201



11x
6051511



4x
302301



6x
6018774



6x
6097637



4x
362201



19x
302101



1x
300201



1x
371001

138



2x
4527839



2x
302001



4x
4560178



2x
346001



10x
6139649



4x
4125253



2x
4159553



4x
4218749



684x
4124456



4x
6174925



6x
4160483



2x
6132769



4x
4121921



2x
6131896



10x
6211966



3x
4118790



2x
4201062



4x
4124067



4x
6187620



4x
4569056



4x
6135130



20x
6061711



4x
302121



2x
371021



4x
6217123



2x
346021



14x
302323



2x
300323



2x
300223



8x
300923



3x
6168644



6x
307024



2x
300424



6x
6092583



4x
307026



8x
302426



1x
6093525



4x
242026



2x
4523339



4x
6162892



16x
243126



8x
379526



7x
416226



1x
6265011



4x
4100378

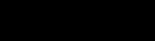

2x
6001494



7x
6240030



8x
6252041



32x
6240204



8x
6251294

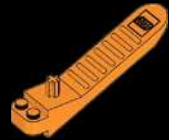

1x
6240515



14x
6240219



1x
6164381



1x
4211412



1x
4529241



1x
6183784



1x
4211483



4x
6176433



16x
4211399



8x
4558953



6x
4211415

6x
6225242

1x
4594238

2x
4211475

1x
6028324

2x
4568637

22x
6066097

31x
4211398

10x
4211414

72x
6015344

42x
6123809

8x
6004990

12x
6126082

32x
4211353

2x
4237084

148x
4654577

16x
4211429

2x
4211428

3x
4558169

1x
6116608

39x
4211396

4x
4211356

8x
4211636

2x
4211394

2x
6173095

6x
4211445

19x
6015347

2x
4211395

4x
4211385



6x
4211393



6x
4211549

12x
4211438

2x
6037399

2x
4211474

4x
4251149

4x
4211462

7x
4210719

5x
4211052

6x
4211063

4x
6092572

8x
4543086

5x
4211104

6x
4568734

14x
6187008

29x
4211043



12x
4211056

4x
4211002

8x
4211008

4x
4210998

6x
4210997

6x
4211122

1x
6186672

4x
6107197

4x
6217492

8x
6092115

8x
6066028

Customer Service

Kundenservice

Service Consommateurs

Servicio Al Consumidor

LEGO.com/service or dial

: 00800 5346 5555
: 1-800-422-5346



LEGO and the LEGO logo are trademarks of the LEGO Group.
©2019 The LEGO Group. 6281924

The Empire State Building name and images® are registered trademarks of ESRT Empire State Building, L.L.C and are used with permission.

 [LEGO.com/architecture](https://www.lego.com/architecture)

Follow LEGO® Architecture on

