

HR FRITEZA NA VRUĆI ZRAK	2	LT AIRFRYER	46	SV LUFTFRITÖS	85
CS VYSOUŠEČ RUKOU	6	LV AIRFRYER	51	TR YAĞSIZ FRITÖZ	89
DA AIRFRYER	10	NO AIRFRYER	55	UK МУЛЬТИПІЧ	93
EN AIRFRYER	14	PL FRYTKOWNICA BEZTŁUSZCZOWA			
ET KUUMAÕHUFRITÜÜR	18		59		
FI ILMAKYPSENNIN	22	RO FRITEUZĂ CU AER	63		
FR FRITEUSE À AIR	26	RU МУЛЬТИПЕЧЬ	67		
DE HEISSLUFTFRITTEUSE	31	SR ФРИТЕЗА БЕЗ УЉА	72		
HU FORRÓLEVÉGŐS SÜTŐ	36	SK AIRFRYER	77		
IT FRIGGITRICE AD ARIA	41	SL AIRFRYER	81		

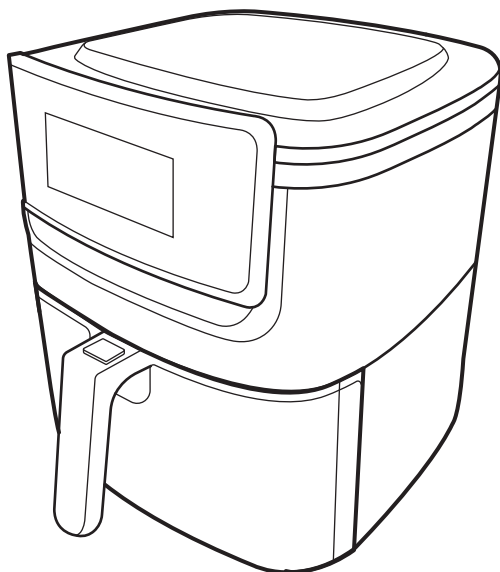

1. OPĆI PREGLED

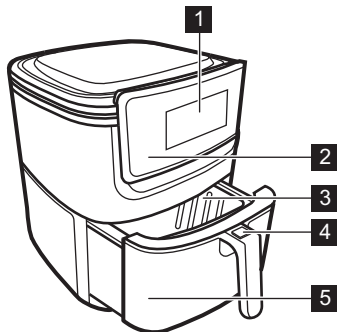

- 1** Zaslون
- 2** Upravljačka ploča
- 3** Košara
- 4** Sigurnosno zaključavanje sa zaštitnim poklopcem
- 5** Plitica

2. UPRAVLJAČKA PLOČA

2.1 Upravljačka ploča

Upoznajte se s osnovnim ikonama na upravljačkoj ploči i zaslonu.

UKLJ./ISKLJ.	Gore	Dolje	Temperatura	Trajanje

Pomoć pri kuhanju - kuhanje s automatskim postavkama vremena i temperature.

Riba	Odrezak	Pileći bataci	Pile
Povrće	Pomfrit	Mini pizza	Muffini

2.2 Zaslون

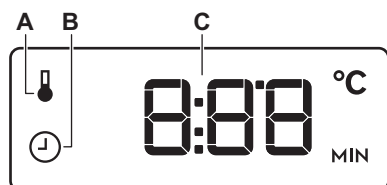

- A.** Postavka temperature
- B.** Postavka vremena
- C.** Vrijeme/temperatura

3. PRIJE PRVE UPOTREBE



Uklonite svu ambalažu, naljepnicu i zaštitnu foliju.



Očistite košaru i posudu toplom vodom, tekućinom za pranje i mekom krpom. Unutar i izvana osušite uređaj krpom.

4. SVAKODNEVNA UPORABA

4.1 Kako koristiti: plitica i košara

Postavite uređaj na stabilnu površinu.

1. Uklonite pliticu i stavite je na stabilnu površinu.
2. Uklonite zaštitni poklopac na sigurnosnoj bravi.
3. Pritisnite sigurnosnu bravu i uklonite košaru.

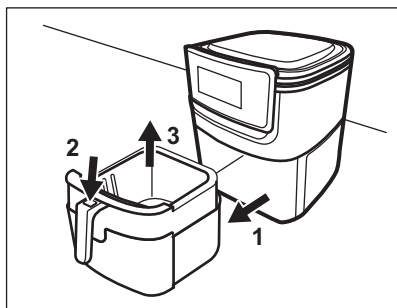

4. U košaru stavite hranu do maksimalne razine. Maksimalna zapremina kkošare je 2 kg.

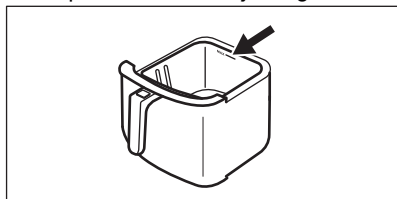

4.2 Kako kuhati

Stavite hranu u košaru. Ukopčajte utikač uređaja.

1. ① - pritisnite i držite.
2. Odaberite jela iz Pomoći pri kuhanju:

Simbol	Podesite
	140 °C 15 min
	200 °C 10 min
	180 °C 20 min
	180 °C 45 min
	170 °C 15 min
	180 °C 15 min
	180 °C 10 min
	180 °C 15 min

3. Pritisnite: ①.

Po isteku kuhanja oglašava se zvučni signal. Ventilator radi nekoliko sekundi.









Možete promijeniti postavke i isključiti uređaj tijekom kuhanja:







- Za promjenu programa, pritisnite simbol hrane.
- ^, v - pritisnite za podešavanje postavke vremena ili temperature.
- ① - pritisnite i držite nekoliko sekundi za isključenje uređaja.

Iskopčajte uređaj iz napajanja i pričekajte da se ohladi. Očistite pliticu i košaru.

5. SAVJETI ZA KUHANJE

Temperature i vremena kuhanja u tablicama služe kao primjeri. Ovisi o receptima, kvaliteti i količini korištenih sastojaka.

	 (kg)	 (min)	 (°C)	
 Krumpiri i povrće				
Pomfrit, tanki, smrznuto	0.3 - 0.7	9 - 16	180	Protresite košaru
Pomfrit, debeli, smrznuto	0.3 - 0.7	11 - 20	180	Protresite košaru
Pomfrit (8 x 8 mm)	0.3 - 0.8	10 - 16	180	Protresite košaru / Dodajte 1/2 žlice ulja
Krumpirići, svježi	0.3 - 0.8	18 - 22	180	Protresite košaru / Dodajte 1/2 žlice ulja
Kockice krumpira	0.3 - 0.75	12 - 18	180	Protresite košaru / Dodajte 1/2 žlice ulja
Punjeno povrće	0.1 - 0.4	10	170	-
Povrće	0.1 - 0.4	10	170	-
 Meso i perad				
Odrezak	0.1 - 0.5	8 - 12	200	-
Svinjeći kotleti	0.1 - 0.5	10 - 14	200	-
Hamburgeri	0.1 - 0.5	7 - 14	200	-
Kobasice u tijestu	0.1 - 0.5	13 - 15	200	-
Pileći bataci	0.1 - 0.5	18 - 22	180	-
Pileća prsa	0.1 - 0.5	10 - 15	185	-
Pile	0.9 - 1.2	40 - 50	180	-
 Grickalice				
Proletne rollice, smrznute	0.1 - 0.4	8 - 10	200	Protresite košaru
Pileći medaljoni, smrznuto	0.1 - 0.5	6 - 10	200	Protresite košaru
Riblji štapići, smrznuto	0.1 - 0.4	6 - 10	200	-

	 (kg)	 (min)	 (°C)	
Panirani prutići od sira, smrznuti	0.1 - 0.4	8 - 10	180	-
 Pečenje				
Kolači	0.3	20 - 25	165	Koristite lim za pečenje
Quiche	0.4	20 - 22	185	Koristite lim za pečenje / posudu za pećnicu
Muffini	0.3	15 - 18	200	Koristite lim za pečenje

6. NAPOMENE O ČIŠĆENJU

	Sredstva za čišćenje i dodaci	Svakodnevna uporaba
	Očistite plitvicu i košaru spužvom namočenom u mlaku sapunicu. Plitica i košara sigurne su za pranje u perilici posuđa. Grijač očistite četkom za čišćenje. Vanjsku stranu uređaja očistite mekom krpom.	Prije čišćenja iskopčajte uređaj iz napajanja i pričekajte da se ohladi. Očistite uređaj nakon svake upotrebe.

7. ŠTO UČINITI AKO...

Problem	Provjerite...
Ne možete uključiti uređaj ili rukovati njime.	<ul style="list-style-type: none"> • Uređaj je pravilno priključen na električno napajanje. • Vrijeme pripreme jela je postavljeno.
Ne možete umetnuti plitvicu u uređaj.	<ul style="list-style-type: none"> • Košara nije napunjena do maksimalnog kapaciteta. • Košara je pravilno postavljena. Mora kliknuti kada je stavite u plitvicu.
Iz uređaja izlazi bijeli dim.	<ul style="list-style-type: none"> • Hrana koju pripremate nije masna. • Plitica i košara su čiste.

8. TEHNIČKI PODACI

8.1 Tehnički podaci

Napon	220 - 240 V
Frekvencija	50 - 60 Hz

1. CELKOVÝ POHLED

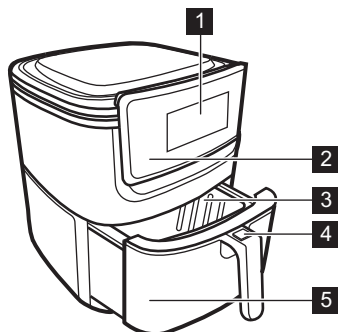

- 1** Displej
- 2** Ovládací panel
- 3** Koš
- 4** Bezpečnostní pojistka s ochranným krytem
- 5** Pekáč

2. OVLÁDACÍ PANEL

2.1 Ovládací panel

Seznamte se se základními symboly na ovládacím panelu a displeji.

ZAP/VYP	Nahoru	Dolů	Teplota	Trvání

Podporované vaření - příprava s automatickým nastavením času a teploty.

Ryby	Steak	Kuřecí stehna	Kuře
Zelenina	Hranolky	Mini pizza	Muffin

2.2 Displej

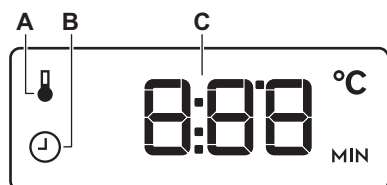

- A.** Nastavení teploty
- B.** Nastavení času
- C.** Čas / teplota

3. PŘED PRVNÍM POUŽITÍM



Odstraňte veškerý obalový materiál, štítky a ochrannou fólii.



Koš a pekáč umyjte teplou vodou s mycím prostředkem a pomocí měkkého hadříku.

Vnitřek i vnějšek spotřebiče osušte pomocí hadříku.

4. DENNÍ POUŽÍVÁNÍ

4.1 Jak používat: pekáč a koš

Spotřebič položte na stabilní povrch.

1. Vyjměte pekáč a položte ho na stabilní povrch.
2. Sejměte ochranný kryt na bezpečnostní pojistce.
3. Stiskněte bezpečnostní pojistku a vyjměte koš.

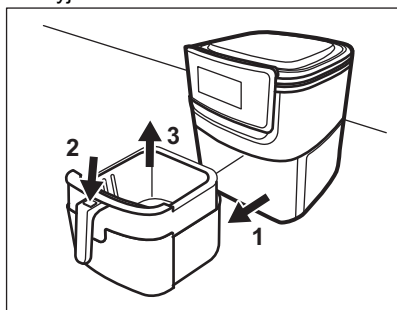

4. Vložte potraviny do koše až po maximální úroveň. Maximální kapacita koše je 2 kg.

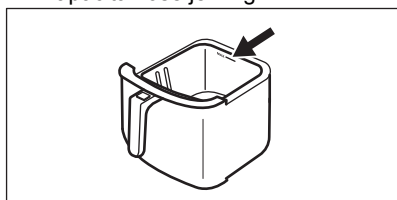

4.2 Příprava pokrmů

Vložte potraviny do koše. Zapojte spotřebič do zásuvky.

1. - stiskněte a podržte.
2. Zvolte pokrm z nabídky Podporované vaření:

Symbol	Nastavení
	140 °C 15 min
	200 °C 10 min
	180 °C 20 min
	180 °C 45 min
	170 °C 15 min
	180 °C 15 min
	180 °C 10 min
	180 °C 15 min

3. Stiskněte: .

Po dokončení přípravy zazní zvukový signál. Několik sekund pracuje chladicí ventilátor.









Během přípravy můžete změnit nastavení a vypnout spotřebič:







- Program změňte stisknutím symbolu pokrmu.
- , - stisknutím upravíte nastavení času nebo teploty.
- - stisknutím a podržením na několik sekund vypnete spotřebič.

Odpojte spotřebič od síťového napájení a vyčkejte, dokud nevychladne. Umyjte pekáč a koš.

5. TIPY PRO PŘÍPRAVU

Teploty a časy přípravy v tabulkách jsou pouze orientační. Závisí na receptu, kvalitě a množství použitých přísad.

	 (kg)	 (min)	 (°C)	
 Brambory a zelenina				
Hranolky, tenké, zmrazené	0.3 - 0.7	9 - 16	180	Zatřeste košem
Hranolky, silné, zmrazené	0.3 - 0.7	11 - 20	180	Zatřeste košem
Hranolky (8 x 8 mm)	0.3 - 0.8	10 - 16	180	Zatřeste košem / přidejte půl lžice oleje
Americké brambory, čerstvé	0.3 - 0.8	18 - 22	180	Zatřeste košem / přidejte půl lžice oleje
Brambory na kostky	0.3 - 0.75	12 - 18	180	Zatřeste košem / přidejte půl lžice oleje
Plněná zelenina	0.1 - 0.4	10	170	-
Zelenina	0.1 - 0.4	10	170	-
 Maso a drůbež				
Steak	0.1 - 0.5	8 - 12	200	-
Vepřové kotlety	0.1 - 0.5	10 - 14	200	-
Hamburgery	0.1 - 0.5	7 - 14	200	-
Klobásy v těstíčku	0.1 - 0.5	13 - 15	200	-
Kuřecí stehna	0.1 - 0.5	18 - 22	180	-
Kuřecí prsa	0.1 - 0.5	10 - 15	185	-
Kuře	0.9 - 1.2	40 - 50	180	-
 Snack				
Jarní závitky, mražené	0.1 - 0.4	8 - 10	200	Zatřeste košem
Kuřecí nugety, zmrazené	0.1 - 0.5	6 - 10	200	Zatřeste košem
Rybí prsty, zmrazené	0.1 - 0.4	6 - 10	200	-

	 (kg)	 (min)	 (°C)	
Sýrový snack se strouhankou, zmrazený	0.1 - 0.4	8 - 10	180	-
 Pečení moučných jídel				
Koláče	0.3	20 - 25	165	Použijte formu na pečení
Slaný koláč	0.4	20 - 22	185	Použijte formu na pečení / nádobu do trouby
Muffin	0.3	15 - 18	200	Použijte formu na pečení

6. POZNÁMKY K ČIŠTĚNÍ

	Čisticí prostředky a příslušenství	Každodenní použití
	<p>Pekáč a koš umyjte měkkou houbičkou namočenou v roztoku teplé vody a mycího prostředku.</p> <p>Pekáč a koš lze bezpečně mýt v myčce nádobí.</p> <p>Topné těleso očistěte kartáčkem.</p> <p>Vnější část spotřebiče očistěte měkkým hadříkem.</p>	<p>Před čištěním spotřebič odpojte od síťového napájení a vyčkejte, dokud nevychladne.</p> <p>Spotřebič čistěte po každém použití.</p>

7. CO DĚLAT, KDYŽ...

Problém	Zkontrolujte, zda...
Spotřebič nelze zapnout ani používat.	<ul style="list-style-type: none"> Spotřebič je správně zapojený do elektrické sítě. Je nastavený čas přípravy.
Nelze zasunout pekáč do spotřebiče.	<ul style="list-style-type: none"> Koš není naplněn nad maximální úroveň. Koš je umístěn správně. Když ho vložíte do pekáče, musí zaklapnout.
Ze spotřebiče nevychází bílý kouř.	<ul style="list-style-type: none"> Připravené pokrmy nejsou mastné. Pekáč a koš jsou čisté.

8. TECHNICKÉ ÚDAJE

8.1 Technické údaje

Napětí	220 - 240 V
Frekvence	50 - 60 Hz

1. OVERSIGT OVER APPARATET

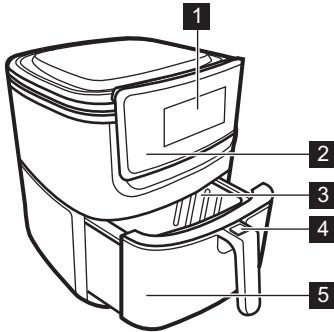

- 1** Display
- 2** Kontrolpanel
- 3** Kurv
- 4** Sikkerhedslås med beskyttelsesdæksel
- 5** Form

2. BETJENINGSPANEL

2.1 Kontrolpanel

Gør dig bekendt med de grundlæggende symboler på kontrolpanelet og displayet.

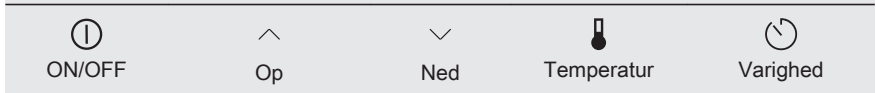

Hjælp til tilberedning - tilbered med automatiske tids- og temperaturindstillinger.

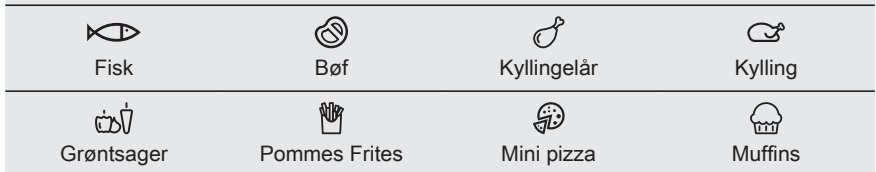

2.2 Display

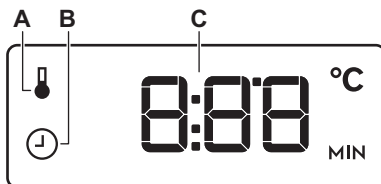

- A.** Temperaturindstilling
- B.** Tidsindstilling
- C.** Tid / temperatur

3. FØR FØRSTE ANVENDELSE



Fjern al emballagen, mærkningen og den beskyttende film.



Rengør kurven og formen med varmt vand, opvaskemiddel og en blød klud.
Tør apparatets inder- og yderside med en klud.

4. DAGLIG BRUG

4.1 Anvendelse: form og kurv

Placer apparatet på en stabil overflade.

1. Fjern formen og placer den på en stabil overflade.
2. Fjern beskyttelsesdækslet på sikkerhedslåsen.
3. Tryk på sikkerhedslåsen for at fjerne kurven.

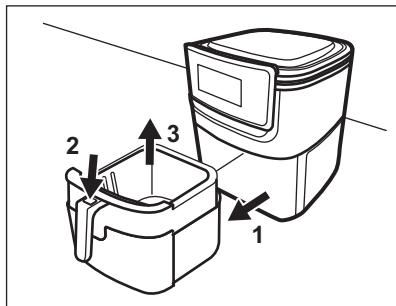

4. Læg maden i kurven op til det maksimale niveau. Kurvens maksimale kapacitet er 2 kg.

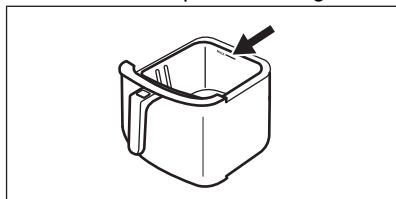

4.2 Madlavning

Læg maden i kurven. Sæt stikket til apparatet i stikkontakten.

1. - tryk og hold.
2. Vælg retten fra Hjælp til tilberedning:

Symbol	Indstilling
	140°C 15 min
	200°C 10 min
	180°C 20 min
	180°C 45 min
	170°C 15 min
	180°C 15 min
	180°C 10 min
	180°C 15 min

3. Tryk på: .

Når tilberedningen ender, udsendes signalet. Køleblæseren virker i få sekunder.









Du kan ændre indstillingerne og slukke for apparatet under tilberedning:







- Tryk på madsymbolet for at ændre programmet.
- , - tryk for at justere tid- eller temperaturindstillinger.
- - tryk og hold nede i nogle få sekunder for at slukke for apparatet.

Træk apparatets stik ud, og vent til det er koldt. Rengør formen og kurven.

5. TIPS TIL MADLAVNING

Tabellernes temperaturer og tilberedningstider er kun vejledende. De afhænger af opskrifterne samt af kvaliteten og mængden af de anvendte ingredienser.

	 (kg)	 (min.)	 (°C)	
 Kartofler og grøntsager				
Pommes frites, tynde, frossen	0.3 - 0.7	9 - 16	180	Ryst kurven
Pommes frites, tykke, frossen	0.3 - 0.7	11 - 20	180	Ryst kurven
Pommes Frites(8 x 8 mm)	0.3 - 0.8	10 - 16	180	Ryst kurven / Tilsæt 1/2 spsk. olie
Kartoffelbåde, friske	0.3 - 0.8	18 - 22	180	Ryst kurven / Tilsæt 1/2 spsk. olie
Kartoffeltern	0.3 - 0.75	12 - 18	180	Ryst kurven / Tilsæt 1/2 spsk. olie
Fyldte grøntsager	0.1 - 0.4	10	170	-
Grøntsager	0.1 - 0.4	10	170	-
 Kød og fjerkræ				
Bøf	0.1 - 0.5	8 - 12	200	-
Svinekotelet	0.1 - 0.5	10 - 14	200	-
Hamburger	0.1 - 0.5	7 - 14	200	-
Pølsehorn	0.1 - 0.5	13 - 15	200	-
Kyllingelår	0.1 - 0.5	18 - 22	180	-
Kyllingebryst	0.1 - 0.5	10 - 15	185	-
Kylling	0.9 - 1.2	40 - 50	180	-
 Snacks				
Forårssruller, frosne	0.1 - 0.4	8 - 10	200	Ryst kurven
Kyllingenuggets, frossen	0.1 - 0.5	6 - 10	200	Ryst kurven
Fiskepinde, frossen	0.1 - 0.4	6 - 10	200	-

	 (kg)	 (min.)	 (°C)	
Panerede ostesnacks, frosne	0.1 - 0.4	8 - 10	180	-
 Bagning				
Kager	0.3	20 - 25	165	Brug en bradepande.
Quiche	0.4	20 - 22	185	Brug en bageform/ovnfad
Muffins	0.3	15 - 18	200	Brug en bradepande.

6. BEMÆRKNINGER OM RENGØRING

	Rengøringsmidler og tilbehør	Hverdagsbrug
	<p>Rengør formen og kurven med en blød svamp med varmt vand og opvaskemiddel. Formen og kurven kan kommes i opvaskemaskine.</p> <p>Rengør varmelegemet med en rengøringsbørste.</p> <p>Aftør apparatets yderside med en blød klud.</p>	<p>Træk apparatets stik ud, og vent til det er koldt, inden rengøring.</p> <p>Rengør altid apparatet efter brug.</p>

7. HVIS NOGET GÅR GALT

Problem	Kontroller, at ...
Apparatet kan ikke tændes eller betjenes.	<ul style="list-style-type: none"> Apparatet er sluttet korrekt til en strømforsyning. Tilberedningstiden er indstillet.
Du kan ikke skubbe formen ind i apparatet.	<ul style="list-style-type: none"> Kurven er ikke fyldt op over dens maksimale kapacitet. Kurven er placeret korrekt. Den skal klikke, når du placerer den i formen.
Der kommer hvid røg ud af apparatet.	<ul style="list-style-type: none"> Den mad, du tilbereder, er ikke fedtet. Formen og kurven er rene.

8. TEKNISKE DATA

8.1 Tekniske data

Spænding	220 - 240 V
Hyppighed	50 - 60 Hz



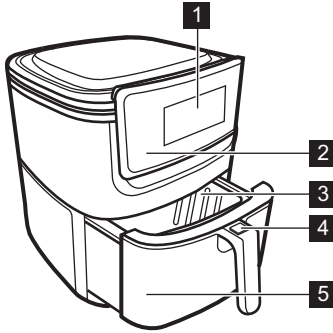









1. GENERAL OVERVIEW



- 1** Display
- 2** Control panel
- 3** Basket
- 4** Safety lock with protection cover
- 5** Pan

2. CONTROL PANEL

2.1 Control panel

Familiarize yourself with the basic icons on the control panel and on the display.				
 ON / OFF	 Up	 Down	 Temperature	 Duration
Assisted Cooking - cook with automatic time and temperature settings.				
 Fish	 Steak	 Chicken drumsticks	 Chicken	
 Vegetables	 French fries	 Mini pizza	 Muffins	

2.2 Display

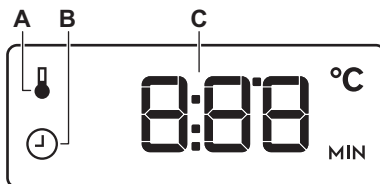

- A.** Temperature setting
- B.** Time setting
- C.** Time / temperature

3. BEFORE FIRST USE



Remove all the packaging, labelling and protective film.



Clean the basket and the pan with warm water, washing-up liquid and a soft cloth. Dry inside and outside of the appliance with a cloth.

4. DAILY USE

4.1 How to use: pan and basket

Place the appliance on the stable surface.

1. Remove the pan and place it on a stable surface.
2. Remove the protection cover on the safety lock.
3. Press the safety lock to remove the basket.

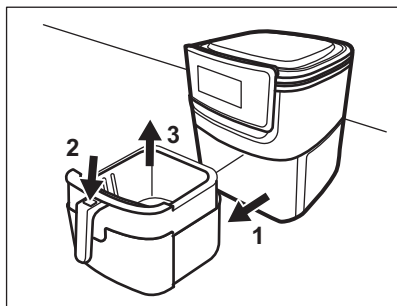

4. Put the food into the basket up to the maximum level. The maximum capacity of the basket is 2 kg.

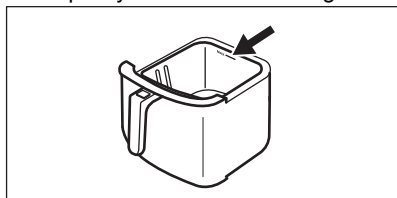

4.2 How to cook

Put the food into the basket. Plug in the appliance.

1. - press and hold.
2. Select the dish from Assisted cooking:

Symbol	Setting
	140°C 15 min
	200°C 10 min
	180°C 20 min
	180°C 45 min
	170°C 15 min
	180°C 15 min
	180°C 10 min
	180°C 15 min

3. Press: .

When the cooking ends the signal sounds. The cooling fan works for a few seconds.









You can change the settings and turn off the appliance during cooking:







- Press the food symbol to change the programme.
- , - press to adjust time or temperature settings.
- - press and hold for a few seconds to turn off the appliance.

Unplug the appliance and wait until it is cold. Clean the pan and the basket.

5. COOKING HINTS

The temperature and cooking times in the tables are guidelines only. They depend on the recipes and the quality and quantity of the ingredients used.

	 (kg)	 (min)	 (°C)	
 Potatoes and vegetables				
French fries, thin, frozen	0.3 - 0.7	9 - 16	180	Shake the basket
French fries, thick, frozen	0.3 - 0.7	11 - 20	180	Shake the basket
French fries (8 x 8 mm)	0.3 - 0.8	10 - 16	180	Shake the basket / Add 1/2 tablespoon of oil
Potato wedges, fresh	0.3 - 0.8	18 - 22	180	Shake the basket / Add 1/2 tablespoon of oil
Potato cubes	0.3 - 0.75	12 - 18	180	Shake the basket / Add 1/2 tablespoon of oil
Stuffed vegetables	0.1 - 0.4	10	170	-
Vegetables	0.1 - 0.4	10	170	-
 Meat and poultry				
Steak	0.1 - 0.5	8 - 12	200	-
Pork chops	0.1 - 0.5	10 - 14	200	-
Hamburger	0.1 - 0.5	7 - 14	200	-
Sausage rolls	0.1 - 0.5	13 - 15	200	-
Chicken drumsticks	0.1 - 0.5	18 - 22	180	-
Chicken breast	0.1 - 0.5	10 - 15	185	-
Chicken	0.9 - 1.2	40 - 50	180	-
 Snacks				
Spring rolls, frozen	0.1 - 0.4	8 - 10	200	Shake the basket
Chicken nuggets, frozen	0.1 - 0.5	6 - 10	200	Shake the basket
Fish fingers, frozen	0.1 - 0.4	6 - 10	200	-

	 (kg)	 (min)	 (°C)	
Bread crumbed cheese snacks, frozen	0.1 - 0.4	8 - 10	180	-
 Baking				
Cakes	0.3	20 - 25	165	Use a baking tin
Quiche	0.4	20 - 22	185	Use a baking tin / oven dish
Muffins	0.3	15 - 18	200	Use a baking tin

6. NOTES ON CLEANING

	Cleaning agents and accessories	Everyday use
	<p>Clean the pan and the basket with a soft sponge with warm water and a washing-up liquid.</p> <p>The pan and the basket are dishwasher-safe.</p> <p>Clean the heating element with a cleaning brush.</p> <p>Clean the outside of the appliance with a soft cloth.</p>	<p>Before cleaning unplug the appliance and wait until it is cold.</p> <p>Clean the appliance after each use.</p>

7. WHAT TO DO IF...

Problem	Check if...
You cannot activate or operate the appliance.	<ul style="list-style-type: none"> The appliance is correctly connected to an electrical supply. The cooking time is set.
You cannot slide the pan into the appliance.	<ul style="list-style-type: none"> The basket is not filled over its maximum capacity. The basket is placed correctly. It has to click when you place it in the pan.
White smoke comes out of the appliance.	<ul style="list-style-type: none"> The food you prepare is not greasy. The pan and the basket are clean.

8. TECHNICAL DATA

8.1 Technical data

Voltage	220 - 240 V
Frequency	50 - 60 Hz



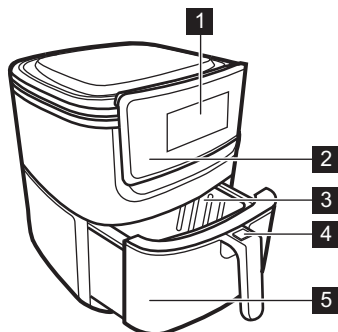









1. ÜLEVAADE



- 1** Ekraan
- 2** Juhtpaneel
- 3** Korv
- 4** Turvalukk koos kaitsekattega
- 5** Pann

2. JUHTPANEEL

2.1 Juhtpaneel

Jätke meelde juhtpaneelil ja ekraanil olevad põhiikoonid.				
				
SISSE/VÄLJA	Üles	Alla	Temperatuur	Kestus
Juhendatud küpsetamine – küpsetage automaatsete aja- ja temperatuuriseadetega.				
				
Kala	Steik	Kanakoivad	Kanaliha	
				
Köögiviljad	Friikartulid	Minipitsa	Muffinid	

2.2 Ekraan

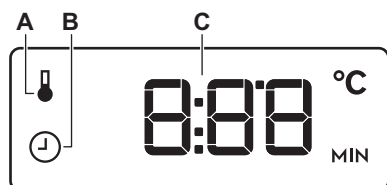

- A.** Temperatuuriseade
- B.** Ajaseade
- C.** Aeg / temperatuur

3. ENNE ESMAKORDSET KASUTAMIST



Eemaldage kogu pakend, sildid ja kaitsekile.



Puhastage korvi ja panni sooja vee, nõudepesuvahendi ja pehme lapiga. Kuivatage seade seest ja väljast pehme lapiga.

4. IGAPÄEVANE KASUTAMINE

4.1 Kuidas kasutada: panni ja korvi

Asetage seade kindlale alusele.

1. Eemaldage pann ja pange see kindlale alusele.
2. Eemaldage turvaluku kaitsekate.
3. Korvi eemaldamiseks vajutage turvalukku.

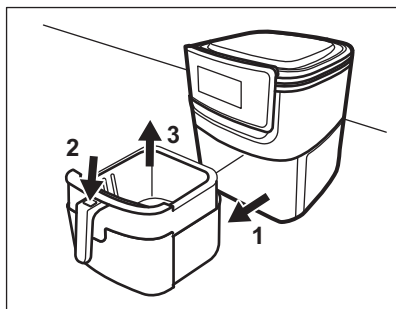

4. Pange toit korvi kuni maksimaalse tähiseni. Korvi maksimaalne mahutavus on 2 kg.

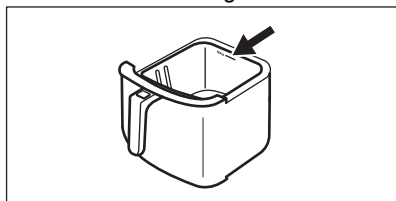

4.2 Küpsetamine

Pange toit korvi. Lülitage seade sisse.

1. – vajutage ja hoidke all.
2. Valige toit jaotisest Juhendatud küpsetamine:

Sümbol	Seade
	140°C 15 min
	200°C 10 min
	180°C 20 min
	180°C 45 min
	170°C 15 min
	180°C 15 min
	180°C 10 min
	180°C 15 min

3. Vajutage: .

Kui küpsetamine lõpeb, kostab helisignaali. Mõni minut töötab jahutusventilaator.









Küpsetamise ajal võite seadeid muuta ja seadme välja lülitada:







- Vajutage toidu sümbolit, et muuta programmi.
- , – vajutage, et muuta aega või temperatuuriseadeid.
- – vajutage ja hoidke paar sekundit, et seade välja lülitada.

Eemaldage seade vooluvõrgust ja laske maha jahtuda. Puhastage pann ja korv.

5. NÕUANDED VALMISTAMISEKS

Tabelites esitatud temperatuurid ja küpsetusajad on ainult soovituslikud. Täpsemalt sõltuvad need retseptist ning kasutatava tooraine kvaliteedist ja kogustest.

	 (kg)	 (min)	 (°C)	
 Kartulid ja juurviljad				
Friikartulid, õhukesed, külmutatud	0.3 - 0.7	9 - 16	180	Raputage korvi
Friikartulid, paksud, külmutatud	0.3 - 0.7	11 - 20	180	Raputage korvi
Friikartulid (8 x 8 mm)	0.3 - 0.8	10 - 16	180	Raputage korvi / lisage 1/2 spl õli
Kartuliviilud, värsked	0.3 - 0.8	18 - 22	180	Raputage korvi / lisage 1/2 spl õli
Kartulikuubikud	0.3 - 0.75	12 - 18	180	Raputage korvi / lisage 1/2 spl õli
Täidetud köögiviljad	0.1 - 0.4	10	170	-
Köögiviljad	0.1 - 0.4	10	170	-
 Liha ja linnuliha				
Steik	0.1 - 0.5	8 - 12	200	-
Seakarbonaad	0.1 - 0.5	10 - 14	200	-
Hamburger	0.1 - 0.5	7 - 14	200	-
Viineripirukad	0.1 - 0.5	13 - 15	200	-
Kanakoivad	0.1 - 0.5	18 - 22	180	-
Kanarind	0.1 - 0.5	10 - 15	185	-
Kanaliha	0.9 - 1.2	40 - 50	180	-
 Suupisted				
Kevadrullid, külmutatud	0.1 - 0.4	8 - 10	200	Raputage korvi
Kananagitsad, külmutatud	0.1 - 0.5	6 - 10	200	Raputage korvi
Kalapulgad, külmutatud	0.1 - 0.4	6 - 10	200	-

	 (kg)	 (min)	 (°C)	
Paneeritud juustupalad, külmutatud	0.1 - 0.4	8 - 10	180	-
 Küpsetamine				
Koogid	0.3	20 - 25	165	Kasutage küpsetusvormi
Quiche	0.4	20 - 22	185	Kasutage küpsetusvormi / ahjunõud
Muffinid	0.3	15 - 18	200	Kasutage küpsetusvormi

6. JUHISED PUHASTAMISEKS

	Puhastusvahendid ja tarvikud	Igapäevane kasutamine
	<p>Puhastage panni ja korvi pehme käsna või lapiga ning sooja vee ja nõudepesuvahendi lahusega.</p> <p>Panni ja korvi võib pesta nõudepesumasinas. Kütteelementi tuleb puhastada puhastusharjaga.</p> <p>Puhastage seadme välispinda pehme lapiga.</p>	<p>Enne puhastamist eemaldage seade vooluvõrgust ja laske maha jahtuda.</p> <p>Puhastage seadet pärast igakordset kasutamist.</p>

7. MIDA TEHA, KUI...

Probleem	Kontrollige, kas:
Seadet ei saa käivitada või kasutada.	<ul style="list-style-type: none"> Seade on elektrivõrku õigesti ühendatud. Küpsetusaeg on valitud.
Panni ei õnnestu seadmesse libistada.	<ul style="list-style-type: none"> Korv ei ole täidetud üle maksimaalse tähise. Korv on paigutatud õigesti. Panni sisse asetamisel peab kostma klõpsatus.
Seadmest tuleb valget suitsu.	<ul style="list-style-type: none"> Valmistatav toit ei ole rasvane. Pann ja korv on puhtad.

8. TEHNILISED ANDMED

8.1 Tehnilised andmed

Pinge	220 - 240 V
Sagedus	50 - 60 Hz

1. LAITTEEN OSAT

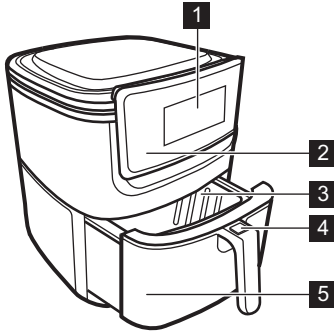

- 1 Näyttö
- 2 Käyttöpaneeli
- 3 Kori
- 4 Turvalukitus suojakannella
- 5 Pannu









2. KÄYTTÖPANEELI

2.1 Käyttöpaneeli

Tutustu käyttöpaneelin ja näytön peruskuvakkeisiin.

			
PÄÄLLE/POIS	Ylös	Alas	Lämpötila
			Kestoaika

Avustava ruoanvalmistus - valmista ruokaa automaattisilla aika- ja lämpötila-asetuksilla.

			
Kala	Pihvit	Broilerin koivet	Kana
			
Vihannekset	Ranskalaiset perunat	Minipizza	Muffinssit

2.2 Näyttö

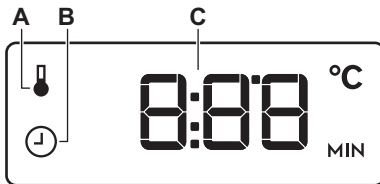

- A. Lämpötila-asetus
- B. Ajan asettaminen
- C. Aika/lämpötila

3. KÄYTTÖNOTTO



Poista kaikki pakkausmateriaalit, merkit ja suojakalvot.



Pese kori ja pannu lämpimällä vedellä käyttäen käsitiskiainetta ja pehmeää liinaa. Kuivaa laitteen sisä- ja ulkopuoli liinalla.

4. PÄIVITTÄINEN KÄYTTÖ

4.1 Käyttöohjeet: pannu ja kori

Aseta laite vakaan alustan päälle.

1. Poista pannu ja aseta se vakaalle alustalle.
2. Poista turvalukituksen suojakansi.
3. Paina kori painamalla turvalukitusta.

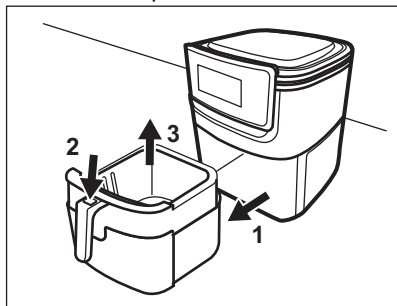

4. Lisää elintarvikkeet koriin korkeintaan maksimitasoon saakka. Korin maksimitilavuus on 2 kg.

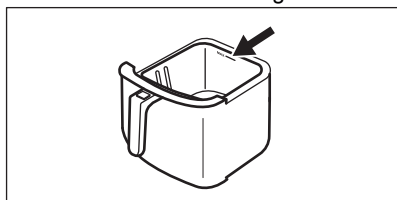

4.2 Ruoan valmistaminen

Aseta ruoka-ainekset koriin. Kytke laite sähköverkkoon.

1. - paina ja pidä alhaalla.
2. Valitse ruoka Avustava ruoanvalmistus -valikosta:

Symboli	Asetus
	140 °C 15 min
	200 °C 10 min
	180 °C 20 min
	180 °C 45 min
	170 °C 15 min
	180 °C 15 min
	180 °C 10 min
	180 °C 15 min

3. Paina: .

Kun kypsennys päättyy, laitteesta kuuluu äänimerkki. Jäähdytyspuhallin toimii muutaman sekunnin ajan.

Asetuksia voidaan muuttaa ja laite voidaan kytkeä pois päältä ruoanlaiton aikana:









- Vaihda ohjelmaa painamalla ruoan symbolia.
- , - säädä aikaa tai lämpötila-asetuksia painamalla.







- ⓘ - kytke laite pois päältä painamalla ja pitämällä alhaalla muutaman sekunnin ajan.

Irrota laite pistorasiasta ja odota, että se jäähtyy. Puhdista pannu ja kori.

5. RUOANLAITTOVINKIT

Taulukoissa mainitut lämpötilat ja paistoaajat ovat ainoastaan suuntaa antavia. Lämpötila ja paistoaika riippuvat reseptistä sekä käytettyjen aineiden laadusta ja määrästä.

	 (kg)	 (min)	 (°C)	
 Perunat ja vihannekset				
Ranskalaiset, ohuet, pakasteet	0,3 - 0,7	9 - 16	180	Ravista koria
Ranskalaiset, paksut, pakasteet	0,3 - 0,7	11 - 20	180	Ravista koria
Ranskalaiset perunat (8 x 8 mm)	0,3 - 0,8	10 - 16	180	Ravista koria / lisää 1/2 rkl öljyä
Lohkoperunat, tuoreet	0,3 - 0,8	18 - 22	180	Ravista koria / lisää 1/2 rkl öljyä
Perunakuutiot	0,3 - 0,75	12 - 18	180	Ravista koria / lisää 1/2 rkl öljyä
Täytetyt vihannekset	0,1 - 0,4	10	170	-
Vihannekset	0,1 - 0,4	10	170	-
 Liha ja linnunliha				
Pihvit	0,1 - 0,5	8 - 12	200	-
Porsaankyljykset	0,1 - 0,5	10 - 14	200	-
Jauhelihapihvi	0,1 - 0,5	7 - 14	200	-
Makkararullat	0,1 - 0,5	13 - 15	200	-
Broilerin koivet	0,1 - 0,5	18 - 22	180	-
Kanan rintafilee	0,1 - 0,5	10 - 15	185	-
Kana	0,9 - 1,2	40 - 50	180	-
 Välipalat				
Kevätkääryleet, pakastetut	0,1 - 0,4	8 - 10	200	Ravista koria
Kananugetit, pakasteet	0,1 - 0,5	6 - 10	200	Ravista koria
Kalapuikot, pakasteet	0,1 - 0,4	6 - 10	200	-

	 (kg)	 (min)	 (°C)	
Paneroidut juustovälipalat, pakaste	0,1 - 0,4	8 - 10	180	-
 Leivonnaisten paistaminen				
Kakut	0,3	20 - 25	165	Käytä uunivuokaa
Piirakka	0,4	20 - 22	185	Käytä uunivuokaa
Muffinssit	0,3	15 - 18	200	Käytä uunivuokaa

6. PUHDISTUKSEEN LIITTYVIÄ HUOMAUTUKSIA

	Puhdistusaineet ja lisävarusteet	Jokapäiväinen käyttö
	<p>Puhdista pannu ja kori lämpimällä vedellä ja käsitiskiaineella käyttäen pehmeää sientä. Pannu ja kori voidaan pestä astianpesukoneessa.</p> <p>Puhdista lämpövastus harjalla.</p> <p>Puhdista laitteen ulkopuoli pehmeällä liinalla.</p>	<p>Irrota laite pistorasiasta ennen sen puhdistamista ja odota, että se jäähtyy.</p> <p>Puhdista keittotasoa jokaisen käytön jälkeen.</p>

7. KÄYTTÖHÄIRIÖT

Ongelma	Tarkista, että
Laite ei kytkeydy toimintaan eikä sitä voida käyttää.	<ul style="list-style-type: none"> Laite on kytketty virheettömästi sähköverkkoon. Kypsennusaika on asetettu.
Pannua ei voida liu'uttaa laitteeseen.	<ul style="list-style-type: none"> Koria ei ole täytetty liian täyteen. Kori on asetettu oikein. Se napsahtaa, kun se asetetaan pannuun.
Laitteesta tulee vaaleaa savua.	<ul style="list-style-type: none"> Valmistettava ruoka ei ole rasvaista. Pannu ja kori ovat puhtaita.

8. TEKNISET TIEDOT

8.1 Tekniset tiedot

Jännite	220 - 240 V
Taajuus	50 - 60 Hz

1. PRÉSENTATION GÉNÉRALE

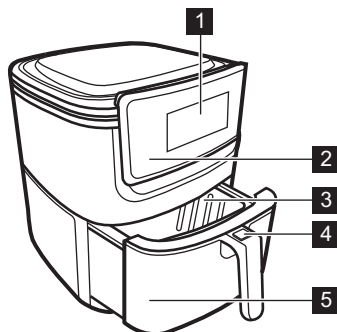

- 1** Affichage
- 2** Bandeau de commande
- 3** Panier
- 4** Verrouillage de sécurité avec couvercle de protection
- 5** Plat

2. BANDEAU DE COMMANDE

2.1 Bandeau de commande

Familiarisez-vous avec les symboles de base du bandeau de commande et de l'affichage :

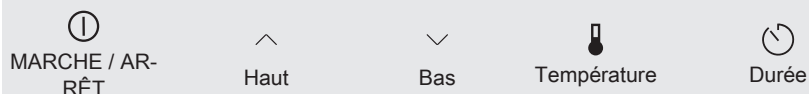

Cuisson assistée - faites cuire avec les réglages automatiques de durée et de température.

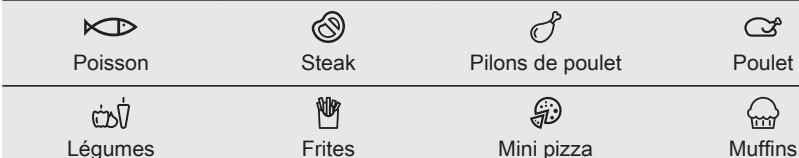

2.2 Affichage

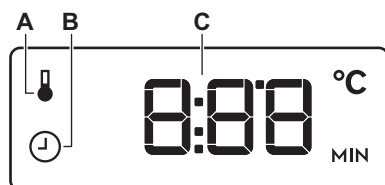

- A.** Réglage de température
- B.** Réglage de l'heure
- C.** Durée / Température

3. AVANT LA PREMIÈRE UTILISATION



Retirez les emballages, les étiquettes et les films de protection.



Nettoyez le panier et le plat avec de l'eau chaude, du liquide vaisselle et un chiffon doux.

Séchez l'intérieur et l'extérieur de l'appareil avec un chiffon.

4. UTILISATION QUOTIDIENNE

4.1 Comment utiliser : plat et panier

Placez l'appareil sur une surface stable.

1. Sortez le plat et placez-le sur une surface stable.
2. Retirez le couvercle de protection sur le verrouillage de sécurité.
3. Appuyez sur le verrouillage de sécurité pour retirer le panier.

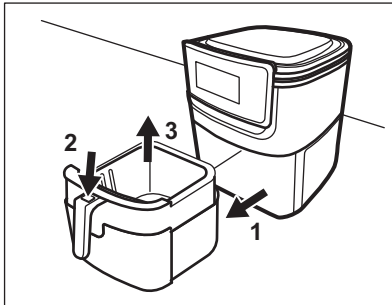

4. Placez les aliments dans le panier jusqu'au niveau maximum. Le panier a une capacité maximale de 2 kg.

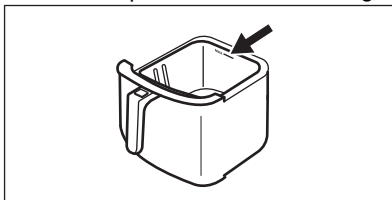

4.2 Comment cuire

Placez les aliments dans le panier. Branchez l'appareil.

1. - appuyez et maintenez enfoncé.
2. Sélectionnez le plat dans Cuisson assistée :

Symbole	Réglage
	140 °C 15 min
	200 °C 10 min
	180 °C 20 min
	180 °C 45 min
	170 °C 15 min
	180 °C 15 min
	180 °C 10 min
	180 °C 15 min

3. Appuyez sur : .

Lorsque la cuisson est terminée, un signal sonore retentit. Le ventilateur de refroidissement fonctionne pendant quelques secondes.

Vous pouvez modifier les réglages et éteindre l'appareil pendant la cuisson :









- Appuyez sur le symbole de l'aliment pour changer le programme.
- , - appuyez pour ajuster les réglages de durée ou de température.







-  - appuyez et maintenez enfoncé pendant quelques secondes pour éteindre l'appareil.

Débranchez l'appareil et attendez qu'il soit froid. Nettoyez le plat et le panier.

5. CONSEILS DE CUISSON

Les températures et temps de cuisson se trouvant dans les tableaux ne sont indiqués qu'à titre indicatif. Ils varient en fonction des recettes ainsi que de la qualité et de la quantité des ingrédients utilisés.

	 (kg)	 (min)	 (°C)	
 Pommes de terre et légumes				
Frites, fines, surgelé	0,3 - 0,7	9 - 16	180	Secouez le panier
Frites, épaisses, surgelé	0,3 - 0,7	11 - 20	180	Secouez le panier
Frites (8 x 8 mm)	0,3 - 0,8	10 - 16	180	Secouez le panier / Ajoutez 1/2 cuillères à soupe d'huile
Quartiers de pommes de terre, frais	0,3 - 0,8	18 - 22	180	Secouez le panier / Ajoutez 1/2 cuillères à soupe d'huile
Cubes de pommes de terre	0,3 - 0,75	12 - 18	180	Secouez le panier / Ajoutez 1/2 cuillères à soupe d'huile
Légumes farcis	0,1 - 0,4	10	170	-
Légumes	0,1 - 0,4	10	170	-
 Viande et volaille				
Steak	0,1 - 0,5	8 - 12	200	-
Côtelettes de porc	0,1 - 0,5	10 - 14	200	-
Steak haché	0,1 - 0,5	7 - 14	200	-
Roulés aux saucisses	0,1 - 0,5	13 - 15	200	-
Pilons de poulet	0,1 - 0,5	18 - 22	180	-
Blanc de poulet	0,1 - 0,5	10 - 15	185	-
Poulet	0,9 - 1,2	40 - 50	180	-
 En-cas				
Rouleaux de printemps, surgelés	0,1 - 0,4	8 - 10	200	Secouez le panier
Nuggets de poulet, surgelés	0,1 - 0,5	6 - 10	200	Secouez le panier

	 (kg)	 (min)	 (°C)	
Bâtonnets de poisson, surgelé	0,1 - 0,4	6 - 10	200	-
En-cas au fromage panés, surgelés	0,1 - 0,4	8 - 10	180	-
 Cuisson				
Gâteaux	0,3	20 - 25	165	Utilisez un moule à gâteaux.
Quiche	0,4	20 - 22	185	Utilisez un moule à gâteaux / plat allant au four
Muffins	0,3	15 - 18	200	Utilisez un moule à gâteaux.

6. REMARQUES CONCERNANT L'ENTRETIEN

	Produits de nettoyage et accessoires	Utilisation quotidienne
	<p>Nettoyez le plat et le panier avec à l'aide d'une éponge douce avec de l'eau chaude et du liquide vaisselle.</p> <p>Le plat et le panier peuvent passer au lave-vaisselle.</p> <p>Nettoyez l'élément chauffant avec une brosse de nettoyage.</p> <p>Nettoyez l'extérieur de l'appareil avec un chiffon doux.</p>	<p>Avant le nettoyage, débranchez l'appareil et attendez qu'il soit froid.</p> <p>Nettoyez l'appareil après chaque utilisation.</p>

7. QUE FAIRE SI...

Problème	Vérifiez si...
Vous ne pouvez pas mettre en fonctionnement l'appareil ni le faire fonctionner.	<ul style="list-style-type: none"> • L'appareil est correctement branché à la prise électrique. • La durée de cuisson est réglée
Vous ne pouvez pas faire coulisser le plat dans l'appareil.	<ul style="list-style-type: none"> • Le panier n'est pas rempli au-delà de sa capacité maximale. • Le panier est placé correctement. Il doit s'enclencher lorsque vous le placez dans le plat.
De la fumée blanche sort de l'appareil.	<ul style="list-style-type: none"> • Les aliments que vous préparez ne sont pas gras. • Le plat et le panier sont propres.

8. CARACTÉRISTIQUES TECHNIQUES

8.1 Caractéristiques techniques

Tension	220 - 240 V
Fréquence	50 - 60 Hz

1. GESAMTANSICHT

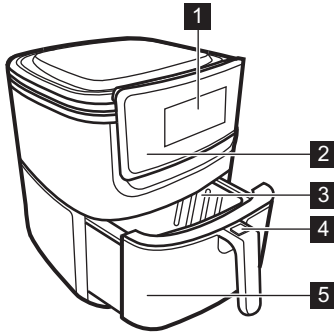

- 1** Display
- 2** Bedienfeld
- 3** Korb
- 4** Sicherheitsverriegelung mit Schutzabdeckung
- 5** Gar-Behälter

2. BEDIENFELD

2.1 Bedienfeld

Machen Sie sich mit den grundlegenden Symbolen auf dem Bedienfeld und auf dem Display vertraut.

ⓘ	^	v	🌡️	⌚
EIN/AUS	Nach oben	Nach unten	Temperatur	Dauer

Koch-Assistent - Kochen mit automatischen Zeit- und Temperatureinstellungen.

🐟	🥩	🍗	🍗
Fisch	Steak	Hähnchenunter-schenkel	Hähnchen
🥕	🍟	🍕	🍞
Gemüse	Pommes frites	Mini-Pizza	Muffins

2.2 Display

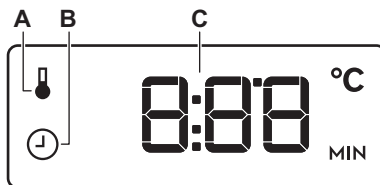

- A.** Temperatureinstellung
- B.** Zeiteinstellung
- C.** Zeit/Temperatur

3. VOR DER ERSTEN INBETRIEBNAHME



Entfernen Sie die gesamte Verpackung, Etiketten und Schutzfolie.



Feuchten Sie ein weiches Tuch mit warmem Wasser und etwas Spülmittel an und reinigen Sie damit den Korb und den Gar-Behälter.

Trocknen Sie das Gerät innen und außen mit einem Tuch ab.

4. TÄGLICHER GAR-BEHÄLTER

4.1 Verwendung: Gar-Behälter und Korb

Stellen Sie das Gerät auf eine stabile Oberfläche.

1. Nehmen Sie den Gar-Behälter heraus und stellen Sie ihn auf eine stabile Oberfläche.
2. Entfernen Sie die Schutzabdeckung und die Sicherheitsverriegelung.
3. Drücken Sie auf die Sicherheitsverriegelung, um den Korb zu entfernen.

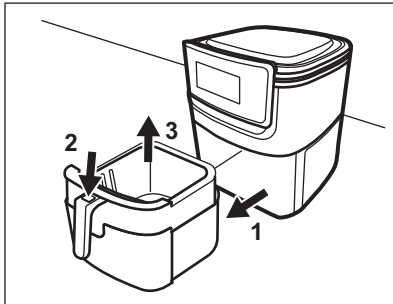



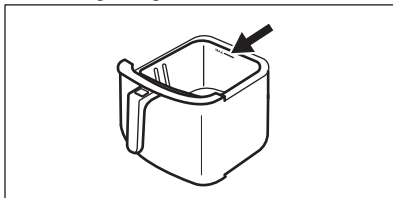





4. Füllen Sie die Zutaten in den Korb bis zur Höchstgrenze. Das maximale Fassungsvermögen des Korbs beträgt 2 kg.



4.2 So wird gekocht

Füllen Sie die Zutaten in den Korb. Stecken Sie den Netzstecker in die Steckdose.

1. Halten Sie  gedrückt.
2. Wählen Sie das Gericht im Koch-Assistenten:

Symbol	Einstellung
	140 °C 15 Min.
	200 °C 10 Min.
	180 °C 20 Min.
	180 °C 45 Min.
	170 °C 15 Min.
	180 °C 15 Min.
	180 °C 10 Min.
	180 °C 15 Min.

3. Drücken Sie: .

Nach Abschluss des Garvorgangs ertönt ein akustisches Signal. Das Kühlgebläse schaltet sich einige Sekunden ein.

Sie können die Einstellungen während des Garvorgangs ändern und das Gerät ausschalten:







- Drücken Sie auf das Speisensymbol, um das Programm zu ändern.
- Drücken Sie \wedge , \vee , um die Zeit- oder Temperatureinstellungen zu ändern.







- Halten Sie ⓪ einige Sekunden gedrückt, um das Gerät auszuschalten.

Ziehen Sie den Netzstecker und warten Sie, bis das Gerät kalt ist. Reinigen Sie den Gar-Behälter und den Korb.

5. GAREMPFEHLUNGEN

Die Temperaturen und Garzeiten in den Tabellen sind nur Richtwerte. Sie sind abhängig von den Rezepten, der Qualität und der Menge der verwendeten Zutaten.

	 (kg)	 (Min.)	 (°C)	
 Kartoffeln und Gemüse				
Pommes frites, dünn, gefroren	0.3 - 0.7	9 - 16	180	Schütteln Sie den Korb
Pommes frites, dick, gefroren	0.3 - 0.7	11 - 20	180	Schütteln Sie den Korb
Pommes frites (8 x 8 mm)	0.3 - 0.8	10 - 16	180	Schütteln Sie den Korb/Fügen Sie 1/2 Esslöffel Öl hinzu
Kartoffelspalten, frisch	0.3 - 0.8	18 - 22	180	Schütteln Sie den Korb/Fügen Sie 1/2 Esslöffel Öl hinzu
Kartoffelwürfel	0.3 - 0.75	12 - 18	180	Schütteln Sie den Korb/Fügen Sie 1/2 Esslöffel Öl hinzu
Gefülltes Gemüse	0.1 - 0.4	10	170	-
Gemüse	0.1 - 0.4	10	170	-
 Fleisch und Geflügel				
Steak	0.1 - 0.5	8 - 12	200	-
Schweinekoteletts	0.1 - 0.5	10 - 14	200	-
Hamburger	0.1 - 0.5	7 - 14	200	-
Würstchen im Teig	0.1 - 0.5	13 - 15	200	-
Hähnchenunterschenkel	0.1 - 0.5	18 - 22	180	-
Hähnchenbrust	0.1 - 0.5	10 - 15	185	-
Hähnchen	0.9 - 1.2	40 - 50	180	-

	 (kg)	 (Min.)	 (°C)	
 Snacks				
Frühlingsrollen, gefroren	0.1 - 0.4	8 - 10	200	Schütteln Sie den Korb
Chicken Nuggets, gefroren	0.1 - 0.5	6 - 10	200	Schütteln Sie den Korb
Fischstäbchen, gefroren	0.1 - 0.4	6 - 10	200	-
Panierte Käse-Snacks, gefroren	0.1 - 0.4	8 - 10	180	-
 Backen				
Kuchen	0.3	20 - 25	165	Verwenden Sie eine Backform
Quiche	0.4	20 - 22	185	Verwenden Sie eine Backform/Auflaufform
Muffins	0.3	15 - 18	200	Verwenden Sie eine Backform

6. HINWEISE ZUR REINIGUNG

 <p>Reinigungsmittel und Zubehör Feuchten Sie einen weichen Schwamm mit warmem Wasser und etwas Spülmittel an und reinigen Sie damit den Gar-Behälter und Korb. Der Gar-Behälter und der Korb sind spülmaschinenfest. Reinigen Sie das Heizelement mit einer Reinigungsbürste. Reinigen Sie die Außenseite des Geräts mit einem weichen Tuch.</p>	<p>Täglicher Gebrauch Ziehen Sie vor der Reinigung den Netzstecker und warten Sie, bis das Gerät kalt ist. Reinigen Sie das Gerät nach jedem Gebrauch.</p>
--	---

7. WAS TUN, WENN...

Störung	Prüfen Sie, ob...
Das Gerät kann nicht eingeschaltet oder bedient werden.	<ul style="list-style-type: none"> • Das Gerät ordnungsgemäß an die Spannungsversorgung angeschlossen ist. • Die Garzeit eingestellt ist.
Sie können den Gar-Behälter nicht in das Gerät schieben.	<ul style="list-style-type: none"> • Der Korb über sein maximales Fassungsvermögen gefüllt ist. • Der Korb richtig eingesetzt ist. Es muss klicken, wenn Sie ihn in den Gar-Behälter einsetzen.

Störung	Prüfen Sie, ob...
Weißer Rauch tritt aus dem Gerät aus.	<ul style="list-style-type: none">• Die von Ihnen zubereitete Speise fettig ist.• Der Gar-Behälter und der Korb sauber sind.

8. TECHNISCHE DATEN

8.1 Technische Daten

Spannung	220 - 240 V
Frequenz	50 - 60 Hz

1. ÁLTALÁNOS ÁTTEKINTÉS

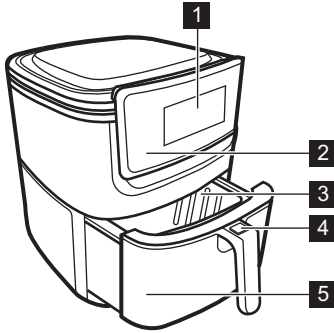

- 1 Kijelző
- 2 Kezelőpanel
- 3 Kosár
- 4 Biztonsági zár védőburkolattal
- 5 tepsi

2. KEZELŐPANEL

2.1 Kezelőpanel

Ismerkedjen meg a kezelőpanelen és a kijelzőn található alapvető ikonokkal.



Előre programozott sütés - főzés automatikus idő- és hőmérséklet-beállításokkal.

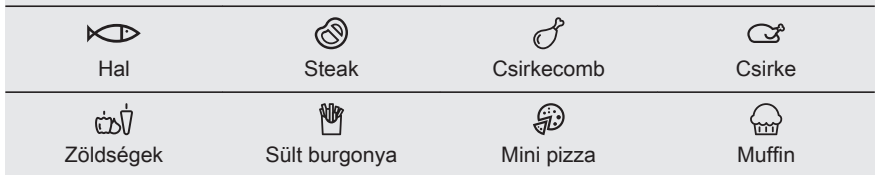

2.2 Kijelző

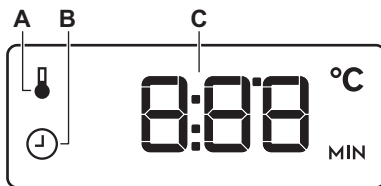

- A. Hőmérséklet-beállítás
- B. Időbeállítás
- C. Idő / hőmérséklet

3. AZ ELSŐ HASZNÁLAT ELŐTT



Távolítsa el az összes csomagolóanyagot, tájékoztató címkét és védőfóliát.



A kosarat és a tepsit tisztítószeres meleg vízzel megnedvesített puha ruhával tisztítsa meg.

A készülék belsejét és külsejét kendővel törölje szárazra.

4. NAPI HASZNÁLAT

4.1 Hogyan használja: tepsit és kosár

Helyezze a készüléket egy stabil felületre.

1. Távolítsa el a tepsit, és tegye egy stabil felületre.
2. Távolítsa el a védőburkolatot a biztonsági zárról.
3. A kosár eltávolításához nyomja meg a biztonsági zárat.

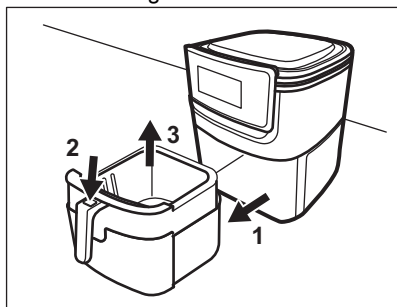

4. Töltse fel a kosarat az élelmiszerrel a maximális szintig. A kosár maximális űrtartalma 2 kg.

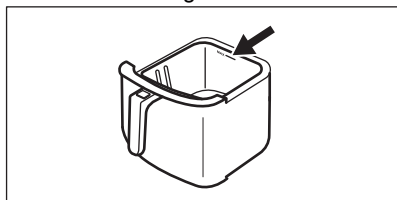









4.2 Tanácsok a főzéshez

Tegye az ételt a kosárba. Csatlakoztassa a készülék tápcsatlakozóját a hálózatra.

1.  - nyomja meg és tartsa megnyomva.



2. Válassza ki az ételt az Előre programozott sütés menüből:

Szimbólum	Beállítás
	140 °C 15 perc
	200 °C 10 perc
	180 °C 20 perc
	180 °C 45 perc
	170 °C 15 perc
	180 °C 15 perc
	180 °C 10 perc
	180 °C 15 perc

3. Nyomja meg ezt a gombot: . A főzés végén hangjelzés hallható. A hűtőventilátor néhány másodpercig még működik.

Főzés közben módosíthatja a beállításokat, és kikapcsolhatja a készüléket:









- A program módosításához nyomja meg az étel szimbólumot.







-  ,  - nyomja meg az idő vagy a hőmérséklet-beállítás módosításához.
-  - a készülék kikapcsolásához tartsa nyomva néhány másodpercig.

Húzza ki a készülék dugaszát a konnektorból, és várja meg, hogy a készülék lehűljön. Tisztítsa meg a tepsit és a kosarat.

5. FŐZÉSI TANÁCSOK

A táblázatban szereplő hőmérsékleti értékek és sütési időtartamok csak tájékoztatásként szolgálnak. A valós értékek a receptektől, a felhasznált összetevők minőségétől és mennyiségétől függenek.

	 (kg)	 (perc)	 (°C)	
 Burgonya és zöldségek				
Sült burgonya, vékony, fagyasztott	0.3 - 0.7	9 - 16	180	Rázza meg a kosarat
Sült burgonya, vastag, fagyasztott	0.3 - 0.7	11 - 20	180	Rázza meg a kosarat
Sült burgonya (8 x 8 mm)	0.3 - 0.8	10 - 16	180	Rázza meg a kosarat / Kenje meg 1/2 evőkanál étolajjal
Hasábburgonya, friss	0.3 - 0.8	18 - 22	180	Rázza meg a kosarat / Kenje meg 1/2 evőkanál étolajjal
Burgonyakockák	0.3 - 0.75	12 - 18	180	Rázza meg a kosarat / Kenje meg 1/2 evőkanál étolajjal
Töltött zöldség	0.1 - 0.4	10	170	-
Zöldségek	0.1 - 0.4	10	170	-
 Hús és szárnyas				
Steak	0.1 - 0.5	8 - 12	200	-
Sertésborda	0.1 - 0.5	10 - 14	200	-
Hamburger	0.1 - 0.5	7 - 14	200	-
Kolbászos tekercs	0.1 - 0.5	13 - 15	200	-
Csirkecomb	0.1 - 0.5	18 - 22	180	-
Csirkemell	0.1 - 0.5	10 - 15	185	-
Csirke	0.9 - 1.2	40 - 50	180	-
 Aprósütemény				
Tavaszi tekercs, fagyasztott	0.1 - 0.4	8 - 10	200	Rázza meg a kosarat

	 (kg)	 (perc)	 (°C)	
Csirkefalatok, fagyasz- tott	0.1 - 0.5	6 - 10	200	Rázza meg a kosarat
Halrudacsok, fagyasz- tott	0.1 - 0.4	6 - 10	200	-
Kenyérmorzsa, sajtos aprósütemény, fagyasz- tott	0.1 - 0.4	8 - 10	180	-
 Tésztasütés				
Sütemények	0.3	20 - 25	165	Használjon sütőformát
Quiche	0.4	20 - 22	185	Használjon sütőformát / hőálló edényt
Muffin	0.3	15 - 18	200	Használjon sütőformát

6. TISZTÍTÁSSAL KAPCSOLATOS MEGJEGYZÉSEK

	Tisztítószeres és tartozékok	Napi használat
	<p>A tepsit és a kosarat tisztítószeres meleg vízzel megnedvesített puha szivaccsal törölje le. A tepsit és a kosár mosogatógépben tisztítható.</p> <p>A fűtőelemet kefével tisztítsa.</p> <p>A készülék külsejét puha ruhával törölje le.</p>	<p>Tisztítás előtt húzza ki a készülék dugaszát a konnektorból, és várja meg, hogy a készülék lehűljön.</p> <p>Minden használat után tisztítsa meg a készüléket.</p>

7. MI A TEENDŐ, HA ...

Jelenség	Ellenőrizze a következőket:
Nem lehet elindítani vagy üzemeltetni a készüléket.	<ul style="list-style-type: none"> A készüléket megfelelően csatlakoztatta az elektromos hálózathoz. A sütési idő be van állítva.
Nem lehet becsúsztatni a tepsit a készülékbe.	<ul style="list-style-type: none"> A kosár nincs a maximális szint fölé töltve. A kosár megfelelően van behelyezve. Kattanó hangot kell hallani a tepsibe való behelyezéskor.
Fehér füst jön ki a készülékből.	<ul style="list-style-type: none"> A készülék étel nem zsíros. A tepsit és a kosár tiszta.

8. MŰSZAKI ADATOK

8.1 Műszaki adatok

Feszültség	220 - 240 V
Frekvencia	50 - 60 Hz

1. PANORAMICA

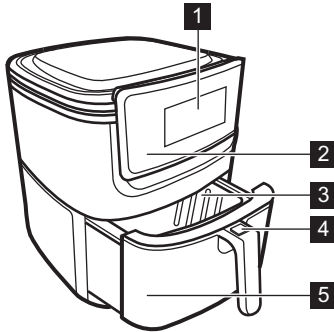

- 1** Display
- 2** Pannello di controllo
- 3** Cestello
- 4** Blocco di sicurezza con coperchio di protezione
- 5** Leccarda

2. PANNELLO DEI COMANDI

2.1 Pannello di controllo

Acquisire familiarità con le icone di base sul pannello di controllo e sul display.

				
ACCESO / SPENTO	Su	Giù	Temperatura	Durata

Cottura guidata - cuocere con impostazioni automatiche di tempo e temperatura.

			
Pesce	Bistecca	Cosce di pollo	Pollo
			
Verdure	Patatine fritte	Mini pizza	Muffin

2.2 Display

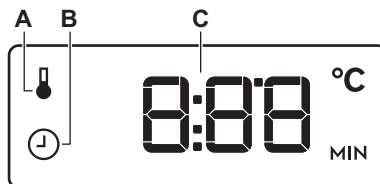

- A.** Impostazione temperatura
- B.** Impostazione del tempo
- C.** Tempo / temperatura

3. PRIMA DI UTILIZZARE L'ELETTRODOMESTICO



Togliere tutto l'imballaggio, le etichette e la pellicola protettiva.



Pulire cestello e padella con acqua calda, un po' di liquido detergente e un panno soffice.

Asciugare all'interno e all'esterno dell'apparecchio con un panno.

4. UTILIZZO QUOTIDIANO

4.1 Come si usa: padella e cestello

Appoggiare l'apparecchiatura su una superficie stabile.

1. Sollevare la pentola e posizionarla su una superficie stabile.
2. Rimuovere il coperchio di protezione sul blocco di sicurezza.
3. Abbassare il blocco di sicurezza per estrarre il cestello.

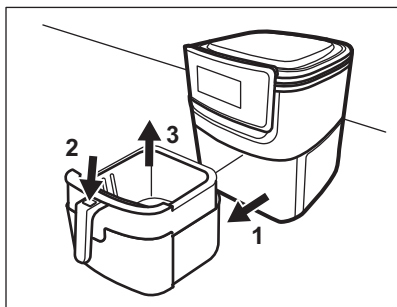

4. Mettere il cibo nel cestello fino al livello massimo. La capacità massima del cestello è 2 kg.

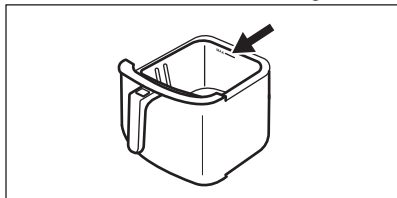

4.2 Come cucinare

Collocare il cibo nel cestello. Inserire la spina dell'apparecchiatura nella presa di corrente.

1. ① - tenere premuto.

2. Selezionare il piatto da Cucina assistita:

Simbolo	Impostazione
	140°C 15 min
	200°C 10 minuti
	180°C 20 min
	180°C 45 min
	170°C 15 min
	180°C 15 min
	180°C 10 minuti
	180°C 15 min

3. Premere: ①.

Al termine della cottura, viene emesso un segnale acustico. La ventola di raffreddamento funziona per qualche secondo.







È possibile modificare le impostazioni e spegnere l'apparecchiatura durante la cottura:







- Premere il simbolo del cibo per modificare il programma.
- \wedge , \vee - premere per regolare le impostazioni di tempo o temperatura.
- ⏸ - tenere premuto per alcuni secondi per spegnere l'apparecchiatura.

Scollegare la spina dell'apparecchiatura dalla corrente e attendere che l'apparecchiatura sia fredda. Pulire la padella e il cestello.

5. CONSIGLI DI CUCINA

La temperatura ed i tempi di cottura specificati nelle tabella sono valori indicativi. Possono variare in base alle ricette, alla qualità e alla quantità degli ingredienti utilizzati.

	 (kg)	 (min)	 (°C)	
 Patate e verdure				
Patatine fritte sottili, surgelato	0,3 - 0,7	9 - 16	180	Agitare il cestello
Patatine fritte tagliate spesse, surgelato	0,3 - 0,7	11 - 20	180	Agitare il cestello
Patatine fritte (8 x 8 mm)	0,3 - 0,8	10 - 16	180	Agitare il cestello / Aggiungere 1/2 cucchiaino d'olio
Spicchi di patate, freschi	0,3 - 0,8	18 - 22	180	Agitare il cestello / Aggiungere 1/2 cucchiaino d'olio
Patate a dadini	0,3 - 0,75	12 - 18	180	Agitare il cestello / Aggiungere 1/2 cucchiaino d'olio
Verdure farcite	0,1 - 0,4	10	170	-
Verdure	0,1 - 0,4	10	170	-
 Carne e pollame				
Bistecca	0,1 - 0,5	8 - 12	200	-
Bracioline di maiale	0,1 - 0,5	10 - 14	200	-
Hamburger	0,1 - 0,5	7 - 14	200	-
Involtoni di salsiccia	0,1 - 0,5	13 - 15	200	-
Cosce di pollo	0,1 - 0,5	18 - 22	180	-
Petto di pollo	0,1 - 0,5	10 - 15	185	-
Pollo	0,9 - 1,2	40 - 50	180	-

	 (kg)	 (min)	 (°C)	
 Snack				
Involtoni primavera, surgelati	0,1 - 0,4	8 - 10	200	Agitare il cestello
Nugget di pollo, surgelato	0,1 - 0,5	6 - 10	200	Agitare il cestello
Bastoncini di pesce, surgelato	0,1 - 0,4	6 - 10	200	-
Spuntini al formaggio panati, congelati	0,1 - 0,4	8 - 10	180	-
 Panificare				
Torte	0,3	20 - 25	165	Usare una leccarda
Quiche	0,4	20 - 22	185	Usare una leccarda / teglia da forno
Muffin	0,3	15 - 18	200	Usare una leccarda

6. NOTE SULLA PULIZIA

 <p>Detergenti e accessori Pulire la padella e il cestello con una spugna morbida inumidita con acqua tiepida saponata. La padella e il cestello sono lavabili in lavastoviglie. Pulire l'elemento riscaldante con uno spazzolino. Pulire il lato esterno dell'apparecchiatura con un panno inumidito.</p>	<p>Uso quotidiano Prima della pulizia, spegnere l'apparecchiatura e attendere che sia fredda. Pulire l'apparecchiatura dopo ogni utilizzo.</p>
---	---

7. COSA FARE SE...

Problema	Controllare se...
Non è possibile attivare l'apparecchiatura o metterla in funzione.	<ul style="list-style-type: none"> L'apparecchiatura è stata collegata in modo corretto all'alimentazione di rete. Il tempo di cottura è impostato.
Non è possibile far scivolare la padella nell'apparecchiatura.	<ul style="list-style-type: none"> Il cestello non viene riempito oltre la sua capacità massima. Il cestello è posizionato correttamente. Deve scattare quando lo si mette nella padella.

Problema	Controllare se...
Fumo bianco esce dall'apparecchio.	<ul style="list-style-type: none"><li data-bbox="613 156 935 180">• Il cibo preparato non è grasso.<li data-bbox="613 180 965 204">• La padella e il cestello sono puliti.

8. DATI TECNICI

8.1 Dati tecnici

Tensione	220 - 240 V
Frequenza	50 - 60 Hz

1. BENDRA APŽVALGA

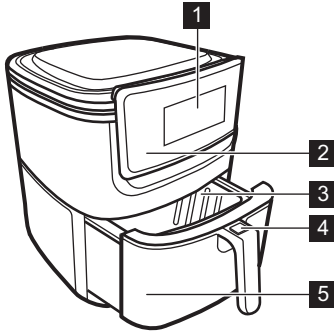





- 1 Valdymo skydelis
- 2 Valdymo skydelis
- 3 Krepšys
- 4 Saugos užraktas su apsauginiu dangteliu
- 5 Prikaistuvis









2. VALDYMO SKYDELIS

2.1 Valdymo skydelis

Susipažinkite su valdymo skydelio ir ekrano pagrindinėmis piktogramomis.

				
ĮJUNGIMAS / IŠJUNGIMAS	Aukštyn	Žemyn	Temperatūra	Trukmė

Kepimo vadovas - gaminkite, naudodami automatinės laiko ir temperatūros nuostatas.

			
Žuvis	Kepsnys	Viščiuko šlaunelės	Viščiukas
			
Daržovės	Gruzdintos bulvytės	Maža pica	Keksiukai

2.2 Valdymo skydelis

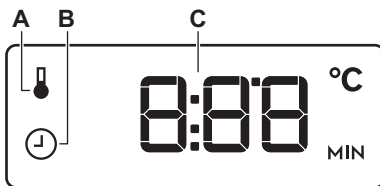

- A. Temperatūros nustatymai
- B. Laiko nuostata
- C. Laikas / temperatūra

3. PRIEŠ NAUDODAMI PIRMAKART



Nuimkite visas pakuotės, ženklavimo medžiagas ir apsauginę plėvelę.



Išplaukite krepšį ir prikaistuvį šiltu vandeniu su plovimo skysčiu ir išvalykite švelnia šluoste.

Šluoste nusausinkite prietaiso vidų ir išorę.

4. KASDIENIS NAUDOJIMAS

4.1 Kaip naudoti: prikaistuvį ir krepšį

Pastatykite prietaisą ant stabilaus paviršiaus.

1. Nuimkite prikaistuvį ir padėkite jį ant stabilaus paviršiaus.
2. Nuimkite nuo saugos užrakto apsauginį dangtelį.
3. Norėdami ištraukti krepšį, paspauskite saugos užraktą.

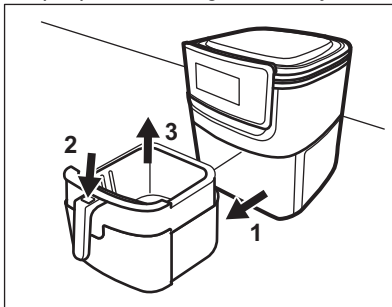

4. Sudėkite maistą į krepšį iki maksimalaus lygio. Maksimali krepšio talpa – 2 kg.

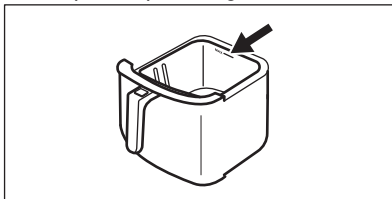

4.2 Kaip ruošti maistą

Sudėkite maistą į krepšį. Įjunkite prietaisą į maitinimo tinklą.

1.  - paspauskite ir palaikykite nuspaudę.

2. Pasirinkite patiekalą iš kepimo vadovo:

Simbolis	Nuostata
	140 °C 15 min.
	200 °C 10 min.
	180 °C 20 min.
	180 °C 45 min.
	170 °C 15 min.
	180 °C 15 min.
	180 °C 10 min.
	180 °C 15 min.

3. Paspauskite: .

Gaminimui pasibaigus, girdimas signalas. Kelias sekundes veikia aušinimo ventiliatorius.

Galite pakeisti nuostatas ir išjungti prietaisą ruošiant maistą:









- Paspauskite maisto simbolį, kad pakeistumėte programą.







- ^, v – spauskite laiko ar temperatūros nuostatomis koreguoti.
- Ⓛ - paspauskite ir palaikykite kelias sekundes, kad išjungtumėte prietaisą.

Išjunkite prietaisą ir palaukite, kol atvės. Išvalykite prikaistuvį ir krepšį.

5. MAISTO RUOŠIMO PATARIMAI

Lentelėse nurodyta temperatūra ir ruošimo laikas yra tik orientacinio pobūdžio. Jie priklauso nuo receptų, naudojamų produktų kokybės ir kiekio.

	 (kg)	 (min.)	 (°C)	
 Bulvės ir daržovės				
Gruzdintos bulvytės, plonai pjaustytos, šaldyti	0,3–0,7	9–16	180	Pakratykite krepšį
Gruzdintos bulvytės, stambiai pjaustytos, šaldyti	0,3–0,7	11–20	180	Pakratykite krepšį
Gruzdintos bulvytės (8 x 8 mm)	0,3–0,8	10–16	180	Pakratykite krepšį / įpilkite 1/2 valgomojo šaukšto aliejaus
Bulvių skiltelės, šviežios	0,3–0,8	18–22	180	Pakratykite krepšį / įpilkite 1/2 valgomojo šaukšto aliejaus
Bulvių kubeliai	0,3–0,75	12–18	180	Pakratykite krepšį / įpilkite 1/2 valgomojo šaukšto aliejaus
Įdarytos daržovės	0,1–0,4	10	170	–
Daržovės	0,1–0,4	10	170	–
 Mėsa ir paukštiena				
Kepsnys	0,1–0,5	8–12	200	–
Kiaulienos muštiniai	0,1–0,5	10–14	200	–
Mėsainis	0,1–0,5	7–14	200	–
Bandelės su dešra	0,1–0,5	13–15	200	–
Viščiuko šlaunelės	0,1–0,5	18–22	180	–
Vištienos krūtinėlė	0,1–0,5	10–15	185	–
Viščiukas	0,9–1,2	40–50	180	–
 Užkandžiai				
Pavasariniai ritinėliai, šaldyti	0,1–0,4	8–10	200	Pakratykite krepšį

	 (kg)	 (min.)	 (°C)	
Kepti vištienos gabalėliai, šaldyti	0,1–0,5	6–10	200	Pakratykite krepšį
Žuvų piršteliai, šaldyti	0,1–0,4	6–10	200	–
Sūrio užkandžiai, apvolioti duonos trupiniais, šaldyti	0,1–0,4	8–10	180	–
 Kepimas				
Pyragai	0,3	20–25	165	Naudokite kepimo skardą
Apkepas su įdaru	0,4	20–22	185	Naudokite kepimo skardą / orkaitėje kepti tinkamą indą
Keksiukai	0,3	15–18	200	Naudokite kepimo skardą

6. PASTABOS DĖL VALYMO

	Valymo priemonės ir priedai	Kasdienis naudojimas
	Nuvalykite prikaistuvį ir krepšį minkšta kempine su šiltu vandeniu ir plovimo skysčiu. Prikaistuvį ir krepšį galima plauti indaplovėje. Išvalykite kaitinamąjį elementą valymo šepečėliu. Nuvalykite prietaiso išorę minkšta šluoste.	Prieš valydami, išjunkite prietaisą ir palaukite, kol atvės. Prietaisą valykite po kiekvieno naudojimo.

7. KĄ DARYTI, JEIGU...

Problema	Patikrinkite, ar...
Prietaiso negalima įjungti arba valdyti.	<ul style="list-style-type: none"> • Prietaisas tinkamai prijungtas prie elektros tinklo lizdo. • Nustatyta gamintojo trukmė.
Negalite įstumti prikaistuvio į prietaisą.	<ul style="list-style-type: none"> • Krepšys nepripildytas daugiau nei maksimali talpa. • Krepšys tinkamai įdėtas. Turi spragtelėti, kai įdedate jį į prikaistuvį.
Iš prietaiso sklinda balti dūmai.	<ul style="list-style-type: none"> • Jūsų paruoštas maistas be riebalų. • Prikaistuvis ir krepšys yra švarūs.

8. TECHNINIAI DUOMENYS

8.1 Techniniai duomenys

Įtampa	220–240 V
Dažnis	50–60 Hz

1. VISPĀRĒJS PĀRSKATS

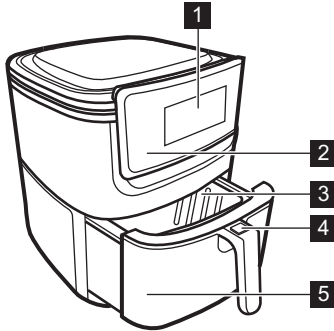

- 1** Displejs
- 2** Vadības panelis
- 3** Grozs
- 4** Drošības slēdzene ar aizsardzības pārsegu
- 5** Panna









2. VADĪBAS PANELIS

2.1 Vadības panelis

Iepazīstieties ar galvenajām ikonām vadības panelī un uz displeja.

				
IESLĒGT / IZ-SLĒGT	Uz augšu	Uz leju	Temperatūra	Darb. laiks

Gatavošanas palīgs - gatavošana ar automātiskajiem laika un temperatūras iestatījumiem.

			
Zivs	Steiks	Vistu stilbiņi	Vista
			
Dārzeni	Kartupeļi frī	Mini pica	Mufini

2.2 Displejs

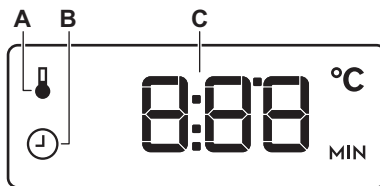

- A. Temperatūras iestatījums
- B. Laika iestatījums
- C. Laiks / temperatūra

3. PIRMS PIRMĀS IZMANTOŠANAS REIZES



Noņemiet visus iesaiņojuma materiālus, uzlīmes un aizsargplēvi.



Nomazgājiet grozu un pannu ar karstu ūdeni, trauku mazgāšanas līdzekli un mikstu drānu.

Nosusiniet ierīces iekšpusi un ārpusi ar drānu.

4. IZMANTOŠANA IKDIENĀ

4.1 Izmantošana: panna un grozs

Novietojiet ierīci uz stabilas virsmas.

1. Noņemiet pannu un novietojiet to uz stabilas virsmas.
2. Noņemiet aizsardzības pārsegu no drošības slēdzenes.
3. Nospiediet drošības slēdzeni, lai noņemtu grozu.

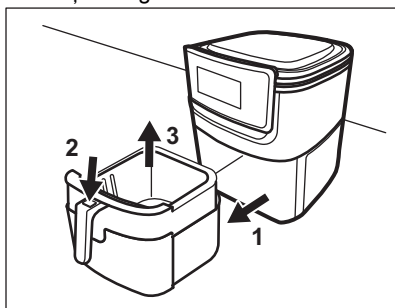

4. Ievietojiet produktus grozā līdz maksimālajam līmenim. Groza maksimālā ietilpība ir 2 kg.

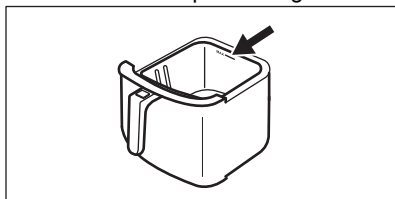

4.2 Gatavošana

Ievietojiet produktus grozā. Pieslēdziet ierīci elektrotīklam.

1. ① - turiet nospiestu.
2. Izvēlieties ēdienu no Gatavošanas palīga:

Simbols	Iestatījums
	140 °C 15 min
	200 °C 10 min
	180 °C 20 min
	180 °C 45 min
	170 °C 15 min
	180 °C 15 min
	180 °C 10 min
	180 °C 15 min

3. Nospiediet: ①.

Kad gatavošana beidzas, atskan signāls. Dažas sekundes darbojas dzesēšanas ventilators.









Jūs varat mainīt iestatījumus un izslēgt ierīci gatavošanas laikā:







- Nospiediet ēdiena simbolu, lai mainītu programmu.
- ^, v - nospiediet, lai regulētu laiku vai temperatūras iestatījumus.
- ① - nospiediet un turiet dažas sekundes, lai izslēgtu ierīci.

Atvienojiet ierīci no elektrotīkla un pagaidiet, līdz tā atdziest. Izfīriet pannu un grozu.

5. GATAVOŠANAS PADOMI

Tabulās uzrādītā temperatūra un cepšanas laiki ir ir tikai orientējoši. Tie atkarīgi no receptēm un izmantoto sastāvdaļu kvalitātes un daudzuma.

	 (kg)	 (min.)	 (°C)	
 Kartupeļi un dārzeņi				
Kartupeļi frī, smalki, saldēti	0,3 - 0,7	9 - 16	180	Sakratiet grozu
Kartupeļi frī, biezi, saldēti	0,3 - 0,7	11 - 20	180	Sakratiet grozu
Kartupeļi frī (8 x 8 mm)	0,3 - 0,8	10 - 16	180	Sakratiet grozu / pievienojiet 1/2 ēdamkaroti eļļas
Kartupeļu daiviņas, svaigas	0,3 - 0,8	18 - 22	180	Sakratiet grozu / pievienojiet 1/2 ēdamkaroti eļļas
Kubiņos sagriezti kartupeļi	0,3 - 0,75	12 - 18	180	Sakratiet grozu / pievienojiet 1/2 ēdamkaroti eļļas
Pildīti dārzeņi	0,1 - 0,4	10	170	-
Dārzeņi	0,1 - 0,4	10	170	-
 Gaļa un putnu gaļa				
Steiks	0,1 - 0,5	8 - 12	200	-
Cūkgaļas karbonāde ar ribiņu	0,1 - 0,5	10 - 14	200	-
Hamburgers	0,1 - 0,5	7- 14	200	-
Kārtainā mīklā ieceptas desiņas	0,1 - 0,5	13 - 15	200	-
Vistu stilbiņi	0,1 - 0,5	18 - 22	180	-
Cāļa krūtiņa	0,1 - 0,5	10 - 15	185	-
Vista	0,9 - 1,2	40 - 50	180	-
 Uzkodas				
Dārzeņu ruletītes, saldētas	0,1 - 0,4	8 - 10	200	Sakratiet grozu
Vistas nageti, saldēti	0,1 - 0,5	6 - 10	200	Sakratiet grozu

	 (kg)	 (min.)	 (°C)	
Zivju pirkstiņi, saldēti	0,1 - 0,4	6 - 10	200	-
Siera uzkodas rīvmaizē, saldētas	0,1 - 0,4	8 - 10	180	-
 Konditorejas izstrādājumiem				
Kūkas	0,3	20 - 25	165	Izmantojiet cepšanas formu
Sāļais pīrāgs	0,4	20 - 22	185	Izmantojiet cepšanas formu/ cepeškrāsns trauku
Mufini	0,3	15 - 18	200	Izmantojiet cepšanas formu

6. PIEZĪMES PAR TĪRĪŠANU

	Tīrīšanas līdzekļi un piederumi	Lietošana ikdienā
	<p>Notīriet pannu un grozu ar siltā ūdenī un trauku mazgājamā līdzeklī izmērcētu mīkstu drāniņu.</p> <p>Pannu un grozu drīkst mazgāt trauku mazgājamajā mašīnā.</p> <p>Notīriet sildelementu ar tīrīšanas suku.</p> <p>Notīriet ierīces ārpusi ar mīkstu drāniņu.</p>	<p>Pirms tīrīšanas atvienojiet ierīci no elektrotīkla un pagaidiet, līdz tā atdziest.</p> <p>Tīriet ierīci pēc katras lietošanas reizes.</p>

7. KO DARĪT, JA ...

Problēma	Pārbaudiet, vai:
Ierīci nevar ieslēgt vai lietot.	<ul style="list-style-type: none"> Ierīce ir pareizi pievienota strāvas padevei. Ir iestatīts gatavošanas laiks.
Pannu nevar iebīdīt ierīcē.	<ul style="list-style-type: none"> Nav pārsniegta groza maksimālā ietilpība. Grozs ir novietots pareizi. Ievietojot to pannā, ir jāatskan klikšķim.
No ierīces izdalās balti dūmi.	<ul style="list-style-type: none"> Jūsu gatavotais ēdiens nav taukains. Panna un grozs ir tīrs.

8. TEHNISKIE DATI

8.1 Tehniskie dati

Spriegums	220 – 240 V
Frekvence	50 - 60 Hz

1. GENERELL OVERSIKT

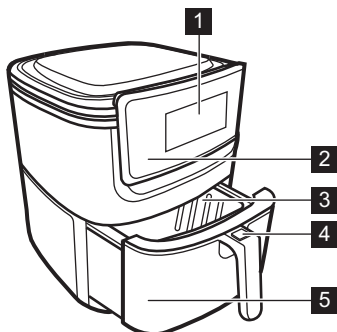

- 1 Display
- 2 Betjeningspanel
- 3 Kurv
- 4 Sikkerhetslås med beskyttelsesdeksel
- 5 Panne

2. BETJENINGSPANEL

2.1 Betjeningspanel

Bli kjent med de grunnleggende ikonene på betjeningspanelet og displayet.



Assistert matlaging - stek med automatiske tids- og temperaturinnstillinger.



2.2 Display

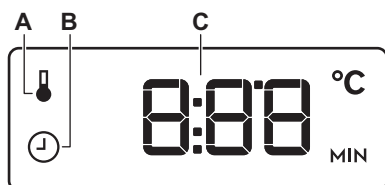

- A. Temperaturinnstilling
- B. Tidsinnstilling
- C. Tid/temperatur

3. FØR FØRSTEGANGS BRUK



Fjern all emballasje, merking og beskyttelsesfilm.



Rengjør kurven og pannen med varmt vann, oppvaskmiddel og en myk klut.
Tørk innsiden og utsiden av produktet med en klut.

4. DAGLIG BRUK

4.1 Slik bruker du: panne og kurv

Plasser produktet på den stabile overflaten.

1. Fjern pannen og plasser det på en stabil overflate.
2. Fjern beskyttelsesdekselet på sikkerhetslåsen.
3. Trykk på sikkerhetslåsen for å fjerne kurven.

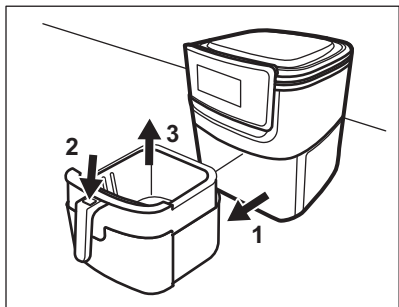

4. Legg maten i kurven opp til maksimalt nivå. Kurvens maksimale kapasitet er 2 kg.

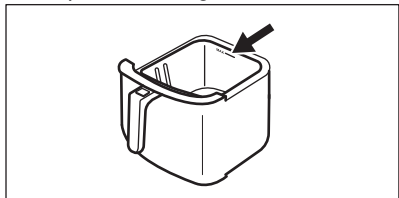

4.2 Slik lager du mat

Sett maten i kurven. Sett inn produktet.

1. ① – trykk og hold.
2. Velg retten fra assistert Tilberedningshjelp:

Symbol	Innstilling
	140°C 15 min
	200°C 10 min
	180°C 20 min.
	180°C 45 min.
	170°C 15 min
	180°C 15 min
	180°C 10 min
	180°C 15 min

3. Trykk på: ①.

Når tilberedningstiden er utløpt, høres et lydsignal. Kjøleviften virker i et par sekunder.









Du kan endre innstillingene og slå av produktet under tilberedningen:







- Trykk på matsymbolet for å endre programmet.
- ^, v - trykk for å justere tids- eller temperaturinnstillingene.
- ① – trykk og hold inne i et par sekunder for å slå av produktet.

Koble fra produktet, og vent til det er kaldt. Rengjør pannen og kurven.

5. TIPS TIL TILBEREDNING

Temperaturer og steketider i tabellene er kun veiledende. De avhenger av oppskrift, samt mengde og kvalitet på ingrediensene som brukes.

	 (kg)	 (min.)	 (°C)	
 Poteter og grønnsaker				
Pommes frites, tynne, frossen	0,3 - 0,7	9 - 16	180	Rist kurven
Pommes frites, tykke, frossen	0,3 - 0,7	11 - 20	180	Rist kurven
Pommes Frites (8 x 8 mm)	0,3 - 0,8	10 - 16	180	Rist kurven / Tilsett 1/2 ss olje
Potetbåter, ferske	0,3 - 0,8	18 - 22	180	Rist kurven / Tilsett 1/2 ss olje
Potetterninger	0,3 - 0,75	12 - 18	180	Rist kurven / Tilsett 1/2 ss olje
Fylte grønnsaker	0,1 - 0,4	10	170	-
Grønnsaker	0,1 - 0,4	10	170	-
 Kjøtt og fjærkre				
Biff	0,1 - 0,5	8 - 12	200	-
Svinekoteletter	0,1 - 0,5	10 - 14	200	-
Hamburger	0,1 - 0,5	7 - 14	200	-
Pølseruller	0,1 - 0,5	13 - 15	200	-
Kyllinglår	0,1 - 0,5	18 - 22	180	-
Kyllingbryst	0,1 - 0,5	10 - 15	185	-
Kylling	0,9 - 1,2	40 - 50	180	-
 Snacks				
Vårruller, frosne	0,1 - 0,4	8 - 10	200	Rist kurven
Kyllingnuggets, frossen	0,1 - 0,5	6 - 10	200	Rist kurven
Fiskepinner, frossen	0,1 - 0,4	6 - 10	200	-
Oste-/brødsnacks, frosne	0,1 - 0,4	8 - 10	180	-

	 (kg)	 (min.)	 (°C)	
 Steking av bakst				
Kaker	0,3	20 - 25	165	Bruk en bakeform
Quiche	0,4	20 - 22	185	Bruk en ildfast form / stekeplate
Muffins	0,3	15 - 18	200	Bruk en bakeform

6. MERKNADER OM RENGJØRING

	<p>Rengjøringsmidler og tilbehør Rengjør pannen og kurven med en myk svamp med varmt vann og oppvaskmiddel. Pannen og kurven kan vaskes i oppvaskmaskin. Rengjør varmeelementet med en rengjøringsbørste. Rengjør utersiden av produktet med en myk klut.</p>	<p>Hverdagsbruk Før du rengjør kobler du fra produktet og venter til det er kaldt. Rengjør produktet etter hver bruk.</p>
---	--	--

7. HVA MÅ GJØRES, HVIS ...

Problem	Kontroller at ...
Du kan ikke slå på eller betjene produktet.	<ul style="list-style-type: none"> • Produktet er riktig koblet til strømforsyningen. • Tilberedningstiden er innstilt.
Du kan ikke skyve pannen inn i produktet.	<ul style="list-style-type: none"> • Kurven er ikke fylt over sin maksimale kapasitet. • Kurven er plassert riktig. Den må klikke når du legger den i pannen.
Hvit røyk kommer ut av produktet.	<ul style="list-style-type: none"> • Maten du tilbereder er ikke fet. • Pannen og kurven er rene.

8. TEKNISKE DATA

8.1 Tekniske data

Spenning	220 - 240 V
Frekvens	50 - 60 Hz

1. WIDOK URZĄDZENIA

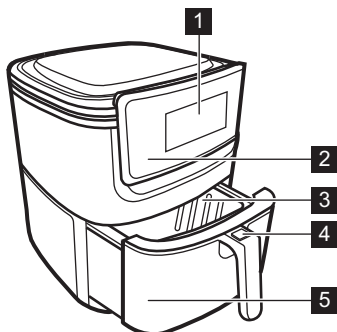





- 1 Wyświetlacz
- 2 Panel sterowania
- 3 Kosz
- 4 Blokada z osłoną zabezpieczającą
- 5 Blacha do pieczenia

2. PANEL STEROWANIA

2.1 Panel sterowania

Zapoznać się z podstawowymi symbolami na panelu sterowania i wyświetlaczu.

				
WŁĄCZONE/ WYŁĄCZONE	W górę	W dół	Temperatura	Czas

Gotowanie wspomagane – pieczenie z automatycznymi ustawieniami czasu i temperatury.

			
Ryby	Stek	Udka kurczaka	Kurczak
			
Warzywa	Frytki	Minipizza	Babeczki

2.2 Wyświetlacz

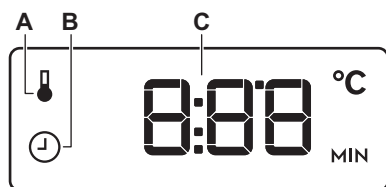

- A. Ustawienie temperatury
- B. Ustawienie czasu
- C. Czas/temperatura

3. PRZED PIERWSZYM UŻYCIEM



Usunąć wszystkie elementy opakowania, etykiety i folię ochronną.



Umyć kosz i pojemnik w ciepłej wodzie z płynem do mycia naczyń za pomocą miękkiej ściereczki.

Osuszyć urządzenie w środku i na zewnątrz za pomocą szmatki.

4. CODZIENNA EKSPLOATACJA

4.1 Obsługa urządzenia: pojemnik i kosz

Postawić urządzenie na stabilnej powierzchni.

1. Wyjąć pojemnik i postawić go na stabilnej powierzchni.
2. Zdjąć osłonę zabezpieczającą z blokady.
3. Nacisnąć blokadę, aby wyjąć kosz.

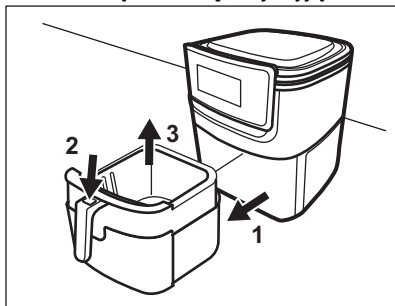

4. Napełnić kosz składnikami do maksymalnego poziomu. Maksymalna ładowność kosza wynosi 2 kg.

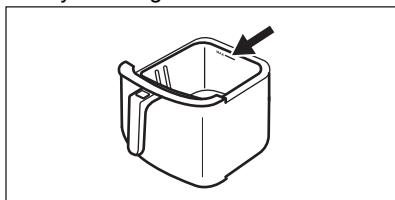

4.2 Sposób pieczenia

Umieścić składniki w koszu. Podłączyć urządzenie do zasilania.

1. ① – nacisnąć i przytrzymać.
2. Wybrać potrawę z menu Gotowanie wspomagane

Symbol	Ustawienie
	140°C 15 min
	200°C 10 min
	180°C 20 min
	180°C 45 min
	170°C 15 min
	180°C 15 min
	180°C 10 min
	180°C 15 min

3. Nacisnąć: ①.

Po zakończeniu pieczenia rozlegnie się sygnał dźwiękowy. Przez kilka sekund będzie działał wentylator chłodzący.









Podczas pieczenia można zmienić ustawienia lub wyłączyć urządzenie.







- Nacisnąć symbol produktu, aby zmienić program.
- ^, v – nacisnąć, aby dostosować ustawienia czasu lub temperatury.
- ① – naciśnij i przytrzymać przez kilka sekund, aby wyłączyć urządzenie.

Odłączyć urządzenie od zasilania i zaczekać, aż ostygnie. Wyczyścić pojemnik i kosz.

5. WSKAZÓWKI DOTYCZĄCE PIECZENIA

Temperatury i czasy pieczenia podane w tabelach mają wyłącznie charakter orientacyjny. Zależą one od przepisu, jakości oraz ilości użytych składników.

	 (kg)	 (min)	 (°C)	
 Ziemniaki i warzywa				
Frytki, cienkie, mrożone	0.3 - 0.7	9 - 16	180	Potrząsnąć koszem
Frytki, grube, mrożone	0.3 - 0.7	11 - 20	180	Potrząsnąć koszem
Frytki (8 x 8 mm)	0.3 - 0.8	10 - 16	180	Potrząsnąć koszem / Dodać 1/2 łyżki oleju
Ćwiartki ziemniaków, świeże	0.3 - 0.8	18 - 22	180	Potrząsnąć koszem / Dodać 1/2 łyżki oleju
Ziemniaki pokrojone w kostkę	0.3 - 0.75	12 - 18	180	Potrząsnąć koszem / Dodać 1/2 łyżki oleju
Nadziewane warzywa	0.1 - 0.4	10	170	-
Warzywa	0.1 - 0.4	10	170	-
 Mięso i drób				
Stek	0.1 - 0.5	8 - 12	200	-
Kotlety wieprzowe	0.1 - 0.5	10 - 14	200	-
Hamburger	0.1 - 0.5	7- 14	200	-
Kiełbaski zapiekane	0.1 - 0.5	13 - 15	200	-
Udka kurczaka	0.1 - 0.5	18 - 22	180	-
Pierś kurczaka	0.1 - 0.5	10 - 15	185	-
Kurczak	0.9 - 1.2	40 - 50	180	-
 Przekąski				
Sajgonki, mrożone	0.1 - 0.4	8 - 10	200	Potrząsnąć koszem
Nuggety z kurczaka, mrożone	0.1 - 0.5	6 - 10	200	Potrząsnąć koszem
Paluszki rybne, mrożone	0.1 - 0.4	6 - 10	200	-

	 (kg)	 (min)	 (°C)	
Przekąski serowe w pa- nierce, mrożone	0.1 - 0.4	8 - 10	180	-
 Pieczenie ciast				
Ciasta	0.3	20 - 25	165	Użyć foremki do ciasta
Quiche	0.4	20 - 22	185	Użyć foremki do ciasta/naczy- nia żaroodpornego
Babeczki	0.3	15 - 18	200	Użyć foremki do ciasta

6. UWAGI DOTYCZĄCE CZYSZCZENIA

	<p>Środki czyszczące i akcesoria Pojemnik i kosz myć miękką gąbką zwilżoną ciepłą wodą z dodatkiem płynu do mycia naczyń. Pojemnik i kosz są przystosowane do mycia w zmywarce. Grzałkę czyścić szczotką do czyszczenia. Zewnętrzne powierzchnie urządzenia czyścić wilgotną ściereczką.</p>	<p>Codziennie użytkowanie Przed przystąpieniem do czyszczenia odłączyć urządzenie od zasilania i zaczekać, aż ostygnie. Czyścić urządzenie po każdym użyciu.</p>
---	---	---

7. CO ZROBIĆ, GDY...

Problem	Sprawdzić, czy...
Nie można uruchomić urządzenia ani nim sterować.	<ul style="list-style-type: none"> • Urządzenie podłączono prawidłowo do źródła zasilania. • Ustawiono czas pieczenia.
Można wsunąć pojemnik do urządzenia.	<ul style="list-style-type: none"> • Kosz nie jest przepelniony. • Kosz jest prawidłowo umieszczony. Podczas umieszczania go w pojemniku powinno być słyszalne kliknięcie.
Z urządzenia nie wydobywa się biały dym.	<ul style="list-style-type: none"> • Przyrządzana potrawa nie jest tłusta. • Pojemnik i kosz są czyste.

8. DANE TECHNICZNE

8.1 Dane techniczne

Napięcie	220-240 V
Częstotliwość	50-60 Hz

1. PREZENTARE GENERALĂ

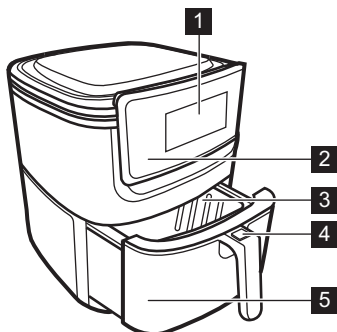



- 1 Afișaj
- 2 Panou de comandă
- 3 Coș
- 4 Încuietoare de siguranță cu capac de protecție
- 5 Cratiță









2. PANOUL DE COMANDĂ

2.1 Panou de comandă

Familiarizați-vă cu pictogramele de bază de pe panoul de comandă și afișaj.

 PORNIT/ OPRIT	 Sus	 Jos	 Temperatură	 Durata
---	--	--	--	---

Gătire asistată - gătiți cu setări automate pentru durată și temperatură.

 Peste	 Friptură	 Pulpe de pui	 Pui
 Legume	 Cartofi prăjiți	 Mini pizza	 Brioșe

2.2 Afișaj

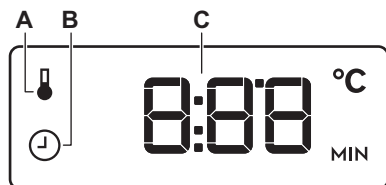

- A. Reglaj temperatură
- B. Setare durată
- C. Durată / temperatură

3. ÎNAINTE DE PRIMA UTILIZARE



Îndepărtați ambalajul, etichetele și folia protectoare.



Curățați coșul și vasul cu apă caldă, lichid de vase și o lavetă moale.
Uscați interiorul și exteriorul aparatului cu o lavetă moale.

4. UTILIZAREA ZILNICĂ

4.1 Modul de utilizare: vasul și coșul

Puneți aparatul pe o suprafață stabilă.

1. Scoateți vasul și puneți-l pe o suprafață stabilă.
2. Scoateți capacul de protecție de la încuietoarea de siguranță.
3. Apăsăți încuietoarea de siguranță pentru a scoate coșul.

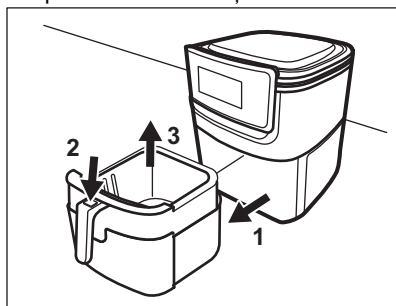

4. Introduceți alimentele în coș până la nivelul maxim. Capacitatea maximă a coșului este de 2 kg.

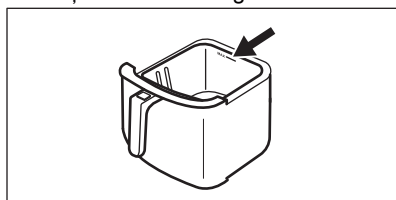

4.2 Cum se gătește

Introduceți alimentele în coș. Introduceți aparatul în priză.

1. ① - apăsați lung.
2. Alegeți preparatul din Gătire asistată:

Simbol	Setare
	140 °C 15 min
	200 °C 10 min
	180 °C 20 min
	180 °C 45 min
	170 °C 15 min
	180 °C 15 min
	180 °C 10 min
	180 °C 15 min

3. Apăsăți: ①.

La terminarea gătirii este emis semnalul sonor. Ventilatorul de răcire funcționează timp de câteva secunde.









Puteți modifica setările și opri aparatul în timpul gătirii:







- Apăsăți simbolul aliment pentru a modifica programul.
- ^, v - apăsați pentru a regla setările pentru durată sau temperatură.
- ① - apăsați lung timp de câteva secunde pentru a opri aparatul.

Scoateți aparatul din priză și așteptați să se răcească. Curățați vasul și coșul.

5. SFATURI PENTRU GĂTIRE

Temperatura și duratele de gătire din tabele au rol consultativ. Acestea depind de rețete și de calitatea și cantitatea ingredientelor utilizate.

	 (kg)	 (min)	 (°C)	
 Cartofi și legume				
Cartofi prăjiți, subțiri, congelat	0.3 - 0.7	9 - 16	180	Scuturați coșul
Cartofi prăjiți, groși, congelat	0.3 - 0.7	11 - 20	180	Scuturați coșul
Cartofi prăjiți(8 x 8 mm)	0.3 - 0.8	10 - 16	180	Scuturați coșul / Adăugați 1/2 de lingură de ulei
Cartofi wedges, proaspeți	0.3 - 0.8	18 - 22	180	Scuturați coșul / Adăugați 1/2 de lingură de ulei
Cubulețe de cartofi	0.3 - 0.75	12 - 18	180	Scuturați coșul / Adăugați 1/2 de lingură de ulei
Legume umplute	0.1 - 0.4	10	170	-
Legume	0.1 - 0.4	10	170	-
 Carne și pui				
Friptură	0.1 - 0.5	8 - 12	200	-
Cotlet de porc	0.1 - 0.5	10 - 14	200	-
Hamburger	0.1 - 0.5	7- 14	200	-
Pateuri cu carne	0.1 - 0.5	13 - 15	200	-
Pulpe de pui	0.1 - 0.5	18 - 22	180	-
Piept de pui	0.1 - 0.5	10 - 15	185	-
Pui	0.9 - 1.2	40 - 50	180	-
 Snacksuri				
Pachețele de primăvară, congelate	0.1 - 0.4	8 - 10	200	Scuturați coșul
Nuggets de pui, congelat	0.1 - 0.5	6 - 10	200	Scuturați coșul
Degetele de pește pane, congelat	0.1 - 0.4	6 - 10	200	-

	 (kg)	 (min)	 (°C)	
Snacksuri din brânză pane în pesmet, conge- late	0.1 - 0.4	8 - 10	180	-
 Coacere				
Prăjituri	0.3	20 - 25	165	Utilizați o formă de gătit
Quiche	0.4	20 - 22	185	Utilizați o formă de gătit / vas pentru cuptor
Briose	0.3	15 - 18	200	Utilizați o formă de gătit

6. NOTE CU PRIVIRE LA CURĂȚARE

	Agenții de curățare și accesoriiile	Utilizarea zilnică
	<p>Curățați vasul și coșul cu un burete moale cu apă caldă și lichid de vase.</p> <p>Vasul și coșul se pot spăla la mașină.</p> <p>Curățați elementul de încălzire cu o perie de curățare.</p> <p>Curățați exteriorul aparatului cu o lavetă moale.</p>	<p>Înainte de curățare, scoateți aparatul din priză și așteptați să se răcească.</p> <p>Curățați aparatul după fiecare întrebuințare.</p>

7. CE TREBUIE FĂCUT DACĂ...

Problemă	Verificați dacă...
Aparatul nu poate fi pornit sau utilizat.	<ul style="list-style-type: none"> Aparatul este conectat corect la o sursă de alimentare electrică. Durata gătirii este setată.
Nu puteți introduce vasul în aparat.	<ul style="list-style-type: none"> Coșul nu este umplut peste capacitatea sa maximă. Coșul este poziționat corect. Acesta trebuie să facă un clic când este introdus în vas.
Din aparat iese fum alb.	<ul style="list-style-type: none"> Mâncarea preparată nu este unsuroasă. Vasul și coșul sunt curate.

8. DATE TEHNICE

8.1 Date tehnice

Tensiune	220 - 240 V
Frecvență	50 - 60 Hz

1. ОБЩИЙ ОБЗОР

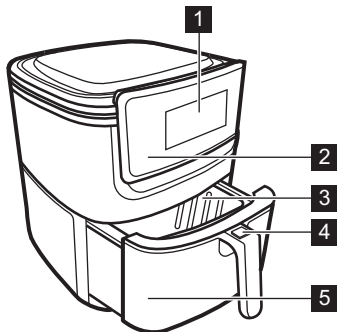

- 1 Дисплей
- 2 Панель управления
- 3 Корзина
- 4 Защитный блокиратор с крышкой
- 5 Поддон

2. ПАНЕЛЬ УПРАВЛЕНИЯ

2.1 Панель управления

Ознакомьтесь с основными значками на панели управления и дисплее.

«ВКЛ/ВЫКЛ»	Вверх	Вниз	Температура	Продолж.

Помощь в Приготовлении - приготовление с автоматически заданными настройками времени и температуры.

Рыба	Стейк	Куриные ножки	Цыпленок
Овощи	Картофель фри	Мини-пицца	Маффины

2.2 Дисплей

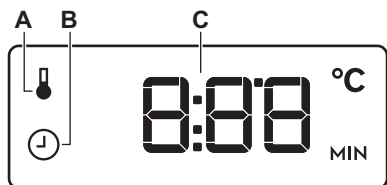

- A. Уровень температуры
- B. Установка параметров времени
- C. Время / температура

3. ПЕРЕД ПЕРВЫМ ИСПОЛЬЗОВАНИЕМ



Удалите всю упаковку, наклейку и защитную пленку.



Вымойте корзину и поддон под горячей водой мягкой тряпкой с моющим средством.

Вытрите прибор тряпкой внутри и снаружи.

4. ЕЖЕДНЕВНОЕ ИСПОЛЬЗОВАНИЕ

4.1 Использование поддона и корзины

Установите прибор на устойчивой поверхности.

1. Снимите поддон и положите его на устойчивую поверхность.
2. Снимите защитную крышку блокиратора.
3. Выньте корзину, нажав на блокиратор.

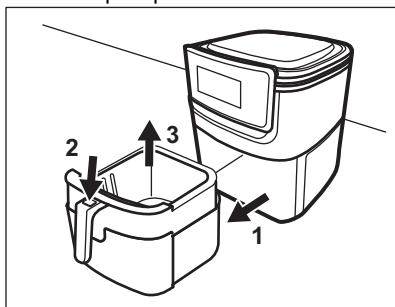

4. Выложите в корзину продукты, не превышая отметки максимальной загрузки. Максимальная емкость корзины составляет 2 кг.

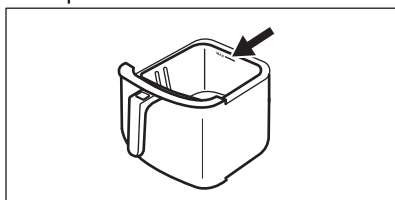









4.2 Приготовление

Поместите продукты в корзину. Включите прибор в сеть.

1. Нажмите и удерживайте .

2. Выберите блюдо из списка функции «Помощь в приготовлении»:

Символ	Настройка
	140°C 15 мин
	200°C 10 мин
	180°C 20 мин
	180°C 45 мин
	170°C 15 мин
	180°C 15 мин
	180°C 10 мин
	180°C 15 мин

3. Нажмите .

По окончании приготовления выдается звуковой сигнал. Вентилятор будет работать еще несколько секунд.

Во время приготовления можно изменить настройки или выключить прибор:







- Для изменения программы нажмите символ продукта.







- Нажмите \wedge , \vee для настройки времени или температуры.
- Нажмите и удерживайте ⏻ в течение нескольких секунд, чтобы выключить прибор.

Выньте вилку прибора из розетки и убедитесь, что он остыл. Очистите поддон и корзину.

5. СОВЕТЫ ПО ПРИГОТОВЛЕНИЮ

Приведенные в таблицах значения температуры и времени приготовления являются ориентировочными. Они зависят от рецепта, а также от качества и количества используемых ингредиентов.

	 (кг)	 (мин)	 (°C)	
 Картофель и овощи				
Картофель фри, тонк., замороз.	0.3 - 0.7	9 - 16	180	Встряхните корзину
Картофель фри, толстый., замороз.	0.3 - 0.7	11 - 20	180	Встряхните корзину
Картофель фри (8 x 8 мм)	0.3 - 0.8	10 - 16	180	Встряхните корзину / добавьте 1/2 столовой ложки растительного масла
Ломтики картофеля, свежие	0.3 - 0.8	18 - 22	180	Встряхните корзину / добавьте 1/2 столовой ложки растительного масла
Кубики картофеля	0.3 - 0.75	12 - 18	180	Встряхните корзину / добавьте 1/2 столовой ложки растительного масла
Фаршированные овощи	0.1 - 0.4	10	170	-
Овощи	0.1 - 0.4	10	170	-
 Мясо, рыба и птица				
Стейк	0.1 - 0.5	8 - 12	200	-
Свинные отбивные	0.1 - 0.5	10 - 14	200	-
Гамбургеры	0.1 - 0.5	7- 14	200	-
Сосиски в тесте	0.1 - 0.5	13 - 15	200	-
Куриные ножки	0.1 - 0.5	18 - 22	180	-
Куриная грудка	0.1 - 0.5	10 - 15	185	-
Цыпленок	0.9 - 1.2	40 - 50	180	-

	 (кг)	 (мин)	 (°C)	
 Закуски				
Спринг-роллы, замороженные	0.1 - 0.4	8 - 10	200	Встряхните корзину
Кусочки курицы в панировке, заморож.	0.1 - 0.5	6 - 10	200	Встряхните корзину
Рыбные палочки, заморож.	0.1 - 0.4	6 - 10	200	-
Сырная закуска в панировке, заморож.	0.1 - 0.4	8 - 10	180	-
 Выпечка				
Пироги	0.3	20 - 25	165	Используйте форму для выпечки
Киш	0.4	20 - 22	185	Используйте форму для выпечки / посуду для выпечки
Маффины	0.3	15 - 18	200	Используйте форму для выпечки

6. ПРИМЕЧАНИЕ ОТНОСИТЕЛЬНО ОЧИСТКИ

 <p>Средства для очистки и аксессуары Мойте поддон и корзину мягкой губкой, смоченной теплой водой с моющим средством. Поддон и корзину можно мыть в посудомоечной машине. Очищайте нагревательный элемент с помощью щетки. Вытирайте прибор снаружи мягкой тряпкой.</p>	<p>Ежедневное использование Перед очисткой выньте вилку прибора из розетки и убедитесь, что он остыл. Прибор необходимо очищать от загрязнений после каждого использования.</p>
---	--

7. ЧТО ДЕЛАТЬ, ЕСЛИ...

Неисправность	Убедитесь, что...
Прибор не включается или не работает.	<ul style="list-style-type: none"> • Прибор подключен к сети электропитания надлежащим образом. • Задано время приготовления.

Неисправность	Убедитесь, что...
Не удается задвинуть поддон в прибор.	<ul style="list-style-type: none"> Загрузка корзины не превышает максимальной отметки. Корзина вставлена надлежащим образом. Она устанавливается в поддон со щелчком.
Из прибора выходит белый дым.	<ul style="list-style-type: none"> Готовящийся продукт не слишком жирный. Поддон и корзина чистые.

8. ТЕХНИЧЕСКИЕ ДАННЫЕ

8.1 Технические данные

Напряжение	220-240 В
Частота	50 - 60 Гц

Дата изготовления изделия указана в его серийном номере, где первая цифра номера соответствует последней цифре года изготовления, а вторая и третья цифры – порядковому номеру недели. Например, серийный номер 14512345 означает, что изделие изготовлено на сорок пятой неделе 2021 года.

Изготовитель: Electrolux Appliances AB, St. Göransgatan 143, 105 45 Stockholm, Швеция

Импортер и уполномоченная изготовителем организация:
ООО "Электролюкс Рус", Кожевнический проезд 1, 115114, Москва, тел.: 8-800-444-444-8

Изготовлено в Китае

1. ОПШТИ ПРИКАЗ

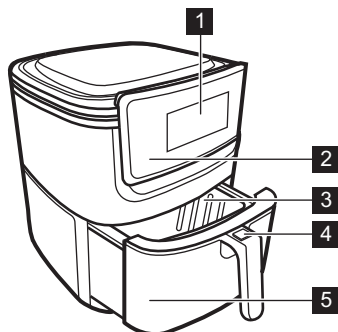

- 1 Дисплеј
- 2 Командна табла
- 3 Корпа
- 4 Сигурносна брава са заштитним поклопцем
- 5 Тигањ

2. КОМАНДНА ТАБЛА

2.1 Командна табла

Упознајте се са основним иконицама на командној табли и на дисплеју.

УКЉУЧЕНО/ ИСКЉУЧЕНО	Горе	Доле	Температура	Трајање

Кухање асистенцију - кувајте са аутоматским подешавањем времена и температуре.

Риба	Одрезак	Пилећи батаци	Пиле
Поврће	Помфрит	Мини пица	Мафини

2.2 Дисплеј

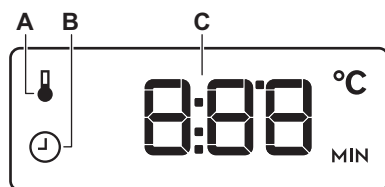

- A. Подешавања температуре
- B. Подешавање времена
- C. Време / температура

3. ПРЕ ПРВЕ УПОТРЕБЕ



Уклонити сву амбалажу, налепнице и заштитну фолију.



Очистите корпу и посуду топлом водом, течношћу за прање и меком крпом.
Унутрашњост и спољашњост уређаја осушите крпом.

4. СВАКОДНЕВНА УПОТРЕБА

4.1 Како да користите: посуду и корпу

Поставите уређај на стабилну површину.

1. Уклоните посуду и ставите је на стабилну површину.
2. Уклоните заштитни поклопац са сигурносне браве.
3. Притисните сигурносну браву да бисзе уклонили корпу.

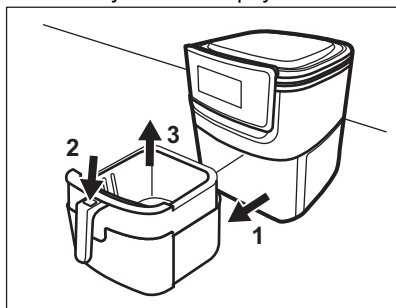

4. Ставите храну у корпу до максималног нивоа. Максимални капацитет корпе је 2 kg.

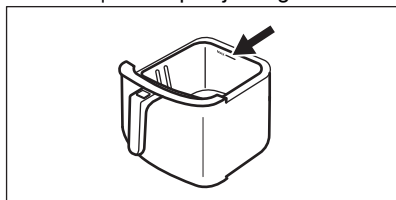

4.2 Како да кувате

Ставите храну у корпу. Укључите уређај.

1. - притисните и задржите.
2. Изаберите јело са листе за Кување уз асистенцију:

Симбол	Подешавање
	140 °C 15 min
	200 °C 10 min
	180 °C 20 min
	180 °C 45 min
	170 °C 15 min
	180 °C 15 min
	180 °C 10 min
	180 °C 15 min



3. Притисните: .

Када се време кувања заврши, оглашава се звучни сигнал.

Вентилатор за хлађење ради неколико секунди.

Можете да промените подешавања и да искључите уређај током кувања:









- Притисните симбол хране да бисте променили програм.







-  ,  - притисните да бисте подесили подешавање времена или температуре.
-  - притисните и задржите неколико секунди да бисте искључили уређај.

Искључите уређај из мреже и сачекајте да се охлади. Очистите посуду и корпу.

5. САВЕТИ У ВЕЗИ СА КУВАЊЕМ

Температура и време кувања наведени у табелама су само оријентациони. Они зависе од рецепата, квалитета и количине употребљених састојака.

	 (kg)	 (min)	 (°C)	
 Кромпир и поврће				
Помфрит, танак, смрзнуто	0.3 - 0.7	9 - 16	180	Протресите корпу
Помфрит, дебео, смрзнуто	0.3 - 0.7	11 - 20	180	Протресите корпу
Помфрит (8 mm x 8 mm)	0.3 - 0.8	10 - 16	180	Протресите корпу / Додајте 1/2 кашике уља
Исечени кромпир, свеж	0.3 - 0.8	18 - 22	180	Протресите корпу / Додајте 1/2 кашике уља
Коцкице од кромпира	0.3 - 0.75	12 - 18	180	Протресите корпу / Додајте 1/2 кашике уља
Пуњено поврће	0.1 - 0.4	10	170	-
Поврће	0.1 - 0.4	10	170	-
 Месо и живина				
Одрезак	0.1 - 0.5	8 - 12	200	-
Свињски одресци	0.1 - 0.5	10 - 14	200	-
Пљескавица	0.1 - 0.5	7 - 14	200	-
Рол-виршле	0.1 - 0.5	13 - 15	200	-
Пилећи батаци	0.1 - 0.5	18 - 22	180	-
Пилеће груди	0.1 - 0.5	10 - 15	185	-
Пиле	0.9 - 1.2	40 - 50	180	-
 Закуске				
Земичке, замрзнуте	0.1 - 0.4	8 - 10	200	Протресите корпу

	 (kg)	 (min)	 (°C)	
Пилећи медаљони, смрзнуто	0.1 - 0.5	6 - 10	200	Протресите корпу
Рибљи штапићи, смрзнуто	0.1 - 0.4	6 - 10	200	-
Грицкалице од сира у презлама, смрзнуте	0.1 - 0.4	8 - 10	180	-
 Печење				
Колачи	0.3	20 - 25	165	Користите плех за печење
Киш	0.4	20 - 22	185	Користите плех за печење / посуђе за рерну
Мафини	0.3	15 - 18	200	Користите плех за печење

6. НАПОМЕНЕ У ВЕЗИ СА ЧИШЋЕЊЕМ

	Средства за чишћење и прибор	Свакодневна употреба
	<p>Очистите посуду и корпу меким сунђером користећи топлу воду и течност за прање. Посуда и корпа могу се прати у машини за прање судова.</p> <p>Очистите грејни елемент четком за чишћење.</p> <p>Очистите спољну страну уређаја меком крпом.</p>	<p>Пре чишћења искључите уређај из мреже и сачекајте да се охлади.</p> <p>Уређај очистите након сваке употребе.</p>

7. ШТА УЧИНИТИ АКО...

Проблем	Проверите да ли...
Не можете да укључите уређај нити да га користите.	<ul style="list-style-type: none"> Уређај је правилно прикључен на електричну мрежу. Време кувања је подешено.
Не можете да убаците посуду у уређај.	<ul style="list-style-type: none"> Корпа није напуњена преко њеног максималног капацитета. Корпа је правилно постављена. Треба да кликне када је убаците у посуду.
Из уређаја излази бели дим.	<ul style="list-style-type: none"> Храна коју припремате није масна. Посуда и корпа су чисте.

8. ТЕХНИЧКИ ПОДАЦИ

8.1 Технички подаци

Напон	220 - 240 V
Фреквенција	50 - 60 Hz

1. CELKOVÝ PREHĽAD

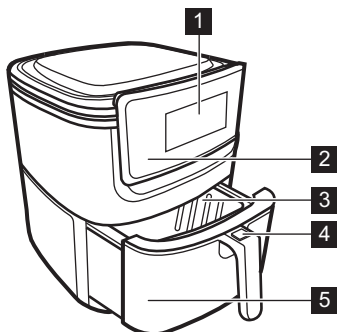

- 1 Displej
- 2 Ovládací panel
- 3 Kôš
- 4 Bezpečnostný zámok s ochranným krytom
- 5 Pekáč









2. OVLÁDACÍ PANEL

2.1 Ovládací panel

Oboznámte sa so základnými ikonami na ovládacom paneli a displeji.

				
ZAP/VYP	Hore	Dole	Teplota	Trvanie

Sprievodca pečením – pečte s automatickými nastaveniami času a teploty.

			
Ryba	Steak	Kuracie stehná	Kurča
			
Zelenina	Hranolčky	Minipizza	Muffiny

2.2 Displej

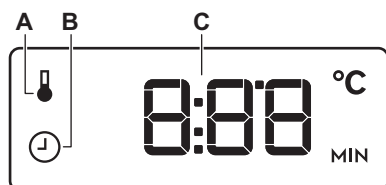

- A. Nastavenie teploty
- B. Nastavenie času
- C. Čas / teplota

3. PRED PRVÝM POUŽITÍM



Odstráňte všetky obaly, značenia a ochrannú fóliu.



Vyčistite kôš a panvicu teplou vodou, saponátom a jemnou handričkou.
Vysušte vnútro a vonkajšok spotrebiča handričkou.

4. KAŽDODENNÉ POUŽÍVANIE

4.1 Používanie: pekáč a kôš

Spotrebič položte na stabilný povrch.

1. Vyberte pekáč a položte ho na stabilný povrch.
2. Vyberte ochranný kryt na bezpečnostnom zámku.
3. Stlačte bezpečnostný zámok, aby ste vybrali kôš.

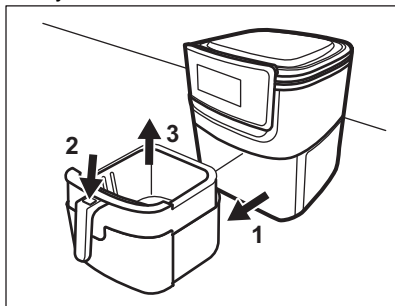

4. Naplňte kôš jedlom po maximálnu úroveň. Maximálny objem koša je 2 kg.

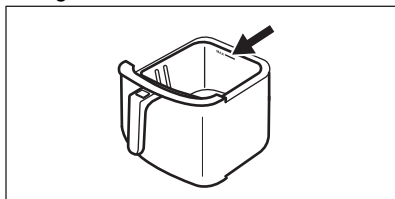

4.2 Príprava jedla

Jedlo vložte do koša. Zapojte spotrebič do elektrickej siete.

1. ① – stlačte a podržte.
2. Vyberte pokrm zo Sprievodca pečením:

Symbol	Nastavenie
	140 °C 15 min
	200 °C 10 min
	180 °C 20 min
	180 °C 45 min
	170 °C 15 min
	180 °C 15 min
	180 °C 10 min
	180 °C 15 min

3. Stlačte: ①.

Keď čas pečenia uplynie, zaznie zvukový signál. Niekoľko sekúnd je v činnosti ventilátor.









Počas pečenia môžete zmeniť nastavenia a vypnúť spotrebič:







- Stlačte symbol jedla, aby ste zmenili program.
- ^, v – stlačte, aby ste upravili nastavenia času alebo teploty.
- ① – stlačte a podržte na niekoľko sekúnd, aby ste vypili spotrebič.

Spotřebič odpojte od elektrické sítě a počkejte, kým nevychladne. Vyčistíte pekáč a kôš.

5. RADY NA PEČENIE

Teploty a časy pečenia uvedené v tabuľkách sú iba orientačné. Závisia od konkrétneho receptu, množstva a kvality použitých prísad.

	 (kg)	 (min)	 (°C)	
 Zemiaky a zelenina				
Hranolky, tenké, mrazené	0.3 - 0.7	9 - 16	180	Potraste košom
Hranolky, hrubé, mrazené	0.3 - 0.7	11 - 20	180	Potraste košom
Hranolčeky (8 x 8 mm)	0.3 - 0.8	10 - 16	180	Potraste košom / Pridajte 1/2 polievkovej lyžice oleja
Americké zemiaky	0.3 - 0.8	18 - 22	180	Potraste košom / Pridajte 1/2 polievkovej lyžice oleja
Zemiaky na kocky	0.3 - 0.75	12 - 18	180	Potraste košom / Pridajte 1/2 polievkovej lyžice oleja
Plnená zelenina	0.1 - 0.4	10	170	-
Zelenina	0.1 - 0.4	10	170	-
 Mäso a hydina				
Steak	0.1 - 0.5	8 - 12	200	-
Bravčové kotlety (hrubšie a s kosťou)	0.1 - 0.5	10 - 14	200	-
Hamburger	0.1 - 0.5	7- 14	200	-
Údeninové rolky	0.1 - 0.5	13 - 15	200	-
Kuracie stehná	0.1 - 0.5	18 - 22	180	-
Kuracie prsia	0.1 - 0.5	10 - 15	185	-
Kurča	0.9 - 1.2	40 - 50	180	-
 Malé pokrmy				
Jarné závitky, mrazené	0.1 - 0.4	8 - 10	200	Potraste košom
Kurča vcelku, mrazené	0.1 - 0.5	6 - 10	200	Potraste košom
Rybíe prsty, mrazené	0.1 - 0.4	6 - 10	200	-

	 (kg)	 (min)	 (°C)	
Strúhankové syrové chuťovky, mrazené	0.1 - 0.4	8 - 10	180	-
 Pečenie				
Koláče	0.3	20 - 25	165	Použite formu na pečenie
Slaný koláč	0.4	20 - 22	185	Použite formu na pečenie / riad do rúry
Muffiny	0.3	15 - 18	200	Použite formu na pečenie

6. POZNÁMKY K ČISTENIU



Čistiace prostriedky a príslušenstvo

Pekáč a kôš očistíte mäkkou utierkou namočenou v teplej vode s prídavkom saponátu. Pekáč a kôš sú vhodné do umývačky riadu. Ohrevný článok vyčistíte čistiacou kefkou. Vonkajšok spotrebiča očistíte vlhkou handričkou.

Každodenné používanie

Spotrebič pred čistením odpojte od elektrickej siete a počkajte, kým nevychladne. Spotrebič vyčistíte po každom použití.

7. ČO ROBIŤ, KEĎ...

Problém	Skontrolujte, či...
Spotrebič sa nedá zapnúť ani používať.	<ul style="list-style-type: none"> Spotrebič je správne pripojený ku zdroju elektrického napájania. Bola nastavená doba pečenia.
Nemôžete vsunúť pekáč do spotrebiča.	<ul style="list-style-type: none"> Kôš nie je naplnený nad maximálnu kapacitu. Kôš je vložený správne. Pri vložení do pekáča musí zaklapnúť.
Zo spotrebiča vychádza biely dym.	<ul style="list-style-type: none"> Jedlo, ktoré pripravujete, nie je masťné. Pekáč a kôš sú čisté.

8. TECHNICKÉ ÚDAJE

8.1 Technické údaje

Napätie	220 – 240 V
Frekvencia	50 - 60 Hz

1. SPLOŠNI PREGLED

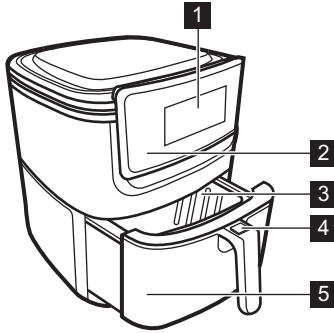



- 1 Prikazovalnik
- 2 Upravljalna plošča
- 3 Košara
- 4 Varnostni zaklep z zaščitnim pokrovom
- 5 Pekač









2. UPRAVLJALNA PLOŠČA

2.1 Upravljalna plošča

Seznanite se z osnovnimi ikonami na upravljalni plošči in prikazovalniku.

				
VKLOP/ IZKLOP	Gor	Dol	Temperatura	Trajanje

Kuharski pomočnik - kuhajte s samodejnimi nastavitvami časa in temperature.

			
Ribe	Zrezek	Piščančja bedra	Piščanec
			
Zelenjava	Ocvrti krompir	Mini pizza	Mafini

2.2 Prikazovalnik

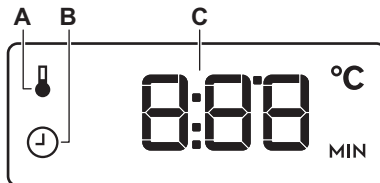

- A. Nastavitev temperature
- B. Nastavitev časa
- C. Čas/Temperatura

3. PRED PRVO UPORABO



Odstranite vso embalažo, etikete in zaščitno folijo.



Očistite košaro in pekač s toplo vodo, tekočino za pomivanje in mehko krpo. Notranjost in zunanost naprave osušite s krpo.

4. VSAKODNEVNA UPORABA

4.1 Uporaba: pekača in košare

Napravo postavite na stabilno površino.

1. Odstranite pekač in ga postavite na stabilno površino.
2. Odstranite zaščitni pokrov na varnostnem zaklepu.
3. Pritisnite varnostni zaklep, da odstranite košaro.

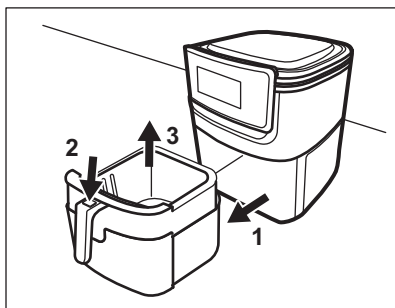

4. Živila zložite v košaro do najvišje ravni. V košaro lahko zložite največ 2 kg.

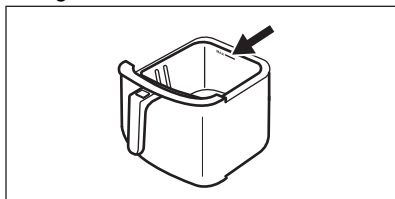

4.2 Pečenje

Hrano položite v košaro. Vtič vtaknite v vtičnico.

1. ① - pritisnite in držite.
2. Izberite jed iz kuharskega pomočnika:

Simbol	Nastavitev
	140 °C 15 min.
	200 °C 10 min.
	180 °C 20 min.
	180 °C 45 min.
	170 °C 15 min.
	180 °C 15 min.
	180 °C 10 min.
	180 °C 15 min.

3. Pritisnite: ①.

Ko je pečenje končano, se oglasi zvočni signal. Ventilator za hlajenje deluje nekaj sekund.









Med pečenjem lahko spremenite nastavitve in izklopite napravo:







- Za spremembo programa pritisnite simbol za živila.
- ^, v - pritisnite za nastavitev časa ali temperature.
- ① - pritisnite in držite nekaj sekund za izklop naprave.

Izključite napravo in počakajte, da se ohladi. Očistite pekač in košaro.

5. NASVETI ZA PEČENJE

Temperature in časi pečenja v razpredelnicah so le smernice. Odvisni so od recepta, kakovosti in količine uporabljenih sestavin.

	 (kg)	 (min.)	 (°C)	
 Krompir in zelenjava				
Ocvrti krompir, tanek, zamrznjen	0.3 - 0.7	9 - 16	180	Stresite košaro
Ocvrti krompir, debel, zamrznjen	0.3 - 0.7	11 - 20	180	Stresite košaro
Ocvrti krompir (8 x 8 mm)	0.3 - 0.8	10 - 16	180	Stresite košaro/Dodajte 1/2 žlice olja
Krompirjevi krhliji, sveži	0.3 - 0.8	18 - 22	180	Stresite košaro/Dodajte 1/2 žlice olja
Krompirjeve kocke	0.3 - 0.75	12 - 18	180	Stresite košaro/Dodajte 1/2 žlice olja
Polnjena zelenjava	0.1 - 0.4	10	170	-
Zelenjava	0.1 - 0.4	10	170	-
 Meso in perutnina				
Zrezek	0.1 - 0.5	8 - 12	200	-
Svinjski kotleti	0.1 - 0.5	10 - 14	200	-
Hamburger	0.1 - 0.5	7 - 14	200	-
Mesni zvitki	0.1 - 0.5	13 - 15	200	-
Piščančja bedra	0.1 - 0.5	18 - 22	180	-
Piščančje prsi	0.1 - 0.5	10 - 15	185	-
Piščanec	0.9 - 1.2	40 - 50	180	-
 Prigrizki				
Spomladanski zvitki, zamrznjeni	0.1 - 0.4	8 - 10	200	Stresite košaro
Piščančji medaljoni, zamrznjeni	0.1 - 0.5	6 - 10	200	Stresite košaro
Ribje palčke, zamrznjene	0.1 - 0.4	6 - 10	200	-

	 (kg)	 (min.)	 (°C)	
Sirovi prigrizki, zamrznjeni	0.1 - 0.4	8 - 10	180	-
 Pečenje kruha in peciva				
Pecivo	0.3	20 - 25	165	Uporabite pekač
Kiš	0.4	20 - 22	185	Uporabite pekač/posodo za pečico
Mafini	0.3	15 - 18	200	Uporabite pekač

6. OPOMBE GLEDE ČIŠČENJA

	<p>Čistilna sredstva in dodatki Pekač in košaro očistite z mehko gobico, toplo vodo in sredstvom za pomivanje. Pekač in košara sta primerna za pomivanje v pomivalnem stroju. Grelec čistite s čistilno ščetko. Zunanost naprave čistite s mehko krpo.</p>	<p>Vsakodnevna uporaba Pred čiščenjem izključite napravo in počakajte, da se ohladi. Napravo po vsaki uporabi očistite.</p>
---	---	--

7. KAJ STORITE V PRIMERU ...

Težava	Preverite, če ...
Naprave ni mogoče vklopiti ali je uporabljati.	<ul style="list-style-type: none"> Naprava je pravilno priključena na napajanje. Čas pečenja je nastavljen.
Pekača ne morete potisniti v napravo.	<ul style="list-style-type: none"> Košara ni povsem napolnjena. Košara je nameščena pravilno. Ko jo položite v pekač, se mora zaskočiti.
Iz naprave prihaja bel dim.	<ul style="list-style-type: none"> Živila, ki jih pripravljate, niso mastna. Pekač in košara sta čista.

8. TEHNIČNI PODATKI

8.1 Tehnični podatki

Napetost	220 - 240 V
Frekvenca	50 - 60 Hz

1. ALLMÄN ÖVERSIKT

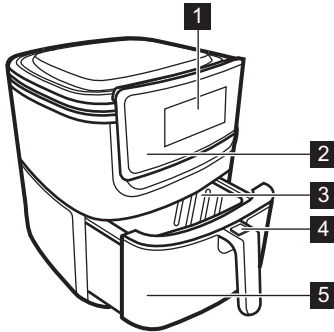

- 1 Display
- 2 Kontrollpanel
- 3 Korg
- 4 Säkerhetslås med skyddslock
- 5 Form

2. KONTROLLPANELEN

2.1 Kontrollpanel

Bekanta dig med de grundläggande ikonerna på kontrollpanelen och på skärmen.

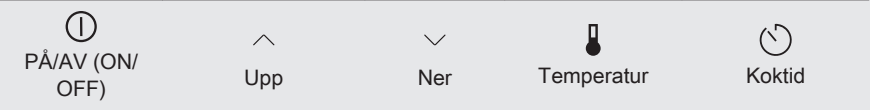

Tillagningshjälp - tillaga med automatiska tids- och temperaturinställningar.



2.2 Display

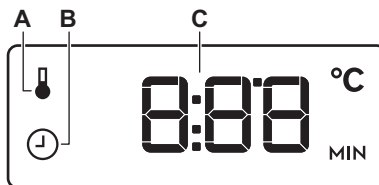

- A. Värmeläge
- B. Ställa in klockan
- C. Tid/temperatur

3. FÖRE FÖRSTA ANVÄNDNING



Ta bort alla förpackningar, märkning och skyddsfilm.



Rengör korgen och formen med varmt vatten, diskmedel och en mjuk svamp.
Torka torrt på insidan och utsidan med en handduk.

4. DAGLIG ANVÄNDNING

4.1 Användning: form och korg

Placera produkten på en stabil yta.

1. Ta bort formen och placera den på en stabil yta.
2. Ta bort skyddet på säkerhetslåset.
3. Tryck på säkerhetslåset för att ta bort korgen.

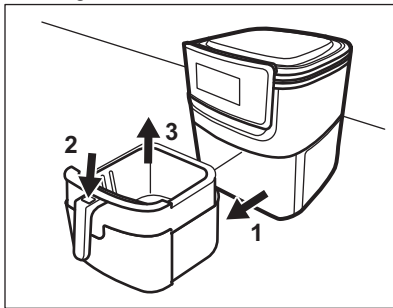

4. Lägg mat i korgen upp till maximala nivån. Korgen rymmer maximalt 2 kg.

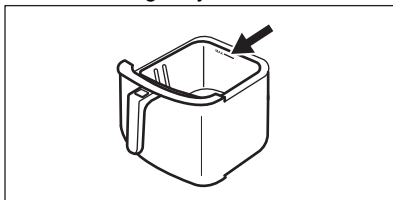

4.2 Hur man tillagar

Lägg maten i korgen. Anslut produkten.

1. - tryck och håll intryckt.
2. Välj maträtt från Assisterad tillagningsfunktion:

Symbol	Inställning
	140 °C 15 min
	200 °C 10 min
	180 °C 20 min
	180 °C 45 min
	170 °C 15 min
	180 °C 15 min
	180 °C 10 min
	180 °C 15 min

3. Tryck på: .

En ljudsignal hörs när tillagningstiden uppnåtts. Kylfläkten sätts igång i några sekunder.









Du kan ändra inställningar och stänga av produkten under tillagning:







- Tryck på matsymbolen för att byta program.
- , - tryck för att ändra tids- eller temperaturinställning.
- - tryck och håll inne i några sekunder för att stänga av produkten.

Koppla ur produkten och vänta tills den är kall. Rengör formen och korgen.

5. MATLAGNINGSTIPS

Temperaturen och gräddningstiderna i tabellerna är endast riktvärden. De beror på recepten samt på ingrediensernas kvalitet och mängd.

	 (kg)	 (min.)	 (°C)	
 Potatis och grönsaker				
Pommes Frites, tunna, fryst	0.3 - 0.7	9 - 16	180	Skaka korgen
Pommes Frites, tjocka, fryst	0.3 - 0.7	11 - 20	180	Skaka korgen
Pommes Frites(8 x 8 mm)	0.3 - 0.8	10 - 16	180	Skaka korgen/ tillsätt 1/2 msk olja
Potatisklyftor, färska	0.3 - 0.8	18 - 22	180	Skaka korgen/ tillsätt 1/2 msk olja
Potatis i tärningar	0.3 - 0.75	12 - 18	180	Skaka korgen/ tillsätt 1/2 msk olja
Fyllda grönsaker	0.1 - 0.4	10	170	-
Grönsaker	0.1 - 0.4	10	170	-
 Kött och fågel				
Biff	0.1 - 0.5	8 - 12	200	-
Fläskkotletter	0.1 - 0.5	10 - 14	200	-
Hamburgare	0.1 - 0.5	7- 14	200	-
Inbakad korv	0.1 - 0.5	13 - 15	200	-
Kycklinglär	0.1 - 0.5	18 - 22	180	-
Kycklingbröst	0.1 - 0.5	10 - 15	185	-
Kyckling	0.9 - 1.2	40 - 50	180	-
 Tilltugg				
Vårullar, frysta	0.1 - 0.4	8 - 10	200	Skaka korgen
Chicken nuggets, fryst	0.1 - 0.5	6 - 10	200	Skaka korgen
Fiskpinnar, fryst	0.1 - 0.4	6 - 10	200	-
Panerade ostsnacks, frysta	0.1 - 0.4	8 - 10	180	-

		 (kg)	 (min.)	 (°C)	
 Gräddning					
Kakor		0.3	20 - 25	165	Använd en bakform
Quiche		0.4	20 - 22	185	Använd en bakform/ugnsform
Muffins		0.3	15 - 18	200	Använd en bakform

6. ANMÄRKNINGAR OM RENGÖRING

	Rengöringsmedel och tillbehör	Daglig användning
	<p>Torka av formen och korgen med en mjuk trasa med varmt vatten och diskmedel.</p> <p>Formen och korgen går att diska i diskmaskinen.</p> <p>Rengör värmeelementet med en rengöringsborste.</p> <p>Rengör produktens utsida med en mjuk trasa.</p>	<p>Koppla ur produkten och vänta tills den är kallt innan den rengörs.</p> <p>Rengör produkten efter varje användningstillfälle.</p>

7. OM PRODUKTEN INTE FUNGERAR ...

Problem	Kontrollera att...
Det går inte att aktivera eller använda produkten.	<ul style="list-style-type: none"> • Produkten är korrekt ansluten till strömförsörjningen. • Tillagningstiden är inställd.
Formen kan inte sättas in i produkten.	<ul style="list-style-type: none"> • Korgen inte är fylld över maximal kapacitet. • Korgen är placerad korrekt. Det ska klicka när du sätter in formen.
Vit rök kommer ut.	<ul style="list-style-type: none"> • Maten du lagar är inte fet. • Formen och korgen är rena.

8. TEKNISKA DATA

8.1 Tekniska data

Nätspänning	220 - 240 V
Frekvens	50 - 60 Hz

1. GENEL BAKIŞ

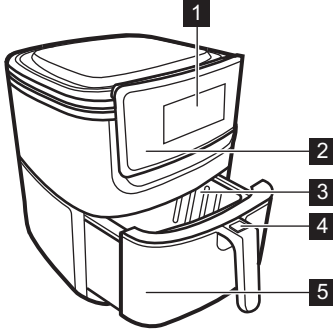

- 1 Gösterge Ekranı
- 2 Kontrol paneli
- 3 Sepet
- 4 Koruma kapaklı emniyet kilidi
- 5 Tava/Pişirme kabı

2. KONTROL PANELİ

2.1 Kontrol paneli

Kontrol paneli ve ekran üzerindeki temel simgeler hakkında bilgi edinin.

AÇIK/KAPALI	Yukarı	Aşağı	Sıcaklık	Süre

Yardımlı Pişirme - otomatik süre ve sıcaklık ayarlarıyla pişirin.

Balık	Biftek	Tavuk bagnet	Tavuk
Sebzeler	Patates kızartması	Mini pizza	Muffin

2.2 Gösterge Ekranı

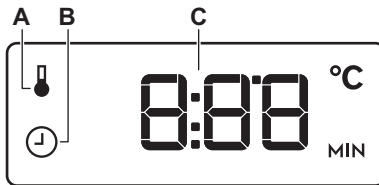

- A. Sıcaklık ayarı
- B. Zaman ayarı
- C. Zaman / sıcaklık

3. İLK KULLANIMDAN ÖNCE



Tüm ambalajı, etiketleri ve koruyucu filmi çıkarın.



Sepeti ve tavayı ılık su, bulaşık deterjanı ve yumuşak bir bezle temizleyin.
Cihazın içini ve dışını bir bezle kurulayın.

4. GÜNLÜK KULLANIM

4.1 Kullanım şekli: tava ve sepet

Cihazı sabit bir yüzeye koyun.

1. Tavayı çıkarın ve sabit bir yüzeye yerleştirin.
2. Güvenlik kilidindeki koruma kapağını çıkarın.
3. Sepeti çıkarmak için emniyet kilidine basın.

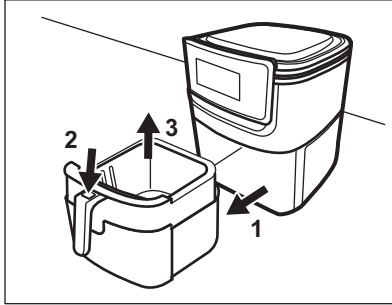

4. Sepete yiyecekleri maksimum seviyeye kadar koyun. Sepetin maksimum kapasitesi 2 kg'dır.

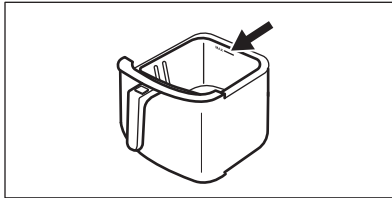

4.2 Nasıl pişirilir

Yiyeceği sepete koyun. Cihazın fişini prize takın.

1. ① - basılı tutun.
2. Yardımlı pişirme'den yemeği seçin:

Sembol	Ayar
	140°C 15 dak
	200°C 10 dak
	180°C 20 dak
	180°C 45 dak
	170°C 15 dak
	180°C 15 dak
	180°C 10 dak
	180°C 15 dak

3. Basın: ①.

Pişirme bittiğinde, sinyal duyulur.
Soğutma fanı birkaç saniye çalışır.

Pişirme sırasında ayarları değiştirebilir ve cihazı kapatabilirsiniz:







- Programı değiştirmek için yiyecek sembolüne basın.
- ^, v - zaman veya sıcaklık ayarlarını yapmak için basın.
- ① - cihazı kapatmak için birkaç saniye basılı tutun.

Cihazı fişten çekin ve soğuyana kadar bekleyin. Tavayı ve sepeti temizleyin.

5. PIŞIRME İPUÇLARI

Tablolarda verilen sıcaklıklar ve pişirme süreleri sadece bilgi amaçlıdır. Gerçek süreler, tariflere ve kullanılan malzemelerin kalitesine ve miktarına bağlıdır.

	 (kg)	 (min)	 (°C)	
 Patates ve sebzeler				
Patates kızartması, ince, dondurulmuş	0.3 - 0.7	9 - 16	180	Sepeti sallayın
Patates kızartması, kalın, dondurulmuş	0.3 - 0.7	11 - 20	180	Sepeti sallayın
Patates kızartması(8 x 8 mm)	0.3 - 0.8	10 - 16	180	Sepeti sallayın / 1/2 yemek kaşığı yağ ekleyin
Patates dilimleri, taze	0.3 - 0.8	18 - 22	180	Sepeti sallayın / 1/2 yemek kaşığı yağ ekleyin
Patates küpleri	0.3 - 0.75	12 - 18	180	Sepeti sallayın / 1/2 yemek kaşığı yağ ekleyin
Sebze dolması	0.1 - 0.4	10	170	-
Sebzeler	0.1 - 0.4	10	170	-
 Et ve kümes hayvanları				
Biftek	0.1 - 0.5	8 - 12	200	-
Keçi eti pizolalar	0.1 - 0.5	10 - 14	200	-
Hamburger	0.1 - 0.5	7- 14	200	-
Sosisli ekmek	0.1 - 0.5	13 - 15	200	-
Tavuk baget	0.1 - 0.5	18 - 22	180	-
Tavuk göğsü	0.1 - 0.5	10 - 15	185	-
Tavuk	0.9 - 1.2	40 - 50	180	-
 Atıştırmalıklar				
Sigara böreği, dondurulmuş	0.1 - 0.4	8 - 10	200	Sepeti sallayın
Tavuk parçaları, dondurulmuş	0.1 - 0.5	6 - 10	200	Sepeti sallayın
Balık kroket, dondurulmuş	0.1 - 0.4	6 - 10	200	-

	 (kg)	 (min)	 (°C)	
Ekmek gibi ufalanmış peynirli atıştırmalıklar, dondurulmuş	0.1 - 0.4	8 - 10	180	-
 Piştirme				
Kek ve pastalar	0.3	20 - 25	165	Piştirme kabı kullanın
Kiş	0.4	20 - 22	185	Piştirme kabı / fırın kabı kullanın
Muffin	0.3	15 - 18	200	Piştirme kabı kullanın

6. TEMİZLİK HAKKINDA AÇIKLAMALAR

	Temizlik maddeleri ve aksesuarları	Günlük kullanım
	Tavayı ve sepeti ılık su ve bulaşık deterjanı kullanarak yumuşak bir süngerle temizleyin. Tava ve sepet bulaşık makinesinde yıkanabilir. Isıtma elemanını bir temizlik fırçasıyla temizleyin. Cihazın dışını yumuşak bir bezle temizleyin.	Temizlemeden önce cihazın fişini çekin ve soğuyana kadar bekleyin. Her kullanımdan sonra cihazı temizleyin.

7. BU DURUMLARDA NE YAPMALI...

Problem	Aşağıdakileri kontrol ediniz...
Cihaz açılmıyor veya çalışmıyor.	<ul style="list-style-type: none"> Cihaz doğru şekilde bir elektrik prizine bağlanmış. Piştirme süresi ayarlanmıştır.
Tavayı cihaza kaydıramazsınız.	<ul style="list-style-type: none"> Sepet maksimum kapasitesinin üzerinde dolu değil. Sepet doğru şekilde yerleştirilmiş. Tava ya yerleştirdiğinizde tıklama sesi gelmelidir.
Cihazdan beyaz duman çıkmakta.	<ul style="list-style-type: none"> Hazırladığınız yiyecek yağlı değil. Tava ve sepet bulaşık temiz.

8. TEKNİK VERİLER

8.1 Teknik veriler

Voltaj	220 - 240 V
Sıklık	50 - 60 Hz

1. ЗАГАЛЬНИЙ ОГЛЯД

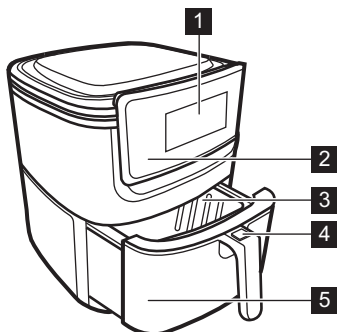

- 1 Дисплей
- 2 Панель керування
- 3 Кошик
- 4 Фіксуючий замок із захисною кришкою
- 5 Деко

2. ПАНЕЛЬ КЕРУВАННЯ

2.1 Панель керування

Ознайомтеся з основними символами на панелі керування та дисплеї.

УВИМК./ВИМК.	Вгору	Вниз	Температура	Тривалість

Допоможене приготування - готування з автоматичними налаштуванням часу і температури.

Риба	Стейк	Курячі ніжки	Курка
Овочі	Картопля фрі	Міні-піца	Кекс

2.2 Дисплей

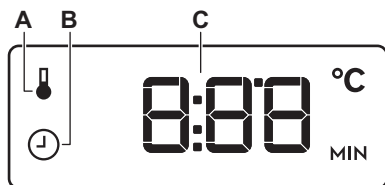

- A. Ступінь нагріву
- B. Налаштування часу
- C. Час / температура

3. ПЕРЕД ПЕРШИМ ВИКОРИСТАННЯМ



Зніміть усі пакувальні матеріали, етикетки та захисну плівку.



Помийте кошик і чашу м'якою ганчіркою з теплою водою і засобом для миття посуду.

Протріть насухо всередині і зовні серветкою.

4. ЩОДЕННЕ ВИКОРИСТАННЯ

4.1 Як користуватися: чаша і кошик

Встановіть прилад на стійкій поверхні.

1. Вийміть чашу та встановіть її на стійку поверхню.
2. Зніміть захисну кришку з фіксуючого замка.
3. Натисніть на фіксуючий замок, щоб вийняти кошик.

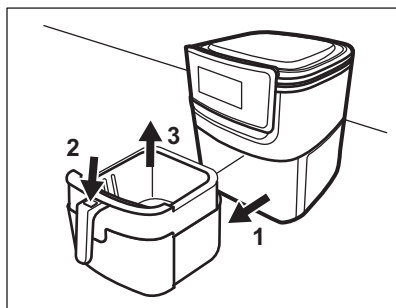

4. Покладіть продукти у кошик до максимального рівня.
Максимальна ємність кошика 2 кг.

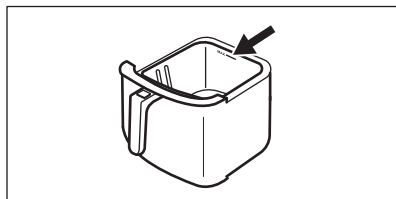

4.2 Як готувати

Покладіть продукти у кошик. Включіть прилад у розетку.

1. ① - натисніть і утримуйте.
2. Виберіть страву з меню «Допомога при готуванні».

Символ	Налаштування
	140°C 15 хв
	200°C 10 хв
	180°C 20 хв
	180°C 45 хв
	170°C 15 хв
	180°C 15 хв
	180°C 10 хв
	180°C 15 хв

3. Натисніть: ①.

Після завершення готування лунає звуковий сигнал. Вентилятор охолодження працює декілька секунд.

Під час приготування можна змінити налаштування і вимкнути прилад:









- Натисніть символ продукту, щоб змінити програму.
- ^, v - натисніть для регулювання налаштувань часу чи температури.







-  - натисніть і утримуйте декілька секунд, щоб вимкнути прилад.

Від'єднайте прилад від живлення і зачекайте, доки він охолоне. Очистіть чашу і кошик.

5. ПОРАДИ ЩОДО ГОТУВАННЯ

У таблицях вказані орієнтовні значення температури та часу приготування. Вони залежать від рецепту, а також якості й кількості інгредієнтів, що використовуються.

	 (кг)	 (хв.)	 (°C)	
 Картопля та овочі				
Картопля фрі, тонкими шматочками, заморожені	0.3 - 0.7	9 - 16	180	Потрусіть кошик
Картопля фрі, товстими шматочками, заморожені	0.3 - 0.7	11 - 20	180	Потрусіть кошик
Картопля фрі (8 x 8 мм)	0.3 - 0.8	10 - 16	180	Потрусіть кошик / Додайте 1/2 столової ложки олії
Картопляні скибочки, свіжі	0.3 - 0.8	18 - 22	180	Потрусіть кошик / Додайте 1/2 столової ложки олії
Картопляні кубики	0.3 - 0.75	12 - 18	180	Потрусіть кошик / Додайте 1/2 столової ложки олії
Фаршировані овочі	0.1 - 0.4	10	170	-
Овочі	0.1 - 0.4	10	170	-
 М'ясо та птиця				
Стейк	0.1 - 0.5	8 - 12	200	-
Відбивні котлети	0.1 - 0.5	10 - 14	200	-
Гамбургер	0.1 - 0.5	7- 14	200	-
Булочки з сосисками	0.1 - 0.5	13 - 15	200	-
Курячі ніжки	0.1 - 0.5	18 - 22	180	-
Куряча грудина	0.1 - 0.5	10 - 15	185	-
Курка	0.9 - 1.2	40 - 50	180	-
 Закуски				
Фаршировані млинці, заморожені	0.1 - 0.4	8 - 10	200	Потрусіть кошик

	 (кг)	 (хв.)	 (°C)	
Курячі нагетси, заморожені	0.1 - 0.5	6 - 10	200	Потрусіть кошик
Рибні палички, заморожені	0.1 - 0.4	6 - 10	200	-
Сирні закуски у паніровці, заморожені	0.1 - 0.4	8 - 10	180	-
 Випічка				
Торти	0.3	20 - 25	165	Використовуйте форму для випікання
Кіш	0.4	20 - 22	185	Використовуйте форму для випікання / посуд для духовки
Кекс	0.3	15 - 18	200	Використовуйте форму для випікання

6. ПРИМІТКИ ЩОДО ЧИЩЕННЯ

	<p>Засоби для чищення і аксесуари</p> <p>Помийте чашу і кошик м'якою губкою з теплою водою і засобом для миття посуду. Чашу і кошик можна мити у посудомийній машині. Очищуйте нагрівальний елемент щіткою для чищення. Зовнішню поверхню приладу слід протирати м'якою серветкою.</p>	<p>Щоденне користування</p> <p>Перед очищенням від'єднайте прилад від живлення и зачекайте, доки він охолоне. Очищуйте прилад після кожного використання.</p>
---	---	--

7. НЕОБХІДНІ ДІЇ В РАЗІ ВИНИКНЕННЯ ПРОБЛЕМ

Несправність	Перевірте чи...
Прилад не вмикається або не працює.	<ul style="list-style-type: none"> • прилад правильно під'єднано до електричної мережі. • встановлено час приготування.
Не вдається вставити чашу у прилад.	<ul style="list-style-type: none"> • не заповнено кошик понад максимальну місткість. • правильно розташовано кошик, ви маєте почути клацання при встановленні кошика в чашу.
З приладу виходить білий дим.	<ul style="list-style-type: none"> • їжа, яку ви готуєте, не жирна. • чаша і кошик чисті.

8. ТЕХНІЧНІ ДАНІ

8.1 Технічні дані

Напруга	220-240 В
Частота	50 - 60 Гц



867361838-A-192020