



Booklet available in English on
Heft in deutscher Sprache erhältlich auf
Livret disponible en français sur
Libretto disponibile in Italiano su
Folleto disponible en español en
如需中文版手册, 请访问





BRINGING THE ICONIC SCENE TO LIFE THROUGH LEGO® BRICKS



CASPER GLAHDER: LEGO® GRAPHIC DESIGNER

ATTICUS TSAI MCCARTHY: LEGO® DESIGNER

WOON TZE CHEE: LEGO® SENIOR DESIGNER

"BOY, DO I HATE BEING RIGHT ALL THE TIME"

DR. IAN MALCOLM'S POMPOUS PREDICTIONS COME TRUE AS THE T. REX ESCAPES ITS PADDOCK.

"I love *Jurassic Park*! For me, it's the ultimate blockbuster and this job gave me the perfect excuse to rewatch it at least five times as part of the process... all in the name of research, of course! I'm especially proud of the shaping of the T. rex's head, and the use of the LEGO® Speed Champions windscreen as the canopy of the Ford Explorer. But, more specifically, there's a green plate I put inside the T. rex that references the genetic make-up of all the dinosaurs at Jurassic Park. It's a simple touch, but I like that it's there."

ATTICUS TSAI MCCARTHY: LEGO® DESIGNER





"DON'T. MOVE."

DR. ALAN GRANT OFFERS A (SLIGHTLY HOPEFUL) SOLUTION TO AVOID BEING EATEN.

This model is a collaboration between Atticus, a fellow LEGO® Designer, and me. Atticus focused on the main vehicle and the T. rex while I worked on the display base and the flipped car. We're both huge fans of the movie, so we know exactly what this scene means to people, which meant there was definitely some pressure to make it perfect!

One of the most exciting things about working on this set is the sheer number of famous details and iconic elements contained within it. From the shaking cups of water that first signify the arrival of the T. rex, that infuriating lamp (turn it off!), the burst tyres, the chain that held the (ill-fated) goat ... and that's not even to mention the magnificent creature itself! There's just so much going on, and that presents an interesting challenge for us, because we must keep everything in the right size and proportion in relation to the minifigures. Too much detail and things get very large, very quickly. Keep the object small and there may not be enough intricacy. In the end I think we found the right balance for the model to work as a scene while delivering a big hit of nostalgia. We hope our fellow *Jurassic Park* fans feel the same!

WOON TZE CHEE: LEGO® SENIOR DESIGNER

"RAAAWWKKKK!"

THE T. REX INTRODUCES HIMSELF TO A TERRIFIED TIM AND LEX MURPHY.

"It was my role to bring to life all the graphic elements within the set – particularly all the signs and stickers. It was a real honor to be able to work on the Ford Explorer, as it's the first time this has been brought to life in a LEGO® set and I know it's something fans have been calling for. I wanted to make it feel completely authentic and cover all those fun little details like the warning signs and the touchscreen inside the car. I'm also really pleased with how the T. rex's eyes came out, especially as they're such a memorable (and scary) part of the scene!"

CASPER GLAHDER: LEGO® GRAPHIC DESIGNER



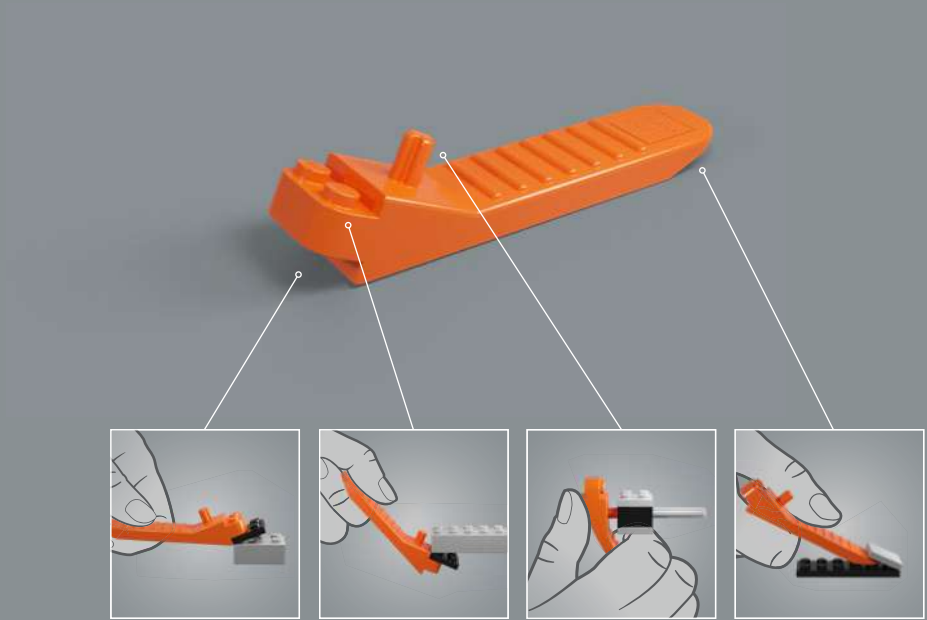

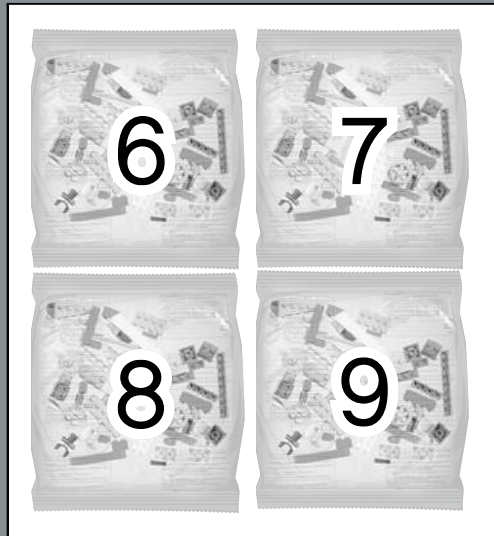
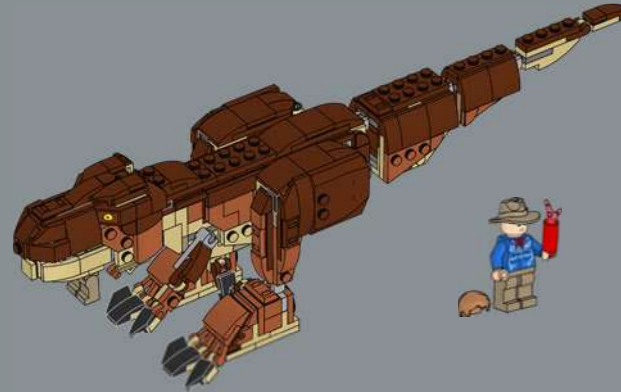
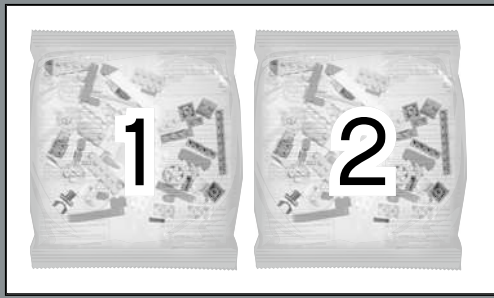

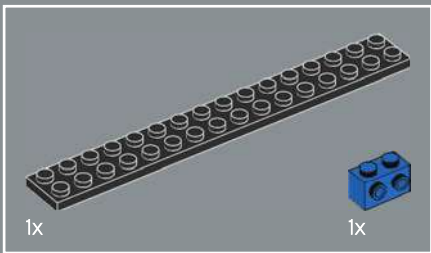
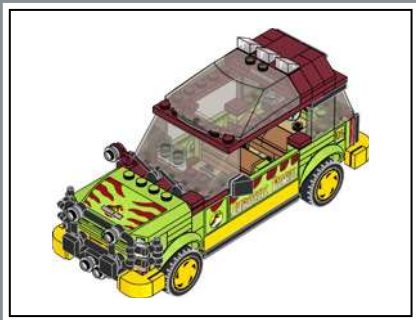
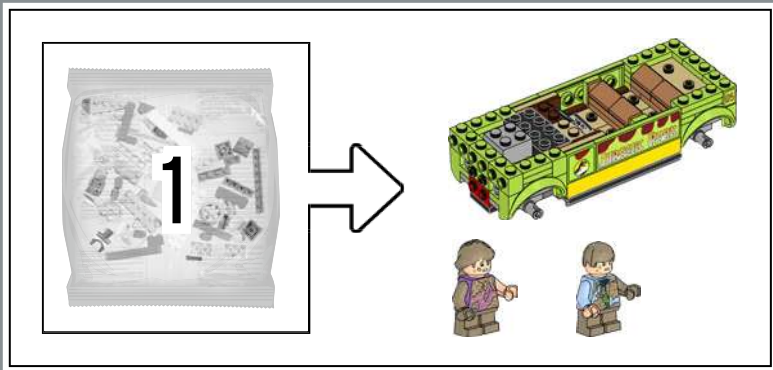

1

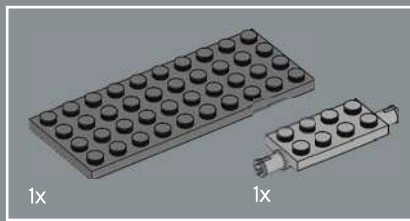
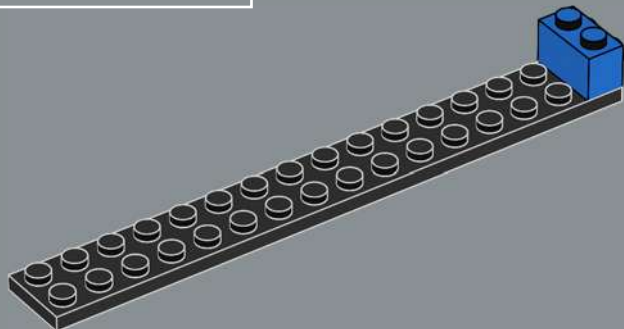

2

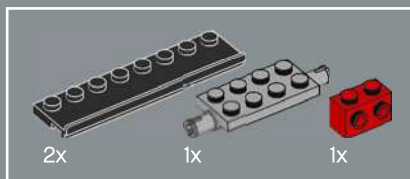
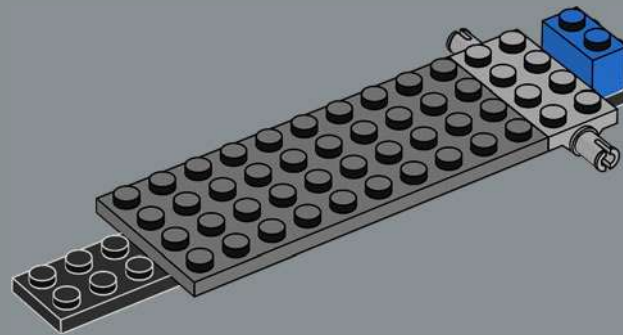

3

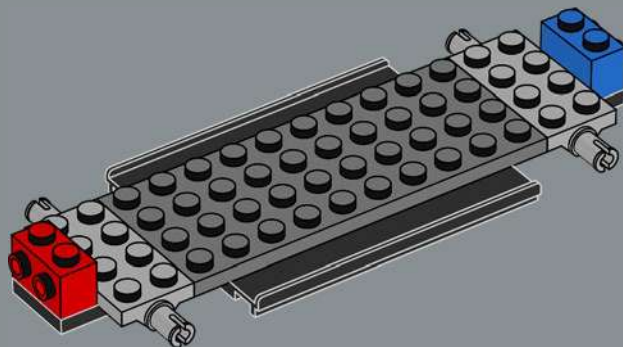

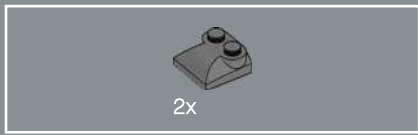

4

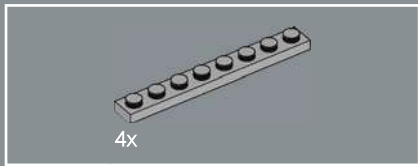
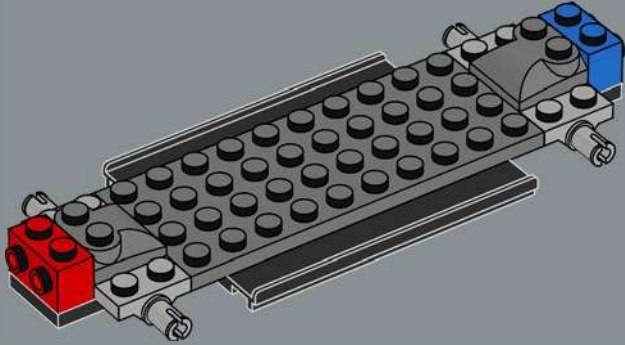

5

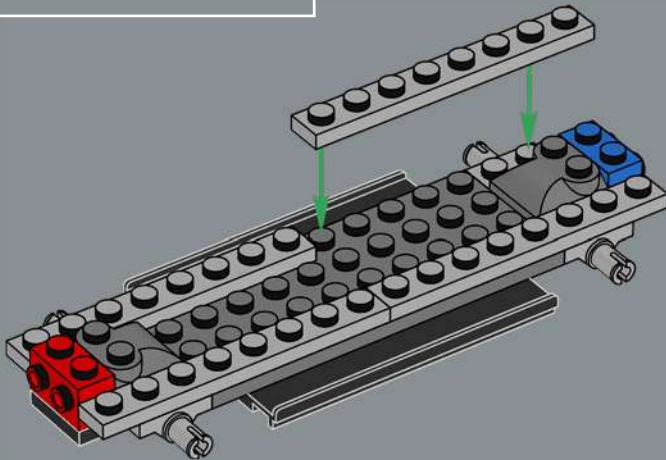

6

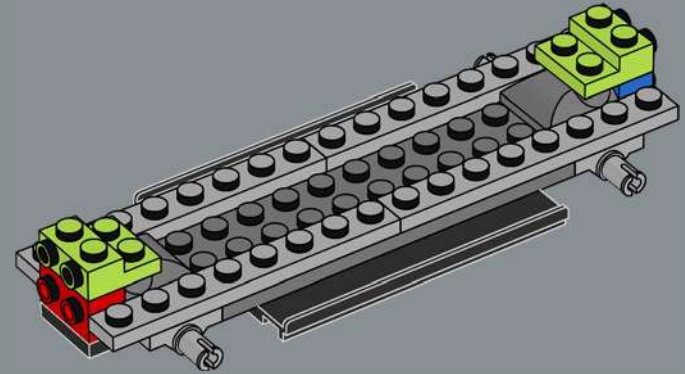

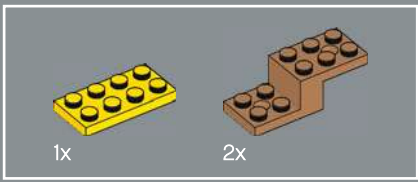

7

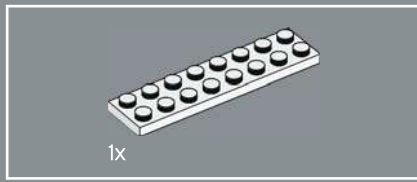
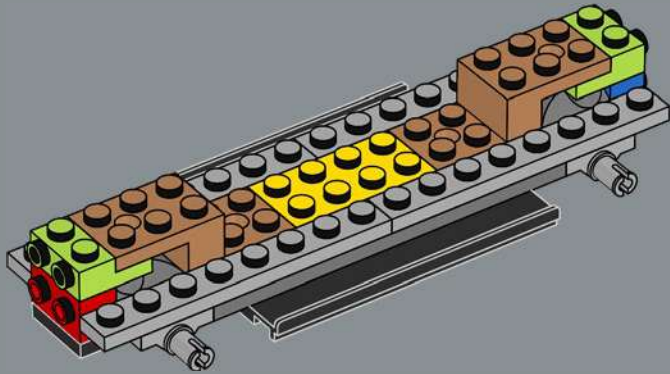

8

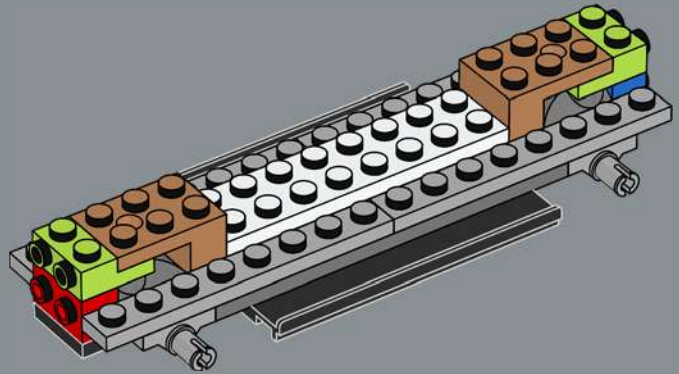

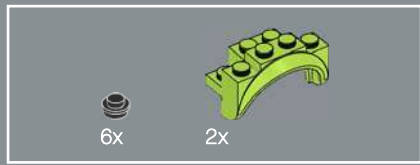

9

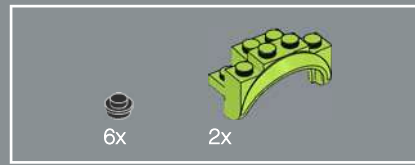
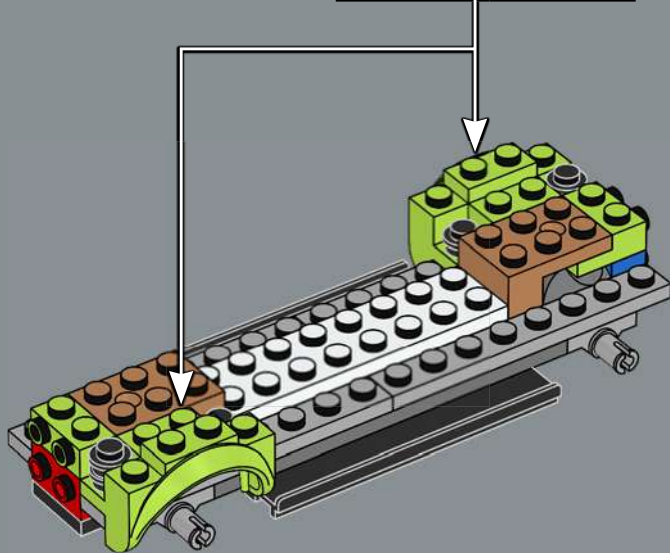
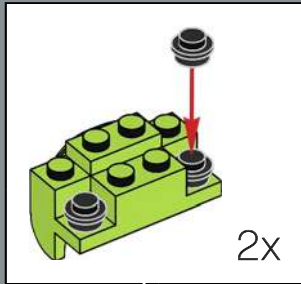

10

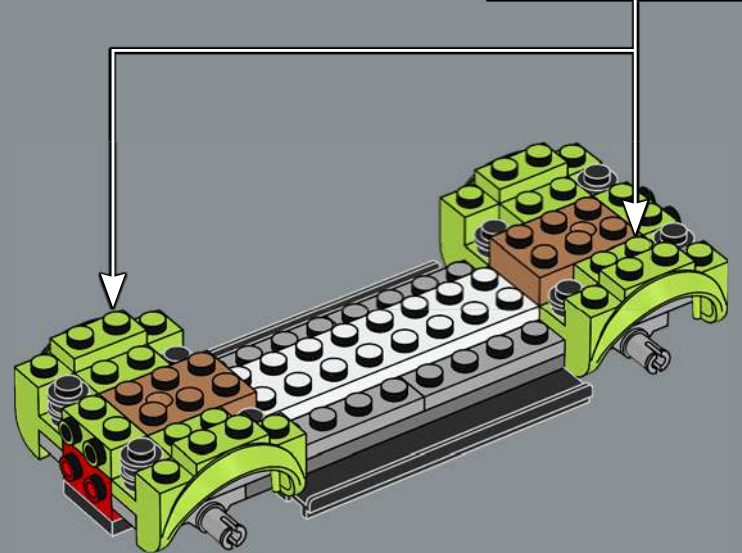
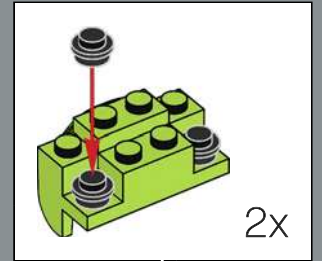



8x

11

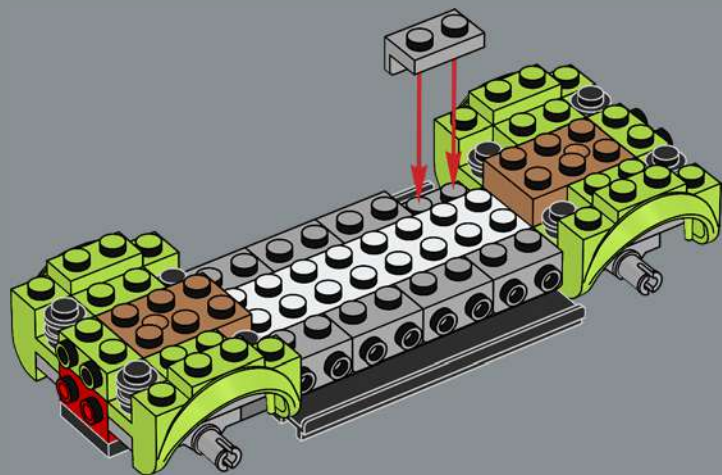

2x



1x



4x

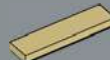

2x

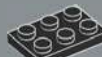

1x

12

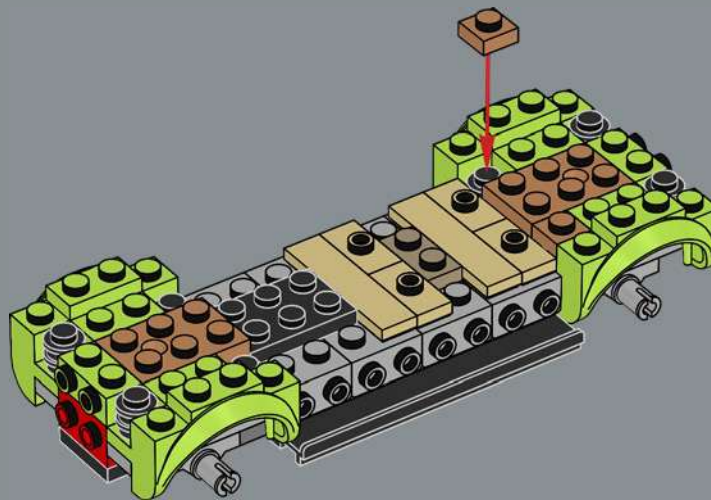



13

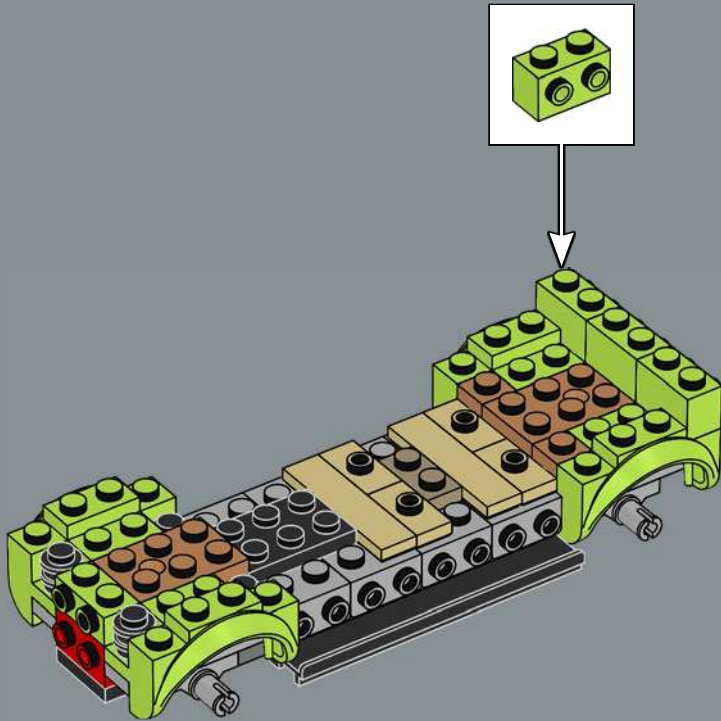

14

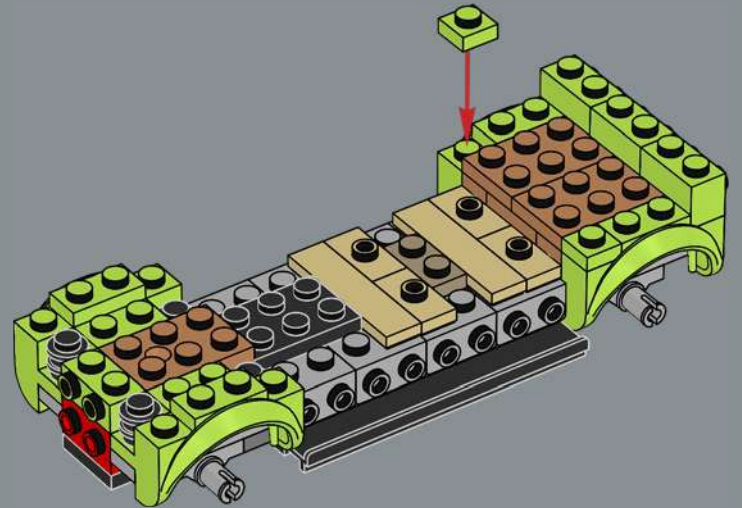

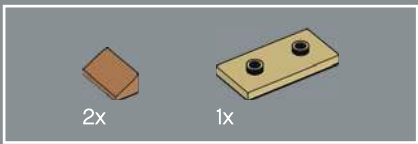

15

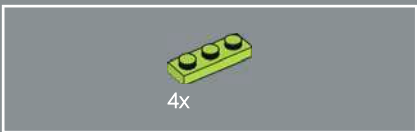
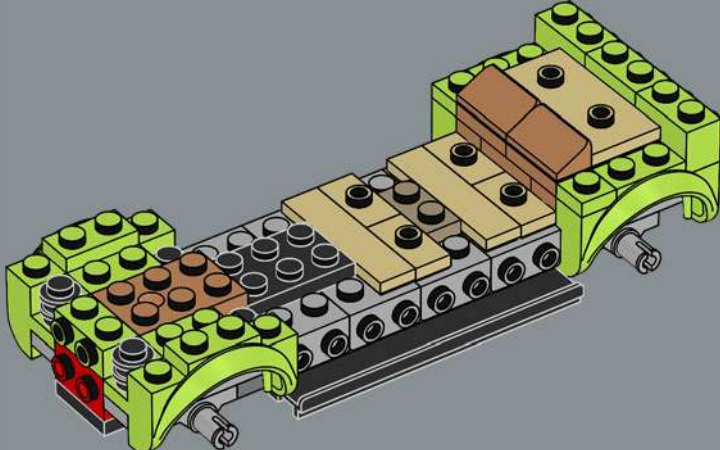

16

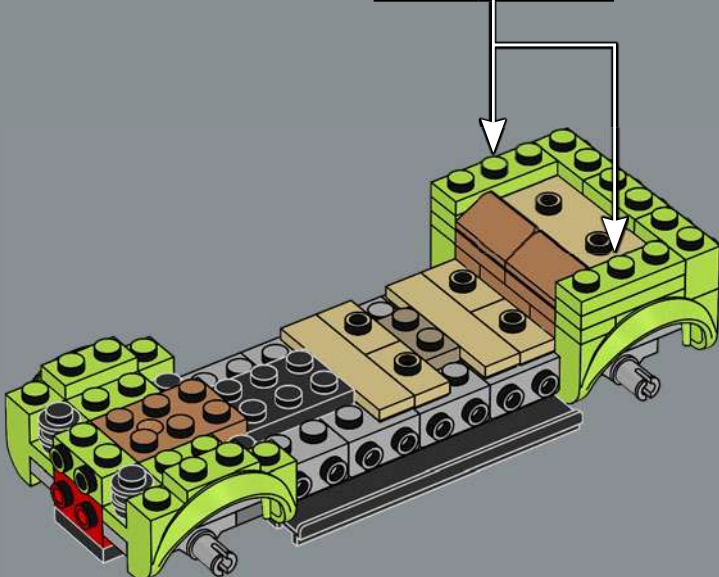
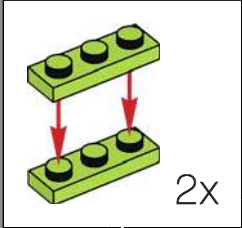



17

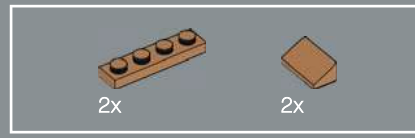
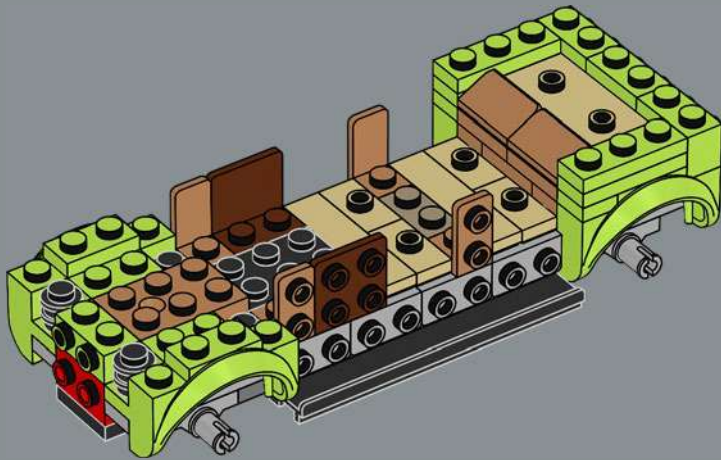

18

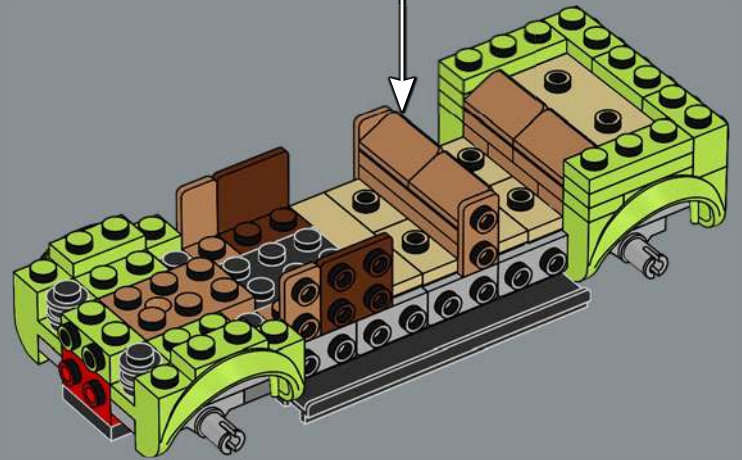
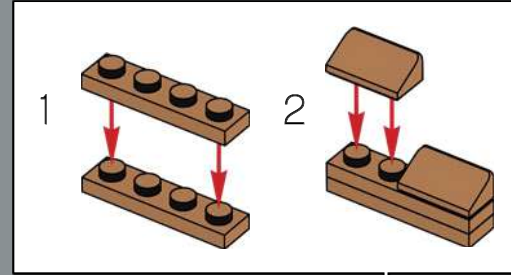

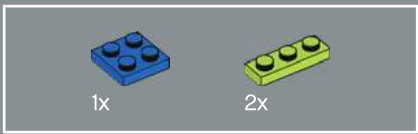

19

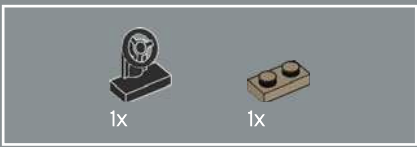
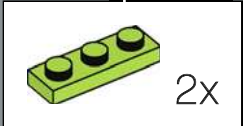
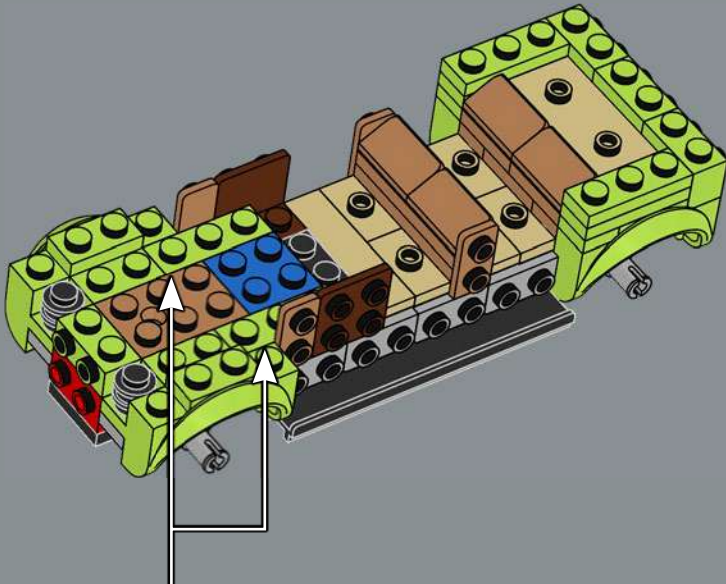

20

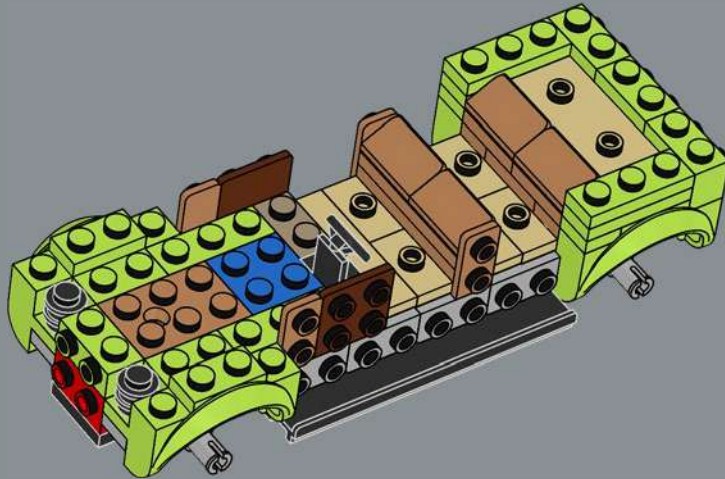

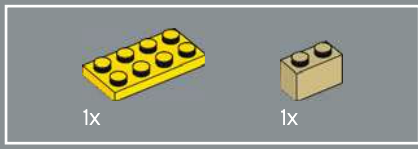

21

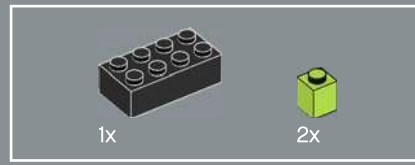
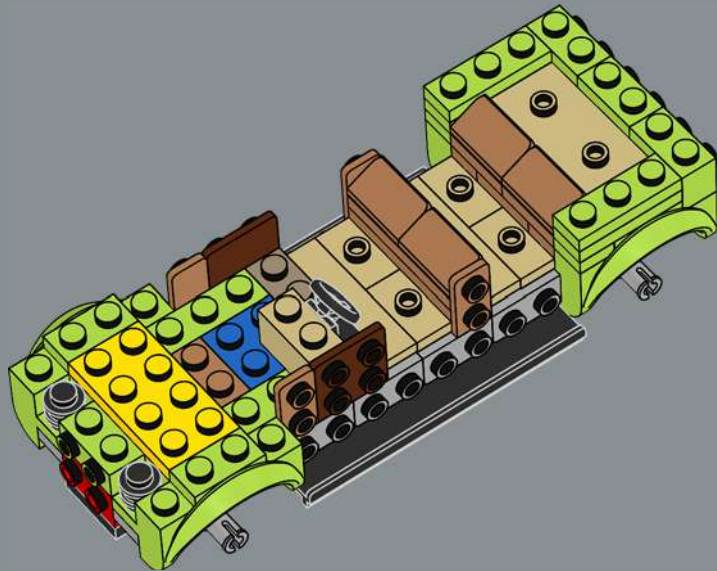

22

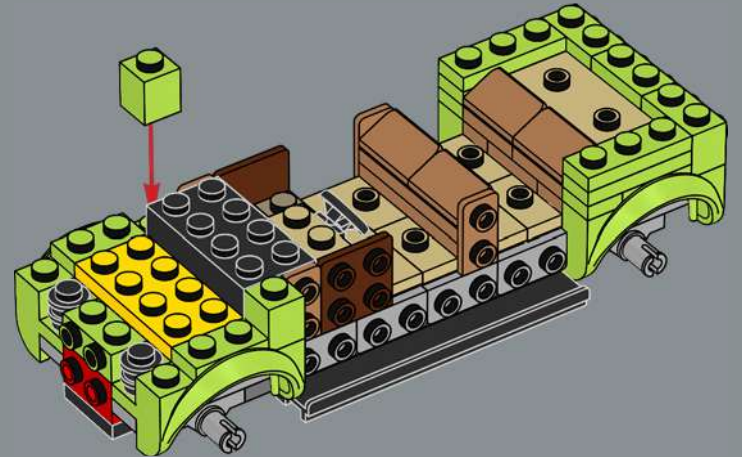

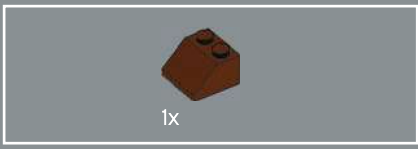

23

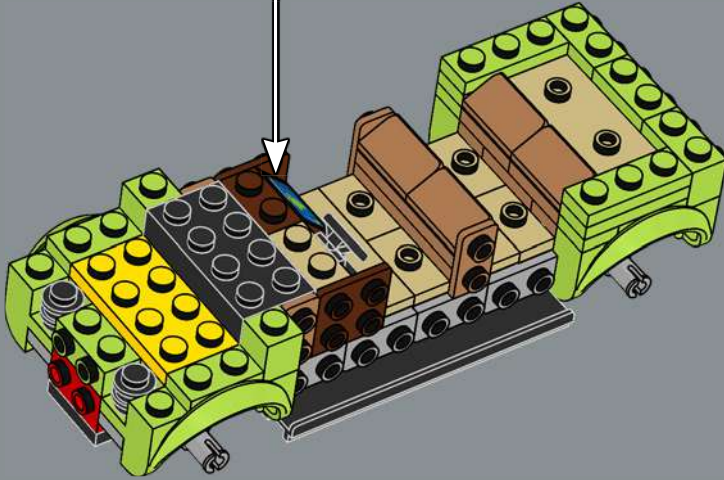
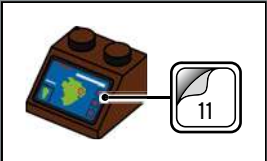

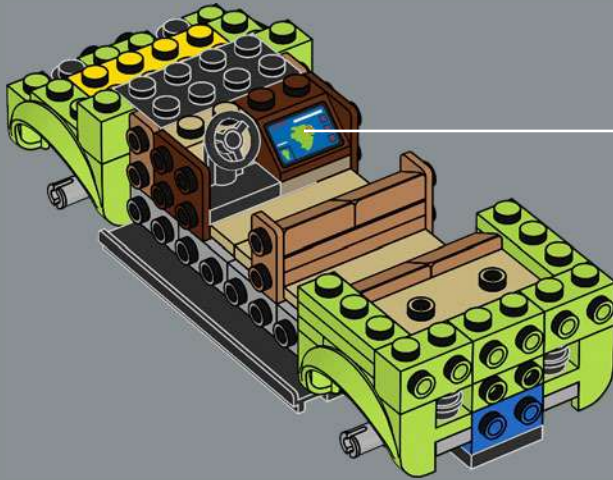

TYRANNOSAURUS TECH

These days we're used to slick, uber-thin phones, tablets and laptops giving us real-time information and entertainment. But back in 1993, this interactive touch-screen CD-ROM drive was the bleeding-edge of tech. You might struggle to fit it in your pocket though...



4x

24

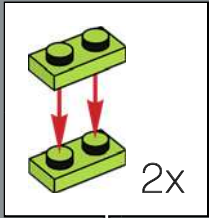

2x

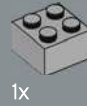
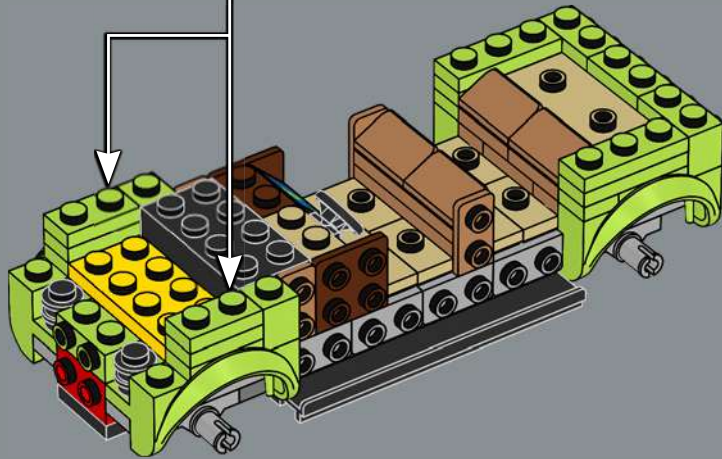

1x

25

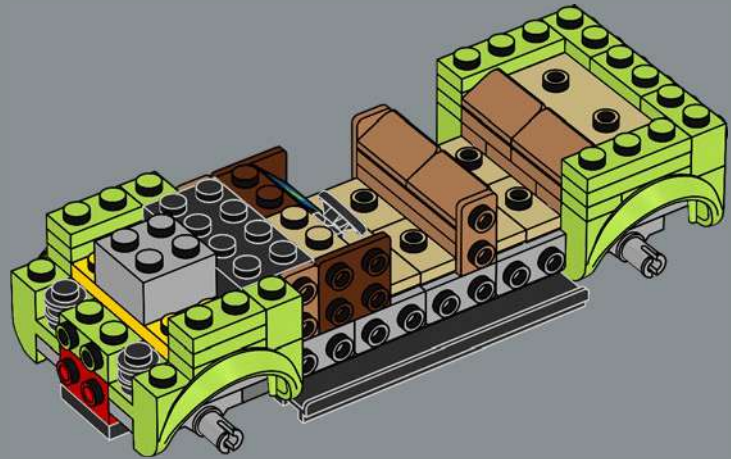



26

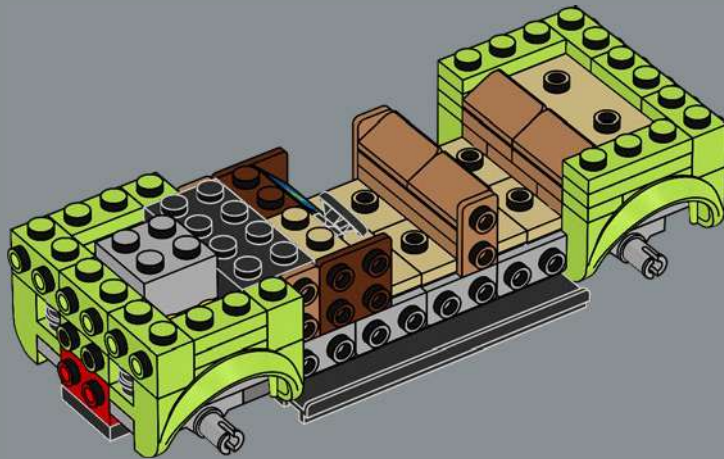

27

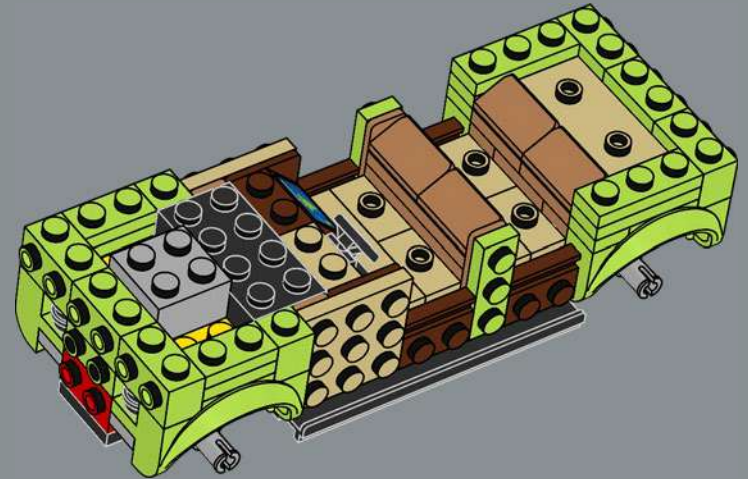

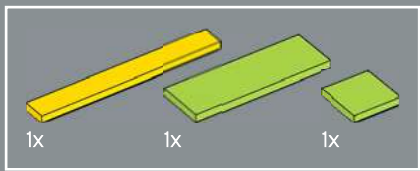

28

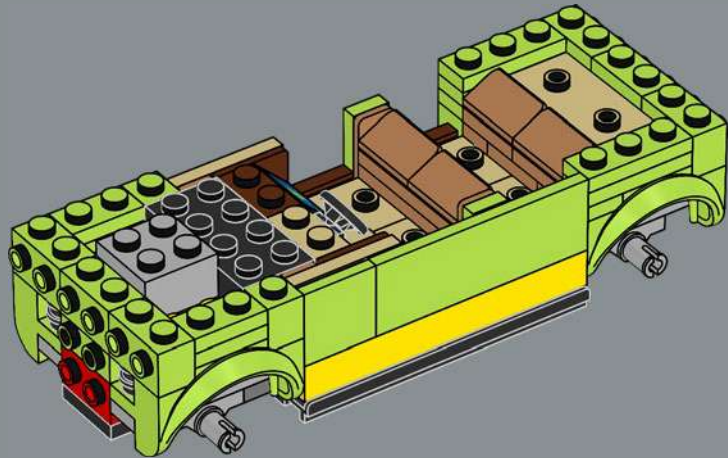

29

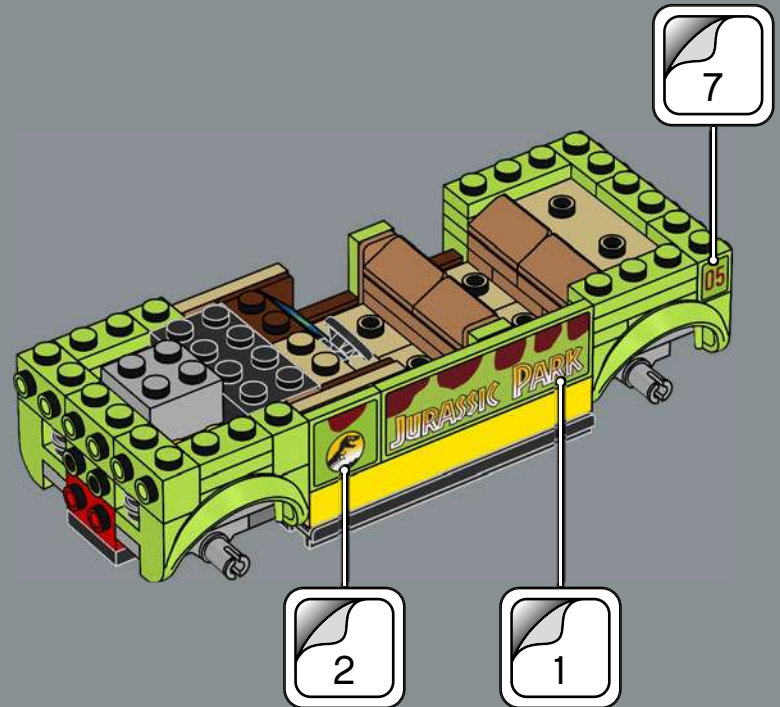

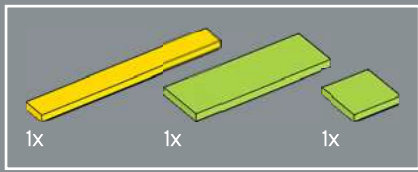

30

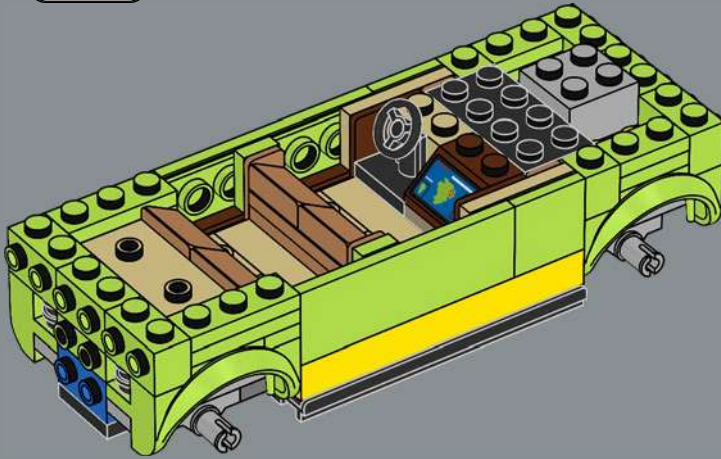

31

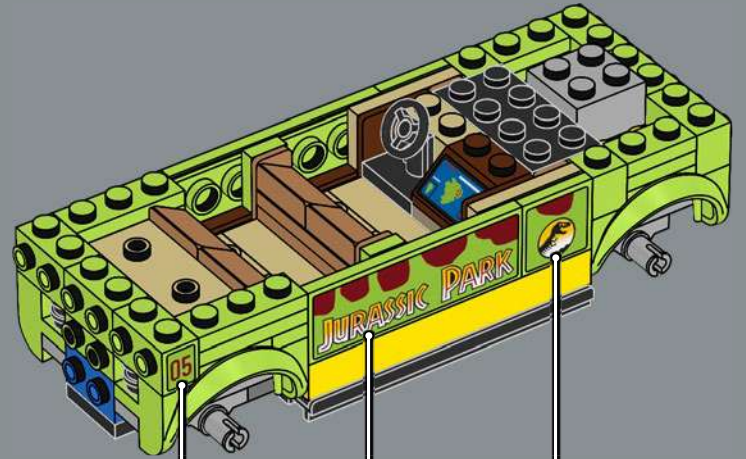

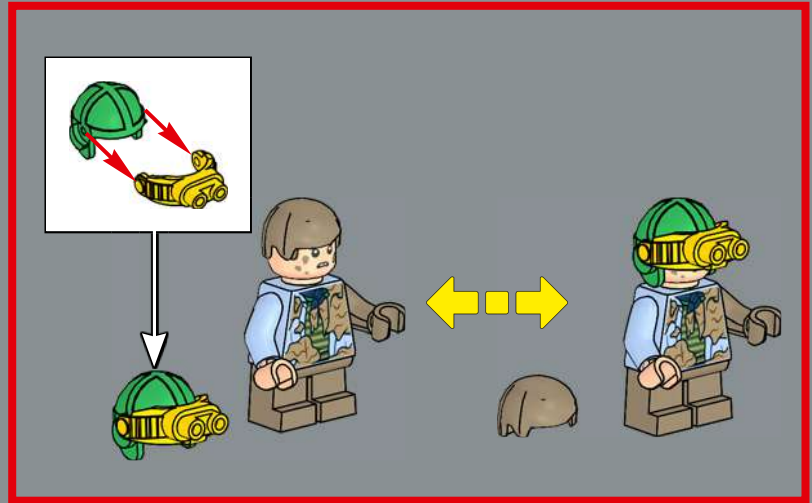
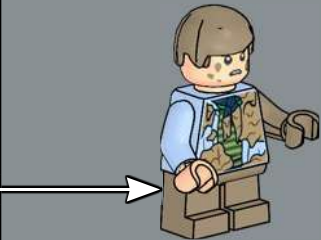
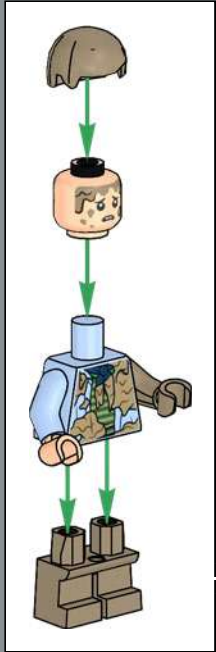



NIGHT VISION

Pros of night vision goggles = you can see in the dark. Cons of night vision goggles = You might not like what you see coming...

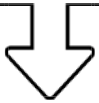

32

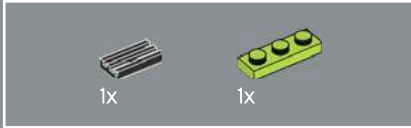
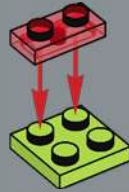

33

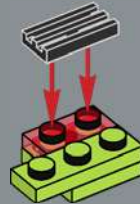

34

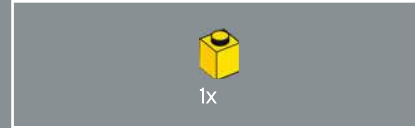

35

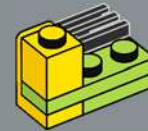

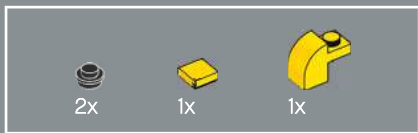

36

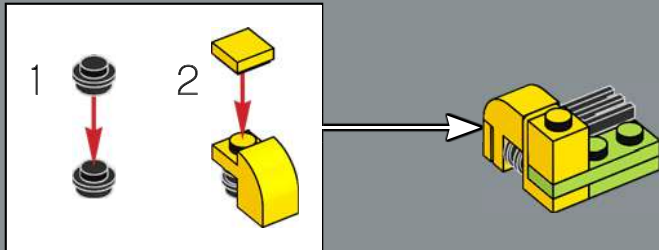

37

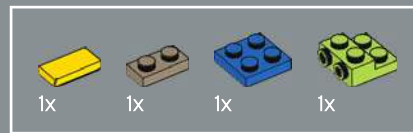
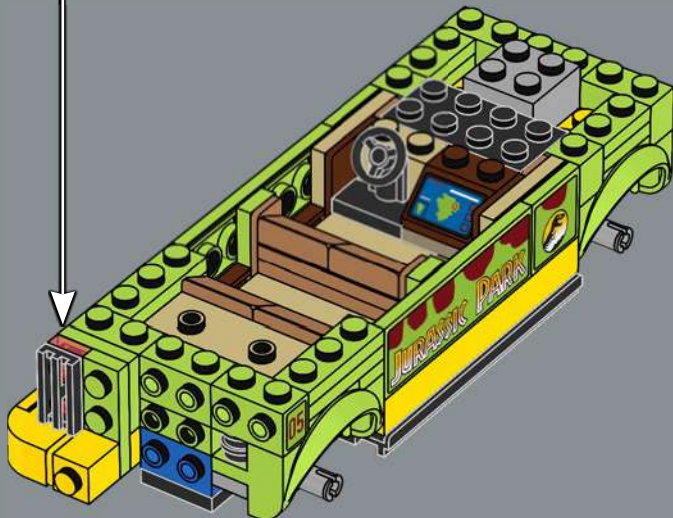

38

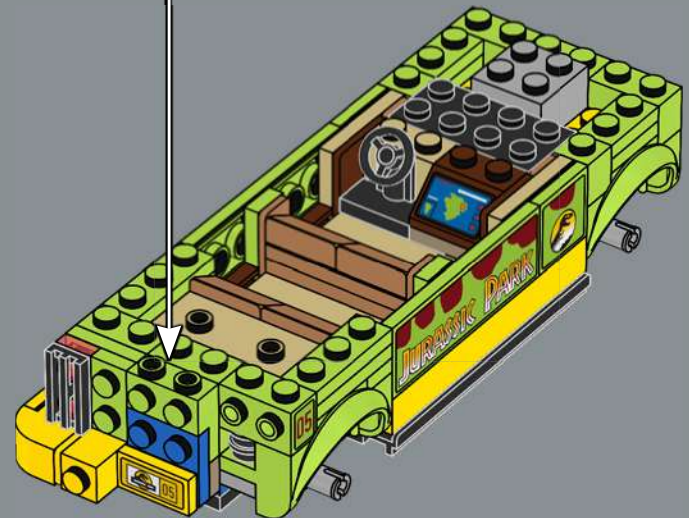
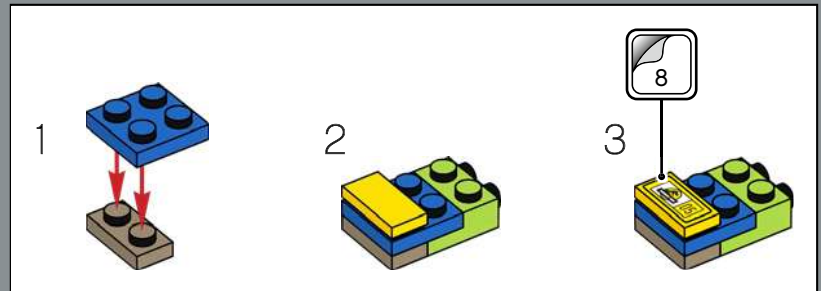

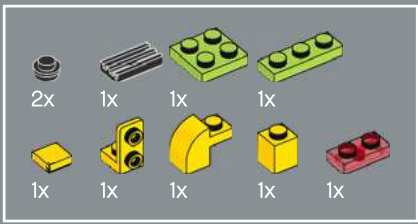

39

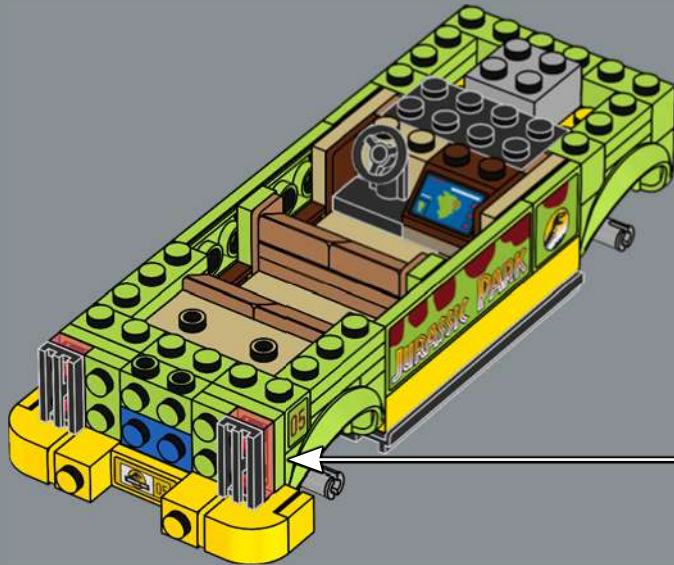
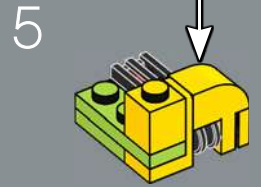
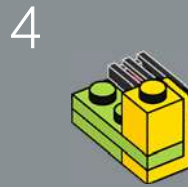
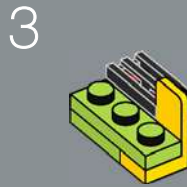
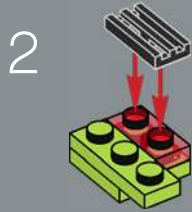
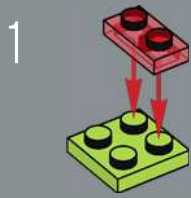
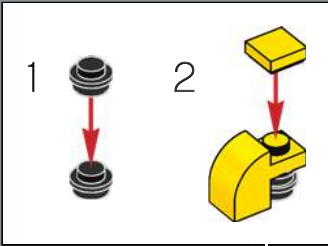

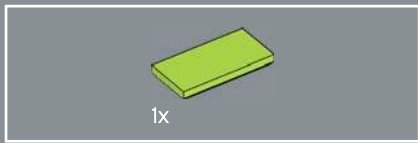

40

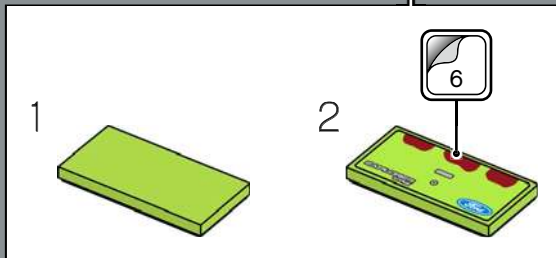
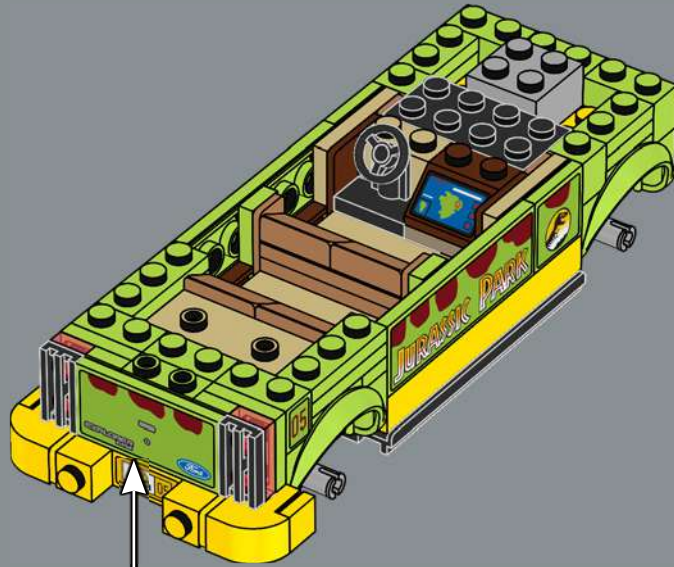



41

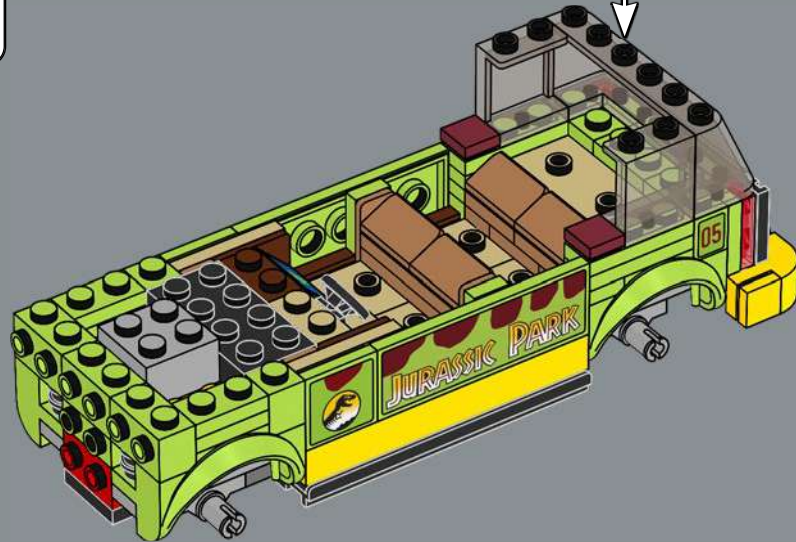
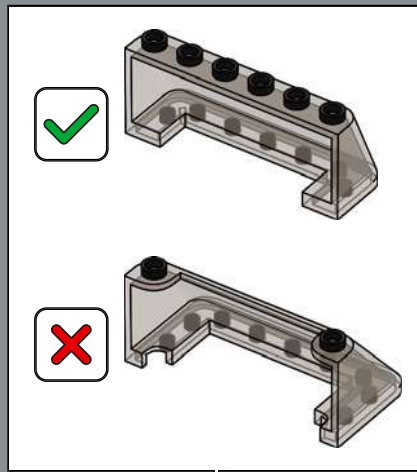



42

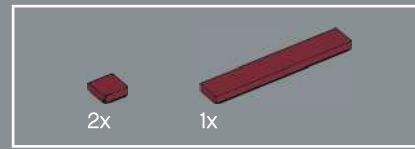
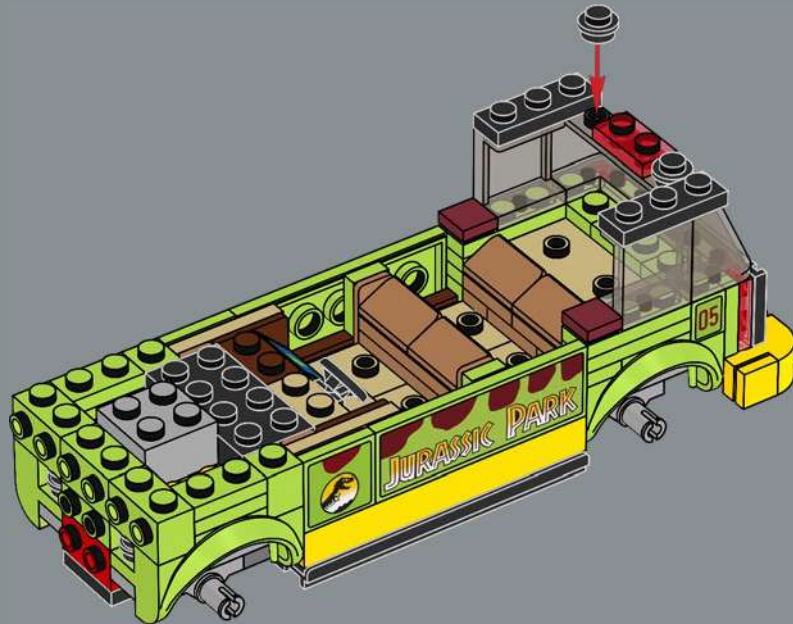

43

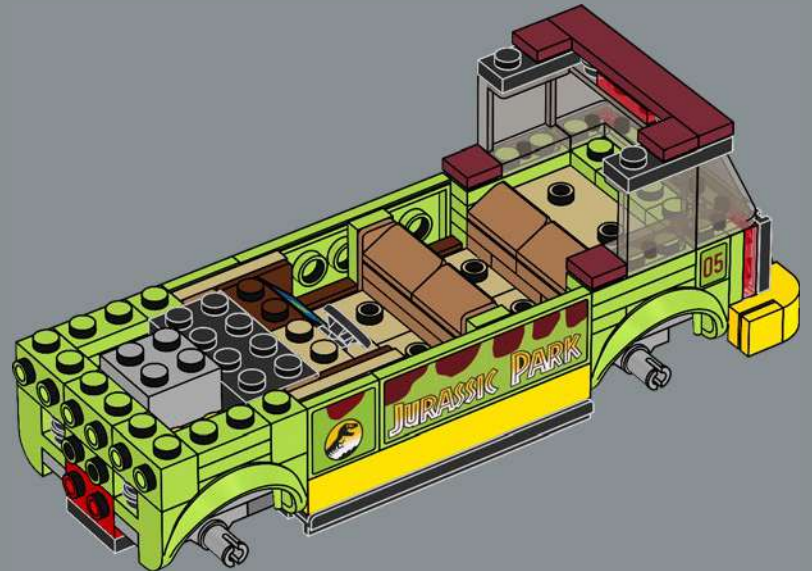



44

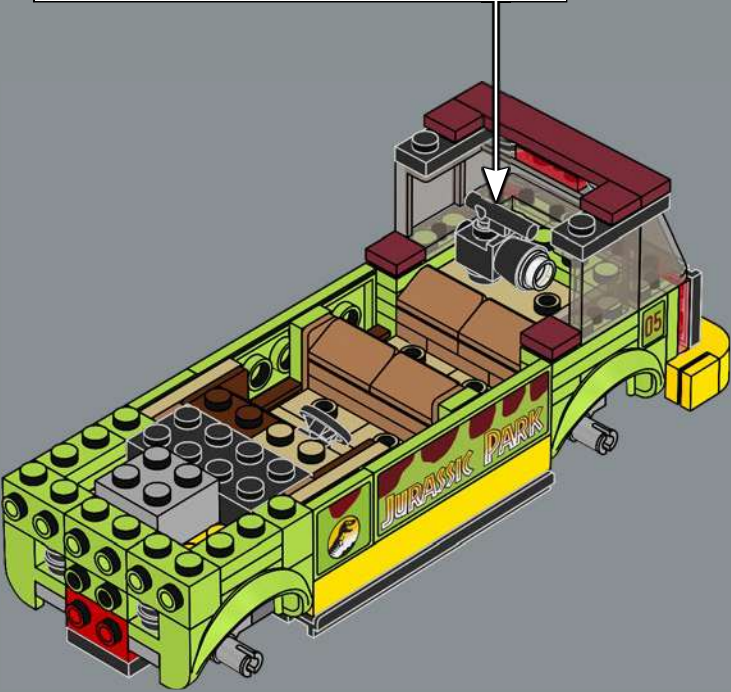
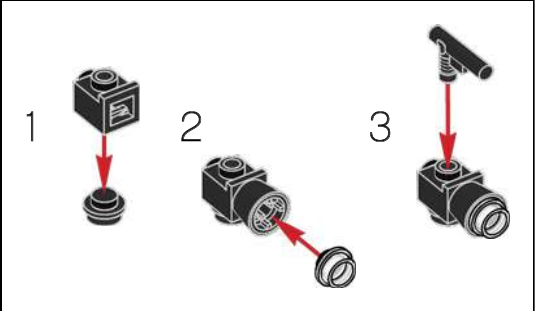

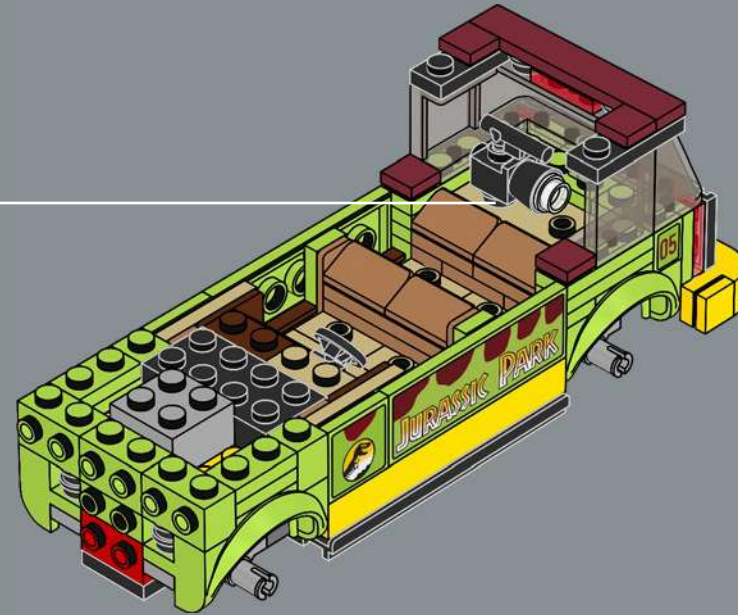

"TURN THE LIGHT OFF, TURN THE LIGHT OFF!"

In an ideal world, Lex would have stayed still and calm and waited for that angry T. rex to walk right by. But where's the fun in that when you can frantically wave a powerful torch instead?

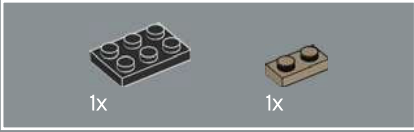
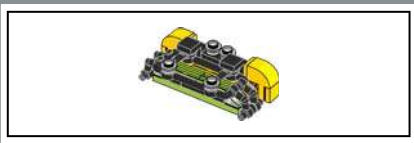

45

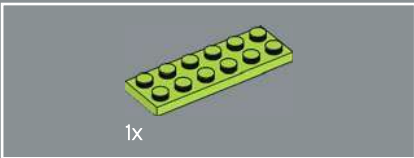
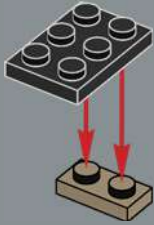

46

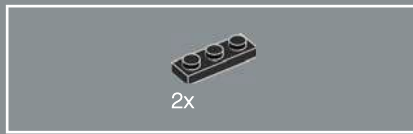
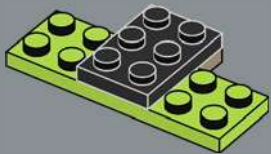

47

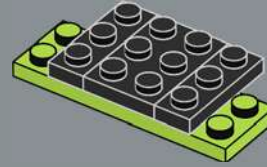

48

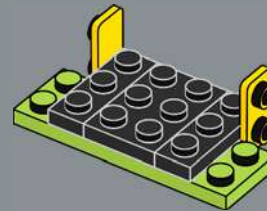



49

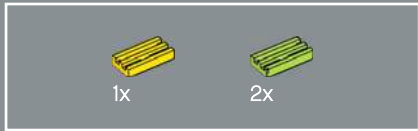
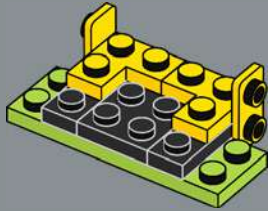

50

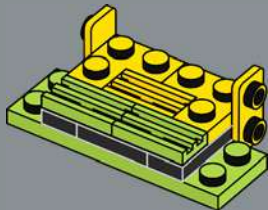

51

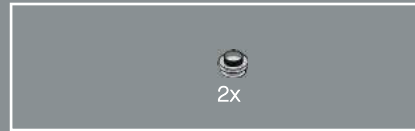
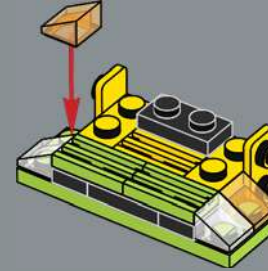

52

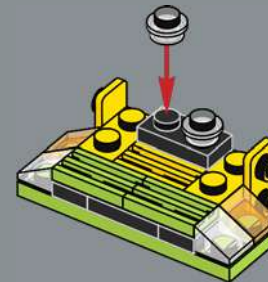



53

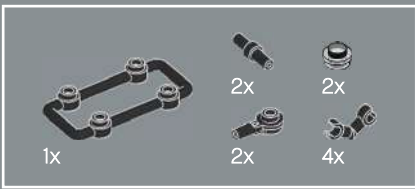
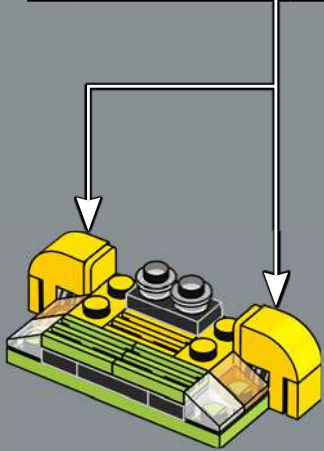
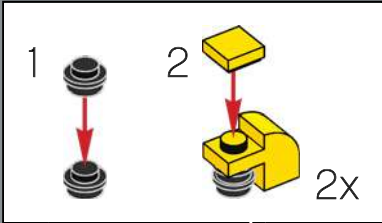

54

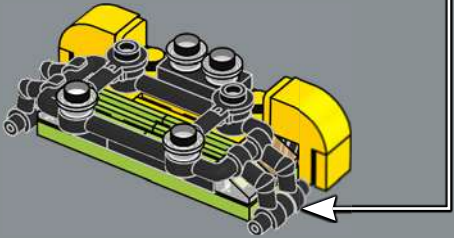
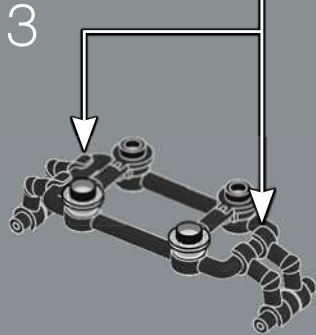
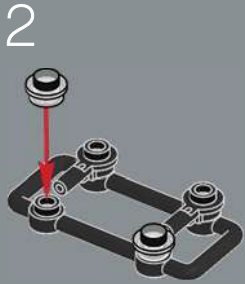
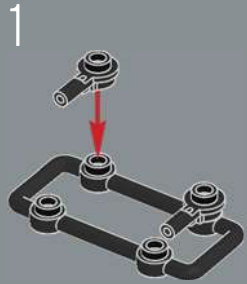
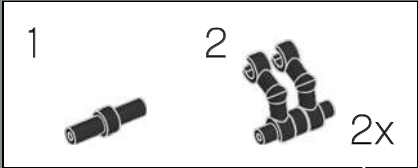



55

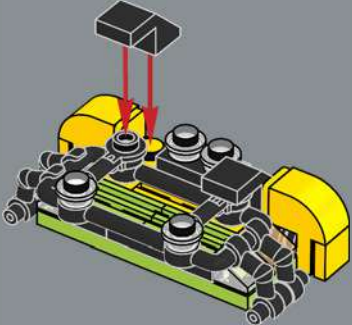

56

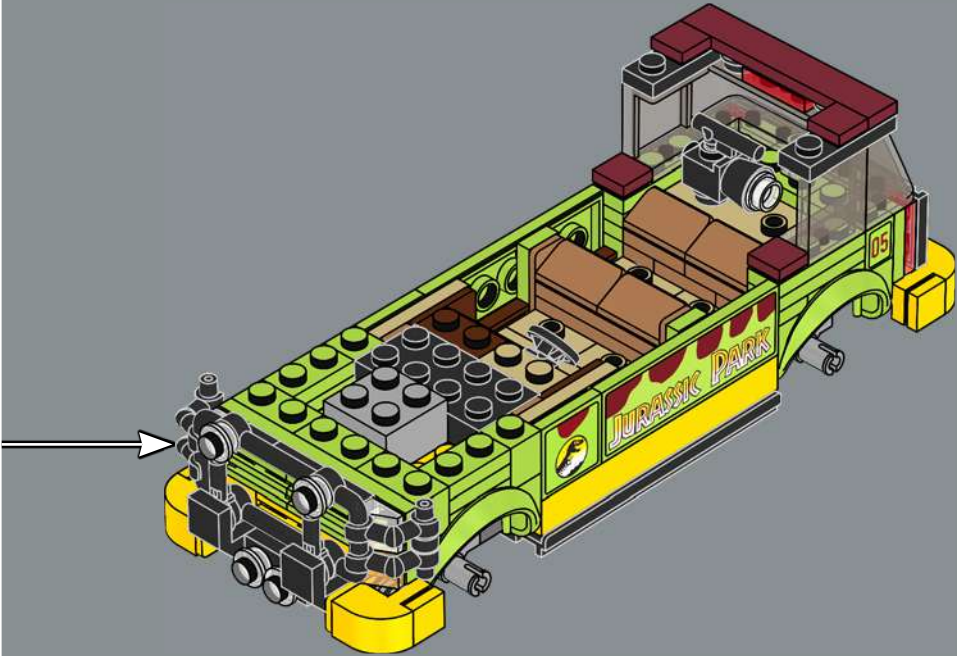

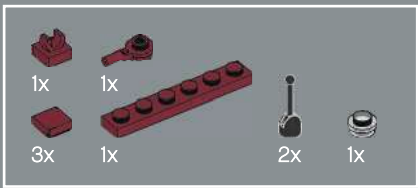

57

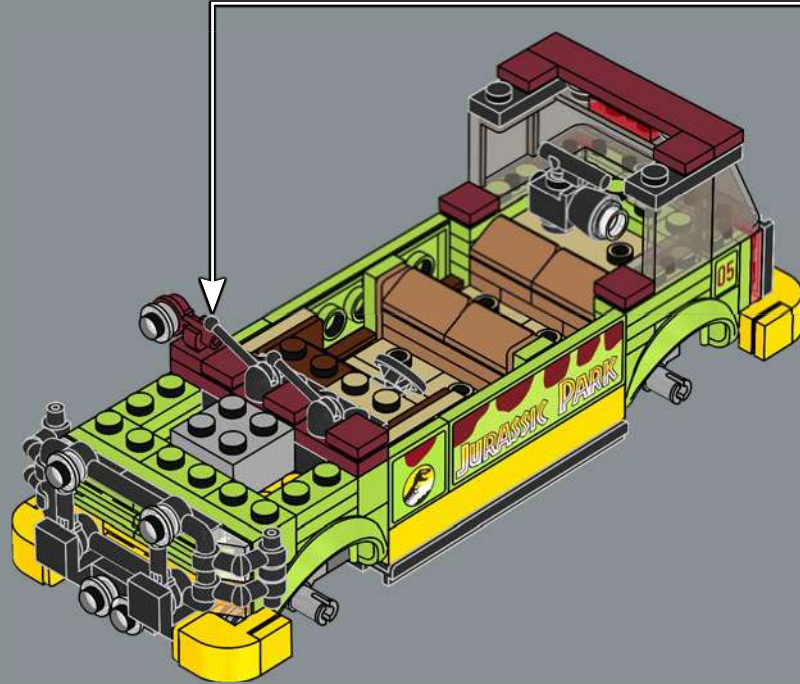
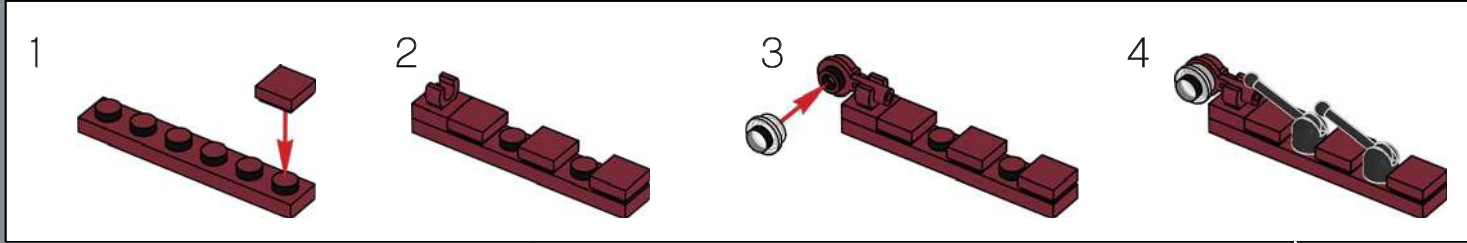

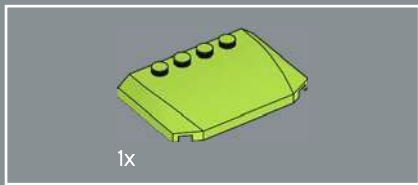

58

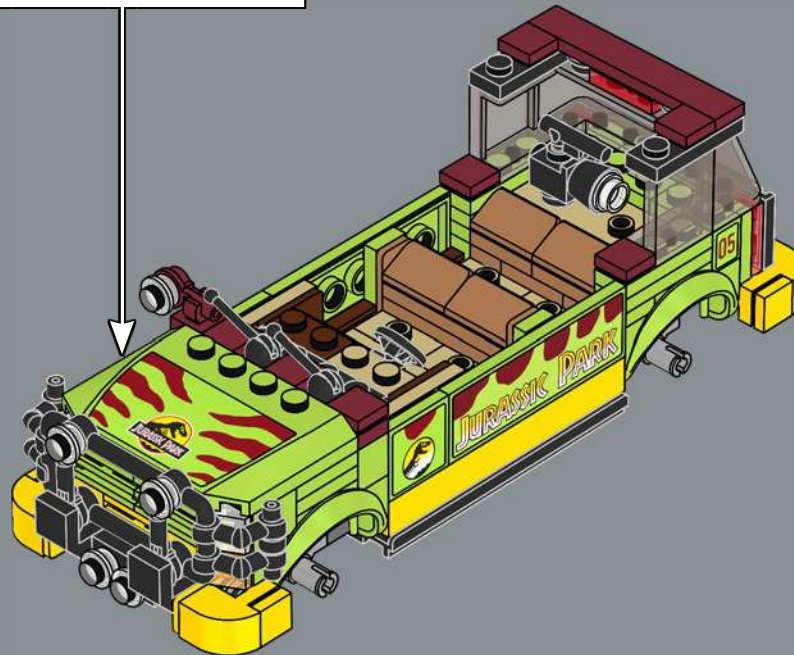
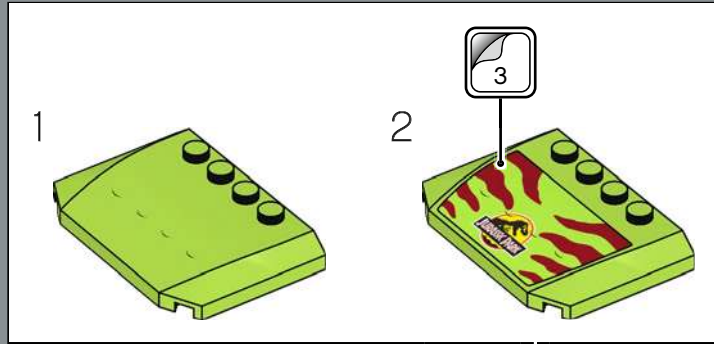

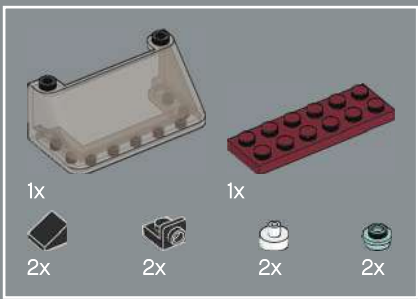

59

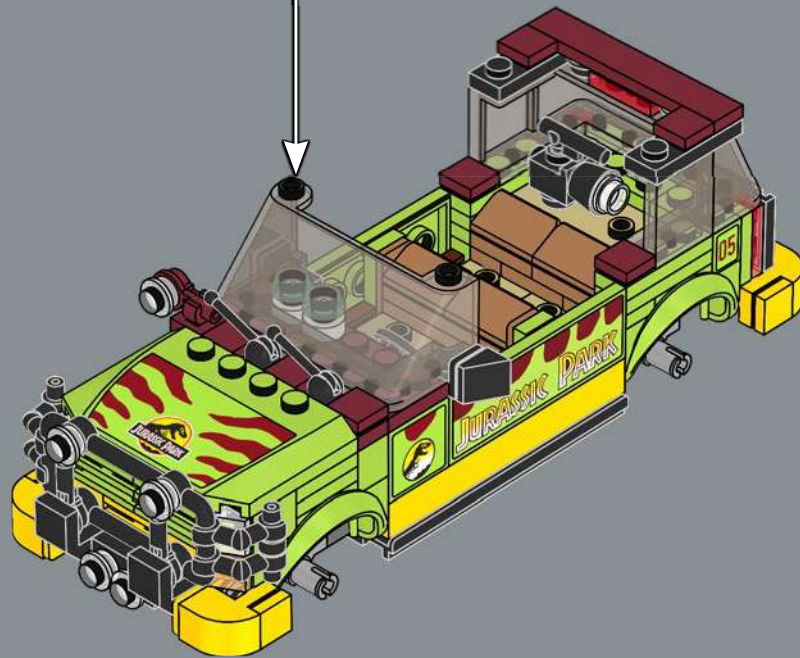
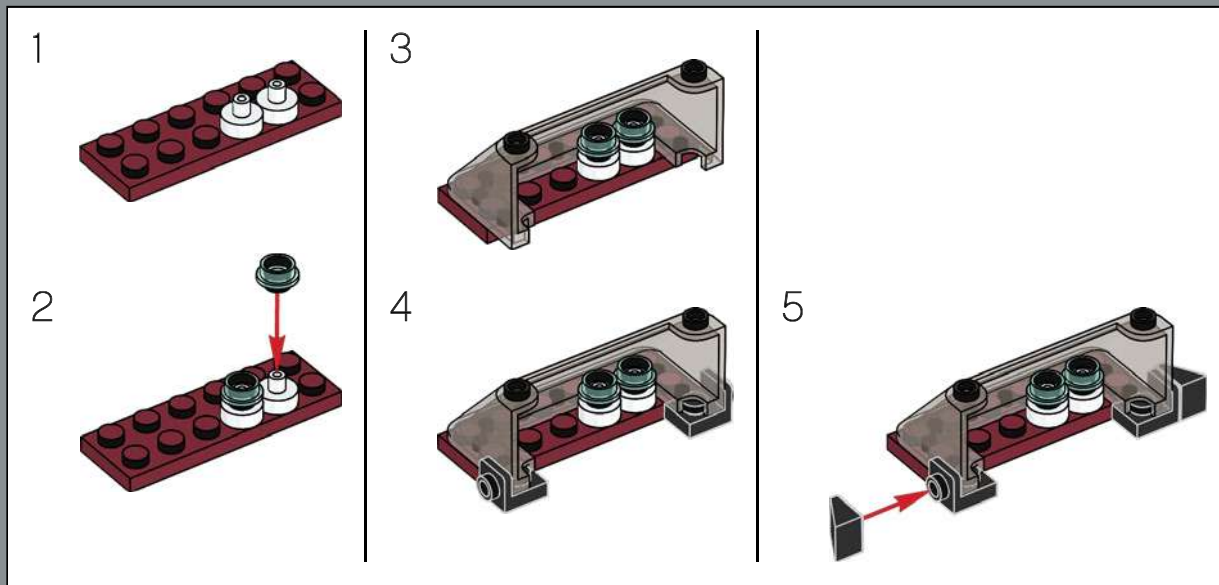

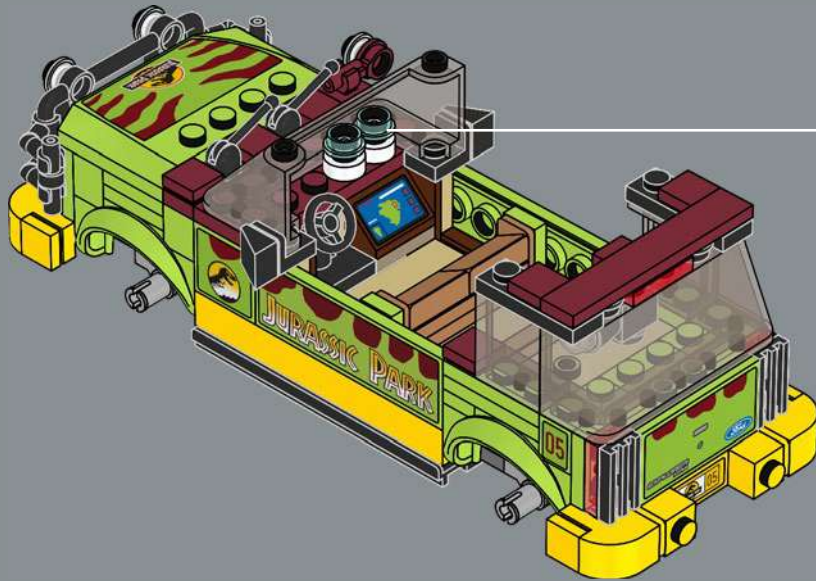

"DID YOU FEEL THAT?"

How do you tell people the T. rex is coming, *without telling people the T. rex is coming*? All you need are two cups of water, something gargantuan enough to shake them, and voila ... cinematic history!

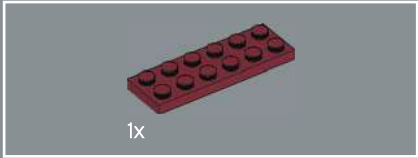
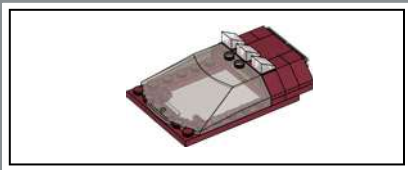

60

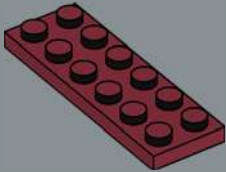

61

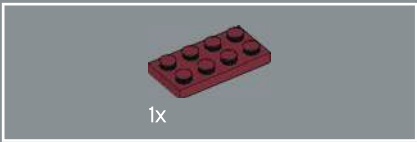
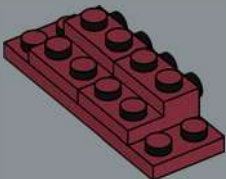

62

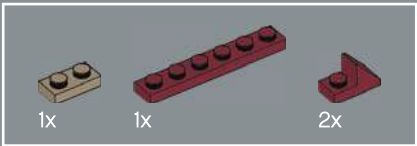
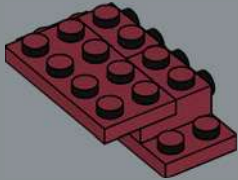

63

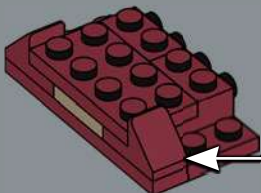
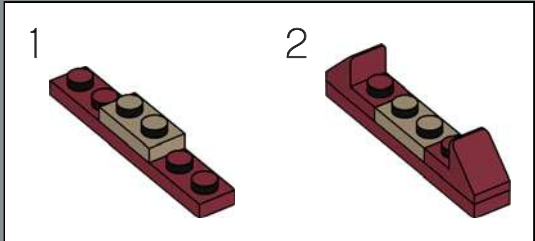



64

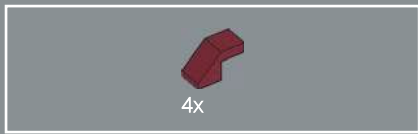
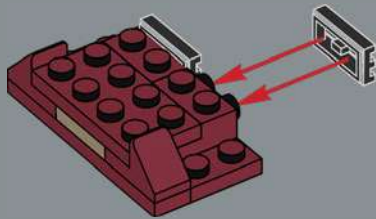

65

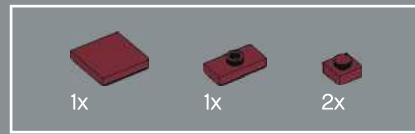
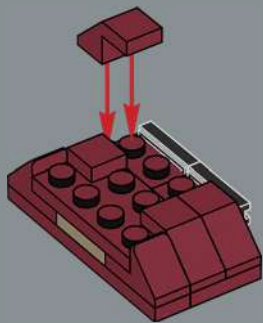

66

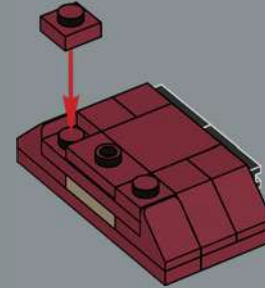

67

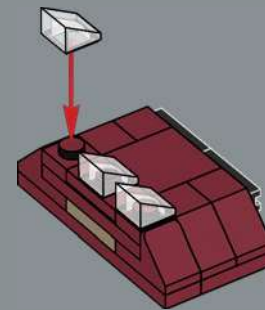

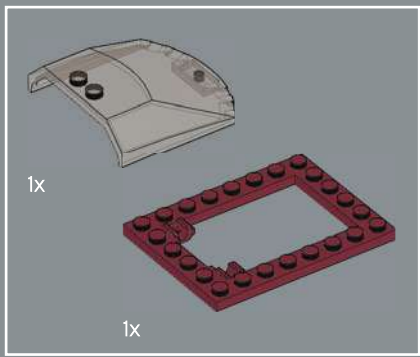

68

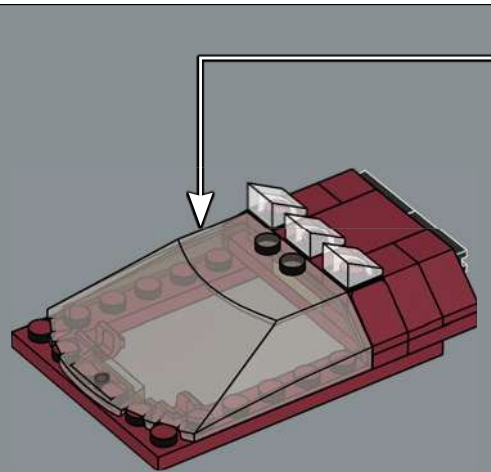
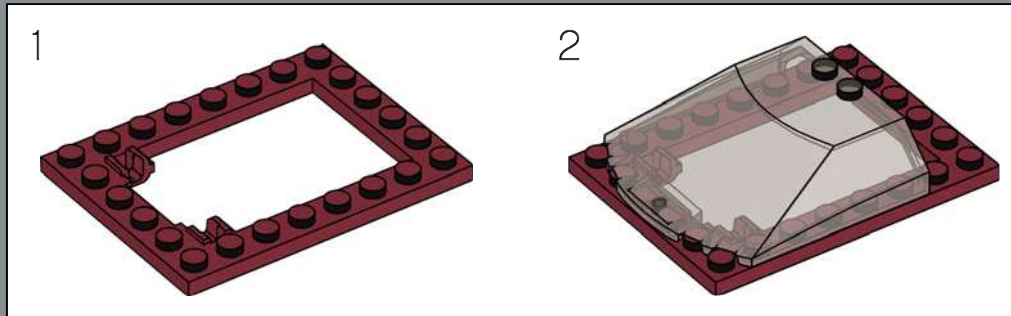

69

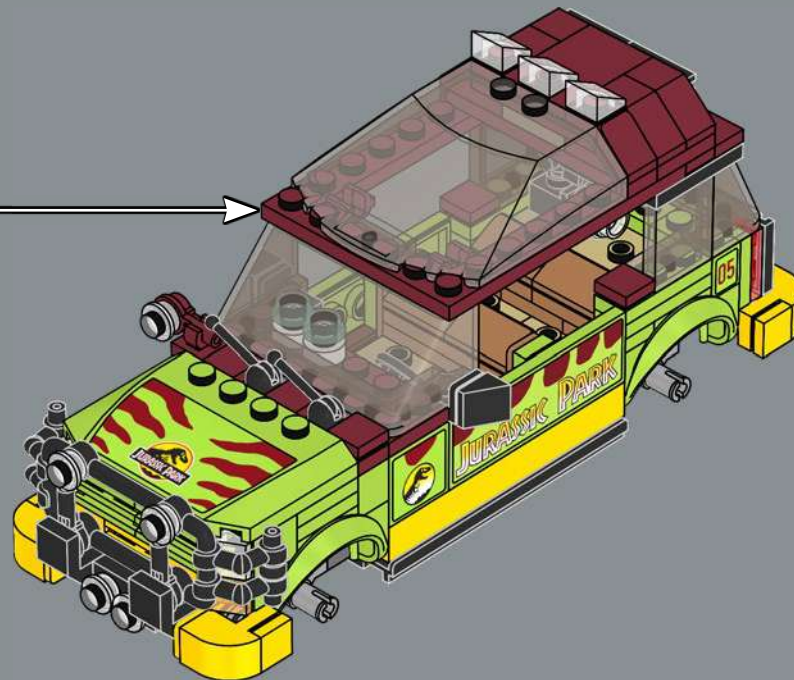



70

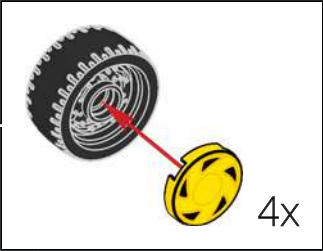
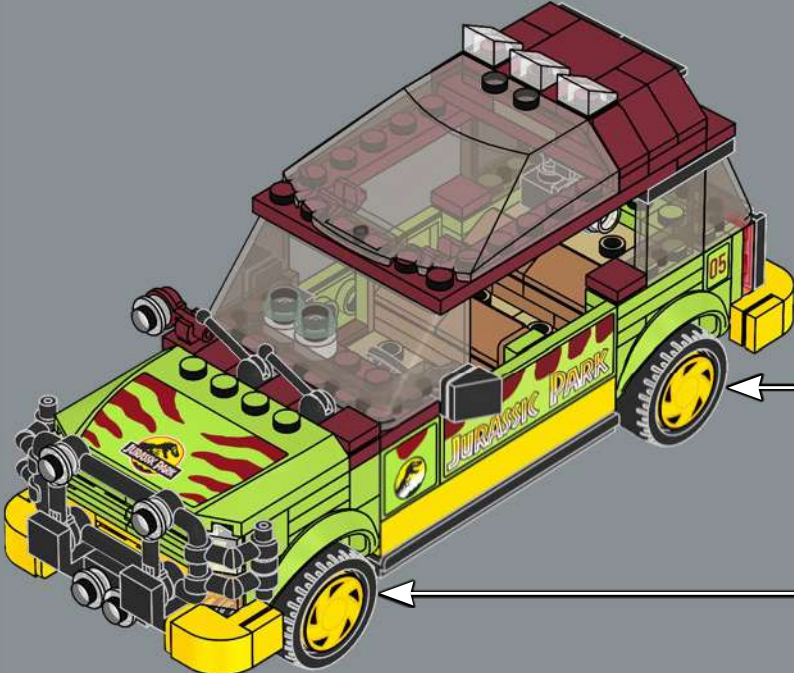

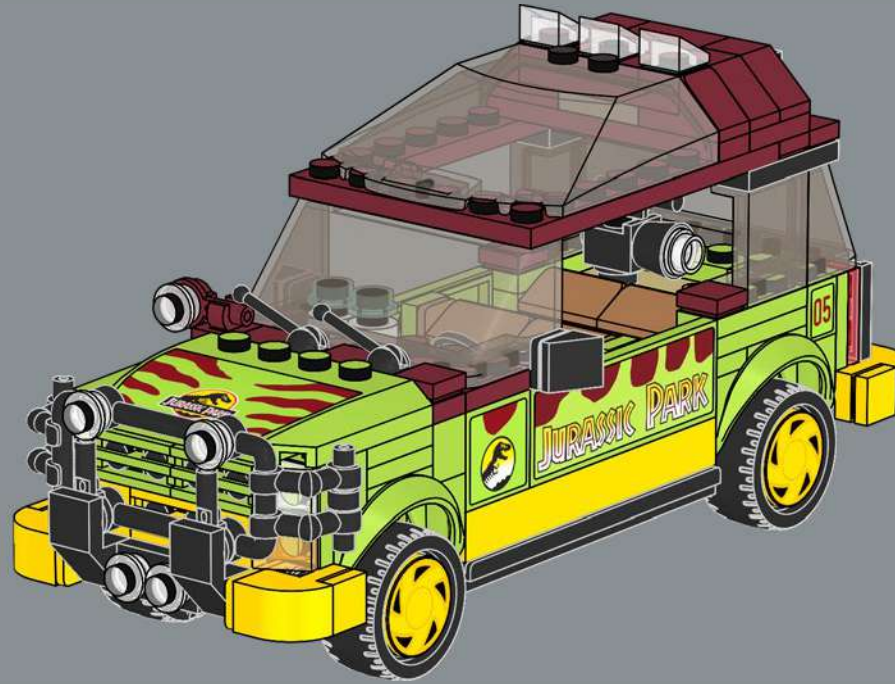

MADE FOR EXPLORING

That panoramic glass roof. That iconic colour scheme and decals. Those bright yellow rims and chunky grill. Back in 1993, everyone dreamed of owning their own *Jurassic Park* Ford Explorer XLT. Unfortunately, there's now one less of them...

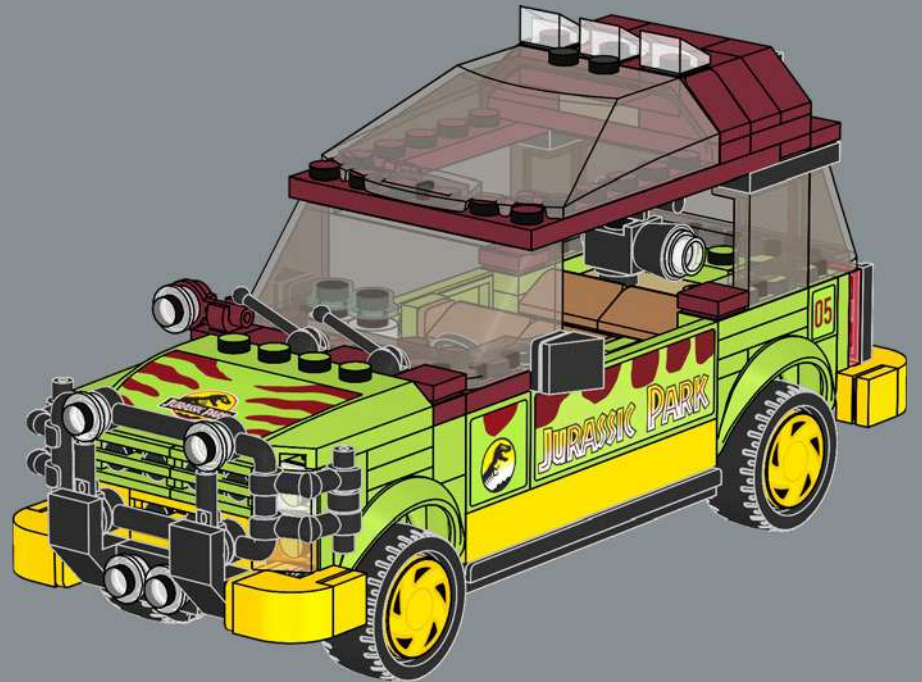
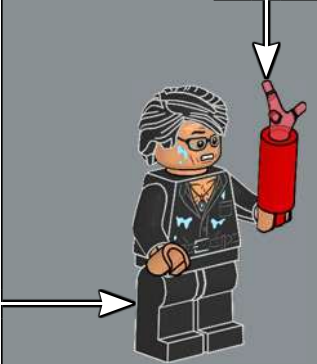
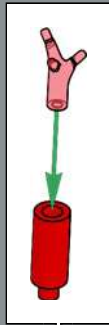
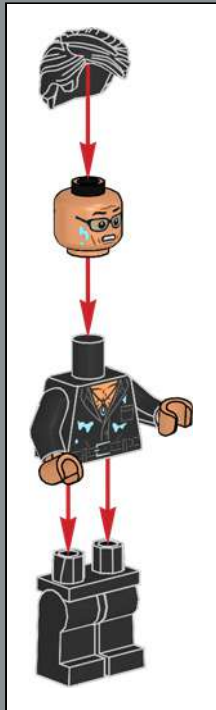

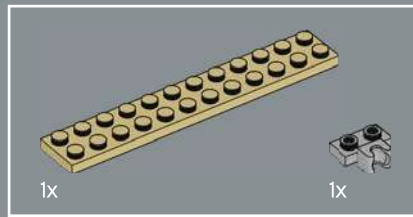
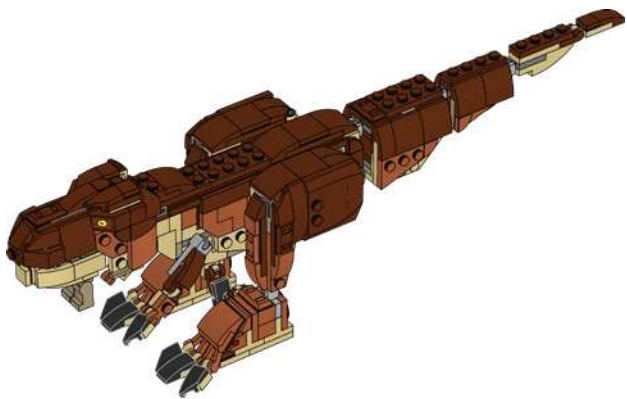
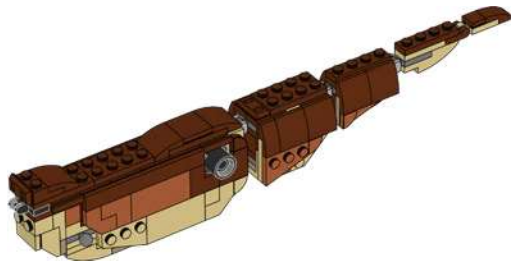

1

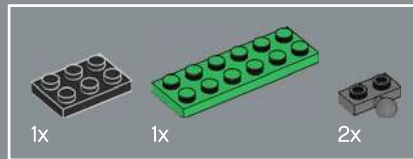
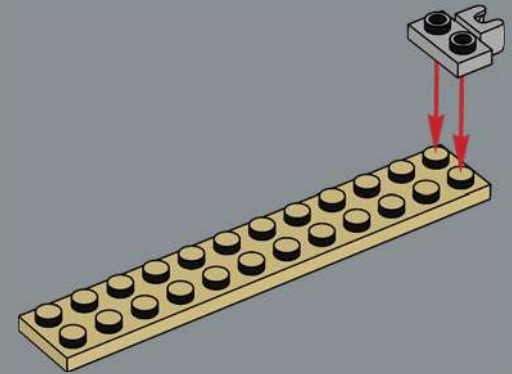

2

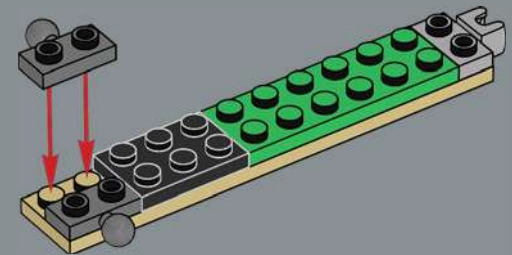

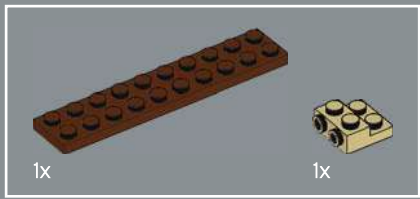

3

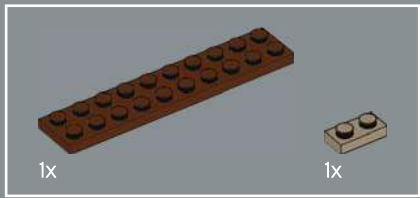
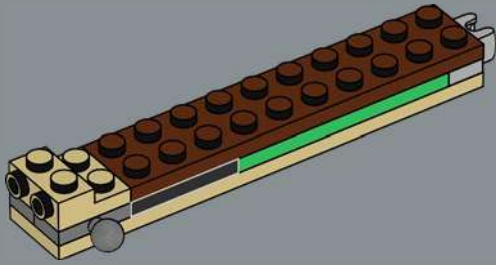

4

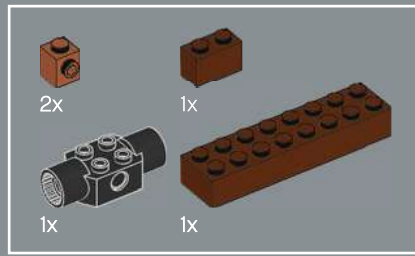
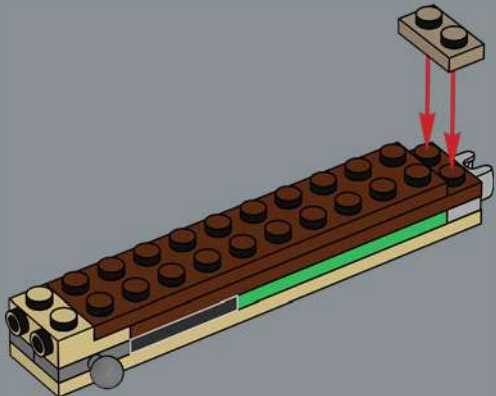

5

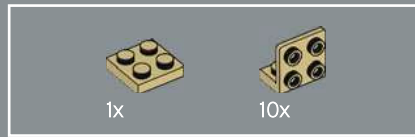
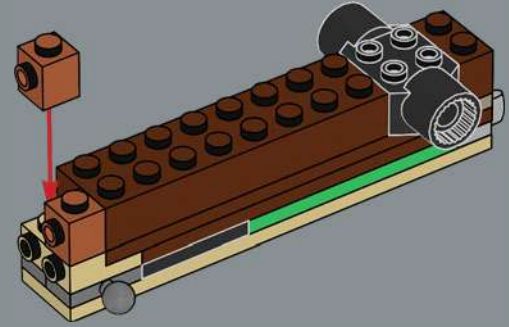

6

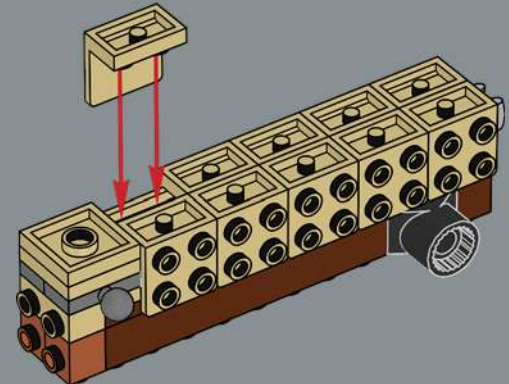

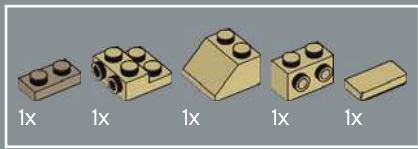

7

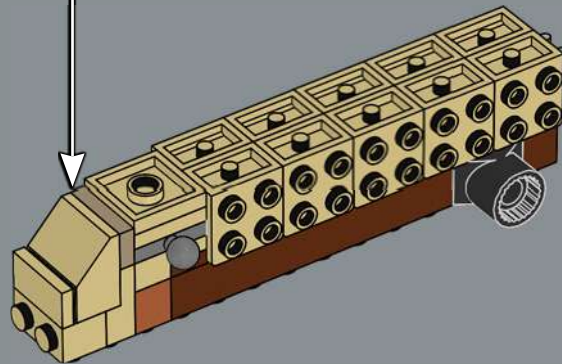
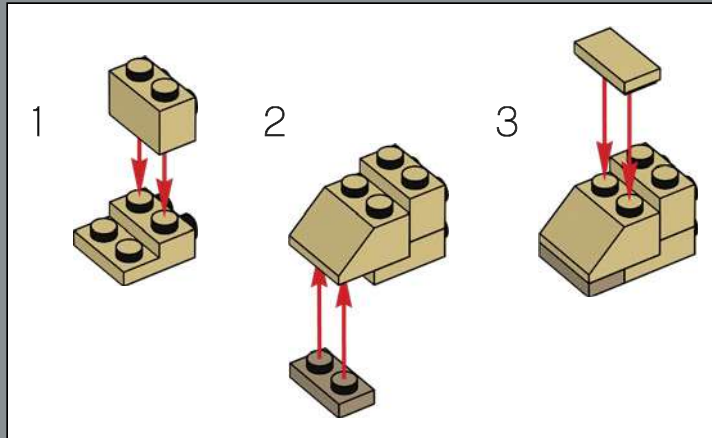

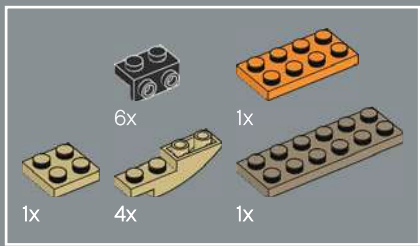

8

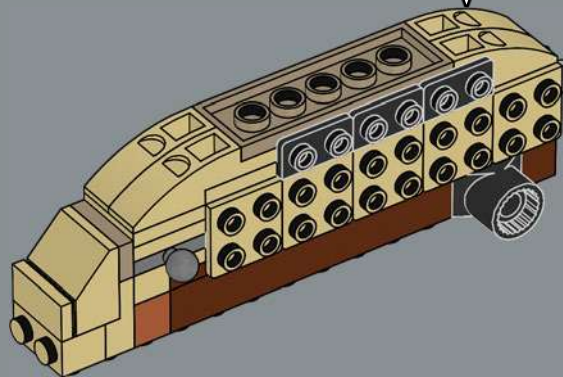
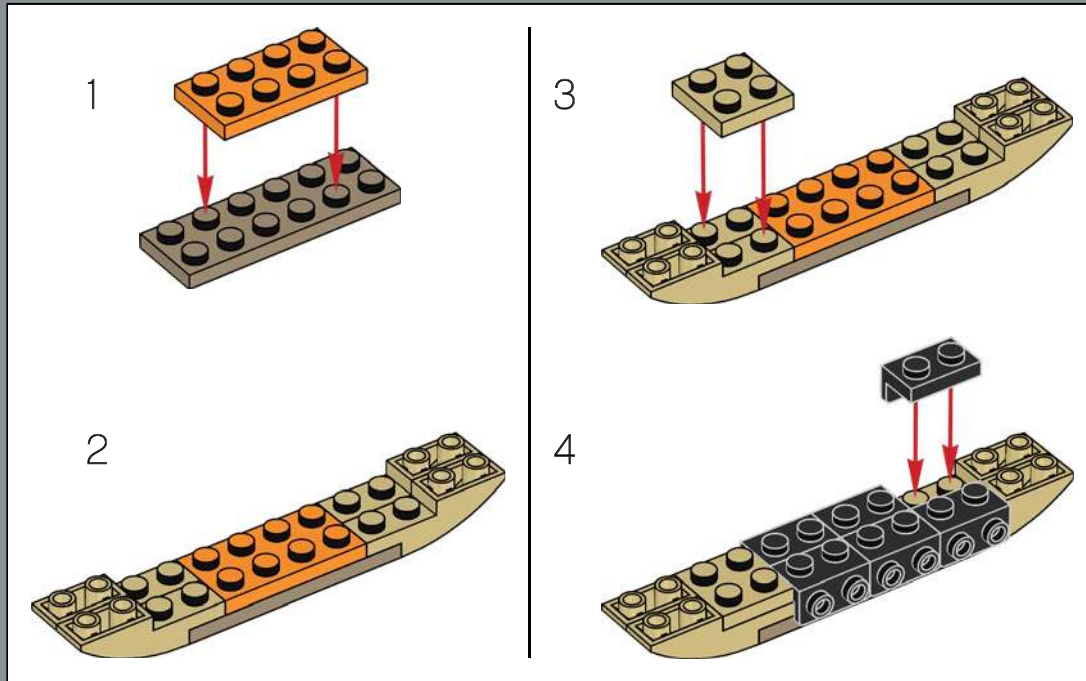

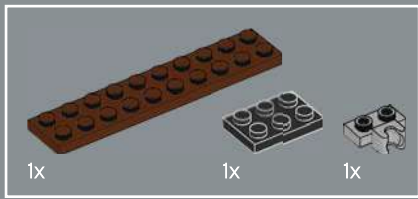

9

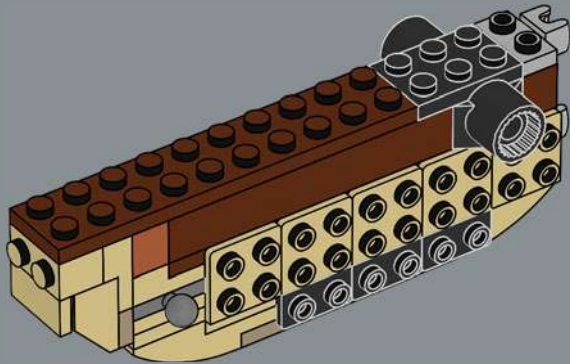

10

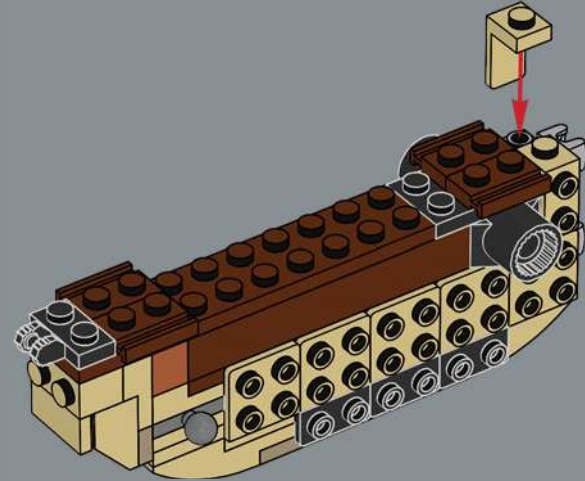



8x

11

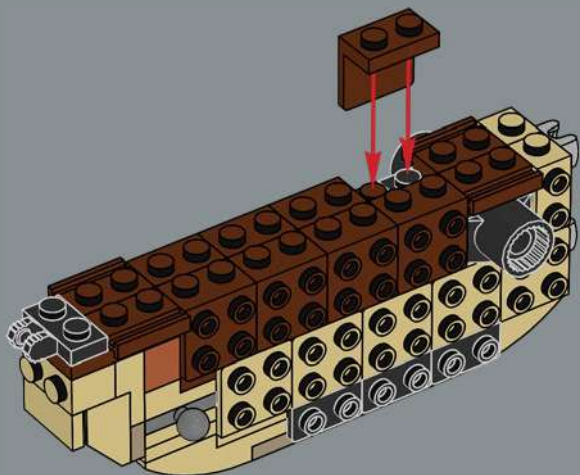

2x

12

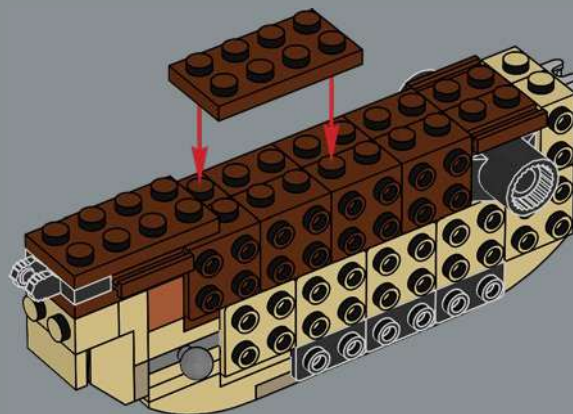

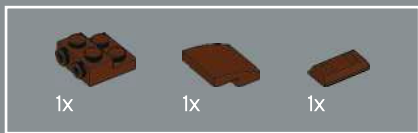

13

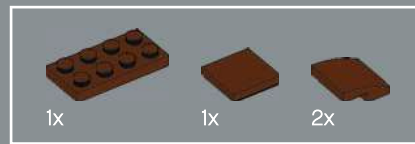
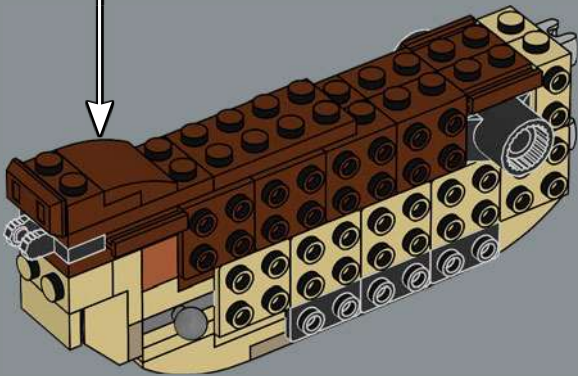
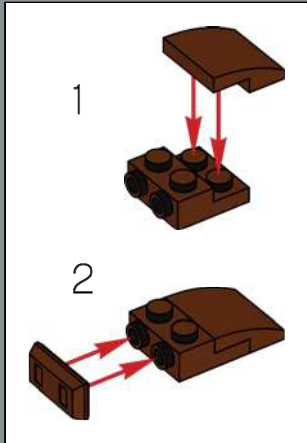

14

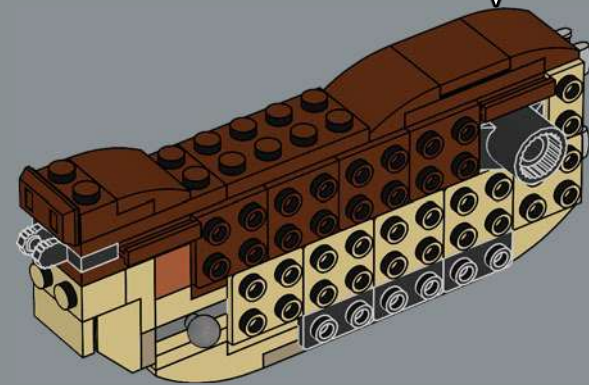
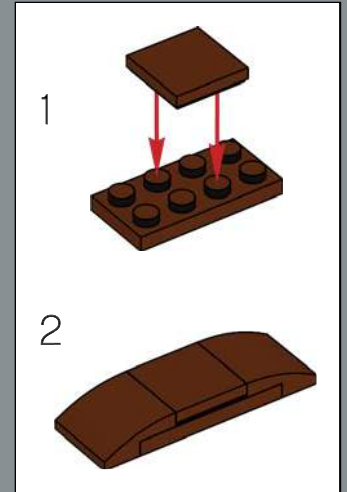

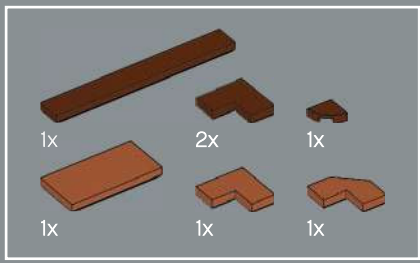

15

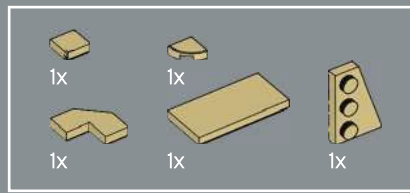
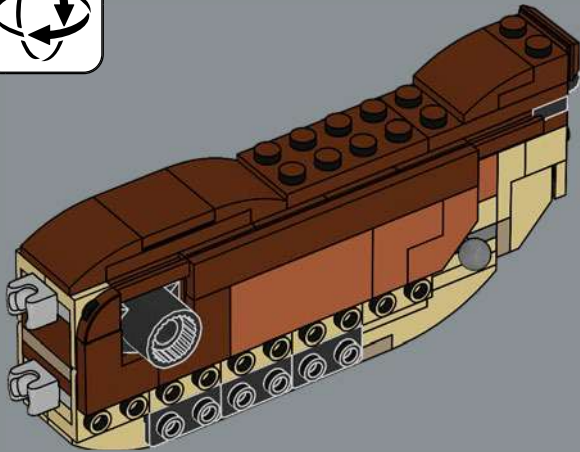

16

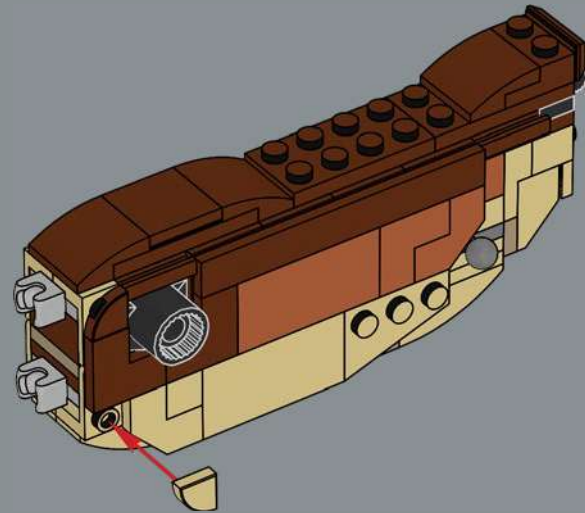

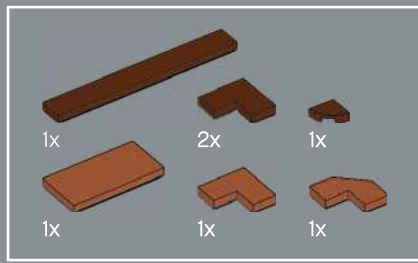

17

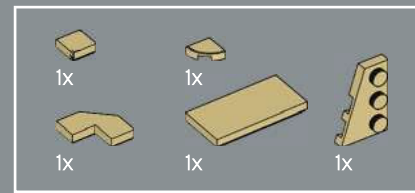
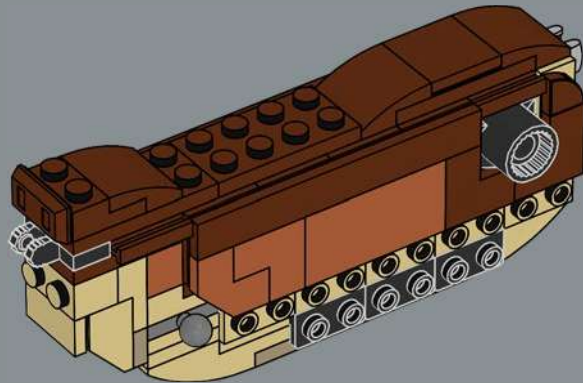

18

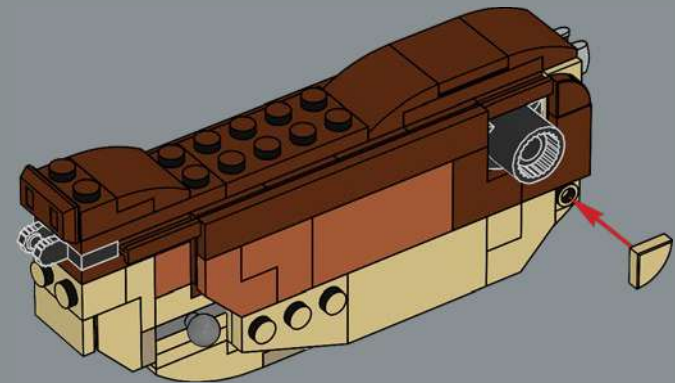

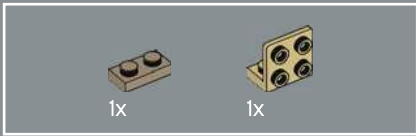

19

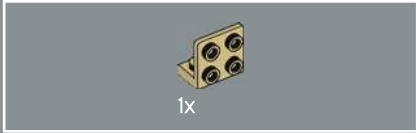

20

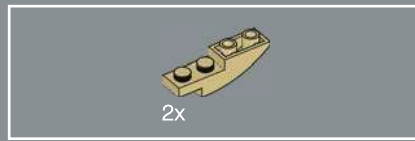

2x

21

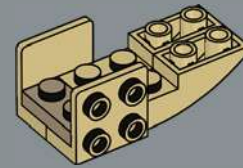

1x

1x

22

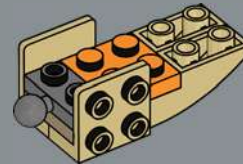

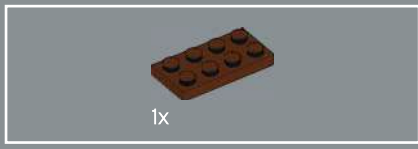

23

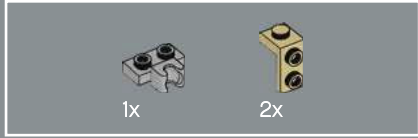
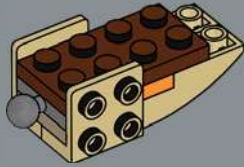

24

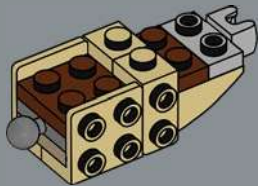

25

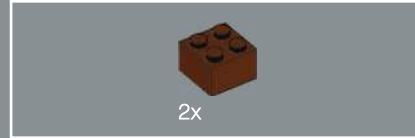
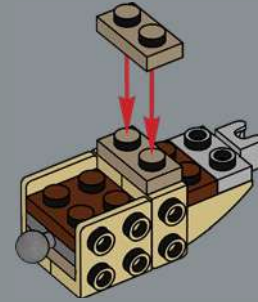

26

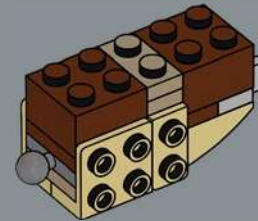



27

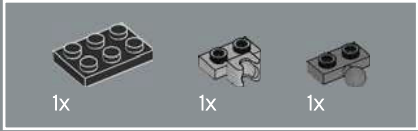
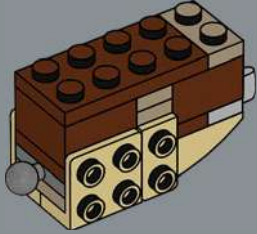

28

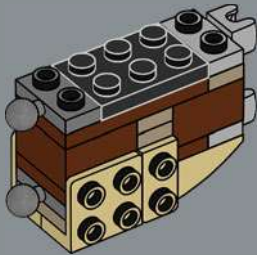

29

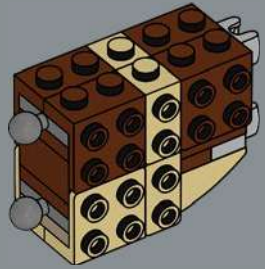

30

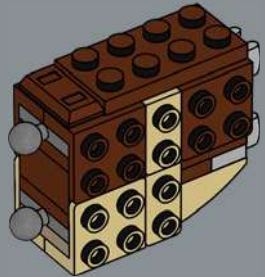

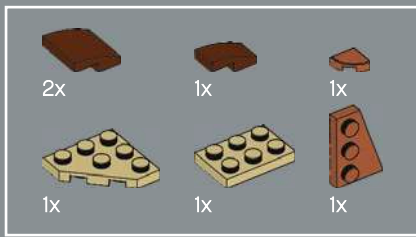

31

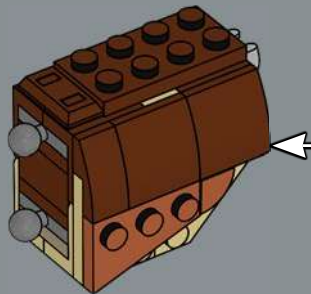
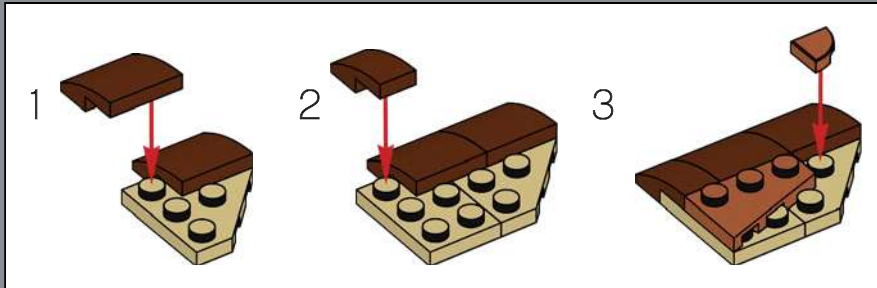

32

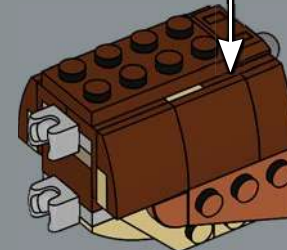
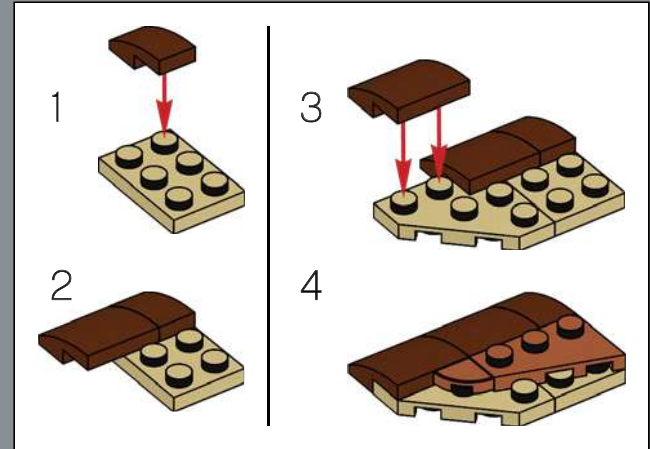

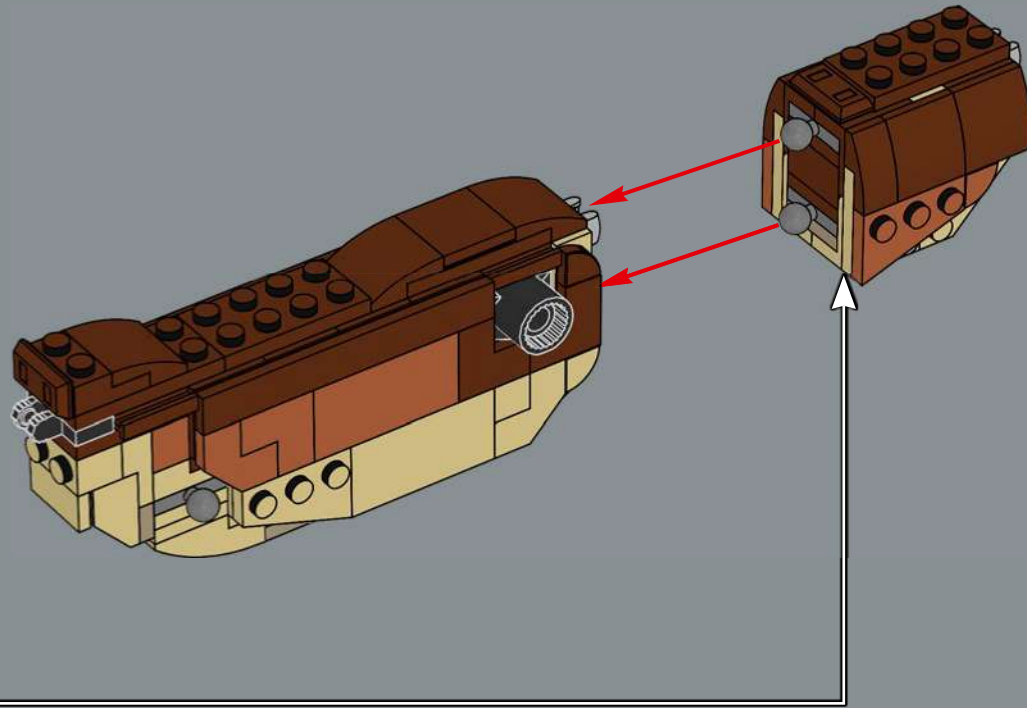



34

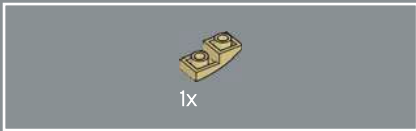
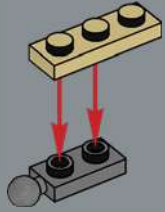

35

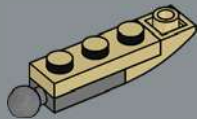

36

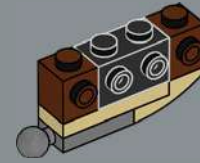

37

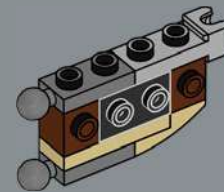



38

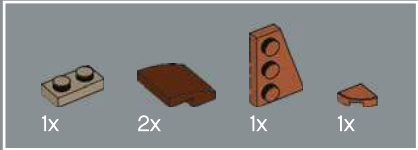
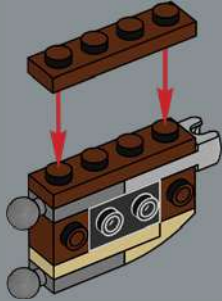

39

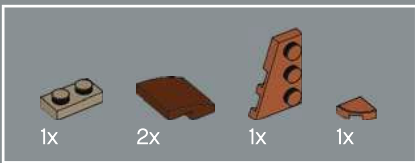
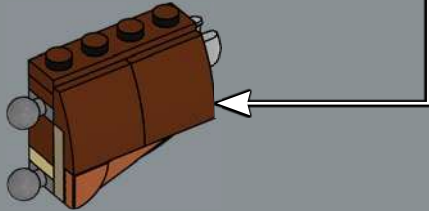
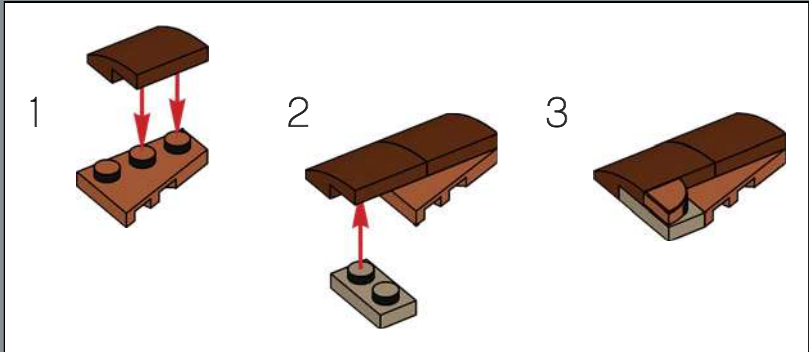

40

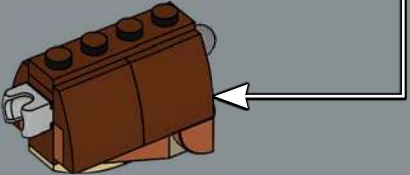
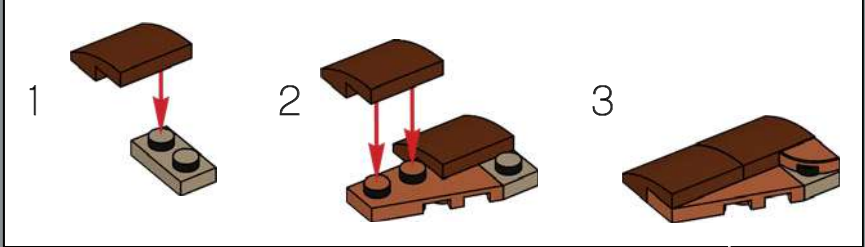

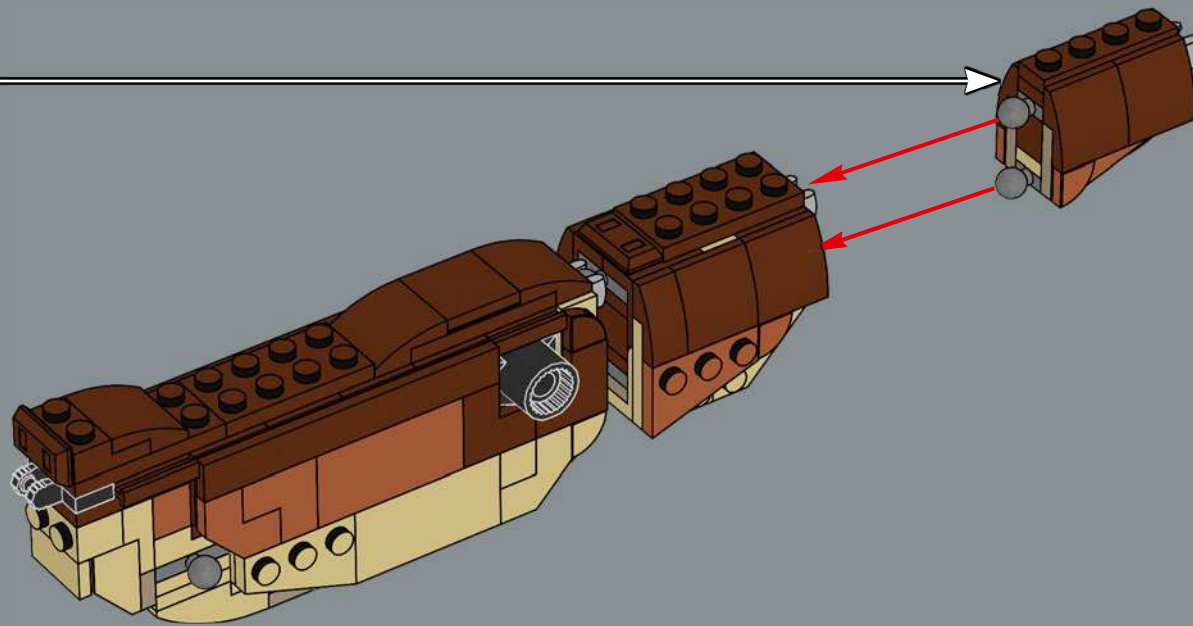

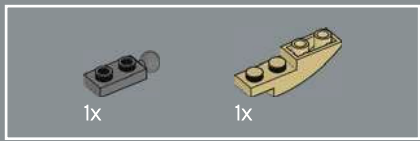

42

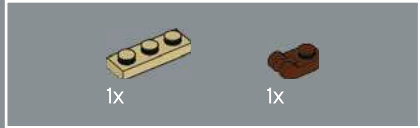
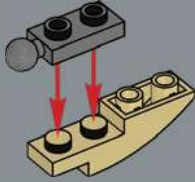

43

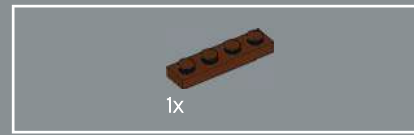
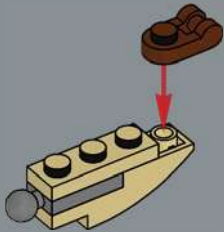

44

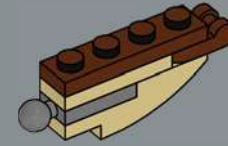

45

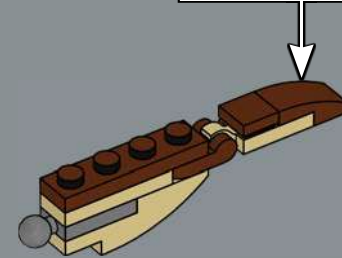
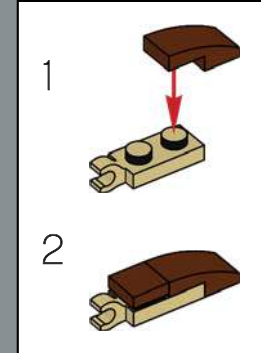

46

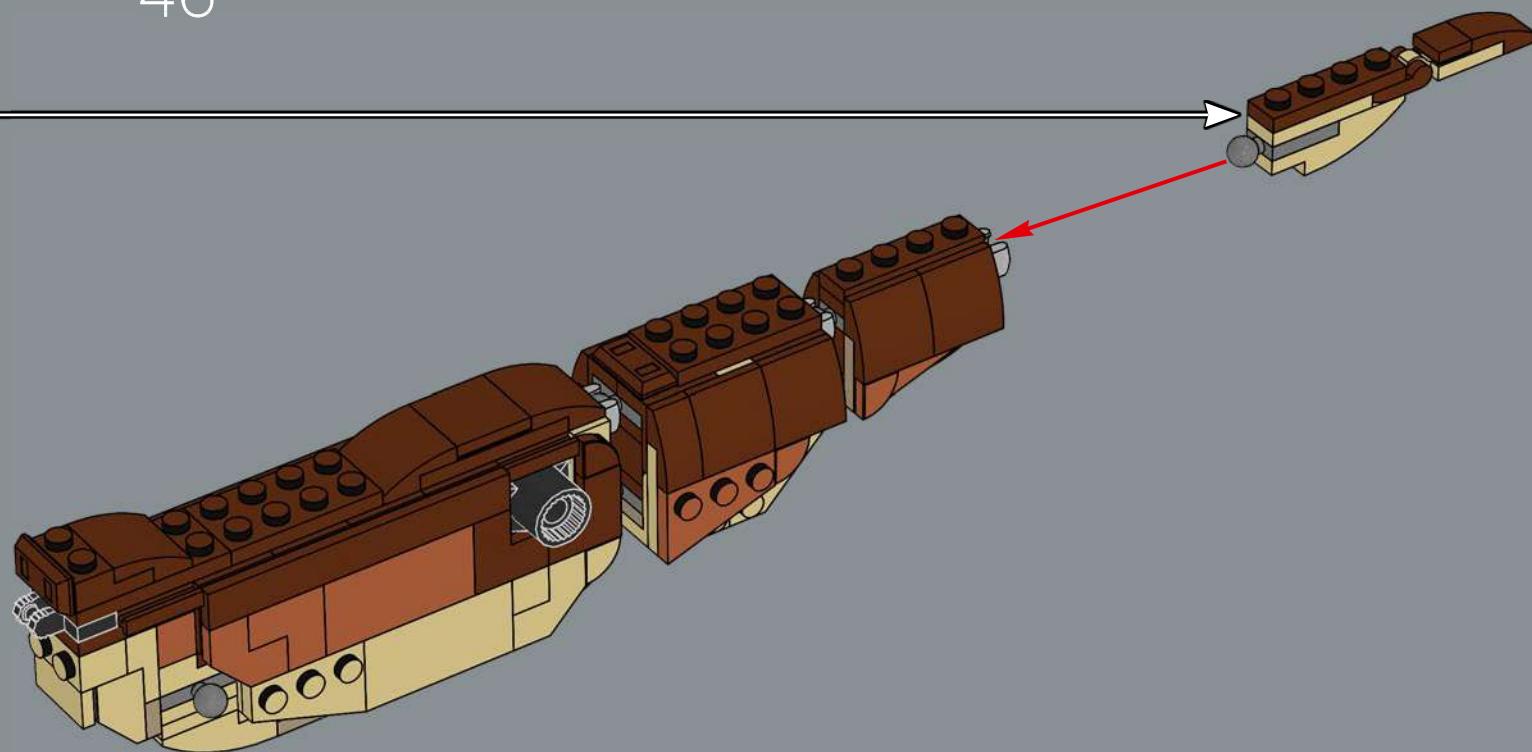

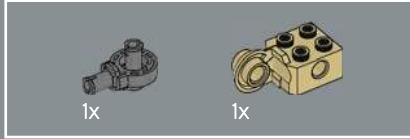
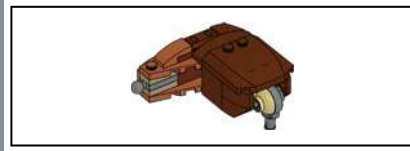
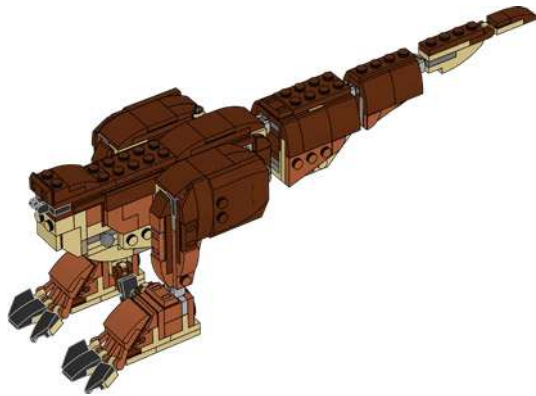

47

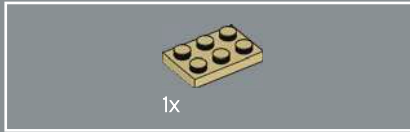
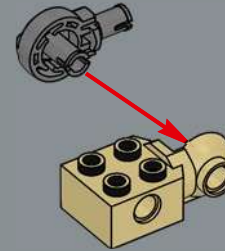

48

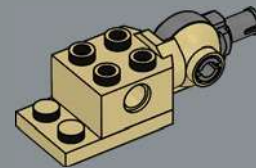

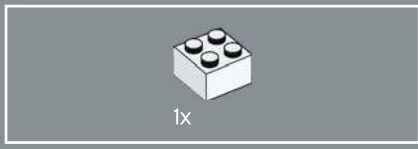

49

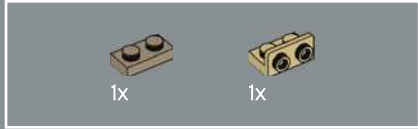

50

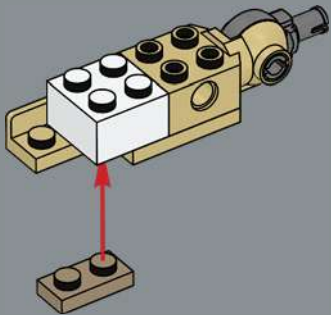

51

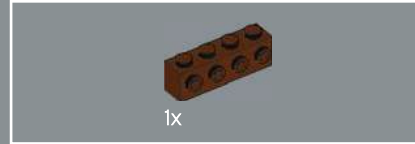
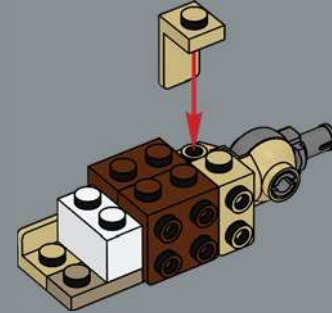

52

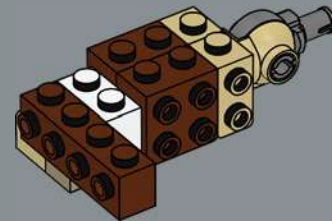

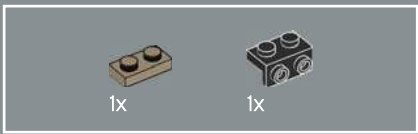

53

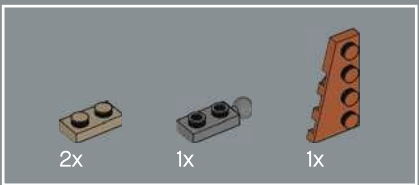
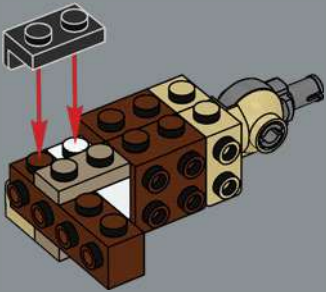

54

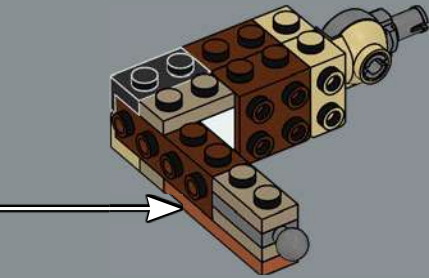
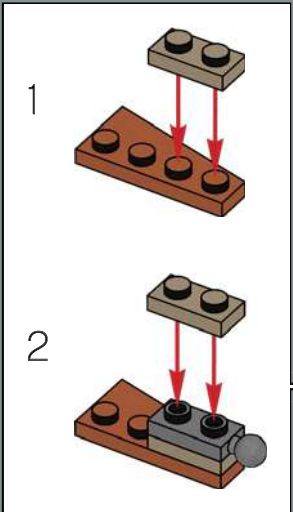



55

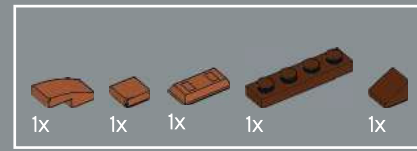
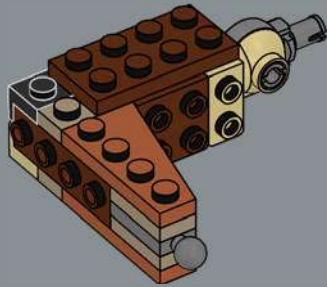

56

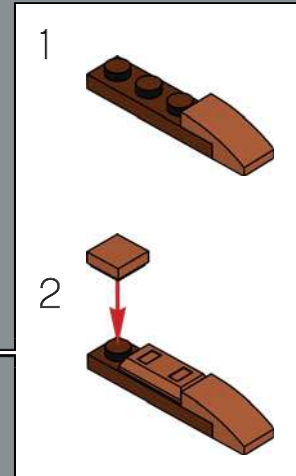
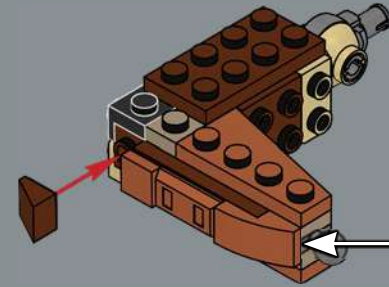



57

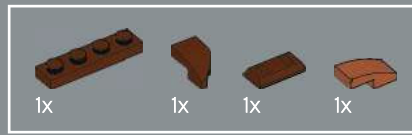
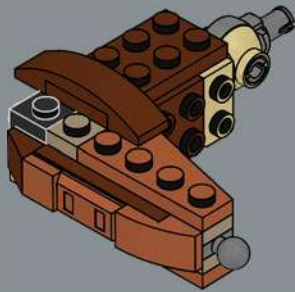

58

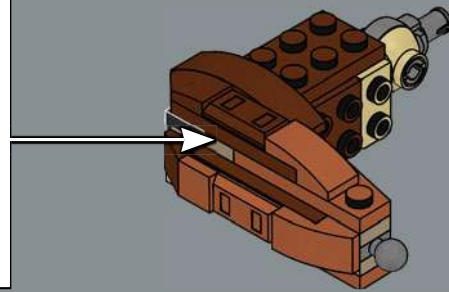
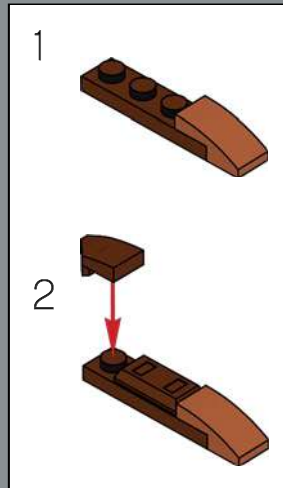

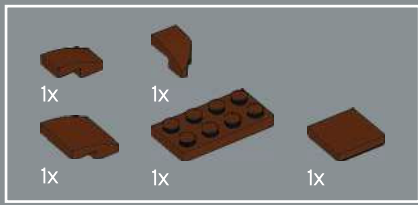

59

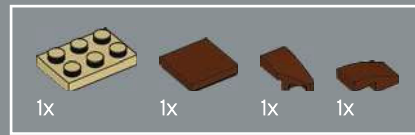
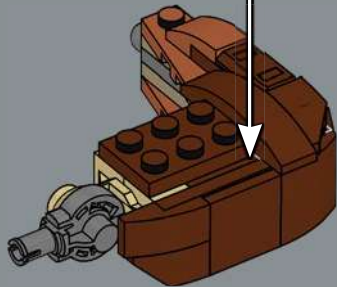
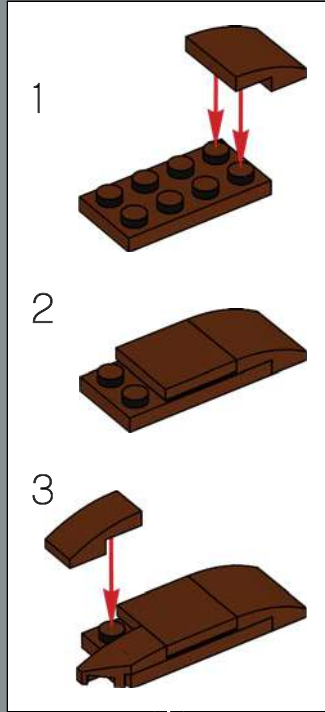

60

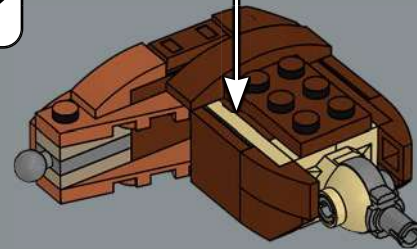
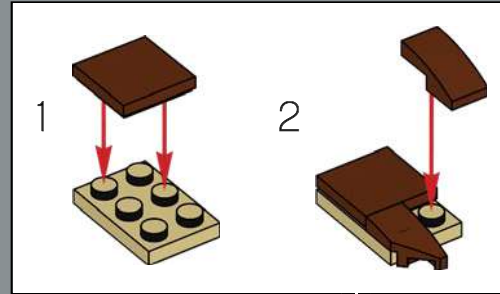

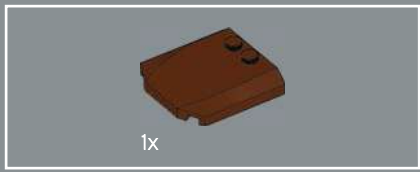

61

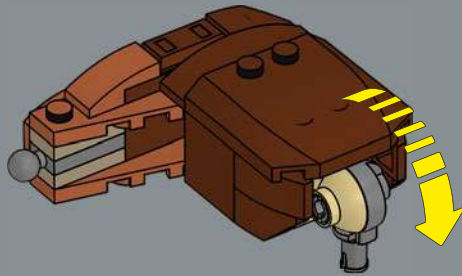

62

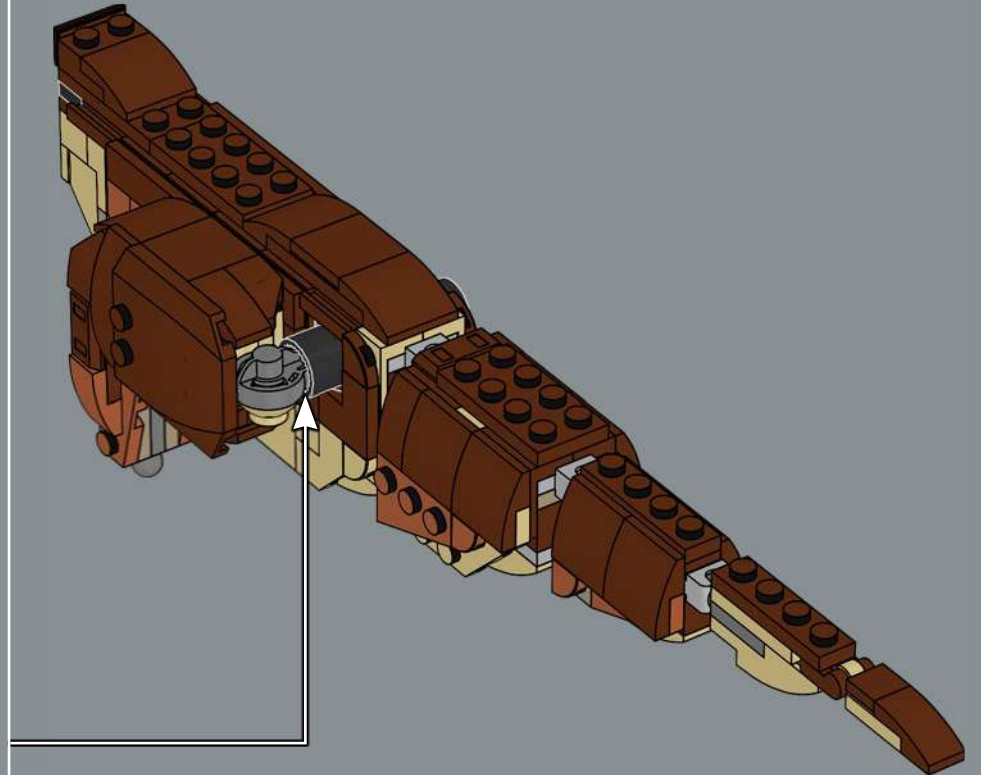

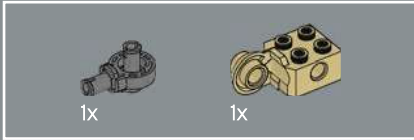

63

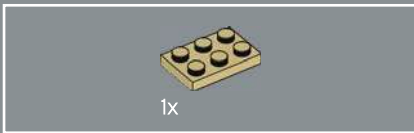
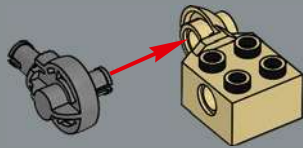

64

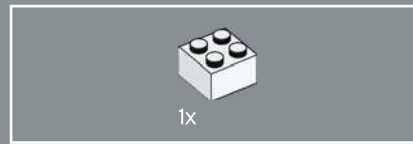

65



66

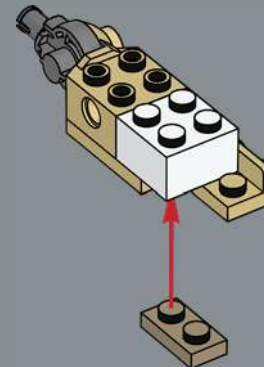



67

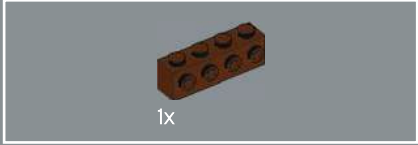
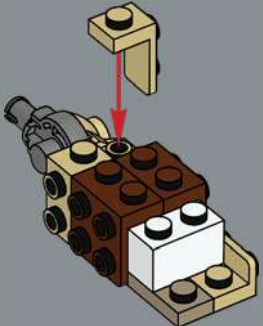

68

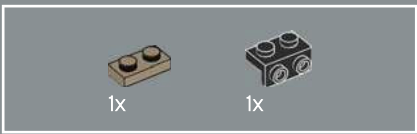
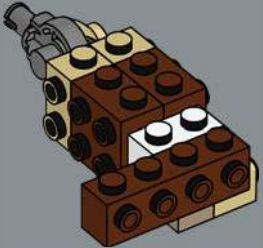

69

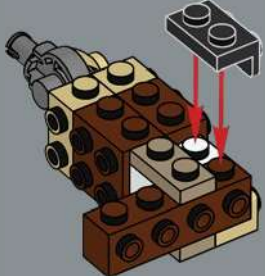

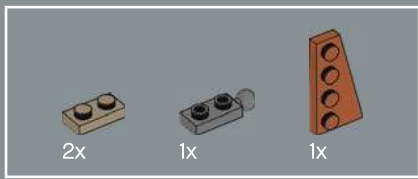

70

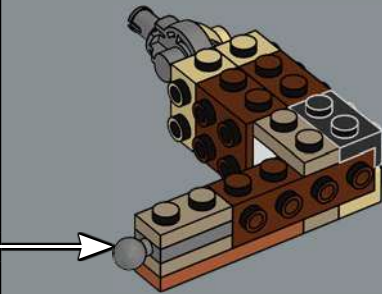
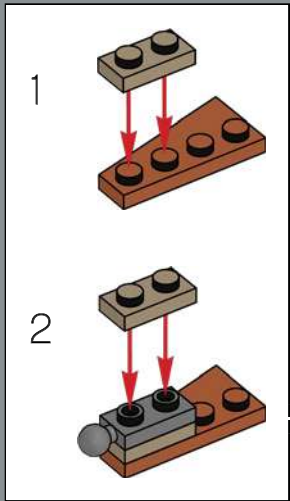

71

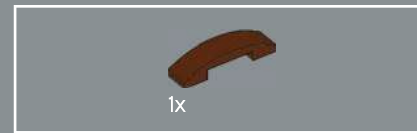
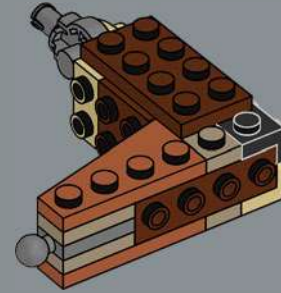

72

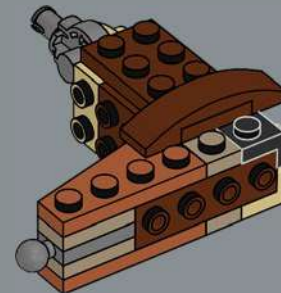

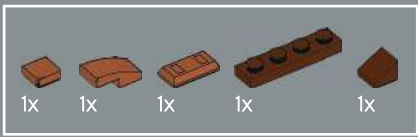

73

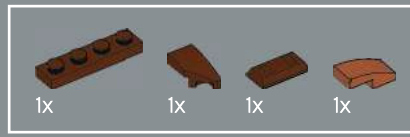
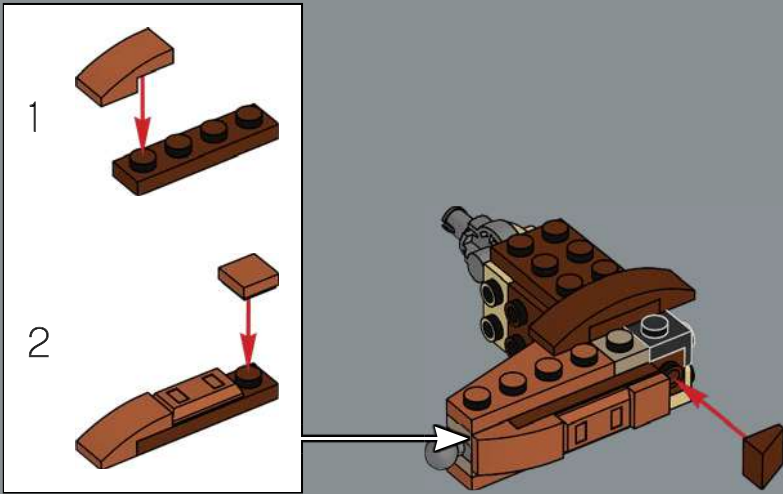

74

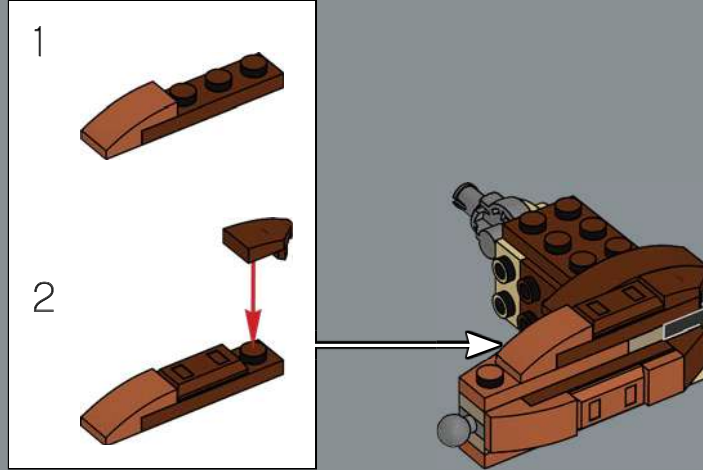

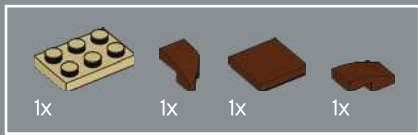

75

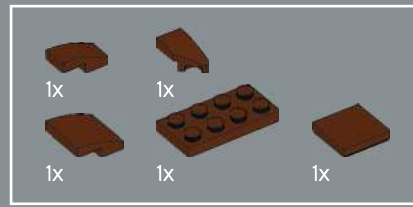
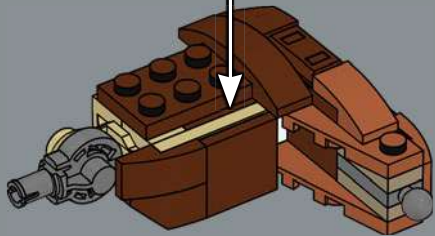
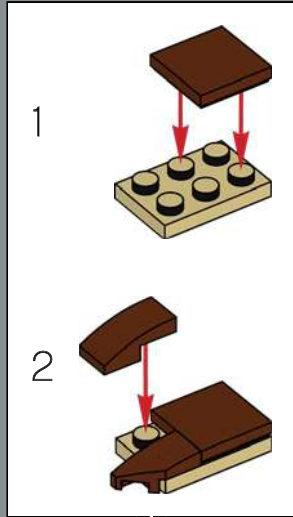

76

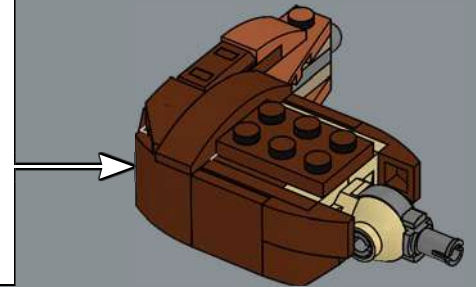
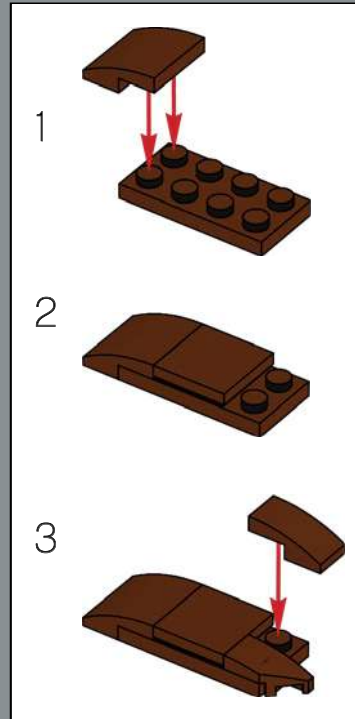

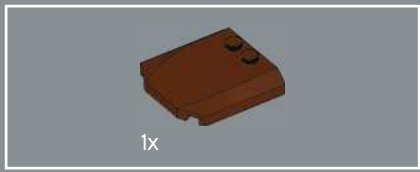

77

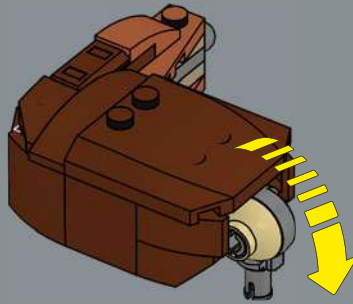

78

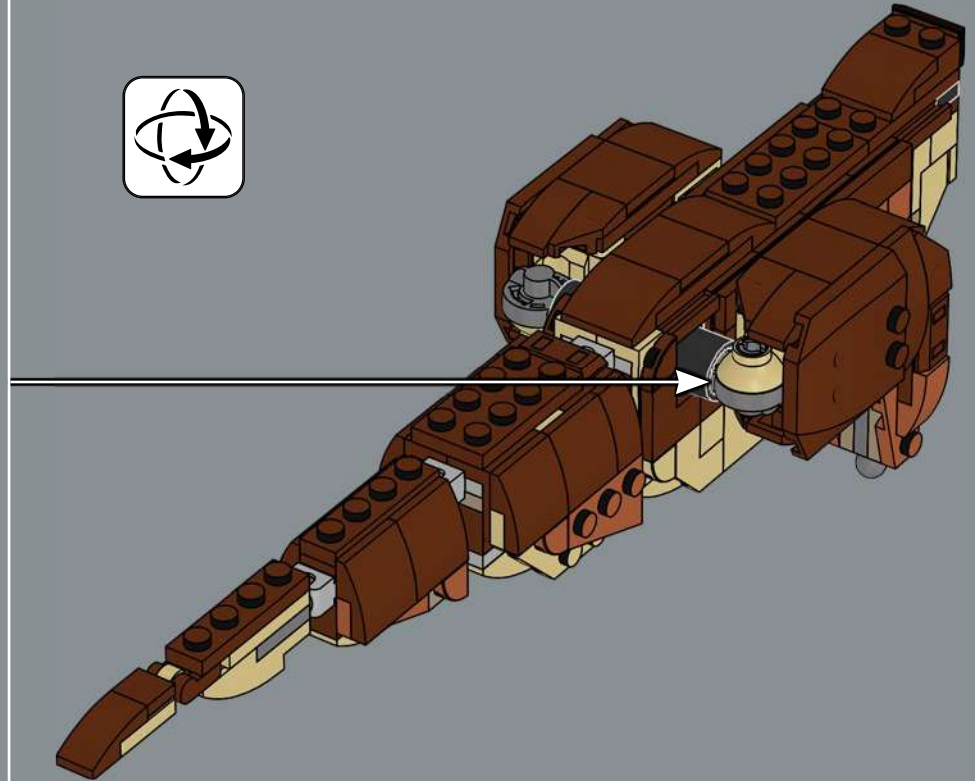

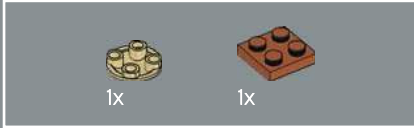
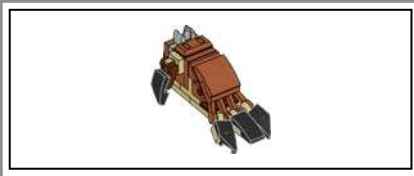

79

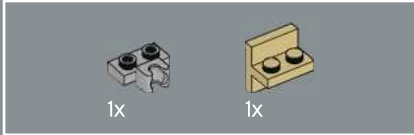
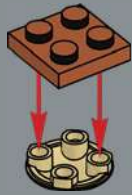

80

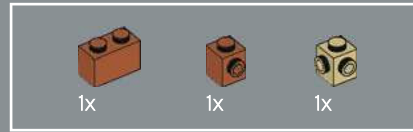

81

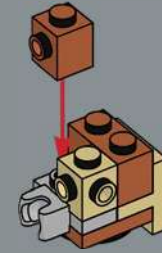

82

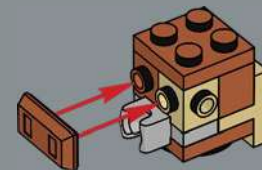

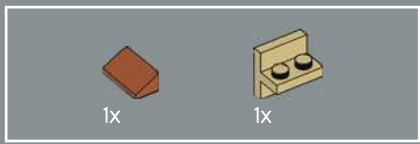

83

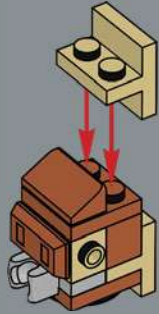

84

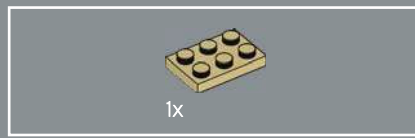
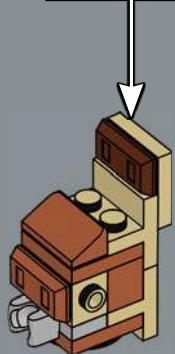
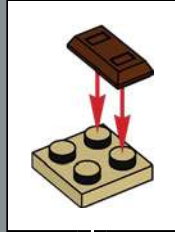

85

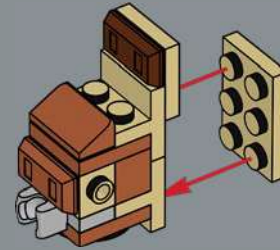

86

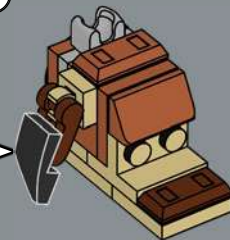
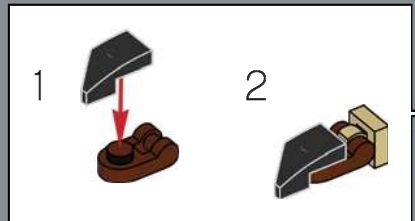



87

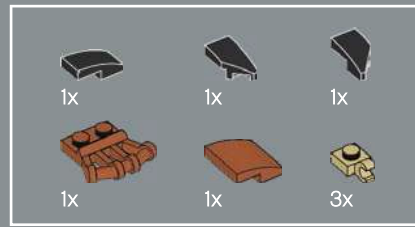
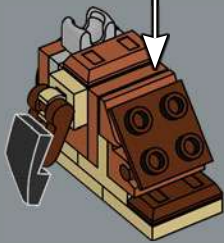
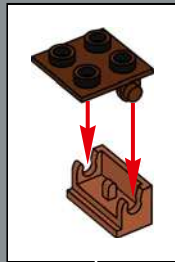

88

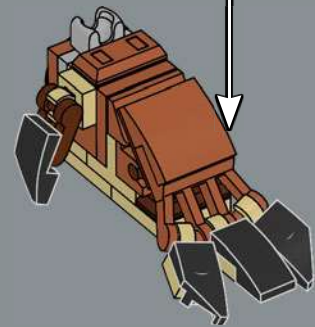

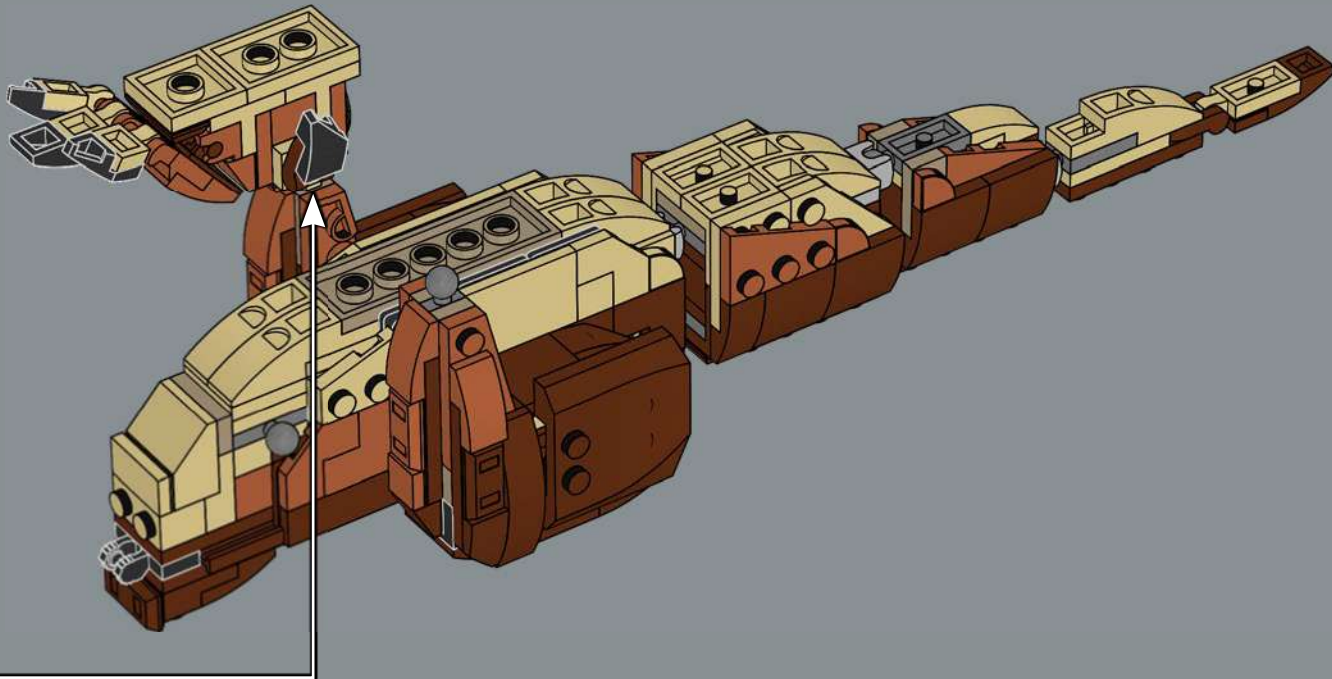

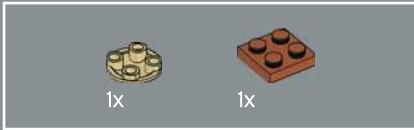

90

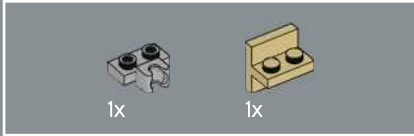
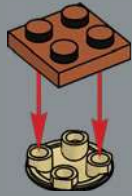

91

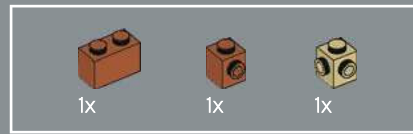
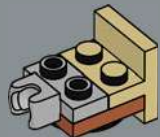

92

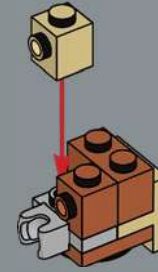

93

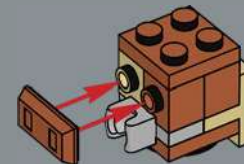

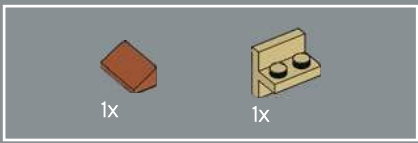

94

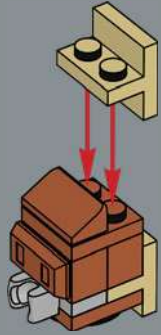

95

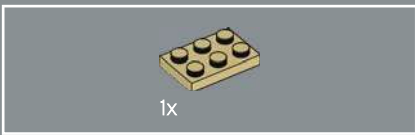
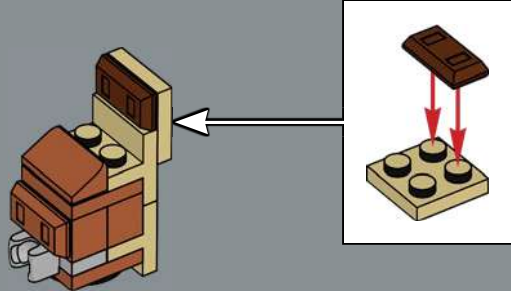

96

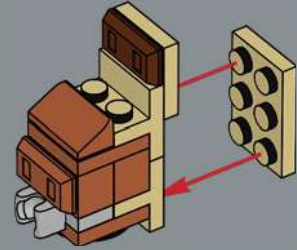

97

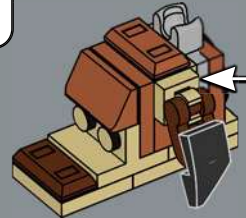
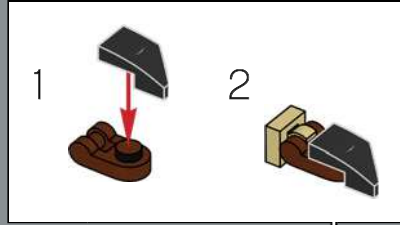



98

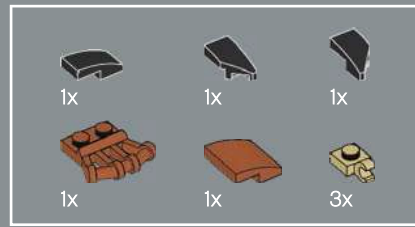
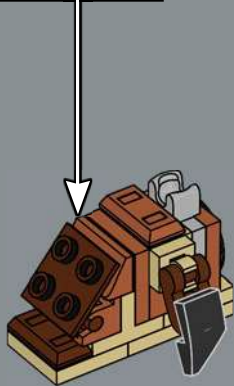

99

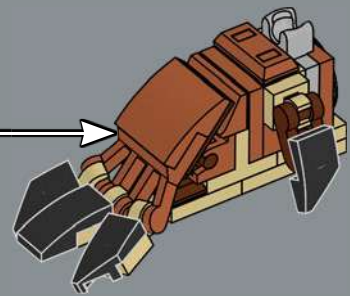
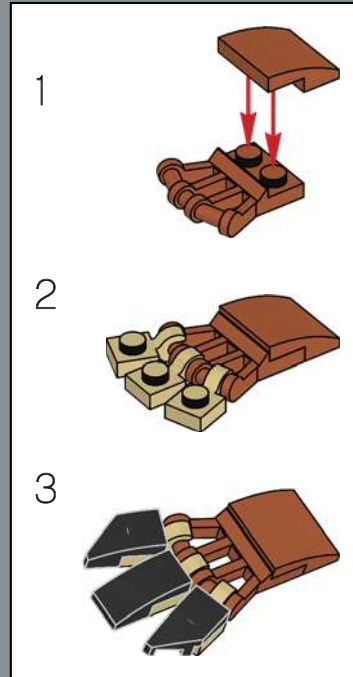

100

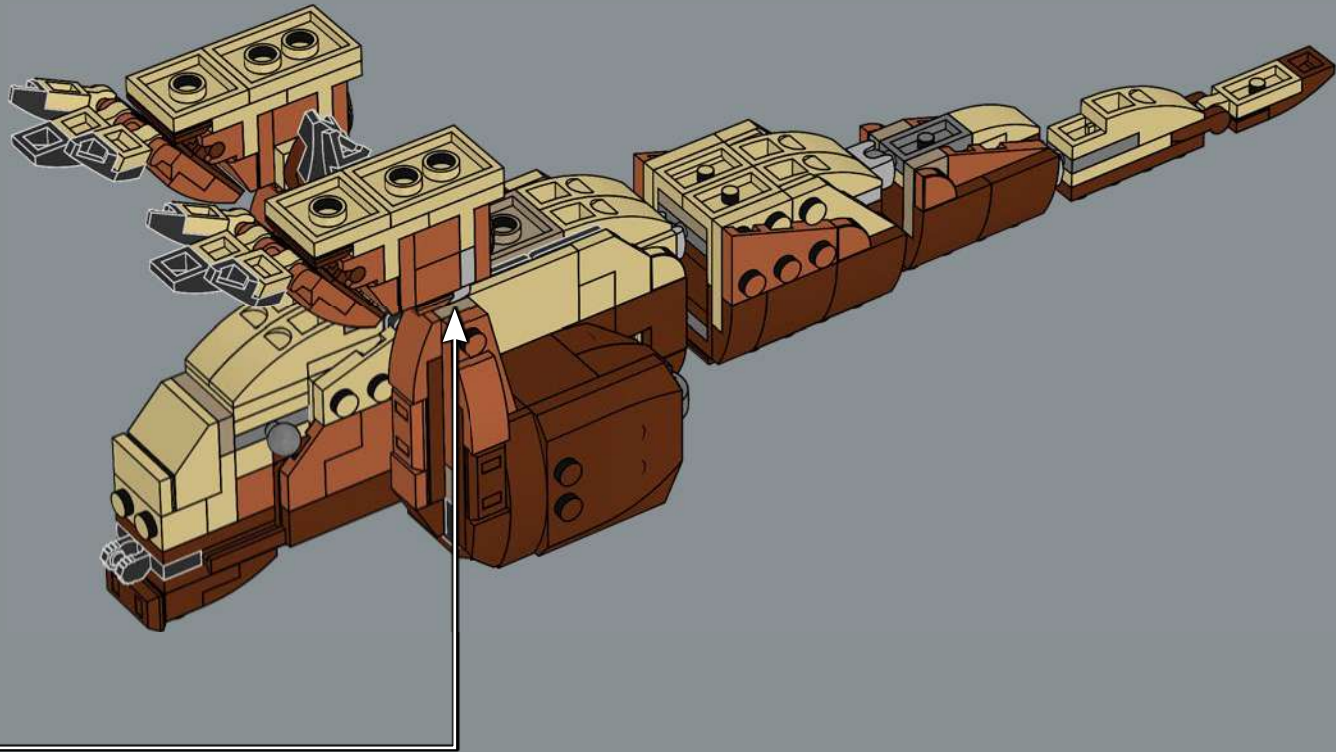

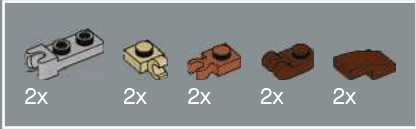
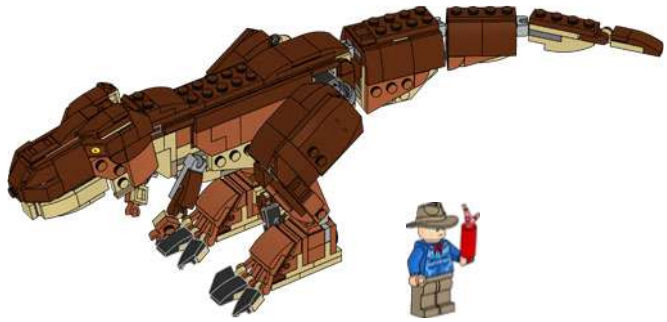
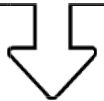

101

1



2

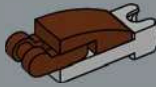

3

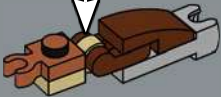
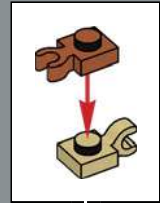

2x

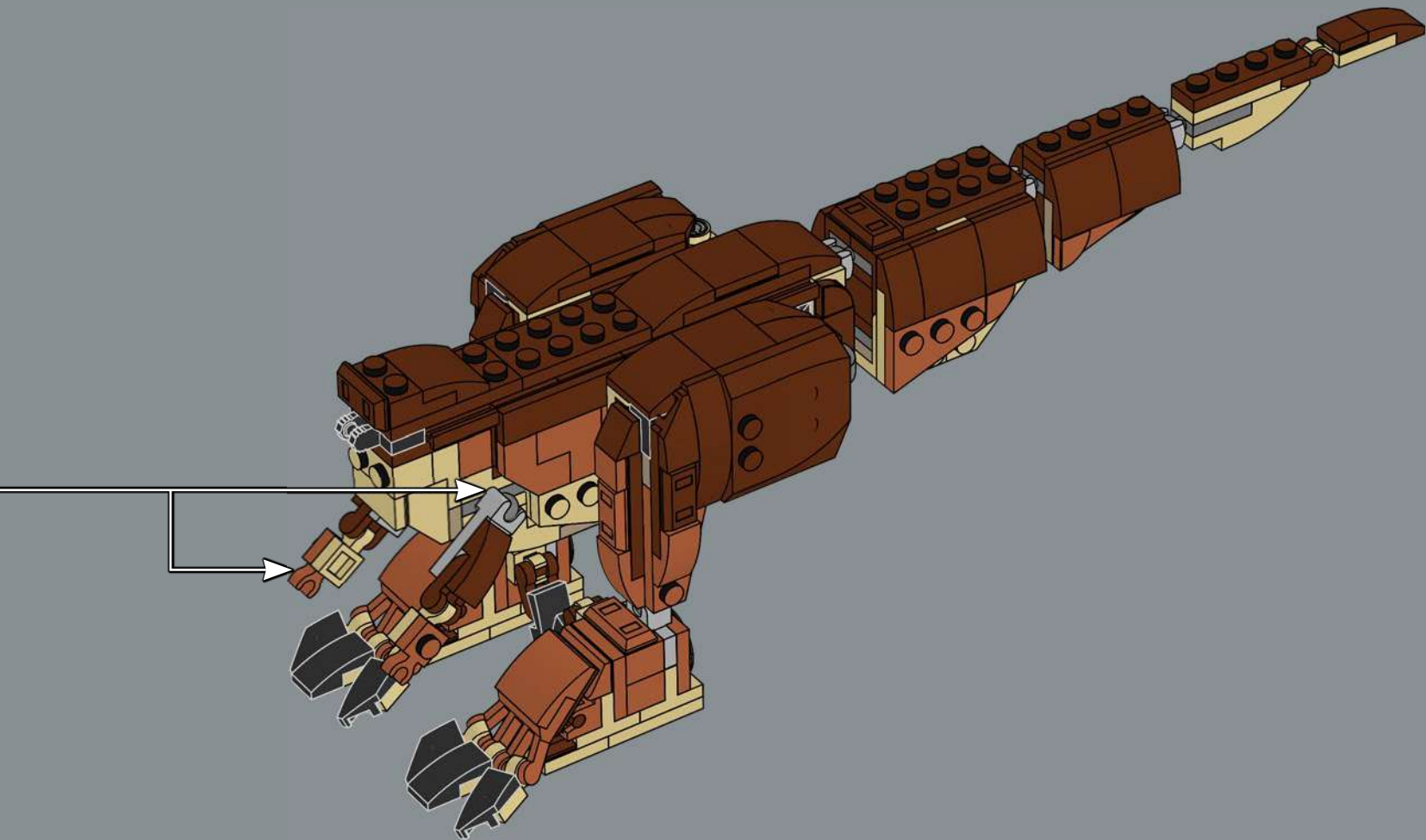

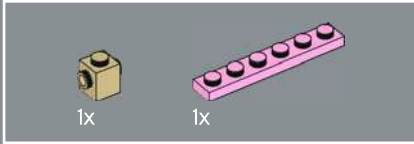
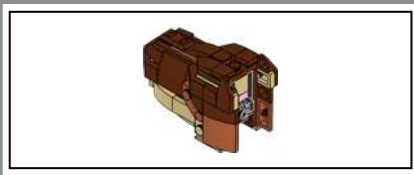

102

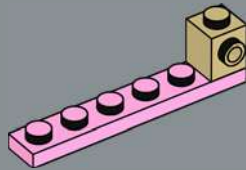

103

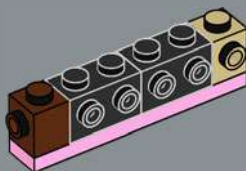

104

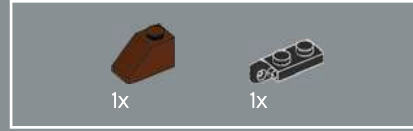
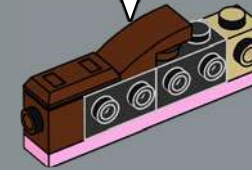
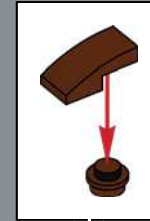

105

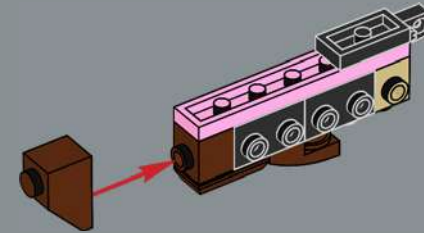



106

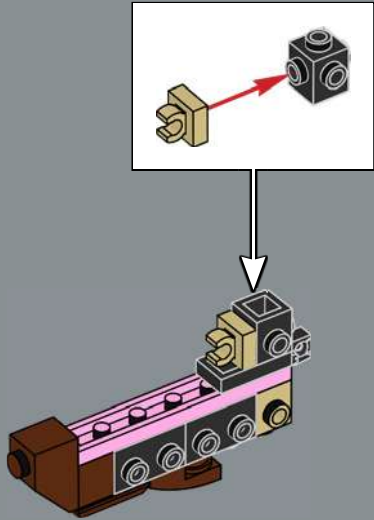

107

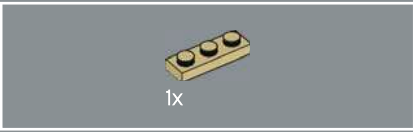
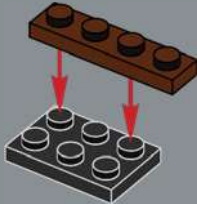

108





109

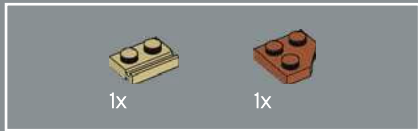
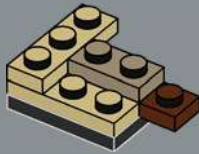

110

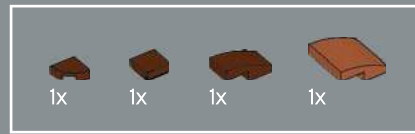
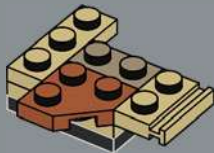

111

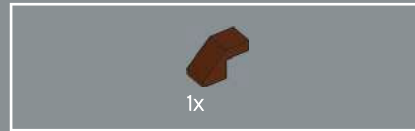
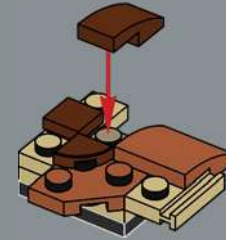

112

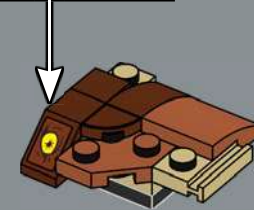
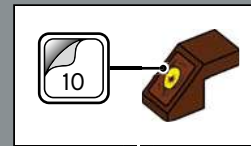

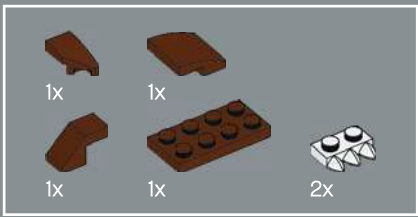

113

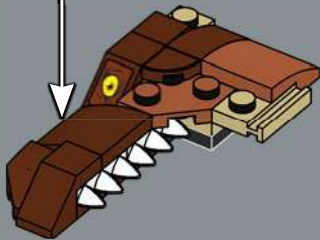
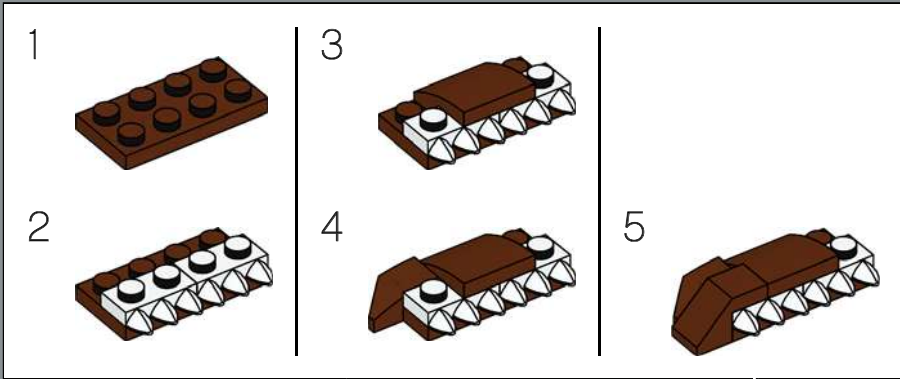

114



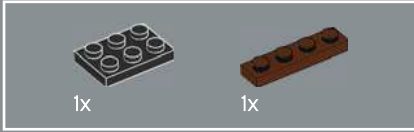
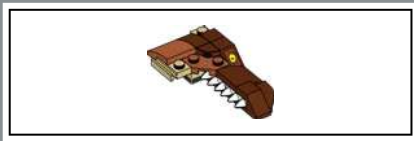

115

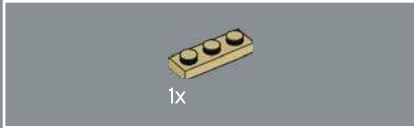
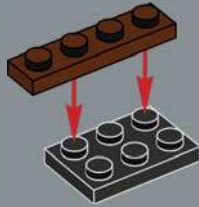

116

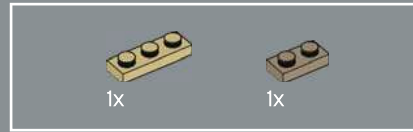
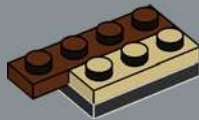

117

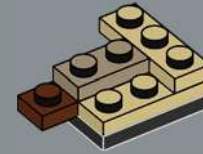

118

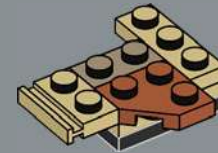

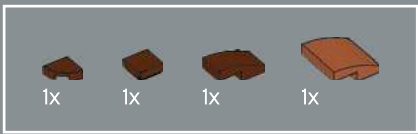

119

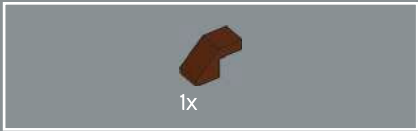
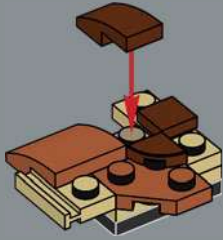

120

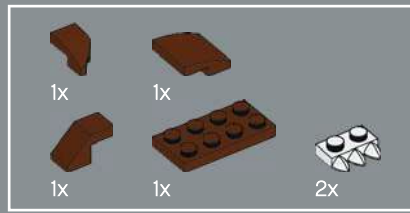
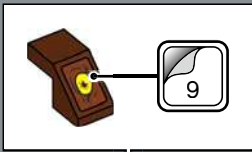

121

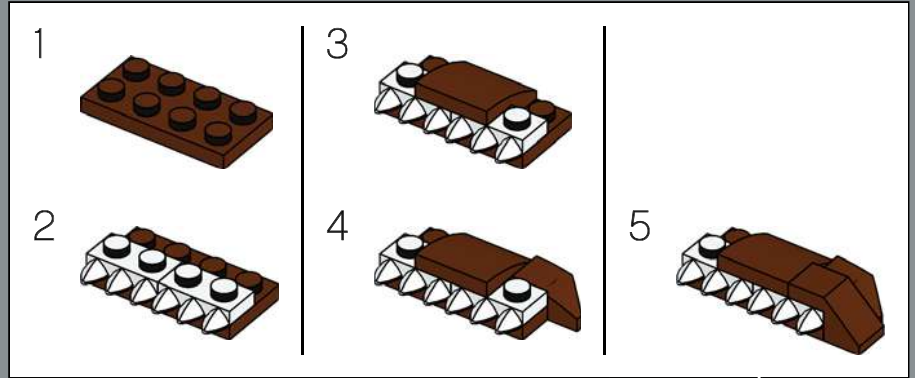

122

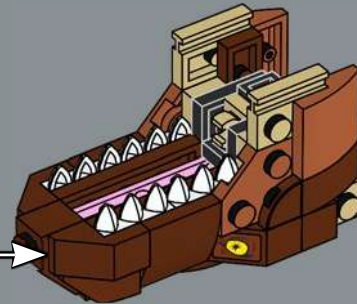

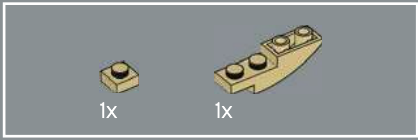

123

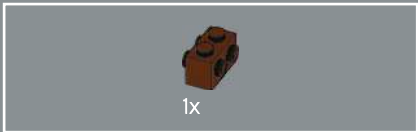
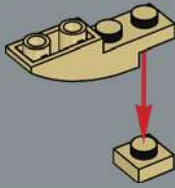

124

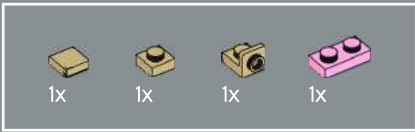
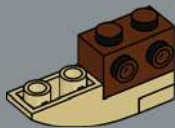

125

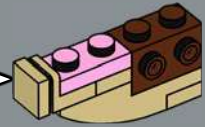
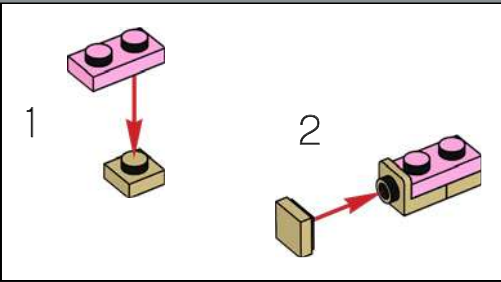

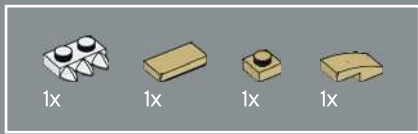

126

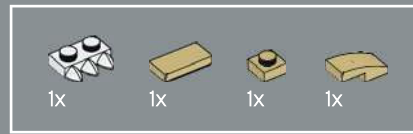
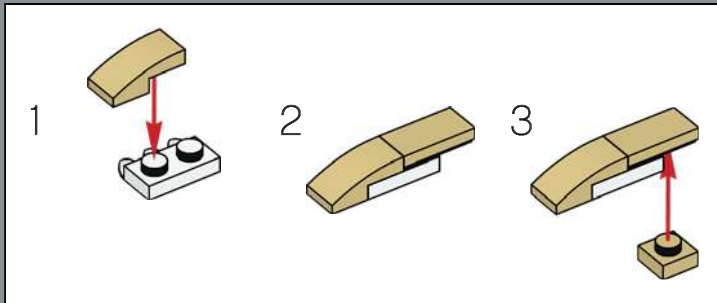

127

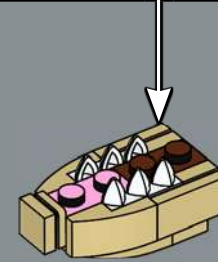
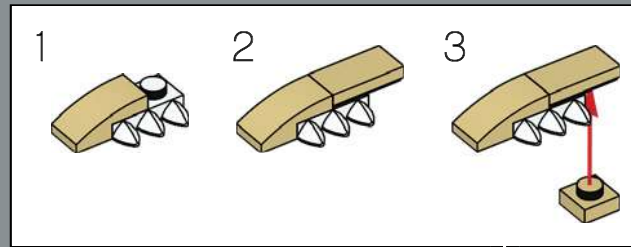



128

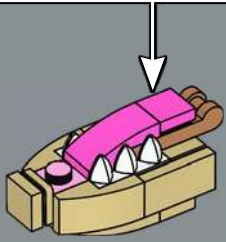
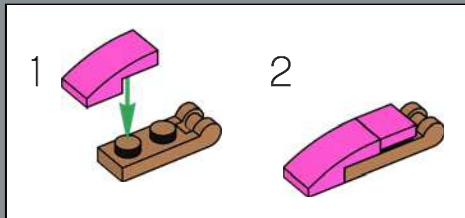

129

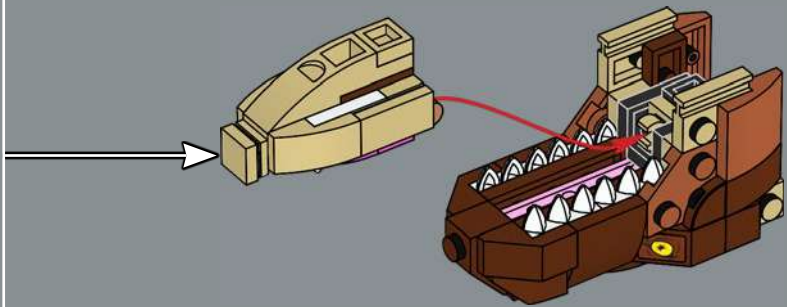



130

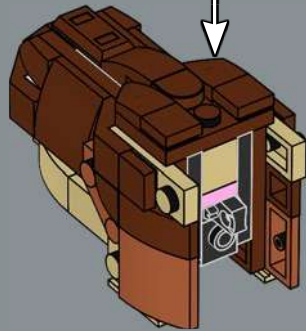
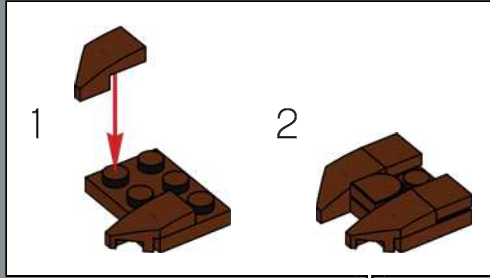

131

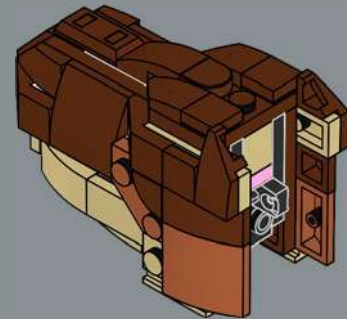

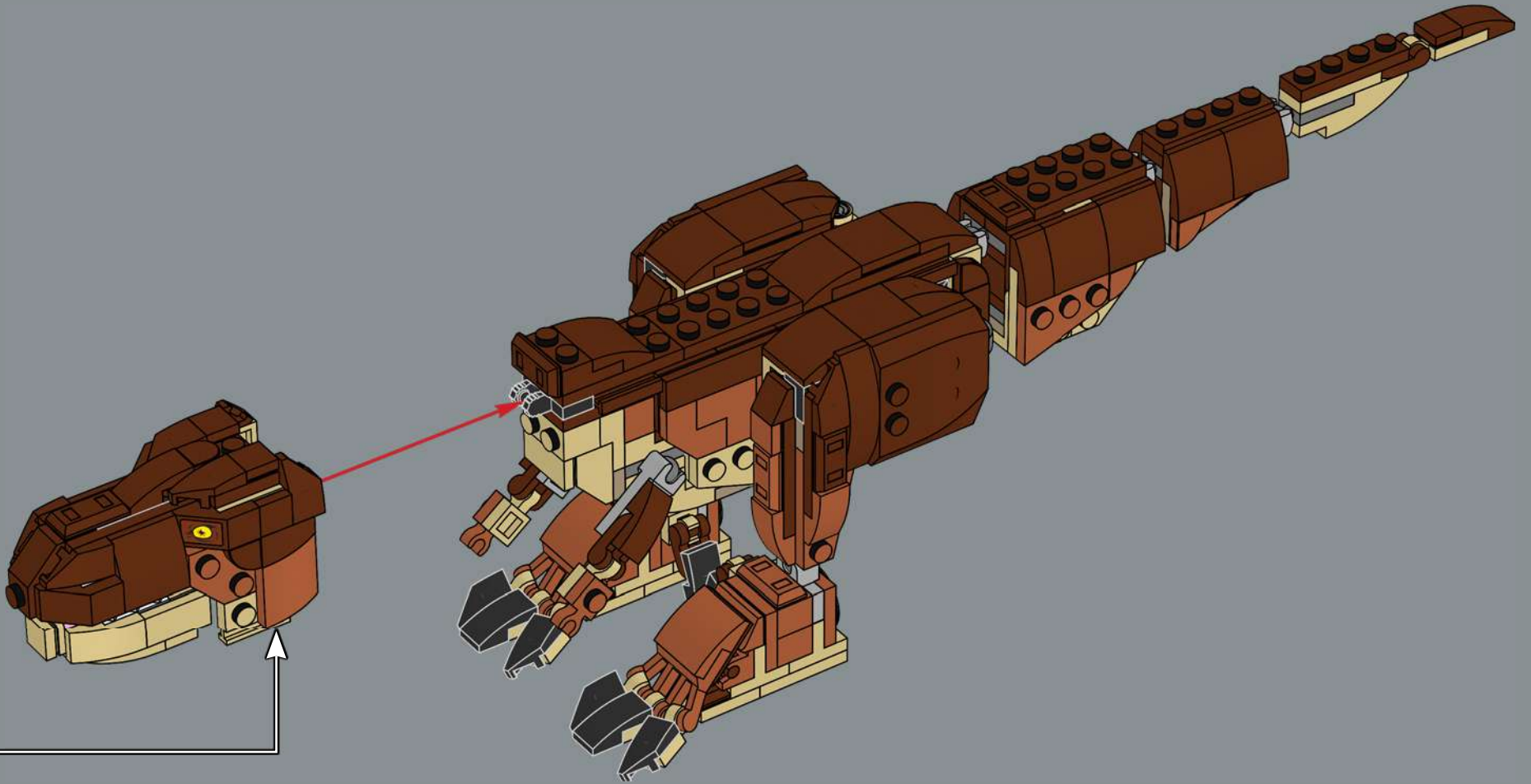

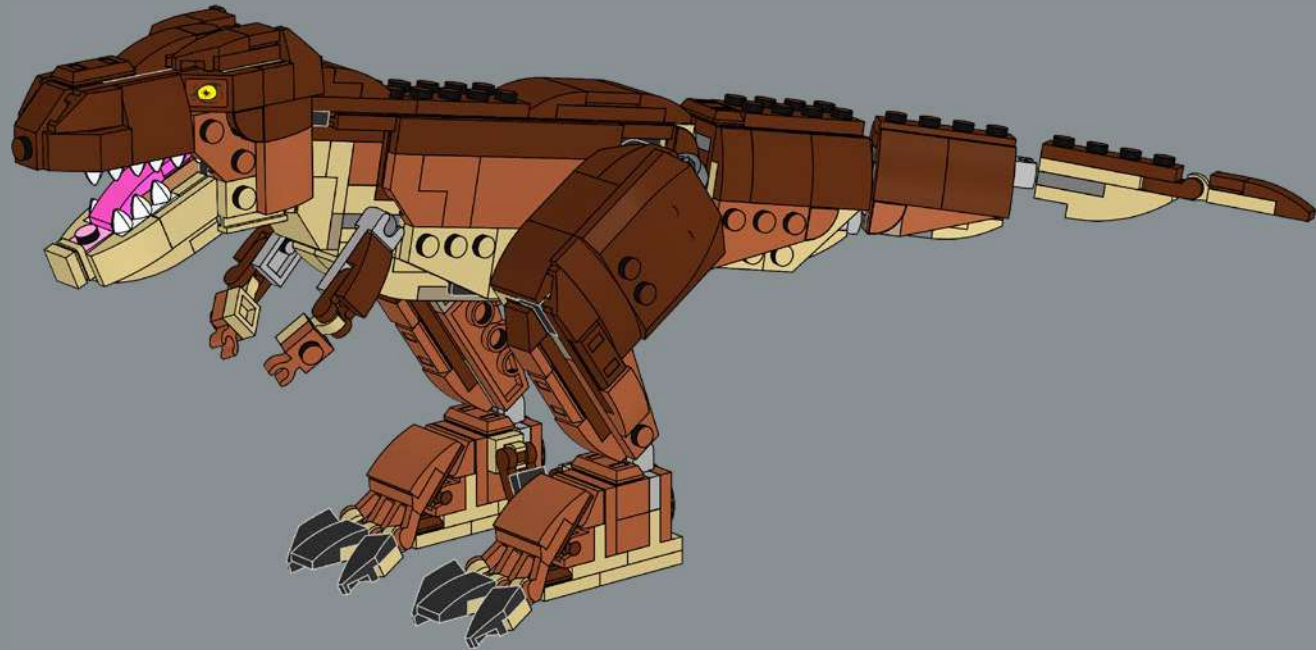

THE KING OF THE TYRANT LIZARDS

Back in 1993, audiences had never seen anything like it, a 13 m (44 ft.)-tall, life-like apex predator. Achieved through ground-breaking animatronics, complemented by a small amount of CGI, the result is a creation that still very much stands the test of time.

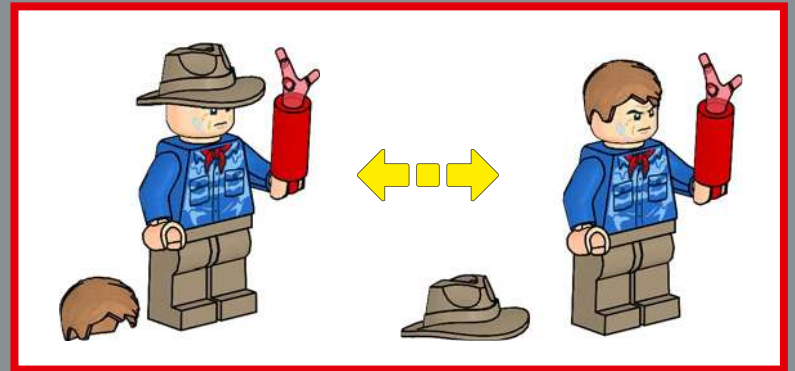
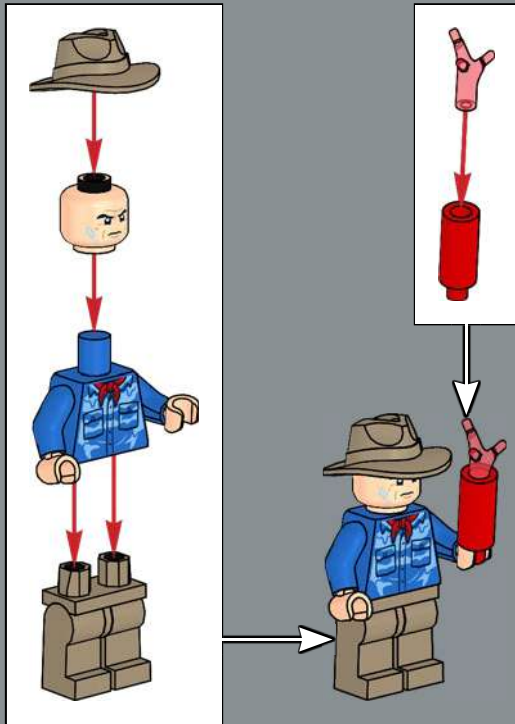

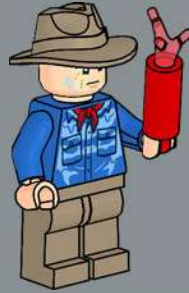

FETCH, REXY!

With Lex and Tim trapped underneath the flipped car, it takes the quick thinking of Dr. Grant to save the day. He lights a flare and tosses it back towards the paddock, distracting the T. rex and giving the kids a chance to escape.



6

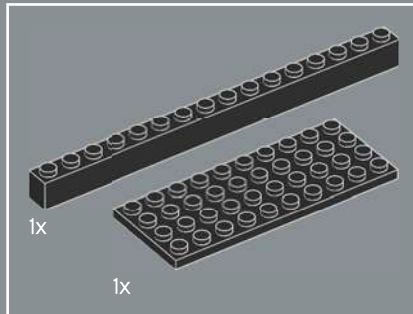
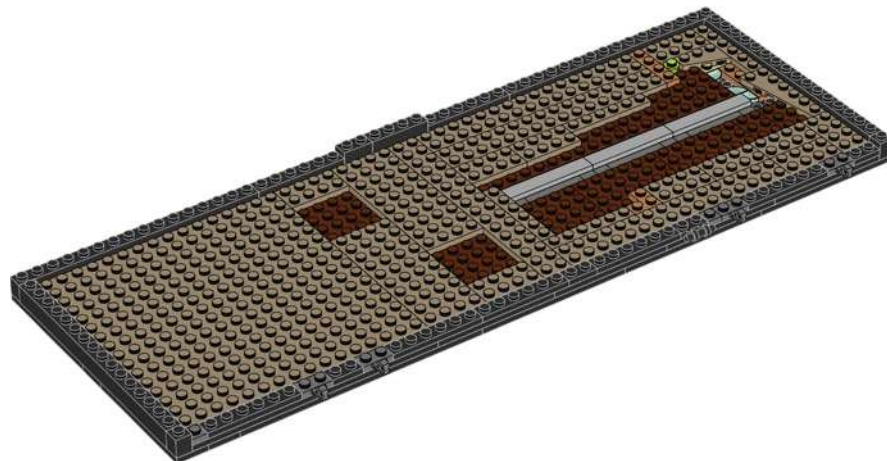
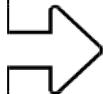

1x

1x

1

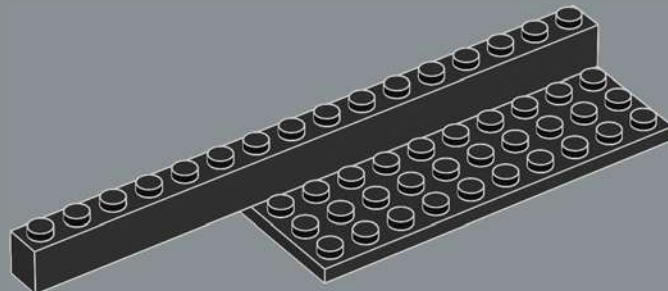

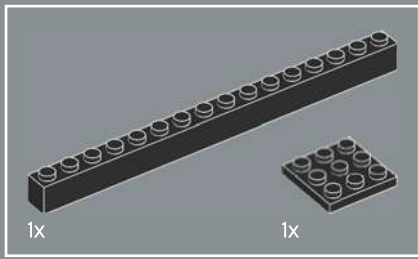

2

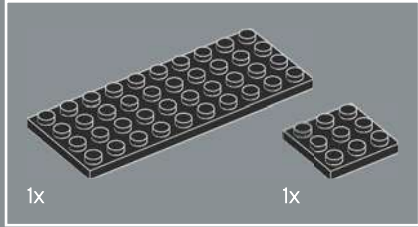
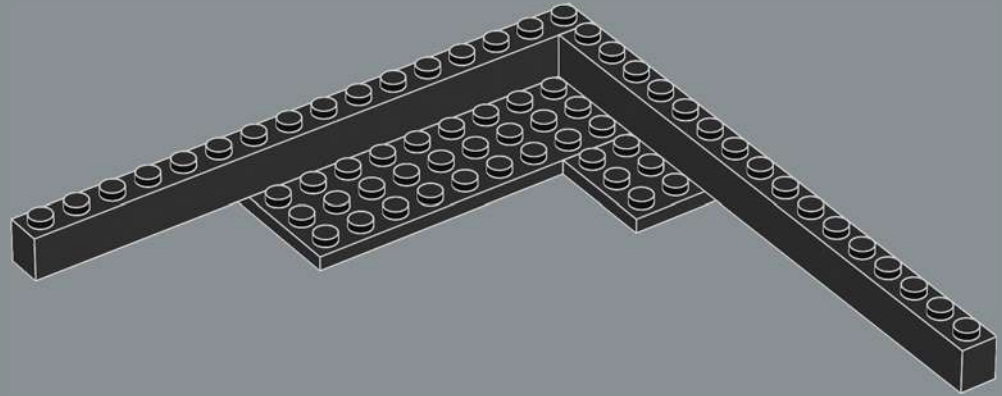

3

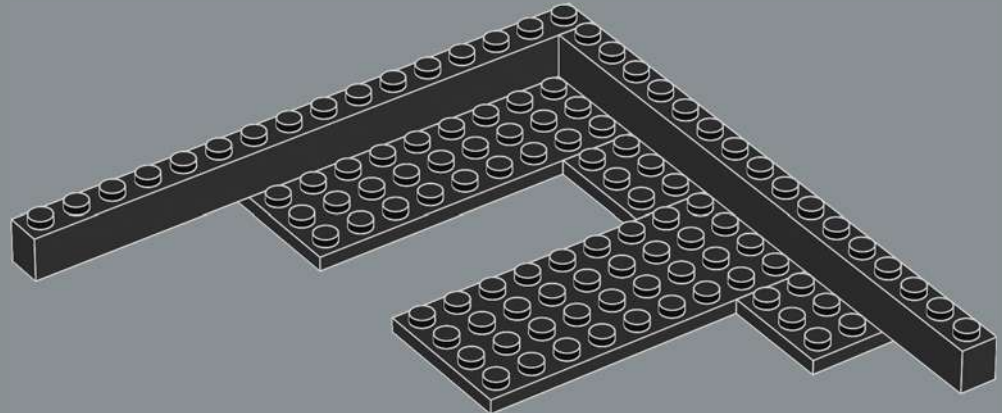

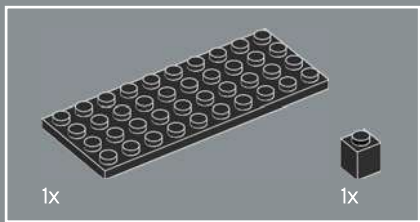

4

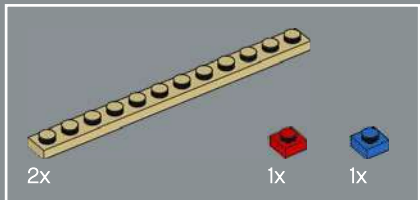
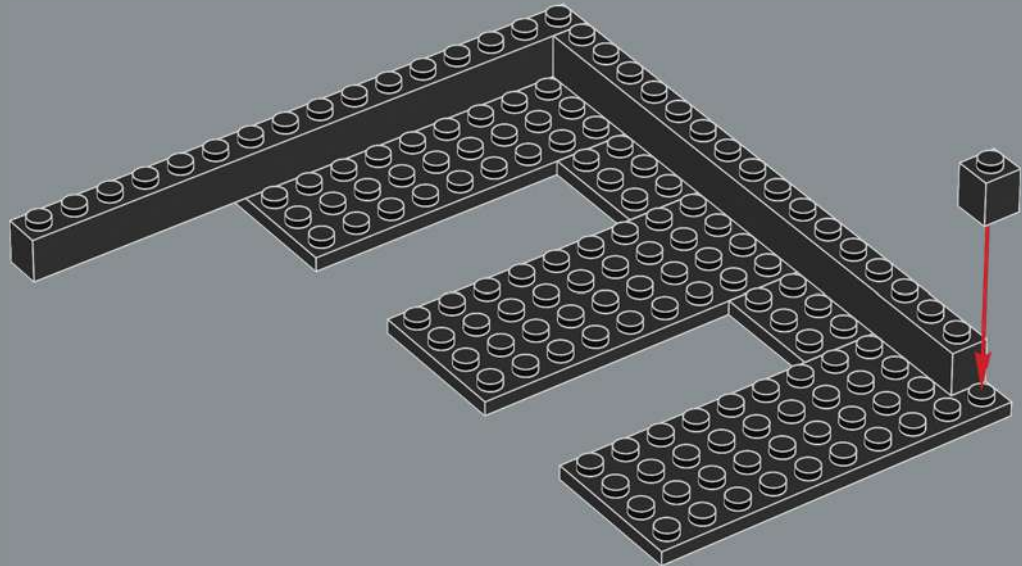

5

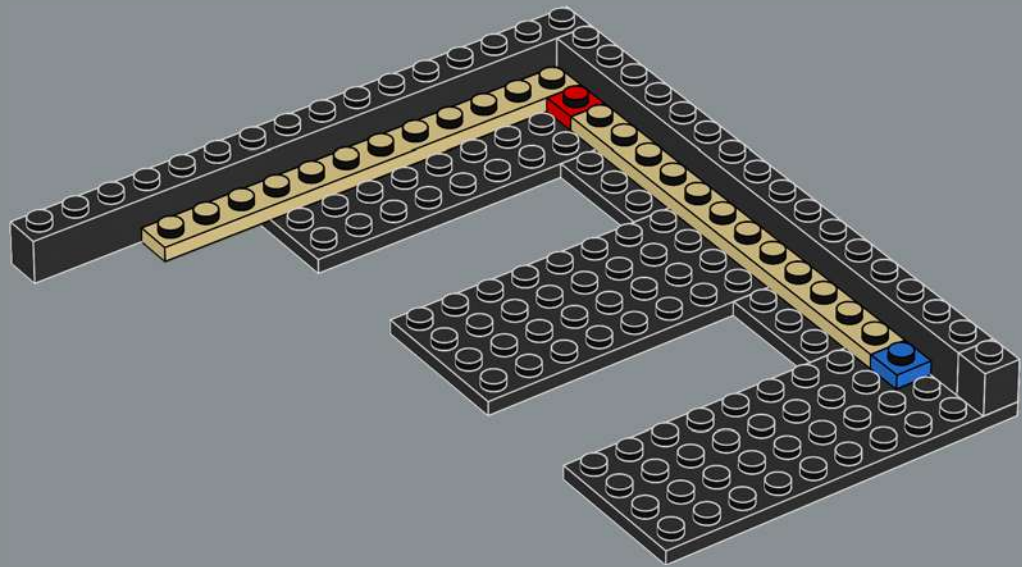

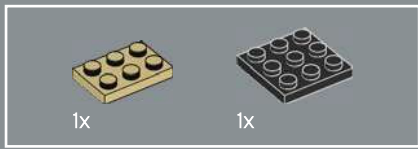

6

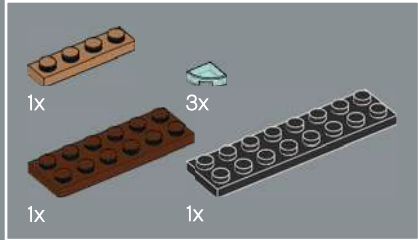
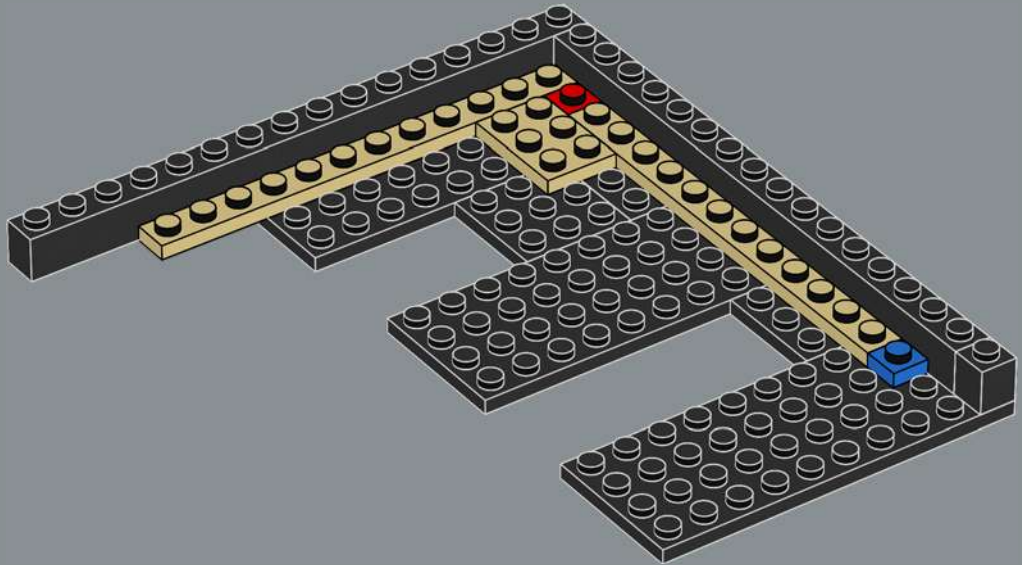

7

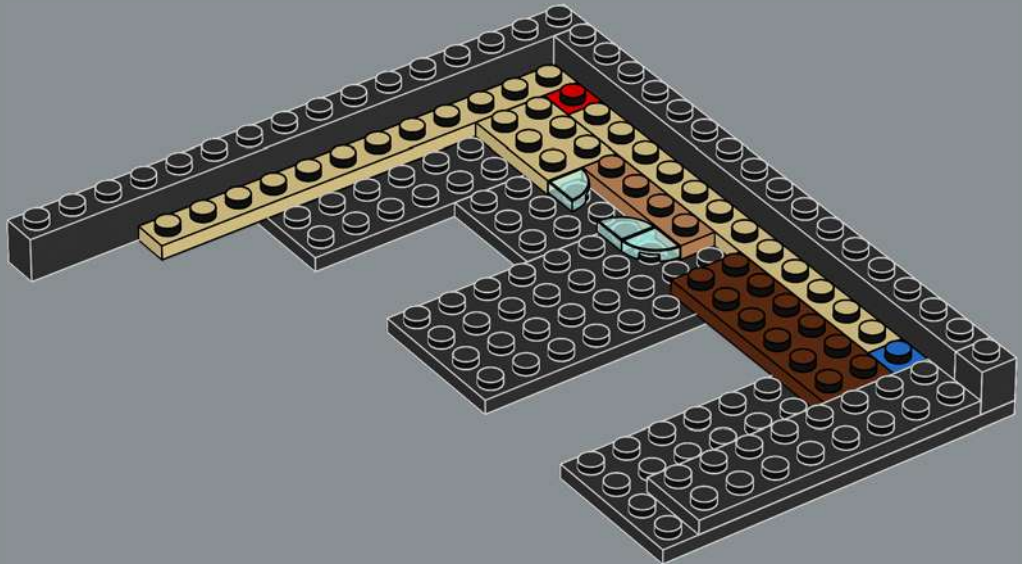

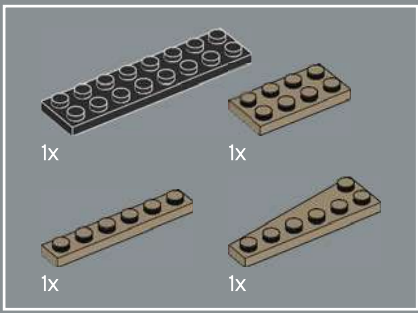

8

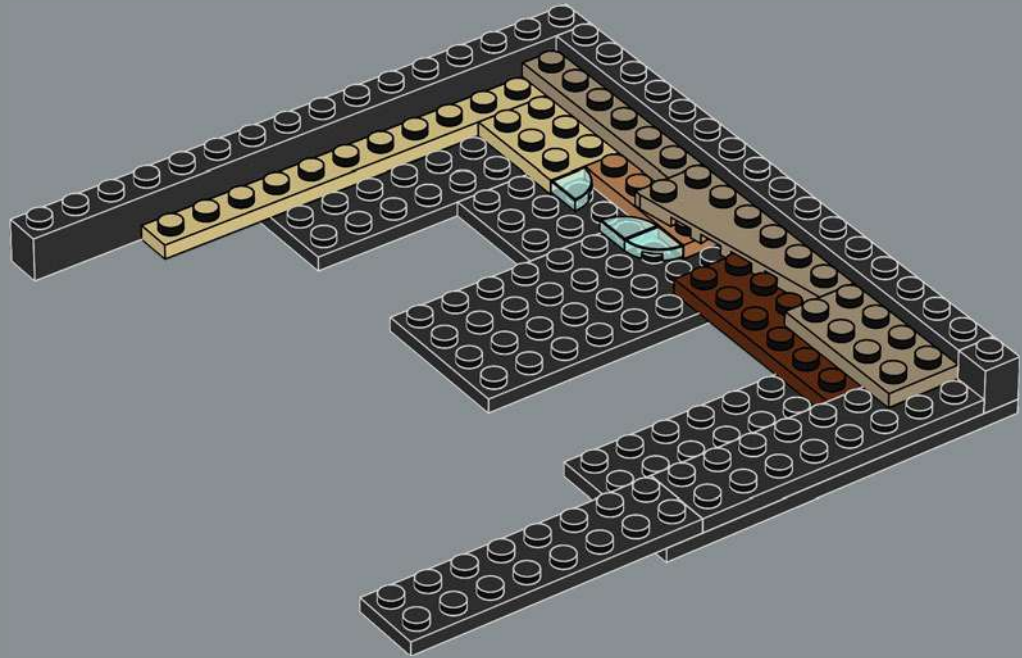

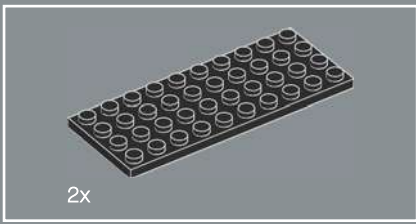

9

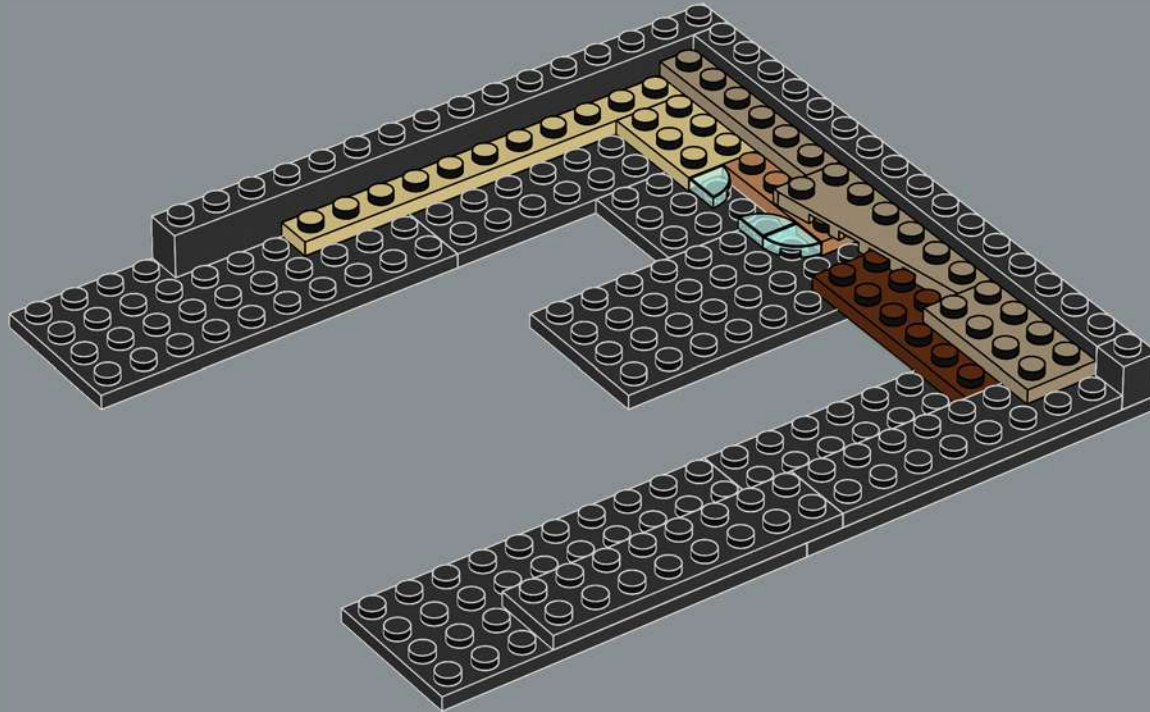

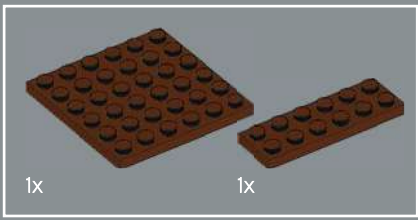

10

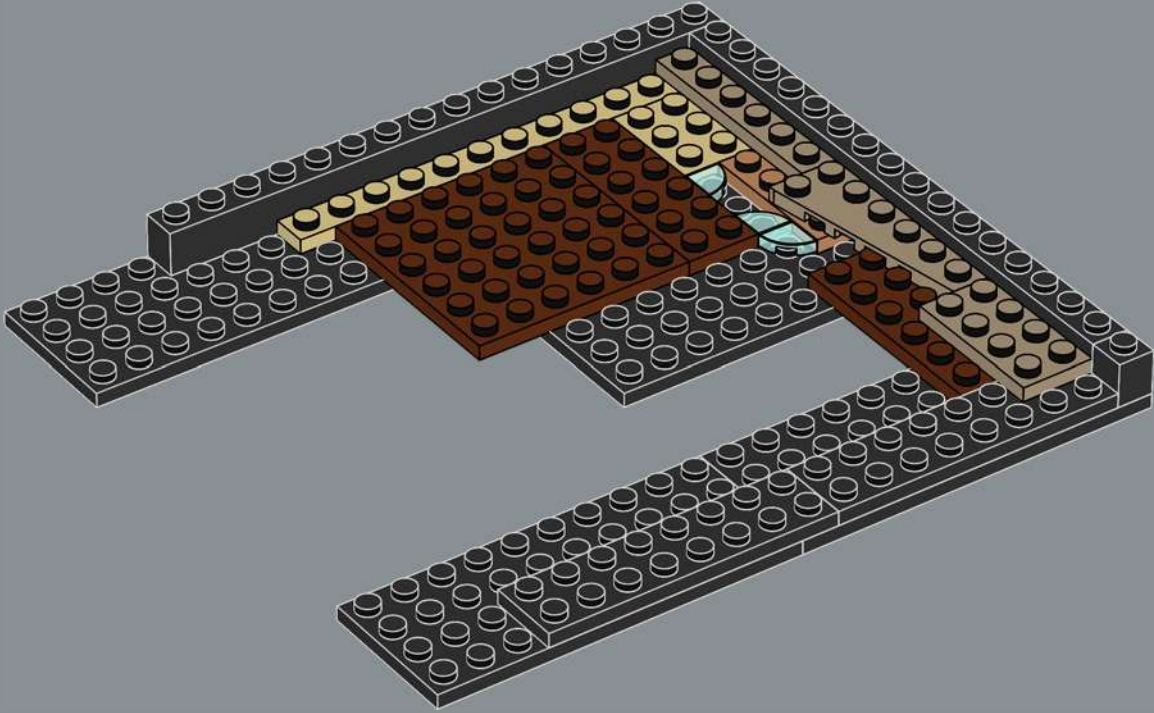

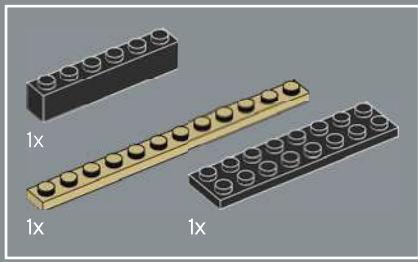

11

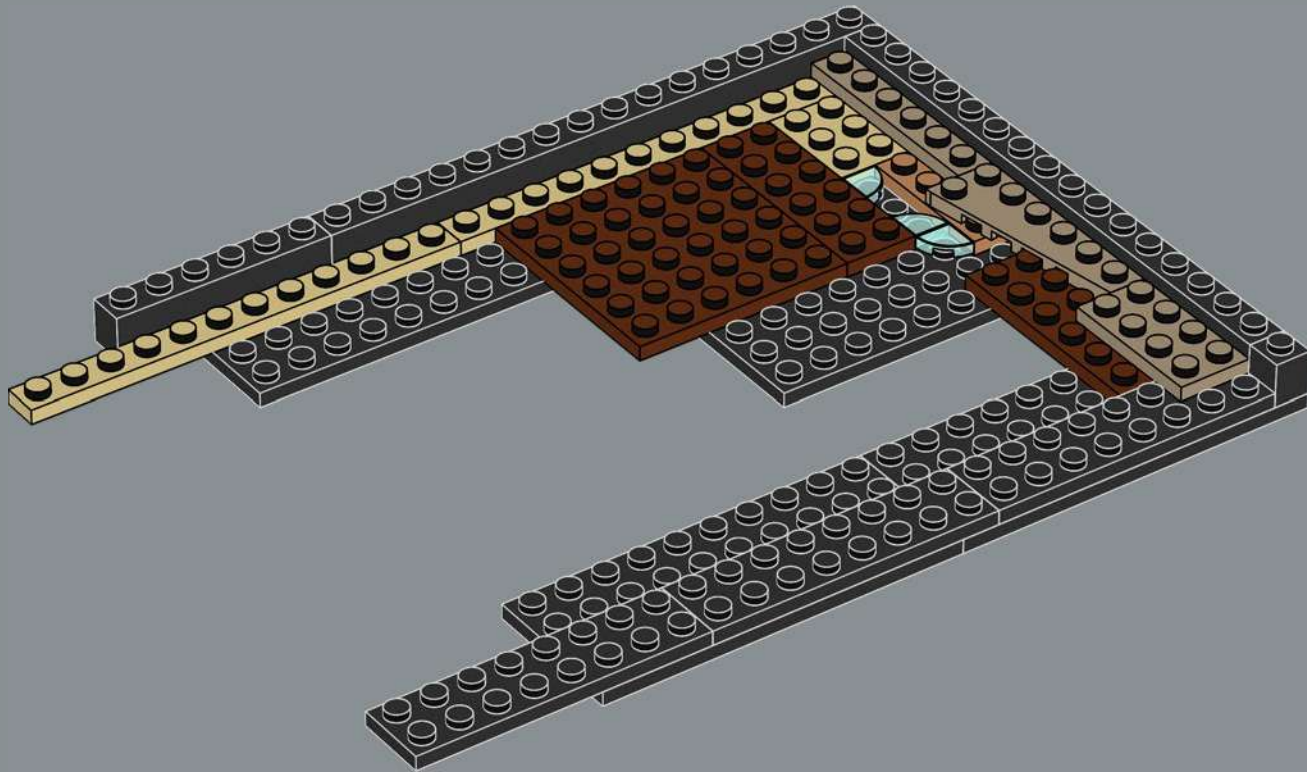

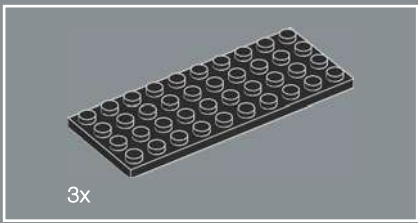

12

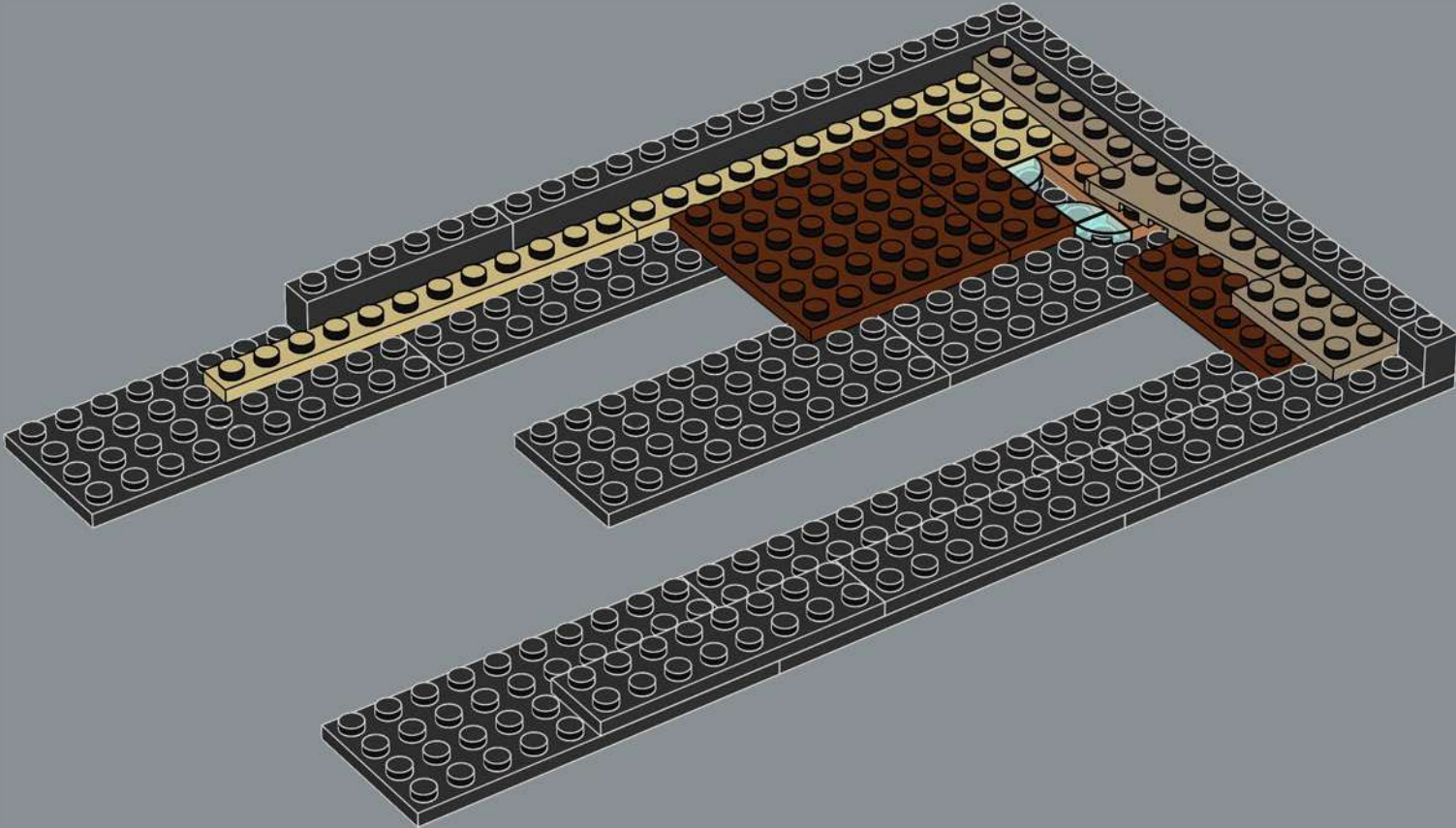

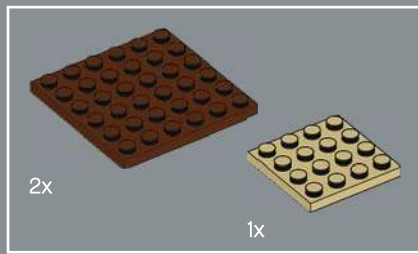

13

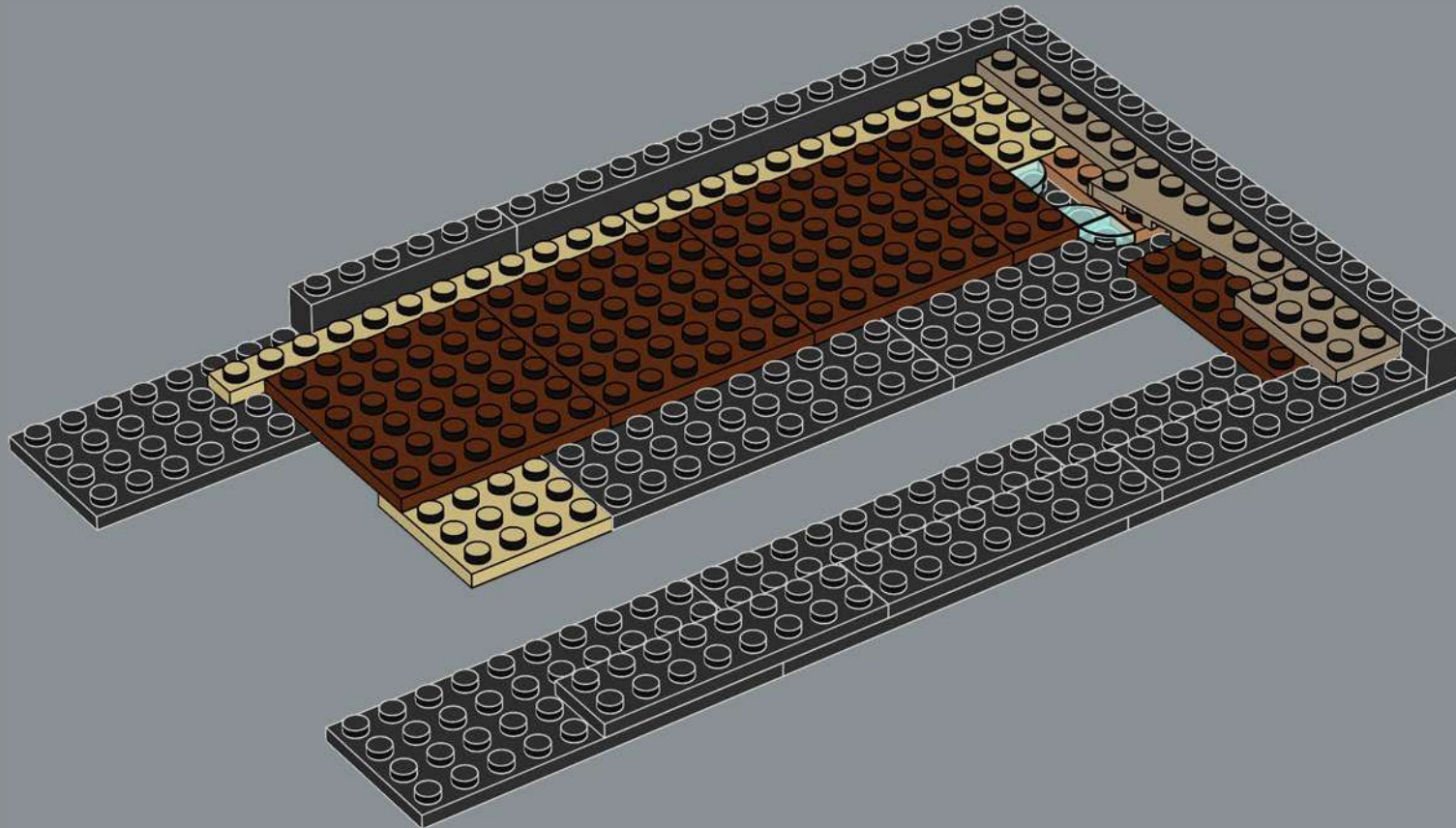

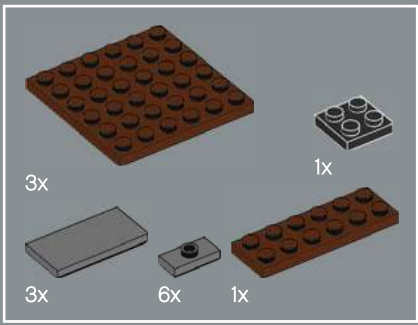

14

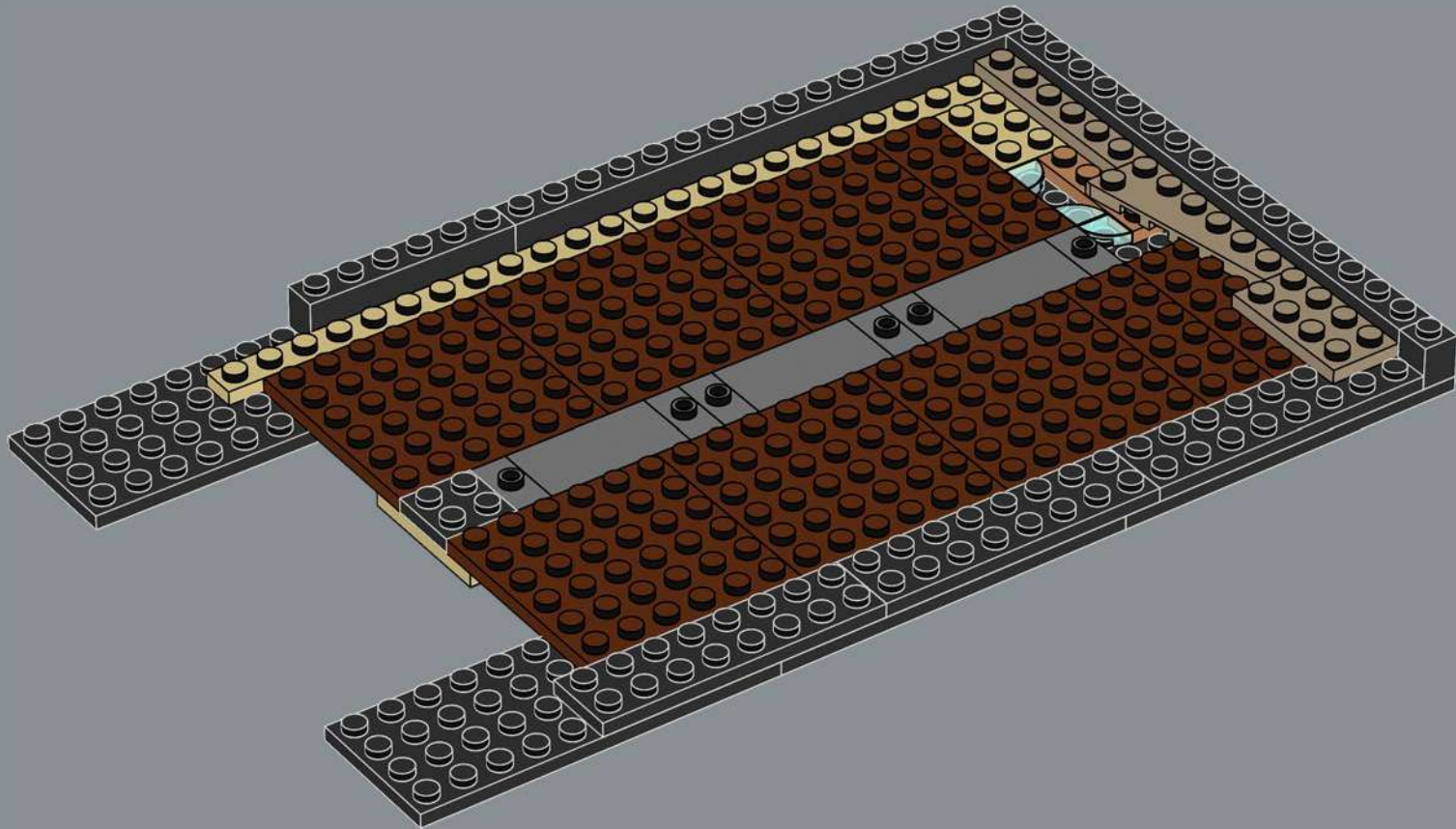

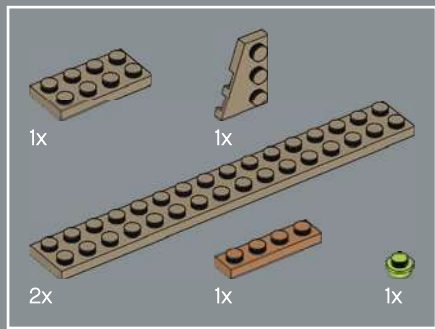

15

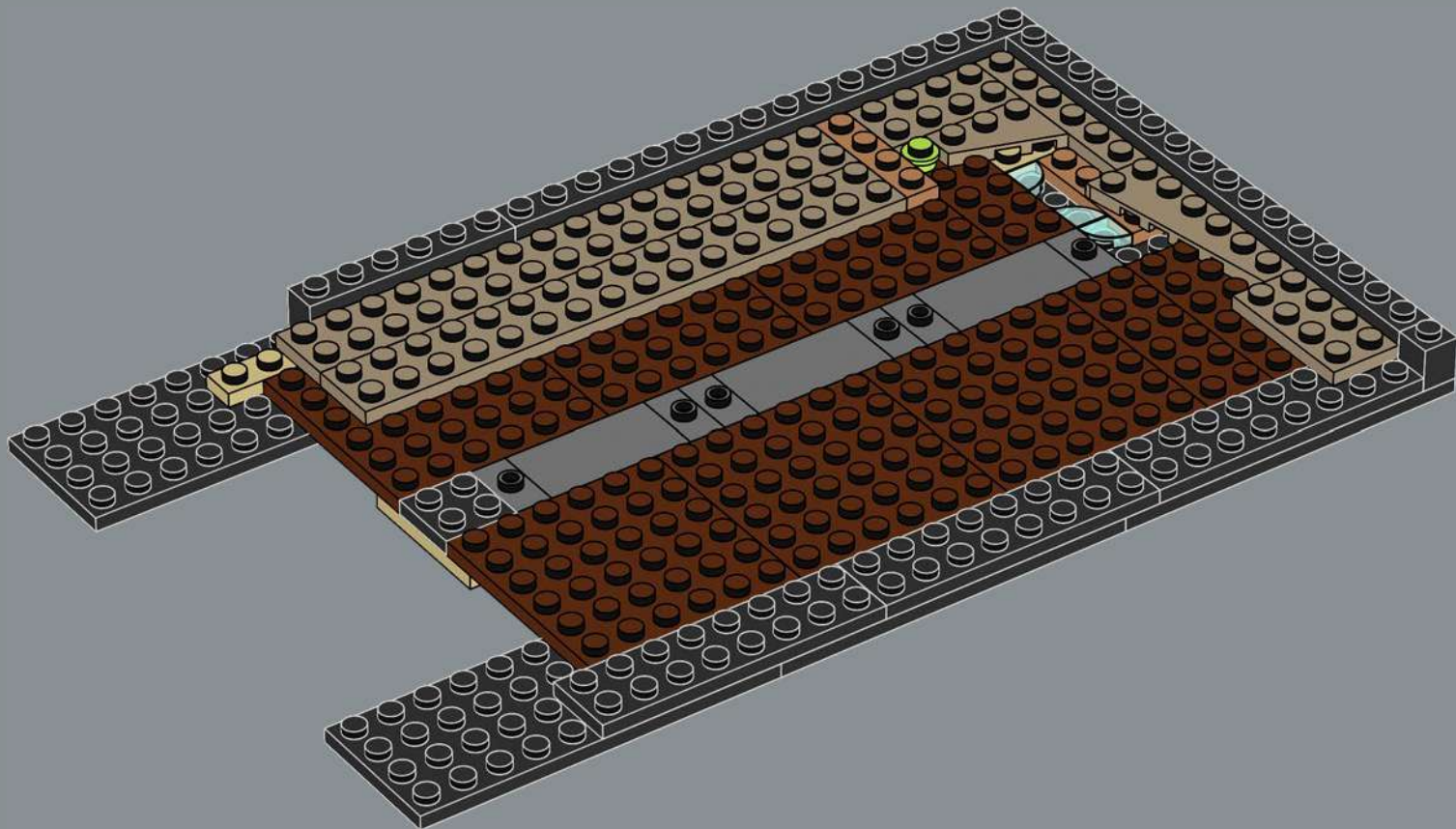

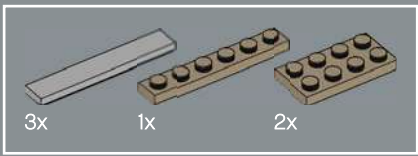

16

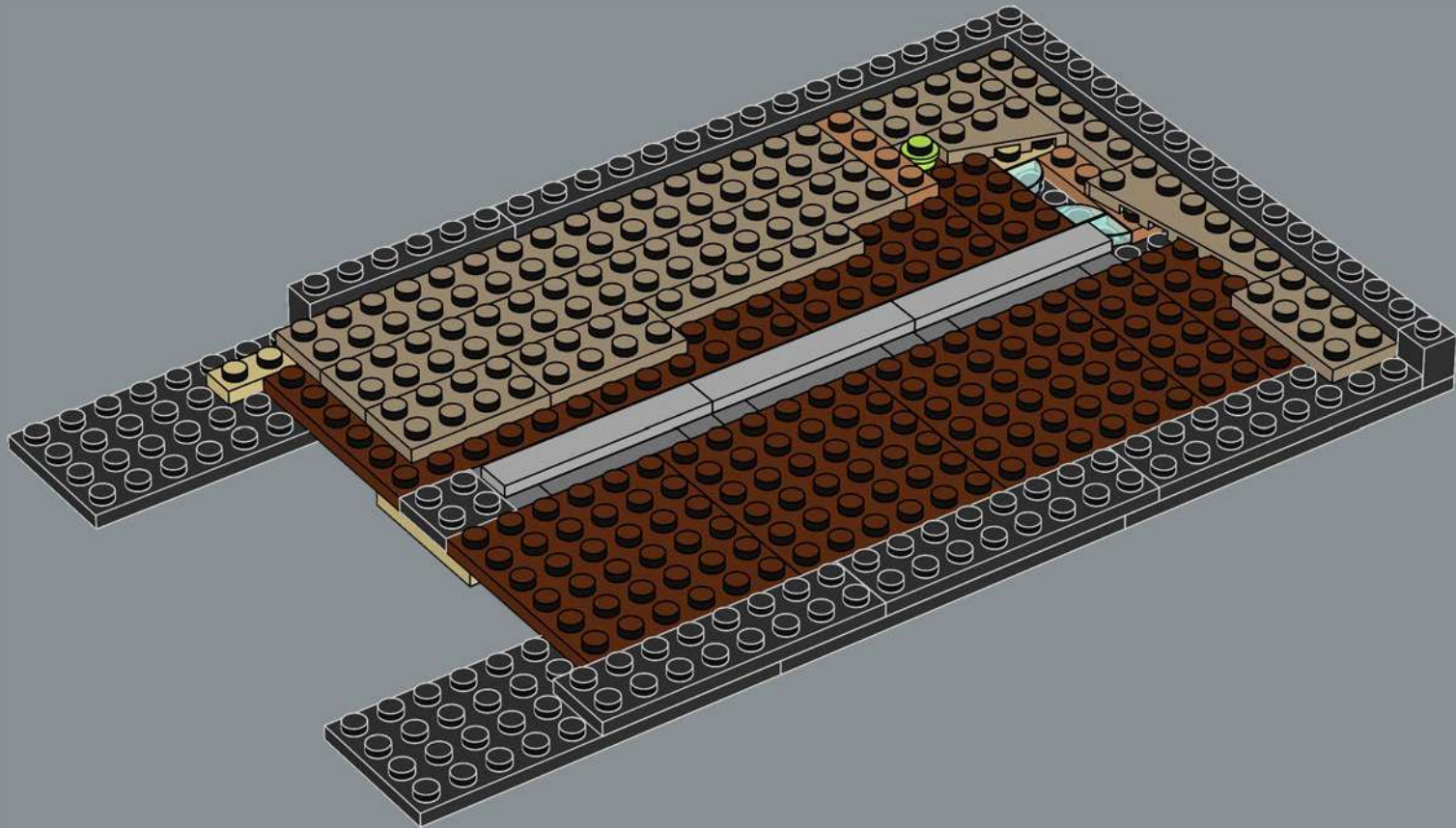

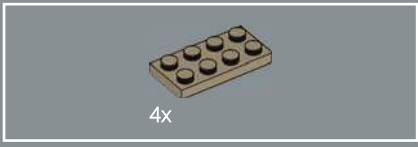

17

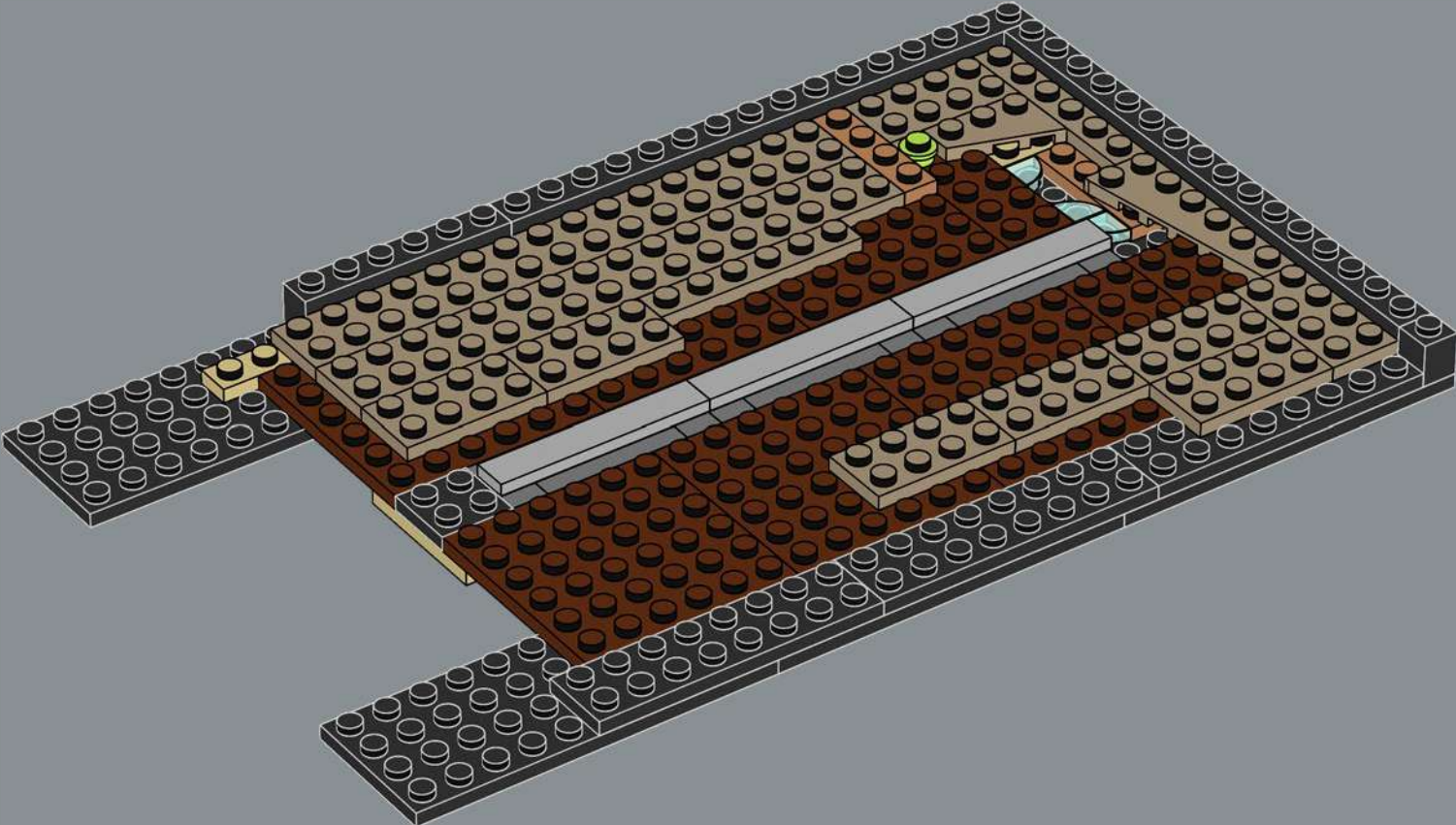

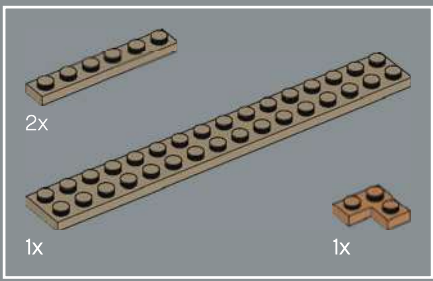

18

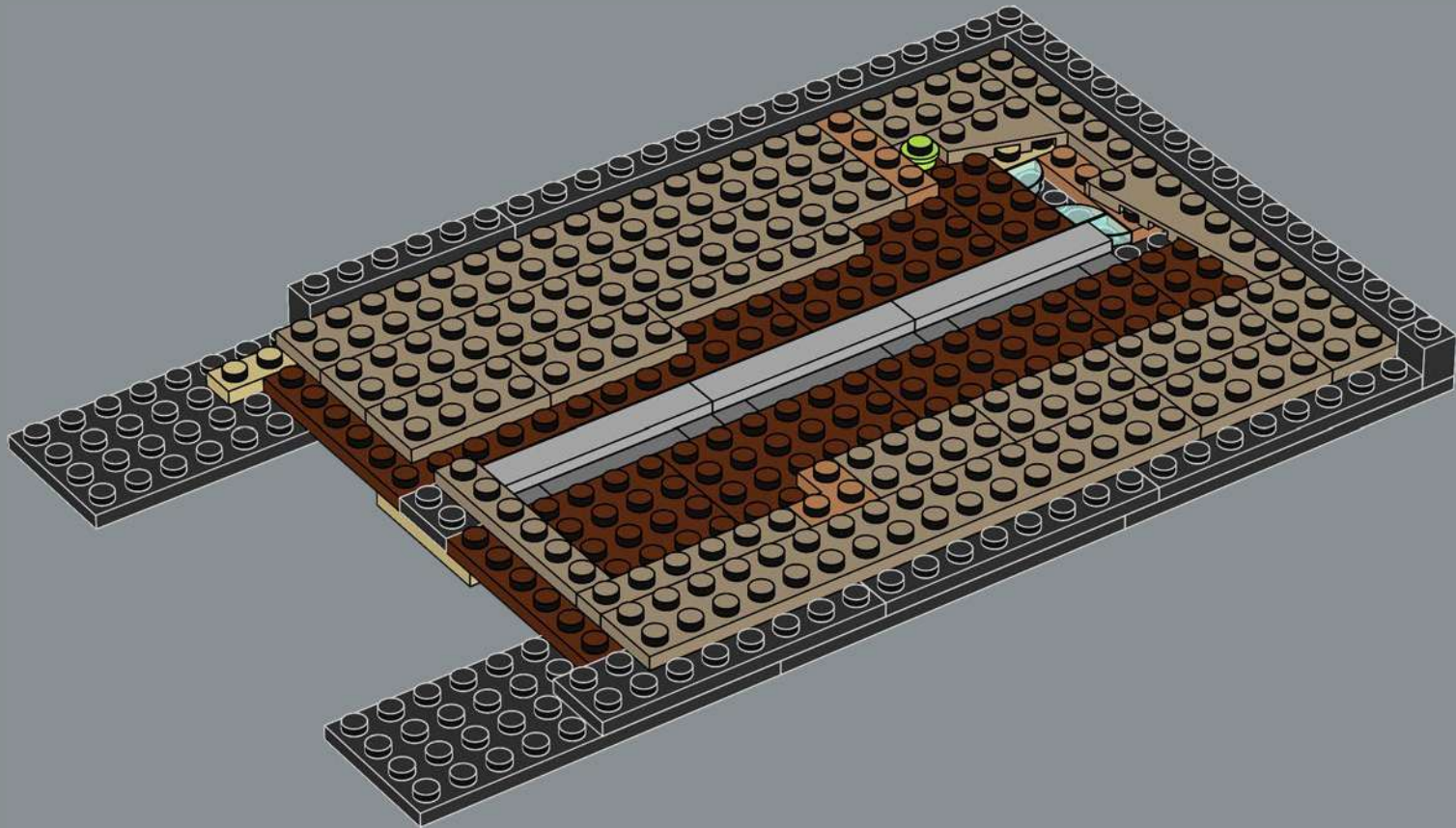

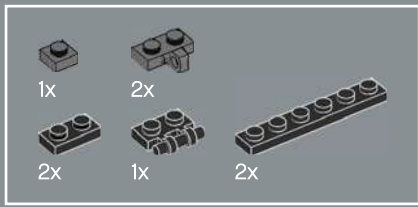

19

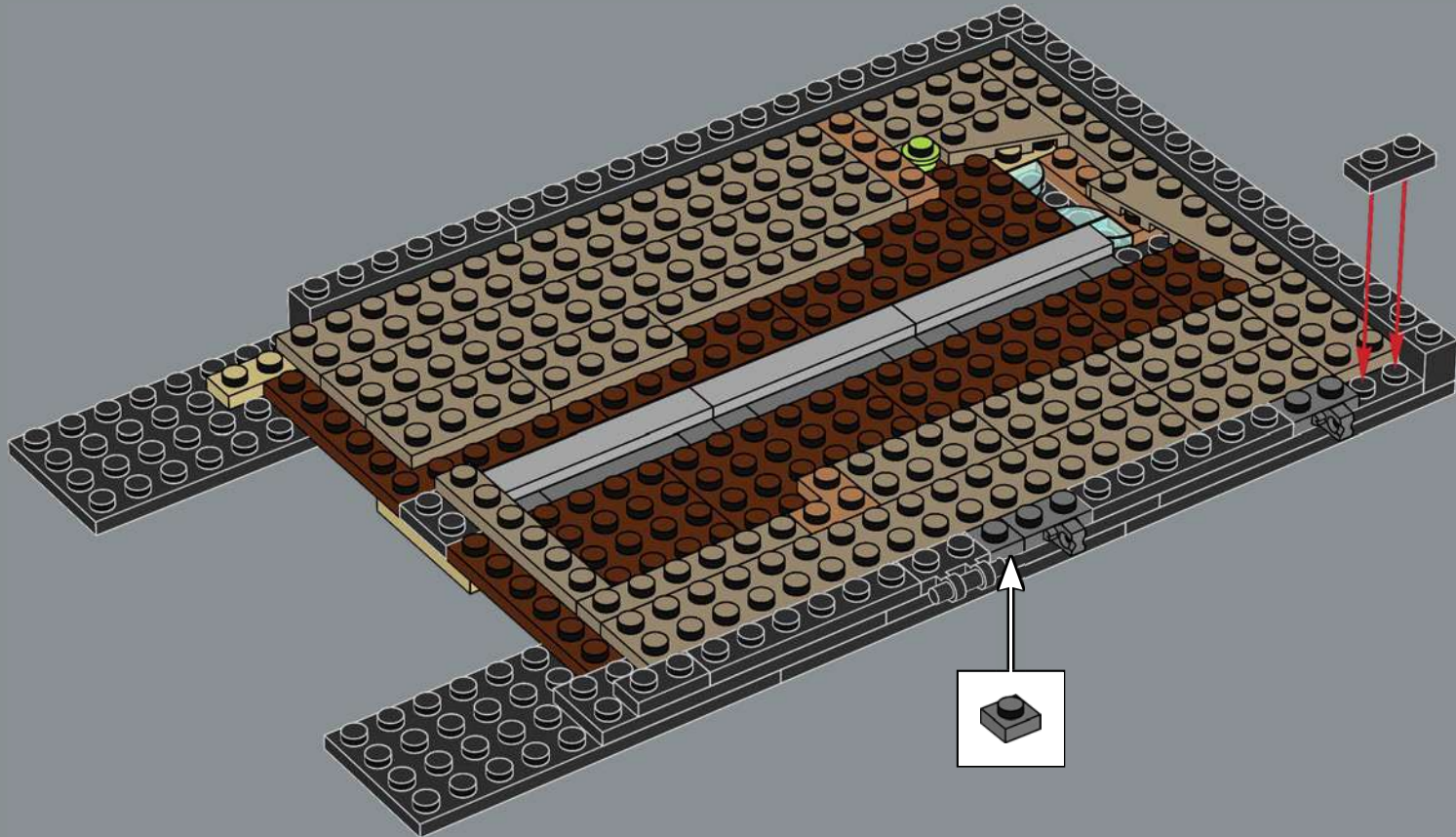

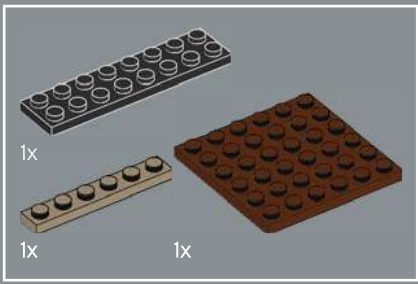

20

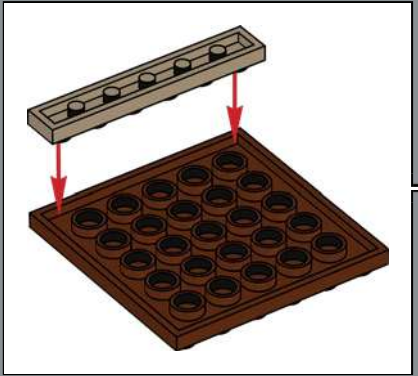
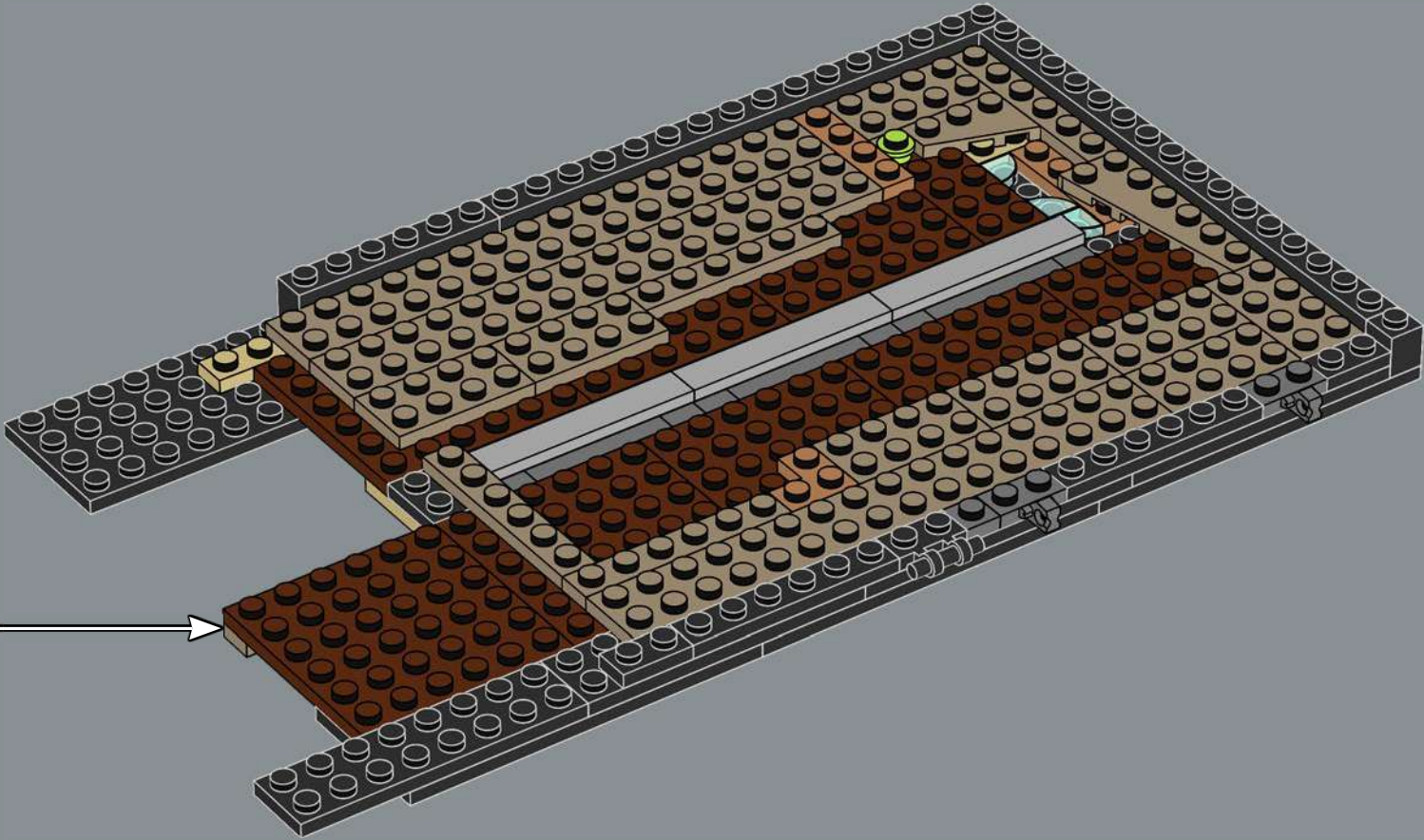

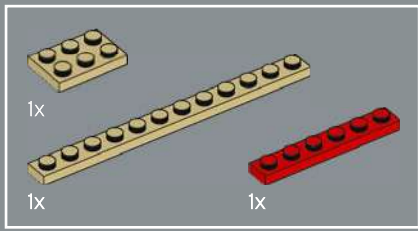

21

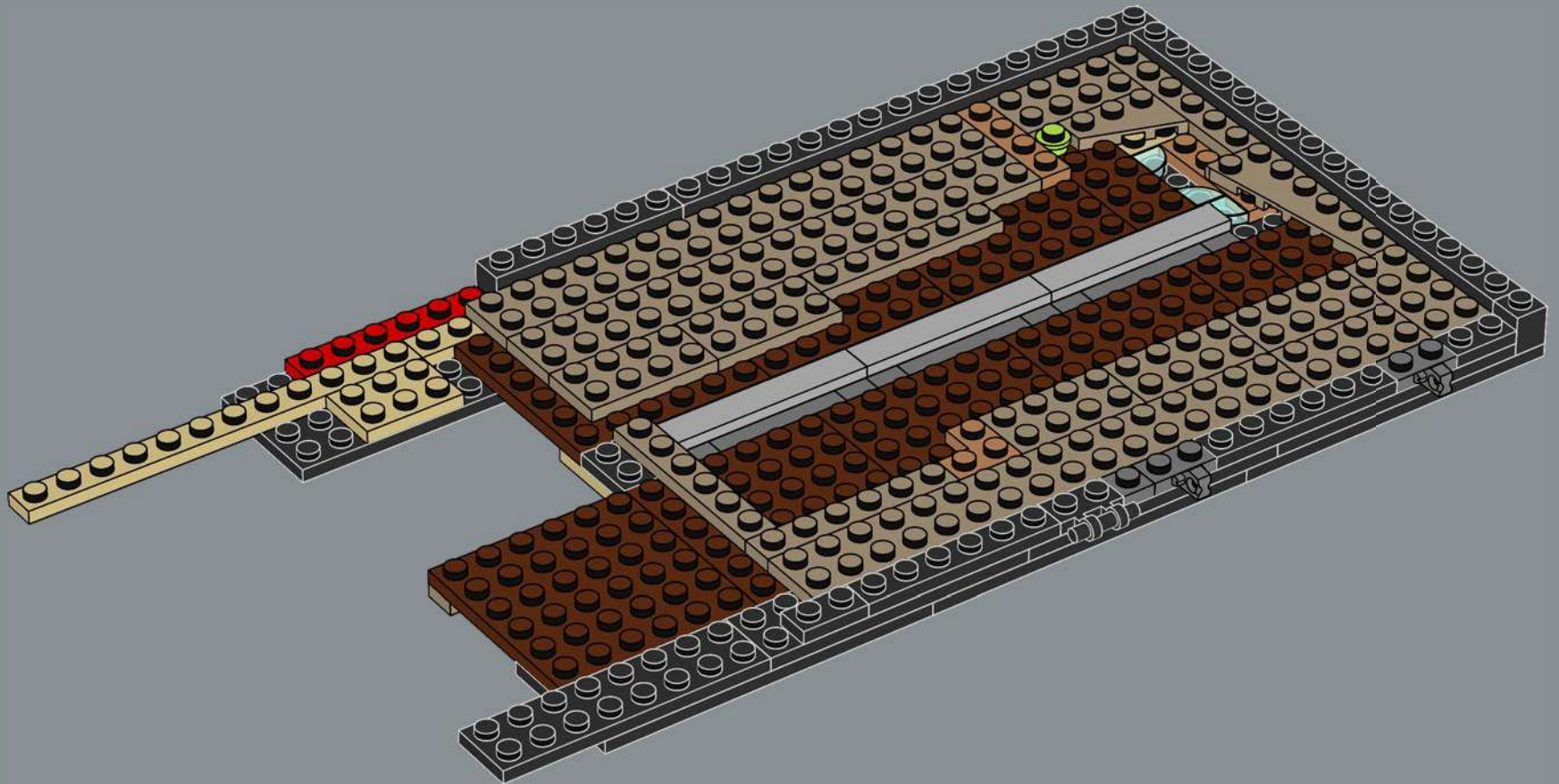

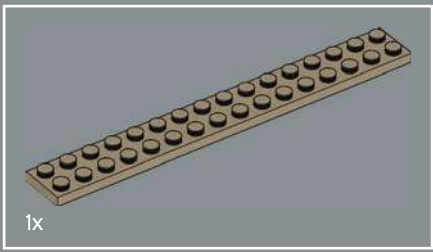

22

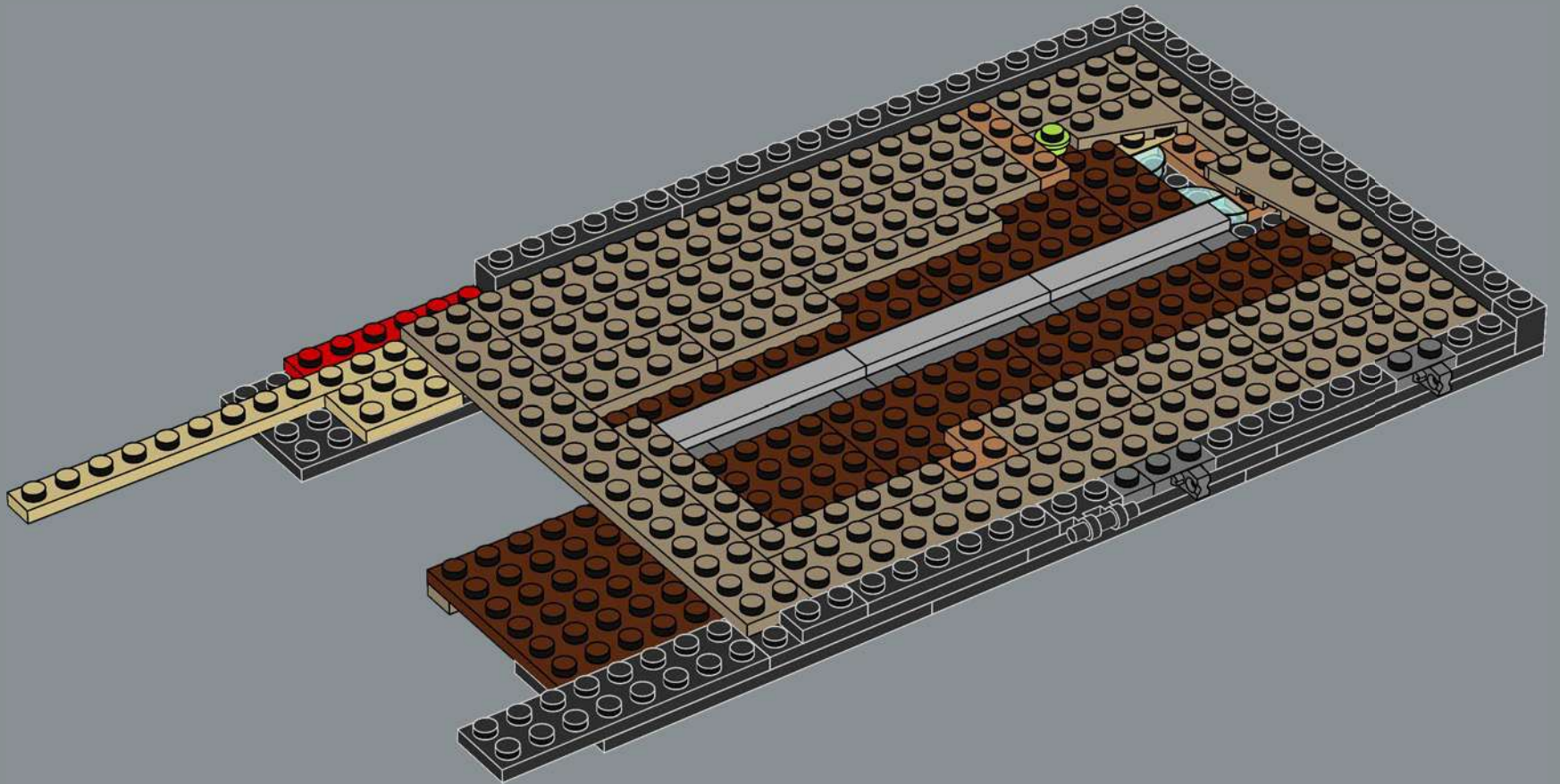

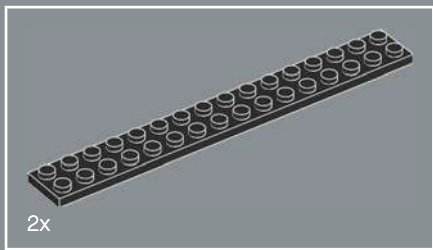

23

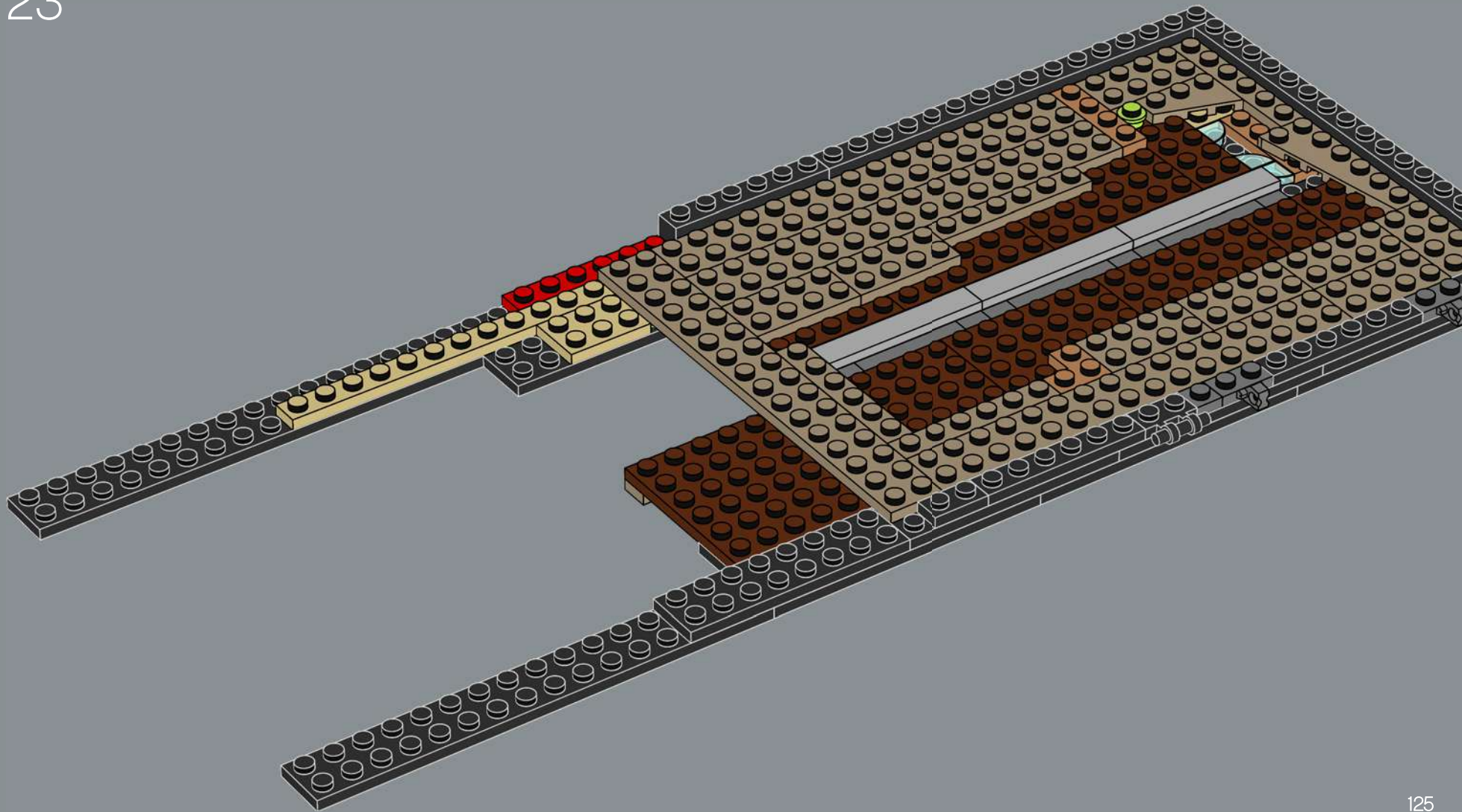

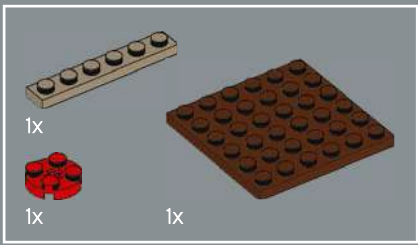

24

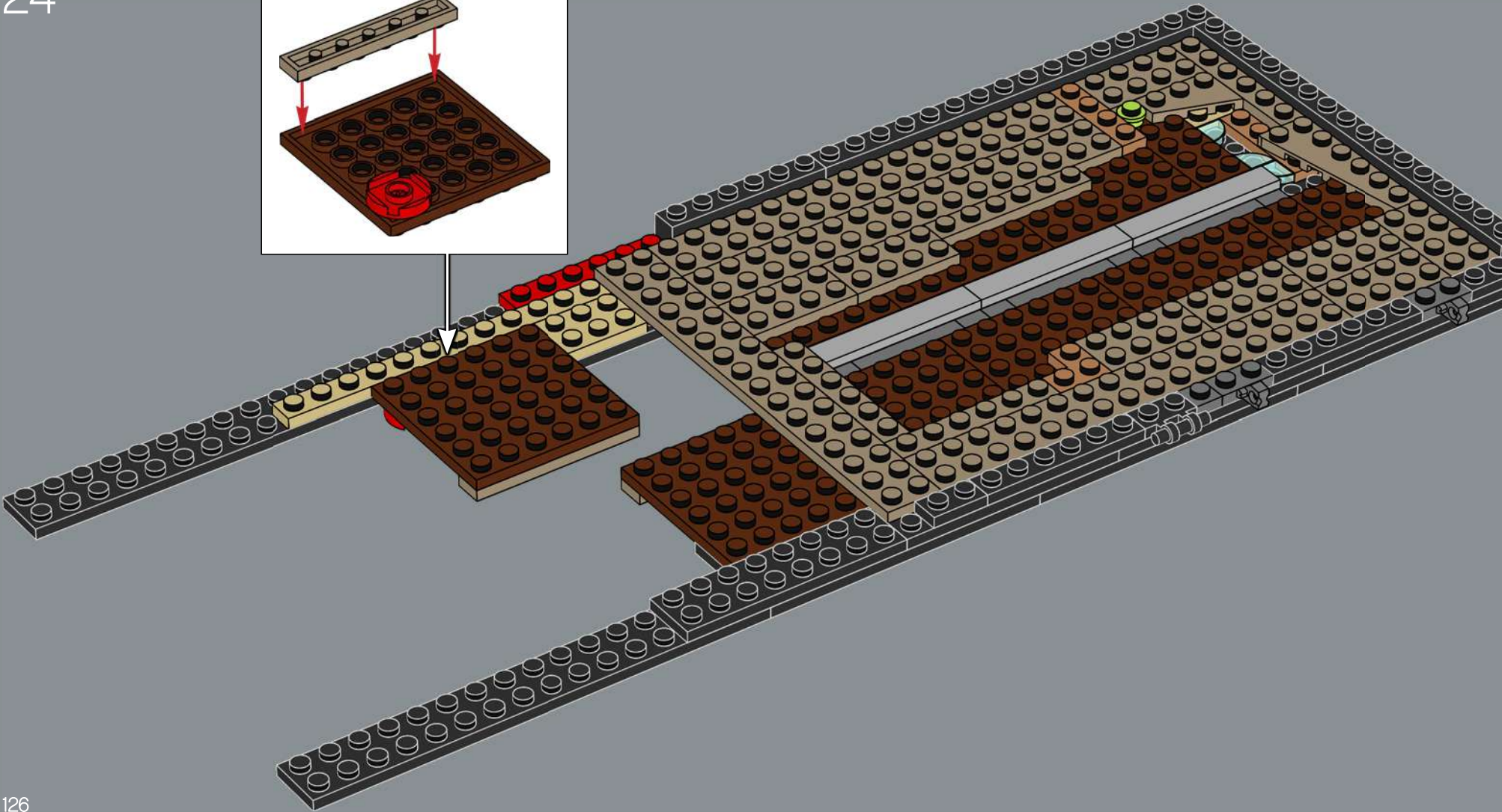
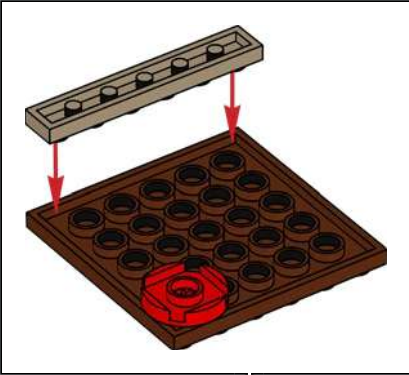

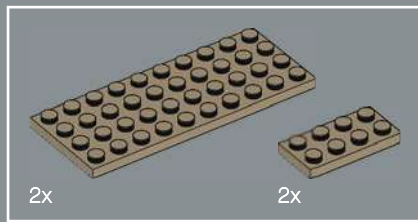

25

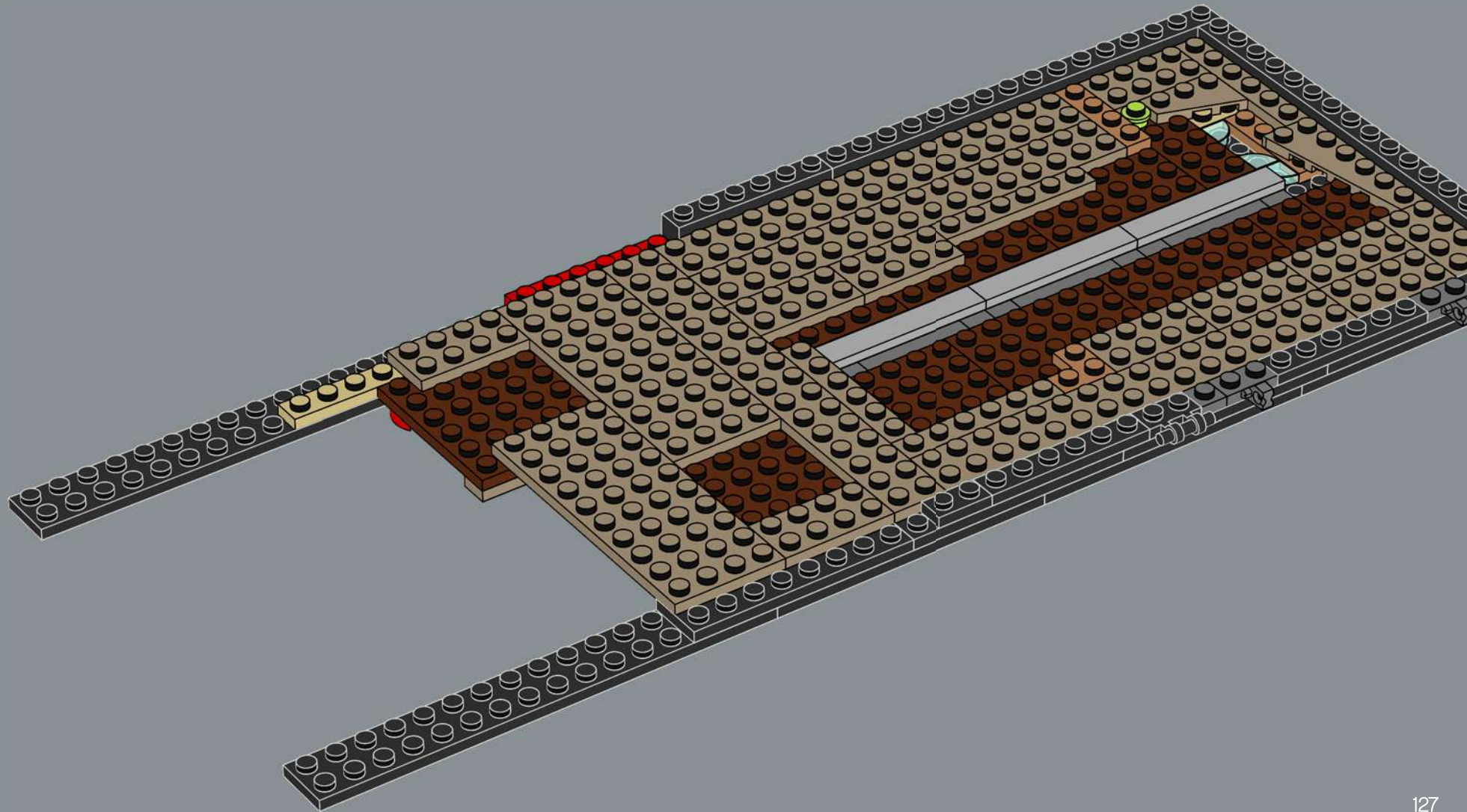

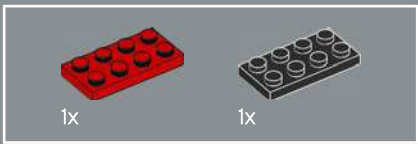

26

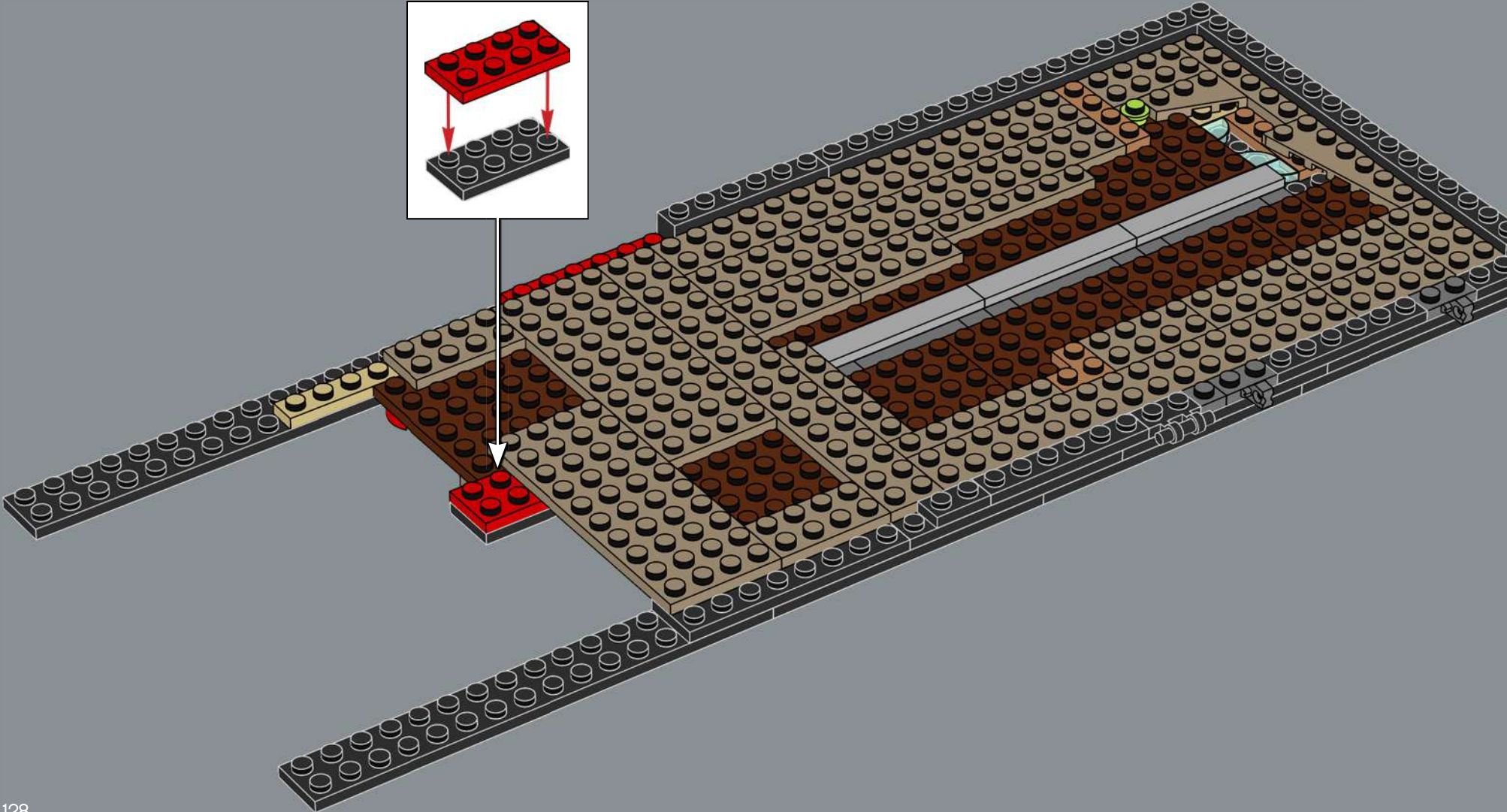
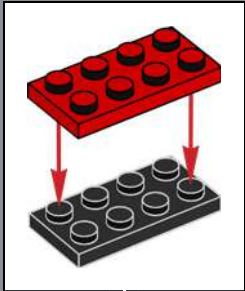

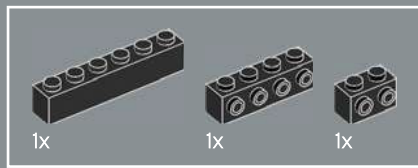

27

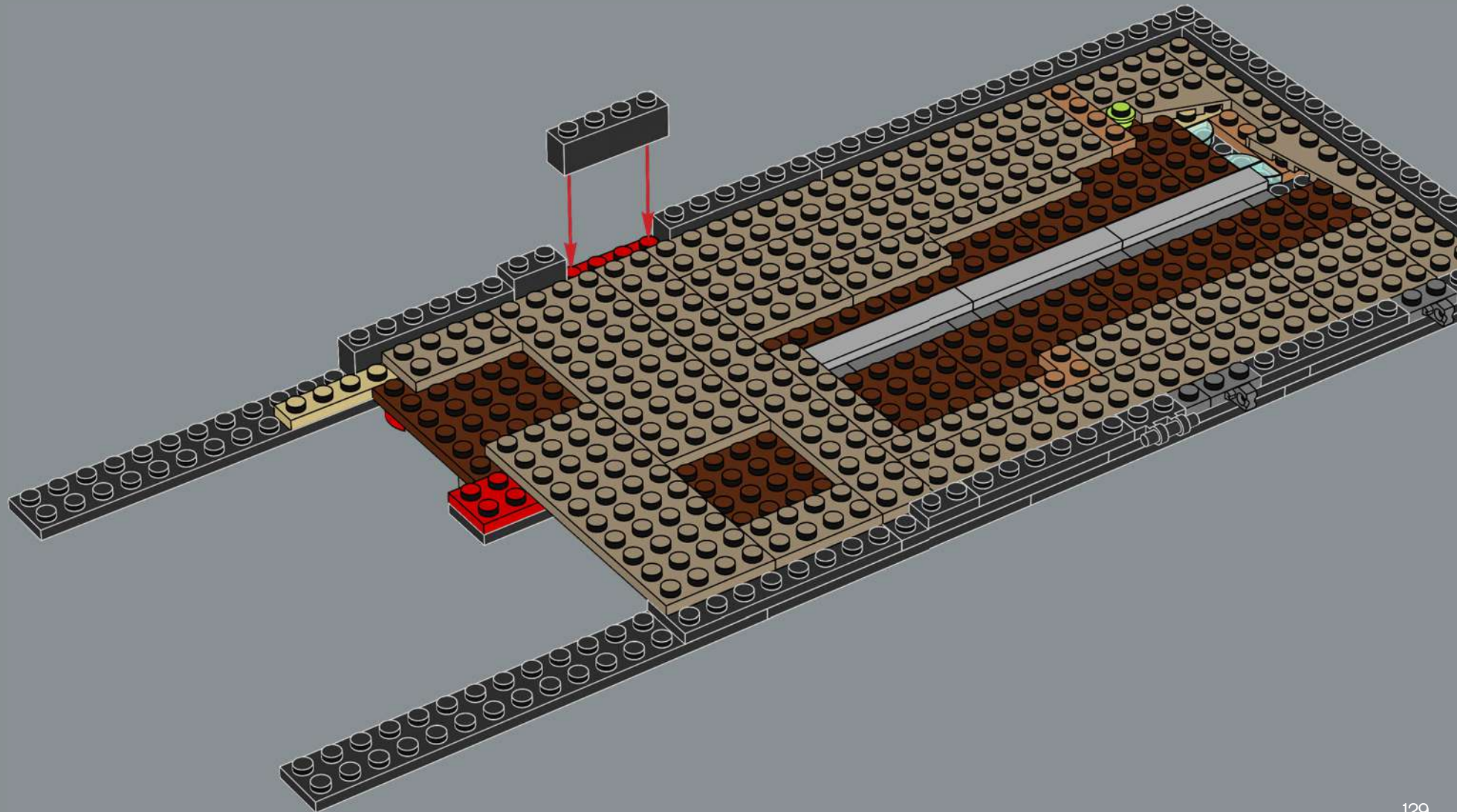

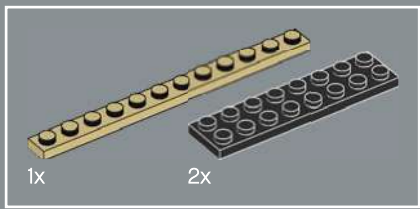

28

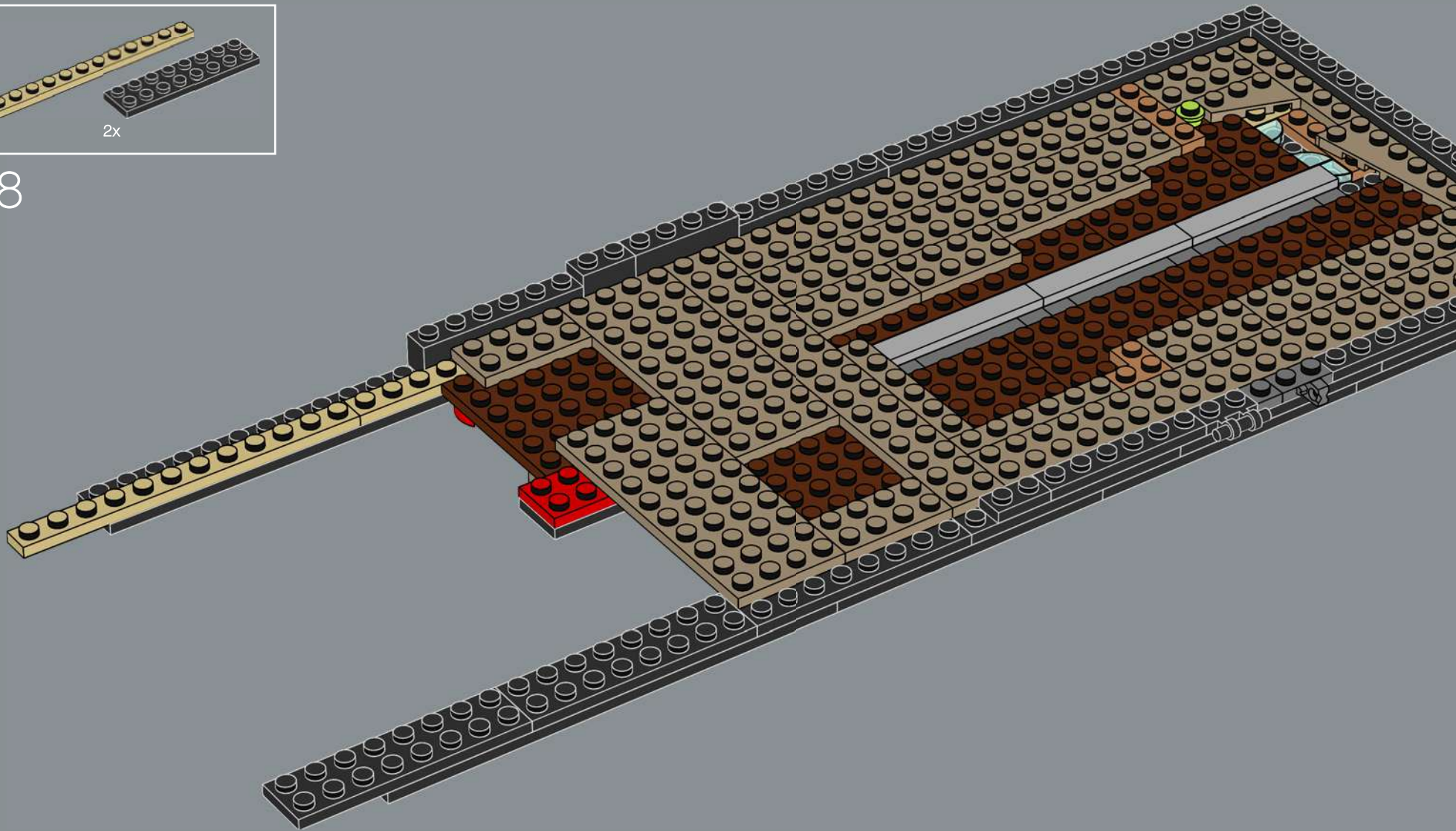

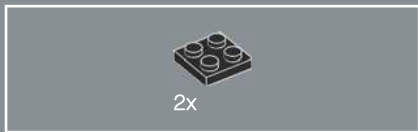

29

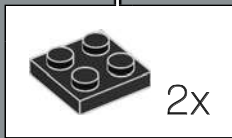
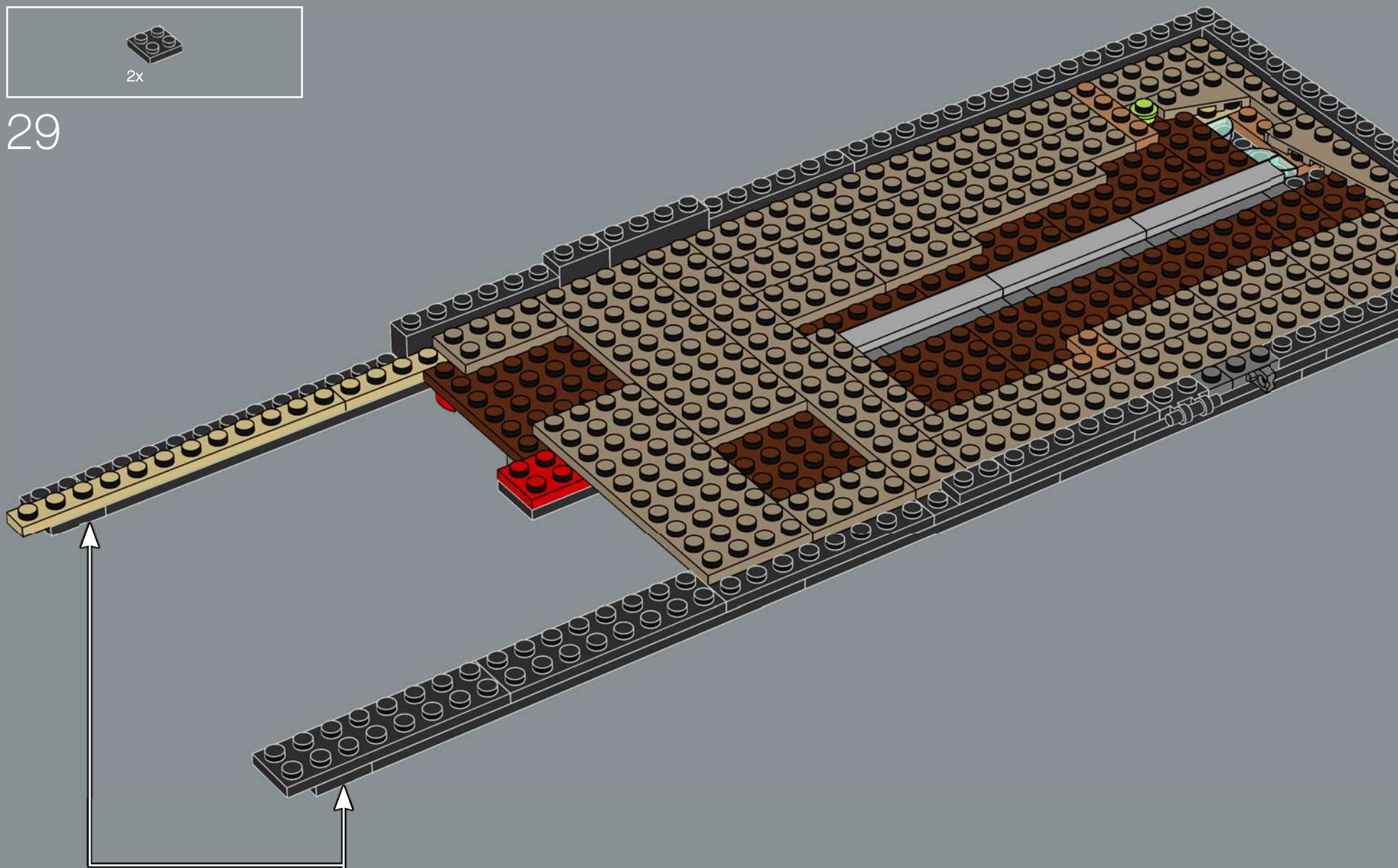

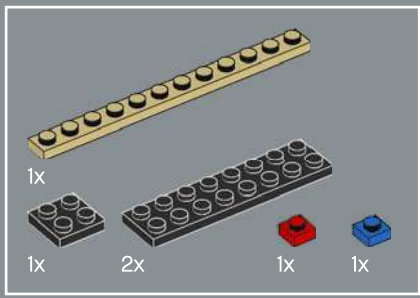

30

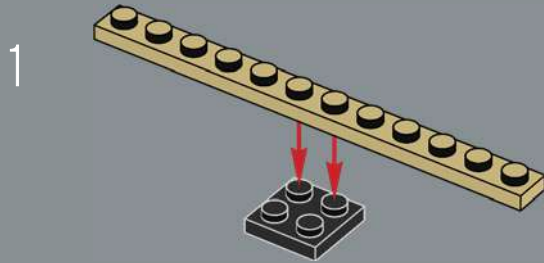

2

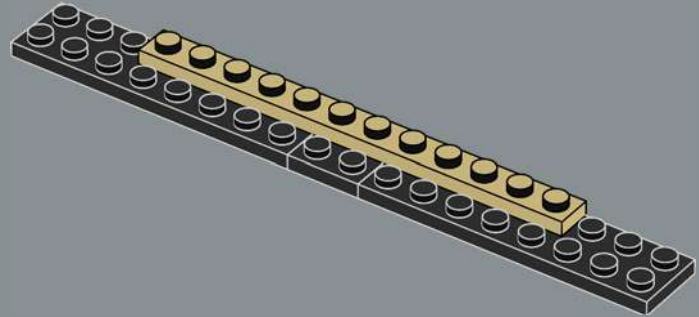

3

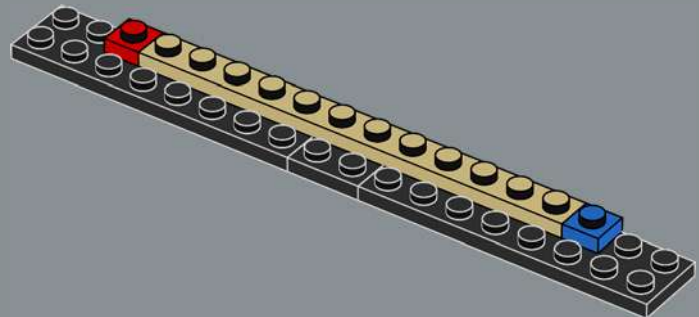

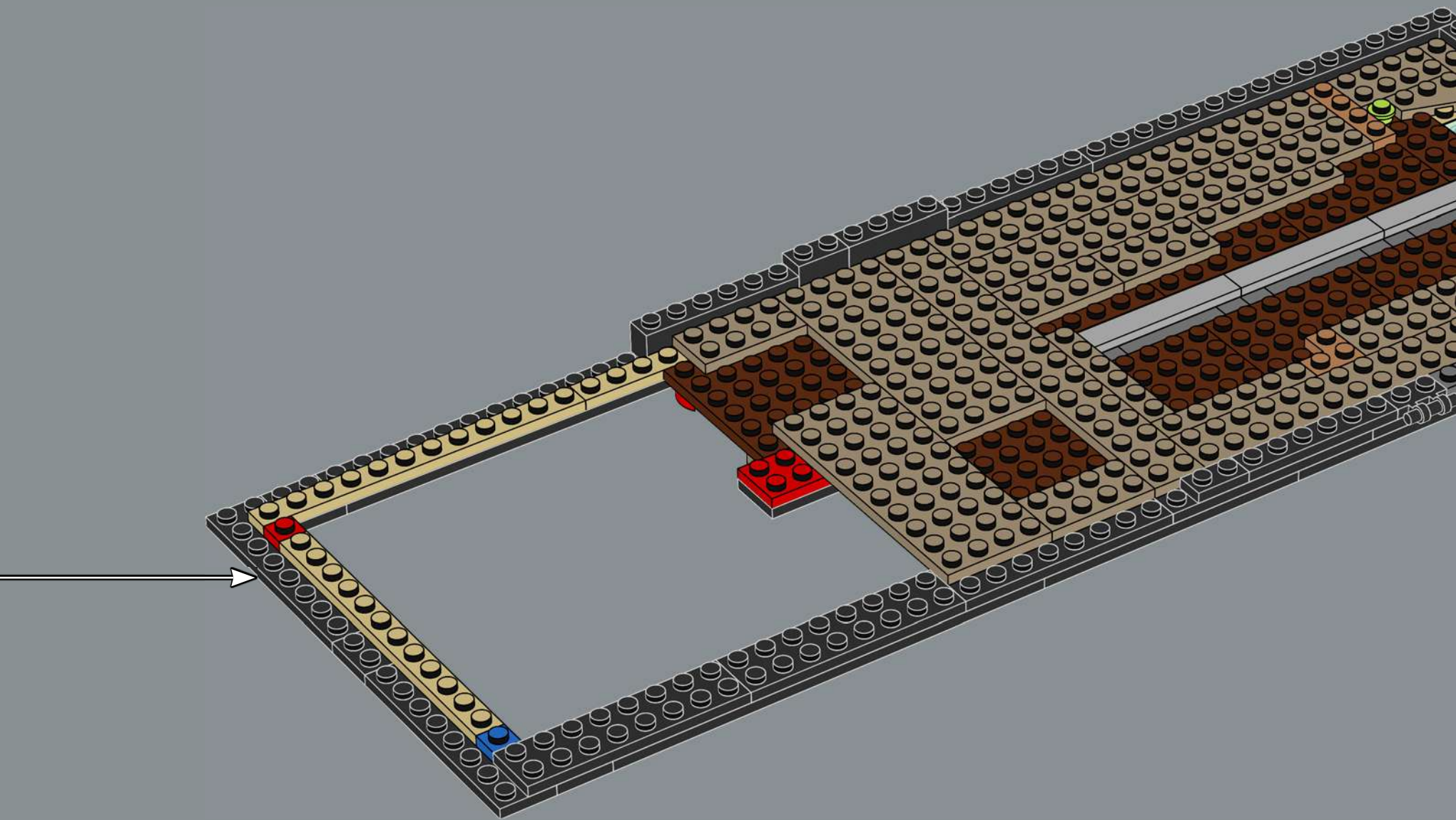

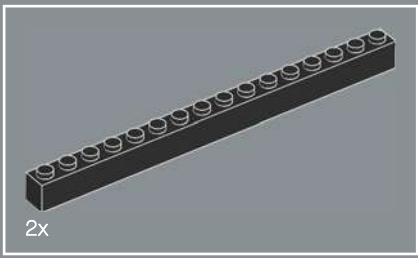

31

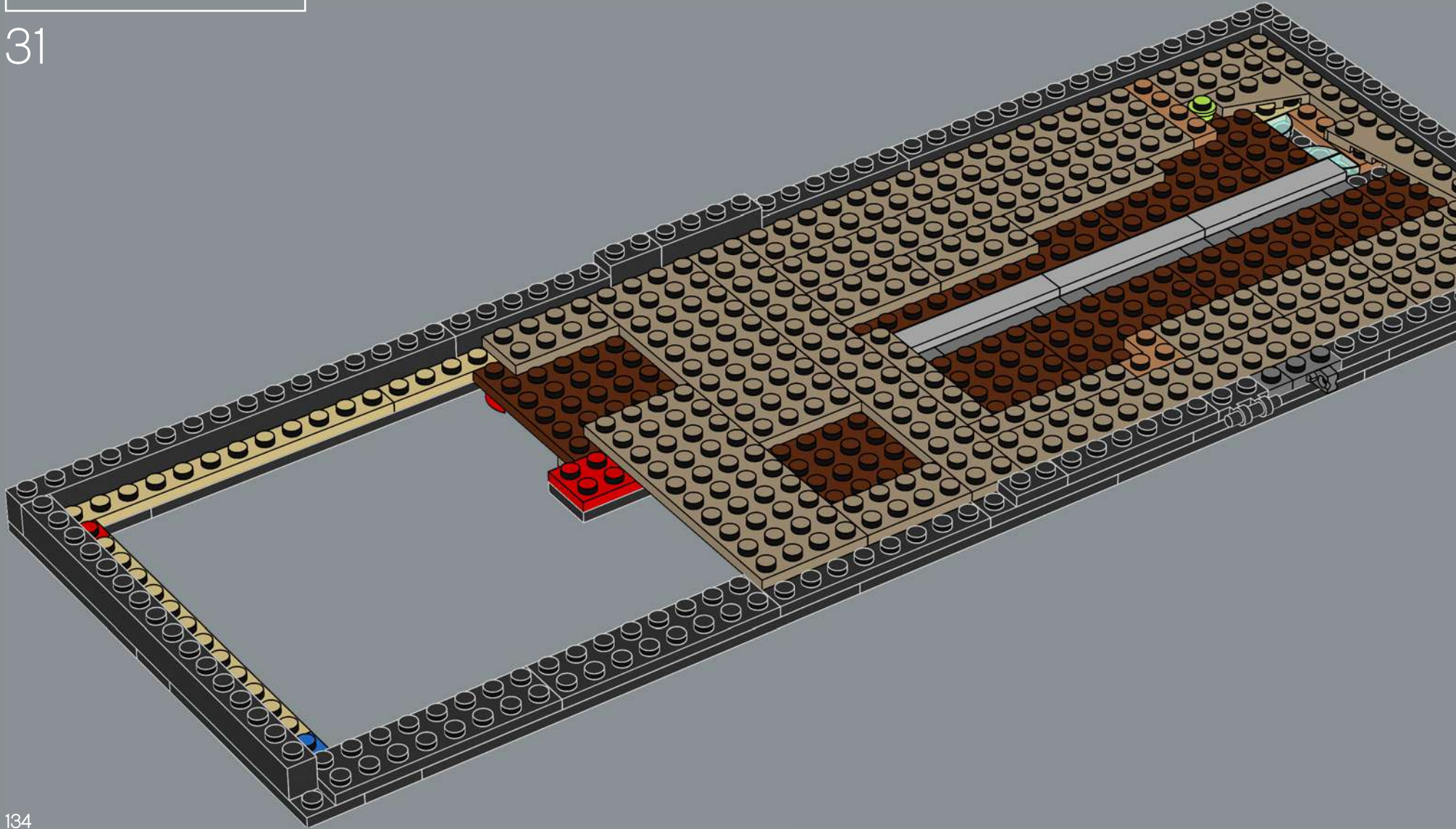

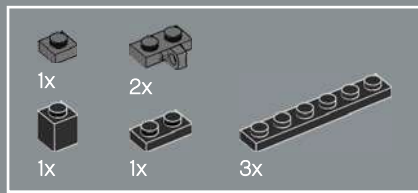

32

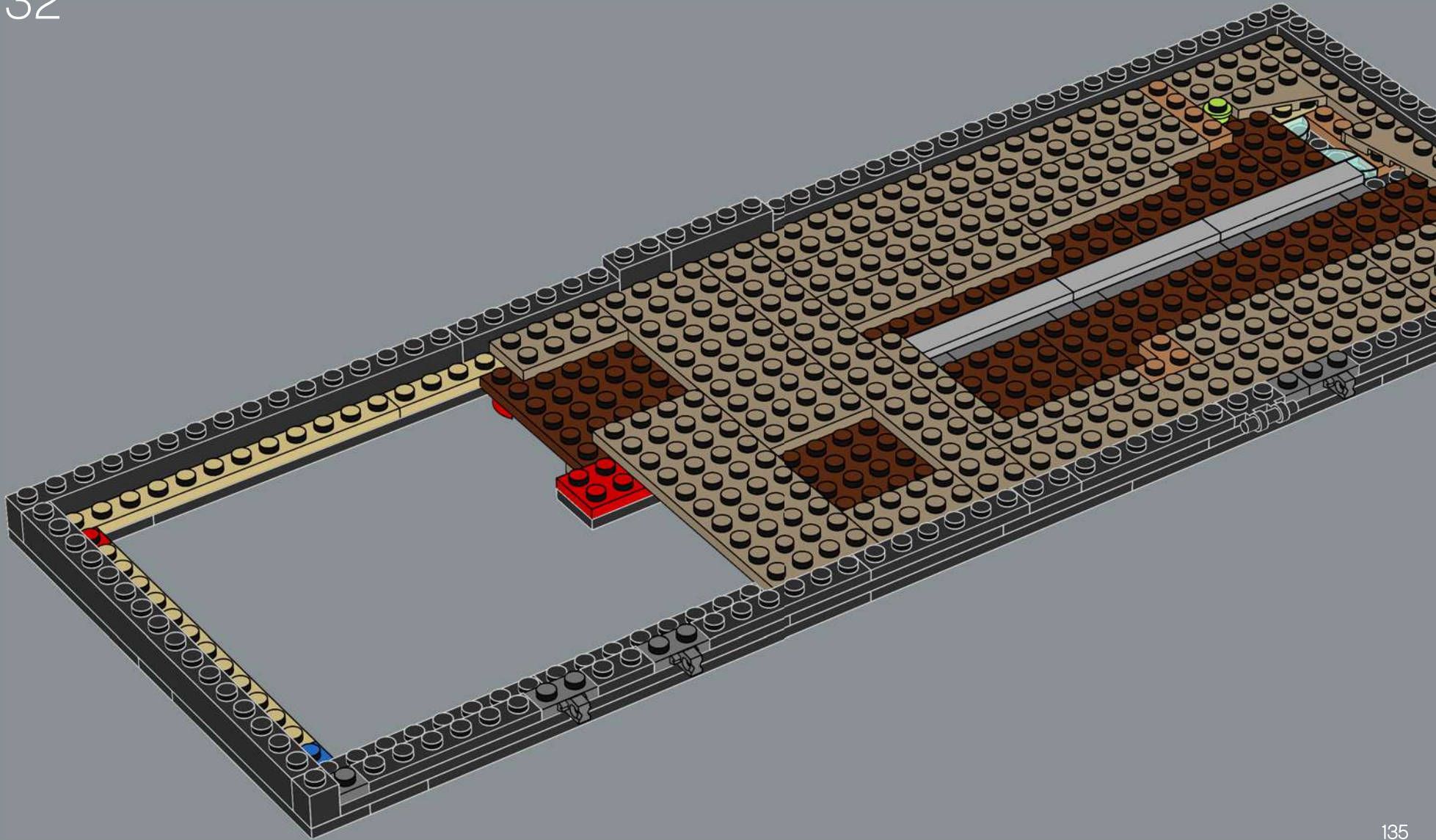

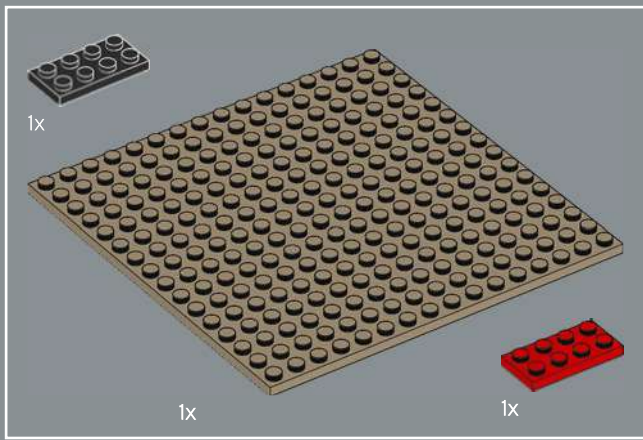

33

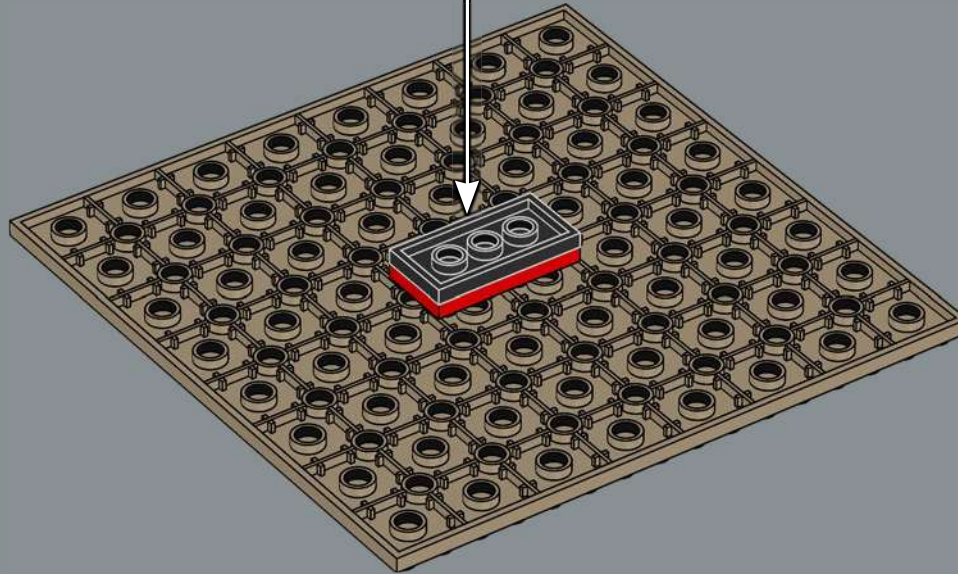
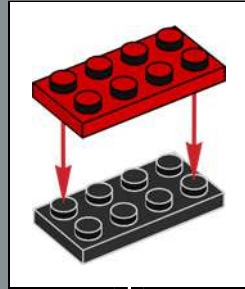

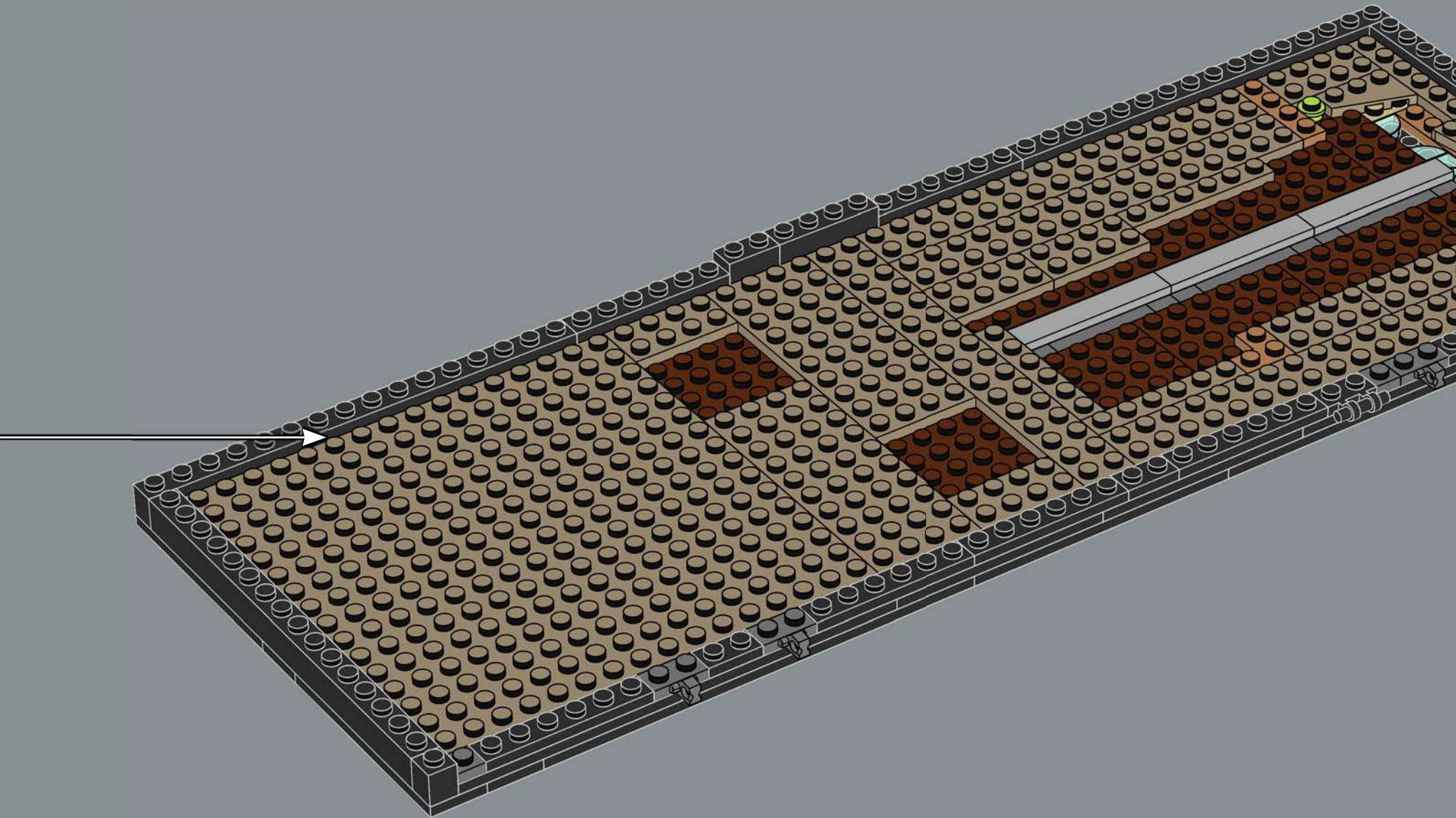

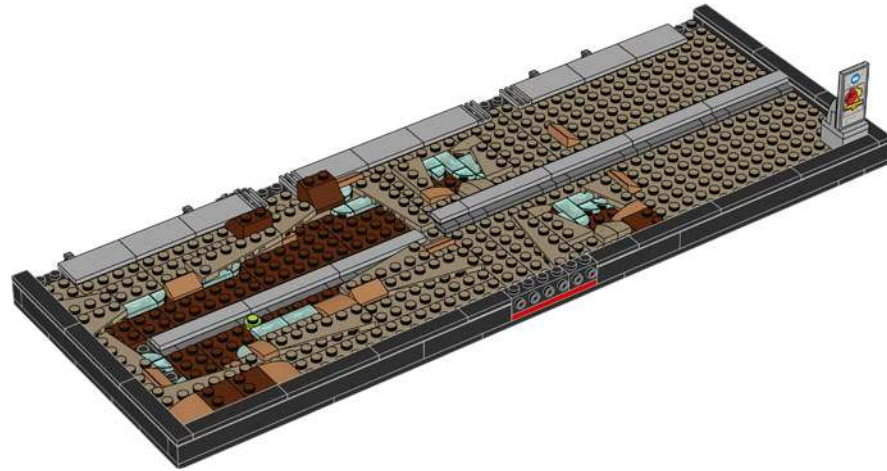
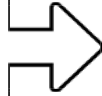

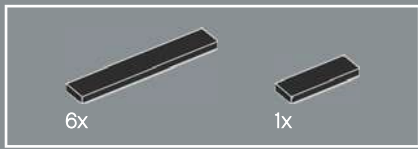

34

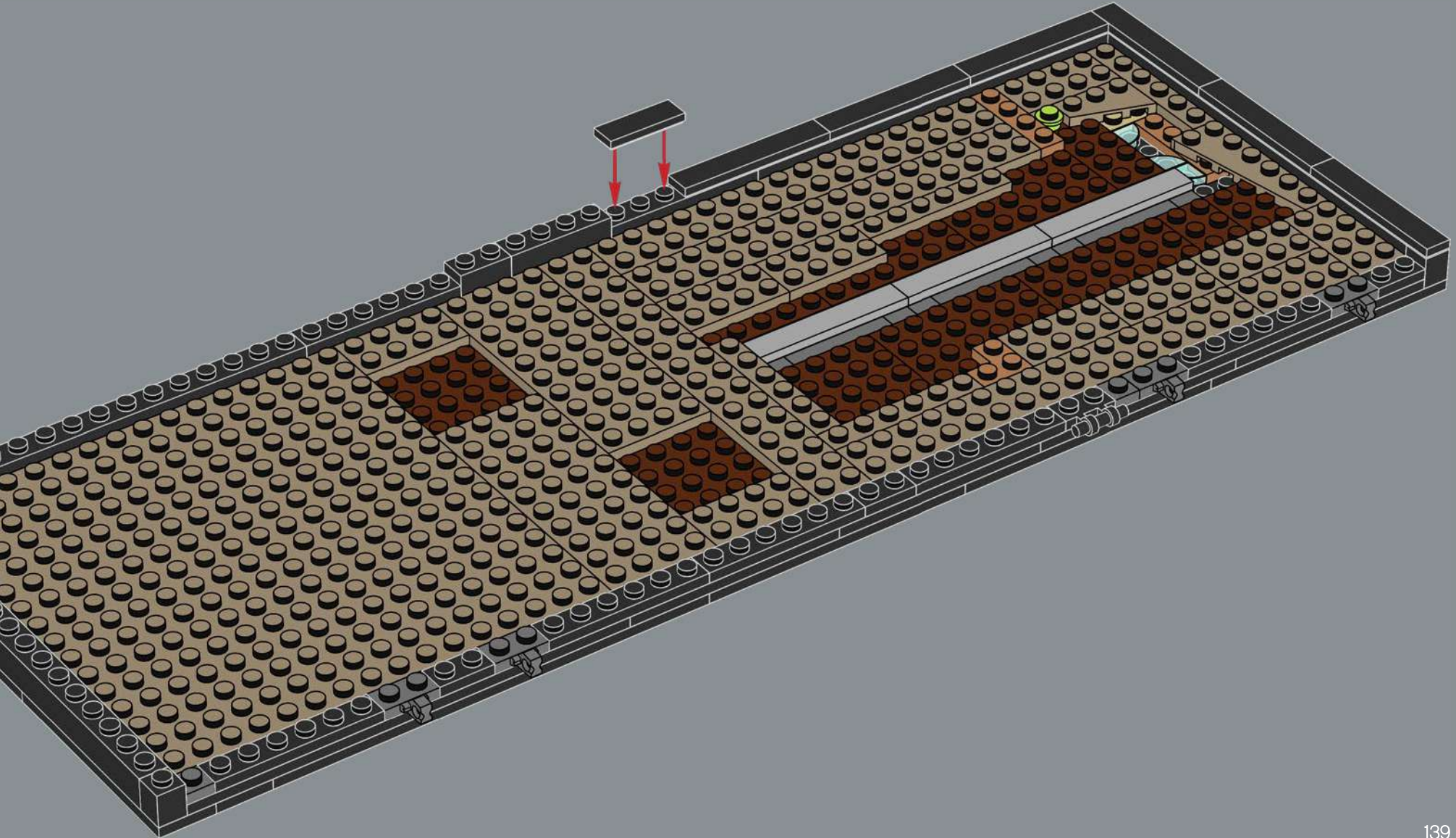

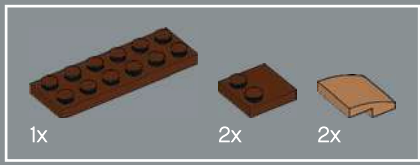

35

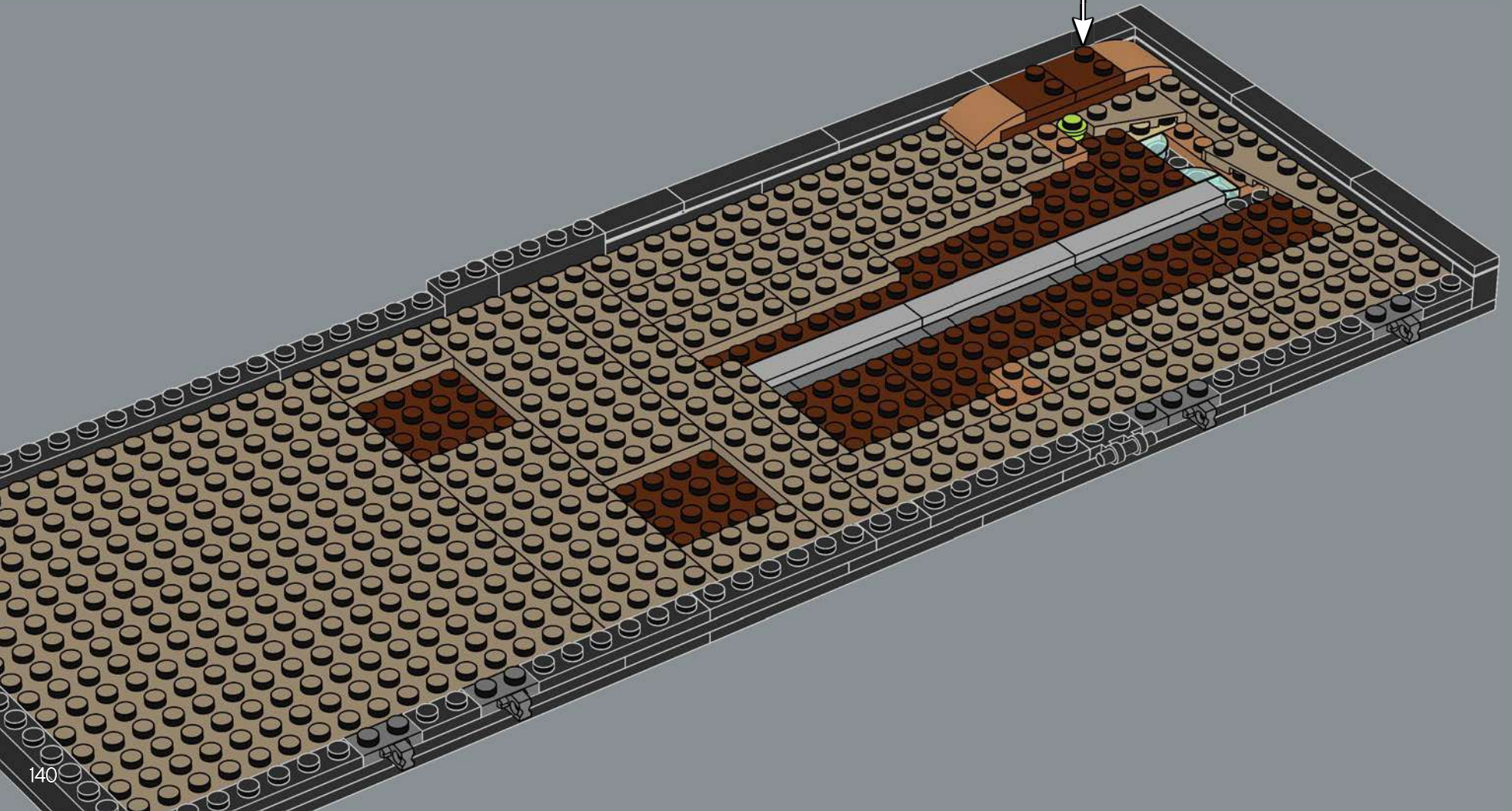
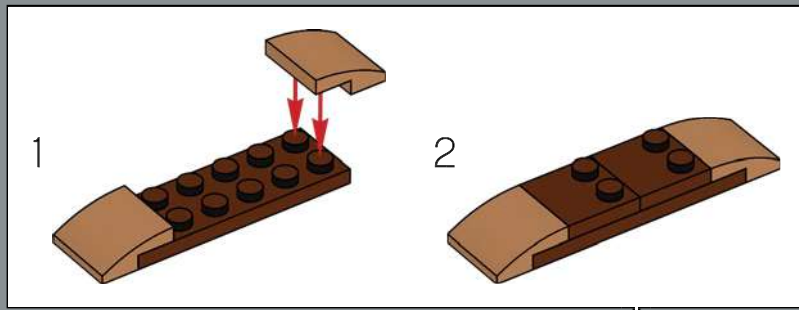

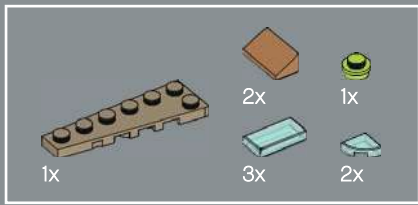

36

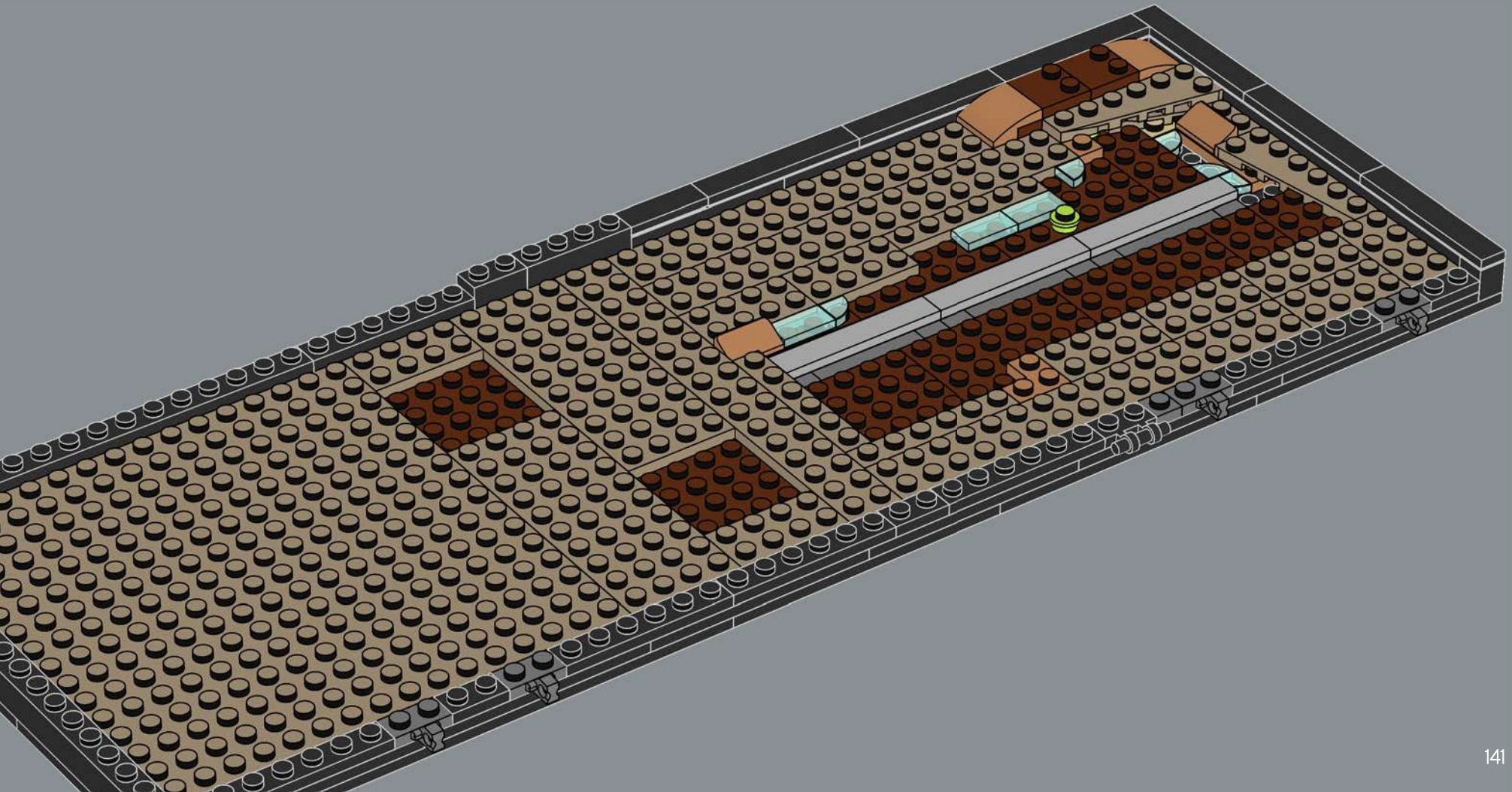



37

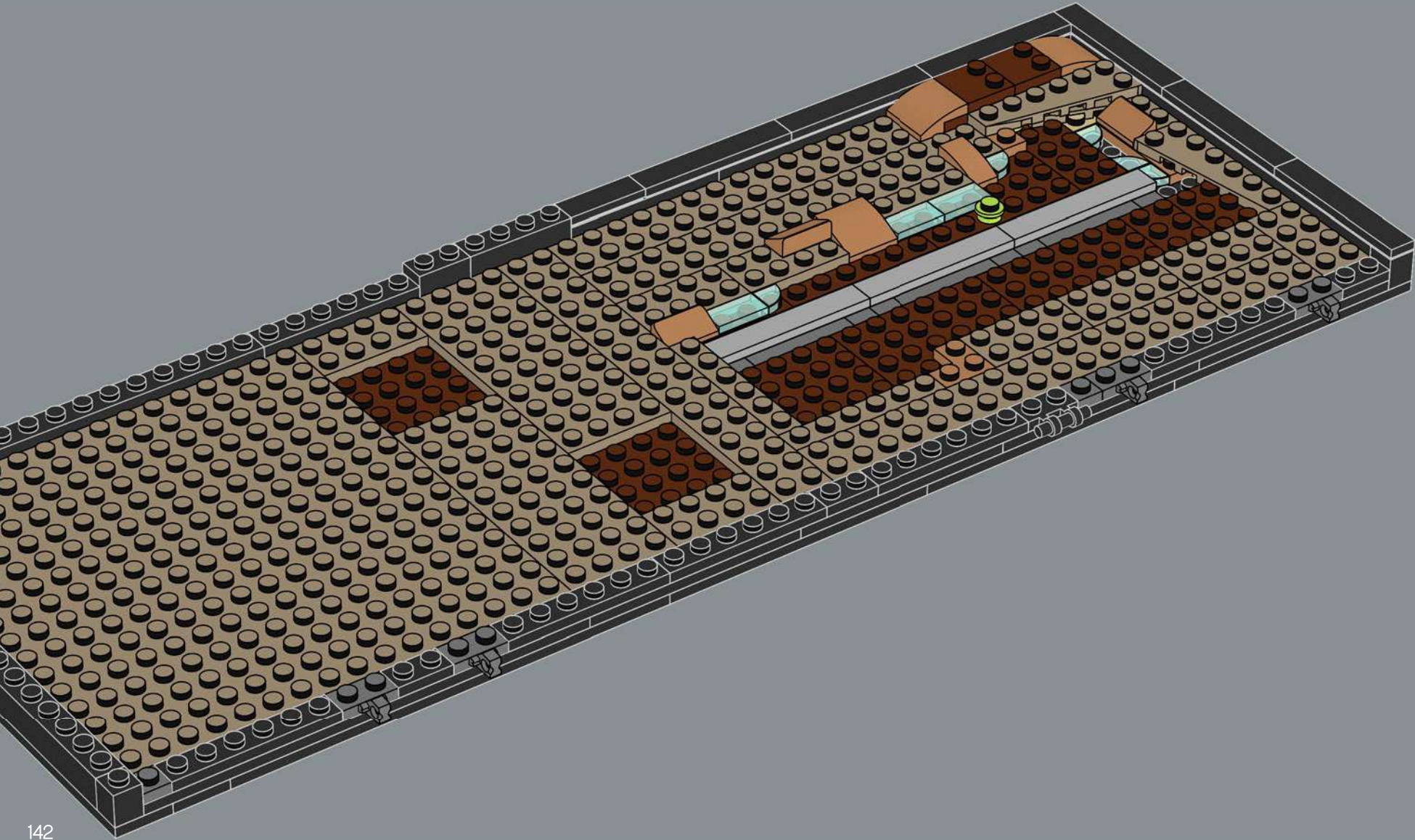

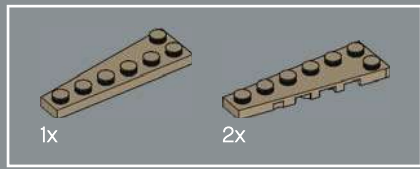

38

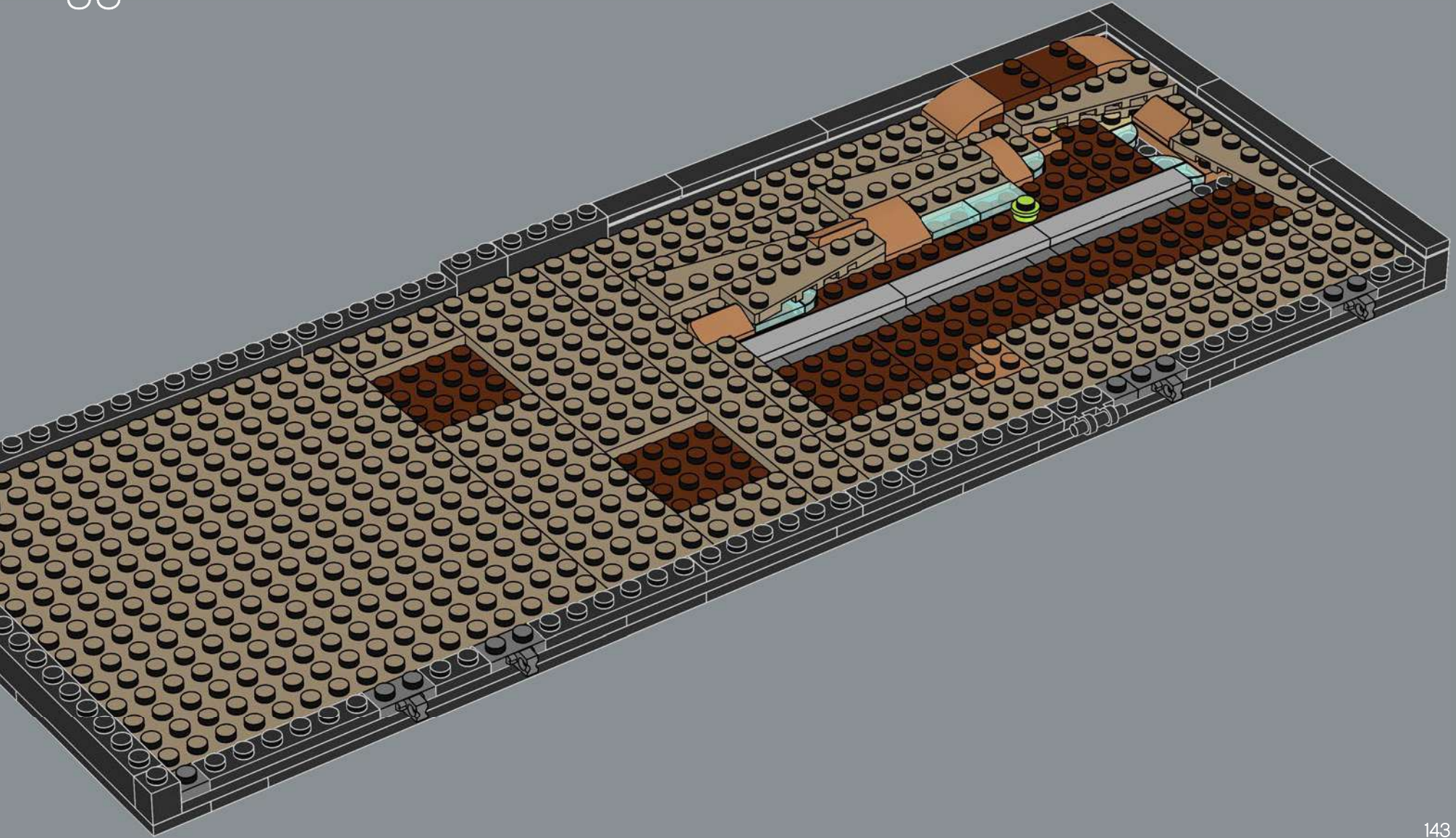



39

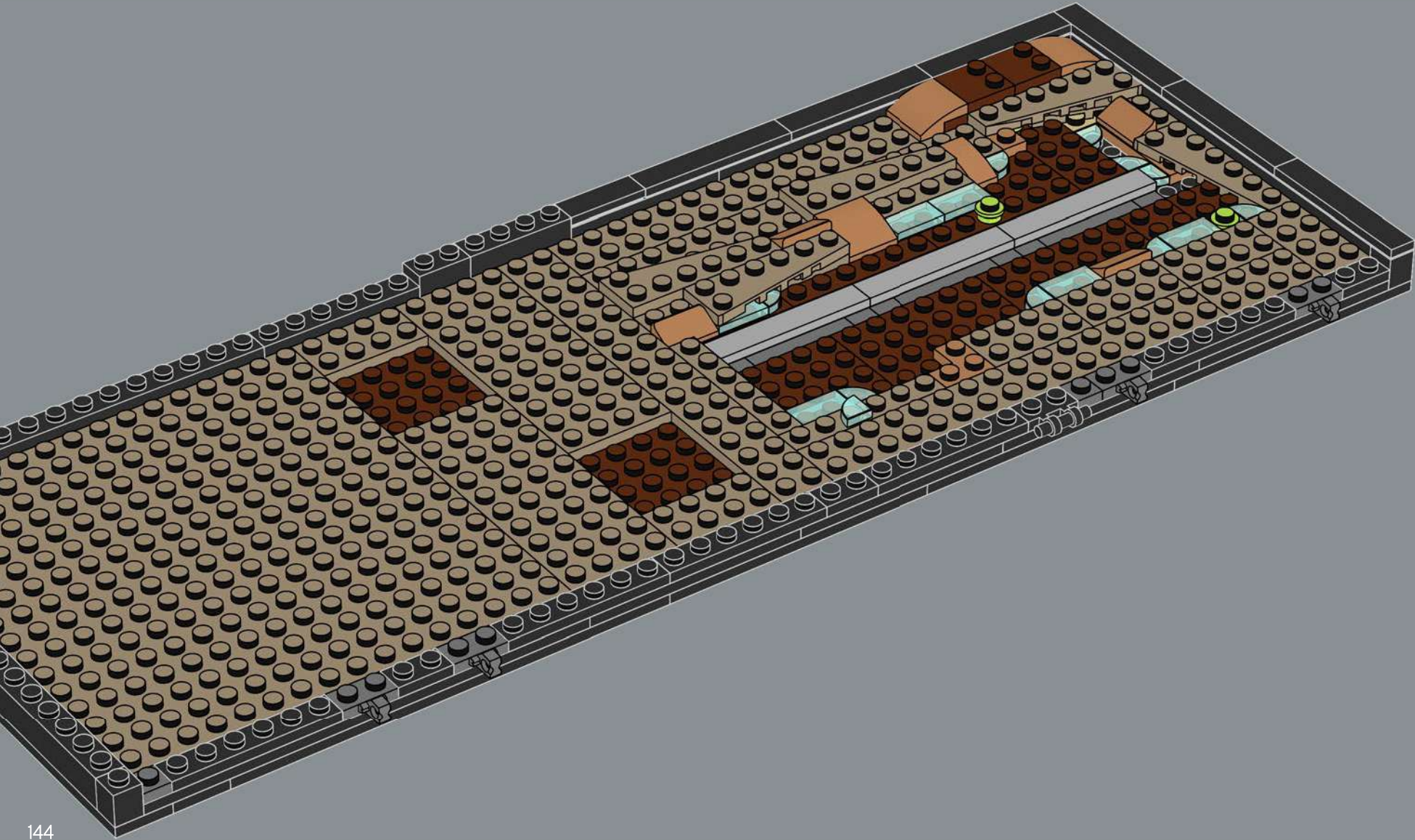

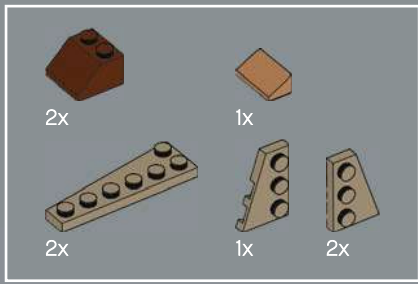

40

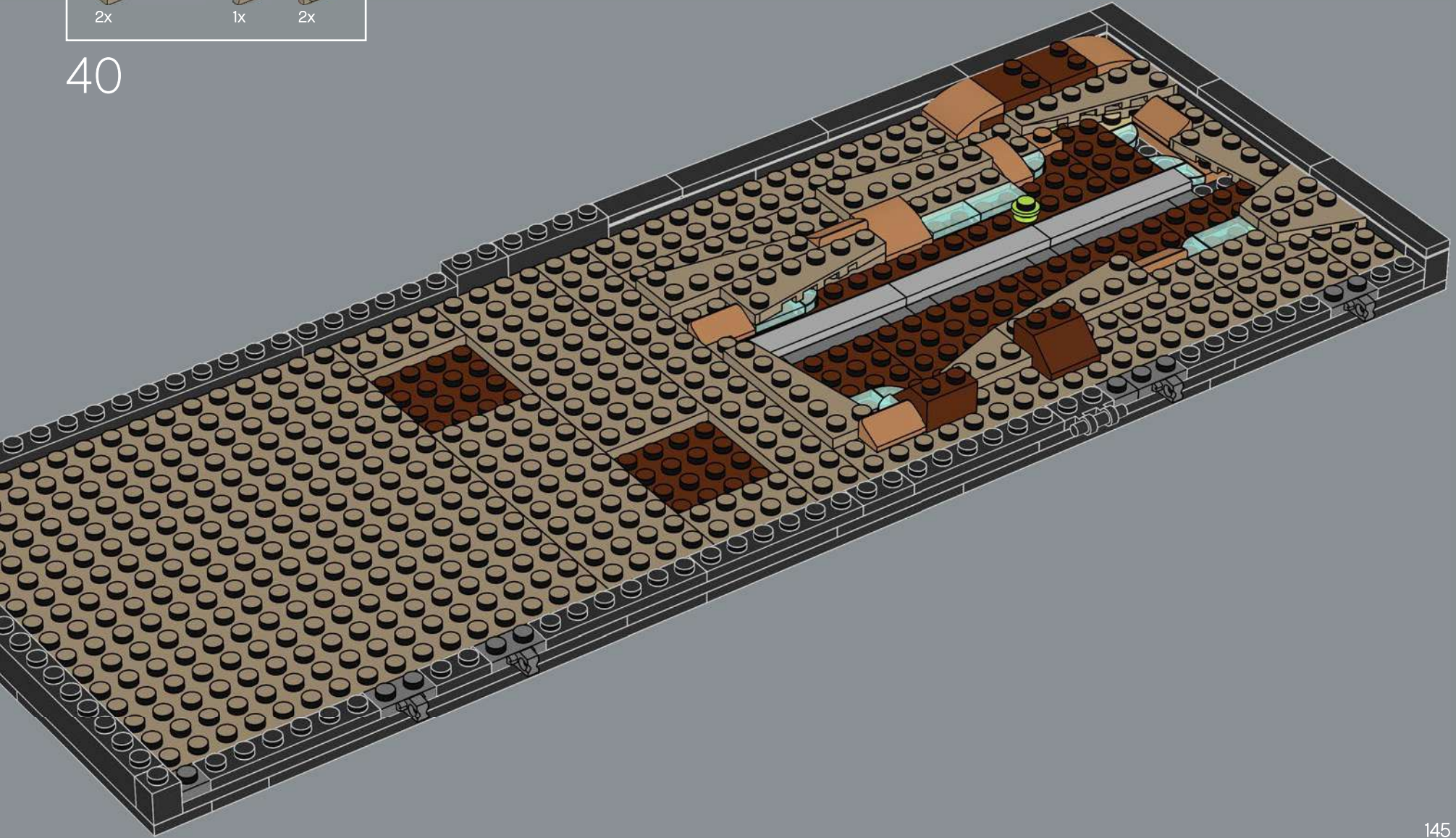

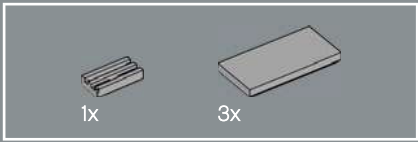

41

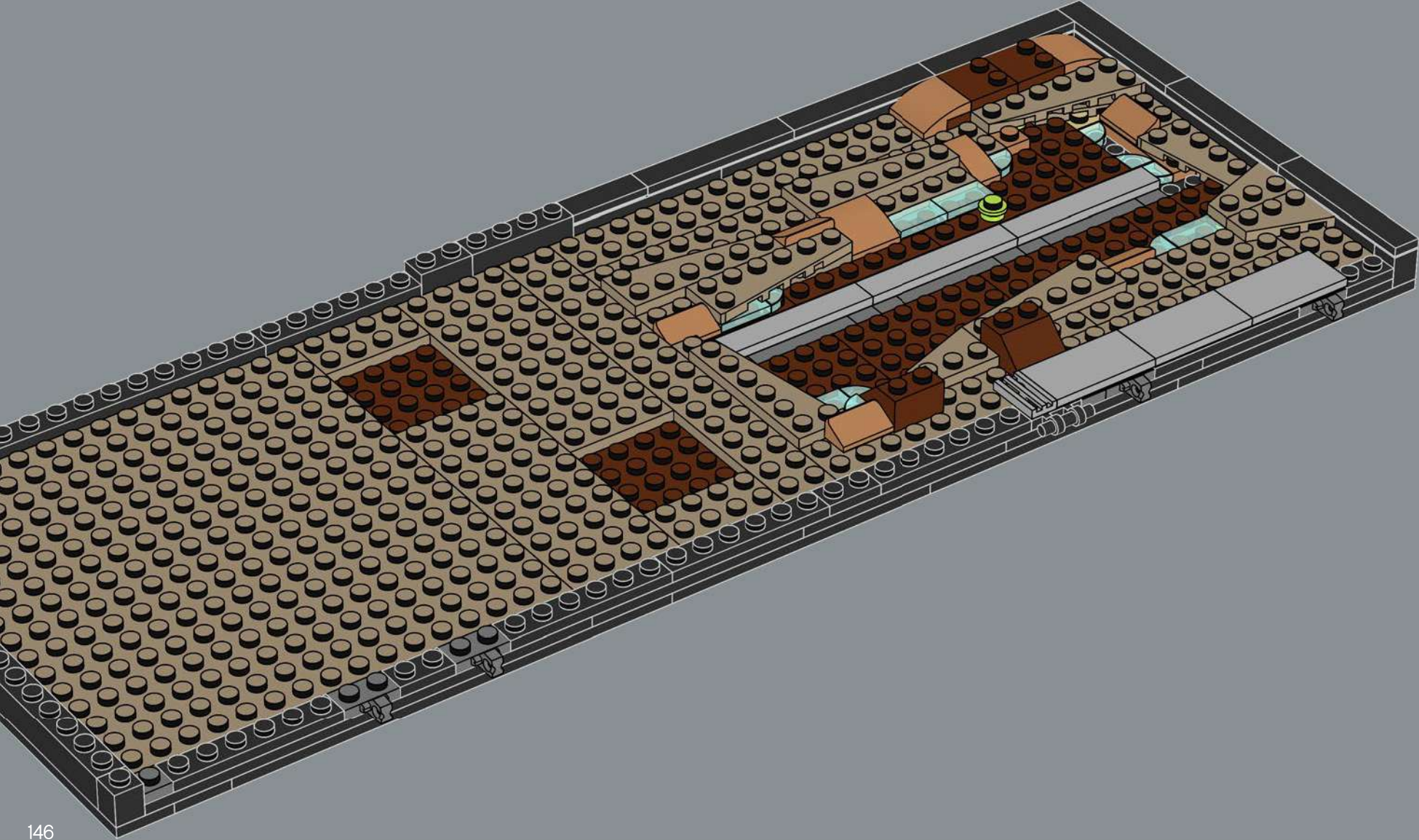

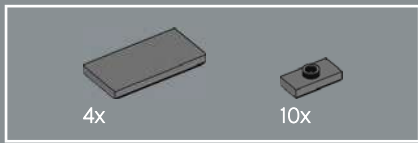

42

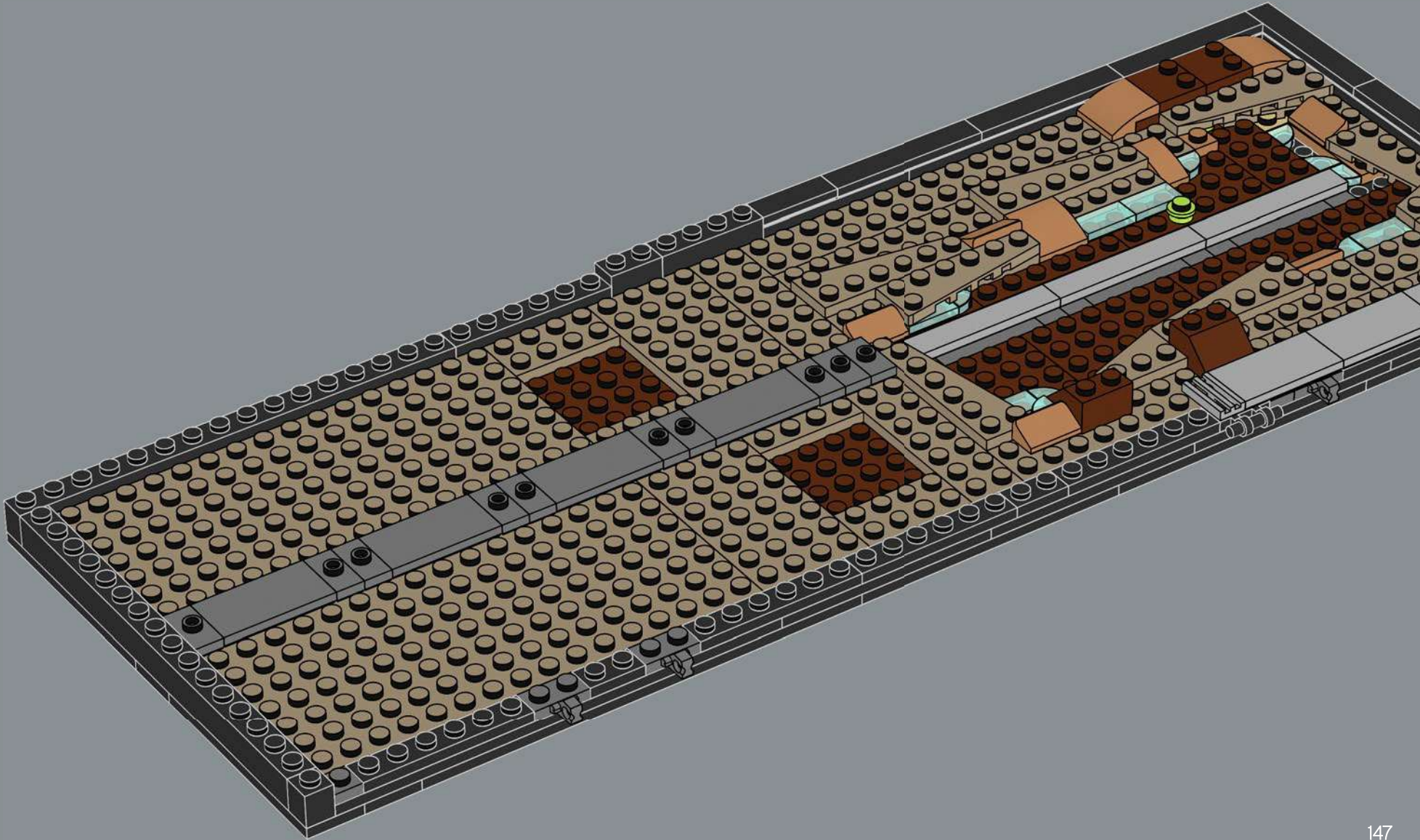

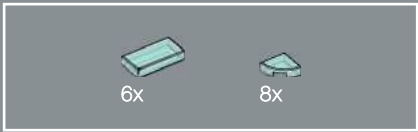

43

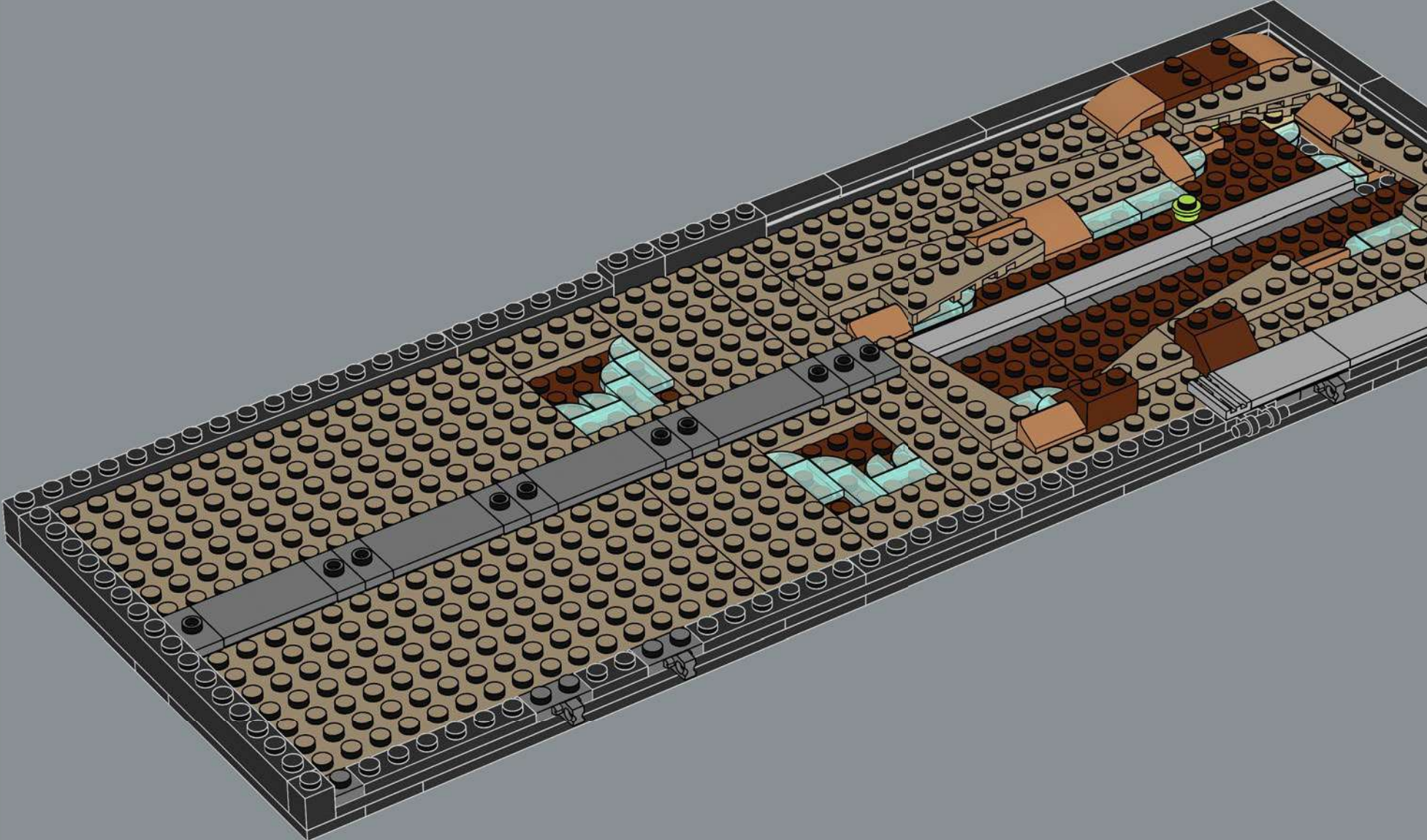

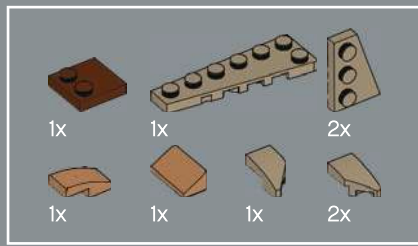

44

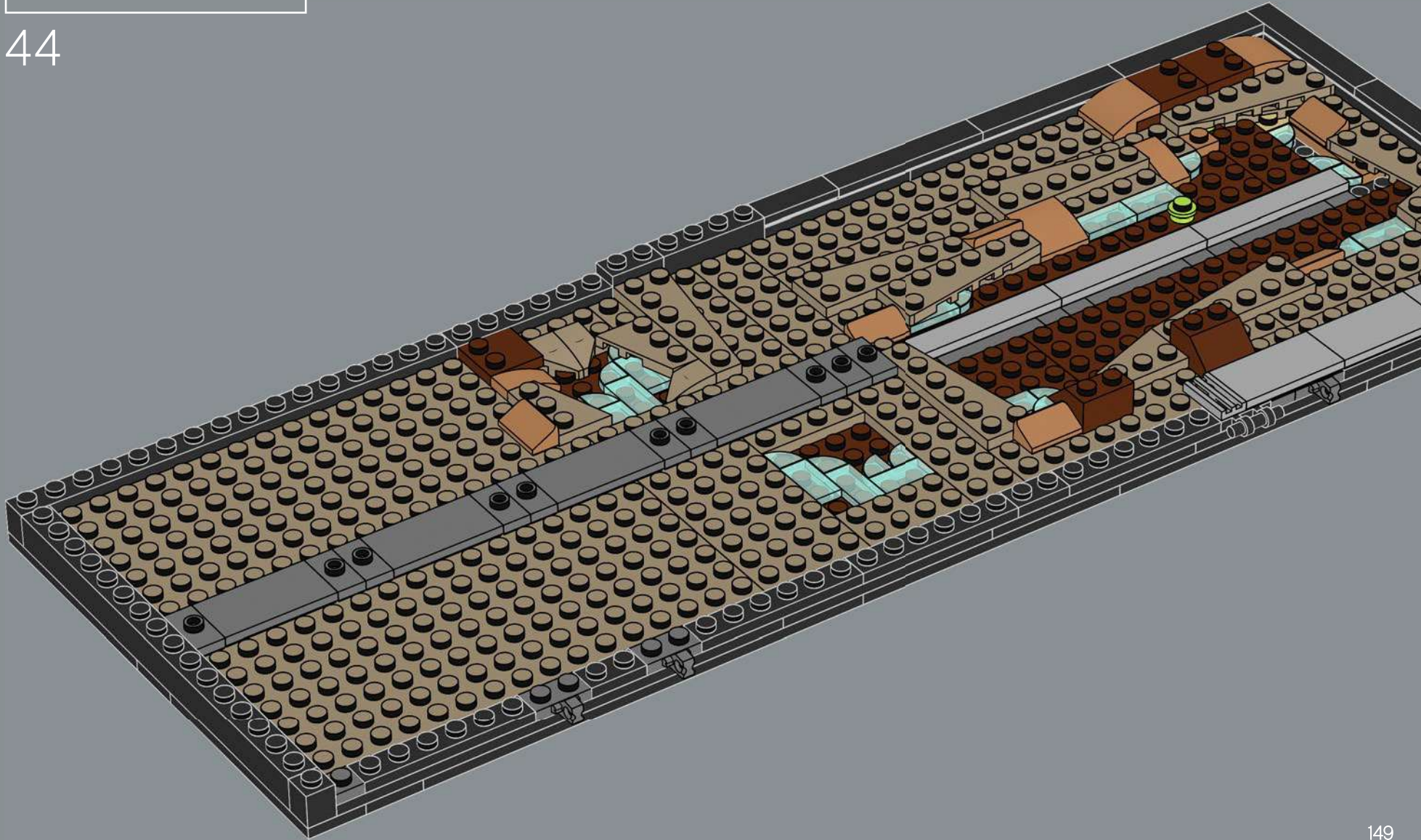

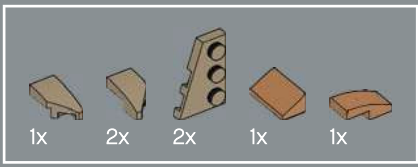

45

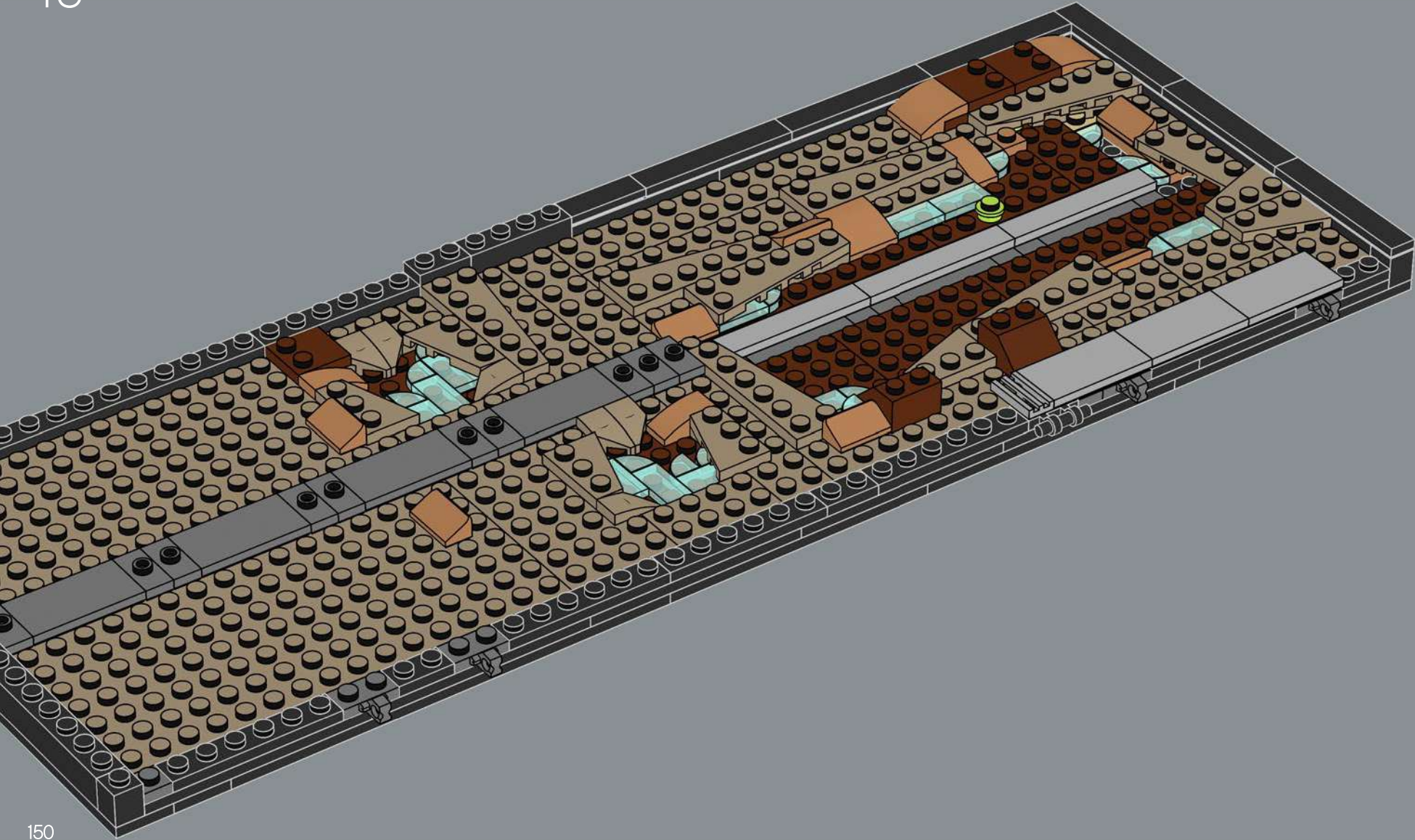



LEAVING A MARK

As a terrified Dr. Grant and Lex cover and desperately try to remain still and quiet, the T. rex stamps its foot down into the mud, creating giant footprints.

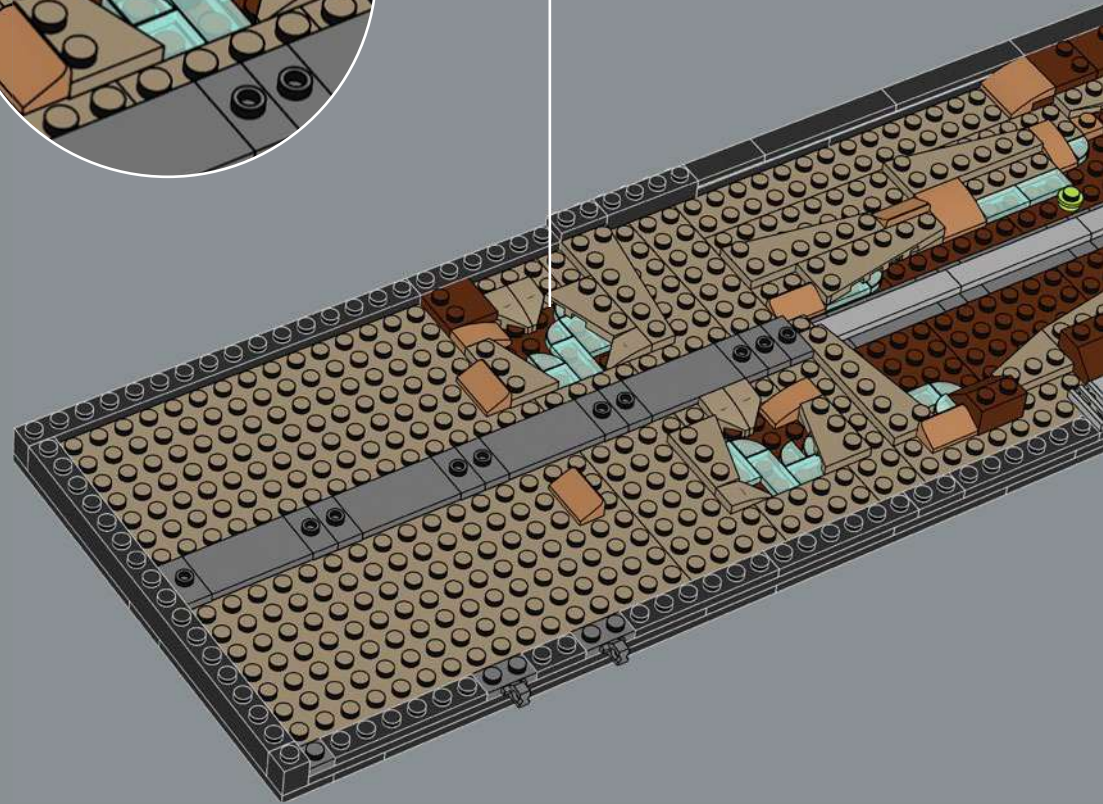
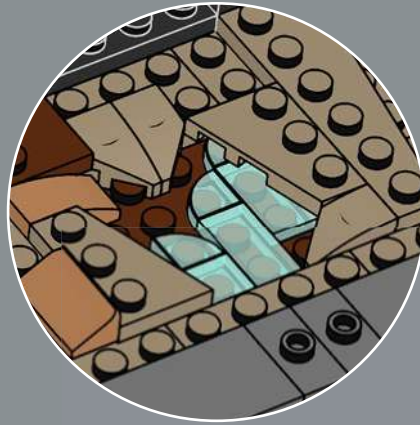

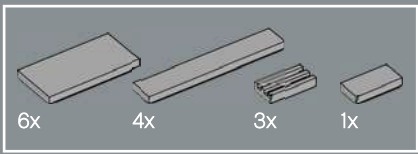

46

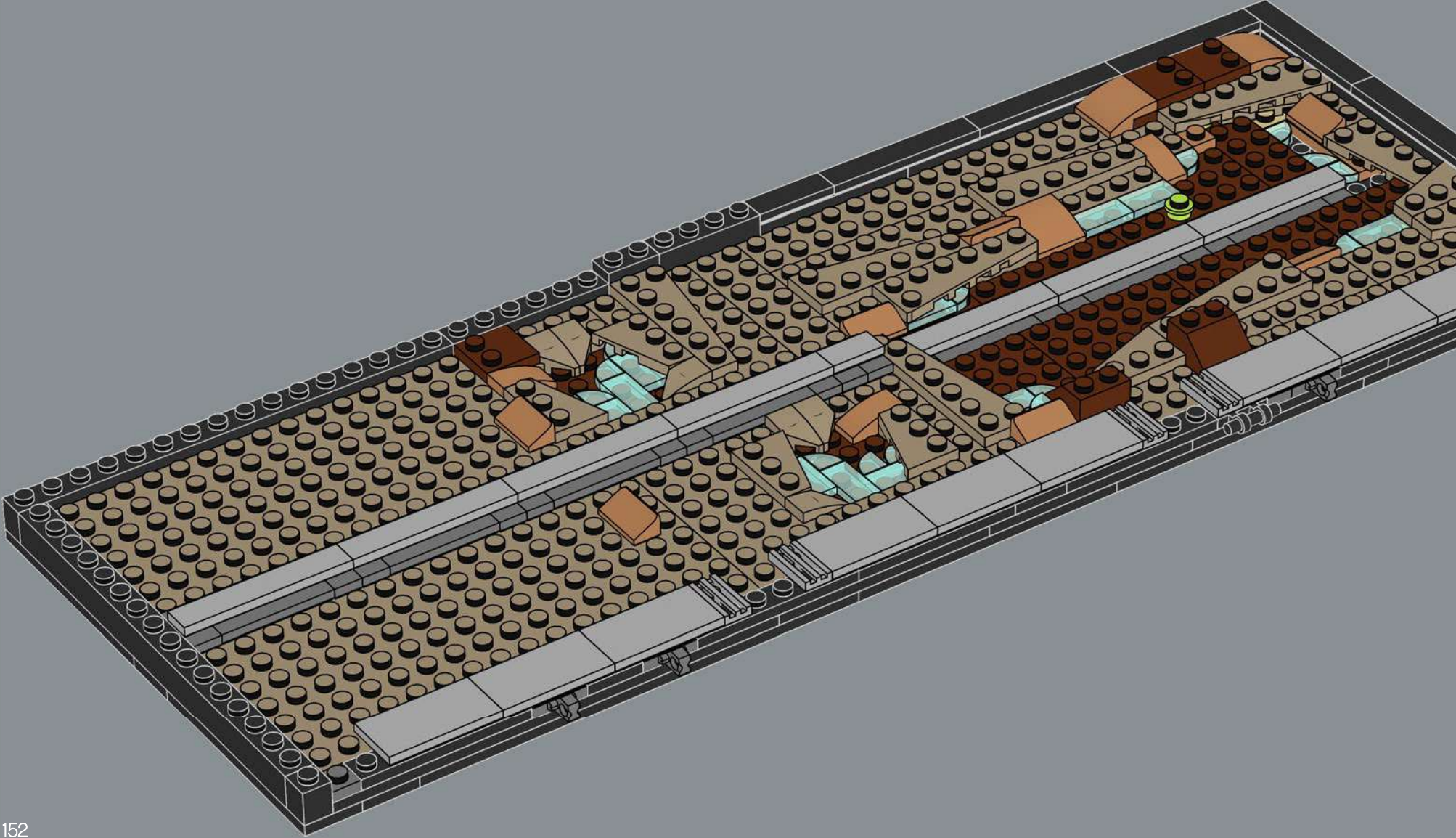

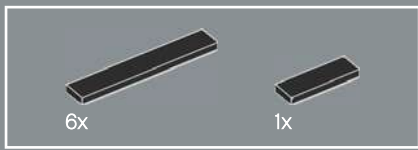

47

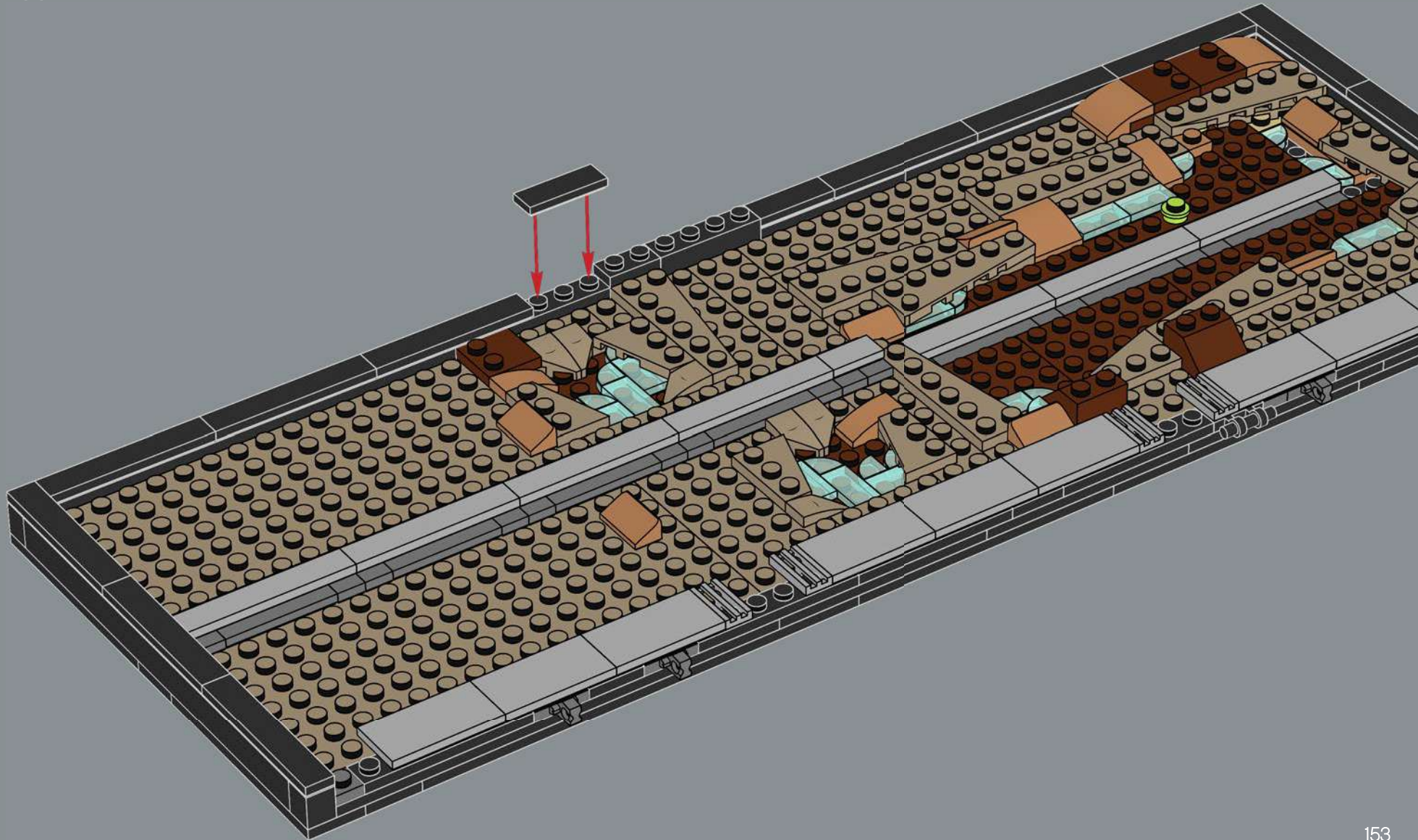

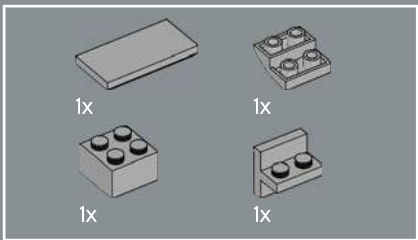

48

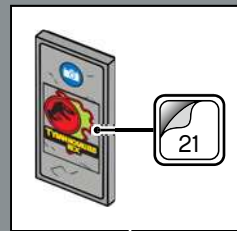
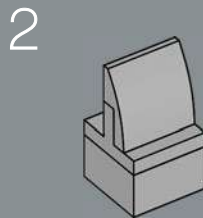
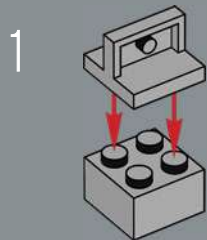

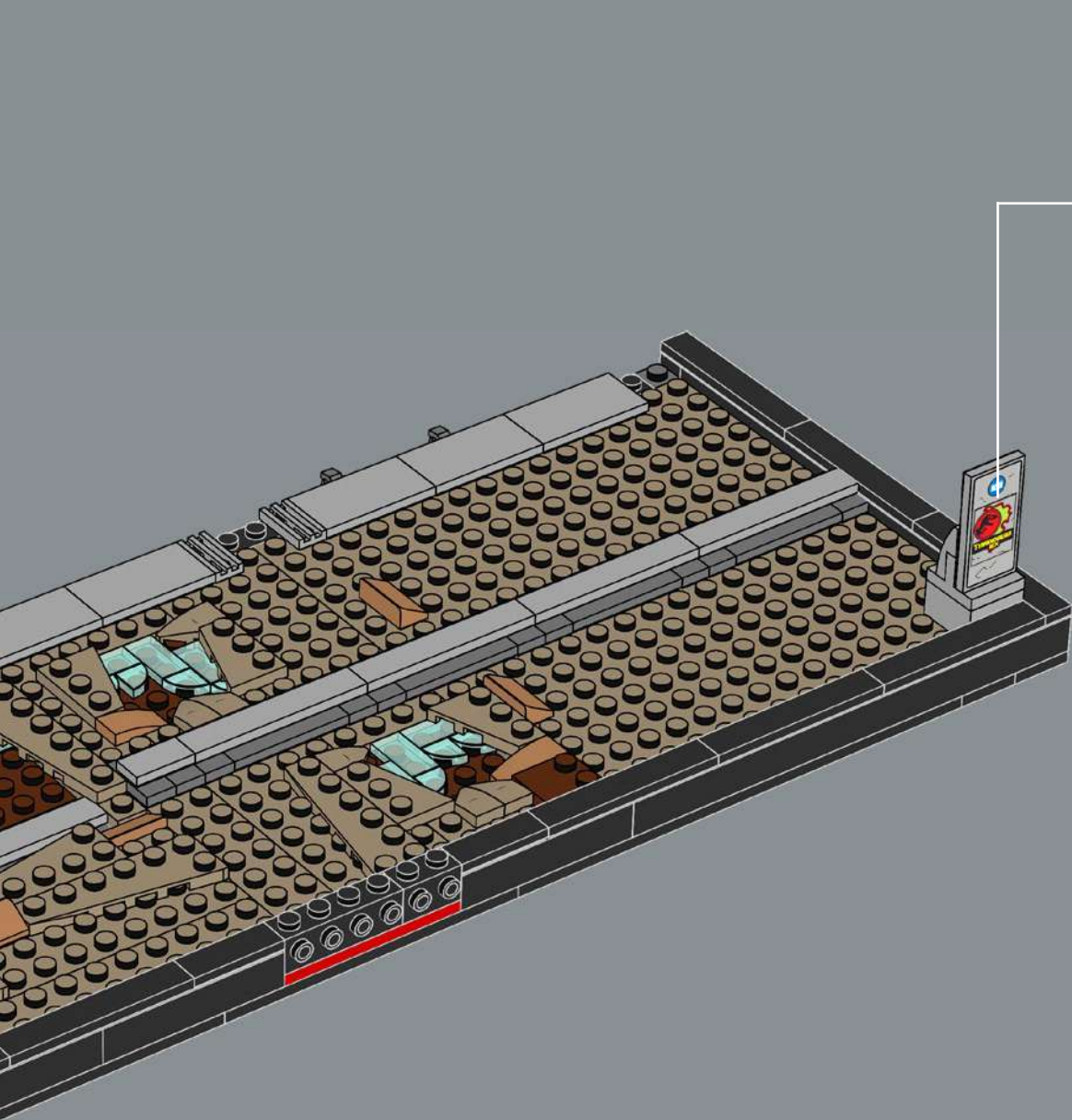

THE MAIN EVENT

Finally, we made it to the T. rex paddock, the main attraction at Jurassic Park!
What could possibly go wrong?

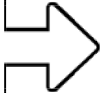

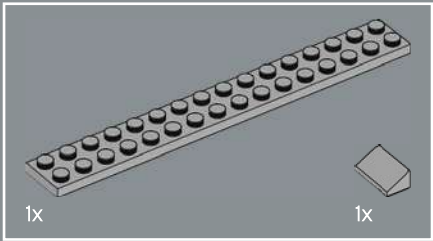
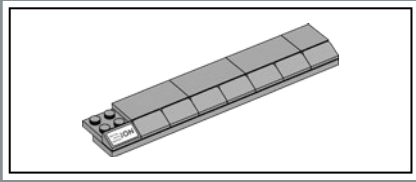
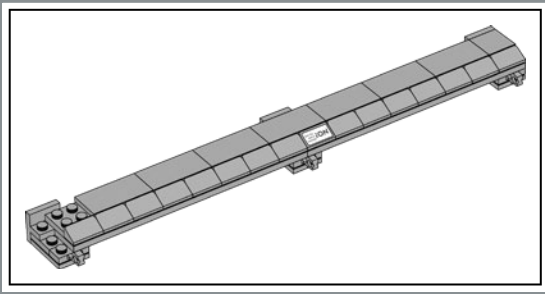

49

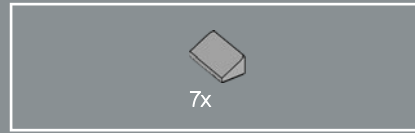
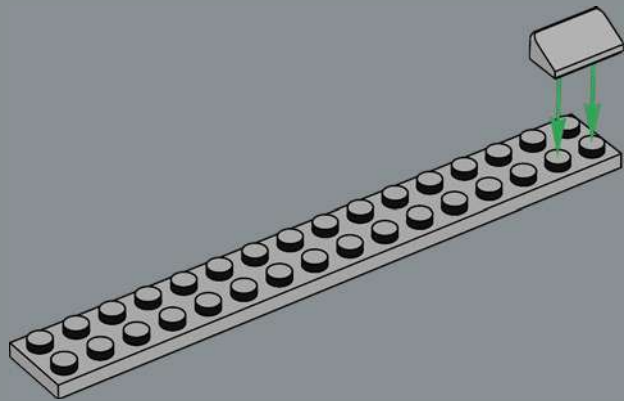

50

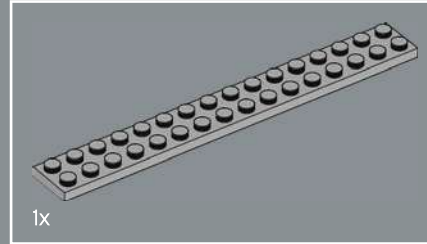
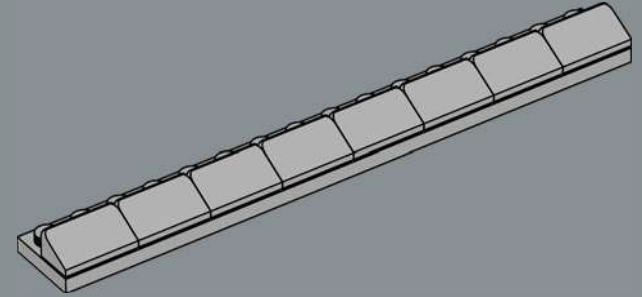

51

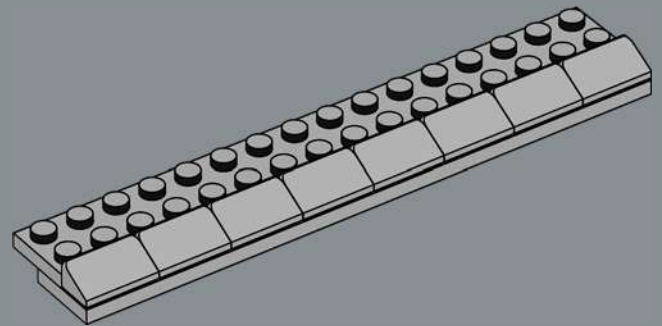

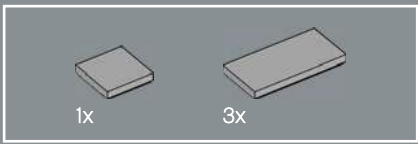

52

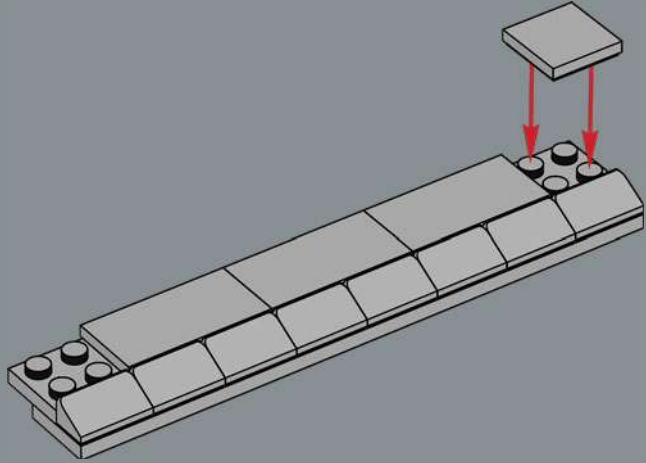

53

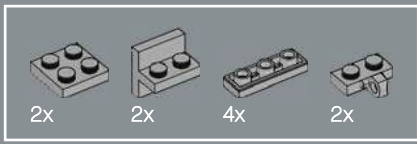
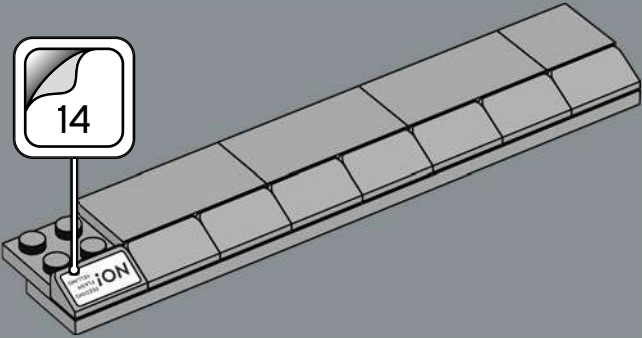

54

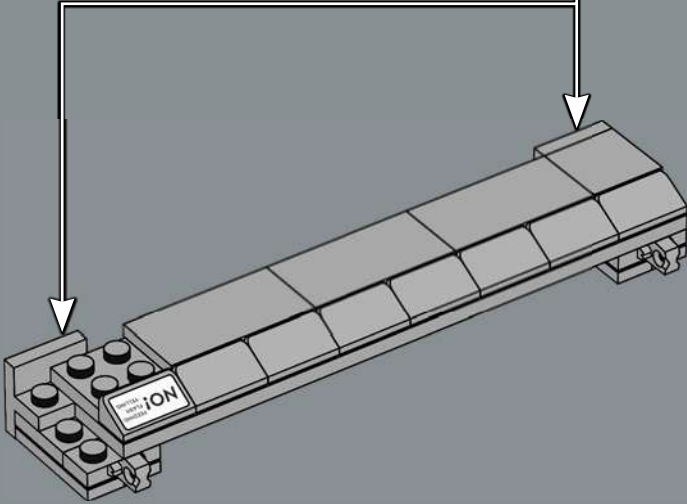
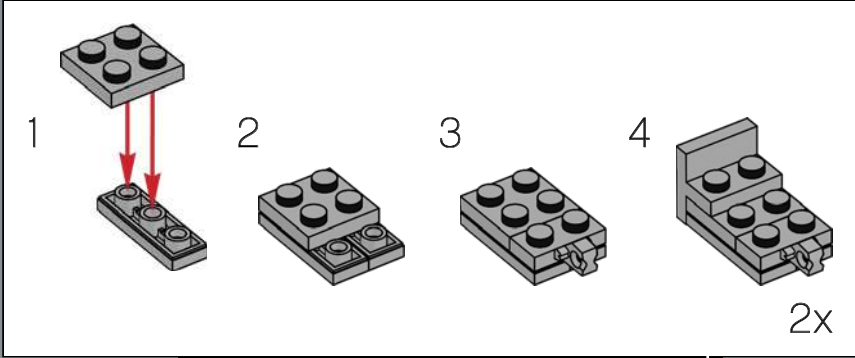

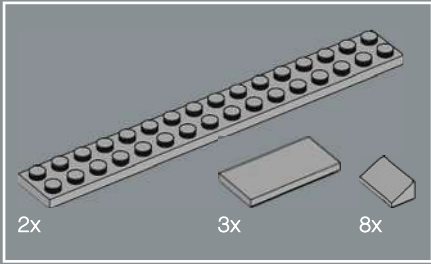
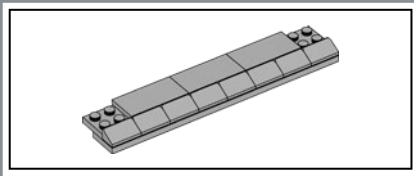

55

1

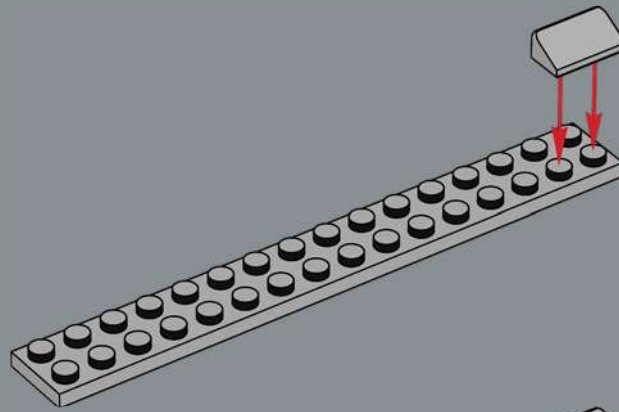

2

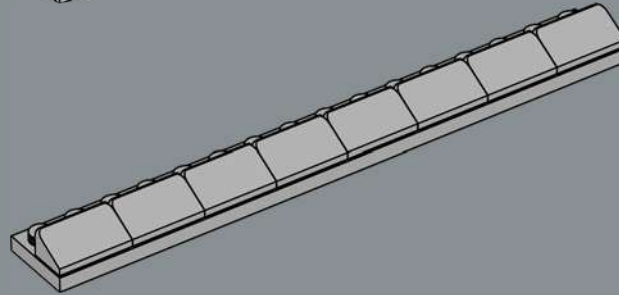

3

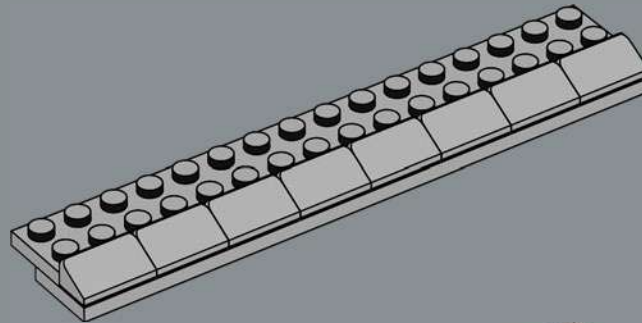

4

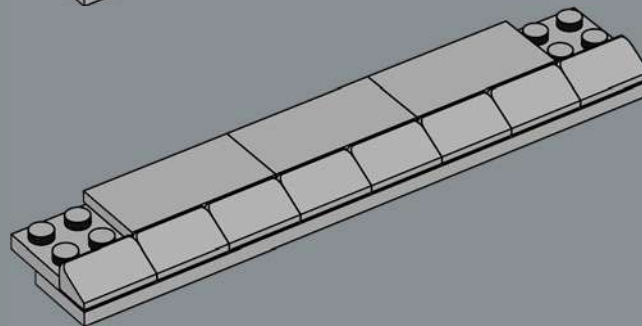

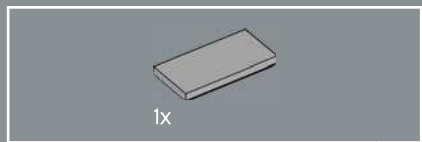
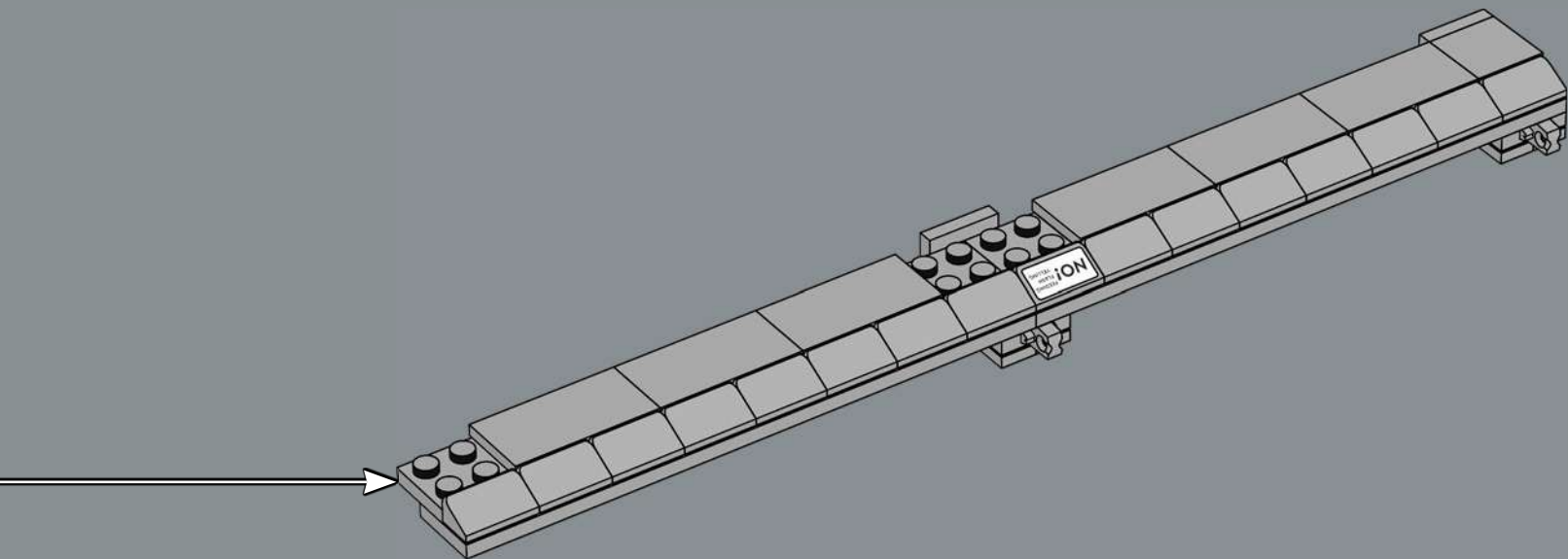

56

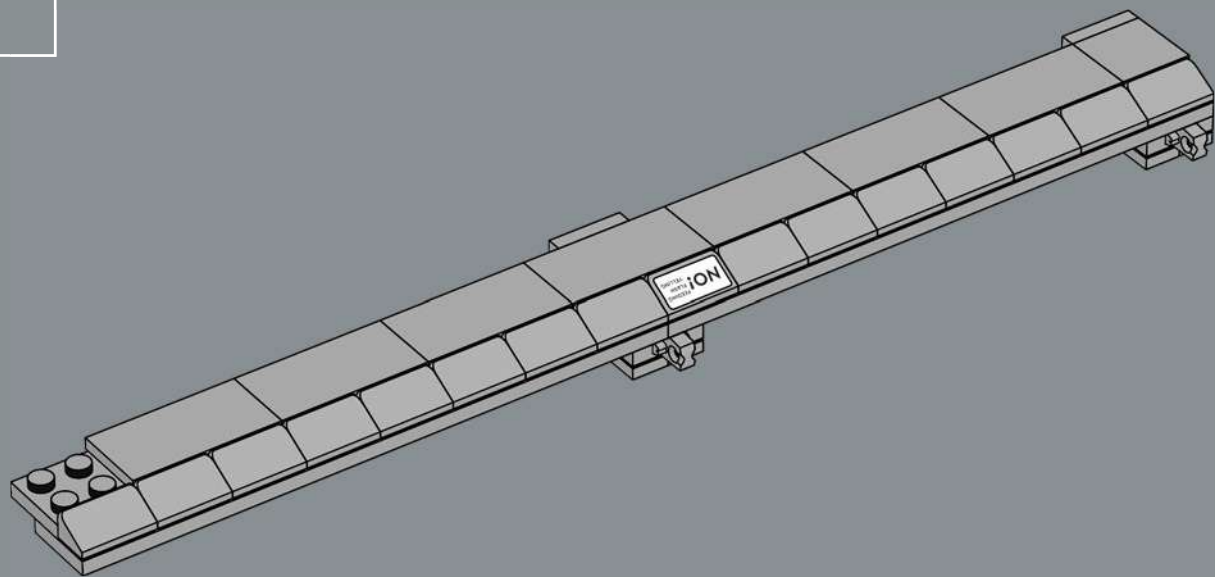

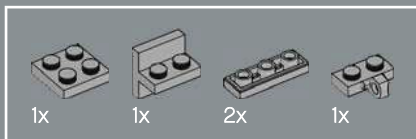

57

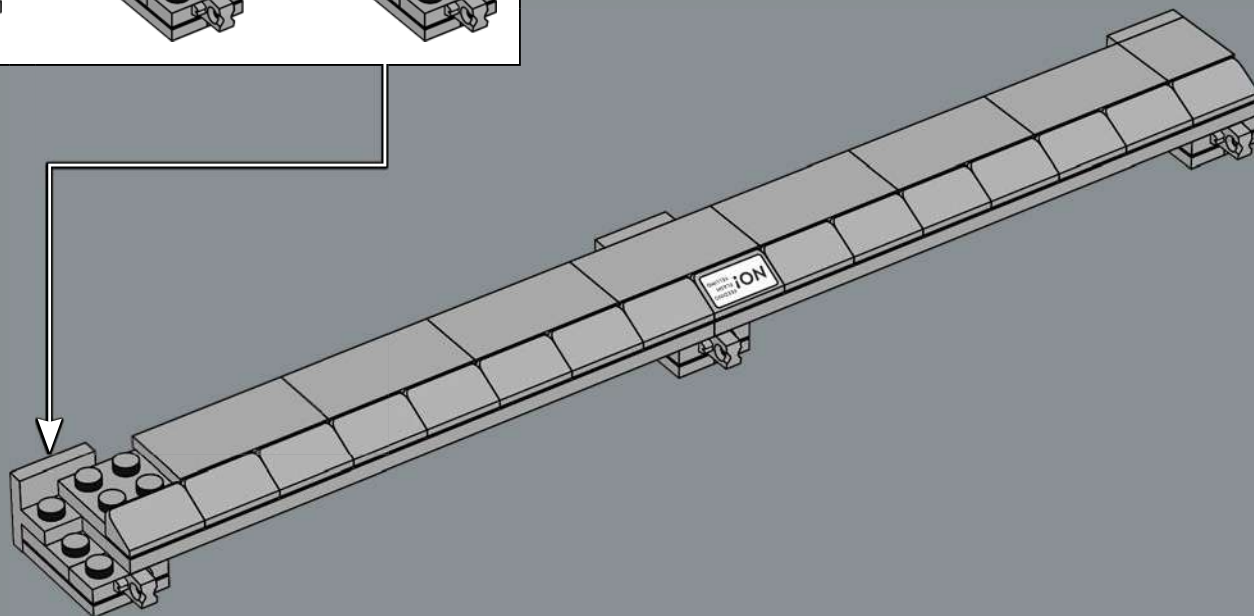
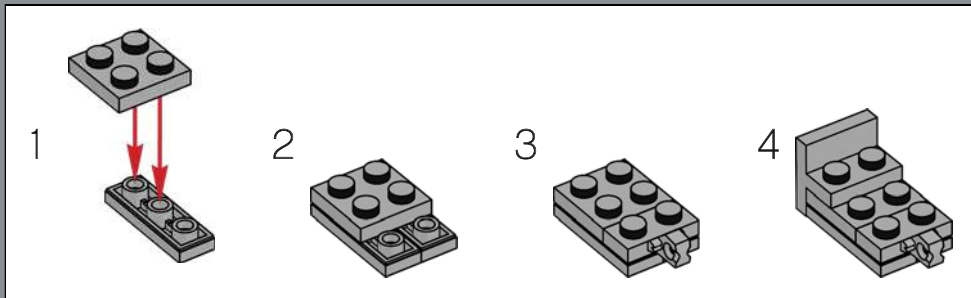

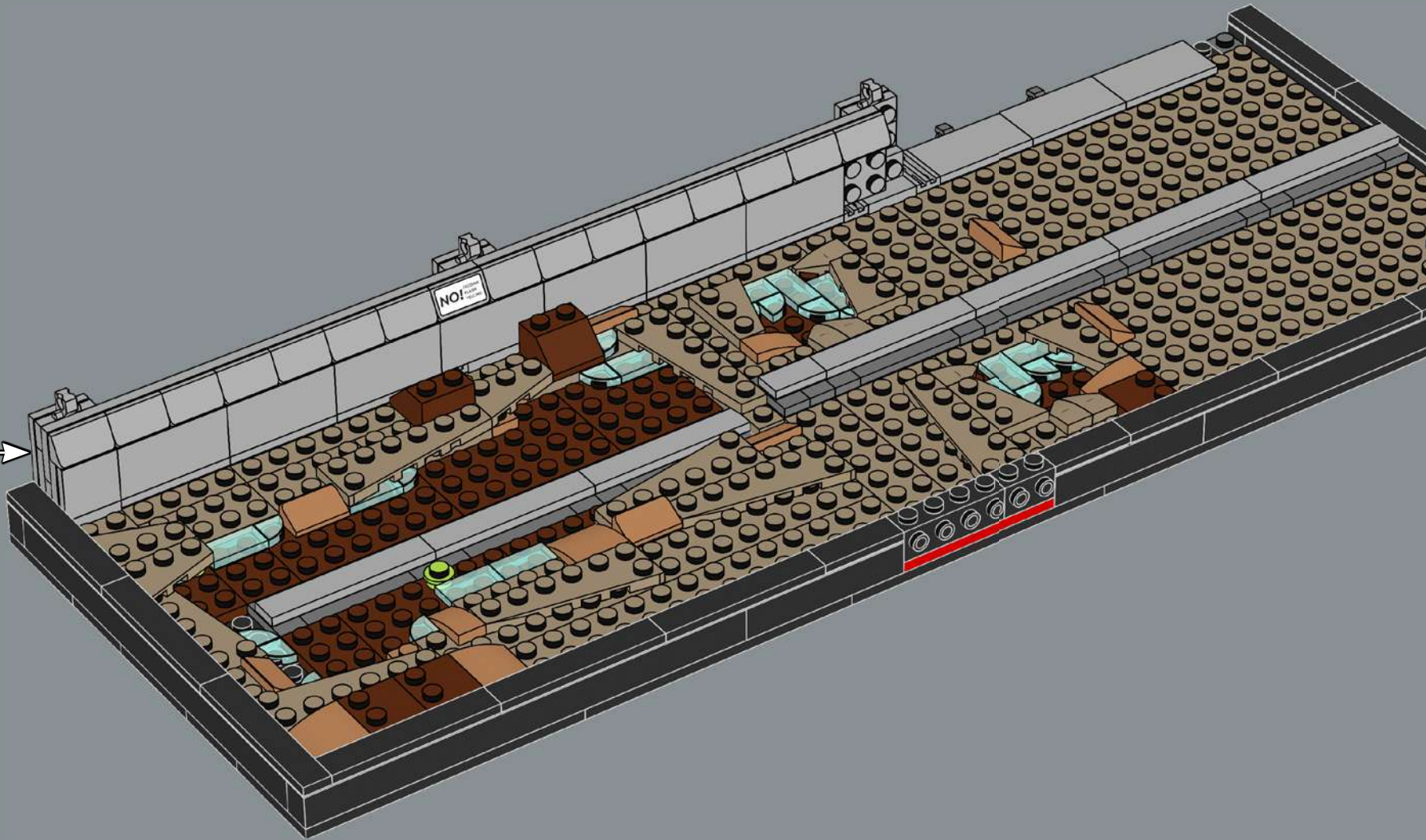

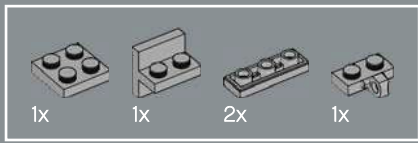

59

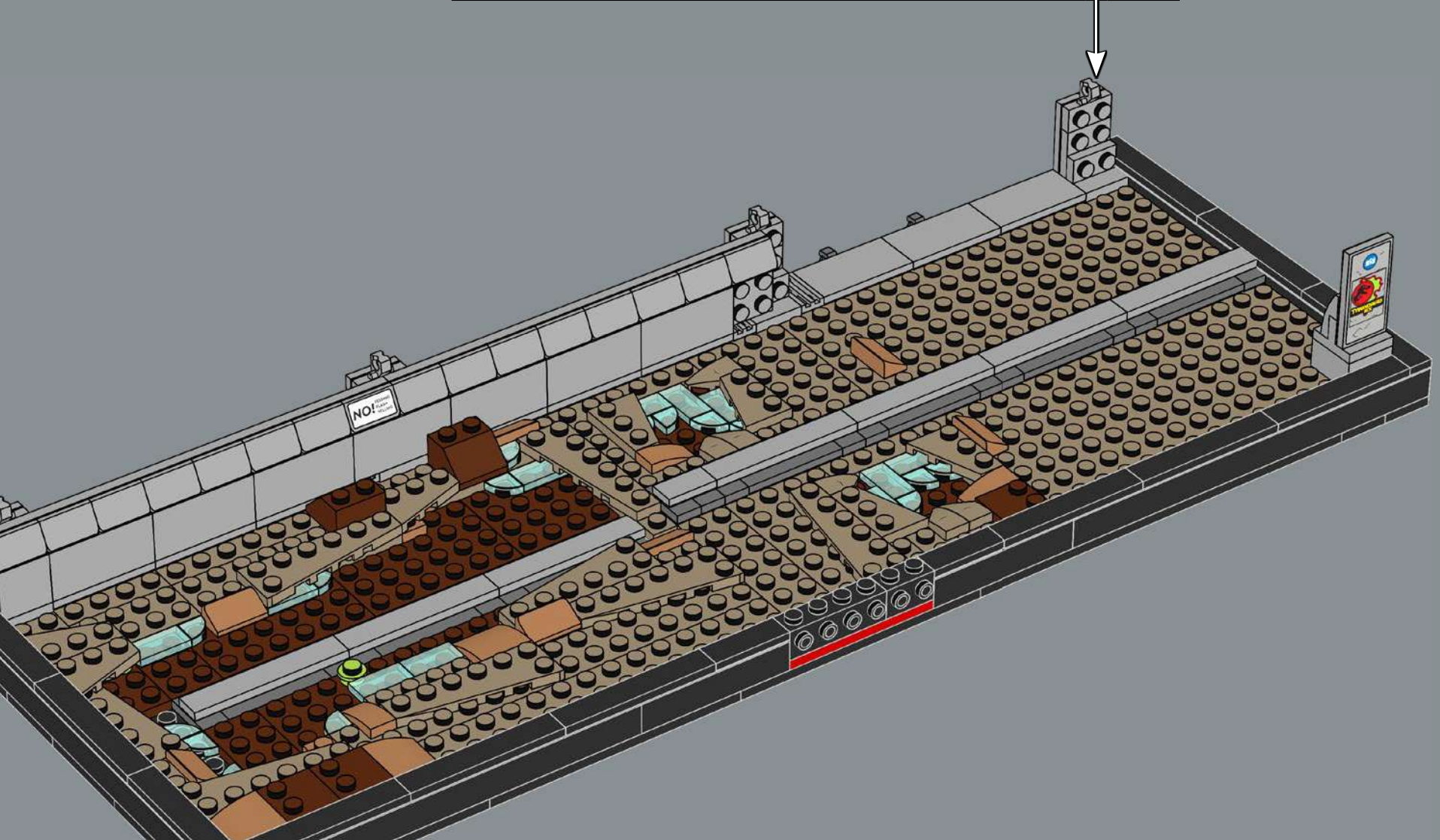
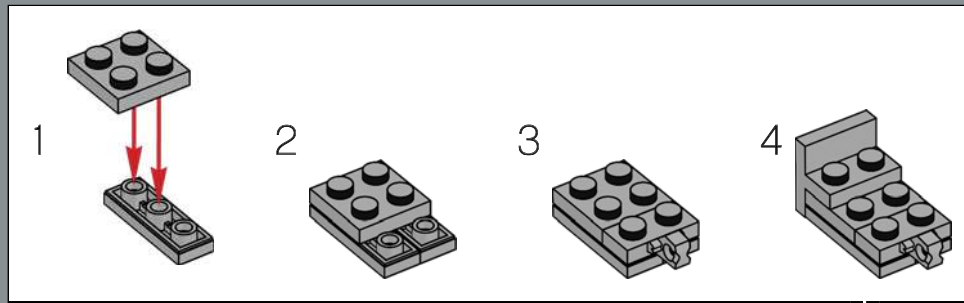

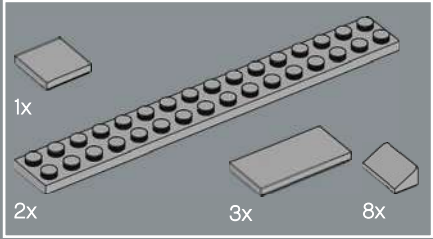
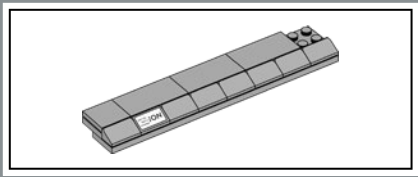

60

1

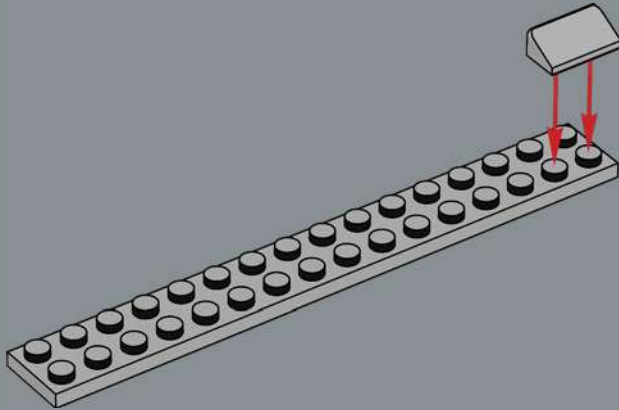

2

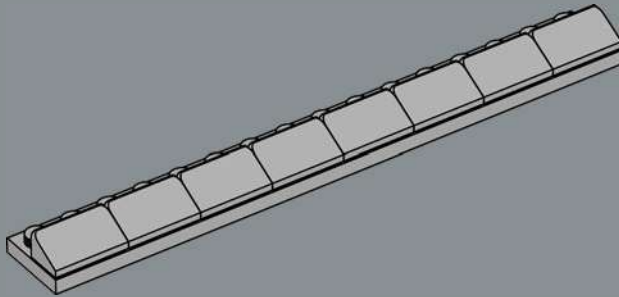

3

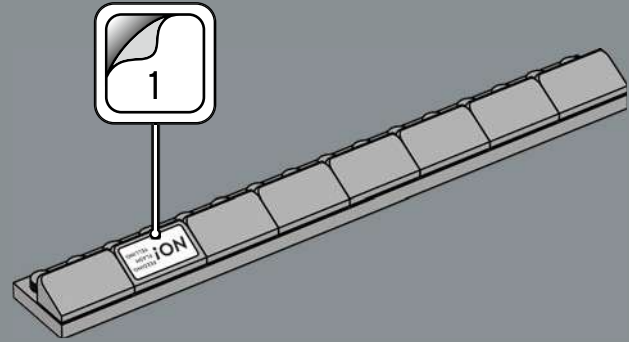

4

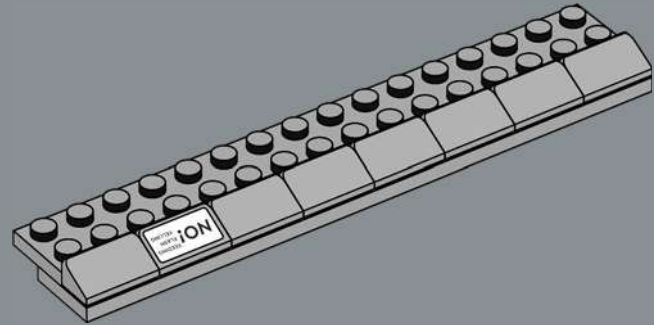

5

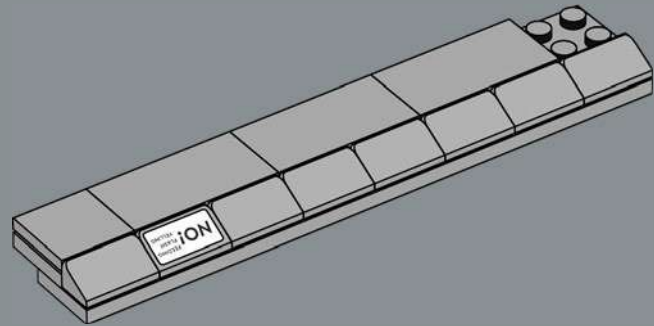

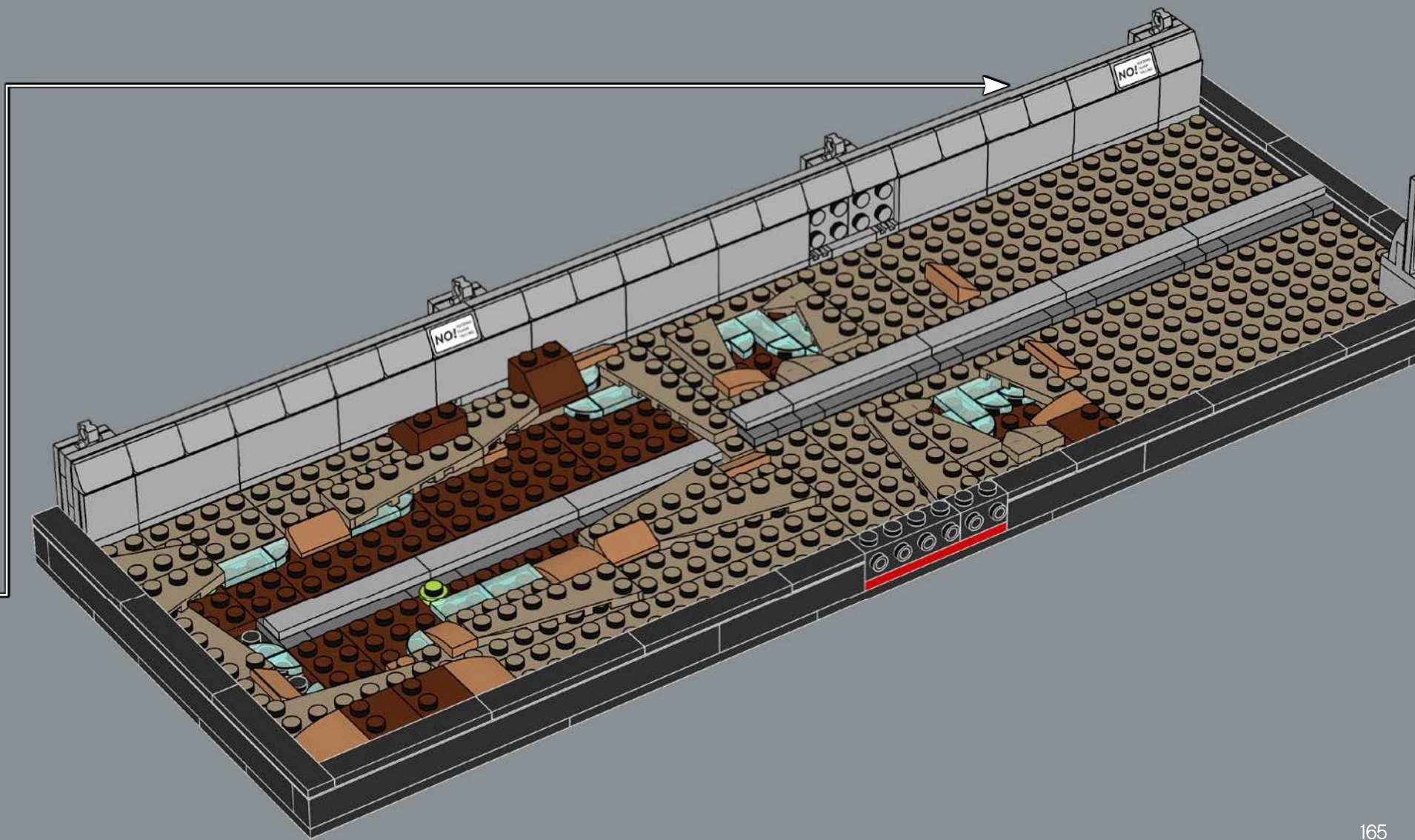

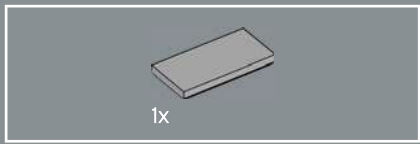

61

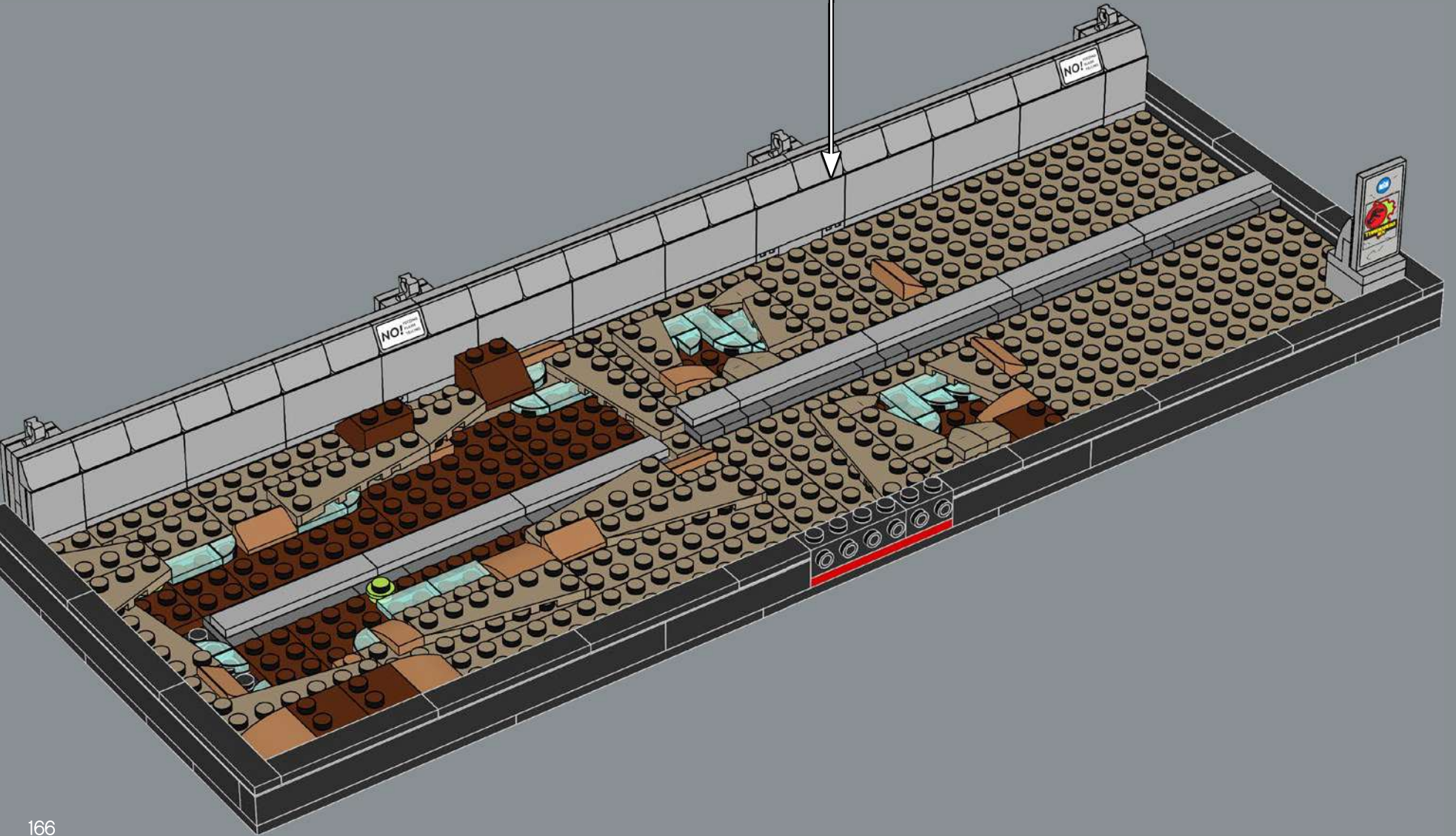
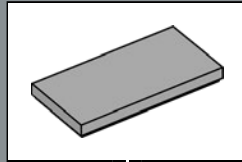

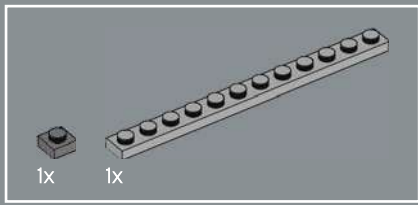

62

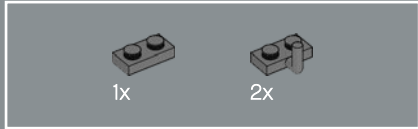
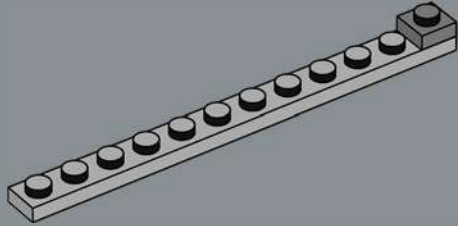

63

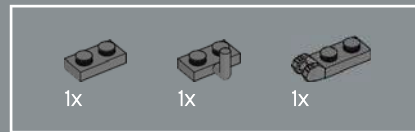
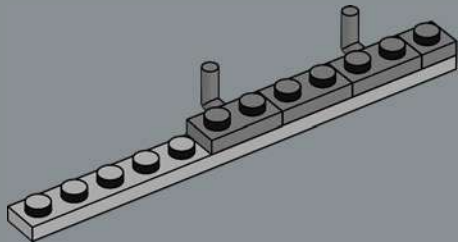

64

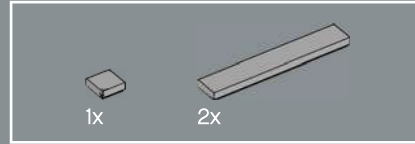
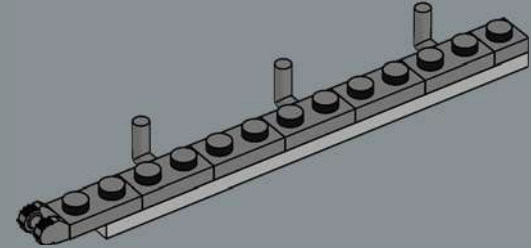

65

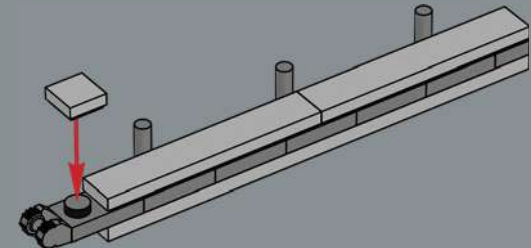

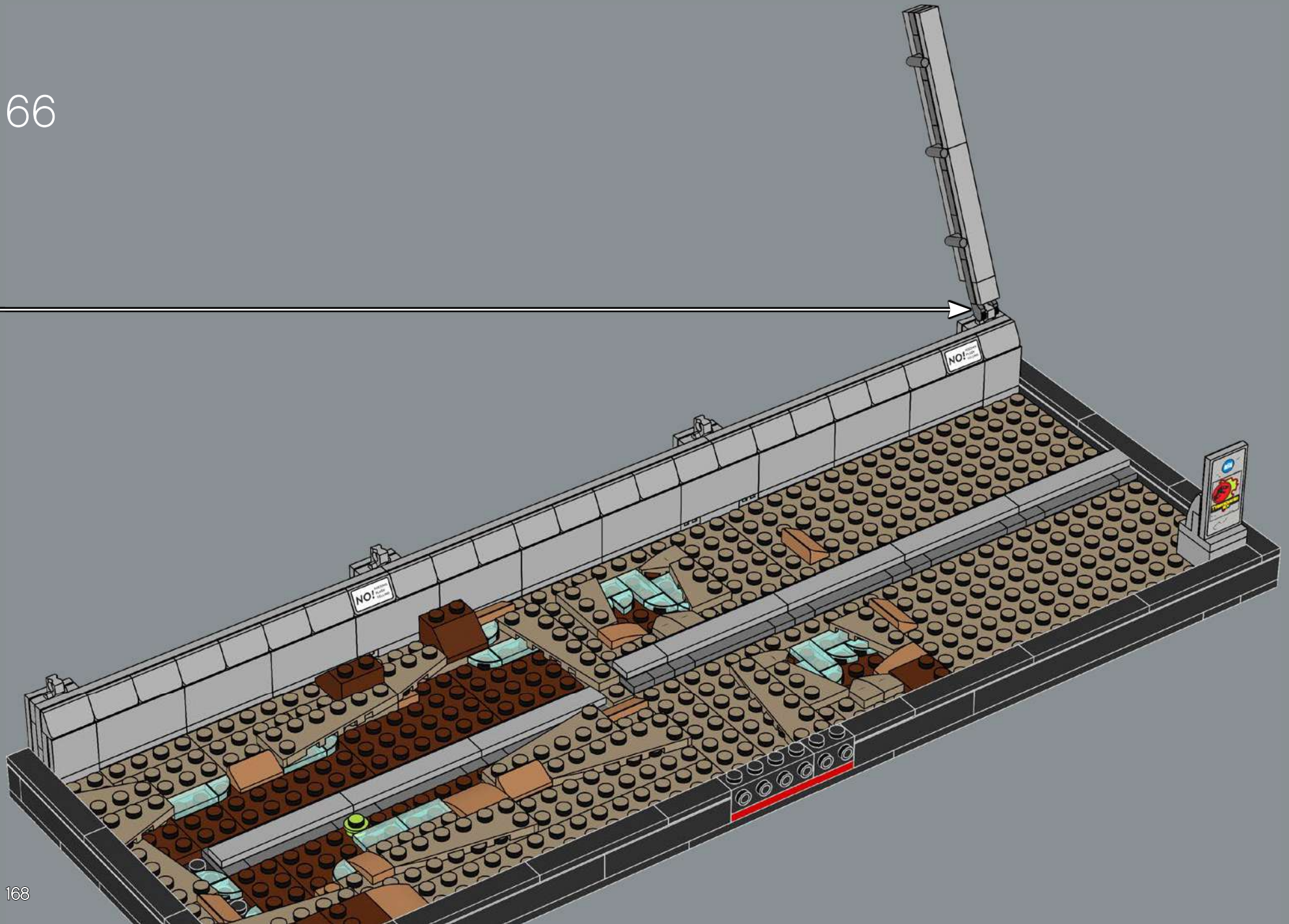

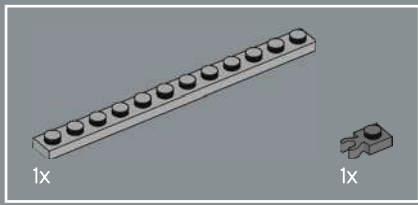

67

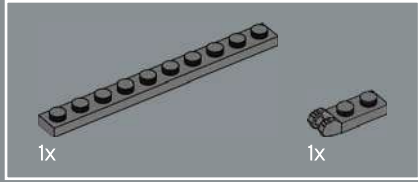
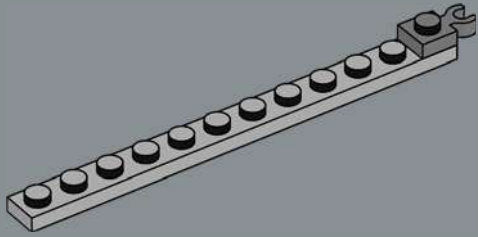

68

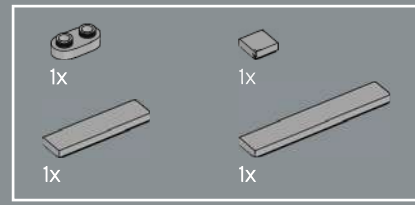
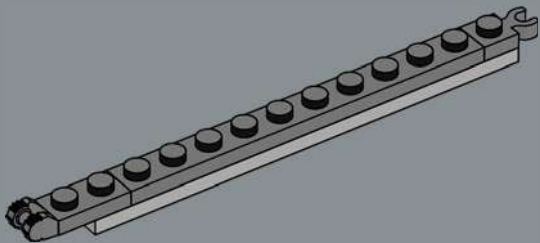

69

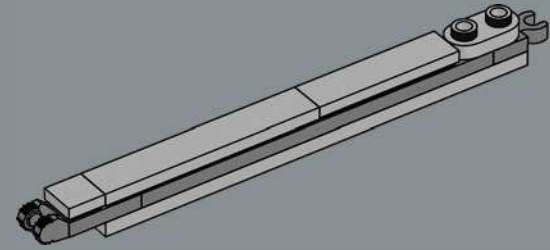

70

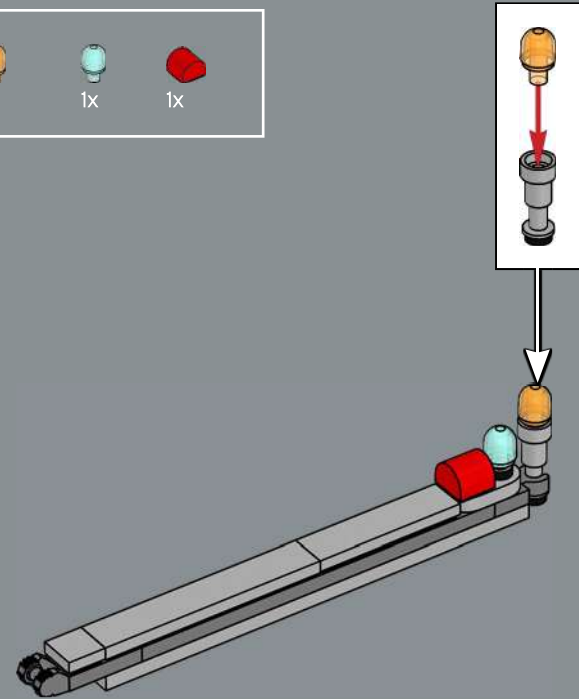

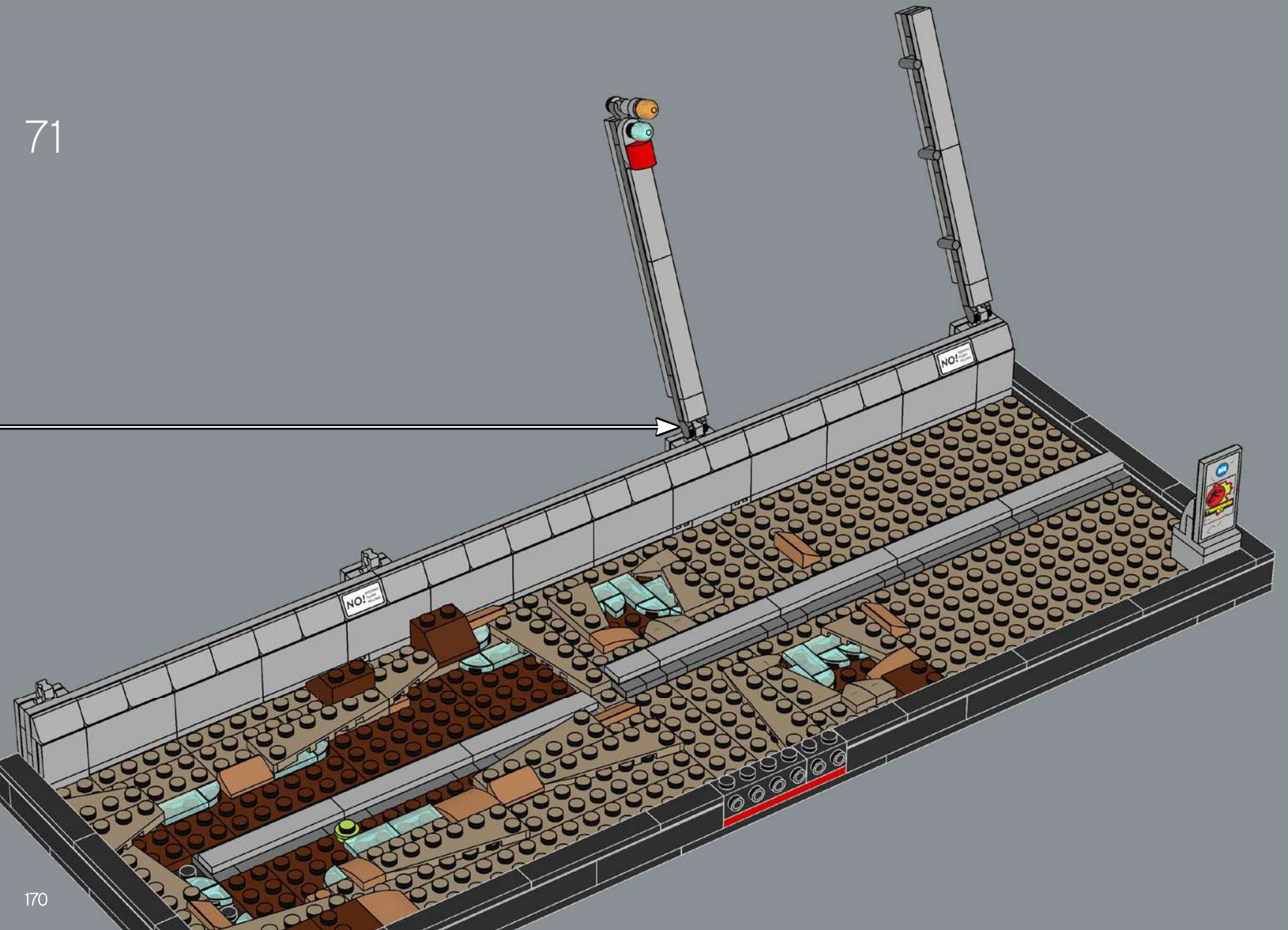

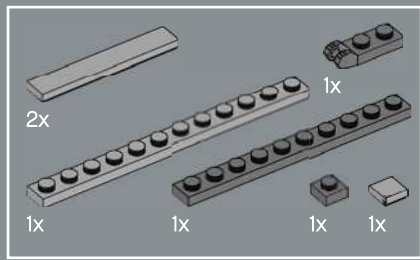

72

1

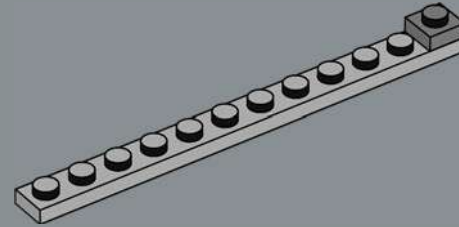

2

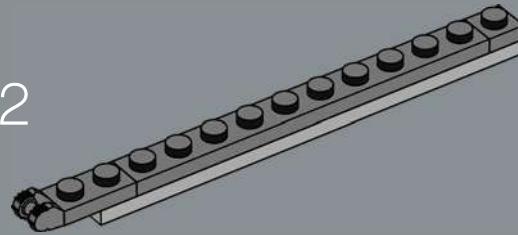

3

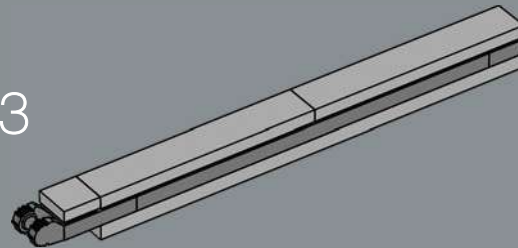

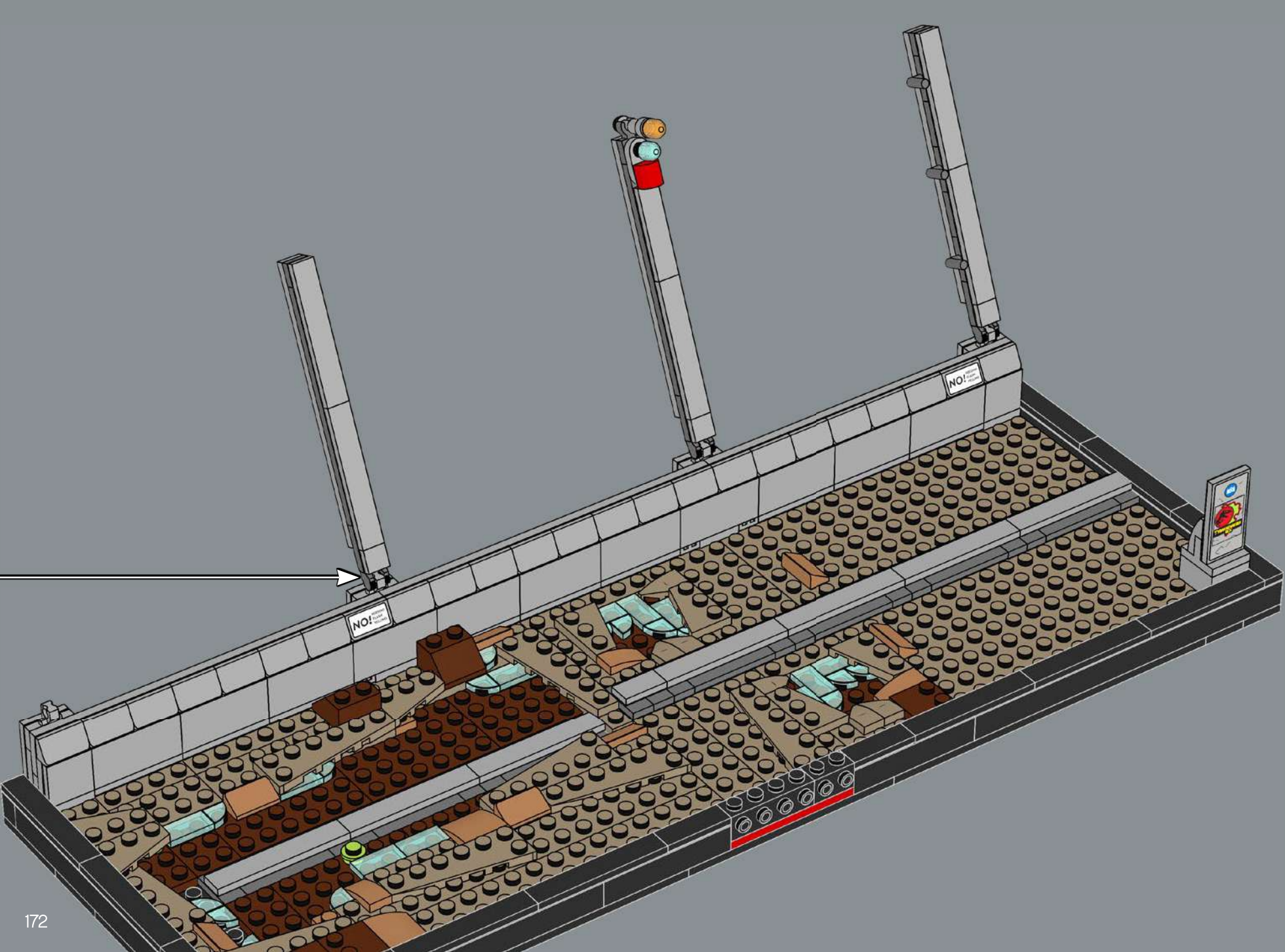

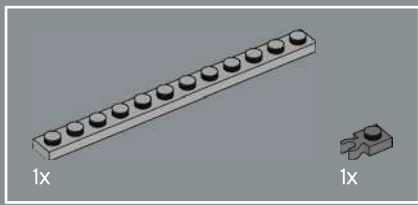

73

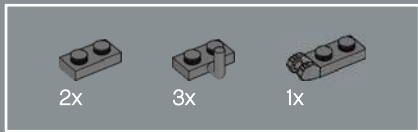
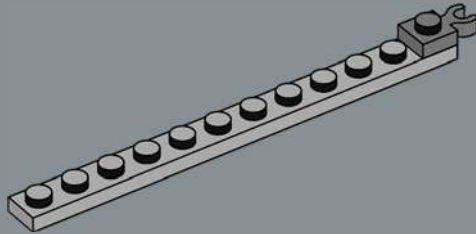

74

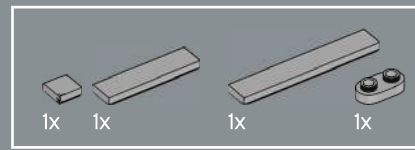
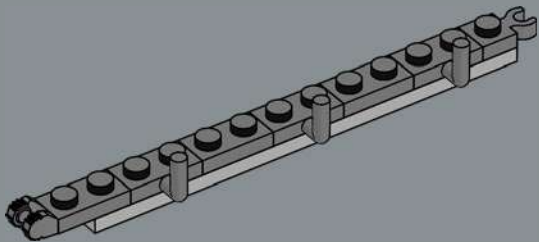

75

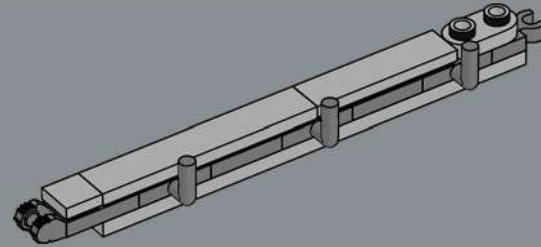

76

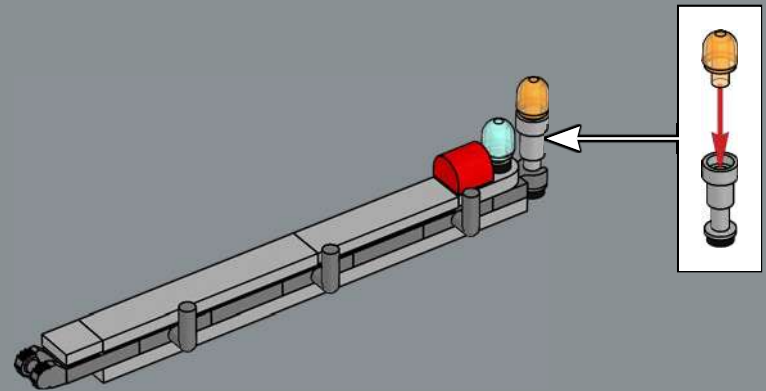

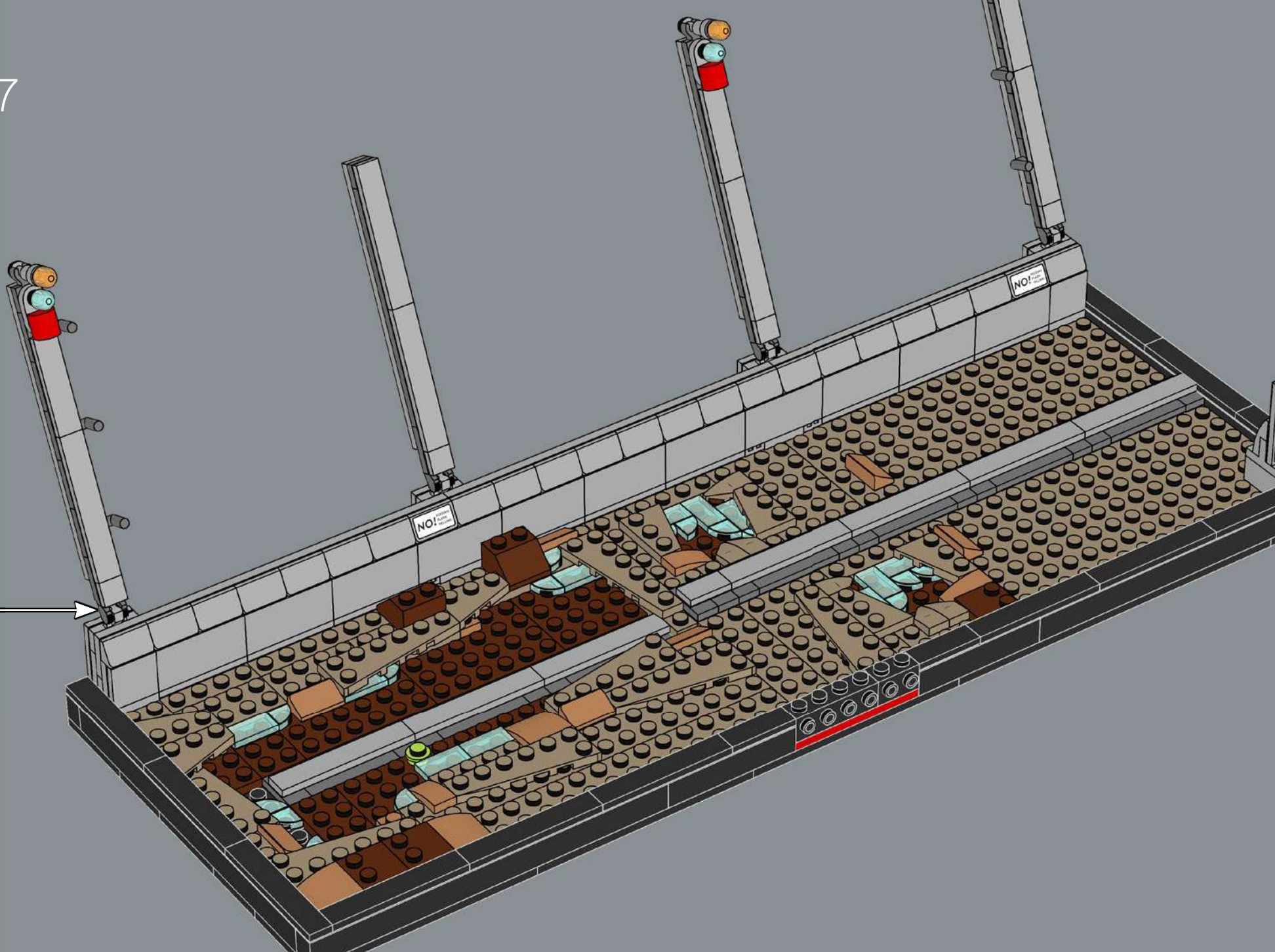

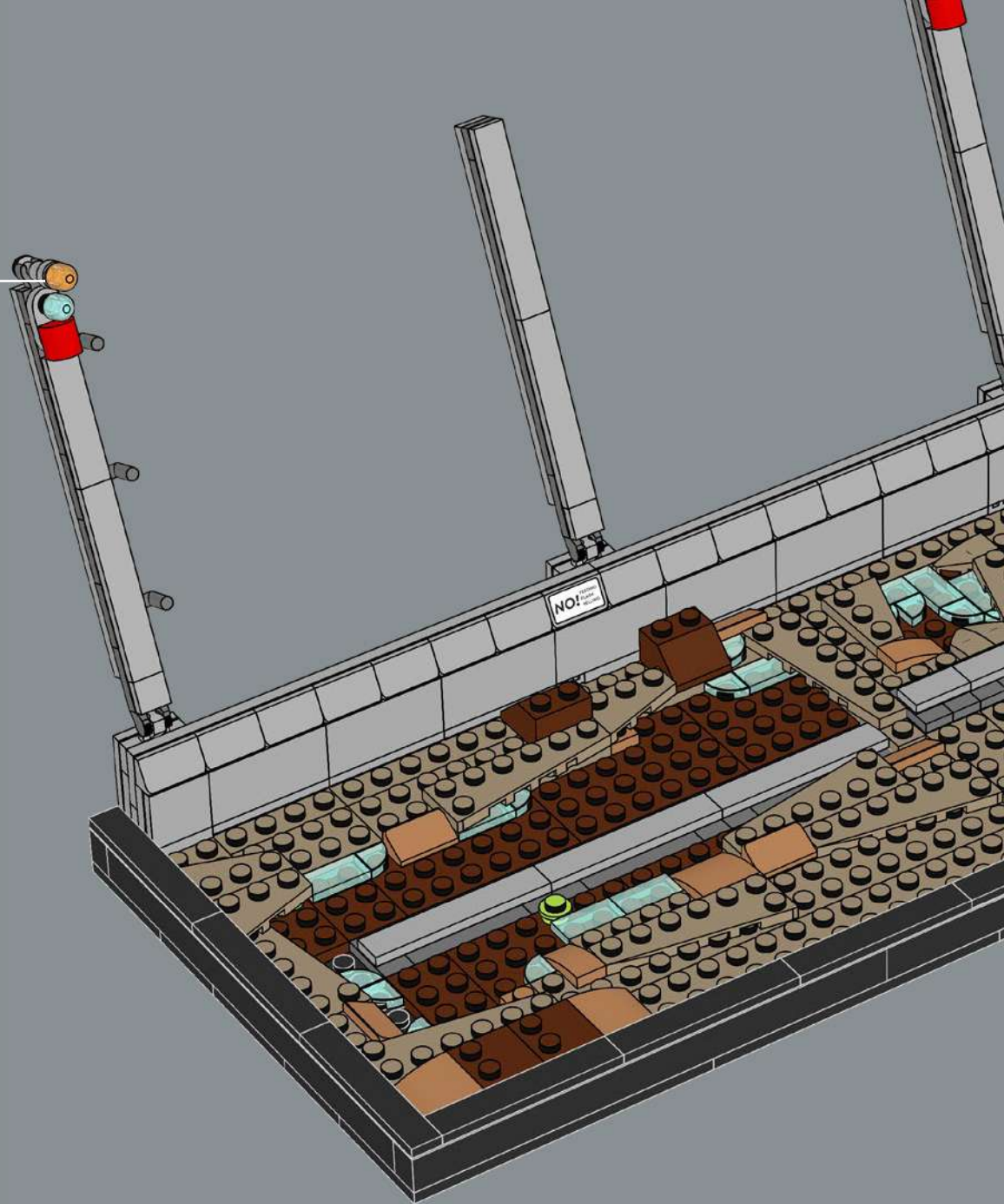
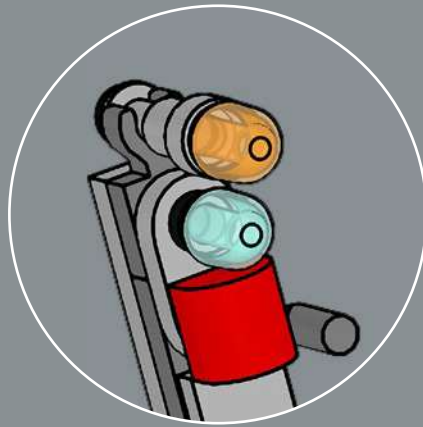

LIGHTS, DINOSAURS, ACTION...

If you happen to be climbing the fence (we don't recommend it) then beware the flashing blue light – it means the power is coming back online. 1 – 2 – 3 ... jump!

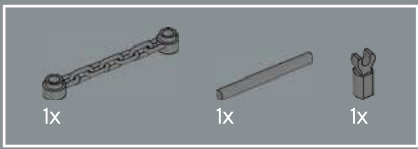

78

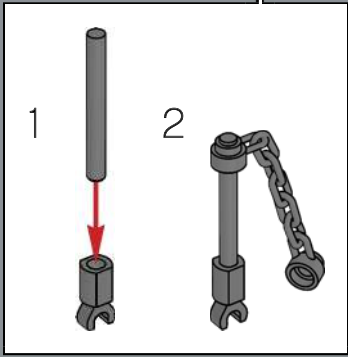
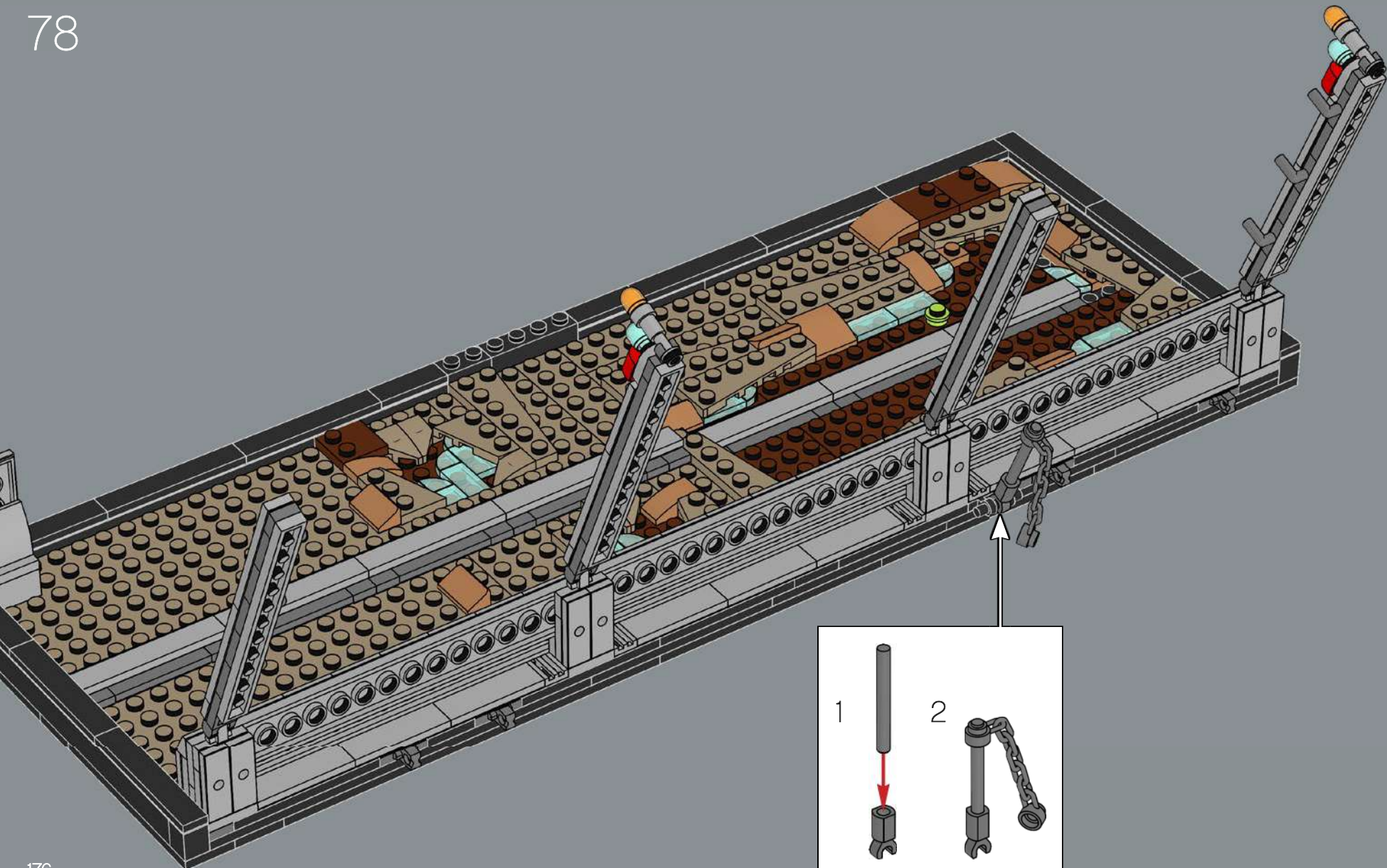



"WHERE'S THE GOAT?"

We could have sworn there was a goat here a moment ago?
Hmmm ... We're sure there's a logical and not terrifying reason for
its sudden disappearance which doesn't result in goat remains
landing on top of our car...

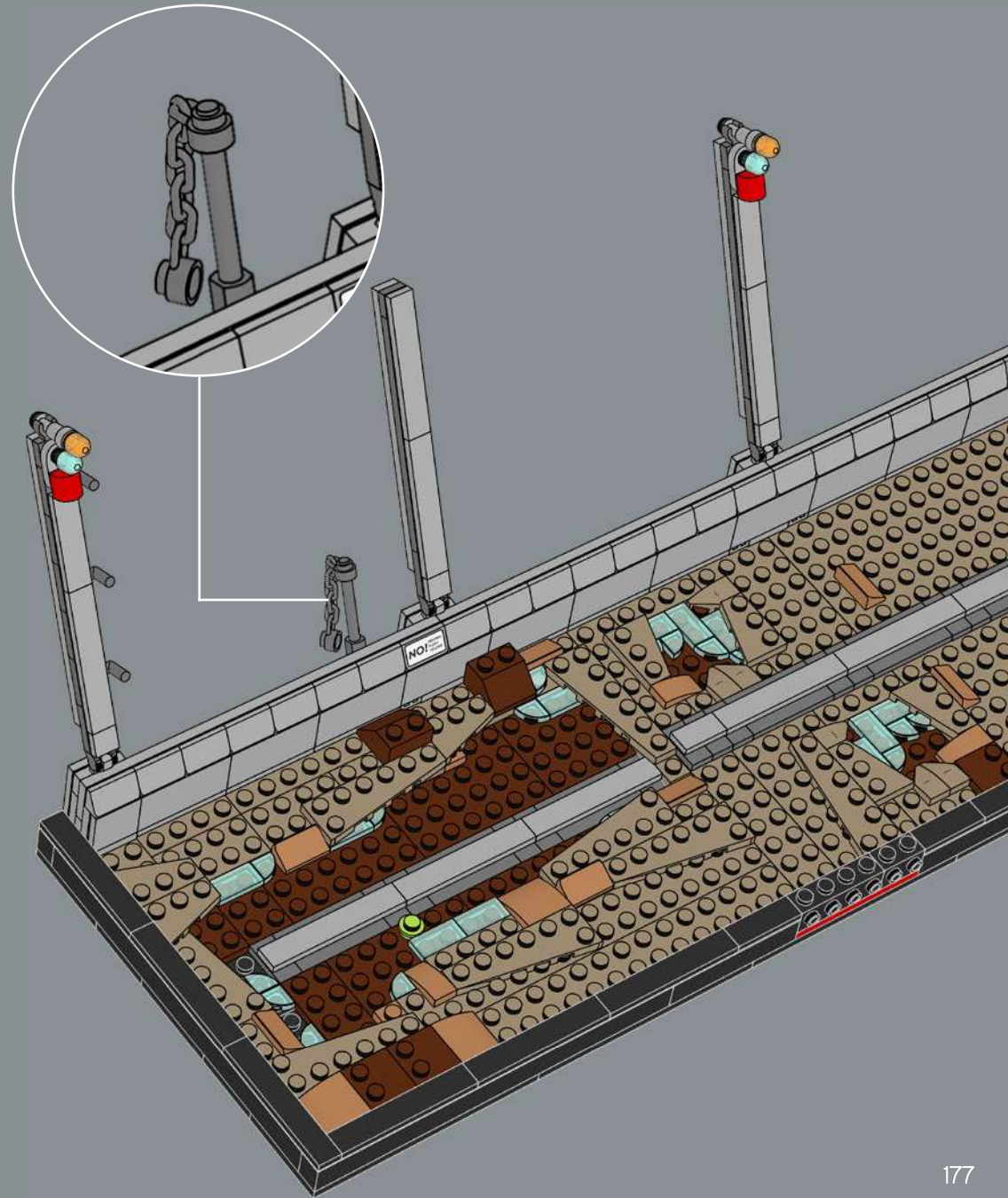

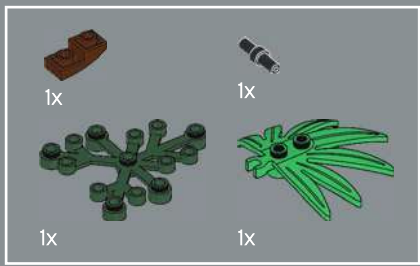

79

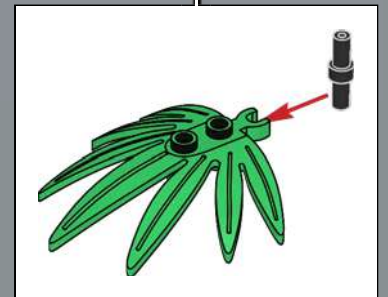
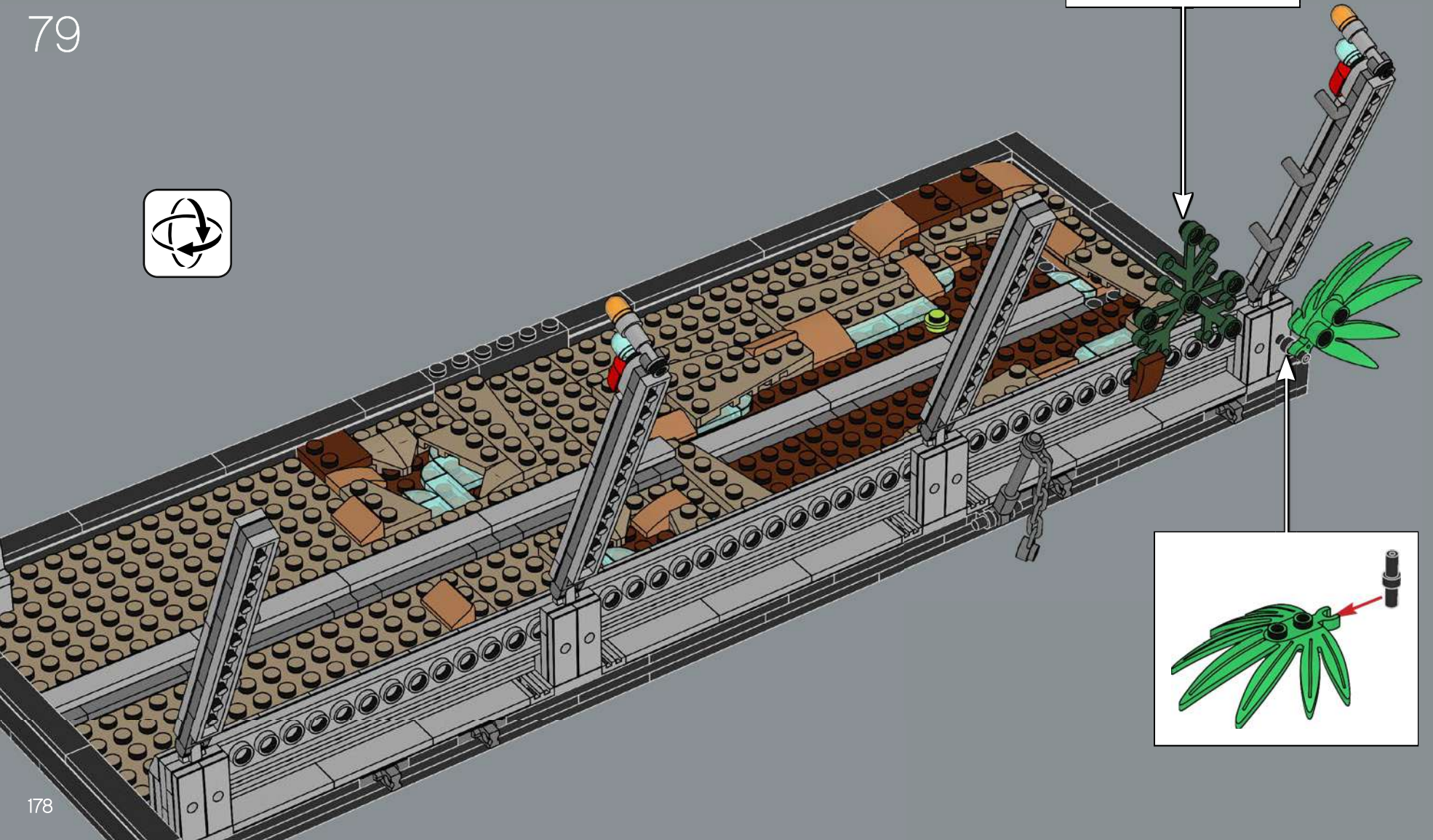
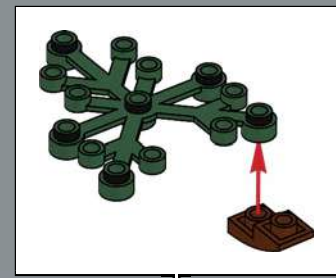

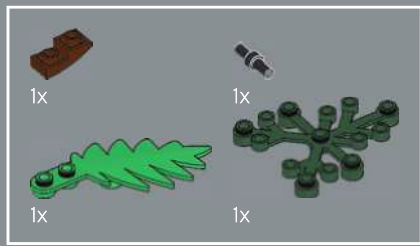

80

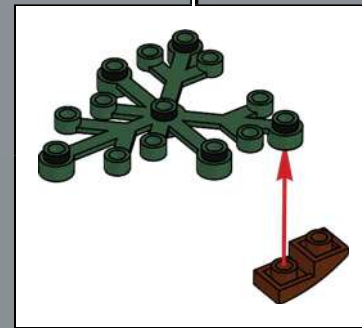
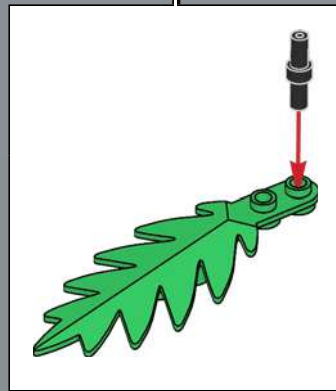
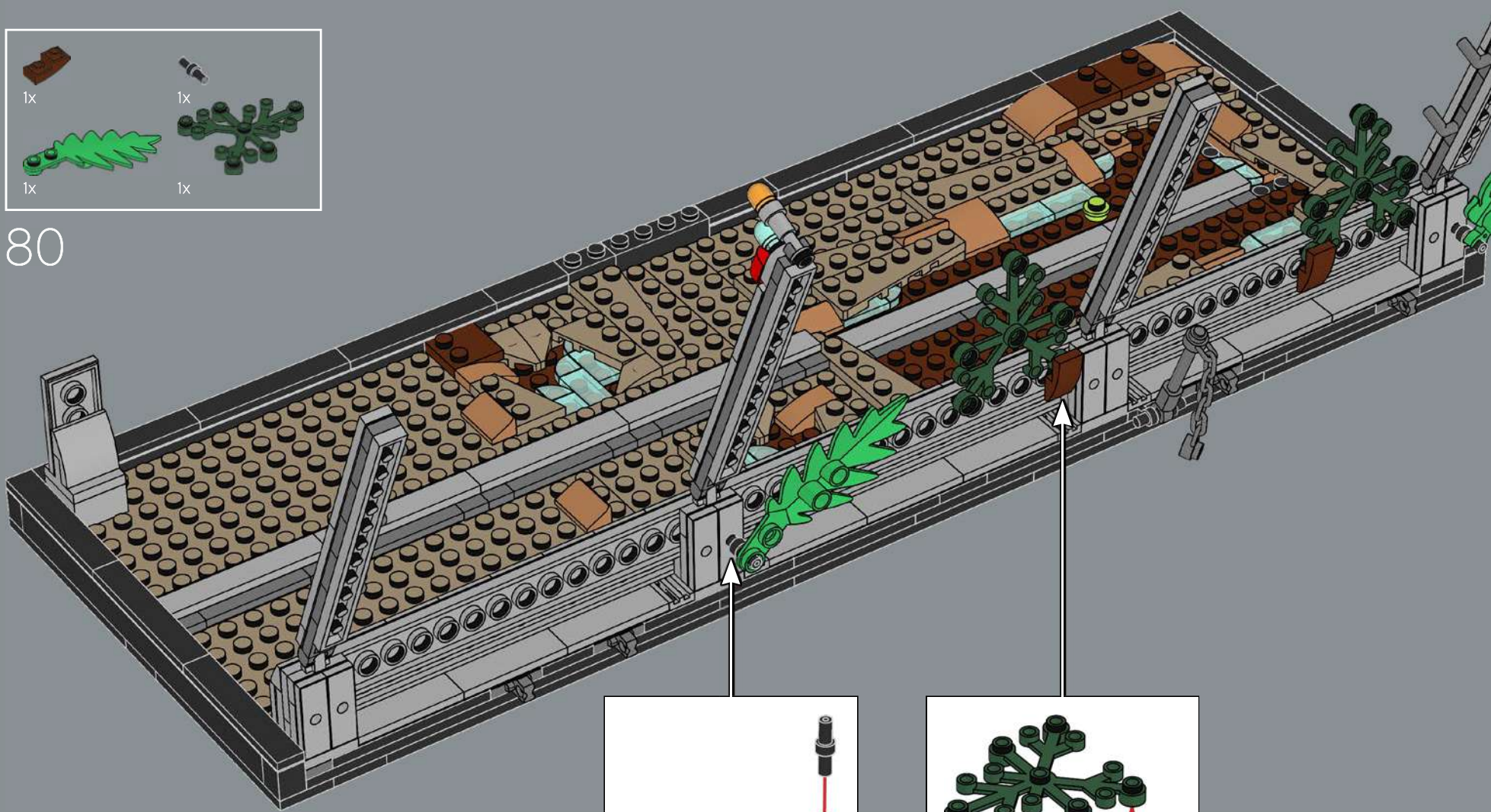

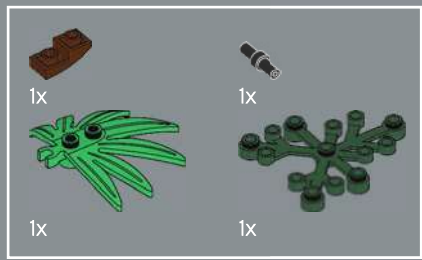

81

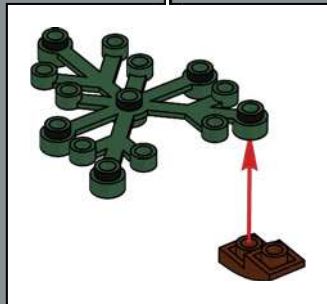
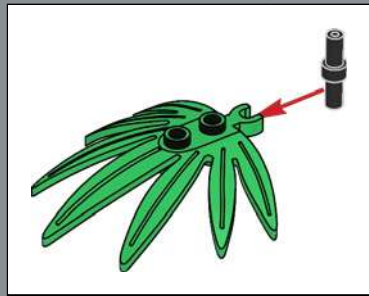
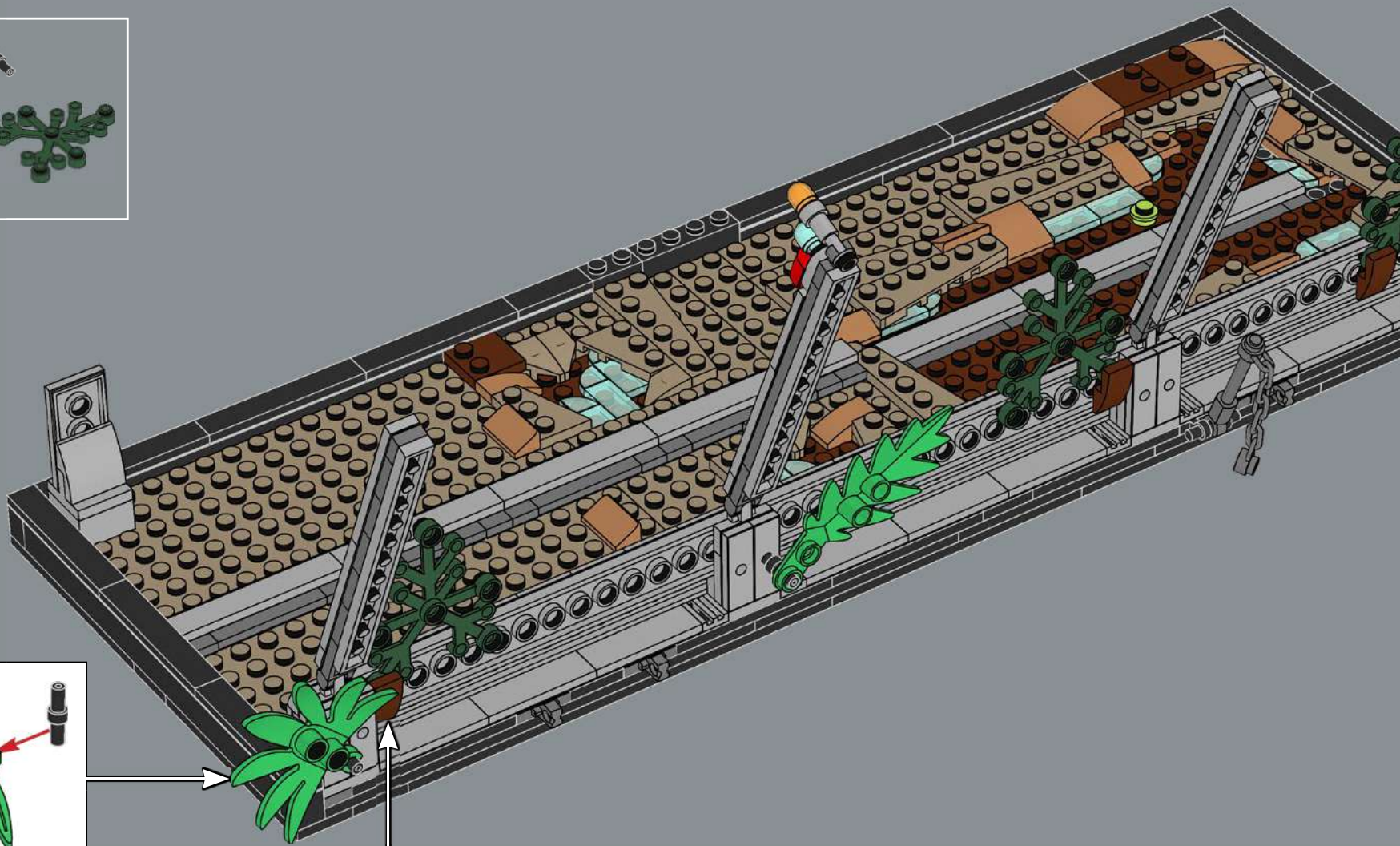

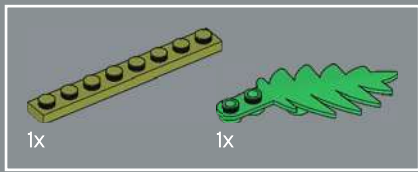

82

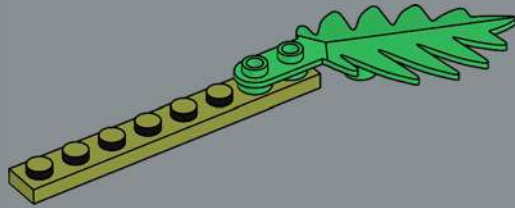

83

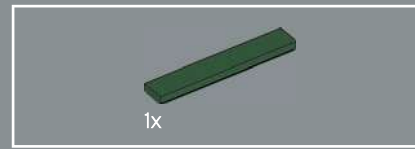
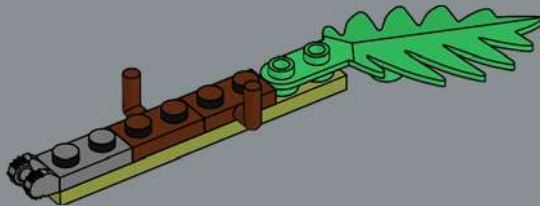

84

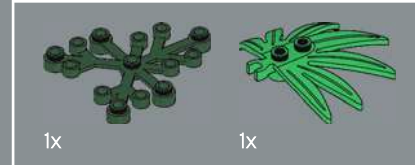
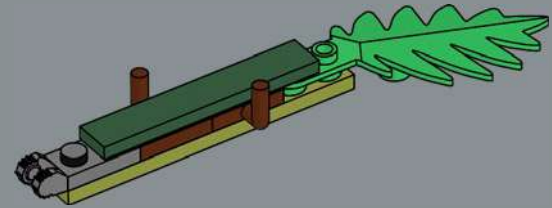

85

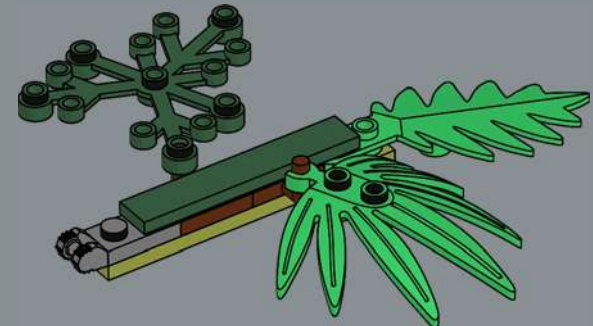

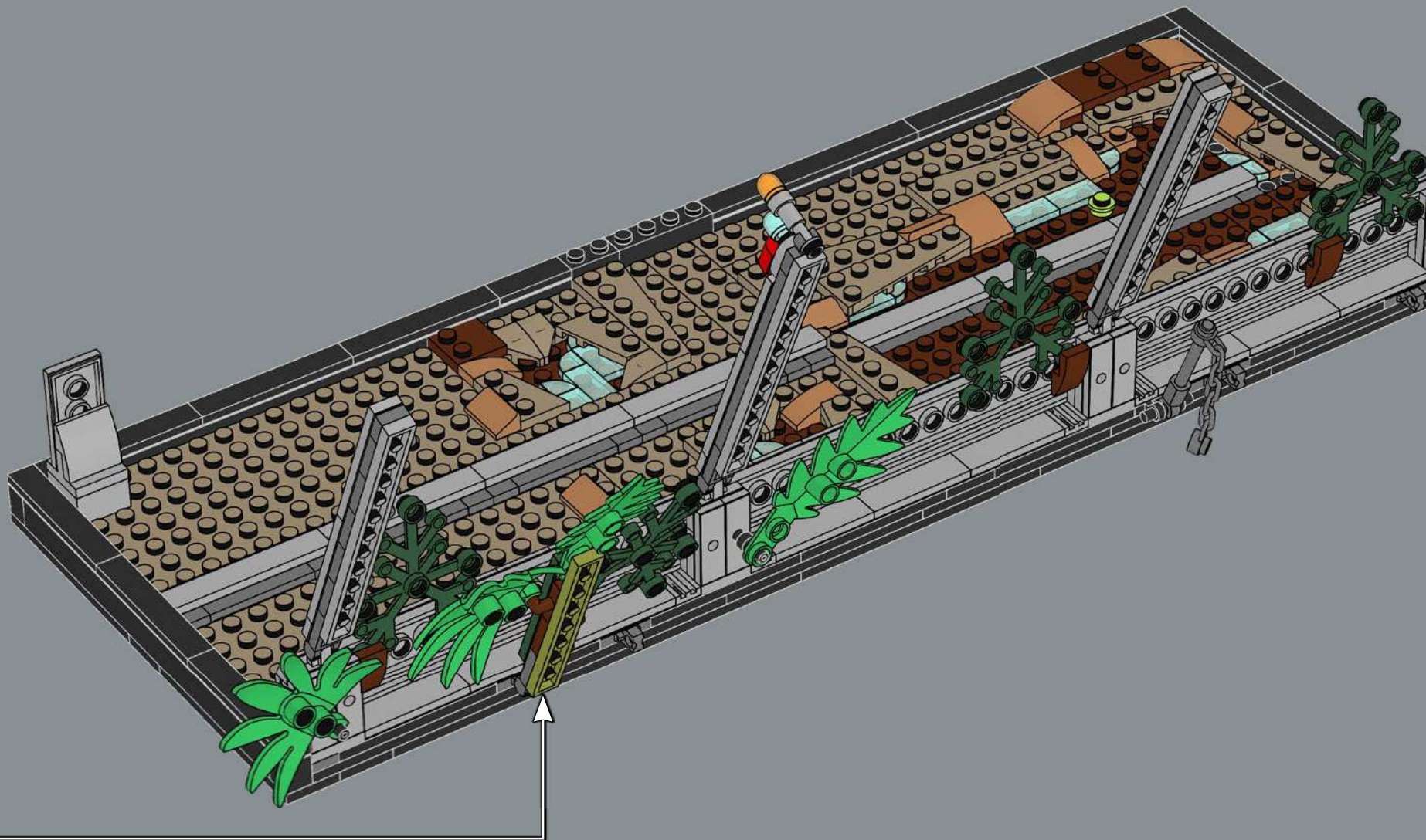

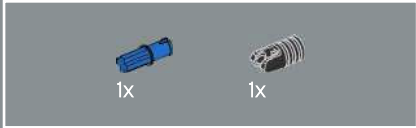

87

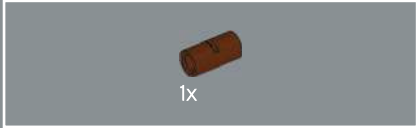
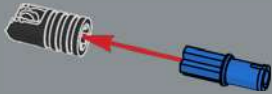

88

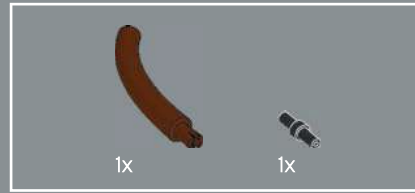

89



90

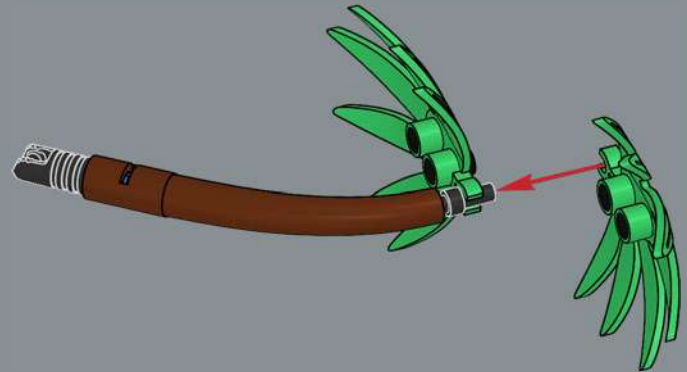



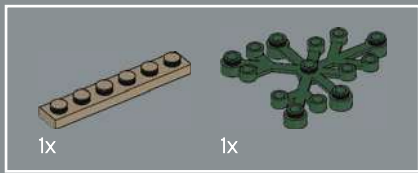

92

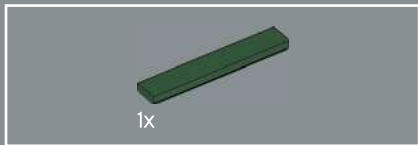
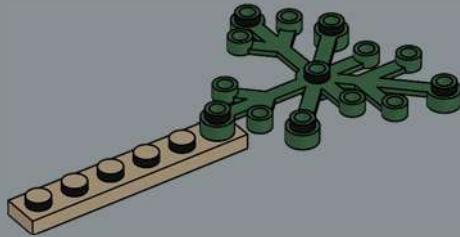

94

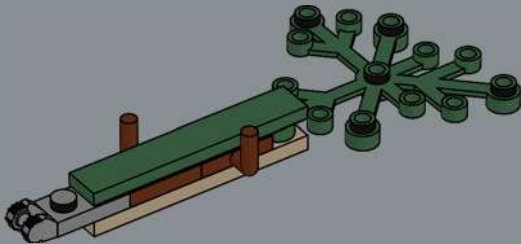

93

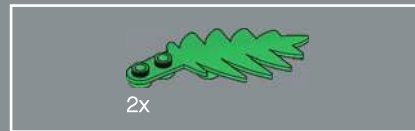
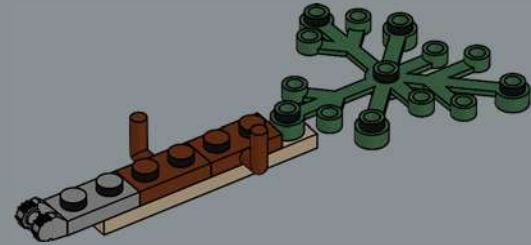

95

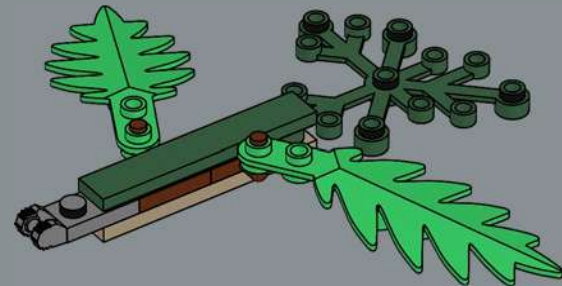

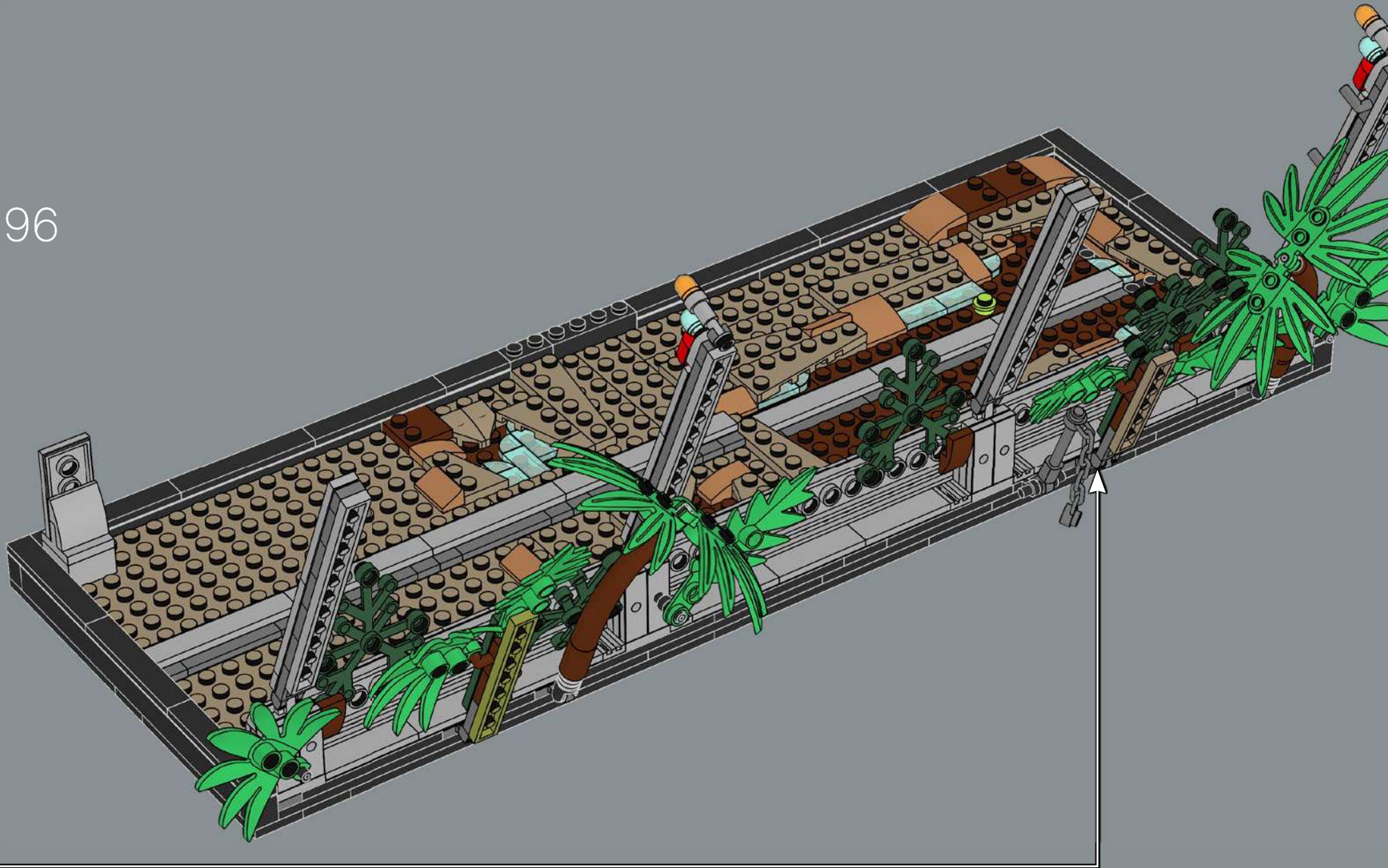

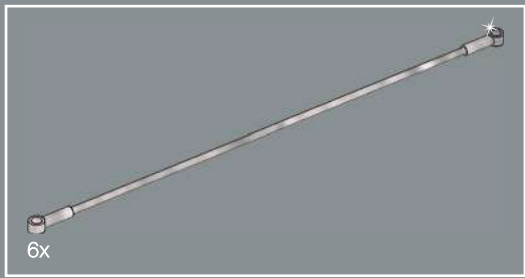

97



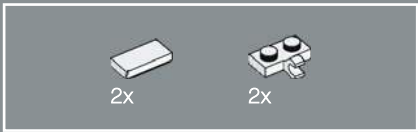

98

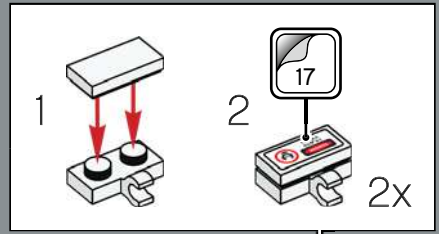



DANGER, HIGH VOLTAGE!

What a relief to know that there's a 10,000-volt fence between us and that marauding T. rex. Wait...what do you mean the power's been cut?!



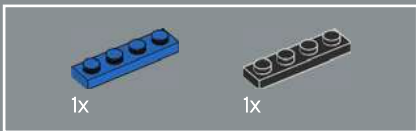
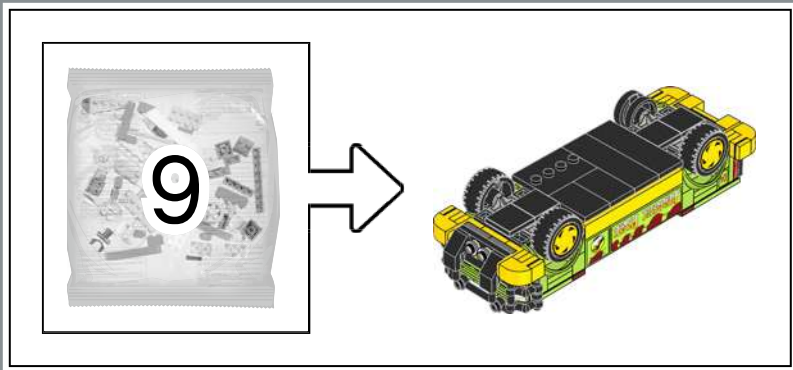

99

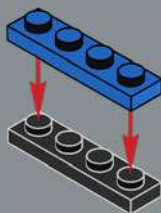

100

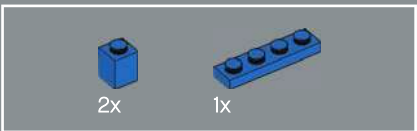
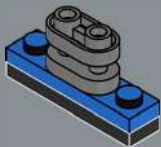

101

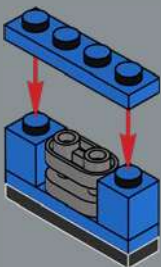

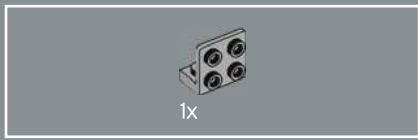

102

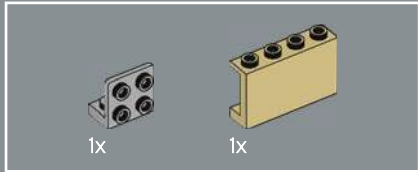
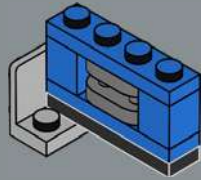

103

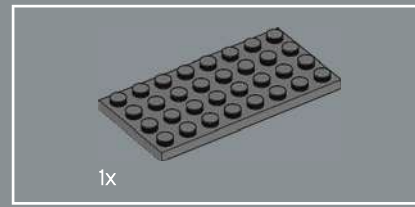
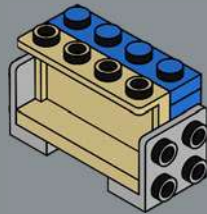

104

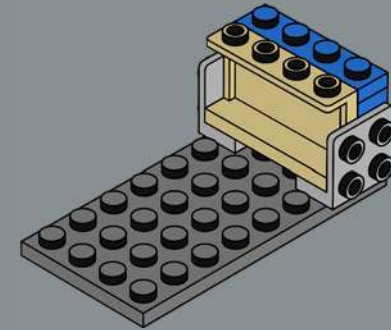

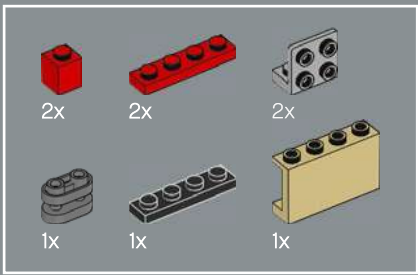

105

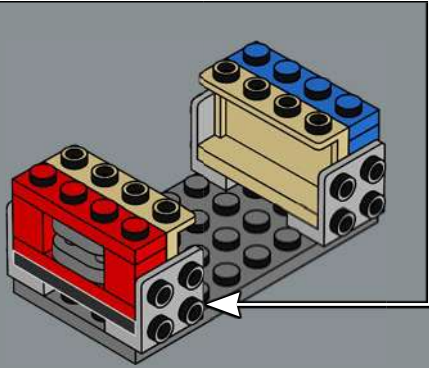
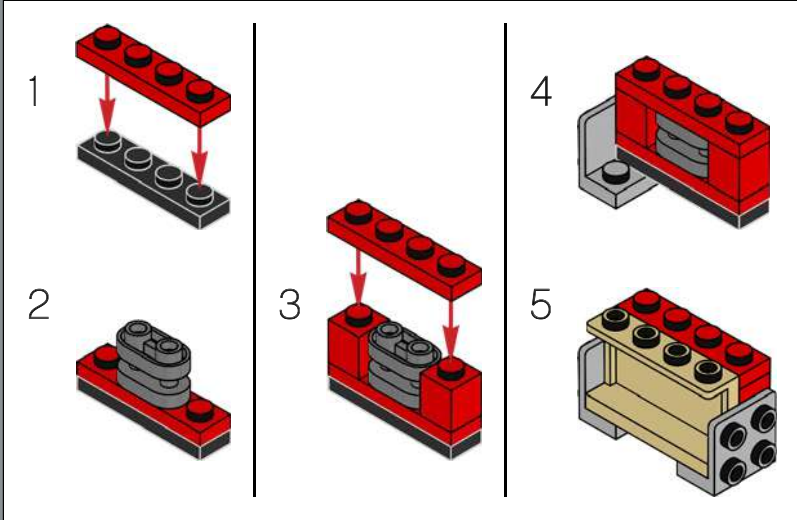

106

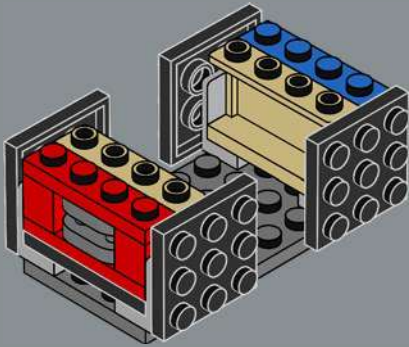

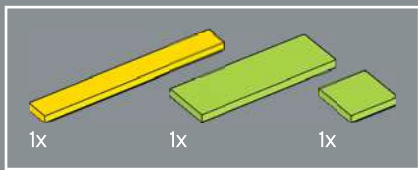

107

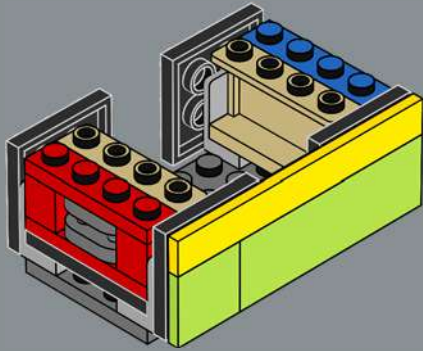

108

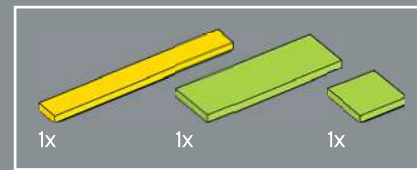
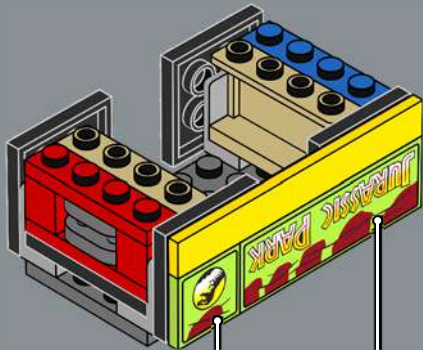

109

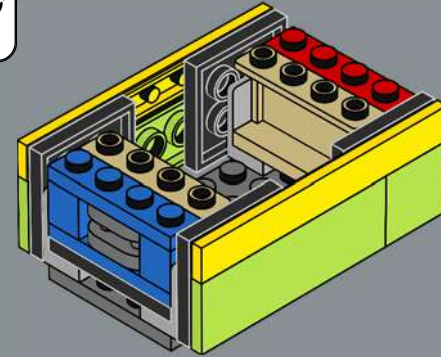

110

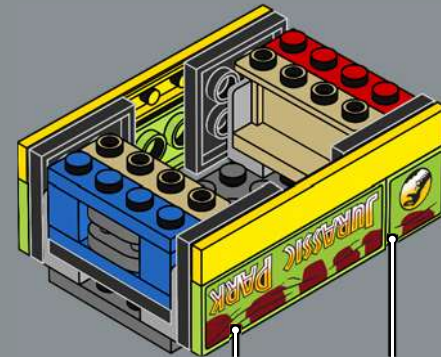

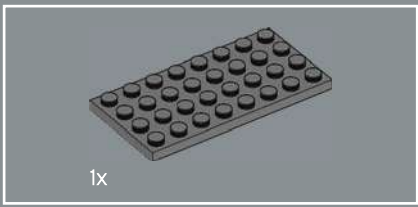

111

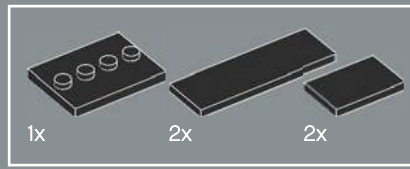
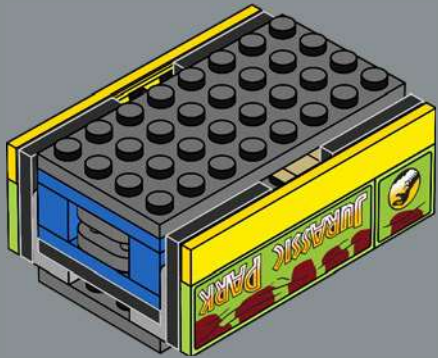

112

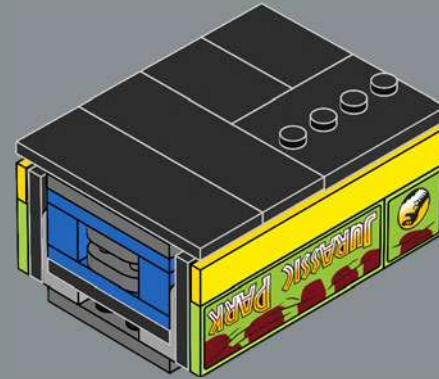

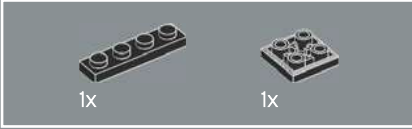
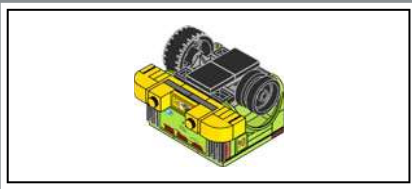

113

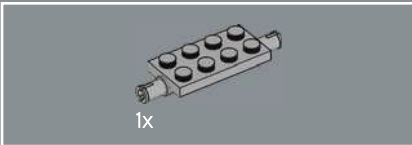
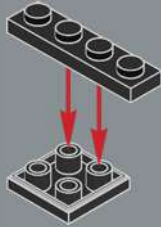

114

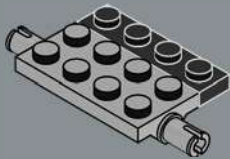

115

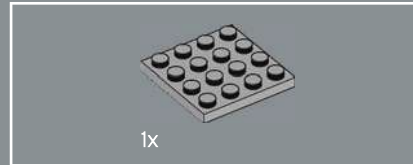
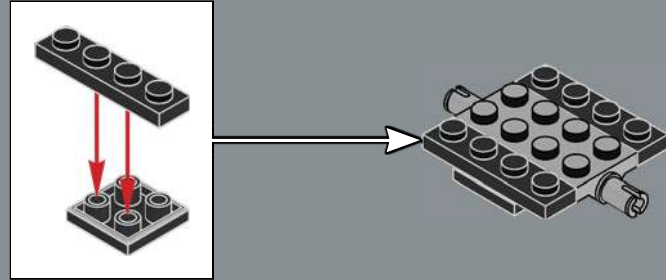

116

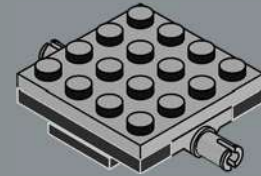

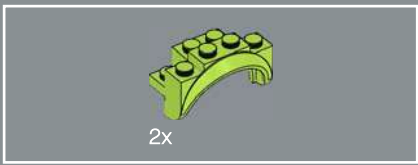

117

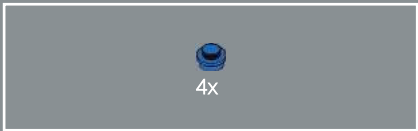
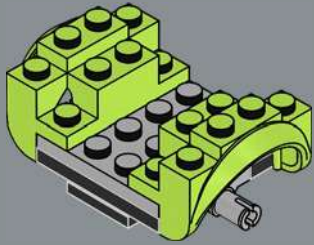

118

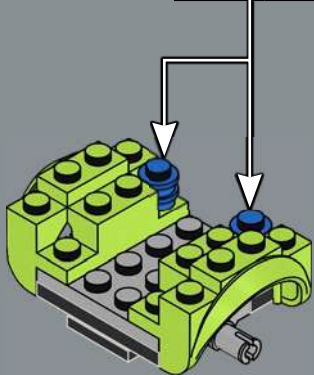
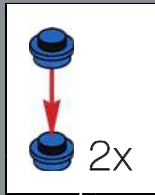

119

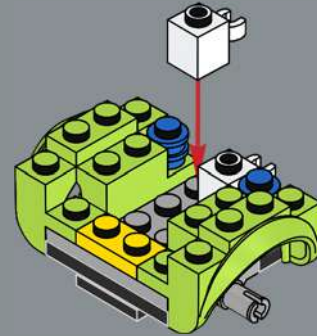

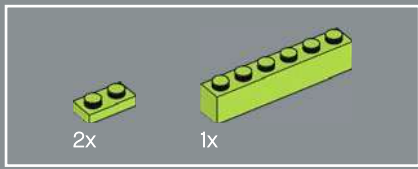

120

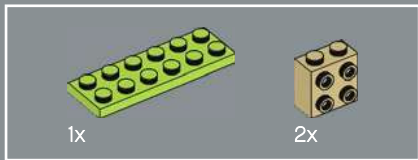
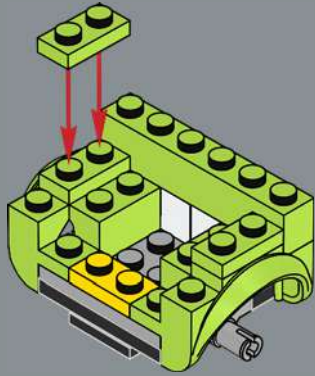

121

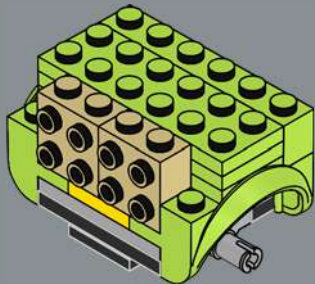

122

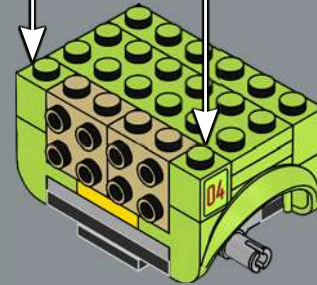
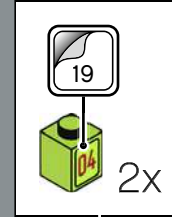

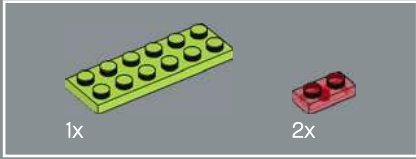
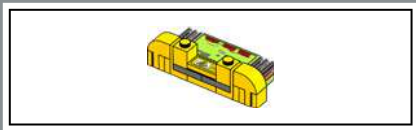

123

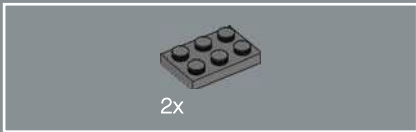
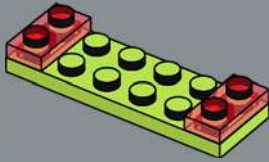

124

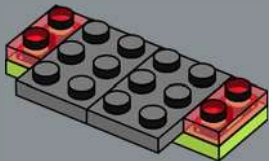

125

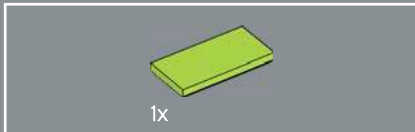
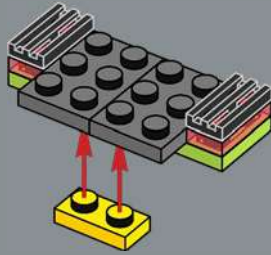

126

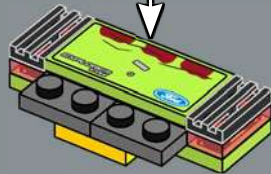
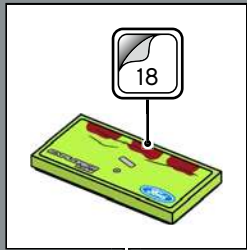



127

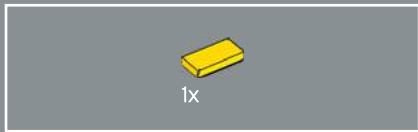

128

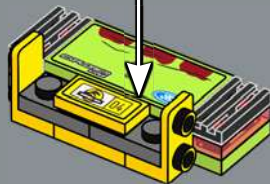

129



130

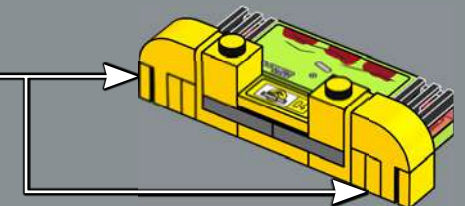
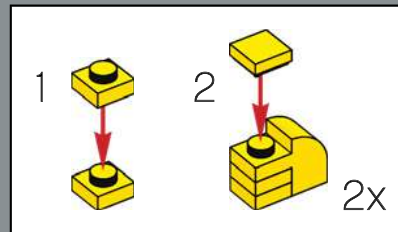

131

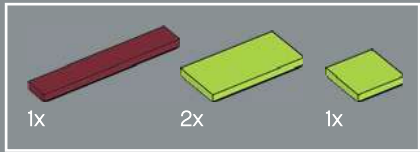
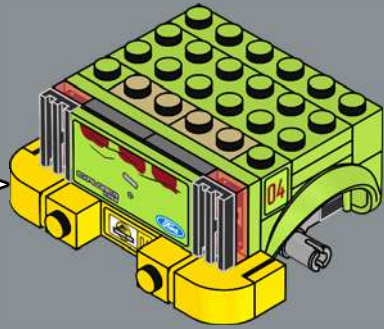

132

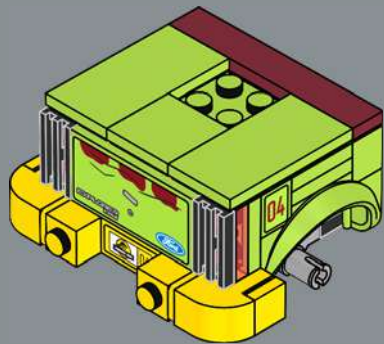

133

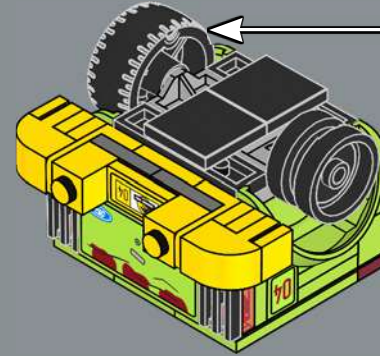

134

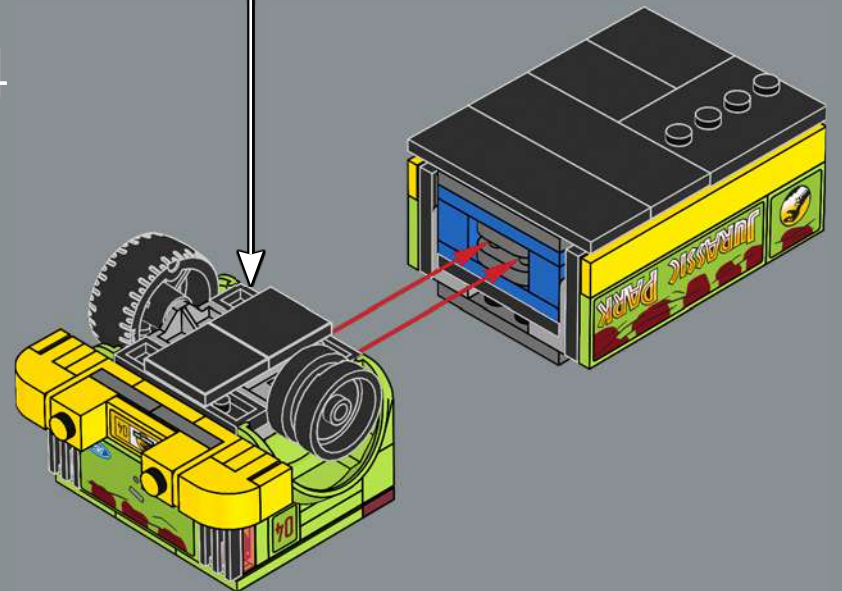

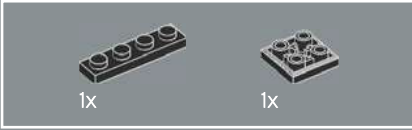
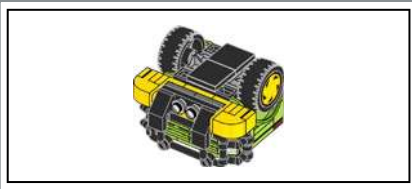

135

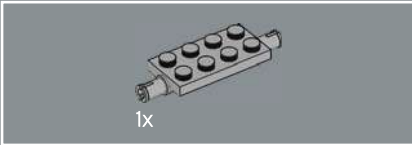
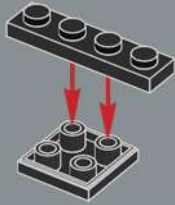

136

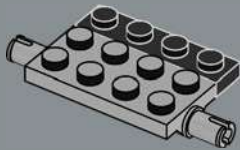

137

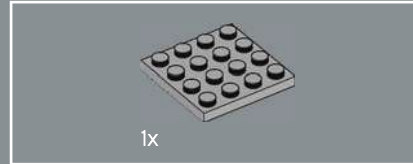
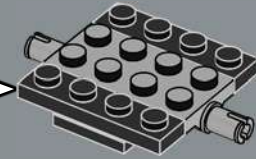
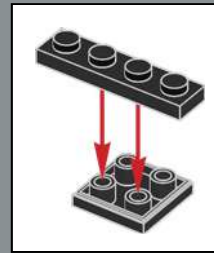

138

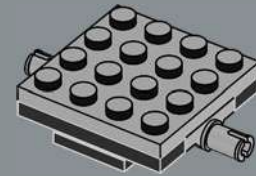

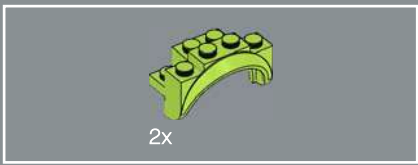

139

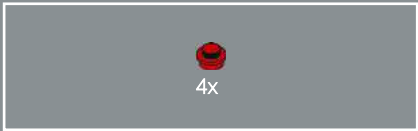
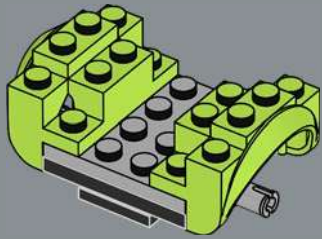

140

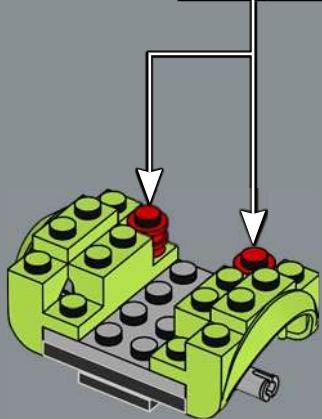
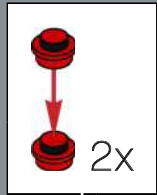

141

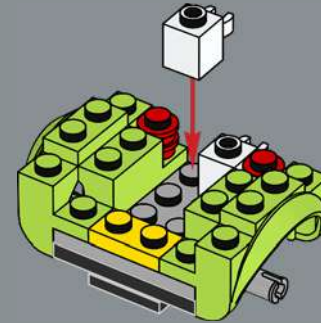



142

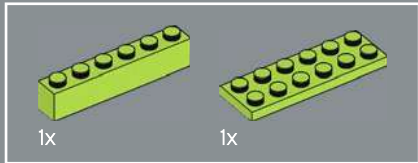
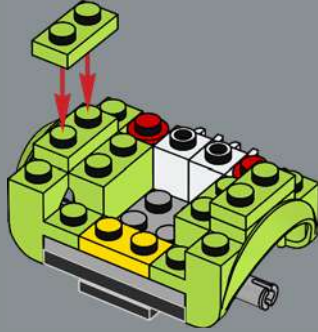

143

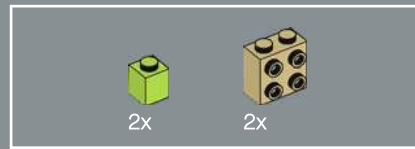
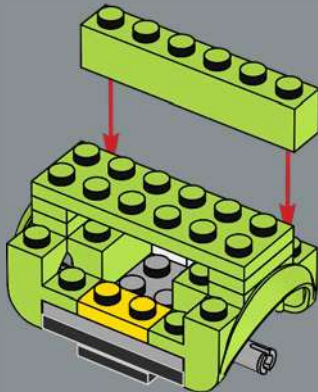

144

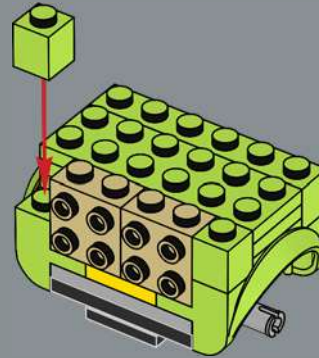

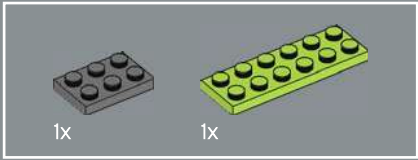
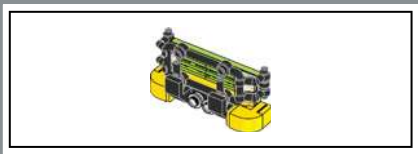

145

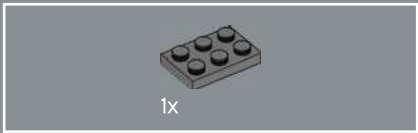
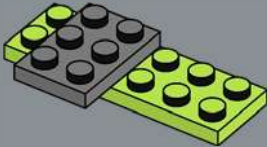

146

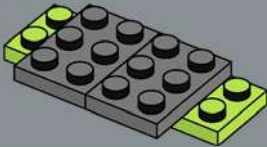

147

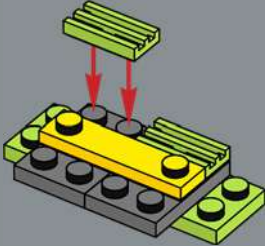

148

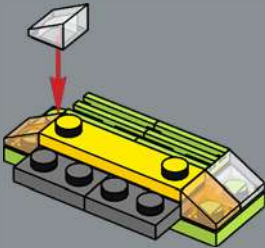

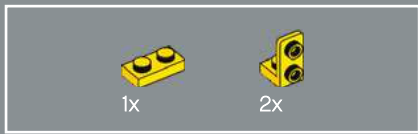

149

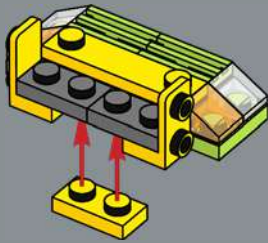

150

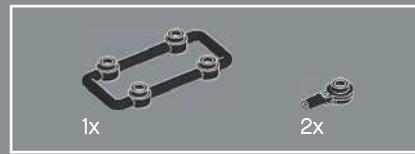

151

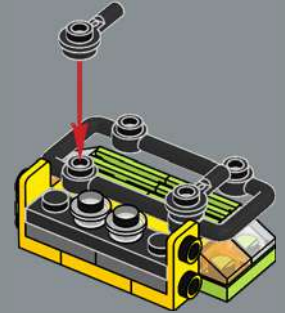

152

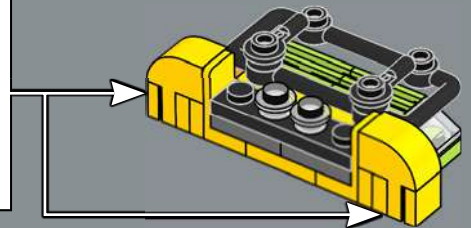
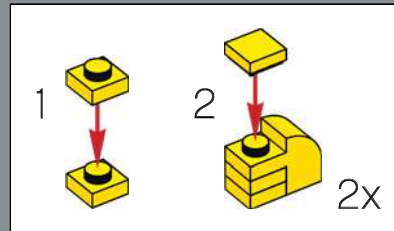



153

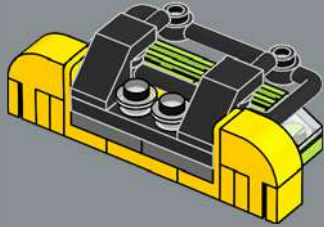

154

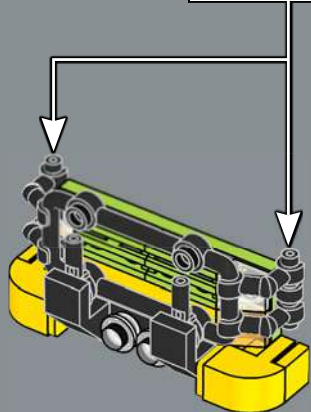
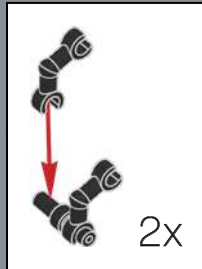

155

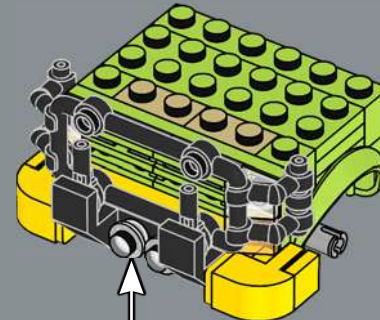

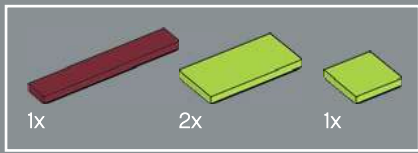

156

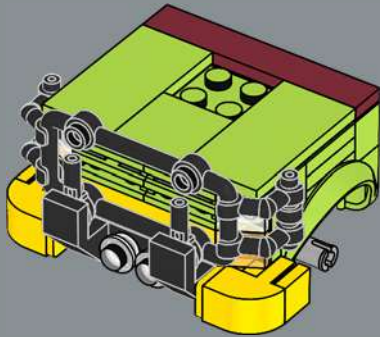

157

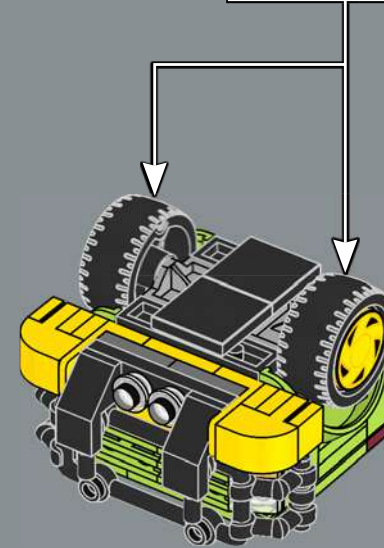
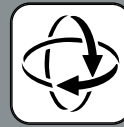

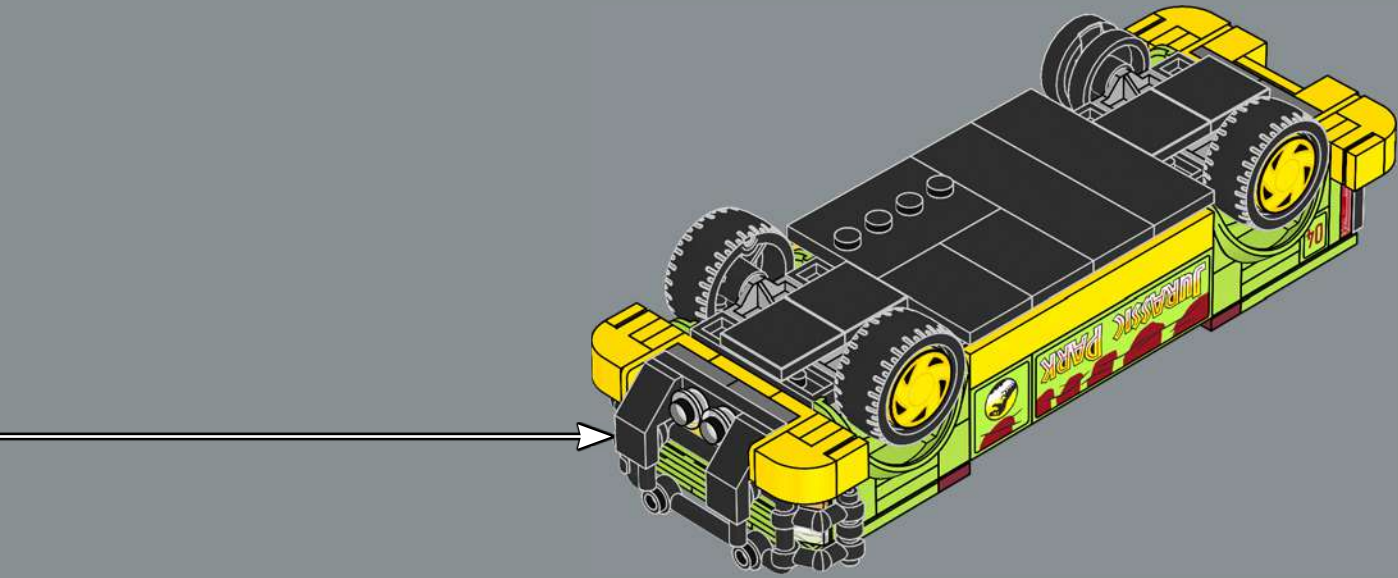

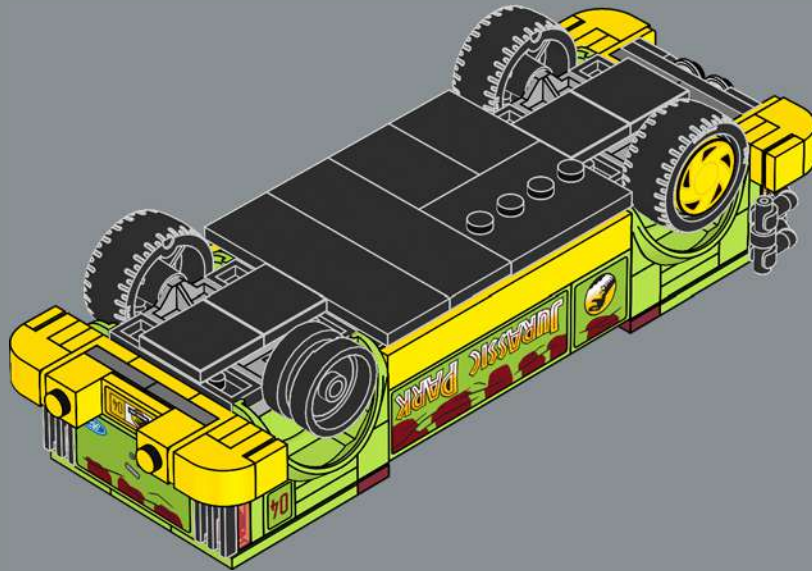

WHERE'S MY WHEEL?

Hmmm, we seem to be missing a tyre? Don't blame us, blame the hungry T. rex who mistook it for a tasty treat...

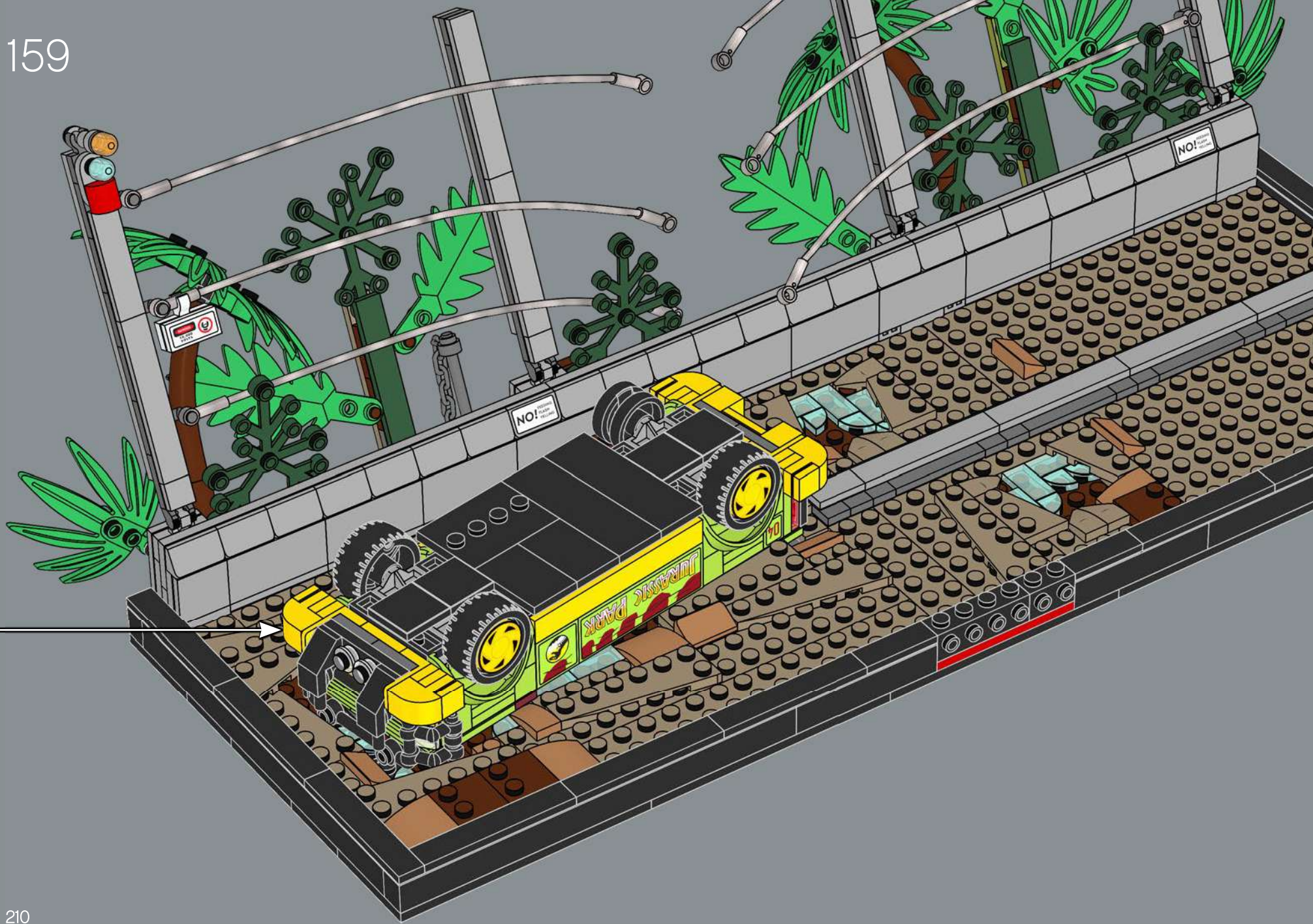



SEE YOU ON THE FLIP SIDE...

Just when you think your day can't get any worse, a T. rex flips your Ford Explorer onto its roof and stomps you into thick, oozing mud. It's going to take a miracle (or a brave man with a flare) to save you now...

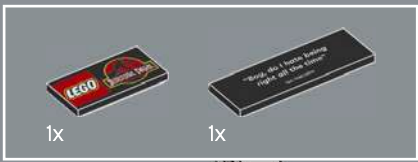

1x

1x

160



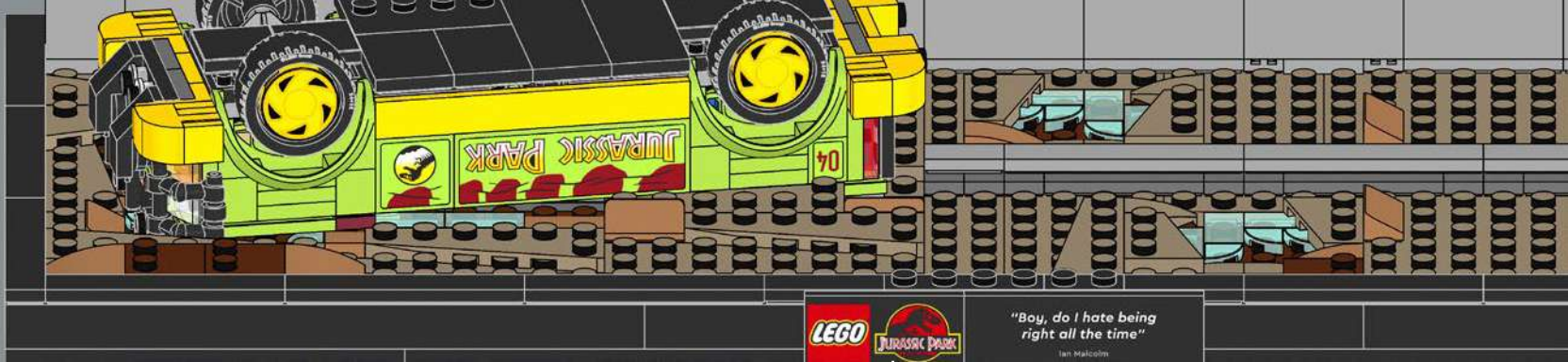

"Boy, do I hate being right all the time"
Ian Malcolm



"Boy, do I hate being right all the time"
Ian Malcolm



SARCASTIC PARK

Wherever a grave and serious situation unravelled (which was most of the time), Dr. Ian Malcolm could be relied upon for a well-timed sarcastic quip. Having forewarned park owner John Hammond about the dangers of keeping dinosaurs in captivity, he couldn't resist delivering this famous quote as the T. rex strode through the barrier and out of captivity...

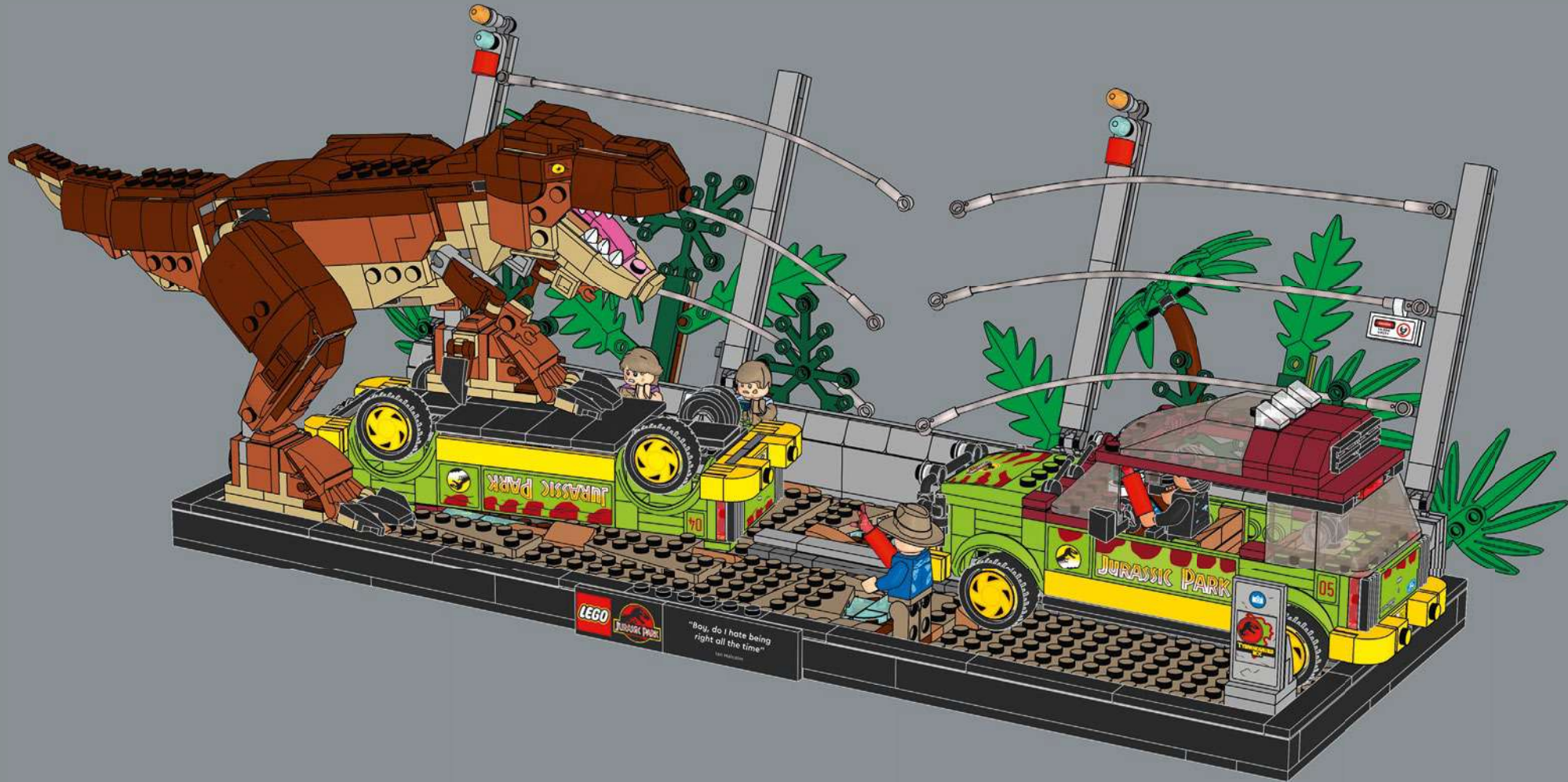



- 2x 6186681
- 4x 6321349
- 2x 306901
- 2x 6313115
- 6x 6046381
- 2x 300301
- 1x 303401
- 3x 4125253
- 3x 6360078
- 4x 4159553
- 2x 6145570
- 2x 6175968
- 10x 6374151
- 1x 6365720
- 8x 6347292
- 1x 4213568
- 1x 6228984
- 1x 6138230
- 2x 4278422
- 1x 6024495
- 3x 4114026
- 2x 6046922
- 1x 6251252
- 1x 4109995
- 4x 6092587
- 4x 6214334
- 12x 6174925
- 2x 6313611
- 4x 6253003
- 2x 4160483
- 1x 6374166
- 4x 4114084
- 1x 4114322
- 2x 6265572
- 2x 6132769
- 6x 4121921
- 10x 4118790
- 8x 6273851
- 2x 4550324
- 2x 6195544
- 2x 6375375
- 2x 6115031
- 2x 4208072
- 2x 6122047
- 1x 6294227
- 1x 4243824
- 6x 6156462
- 1x 6093864
- 1x 6189191
- 2x 6348148
- 4x 614121
- 2x 302421
- 2x 300521
- 2x 6278441
- 1x 403221
- 1x 6019155
- 2x 371021
- 2x 302021
- 1x 366621
- 4x 614123
- 2x 302423
- 2x 300523
- 2x 4206482
- 1x 6189191
- 2x 302223
- 1x 6395398
- 2x 371023
- 4x 300524
- 8x 307024
- 8x 302424
- 8x 6330893
- 7x 6324683
- 1x 6401208
- 2x 306924
- 1x 241224
- 8x 6361082
- 4x 302324
- 2x 242024
- 1x 6257598
- 2x 302024
- 4x 4189400
- 2x 73587
- 23x 614126
- 1x 6203937
- 3x 6181720
- 1x 407026
- 2x 4504382
- 2x 300526
- 9x 6371584
- 2x 6234695
- 1x 473326
- 1x 6055640
- 3x 6181713
- 4x 6196548
- 1x 4537551
- 8x 6326681
- 3x 4253815
- 2x 6271535
- 1x 9339
- 1x 6266207
- 2x 6047276
- 6x 241226
- 1x 73081
- 4x 302326
- 4x 6267487
- 1x 6138173
- 8x 6016172
- 1x 4140588
- 1x 6266224
- 1x 6290263
- 4x 302226
- 4x 6013867
- 4x 362326
- 2x 4558170
- 1x 6395640
- 7x 6336858
- 2x 6162892
- 7x 302126
- 1x 4162443
- 7x 371026
- 7x 6174917
- 2x 302026
- 1x 6324684
- 1x 300126
- 1x 6296186
- 1x 6076678
- 2x 6172984
- 5x 366626
- 2x 300926
- 12x 663626
- 1x 6324685
- 2x 6318582
- 8x 303426
- 2x 6161298
- 8x 303026
- 4x 246526
- 3x 428226
- 1x 6397677
- 7x 6313099
- 1x 379528
- 4x 6269040
- 4x 4666322
- 2x 6143431
- 4x 6228968
- 2x 6340735

2x 6373105
2x 6373104
2x 6360215
2x 6360214
2x 6188477
2x 6228840
4x 6396922
4x 6186009
2x 6396924
2x 4579659
4x 6104344
4x 4615606
2x 6341393
2x 6253425

2x 6396923
2x 6058089
8x 6240030
7x 6245250
2x 6392889
5x 6240212
2x 6171877
2x 6283590
18x 6396287
12x 6251295
1x 4159007
1x 4158355
1x 6240515
2x 6253217
1x 6287677

1x 6245192
1x 6255921
3x 4183133
6x 4220634
2x 4621557
6x 6208291
8x 4164037
4x 6263442
6x 4518611
2x 4537937
3x 6264064
10x 4210210
6x 6212989

8x 6392884
2x 4537919
4x 6392888
5x 4621548
1x 6146890
3x 6258951
1x 4557944
4x 6002843
3x 6258949
1x 6395408
4x 6002847
2x 6016059
23x 4528604

1x 6395371
1x 4524098
10x 4267874
7x 6015424
4x 6385280
4x 6385281
1x 4550329
2x 6001001
4x 6316277
1x 4613196

2x 4539114
7x 4550169
1x 6360079
1x 6396926
2x 6251611
1x 6092597
4x 6267498
1x 4539105
2x 6359716
1x 4539071
2x 4539062
3x 4650865
2x 4618986
1x 6389824

2x 6216880
5x 6266967
2x 6171764
4x 6245265
1x 4216581
1x 6328180
5x 4211288
6x 6290397
2x 4504376
1x 6062574
4x 6149677
2x 6253167
5x 6153863
6x 6290396
1x 6223599
1x 4211149

7x 6261744
12x 6069984
4x 6248854
3x 6172922
4x 6261359
2x 6173132
1x 4211199
16x 6117976
2x 6226436
8x 4645103
15x 6146858
5x 4271949
3x 6196221
4x 6221608
2x 6167644
2x 4211210

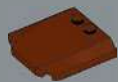

2x
6392880



4x
4211247



2x
4585337

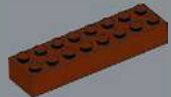

1x
6096701



8x
4217848



3x
4211214



Customer Service
Kundenservice
Service Consommateurs
Servicio Al Consumidor

LEGO.com/service or dial



00800 5346 5555 :

1-800-422-5346 :



3x
4211202



1x
6146301



2x
6326087



1x
4211189



9x
4211190



2x
4658005



2x
6153594



12x
4211186



4x
4211415



2x
6248890



24x
4568637



6x
6043656



4x
6266251



4x
4211350



1x
4211414



2x
4657366



8x
4654582



4x
4654580



5x
6258820



4x
4211397



2x
4211413



2x
4211413



1x
6185676



2x
4211387



3x
6043639



8x
6251044



2x
4211356



21x
4560183



4x
4211572



13x
4211549



2x
4243797



4x
4211425



4x
4211425



4x
4514846



6x
4211486



1x
6336970



4x
4210719



2x
6390673



2x
6296892



4x
6039479



4x
6266248



16x
6092572



6x
6261355



4x
4211063



2x
4522784



5x
6123814



2x
4218696



6x
6267047



1x
6378143



4x
4211043



7x
4560184



1x
6311445

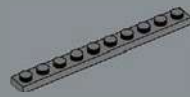

2x
4257526



2x
4211061



1x
4211122



1x
6395537



1x
6133726



1x
6132918



1x
4654128



1x
6058222



1x
6326126



1x
6326123



1x
6326121



2x
6215606



1x
6368591



4x
6380634



11x
6218358



3x
6356566



3x
6312473



1x
6177535



1x
6167699



2x
6334099



4x
6167700



2x
6175943



6x
6210590



1x
6395510



1x
6278034



1x
6278034



1x
6278034



1x
6278034



FEEDBACK AND WIN



FEEDBACK AND WIN

Your feedback will help shape the future development of this product series.

Please visit:

FEEDBACK UND GEWINNEN

Dein Feedback trägt zur Weiterentwicklung dieser Produktreihe bei.

Geh auf:

COMMENTEZ ET GAGNEZ

Vos commentaires nous aideront à concevoir les futurs produits de cette gamme.

Rendez-vous sur :

COMENTA Y GANA

Tu opinión nos ayudará a dar forma al desarrollo de esta serie de productos en el futuro.

Visita:

反馈有奖

您的反馈将有助于我们在今后改进本系列产品。

请访问：

LEGO.com/productfeedback

By completing, you will automatically enter a drawing to win a LEGO® set.

Terms & Conditions apply.

Durch Ausfüllen nimmst du automatisch an der Verlosung eines LEGO® Preises teil.

Es gelten die Teilnahmebedingungen.

En envoyant vos commentaires, vous serez automatiquement inscrit(e) à un tirage au sort qui vous permettra de remporter un prix LEGO®.

Offre soumise à conditions.

Al contestar, participarás automáticamente en el sorteo y podrás ganar un set LEGO®.

Sujeto a Términos y Condiciones.

完成我们的反馈调查，即可自动进入抽奖环节，赢取乐高®套装。

适用《条款和条件》。

LEGO and the LEGO logo are trademarks of the LEGO Group. ©2022 The LEGO Group.

© Universal City Studios LLC and Amblin Entertainment, Inc. All Rights Reserved.

Ford Motor Company Trademarks and Trade Dress used under license to the LEGO Group.

