

NEL 3-4 KG
NEL 3-4

PRODUCTION DATE

PACKING CODE

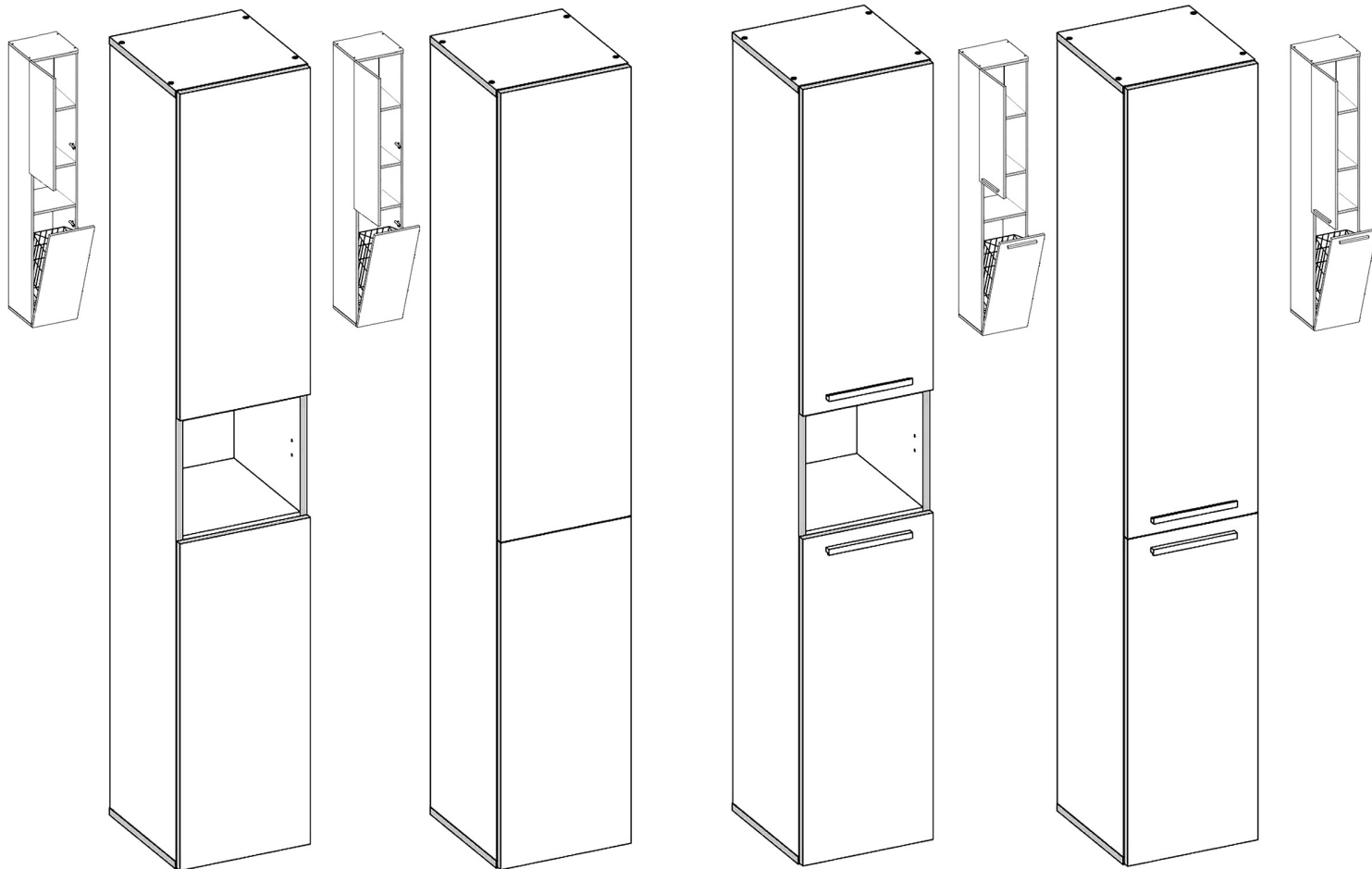

NEL 3 KG

NEL 4 KG

NEL 3

NEL 4

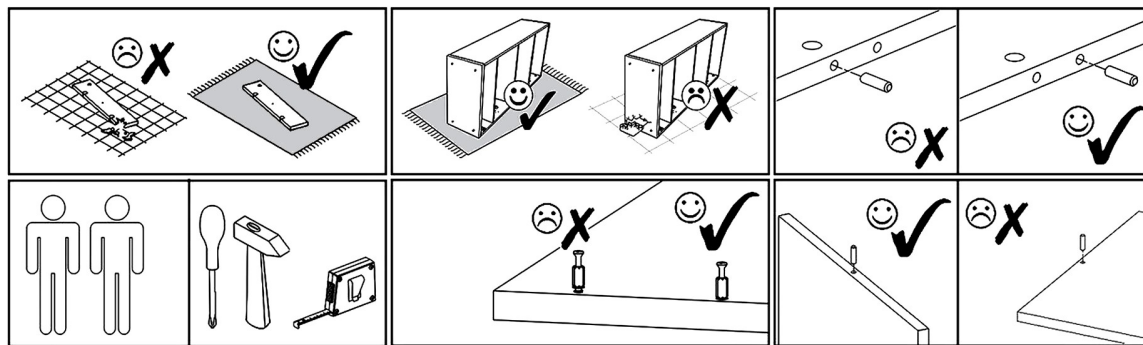

B3 NEL 3-4 KG K ø 7-8/5mm x4	B3 NEL 3-4 KG G ø 7-8/5mm x4	B3 NEL 3-4 B ø 7-8/5mm x4	B3 NEL 3-4 Ant ø 7-8/5mm x4	B3 NEL 3-4 S-A ø 7-8/5mm x4	V9 NEL 3-4 KG NEL 3-4 x1	V10 NEL 3-4 KG NEL 3-4 x4	V11 NEL 3-4 KG NEL 3-4 3,5x16mm x4
V23 NEL 3-4 KG NEL 3-4 5,5x10,5mm x2*	T1 NEL 3-4 KG NEL 3-4 x4	V35 NEL 3-4 KG NEL 3-4 x2	V26 NEL 3-4 KG NEL 3-4 x1	V16 NEL 3-4 KG NEL 3-4 5x16mm x4	V13 NEL 3-4 KG NEL 3-4 x1	U3 NEL 3-4 L=190/160mm x2	S3 NEL 3-4 4x30mm x4
Z1 NEL 3-4 KG NEL 3-4 x80	F1 NEL 3-4 KG NEL 3-4 7x50mm x8	F3 NEL 3-4 KG NEL 3-4 Hex 4mm x1	M1 NEL 3-4 KG NEL 3-4 12x15mm x8	N1 NEL 3-4 KG NEL 3-4 L=35mm x8	A1 NEL 3-4 KG NEL 3-4 ZP x4	S1 NEL 3-4 KG NEL 3-4 3,5x16mm x12*	E1 NEL 3-4 KG NEL 3-4 8x30mm x8

NEL 3-4 KG
NEL 3-4

PRODUCTION DATE

PACKING CODE

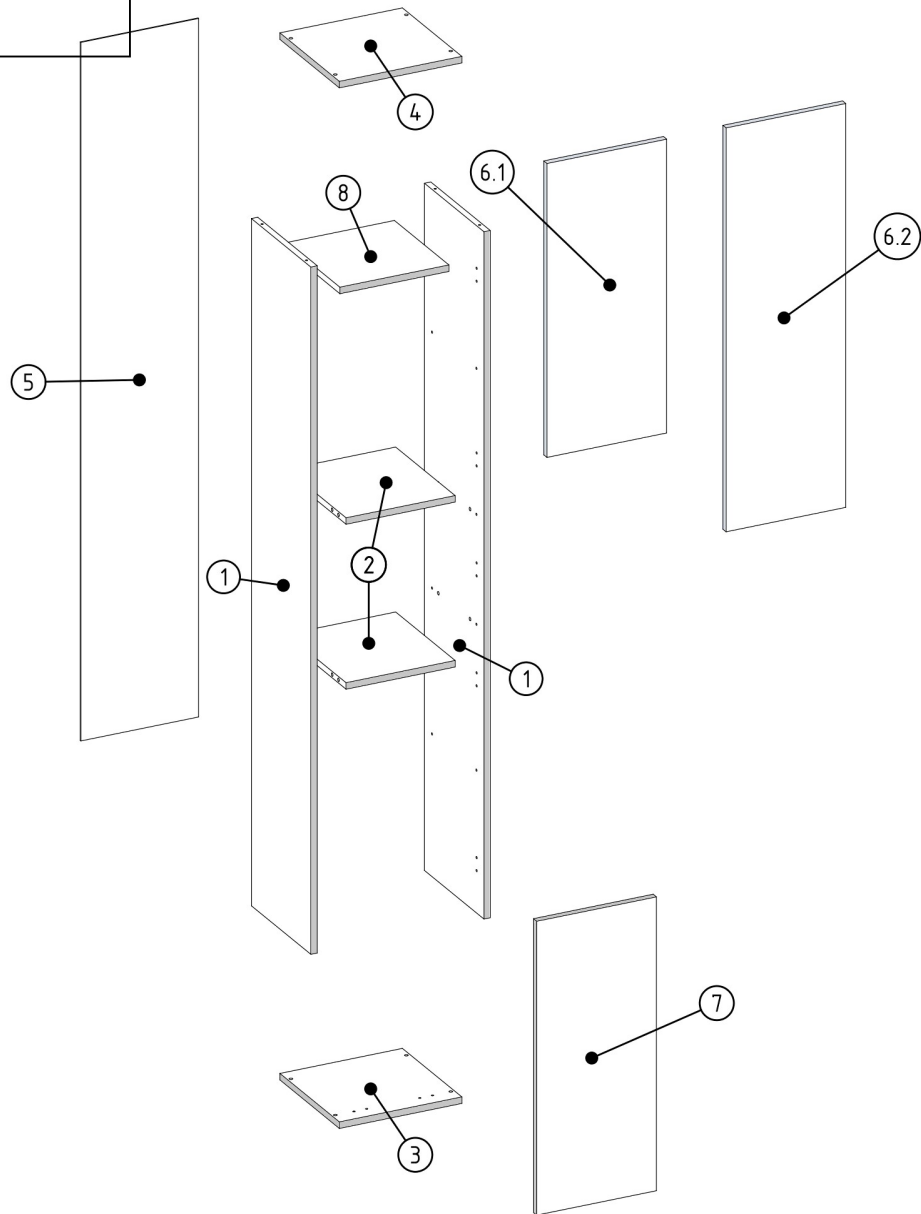

000022	8	1
000165	7	1
000234	6.2	1
000166	6.1	1
000262	5	1
000037	4	1
000036	3	1
000023	2	2
000260	1	2
ID	NUMBER	QUANTITY

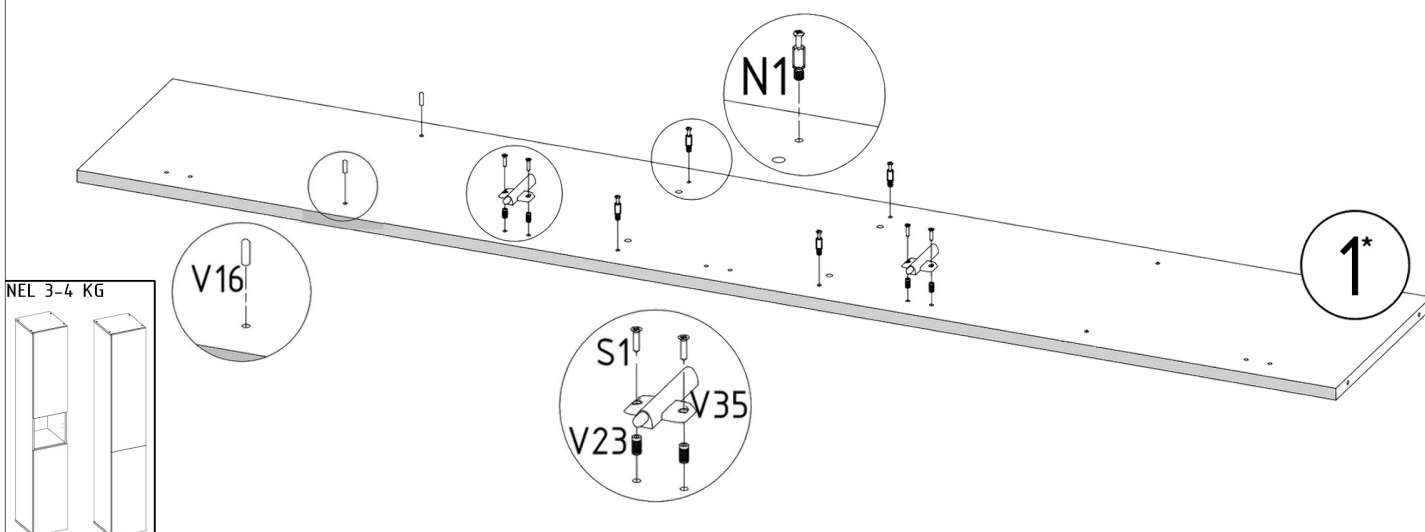
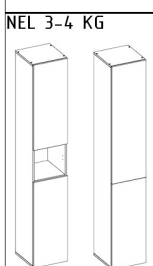
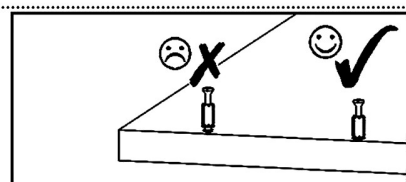
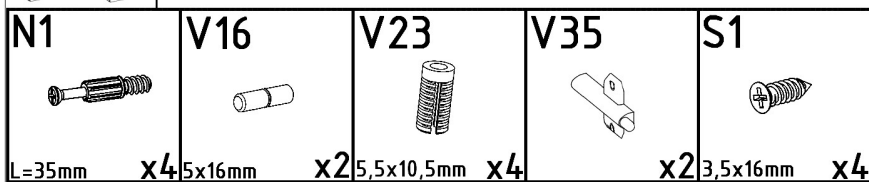
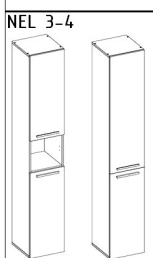
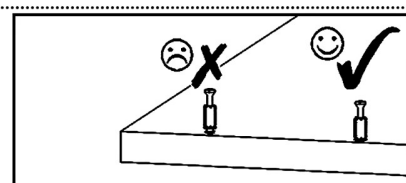
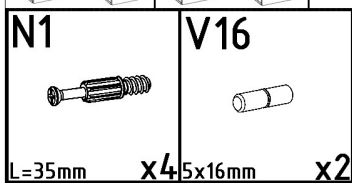
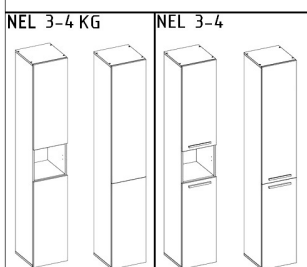
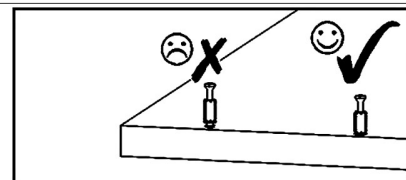
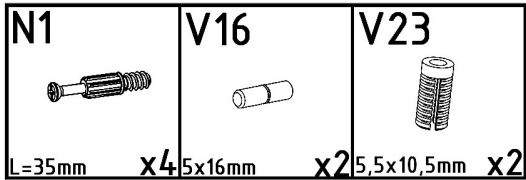

M1



12x15mm

X8

E1



8x30mm

X8

x2

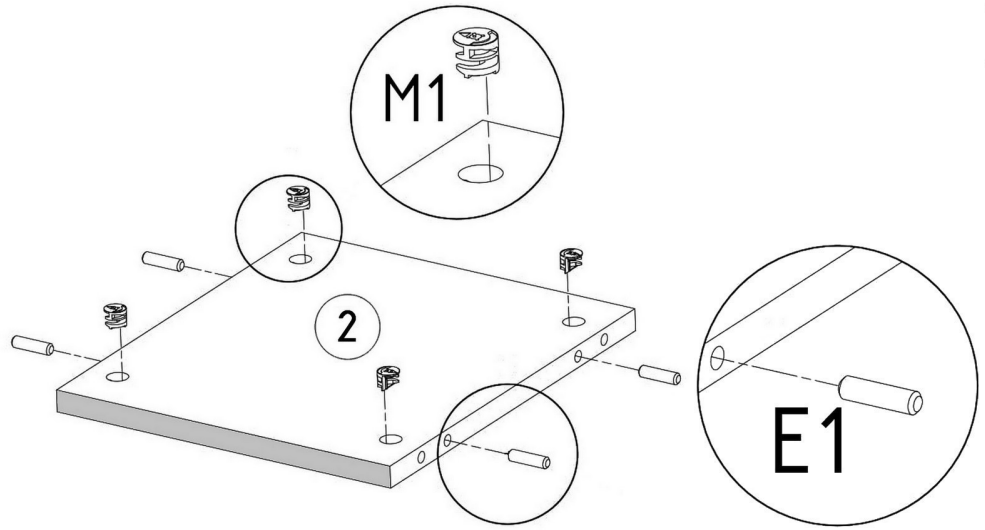

NEL 3-4 KG

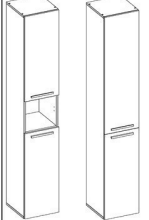

NEL 3-4

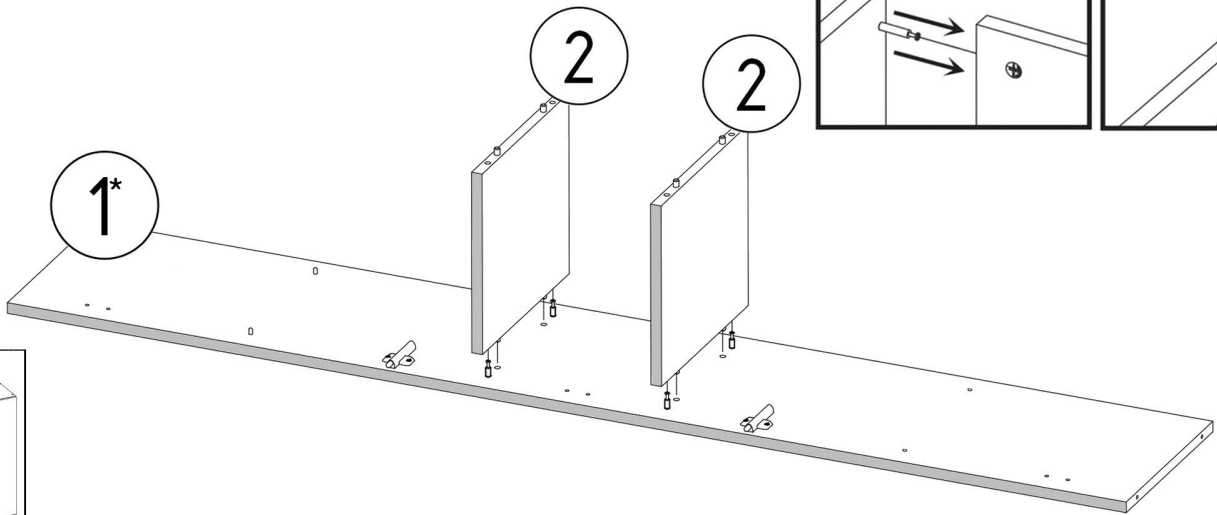
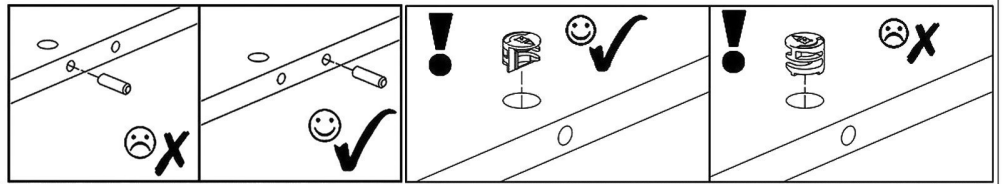
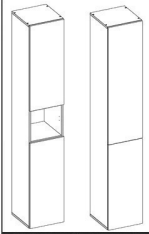

NEL 3-4 KG

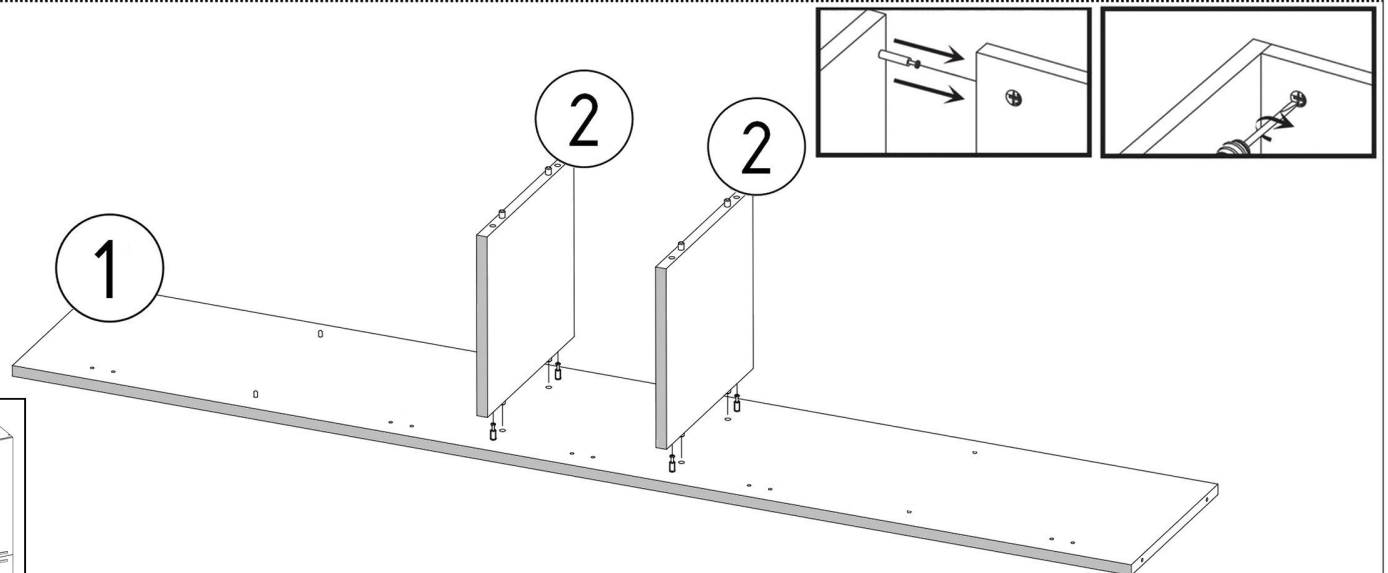
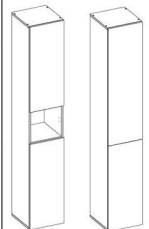

NEL 3-4

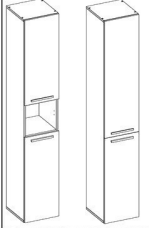

1

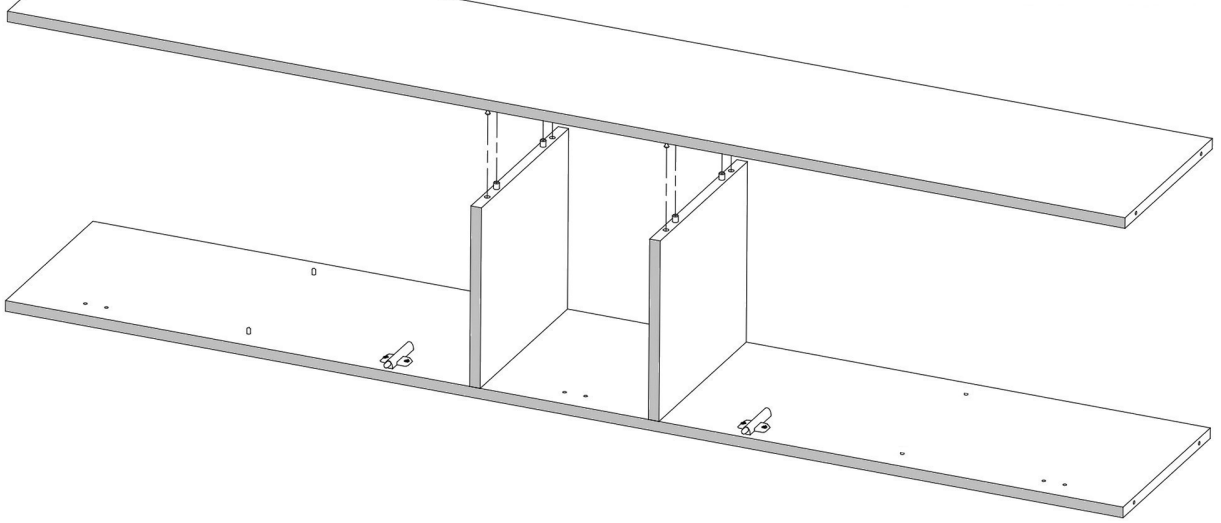
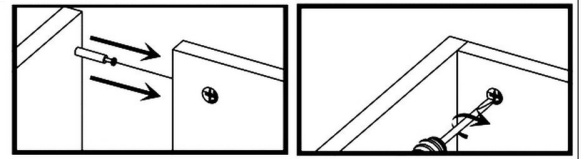

NEL 3-4 KG

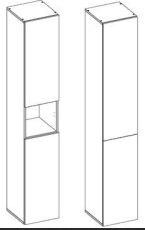

1

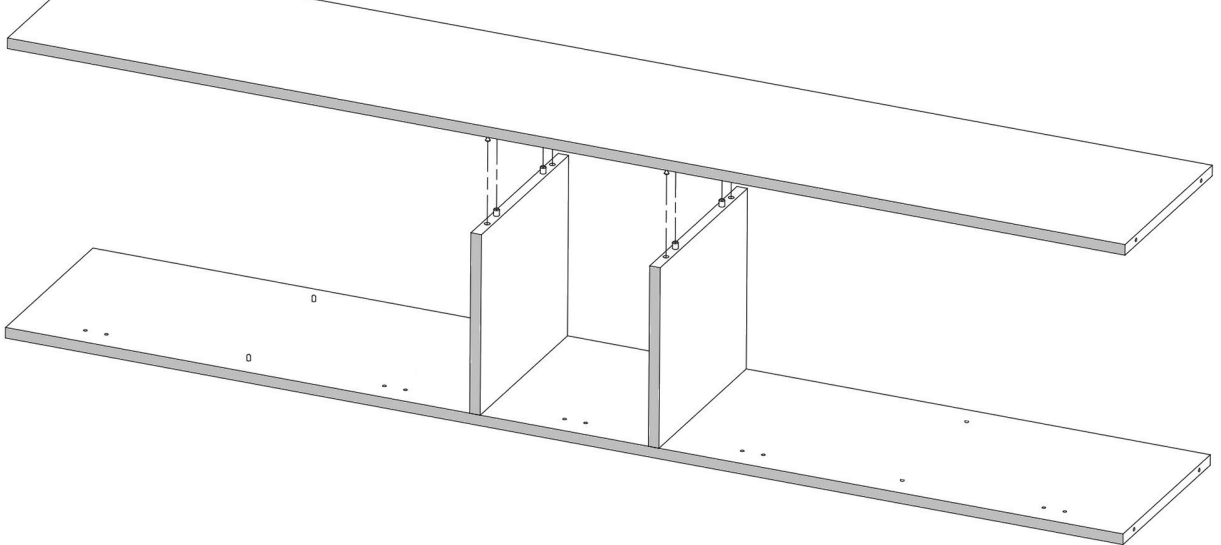
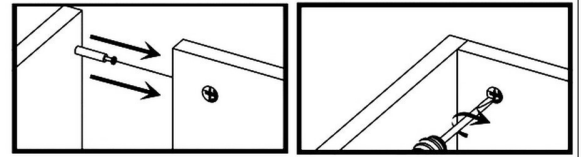

NEL 3-4

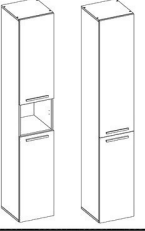

T1



x4

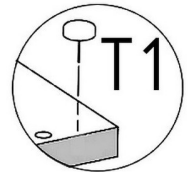

NEL 3-4 KG

NEL 3-4

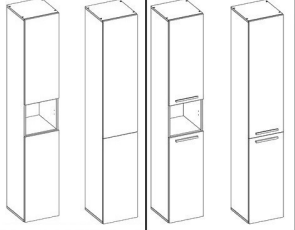

3

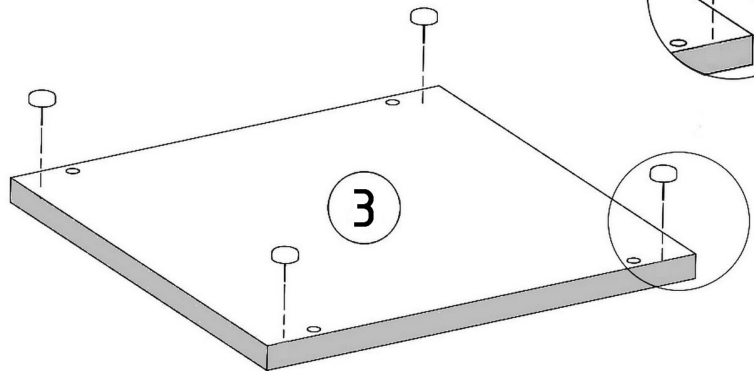

F1
7x50mm X8

F3
Hex 4mm X1

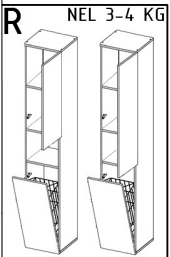
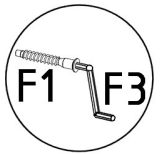
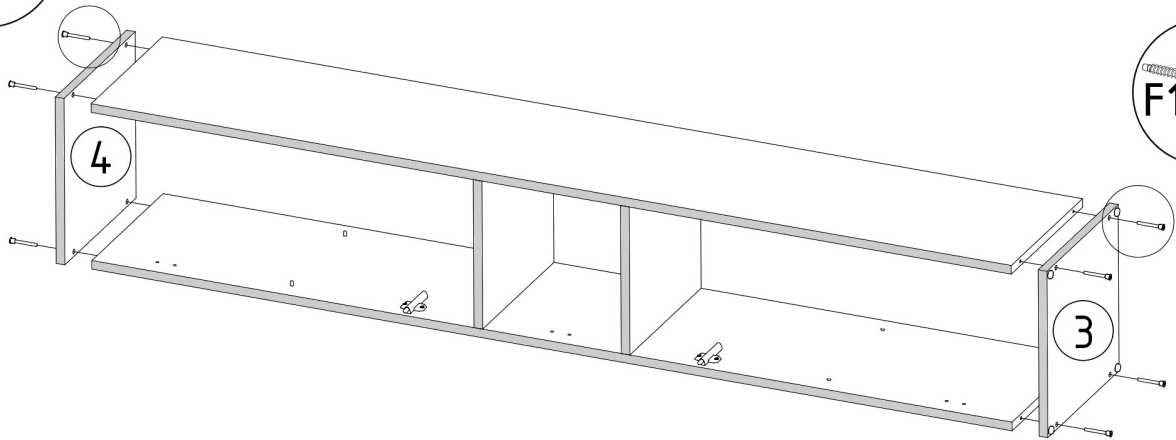
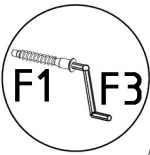
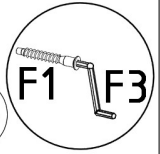
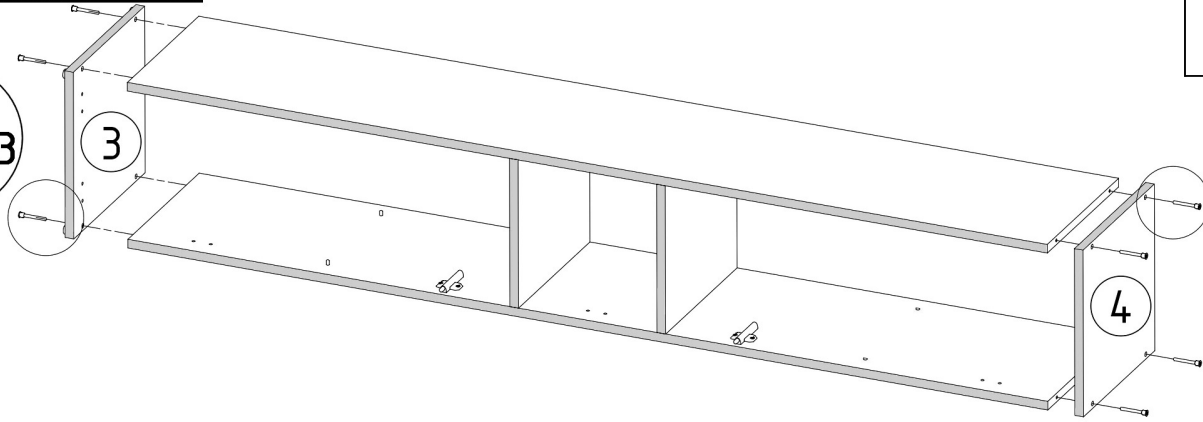
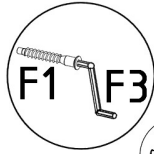
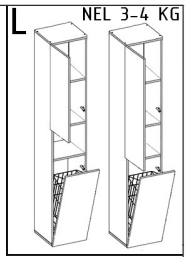





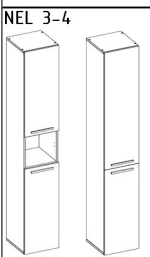
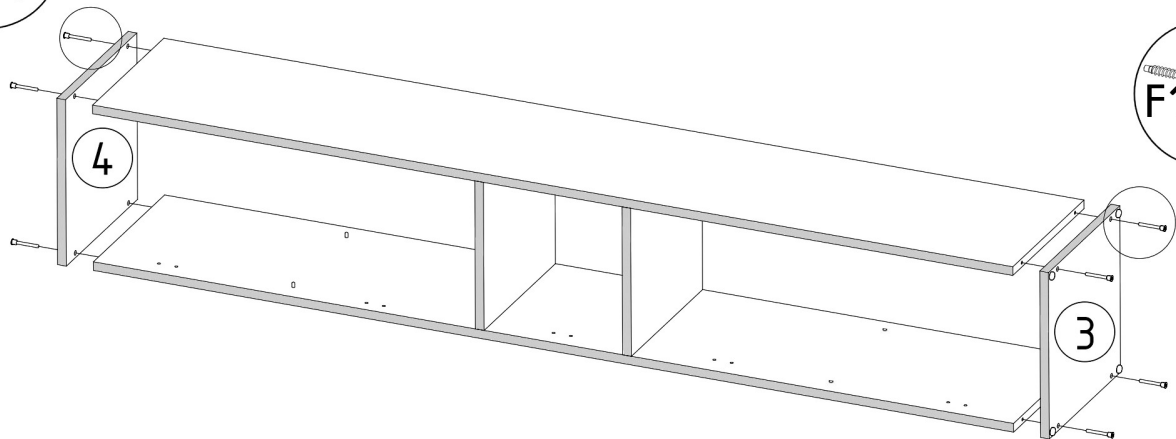
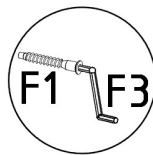

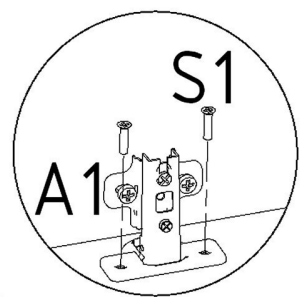
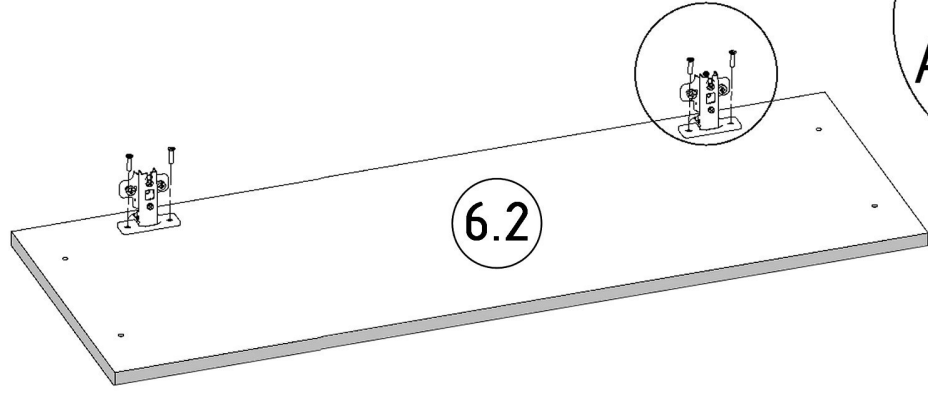
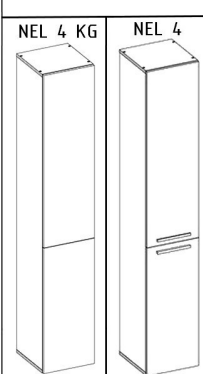
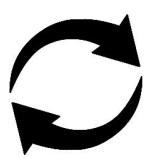
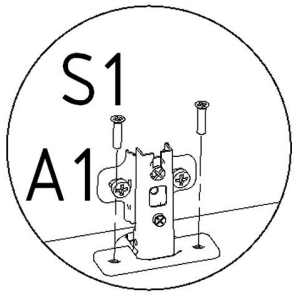
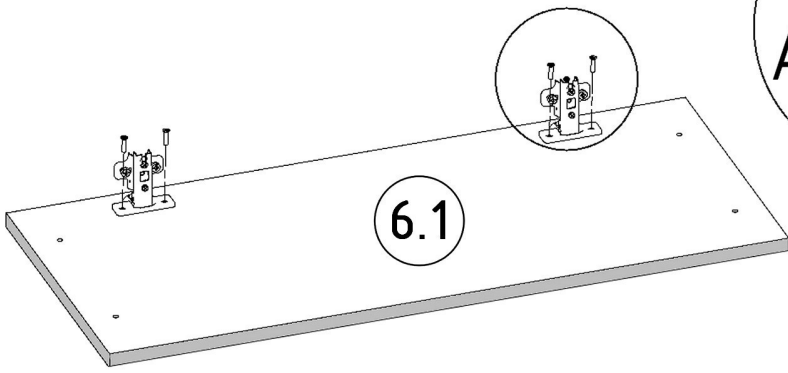
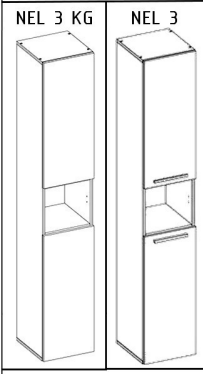
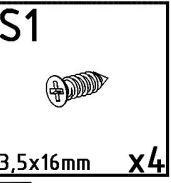
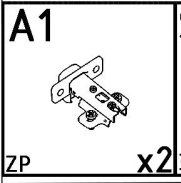
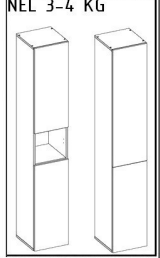
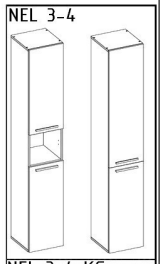
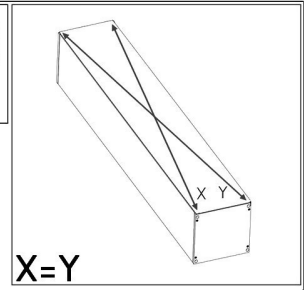
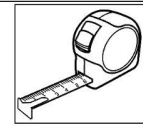
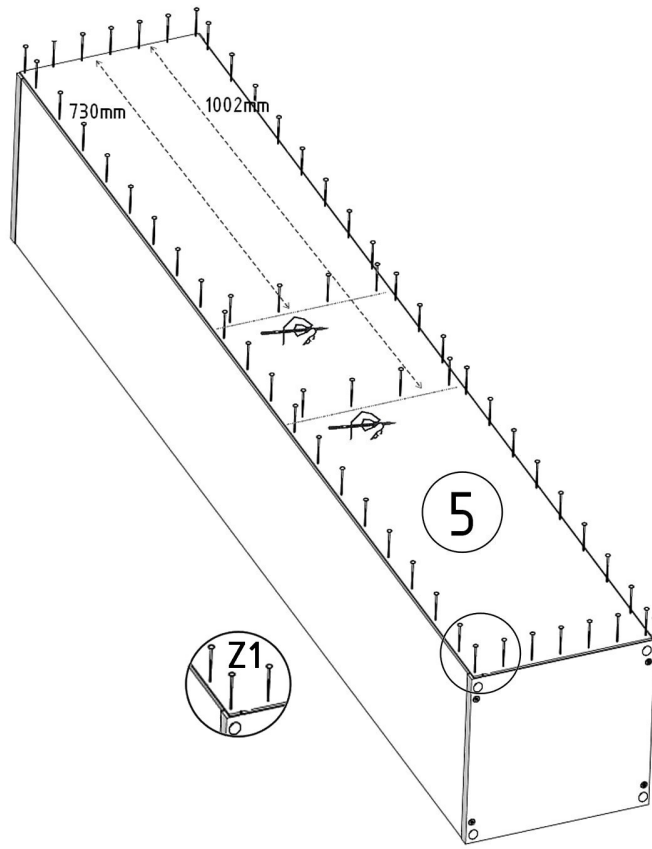
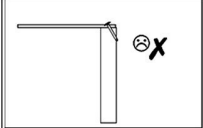
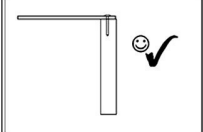
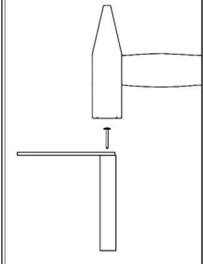
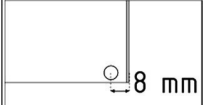
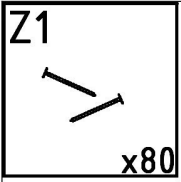
F1
7x50mm X8







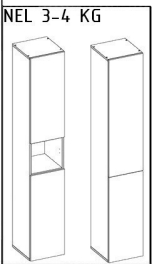
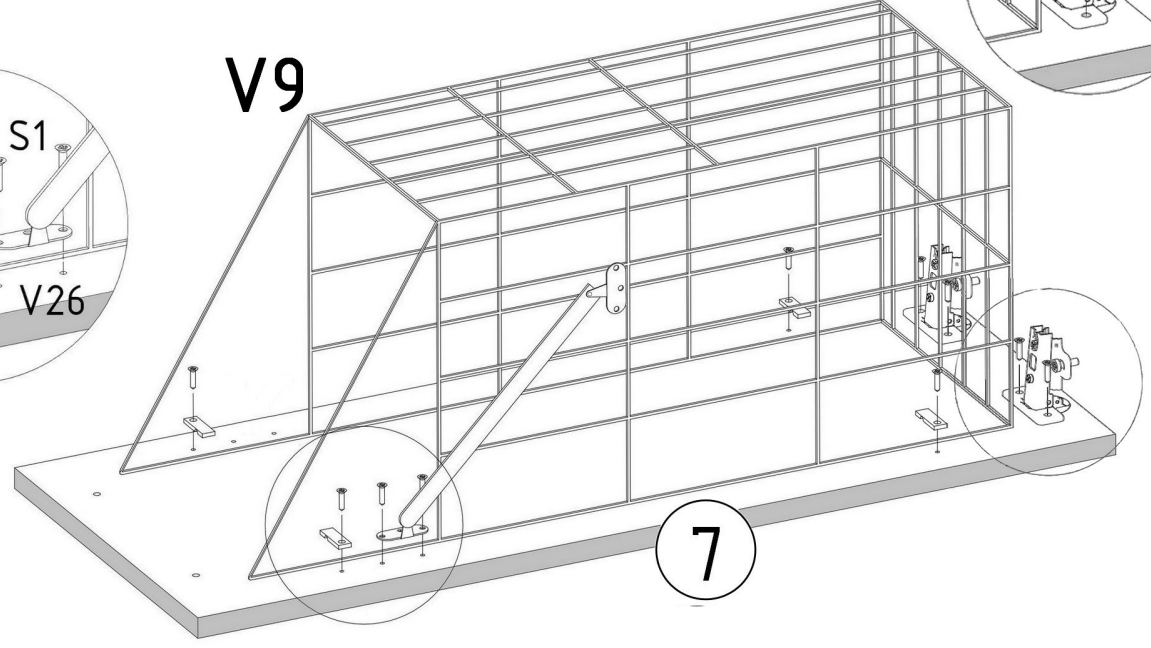
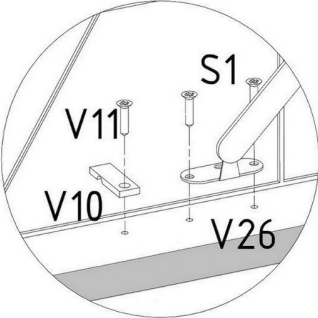
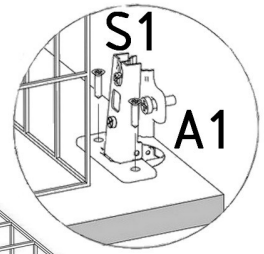

F3
Hex 4mm X1





A1 	S1 	V26 	V9 	V10 	V11 
ZP	x2 3,5x16mm	x6	x1	x1	x4 3,5x16mm



A1 	S1 	V26 	V9 	V10 	V11 	S3 	U3 
ZP	x2 3,5x16mm	x6	x1	x1	x4 3,5x16mm	x4 4x30mm	x2 L=190/160mm

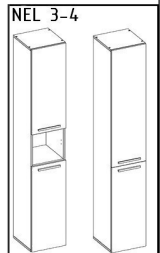
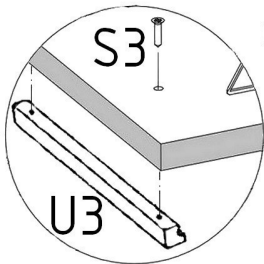
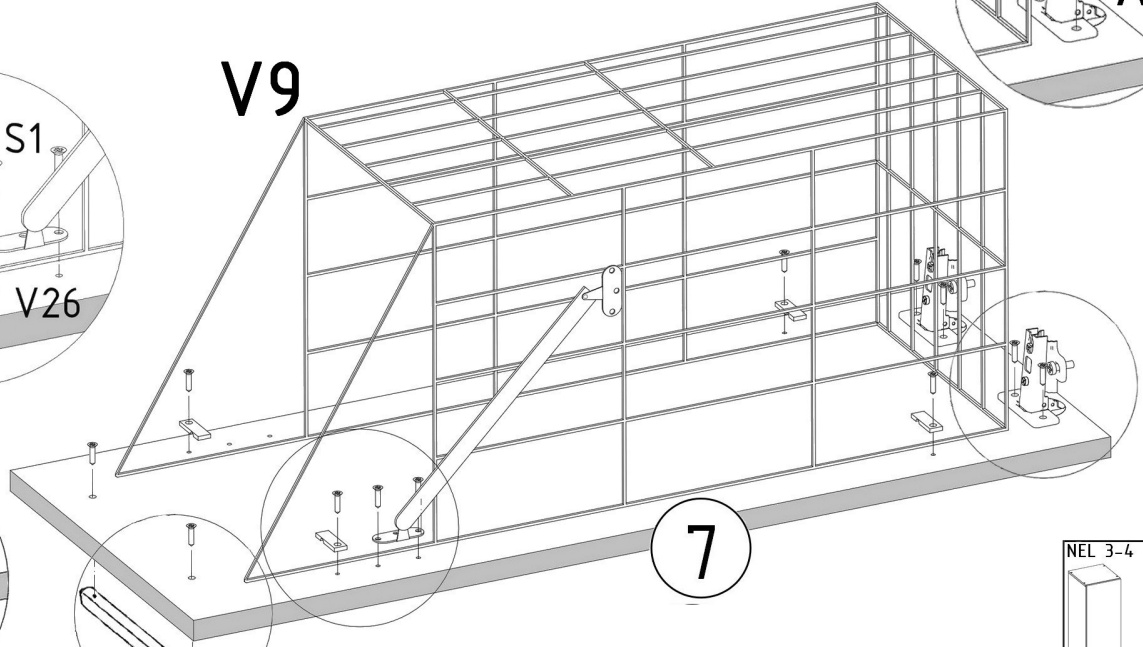
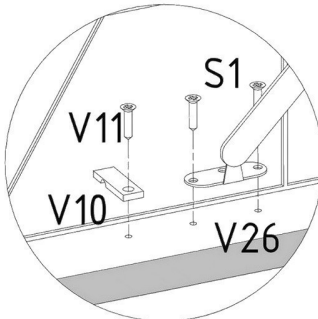
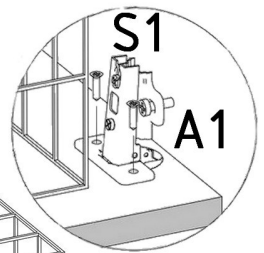

V13	S1
x1 3,5x16mm x2	

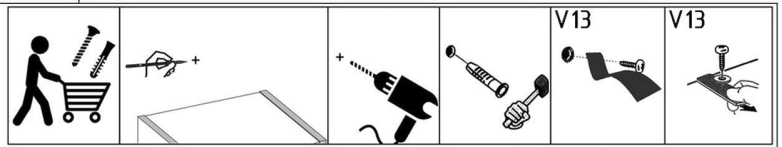

NEL 4 KG

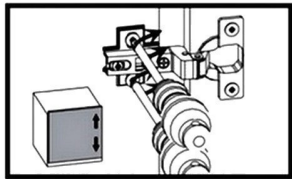
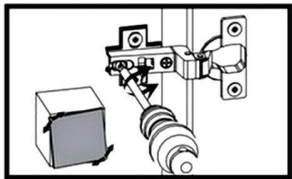
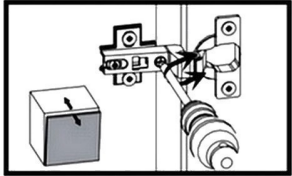
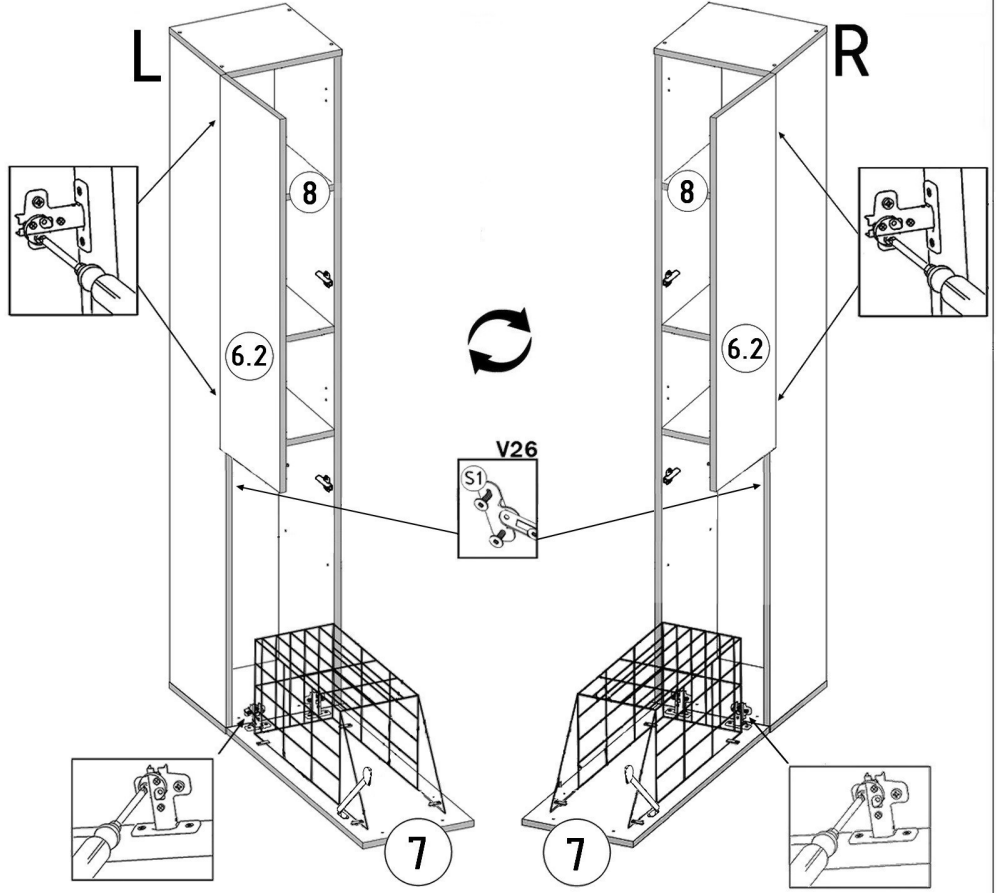



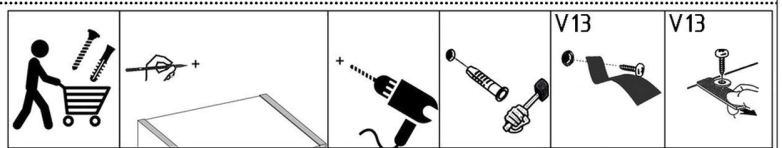

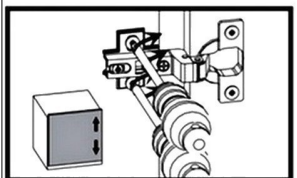
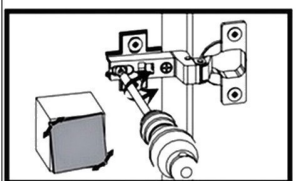
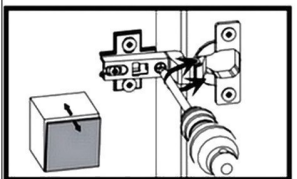
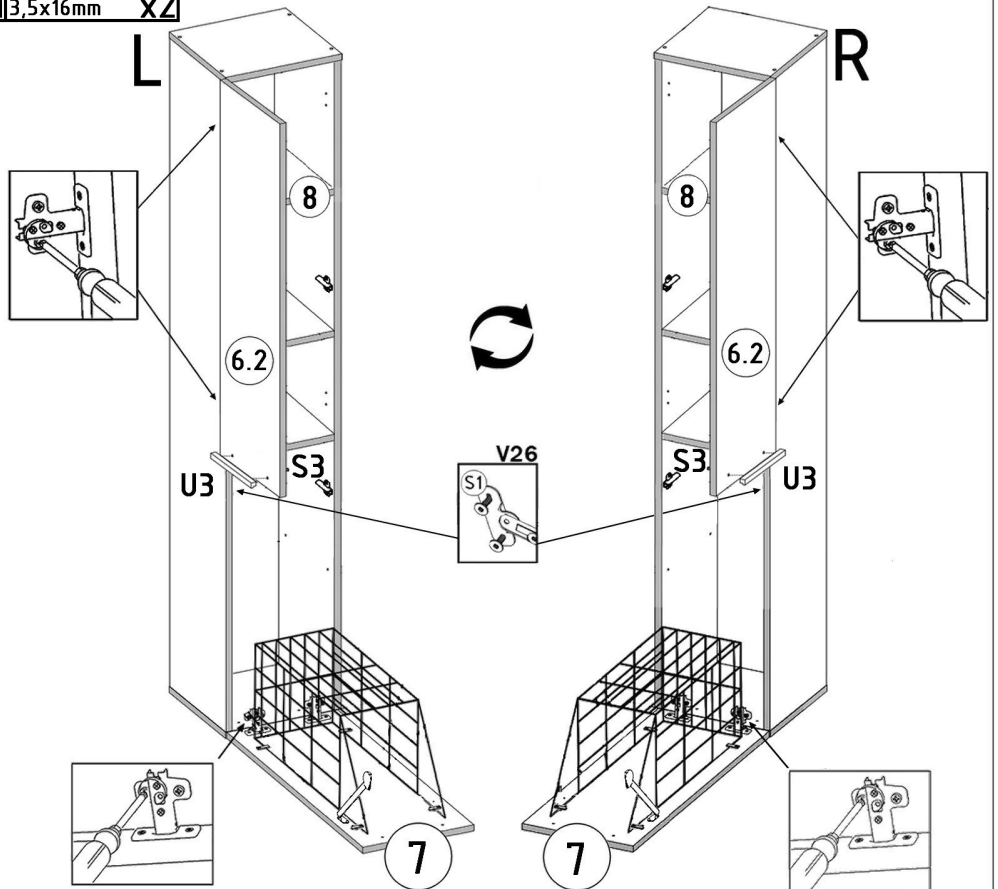

U3	S3	V13	S1
L=190/160mm x1 4x30mm x2		x1 3,5x16mm x2	



NEL 4





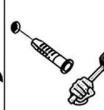
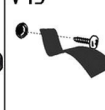



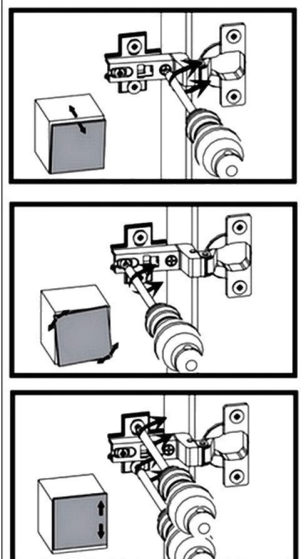
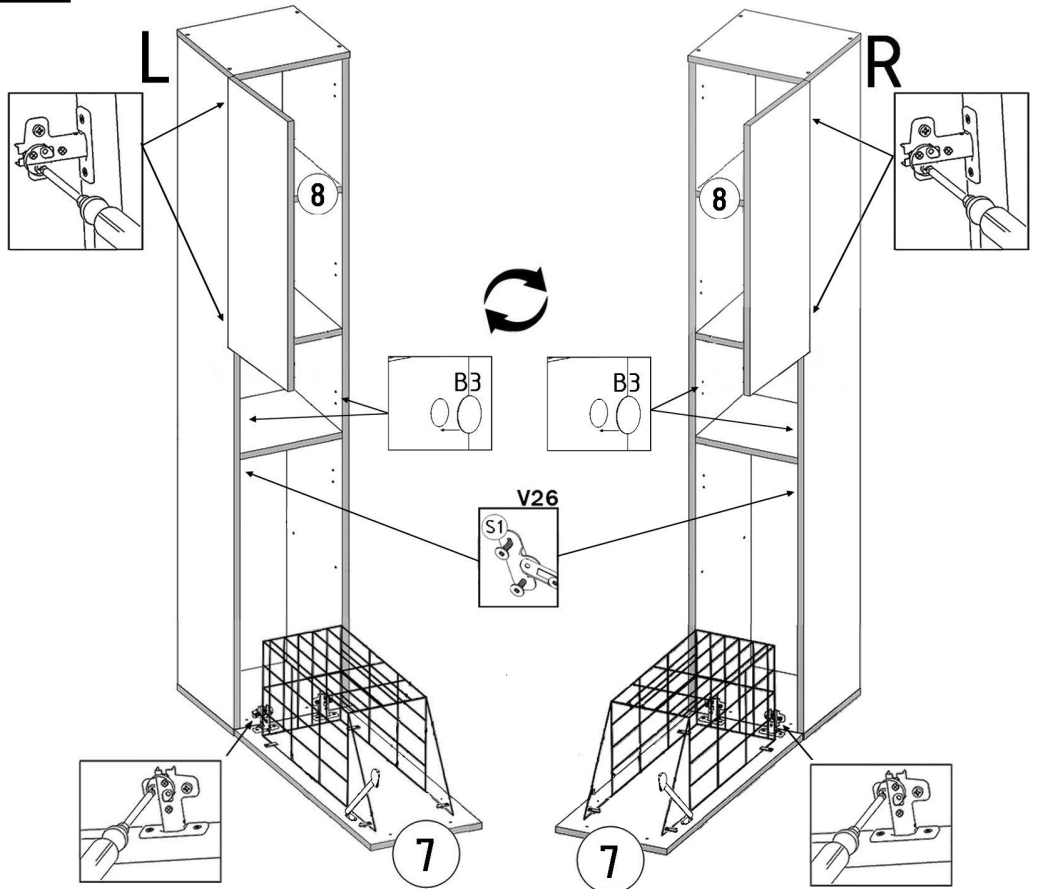

B3  ø 7-8/5mm x4	V13 	S1  x1 3,5x16mm x2
--	--	--

				V13 	V13 
--	--	---	--	--	--

NEL 3 KG

B3  ø 7-8/5mm x4	S3  4x30mm x2	U3  L=190mm x1	V13 
---	---	--	---

				V13 	V13 
---	---	--	---	---	---

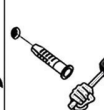
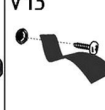
S1  3,5x16mm x2
--

NEL 3

