



Booklet available in English on
Heft in deutscher Sprache erhältlich auf
Livret disponible en français sur
Libretto disponibile in italiano su
Folleto en español disponible en
如需中文版手册, 请访问



LEGO.com/sustainable-packaging

LEGO® VIP

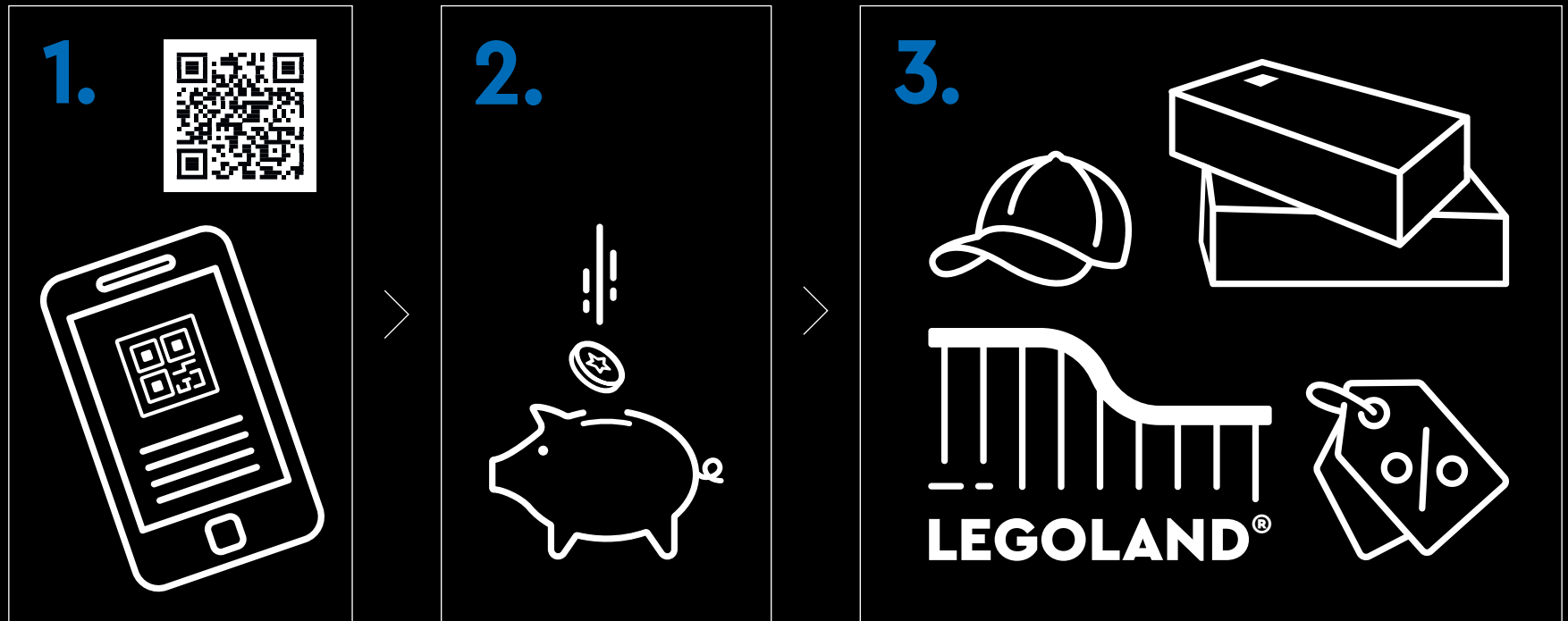

1. Sign up **2.** Earn points for purchases **3.** Redeem points for rewards, experiences, discounts & more | **1.** Melde dich an **2.** Sammle Punkte bei jedem Kauf **3.** Löse die Punkte für Belohnungen, Erlebnisse, Rabatte und Ähnliches ein | **1.** Inscrivez-vous **2.** Gagnez des points lors de vos achats **3.** Échangez vos points contre des récompenses, des expériences, des remises et bien plus encore | **1.** Iscriviti **2.** Guadagna punti con i tuoi acquisti **3.** Riscatta punti per premi, esperienze, sconti e altro ancora | **1.** Regístrate **2.** Gana puntos por tus compras **3.** Canjea puntos por recompensas, experiencias, descuentos y mucho más | **1.** Registe-se **2.** Ganhe pontos em compras **3.** Troque os pontos para prémios, experiências, descontos e muito mais | **1.** 注册 **2.** 购物赚积分 **3.** 用积分兑换奖励、体验、折扣等 | **1.** Zarejestruj się **2.** Zdobywaj punkty za zakupy **3.** Wymieniaj punkty na rabaty, przygody i inne nagrody | **1.** Zaregistrujte se **2.** Sbírejte body za nákupy **3.** Vyměňujte body za odměny, zážitky, slevy a spoustu dalšího | **1.** Zaregistrujte se **2.** Získavajte body za nákupy **3.** Uplatnite si body a získajte odmeny, rôzne zážitky, zľavy a ešte viac | **1.** Regisztrálj **2.** Szerez pontokat minden vásárlással **3.** Váltsd be pontjaidat jutalmakra, élményekre, kedvezményekre és egyebekre | **1.** Înscric-te **2.** Câștigă puncte pentru achiziții **3.** Valorifică puncte pentru recompense, experiențe, reduceri și multe altele | **1.** Регистрируйте се **2.** Получайте точки за покупки **3.** Используйте точки за награды, услуги, отстъпки и т.н. | **1.** Reģistrējies **2.** Pelni punktus par pirkumiem **3.** Izmanto punktus, lai saņemtu balvas, izklaides iespējas, atlaides un daudz ko citu | **1.** Registreeru **2.** Teeni ostude eest punkte **3.** Lunasta punktide eest preemiad, elamused, allahindlused ja muu | **1.** Užsiregistruokite **2.** Pelnykite taškų už pirkinius **3.** Panaudokite taškus atlygiui, funkcijoms, nuolaidoms ir ne tik



21st century pop icons

Since its birth in the 1990s, modern K-pop has conquered the global music scene with compellingly happy tunes, blazing splashes of colour and upbeat dance moves. Transcending language and cultural barriers, each new generation of passionate young Korean artists and bands have carved a niche of their own in music history.

Then in 2013, seven South Korean stars aligned in an extraordinary constellation that would definitively reshape the landscape of K-pop in the pop music scene. With multi-genre-inclusive hits that continue to break world records, BTS are this generation's unequivocal pop icons. Members RM, Jin, SUGA, j-hope, Jimin, V and Jung Kook have reached unprecedented levels of popularity worldwide as 21st century pop icons. Not only for their unique music style and tongue-in-cheek attitudes but also for acting responsibly as positive influencers and activists for equality and inclusivity, and ambassadors for self-love and joy, on and off stage.



BTS – On and Beyond the Scene

With millions of records sold, stadium concerts, countless nominations, prestigious awards and recognitions, and tens of millions of social media followers, BTS have had a tremendous impact on fans worldwide, especially among young generations. BTS, an acronym for *Bangtan Sonyeondan*, later became an acronym for "Beyond the Scene", as band members wanted to use their voices to reach far beyond the music scene. In 2017, they entered a partnership with UNICEF to work towards ending violence and neglect while promoting the younger generation's self-esteem and well-being through the LOVE MYSELF and #ENDviolence campaigns. The band was invited to deliver their "Speak Yourself" speech at the 2018 UN General Assembly, with a message empowering young people to trust their worth and talent, and let their voices be heard.



How to build a record-breaking hit

Released in 2020 under BIGHIT MUSIC (under HYBE LABELS), an industry-leading music label, a new hit shone through the world at a time when most of us could definitely use a little funk and soul. (Or a lot, actually.) Without the opportunity to tour or engage with their beloved and devoted fans in person, the band turned to their superstrength to get through the pandemic; they continued to sing, dance and redefine their art on their own terms. "Dynamite" offered a welcome challenge to keep growing. Seen as a joyful reminder to allow space for light and fun in times of darkness, the song delivered on BTS' mission to bring people together and spread happiness. It lights a fire under our own playfulness and embraces the fact that life really is dynamite!

Build. Play. Dance!

"Dynamite" debuted at no. 1 on the Billboard Hot 100, Global Top 50 on Spotify and reached no. 1 on the charts in more than 100 countries and regions on iTunes. At the time of its release, views of the music video also exploded on YouTube, reaching 100 million views in less than a day. This set is a tribute to one of the most extraordinary music phenomena of our time. It is for everyone who shares the band members' love of feel-good, funky disco overload. Get ready to soak up the warm, sunny colours and energised atmosphere in the vibrant scenes, sing along (loudly!) and build, play and dance your way through your set.

BEAT

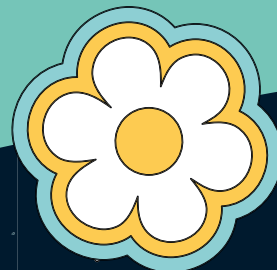



Meet the fan designer duo

Fan designers Josh Bretz and Jacob Twerski met online in a LEGO® fan community and worked together to combine their love of BTS and LEGO building.

Josh Bretz (LEGO® Ideas name JBBrickFanatic) is a US university student from Indiana. A lifelong LEGO fan, he loves playing and listening to music, outdoor fun and farm life.

"Dynamite" was the first BTS song I heard and my introduction to the K-pop world. Their disco beats and catchy tunes really drew me in. I love their positivity and the happiness their music spreads! I teamed up with Jacob, who knows everything about BTS, and he helped me capture the essence of the "Dynamite" music video in LEGO bricks. Once we shared the project on social media, the fan community of BTS helped our model video go viral almost overnight, and we gained 10,000 votes in a matter of days. It is so inspiring how dedicated BTS fans are. Their love and passion are so contagious, and I really hope they enjoy the set!"



Jacob Twerski (LEGO® Ideas name BangtanBricks) is from New York and studies psychology. He loves K-pop and music in general, building LEGO sets and writing science fiction stories and sagas.

"BTS mean everything to me. The first thing I do in the morning is listen to their music. I've written two college papers about them. Beyond the stunning visuals, elaborate choreography, out-of-this-world vocal work and lyrics, the members themselves are truly inspiring. It was such a fun process to work with Josh on this set. I would share my ideas and send him screenshots of important details and he brought the set to life. Music is a powerful force; it transcends language and "Dynamite" perfectly displays BTS' ability to bring joy into the world. I'm glad to see more and more new fans join the BTS fan community every year."



Ping Pong



FUNK

Meet the LEGO® Designers

'Re-creating a music video is something totally different for LEGO® Ideas. I love that we get to try these different things with the support of LEGO fans! I'm also a BTS fan, and I was excited to pack the model with details and accessories to make it a great display model, but also one that younger fans can play with! Dance choreography is so important for BTS, so it was great to be able to incorporate a stage where band members can actually dance with the special function. We must have watched the video hundreds of times for reference, and we still love it, because the song is an absolute bop!'

—James May, LEGO Ideas Model Designer

'As a BTS fan myself, I had so much fun turning this great concept into a buildable LEGO Ideas set! I liked how Josh and Jacob's model already captured the look and layout of the location in the music video, with very iconic scenes like the doughnut shop and record shop. Our focus was to bring both the model and LEGO minifigures to life with lots of details and references from the video, a dynamic stage function and, of course, Diego's stickers and decorated minifigures.'

—Gemma Anderson, LEGO Ideas Model Designer

'I rewatched the "Dynamite" music video over and over (I even learned the dance!) to get as many details as possible from their outfits and expressions that represent the band members' unique personalities. I love their music. I don't speak Korean, but I appreciate the love and energy they exude and how it makes me feel even without understanding the words. To me, music is a universal language and BTS have proved that by captivating fans all over the world. The LEGO Group rarely portrays real people as minifigures, especially celebrities with such a huge and vocal fanbase! I'm proud we could help create this homage to them.'

—Diego Sancho, LEGO Ideas Graphic Designer

DING
DONG

cha
ching



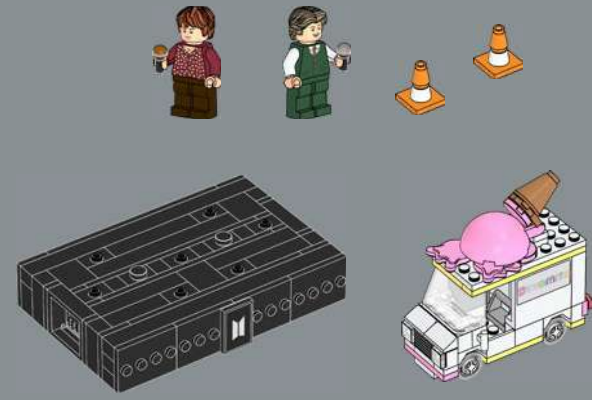
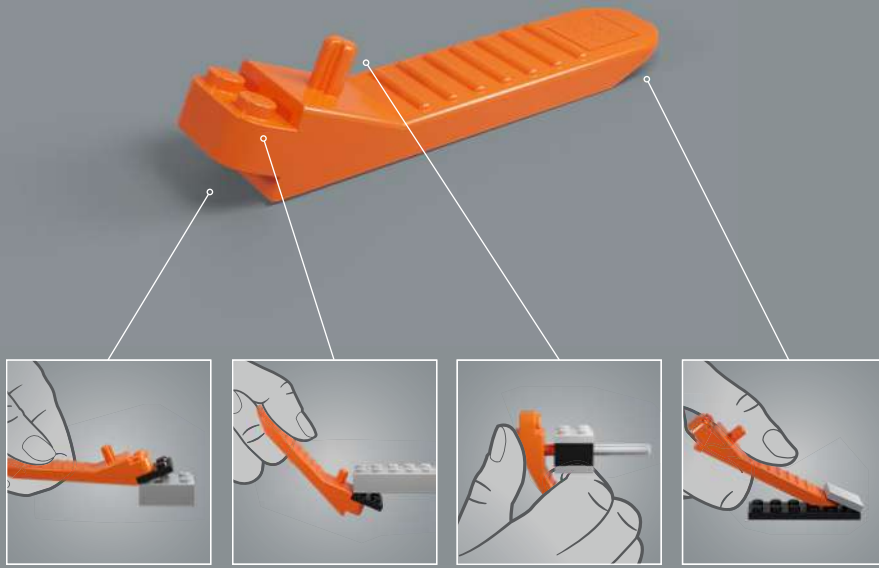

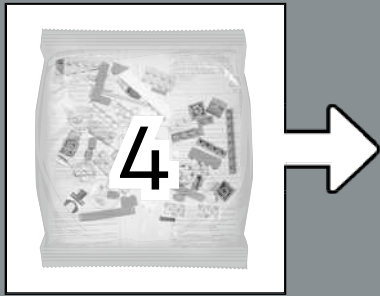
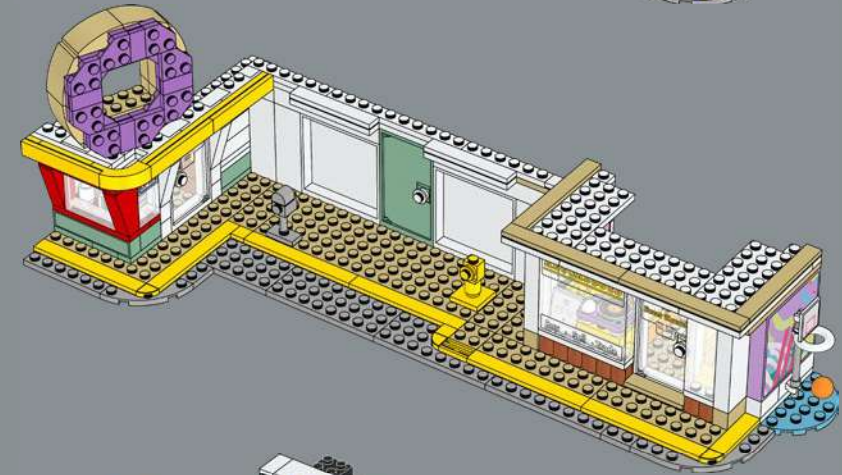
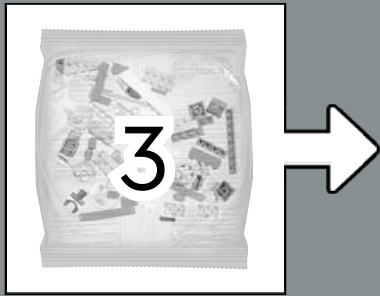
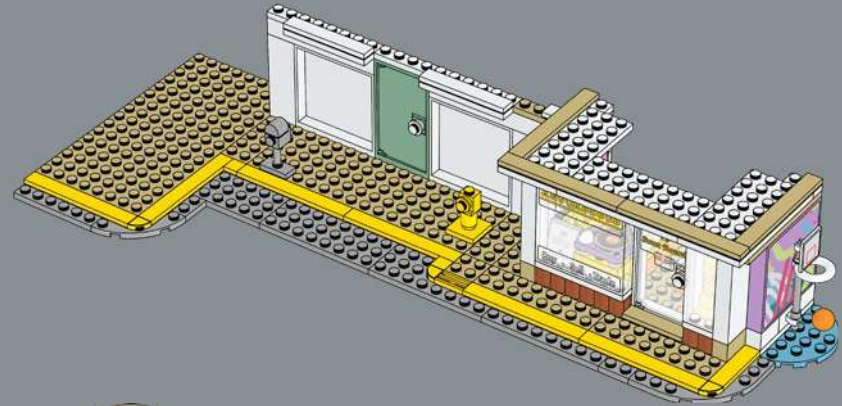
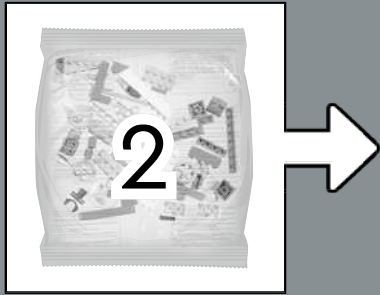



1



2



2x

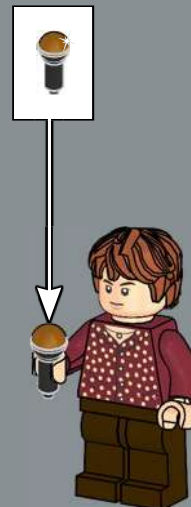
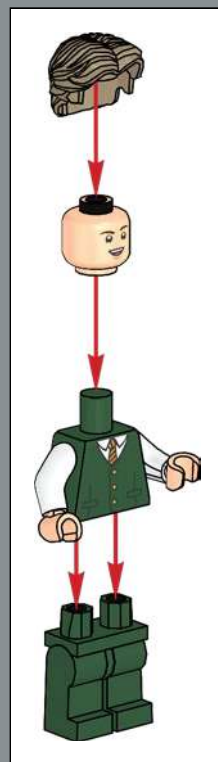

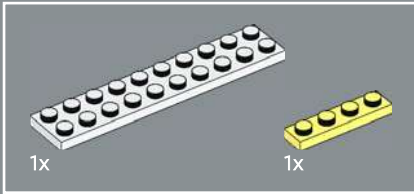

1

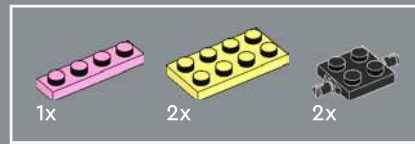
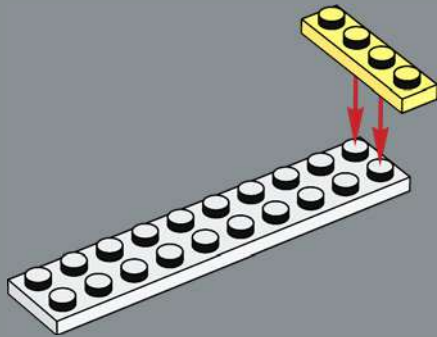

2

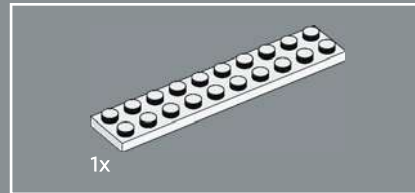
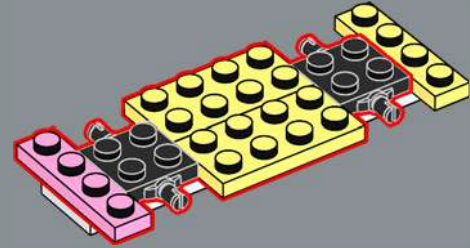

3

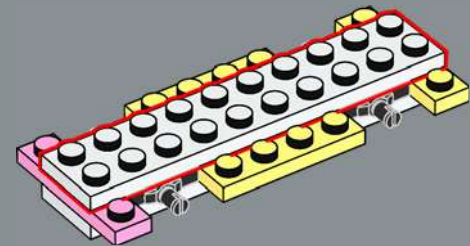

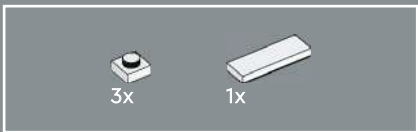

4

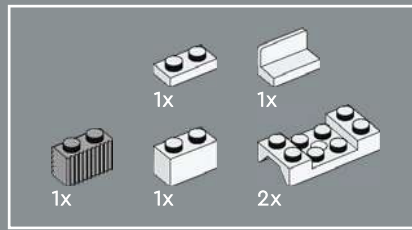
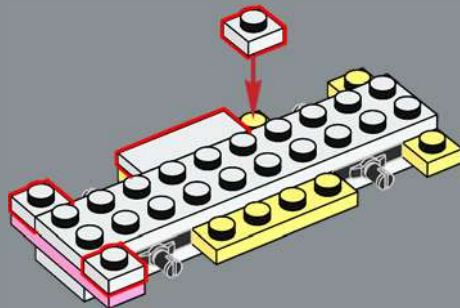

5

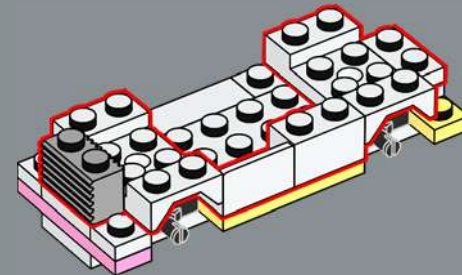



6

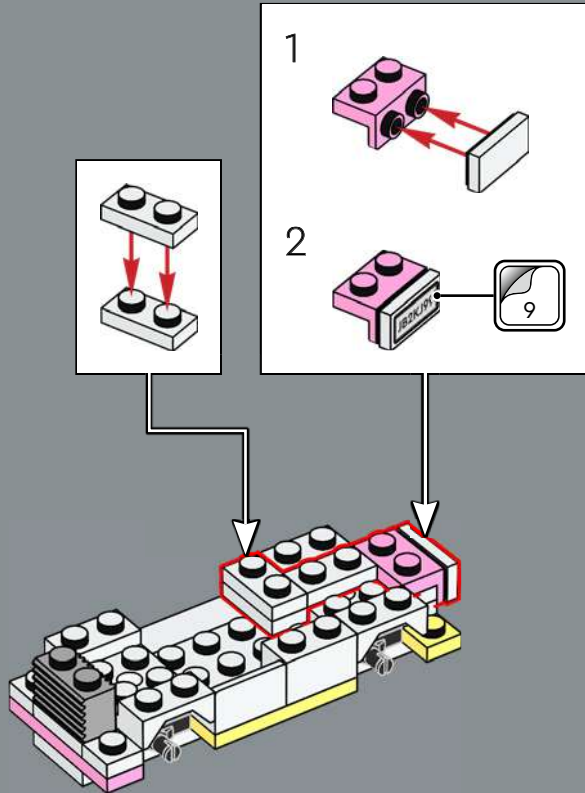

7

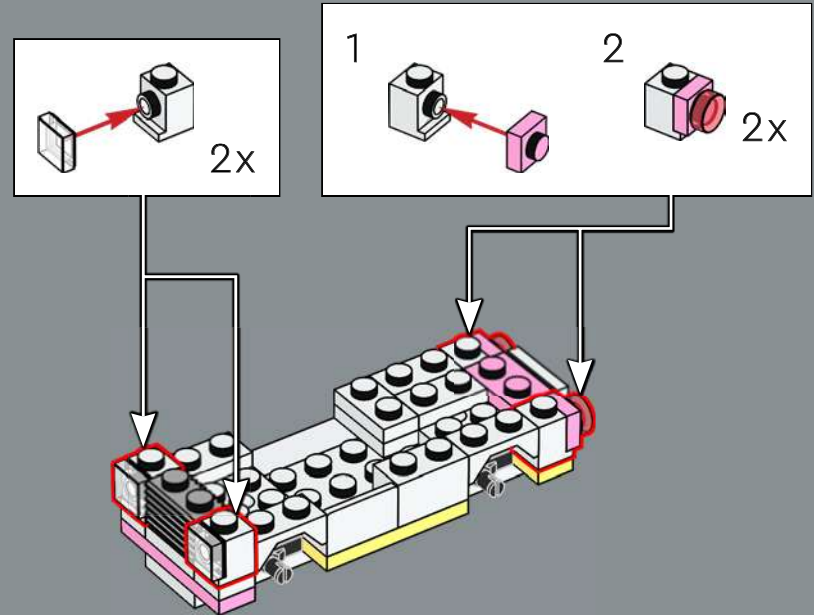

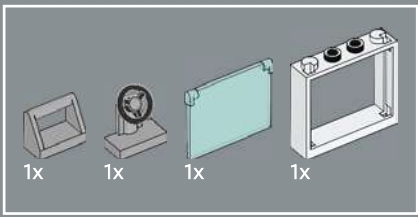

8

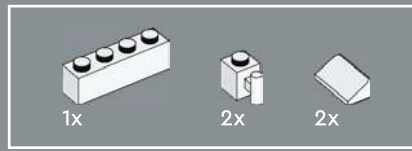
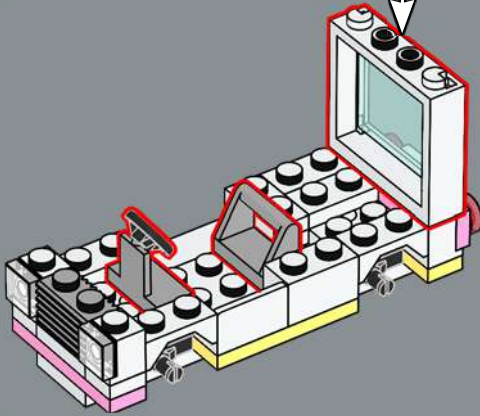
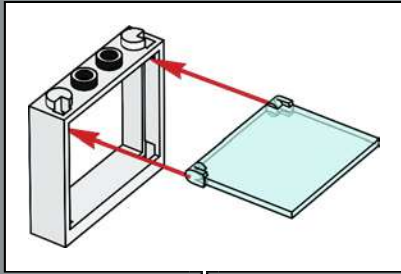

9

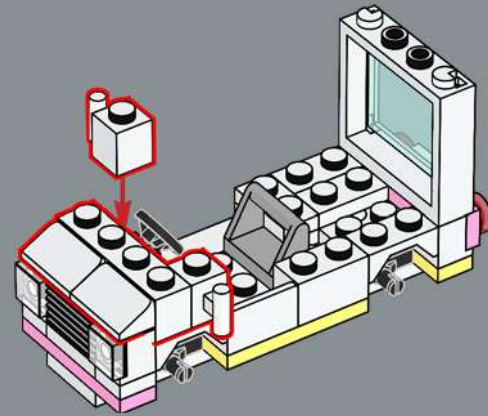

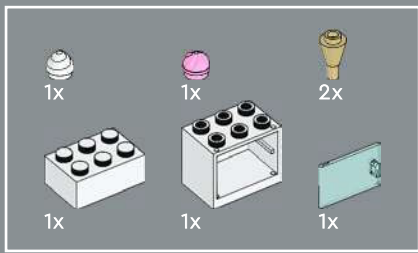

10

1

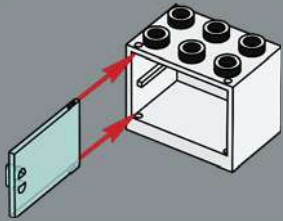

2

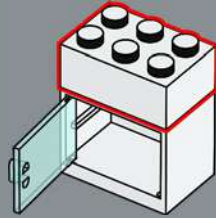

3

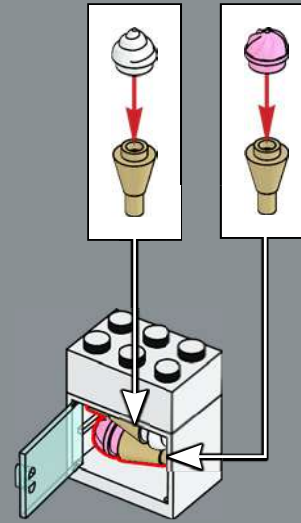

4

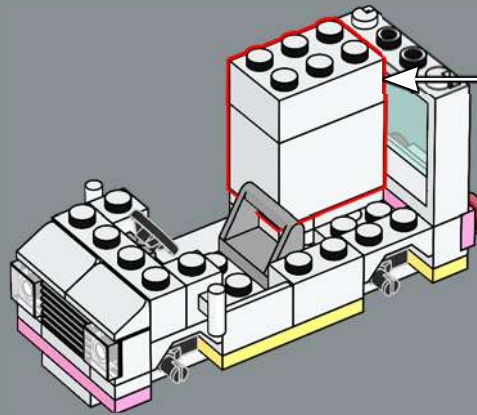
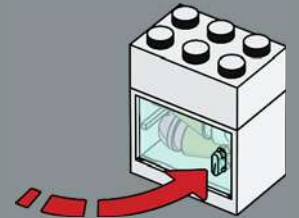

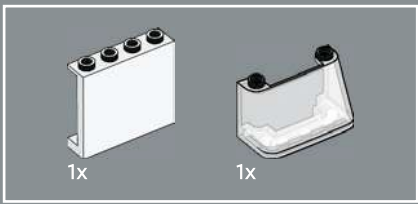

11

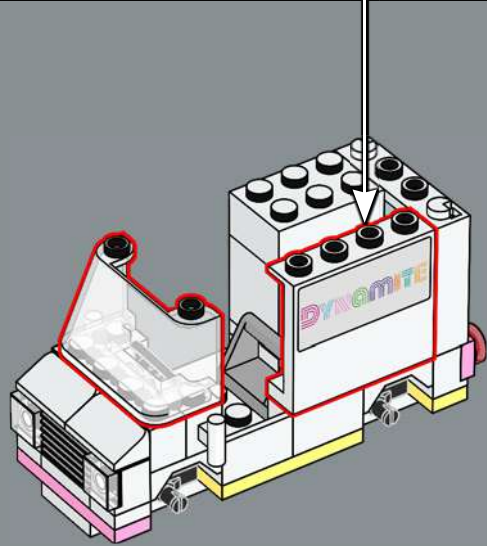
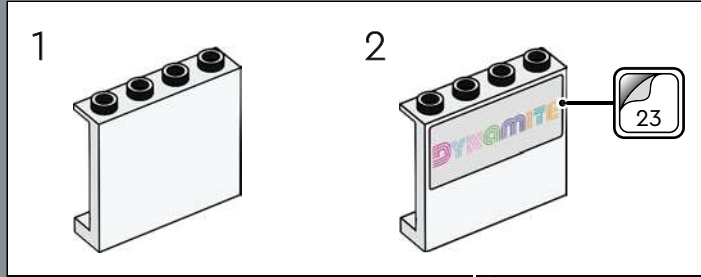

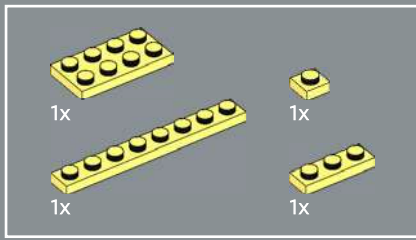

12

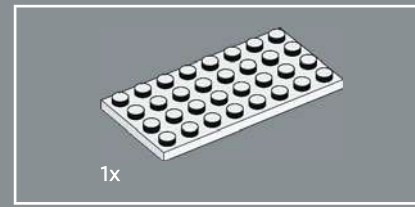
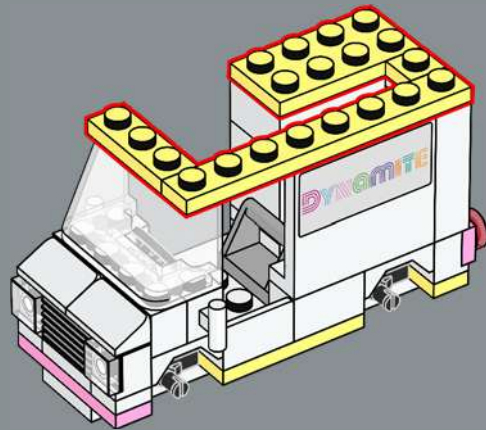

13

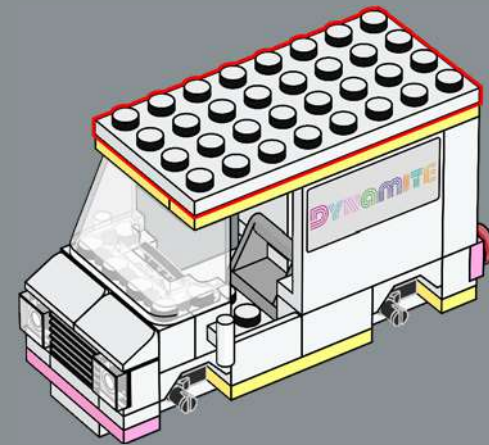

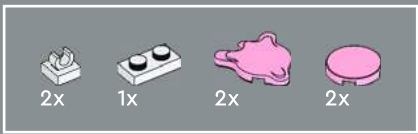

14

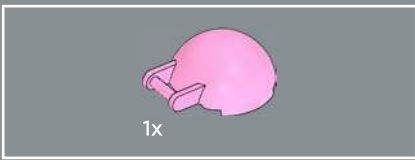
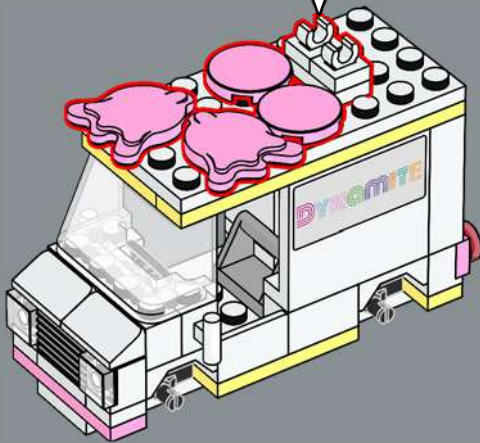
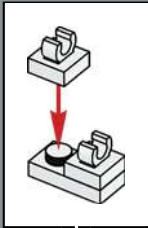

15

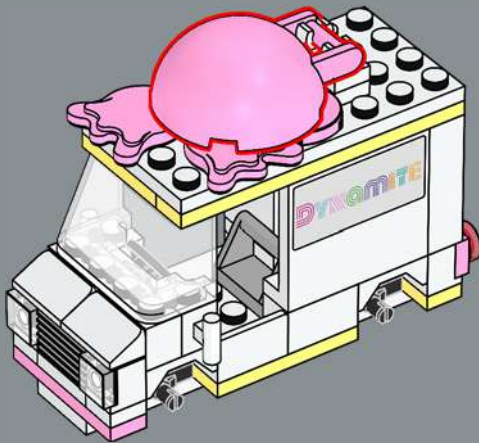

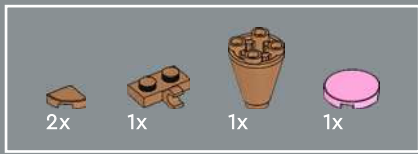

16

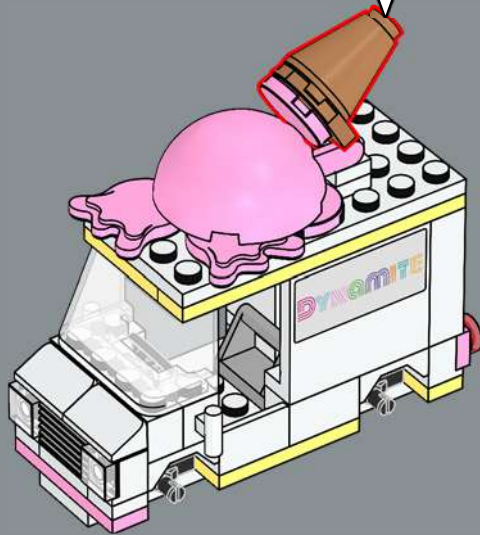
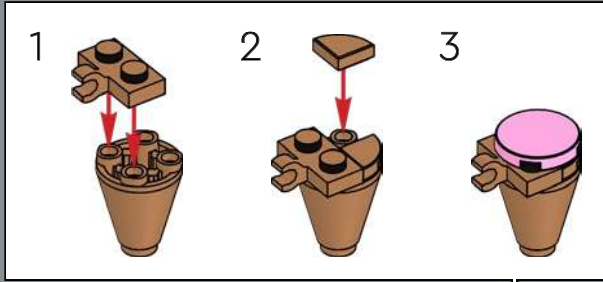

17



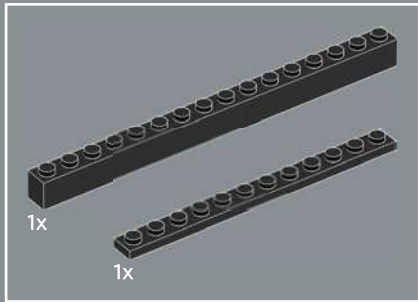
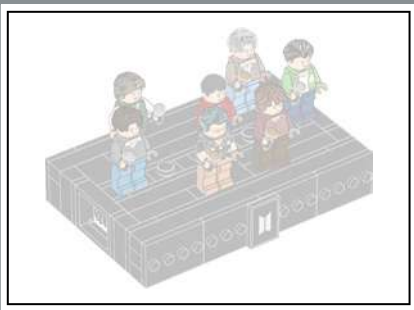

1

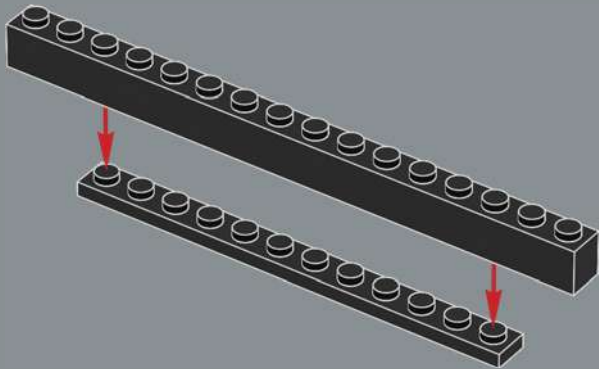

2

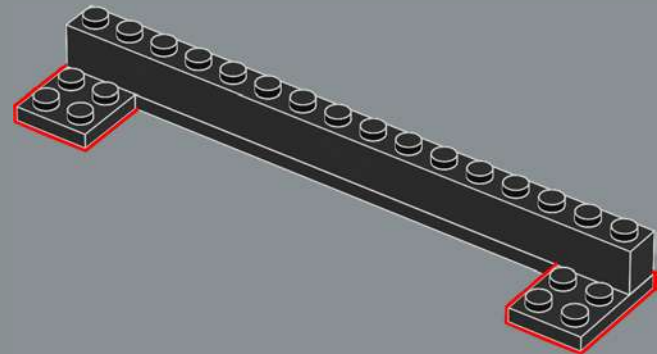

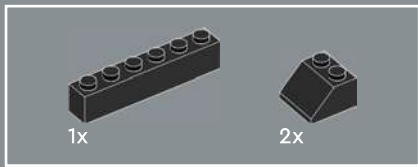

3

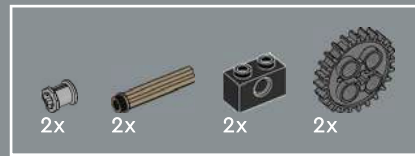
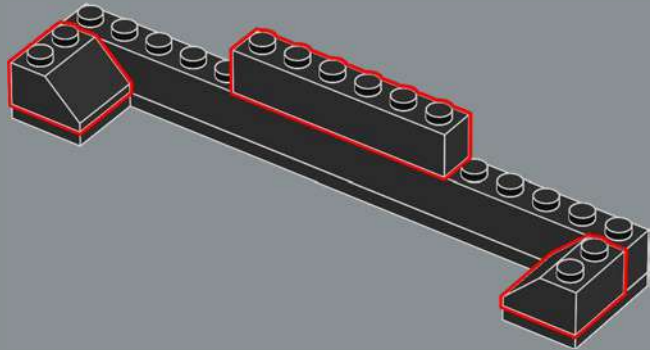

4

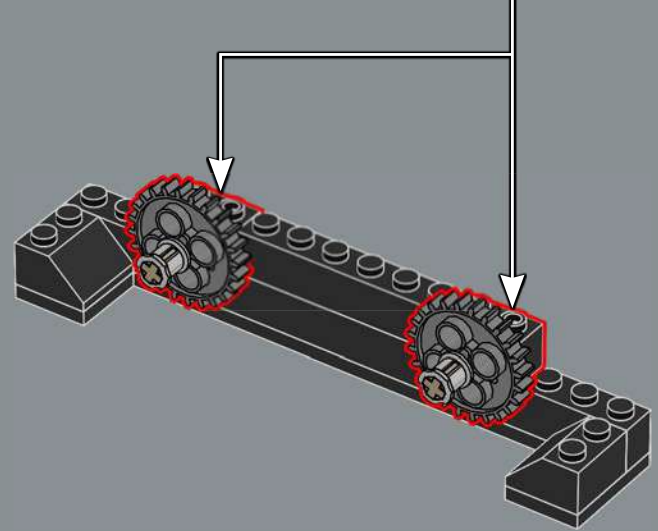
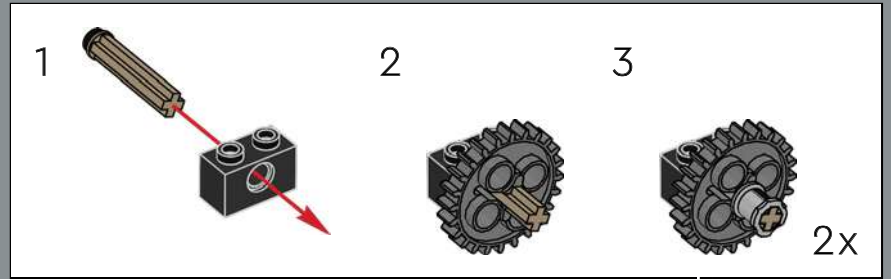

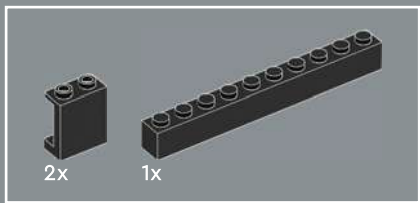

5

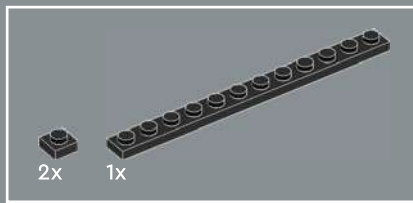
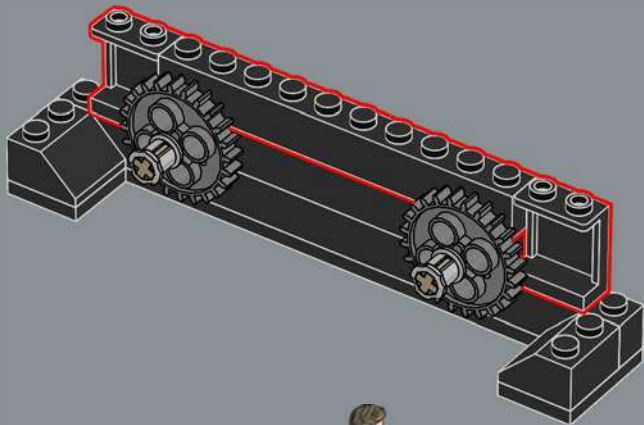

6

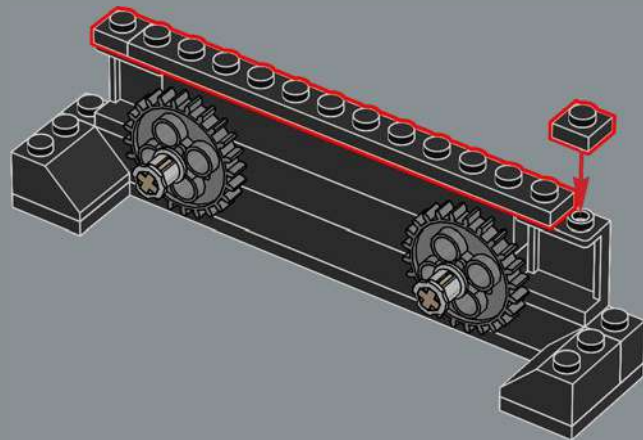

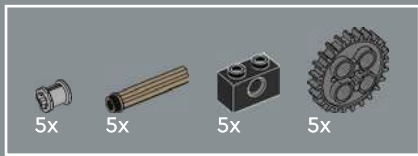

7

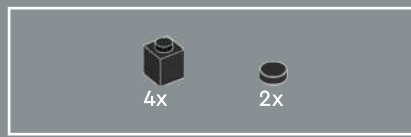
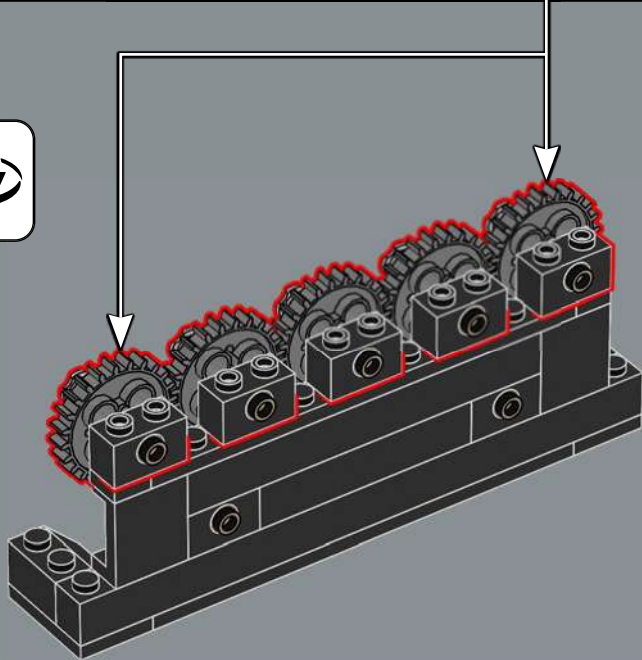
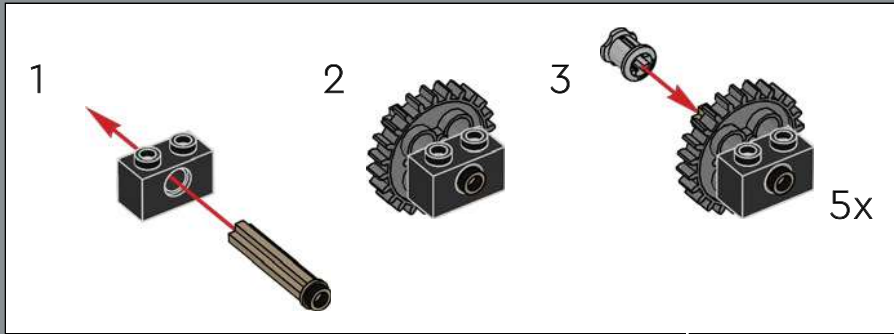

8

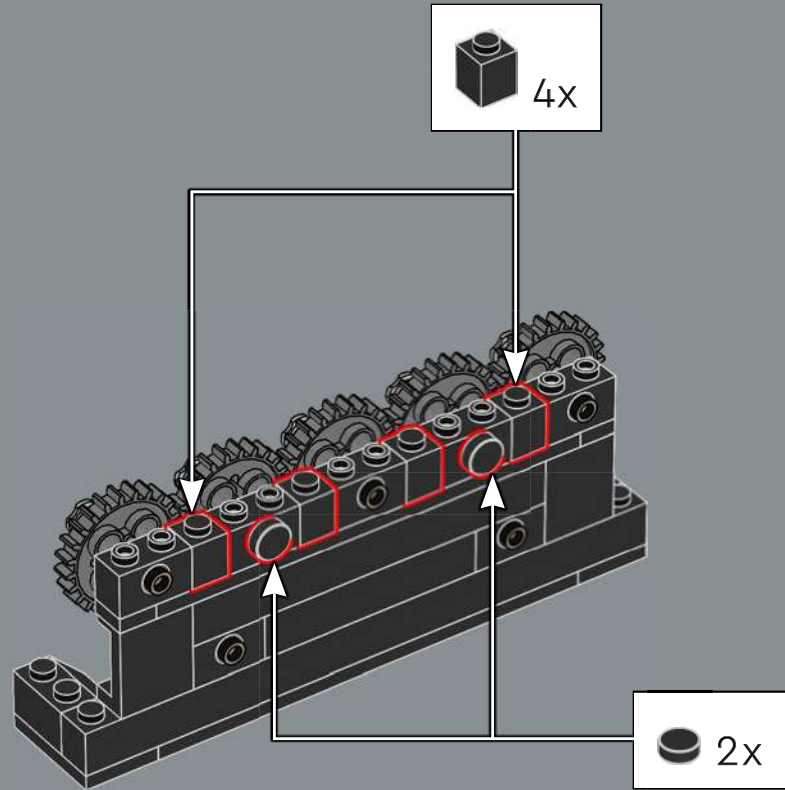

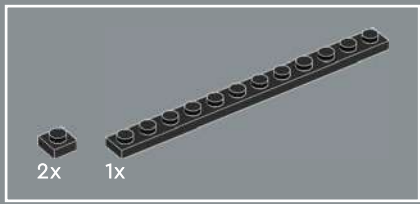

9

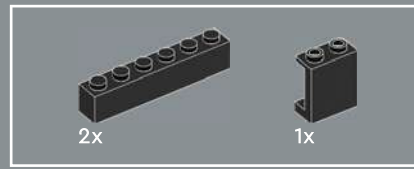
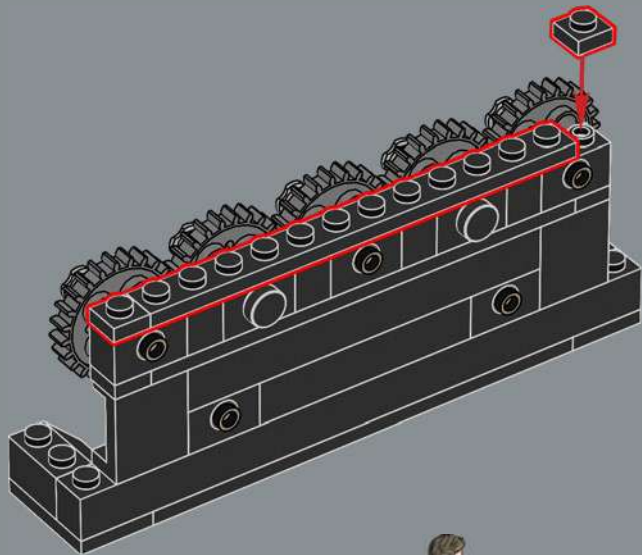

10

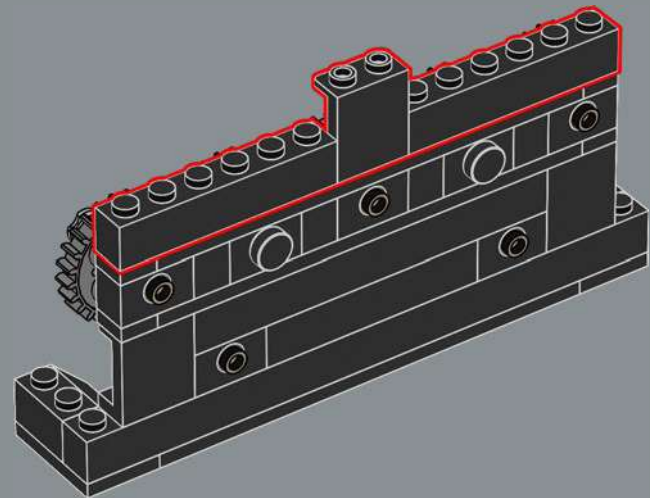

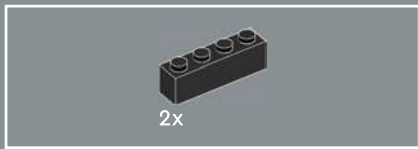

11

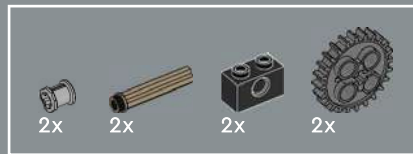
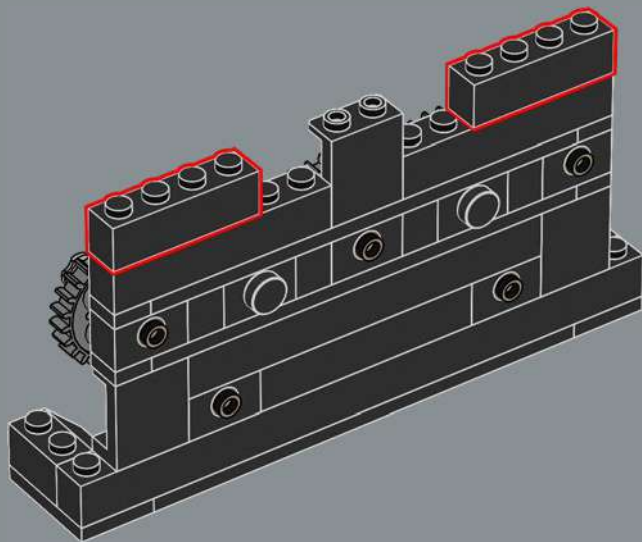

12

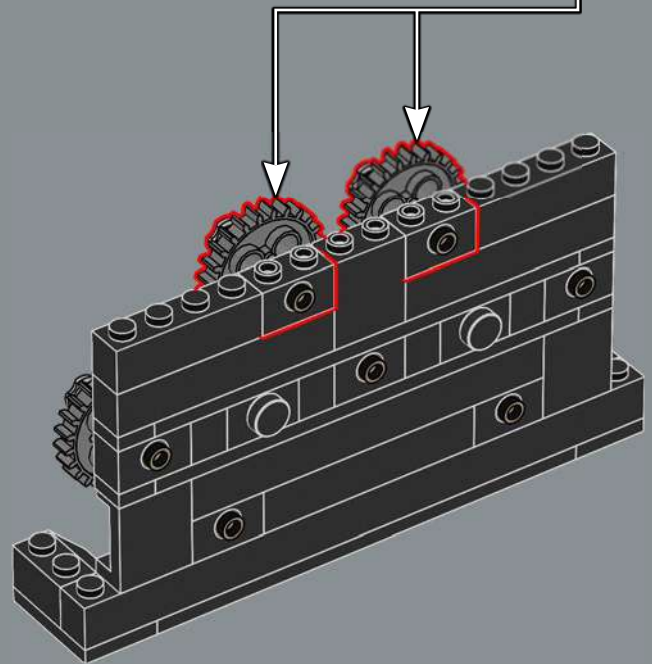
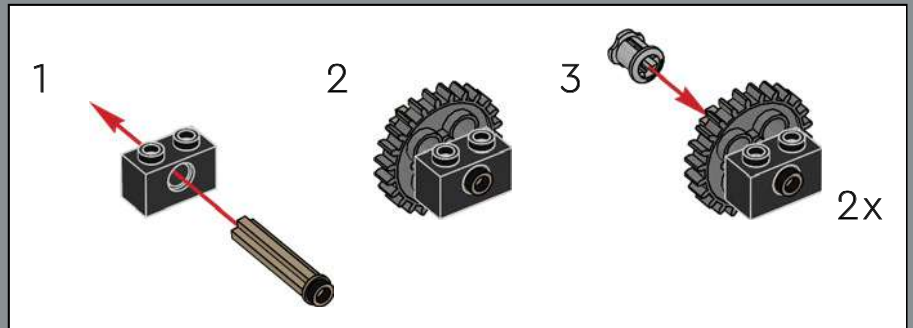

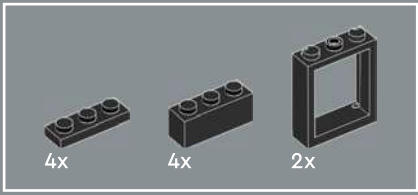

13

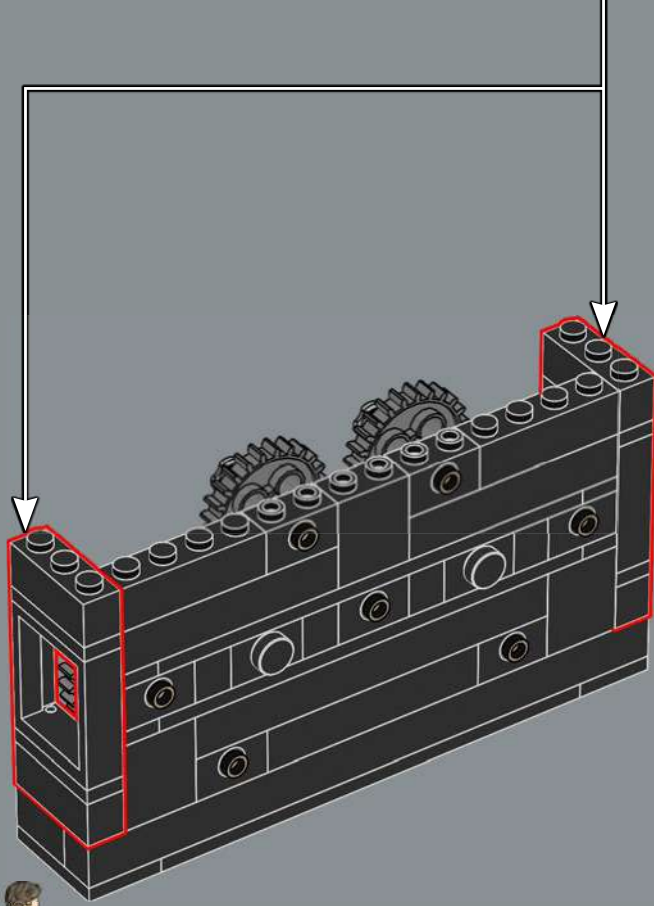
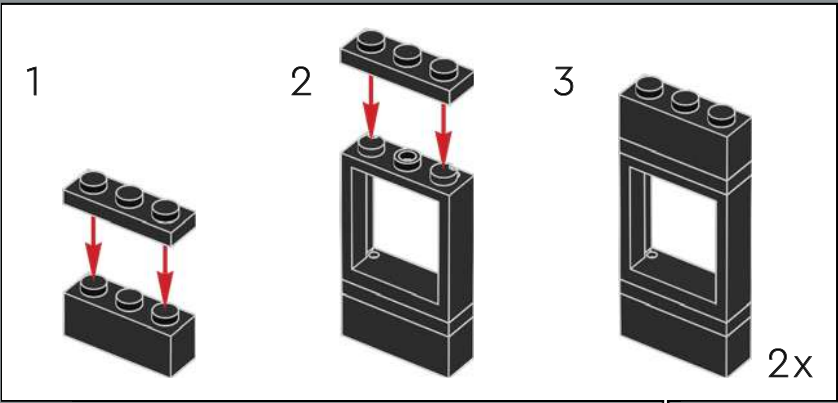

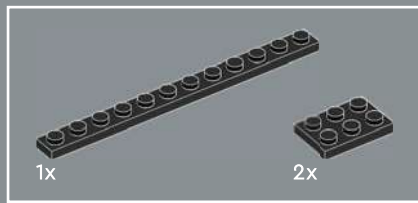

14

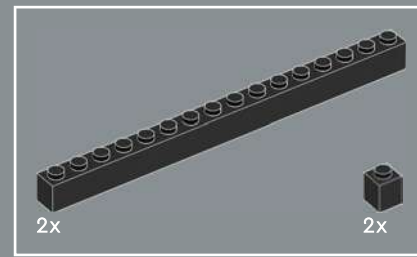
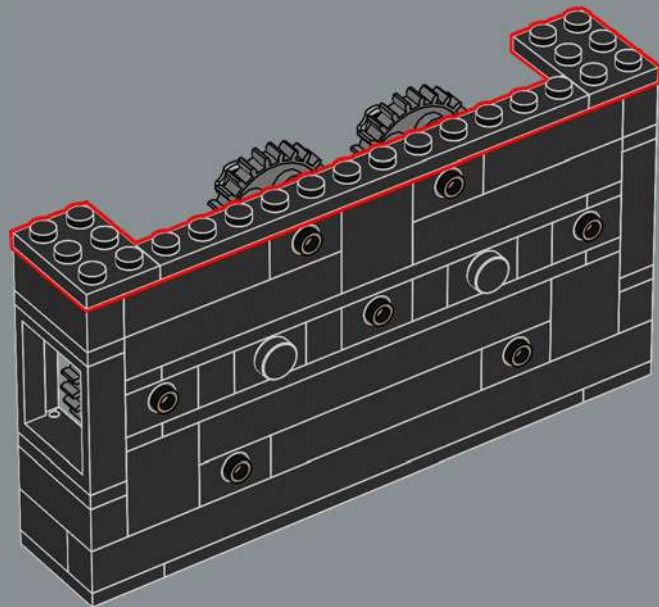

15

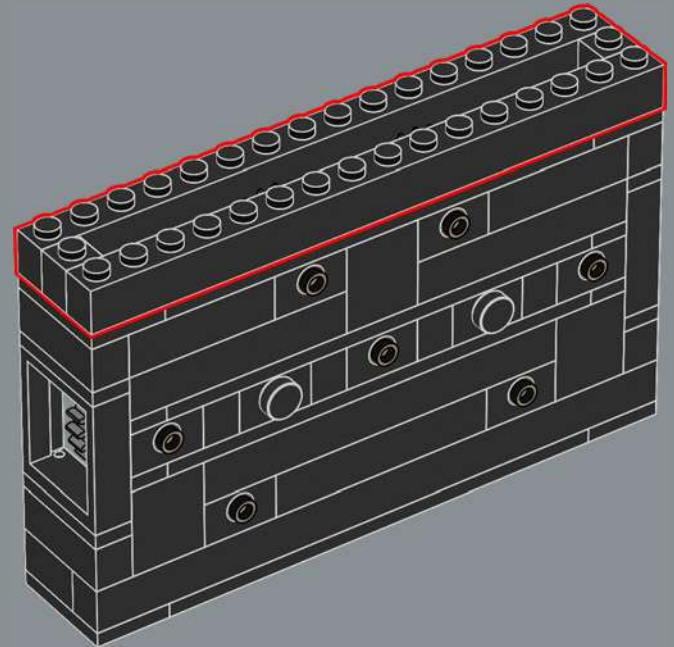

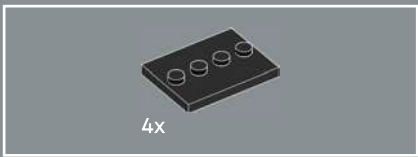

16

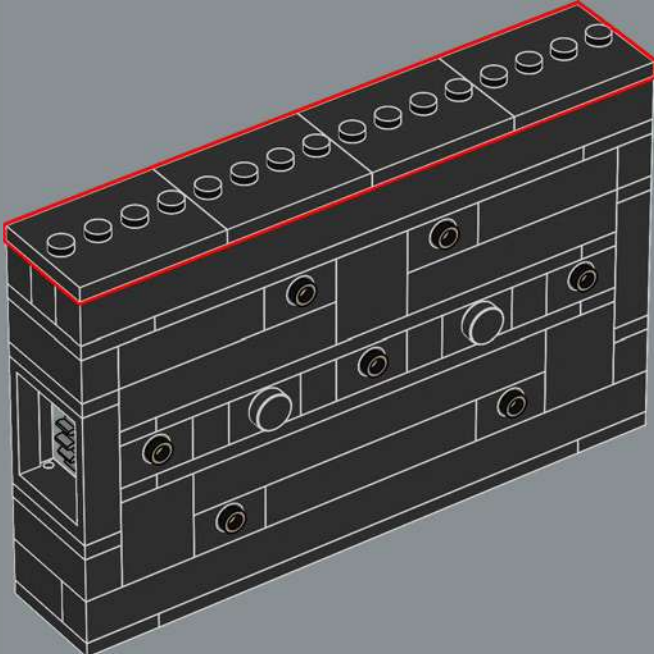

17

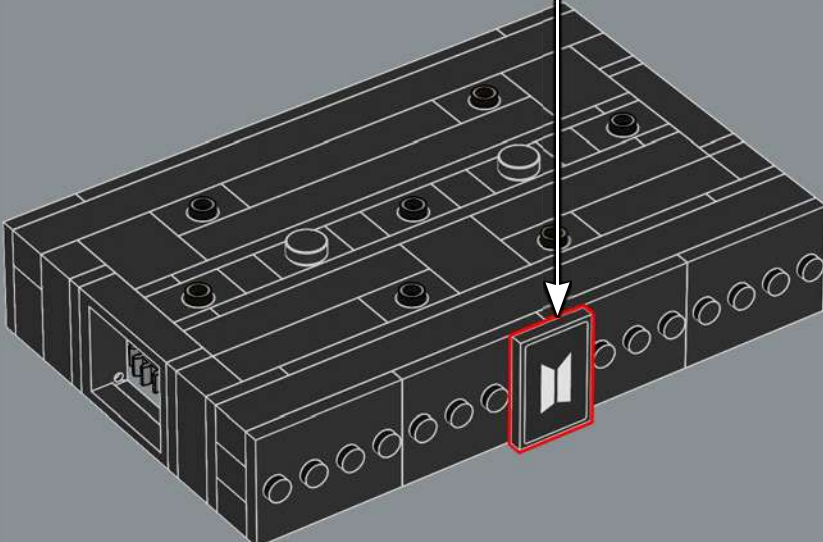
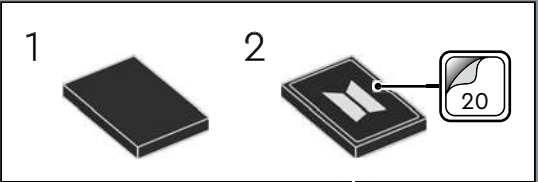

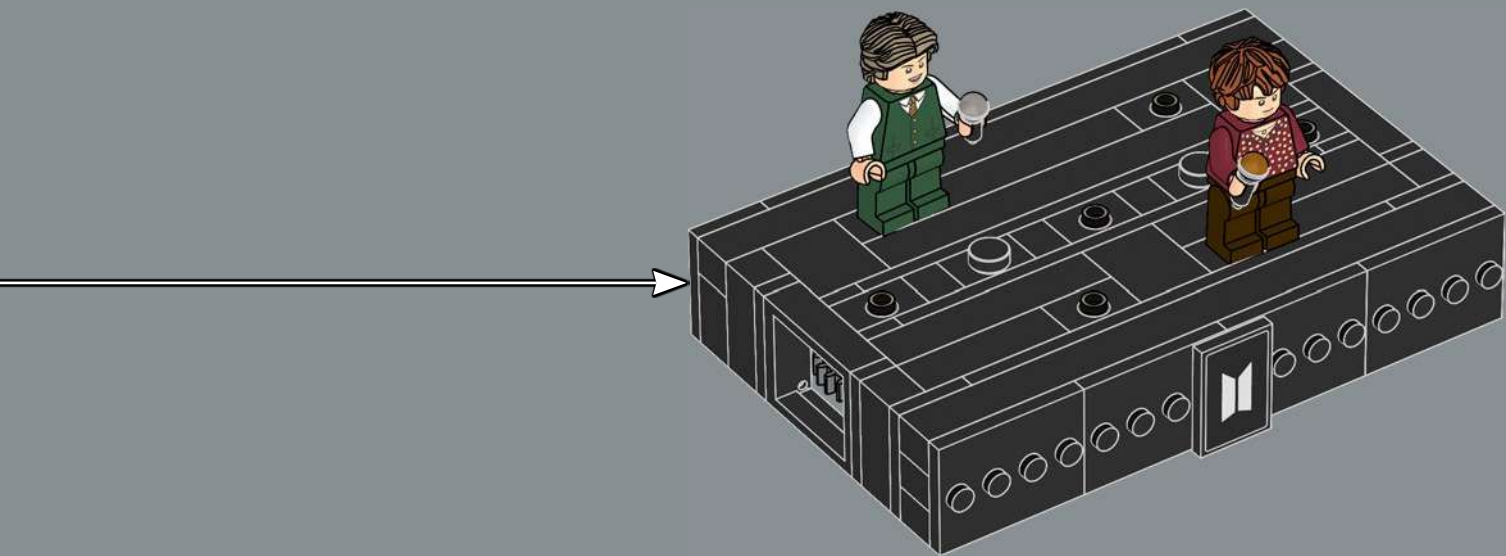

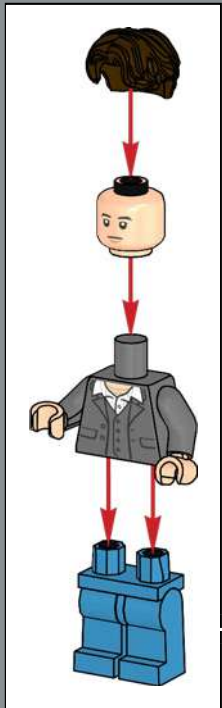
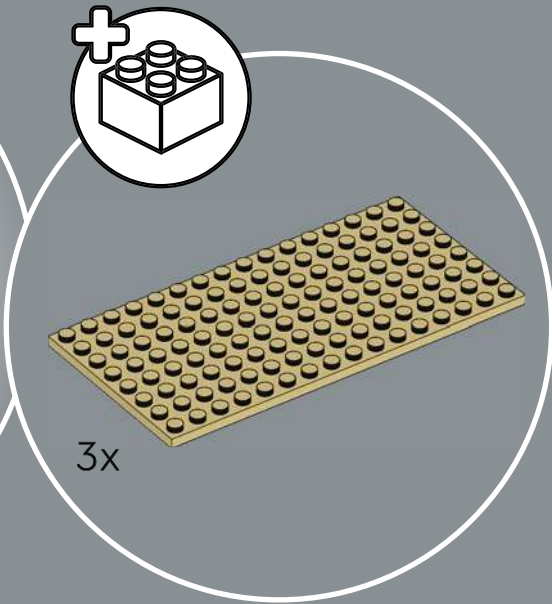

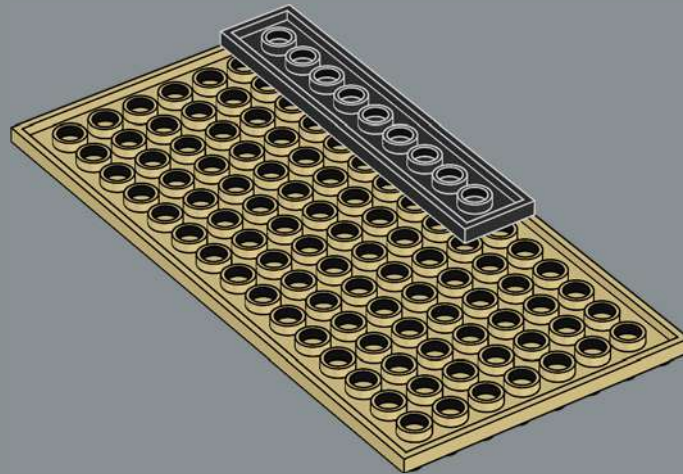
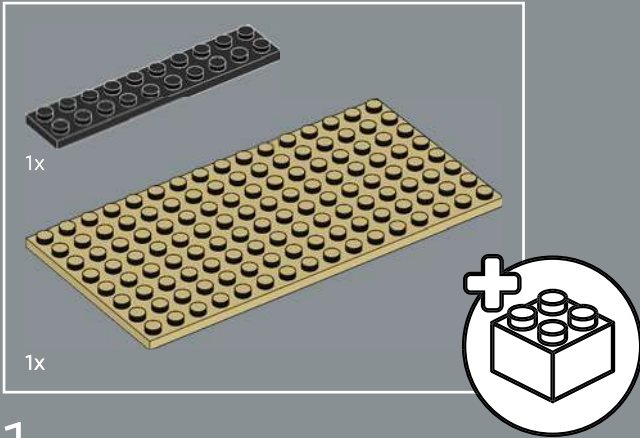
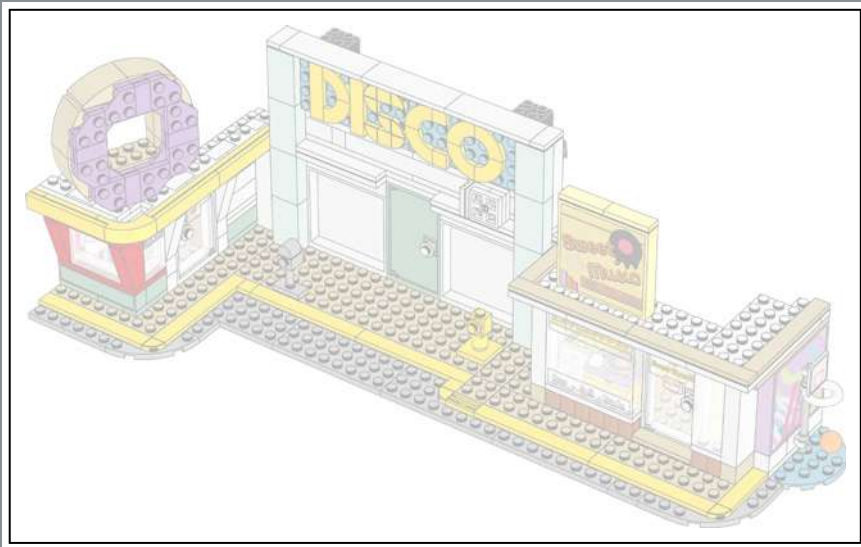

1

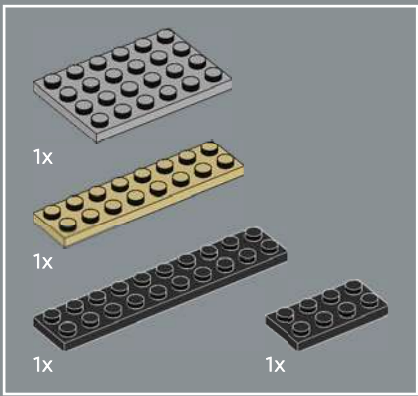

2

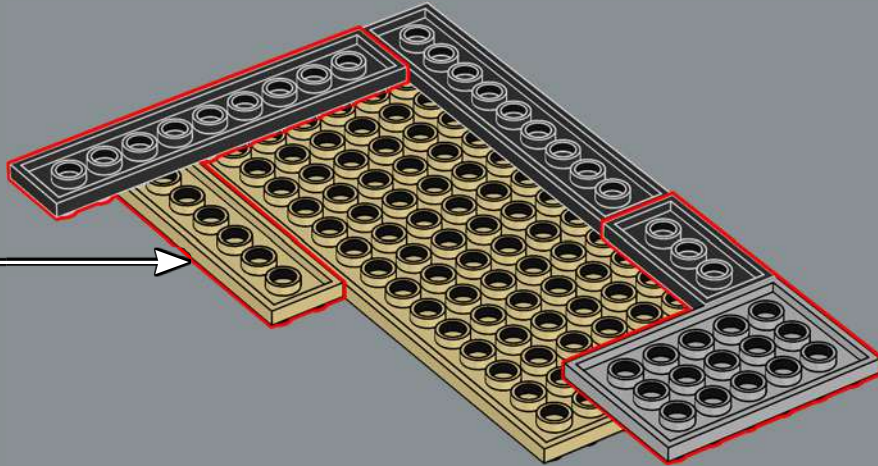
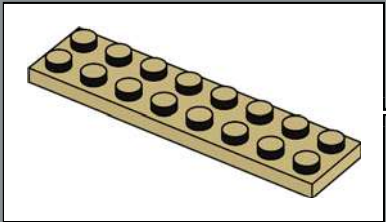

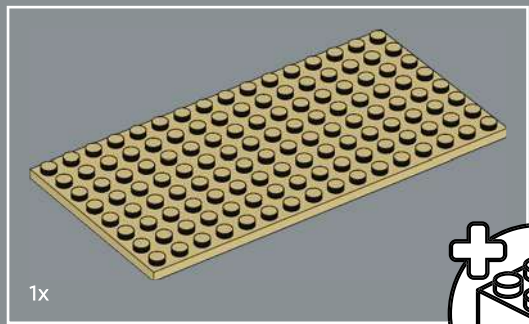

1x

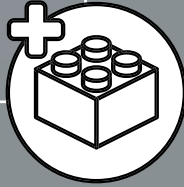

3

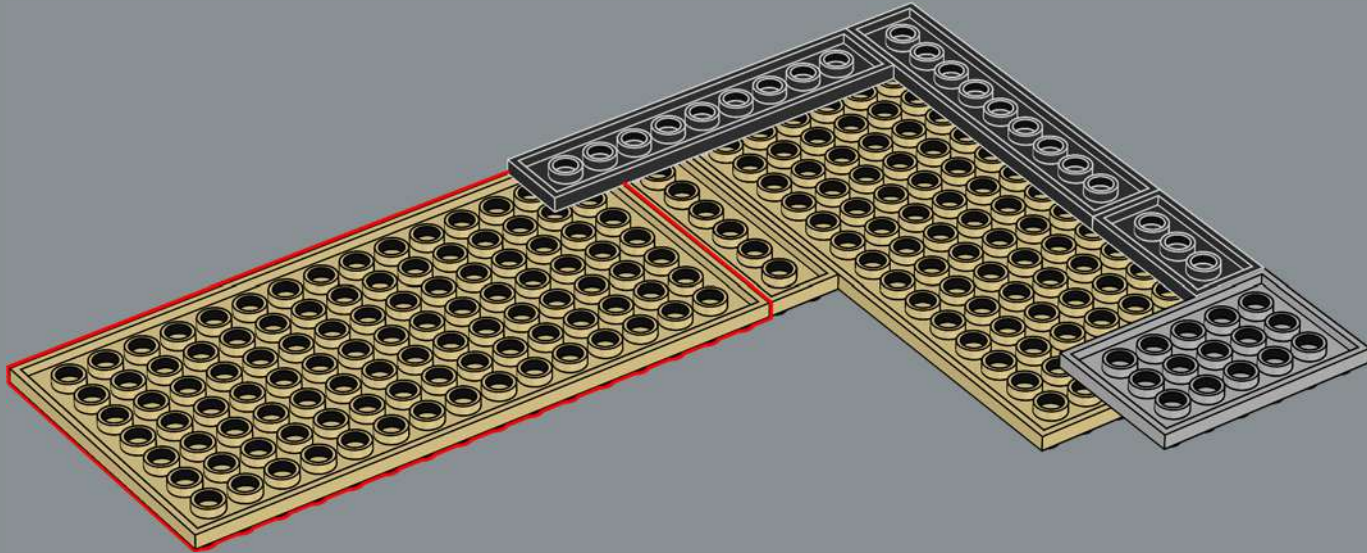

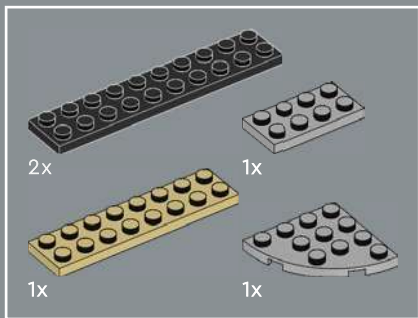

4

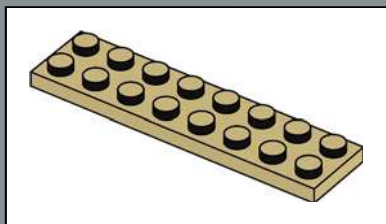
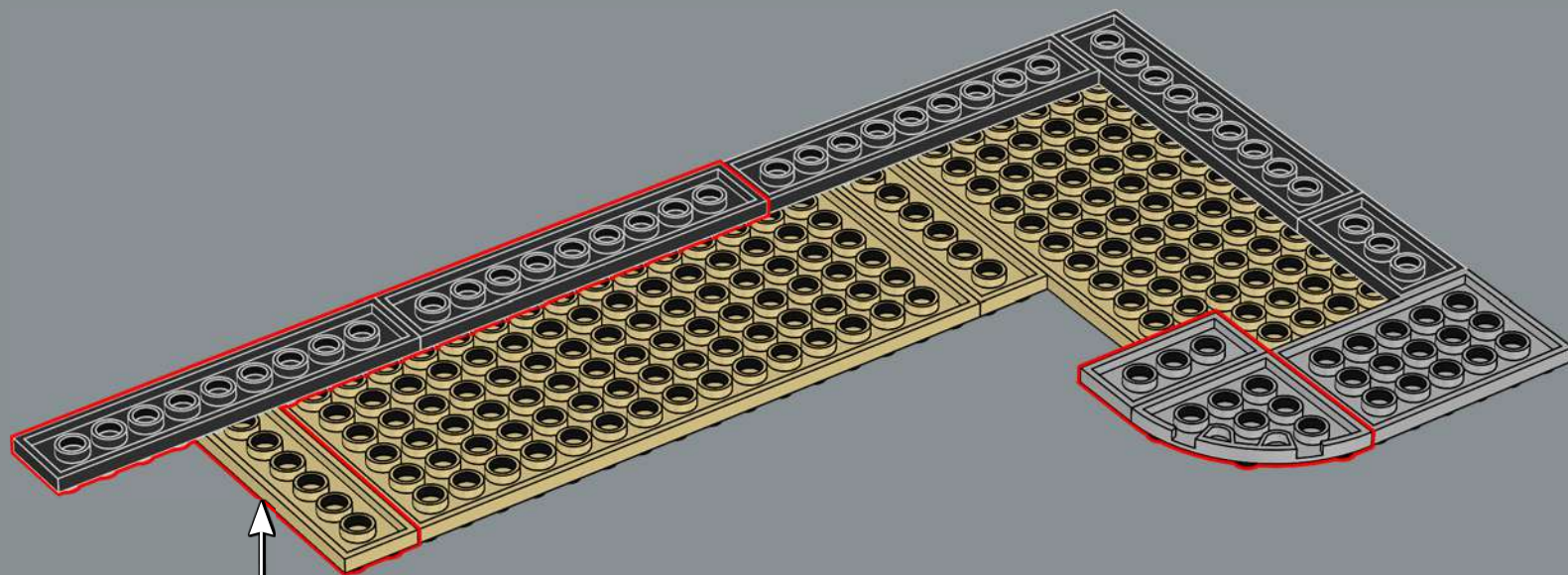

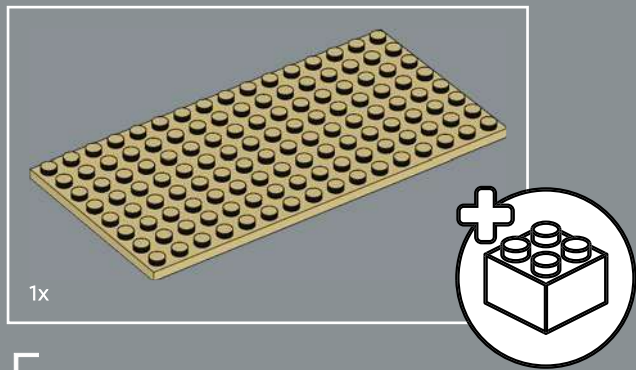

5

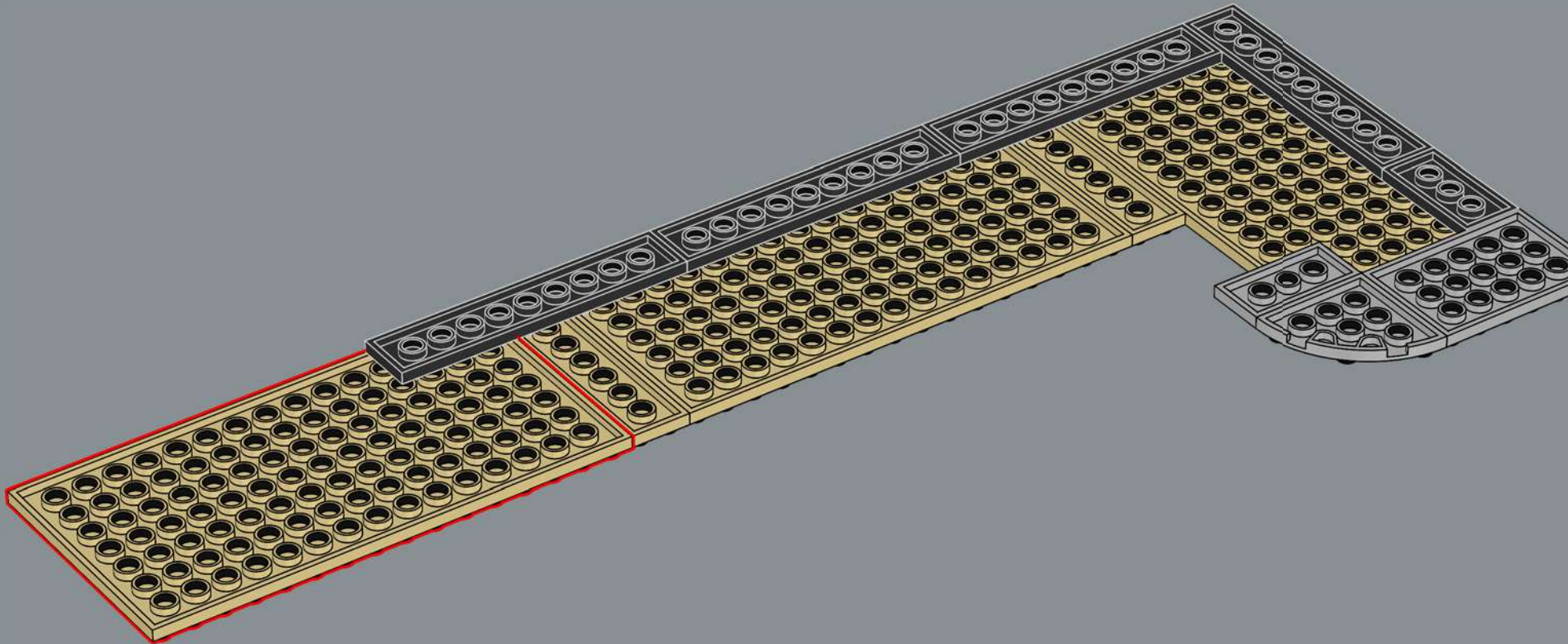

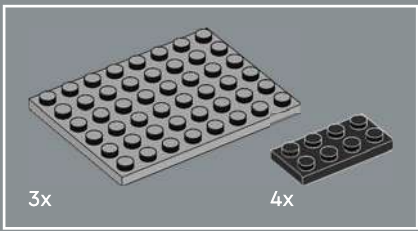

6

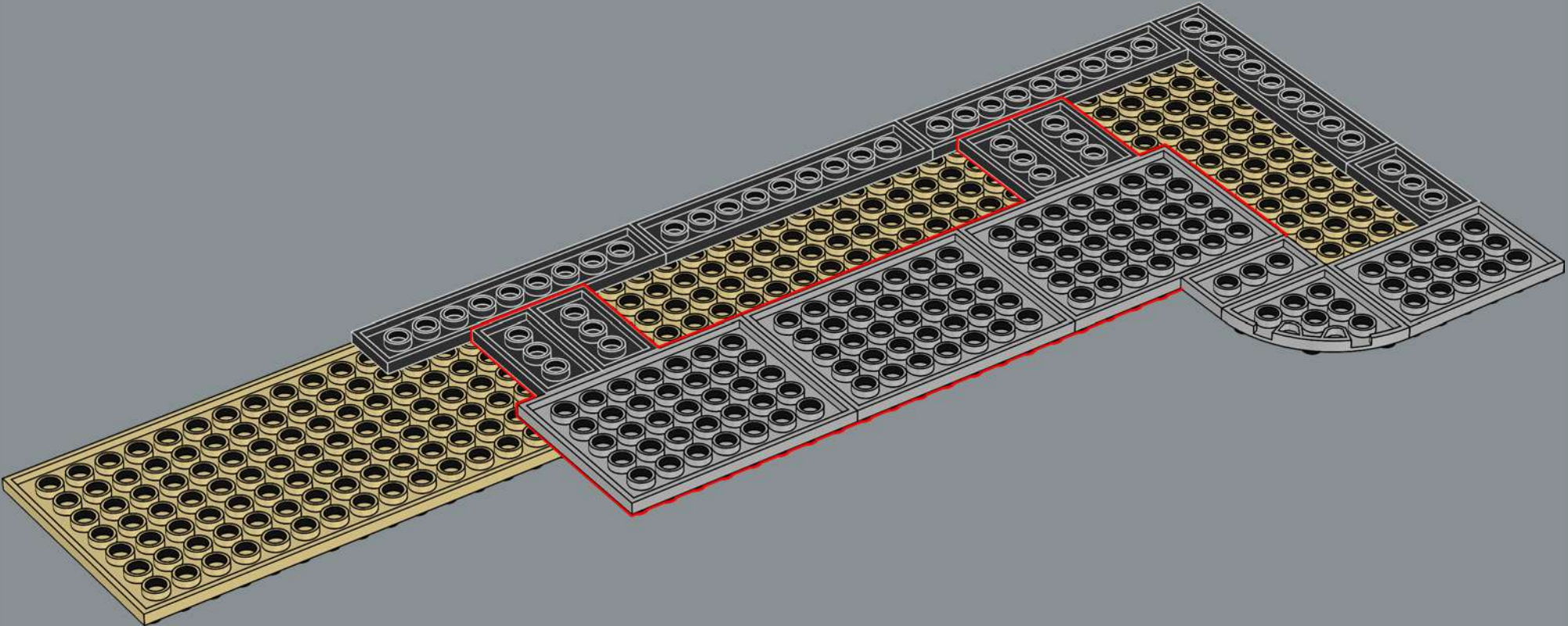

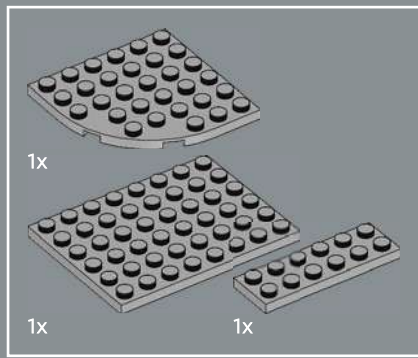

7

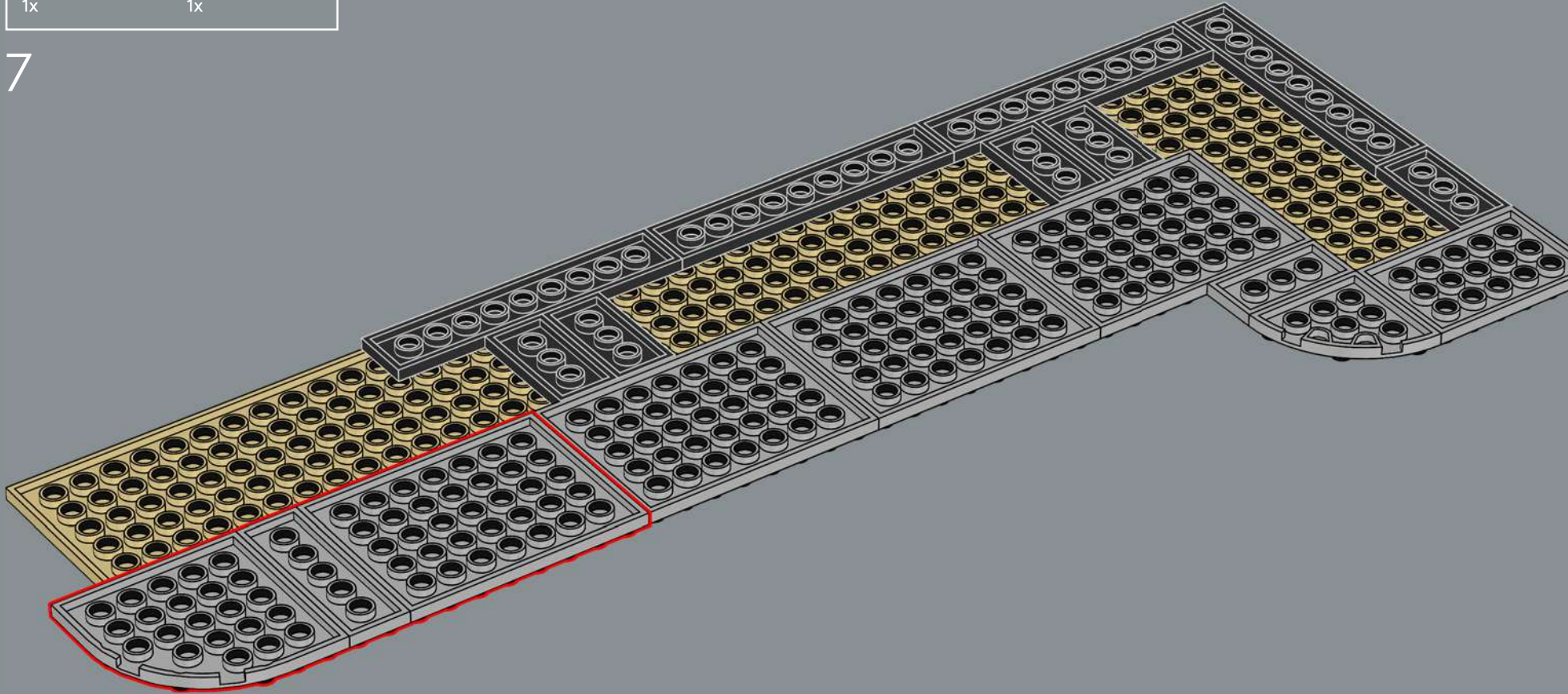

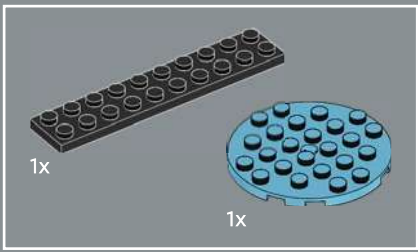

8

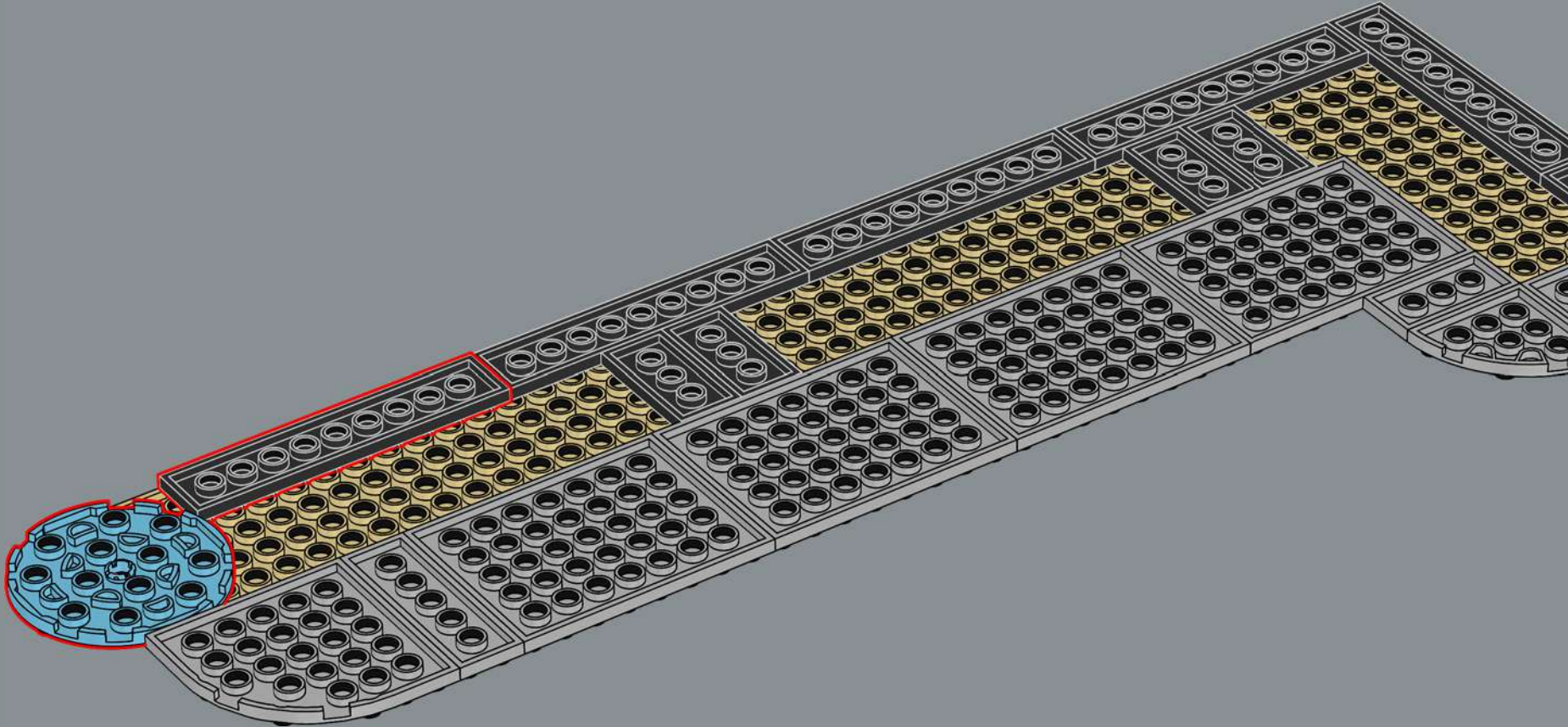

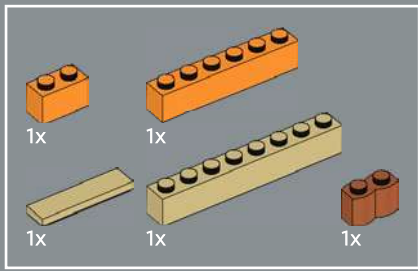

9

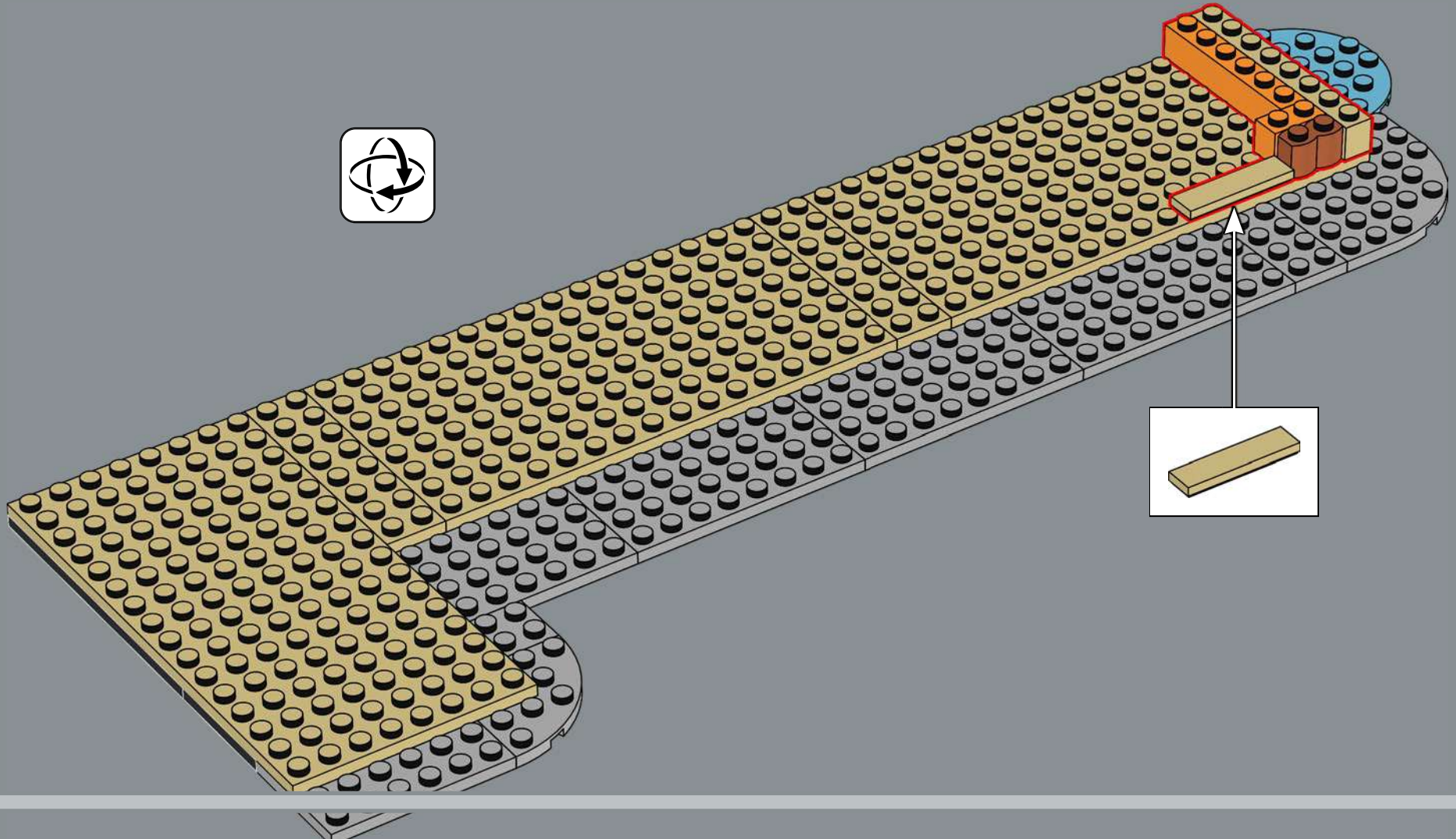

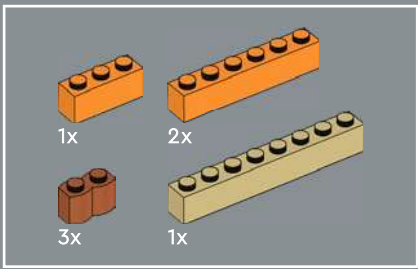

10

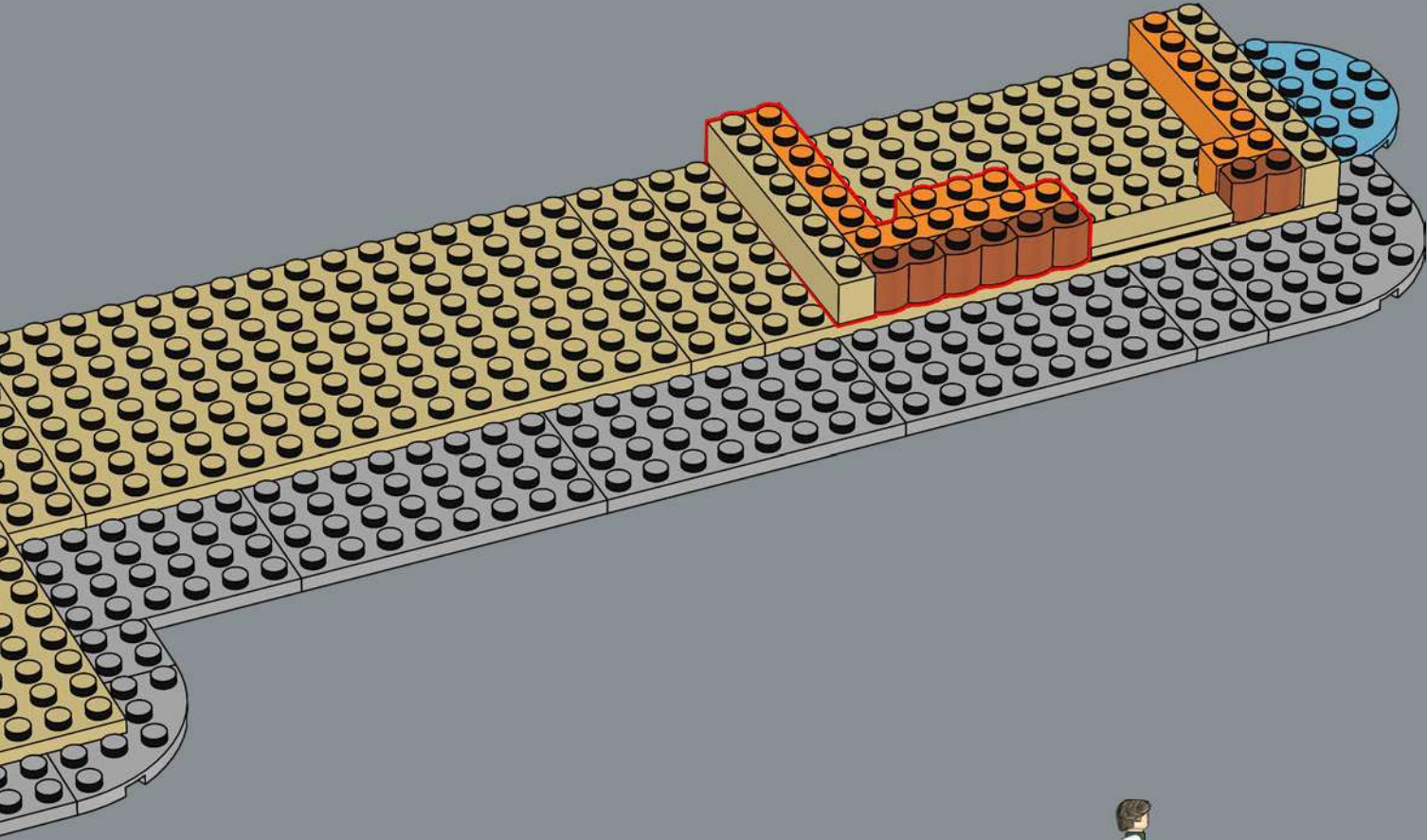

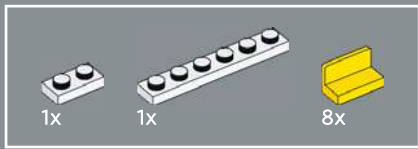

11

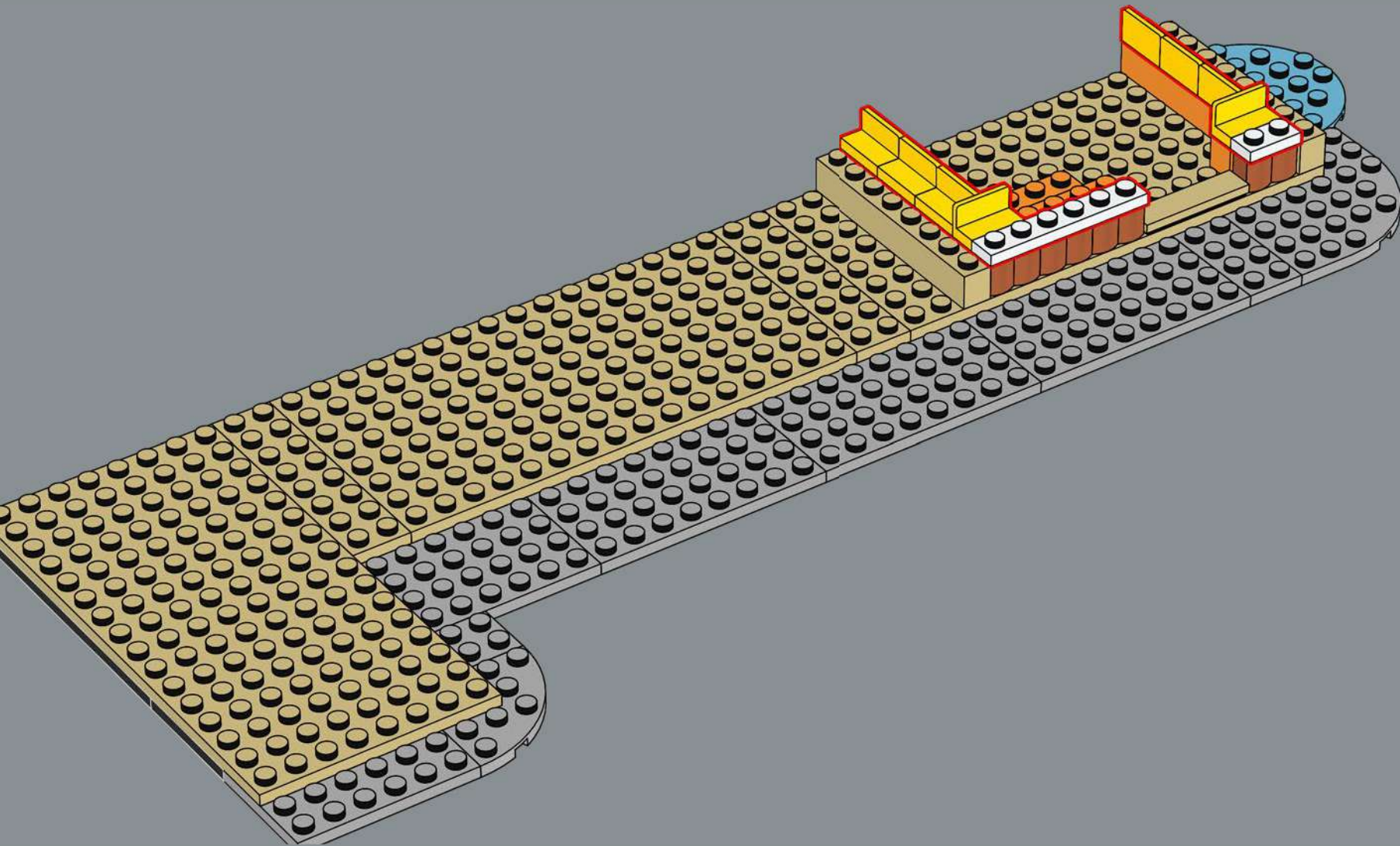

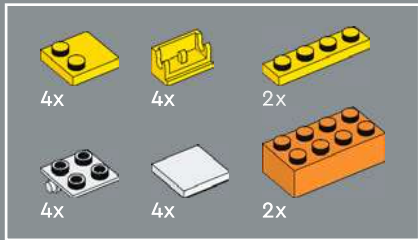

12

1

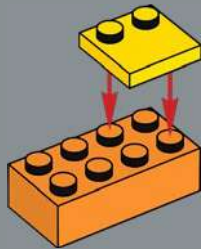

2

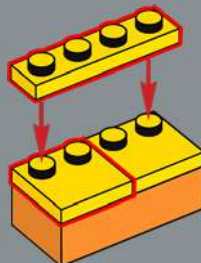

3

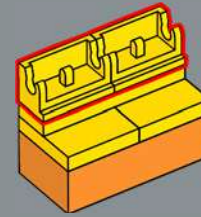

4

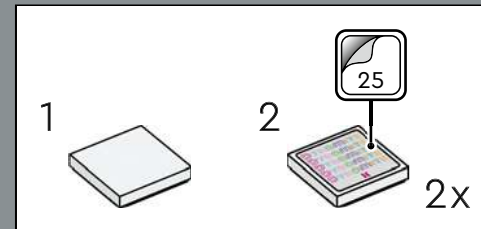

5

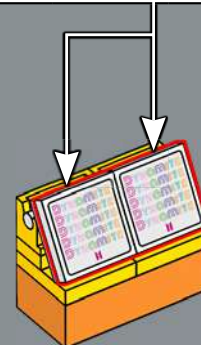

2x



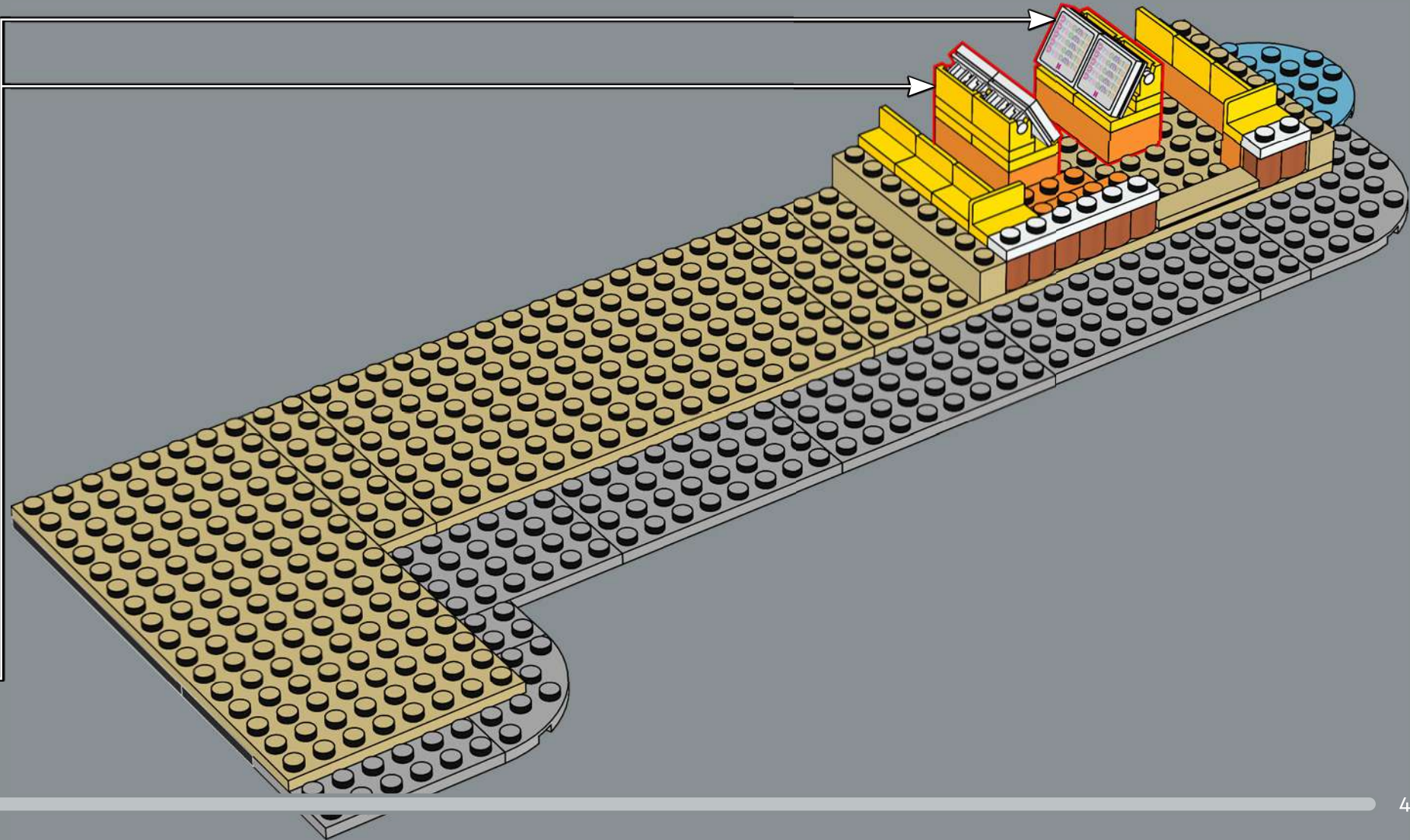

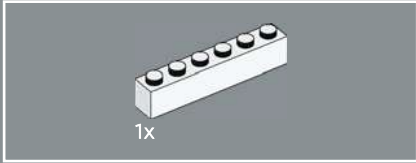

13

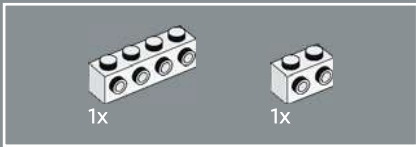
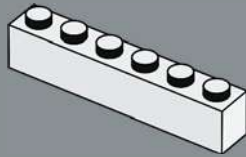

14

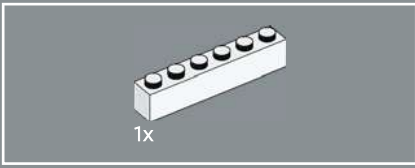
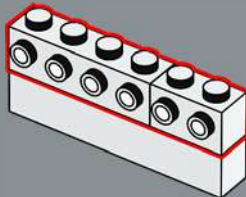

15

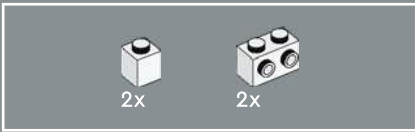
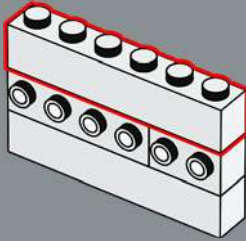

16

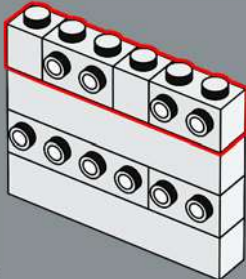

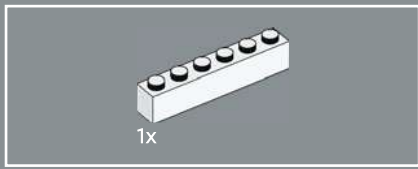

17

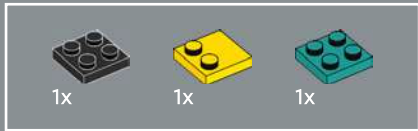
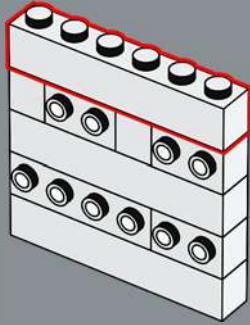

18

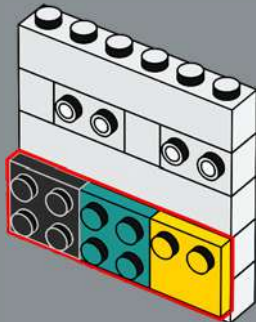

19

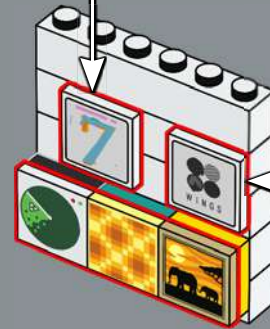
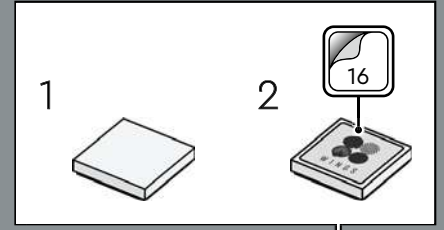
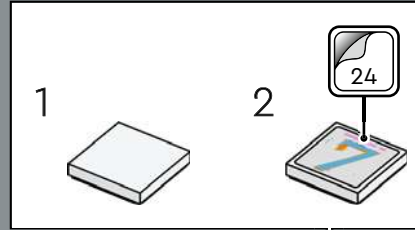

20

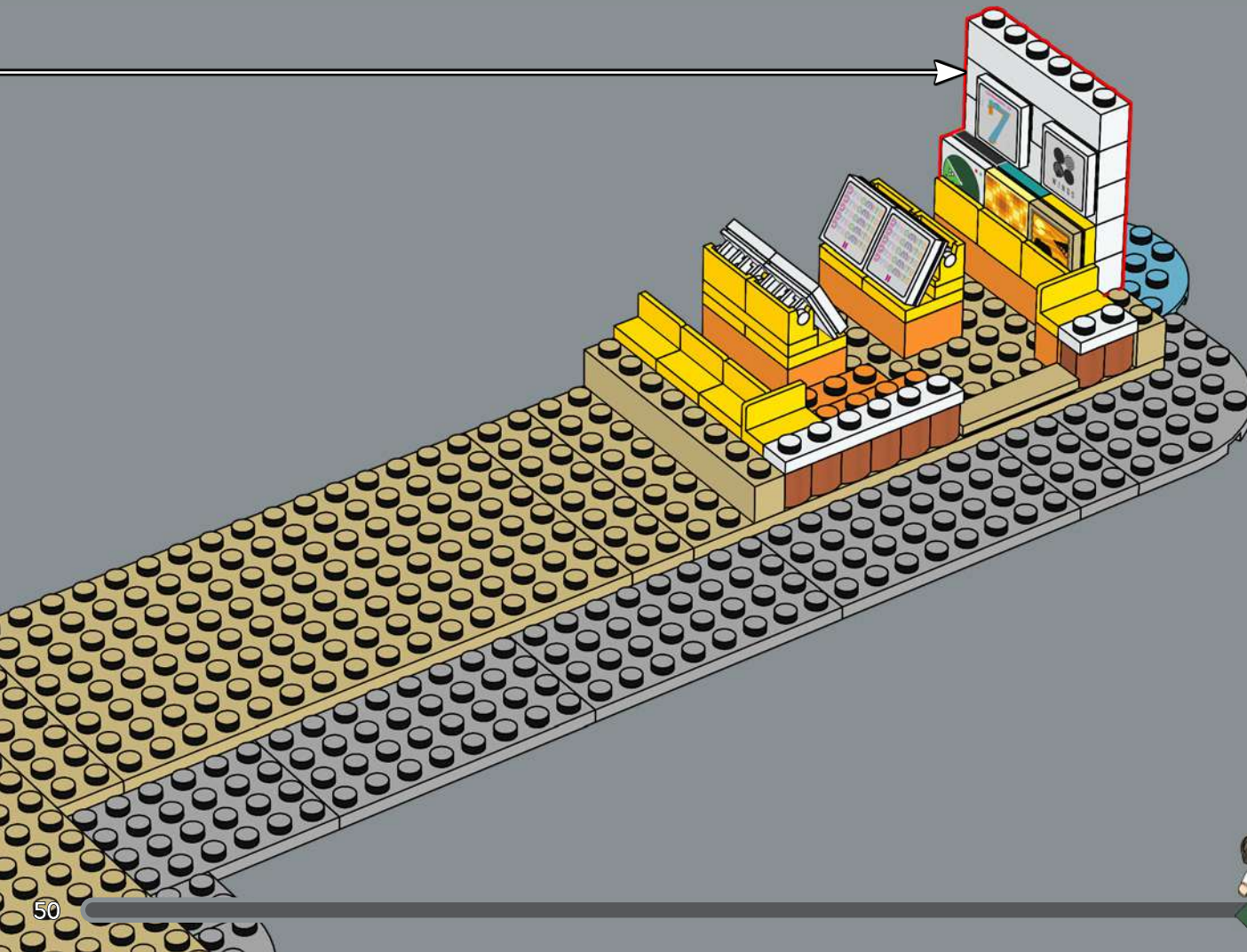

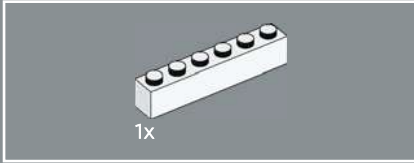

21

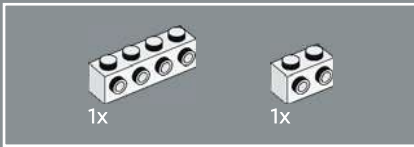
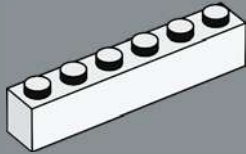

22

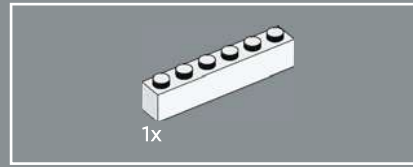
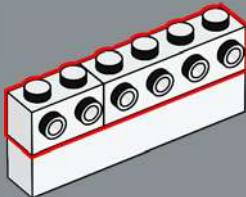

23

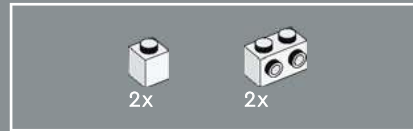
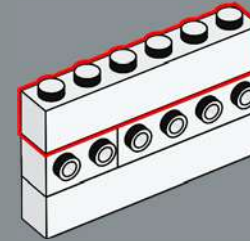

24

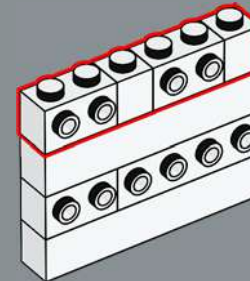

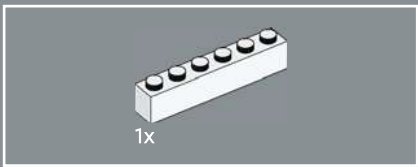

25

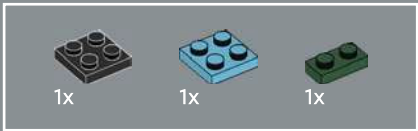
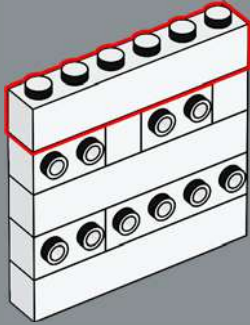

26

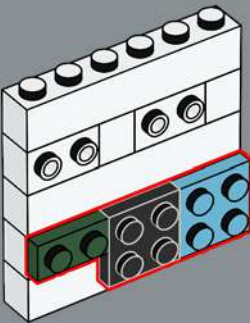

27

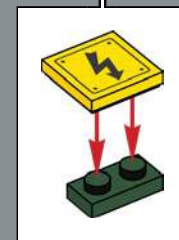
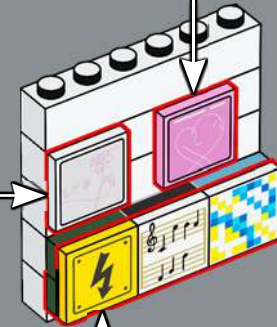
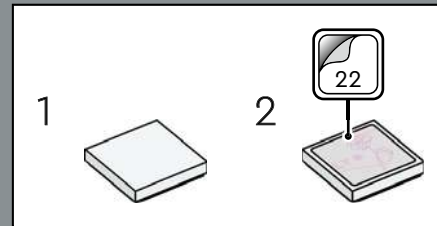
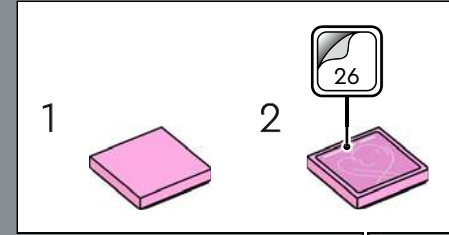

28

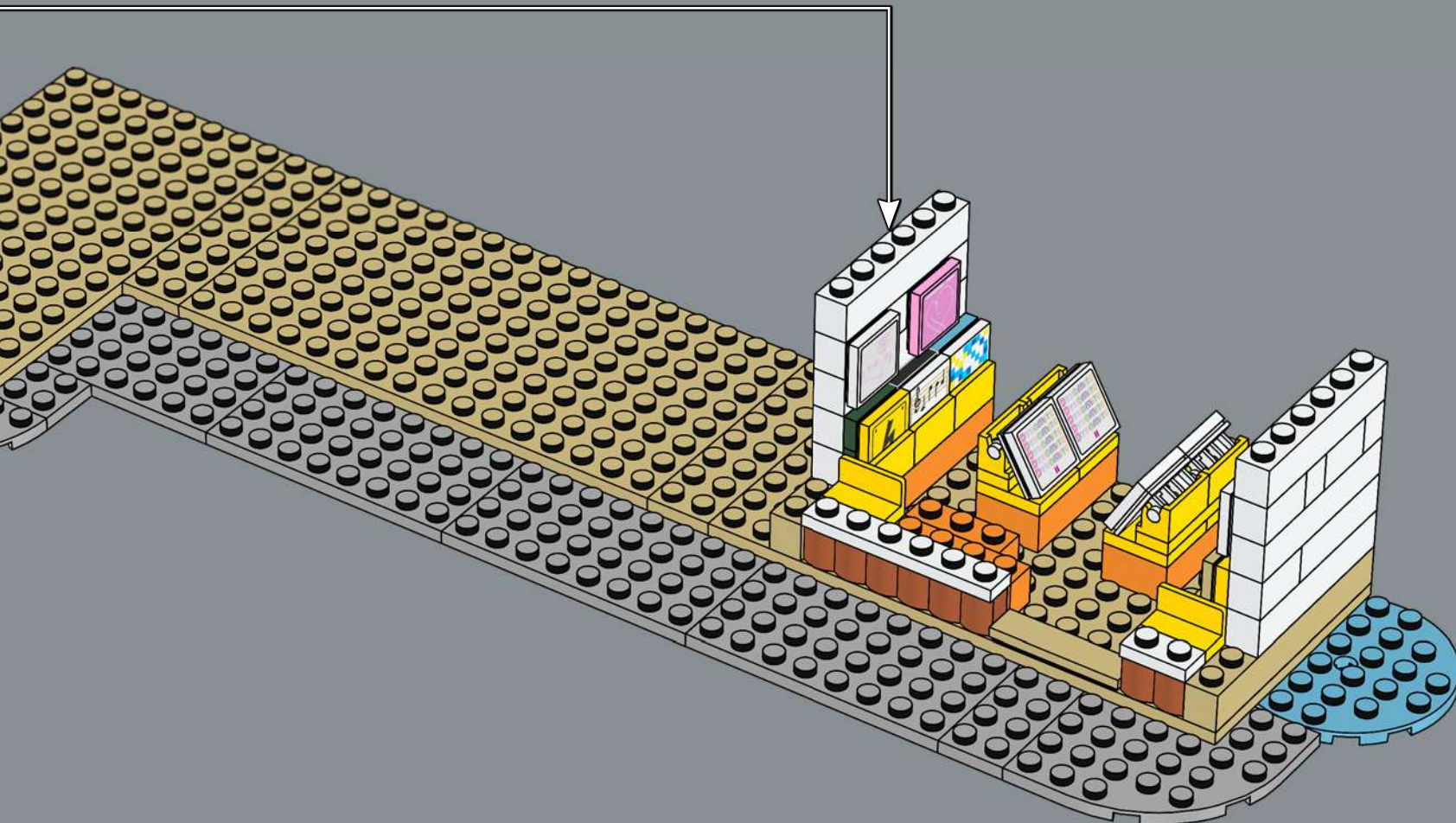

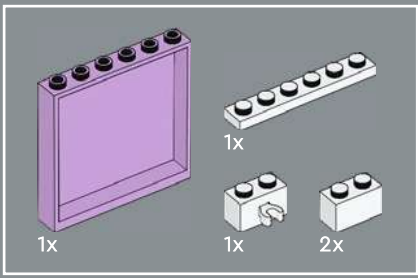

29

1

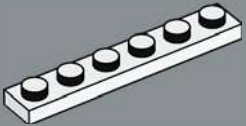

2

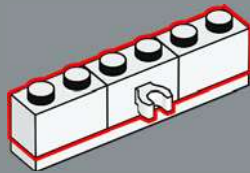

3

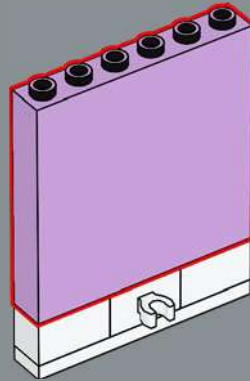

4



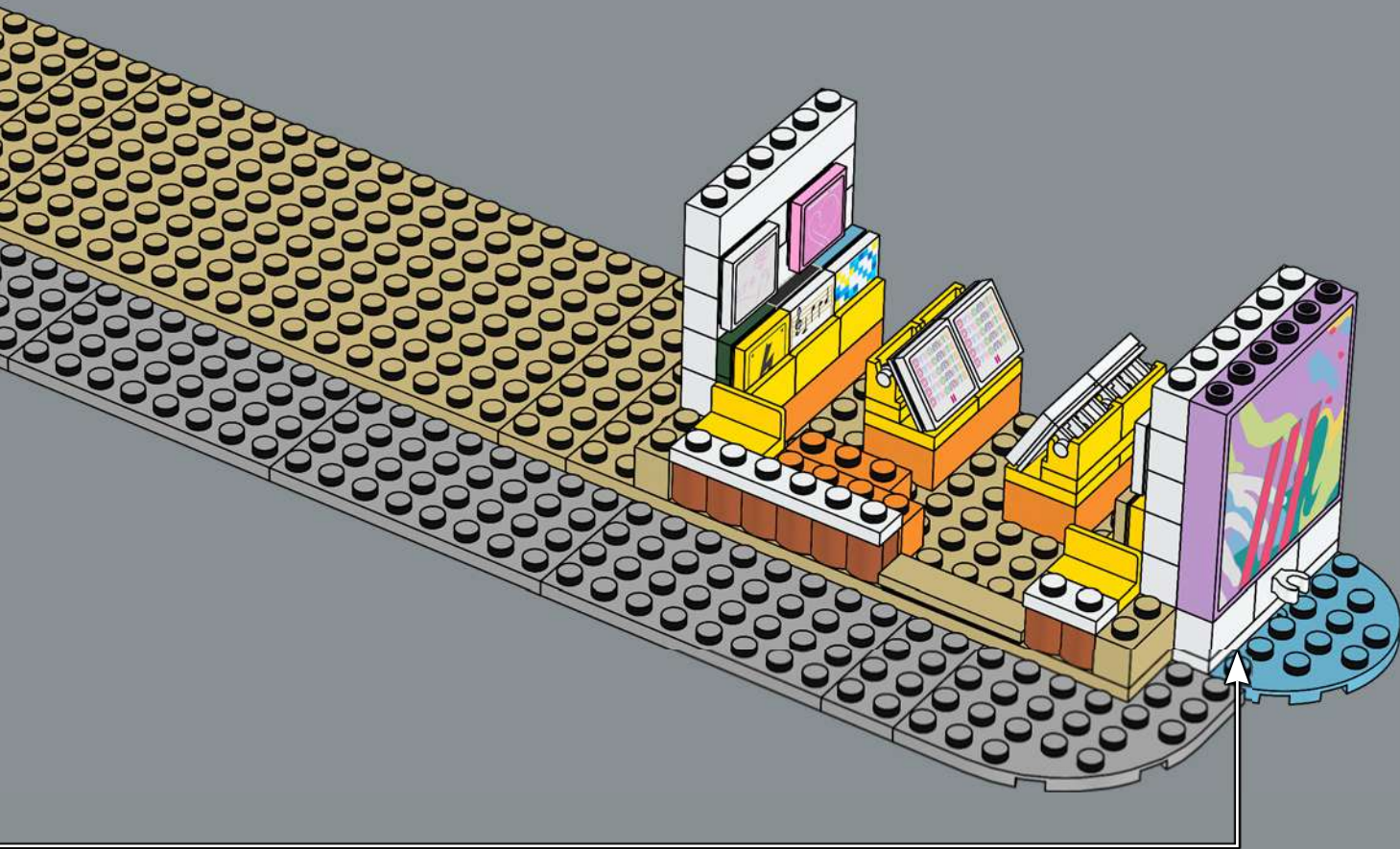

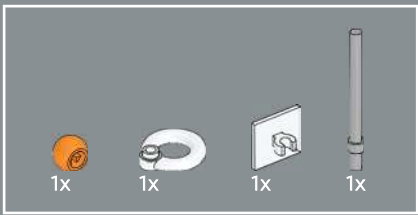

30

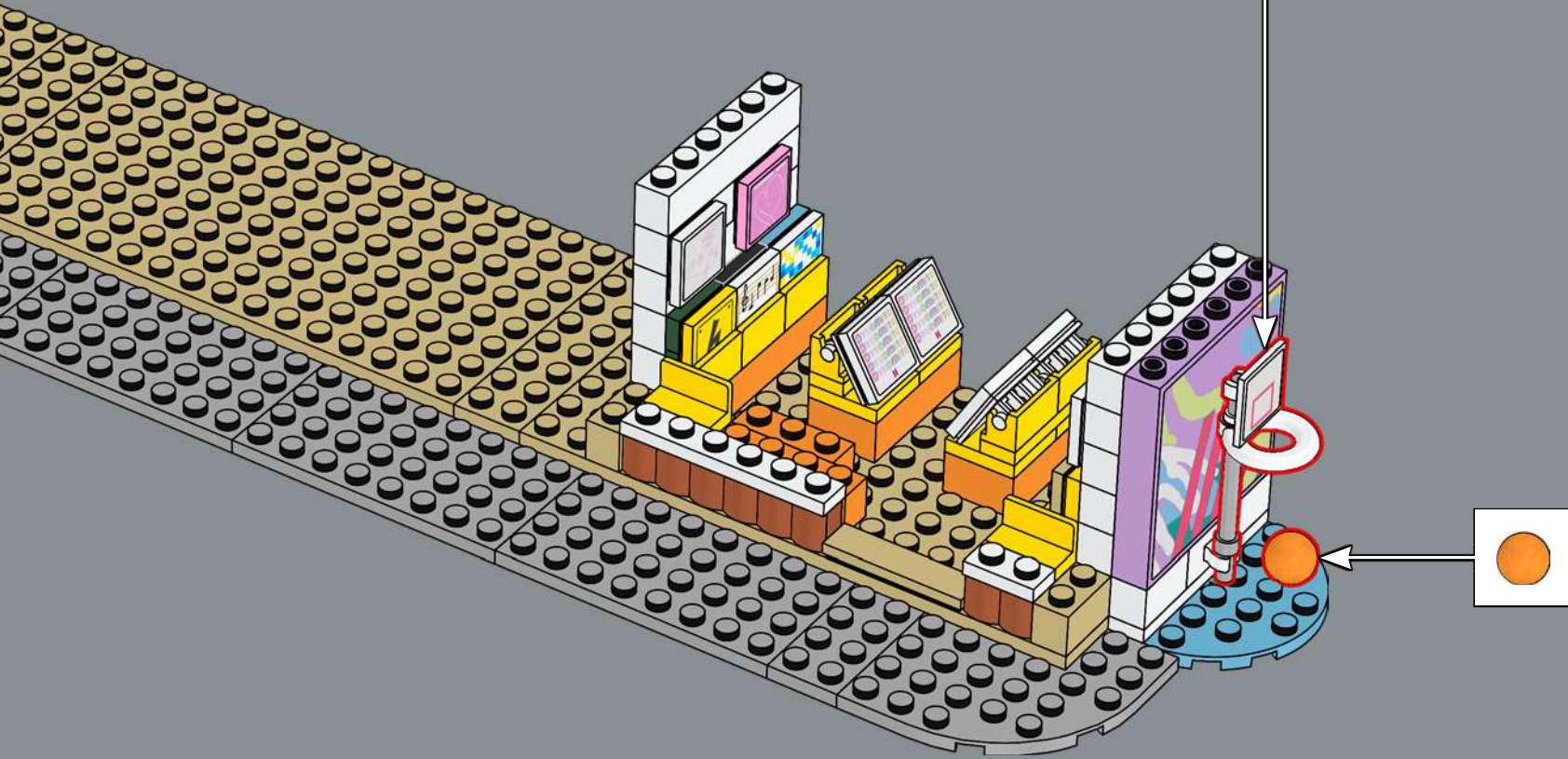
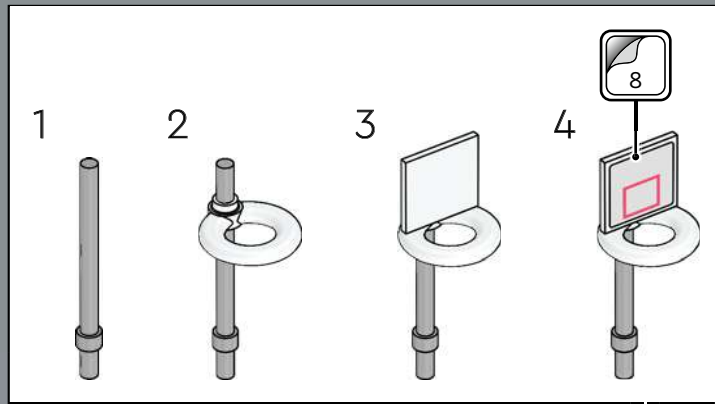

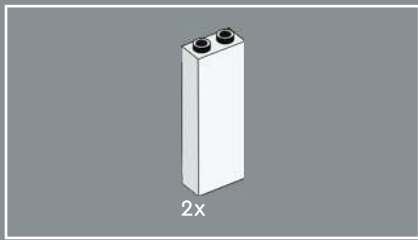

31

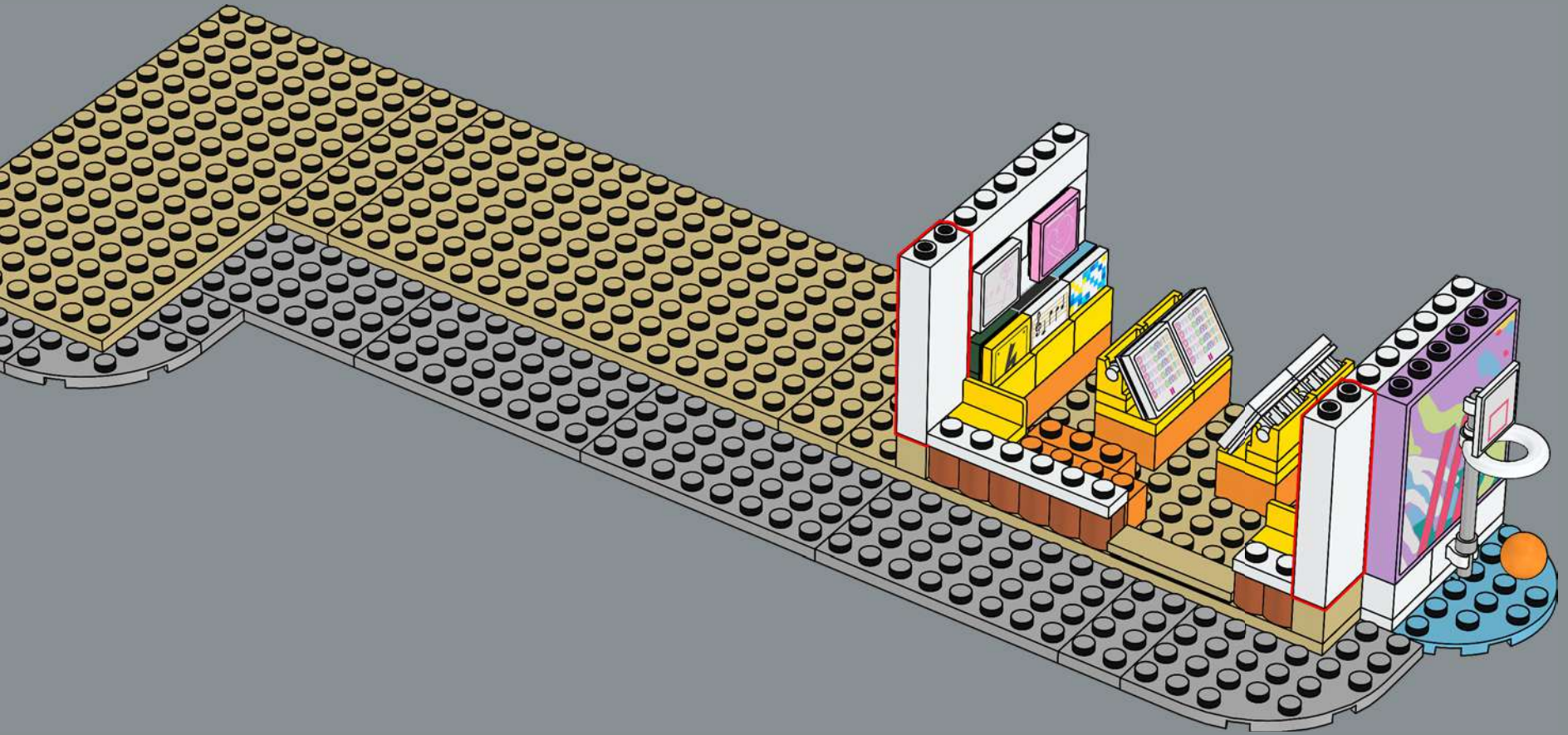

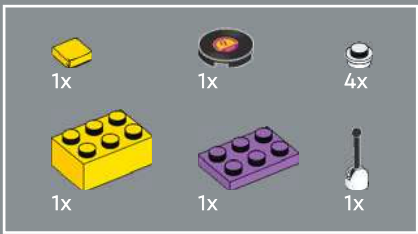

32

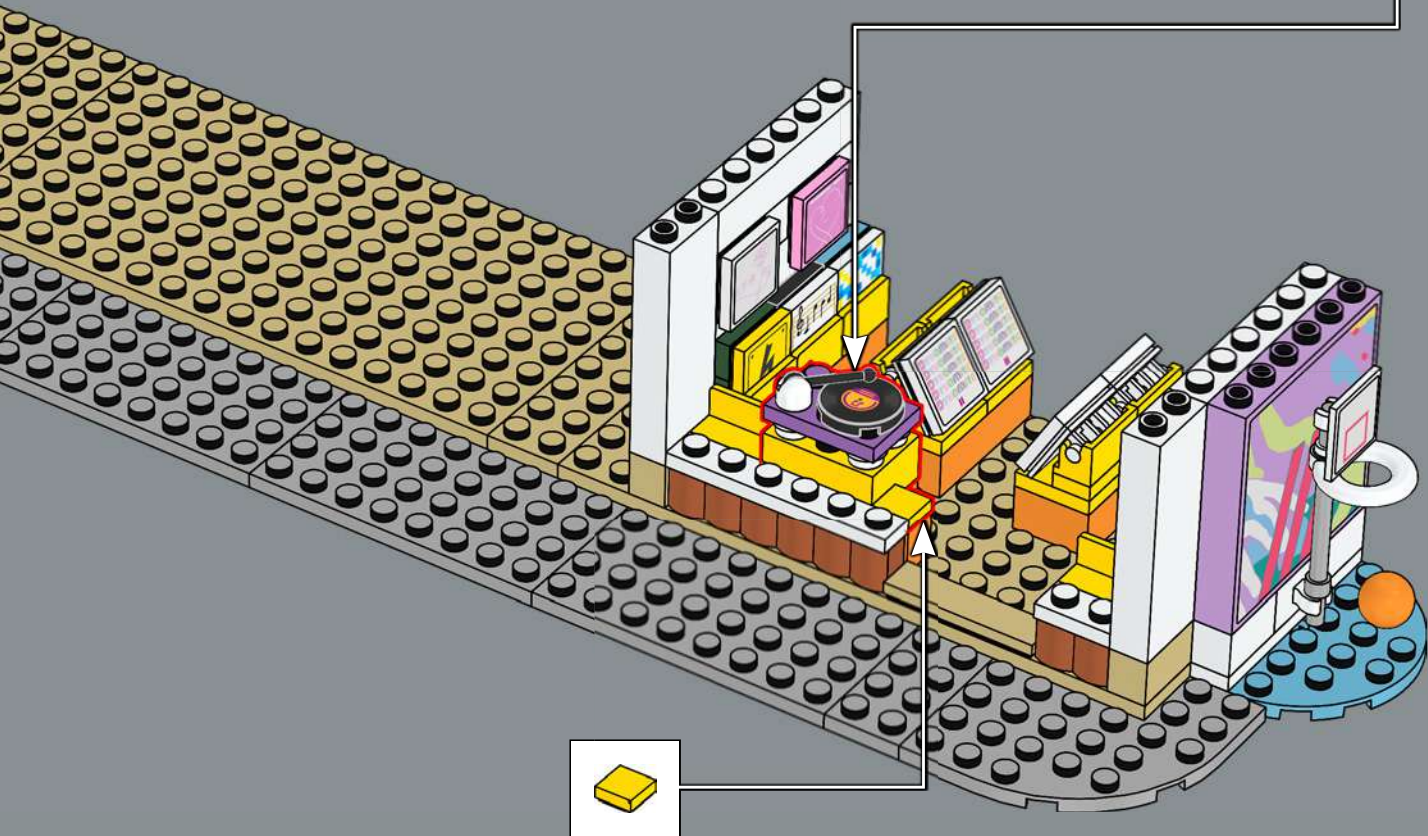
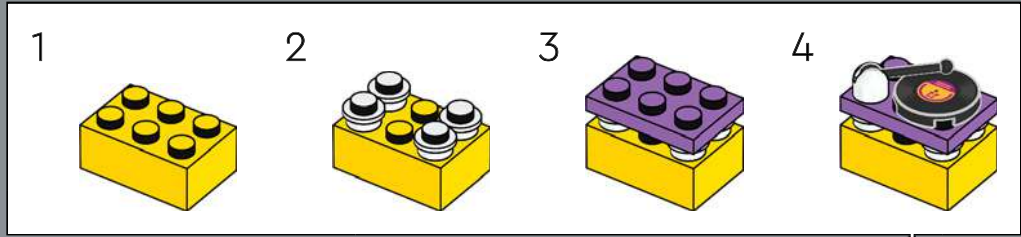

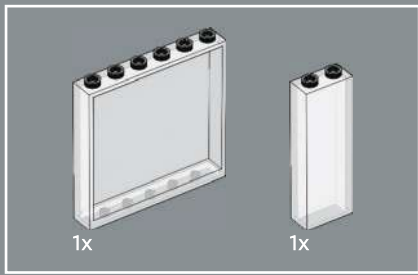

33

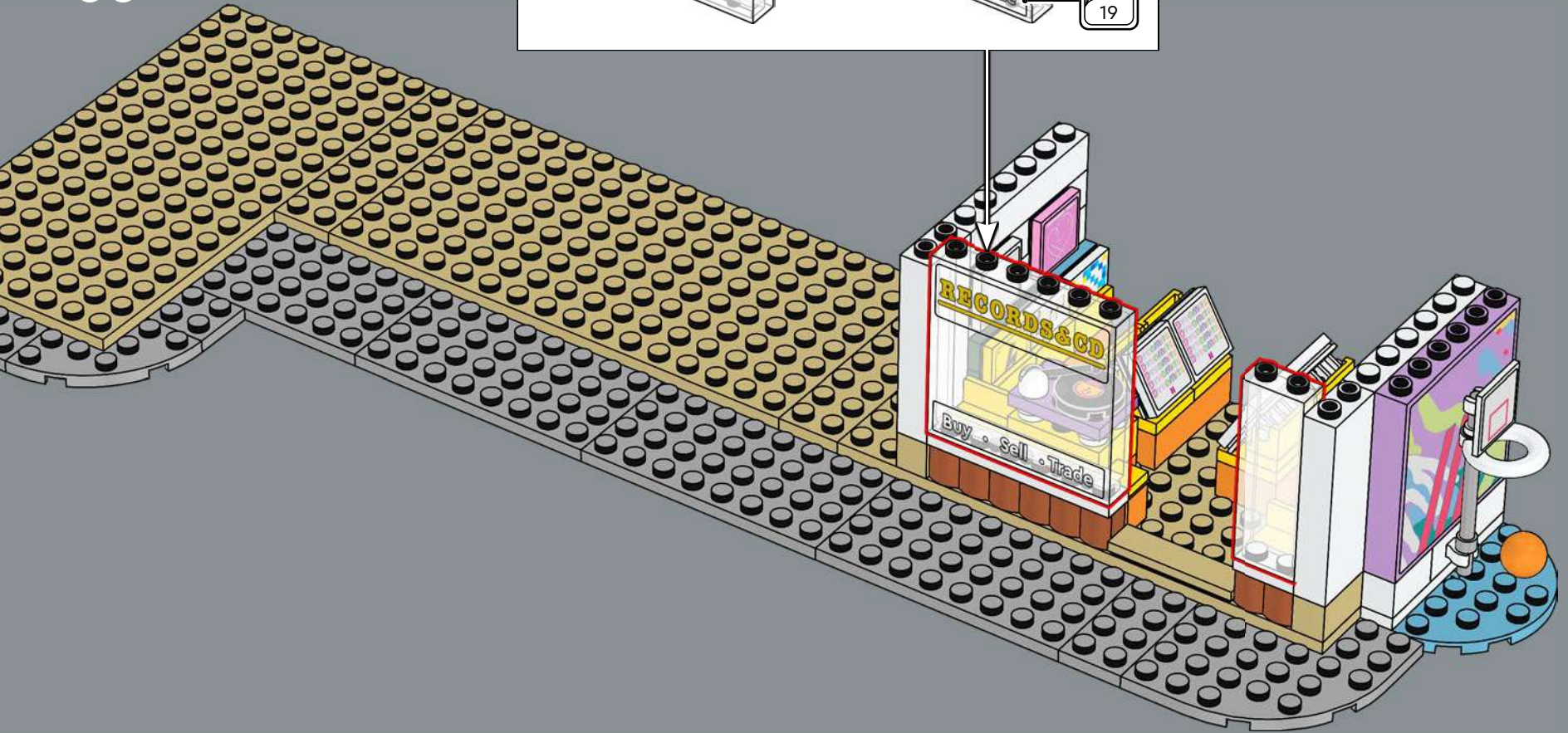
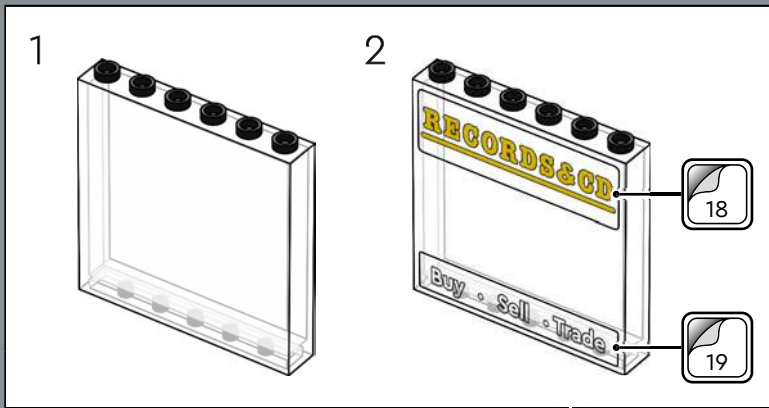

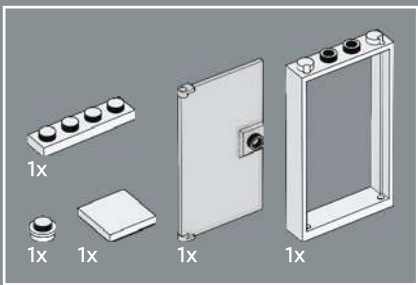

34

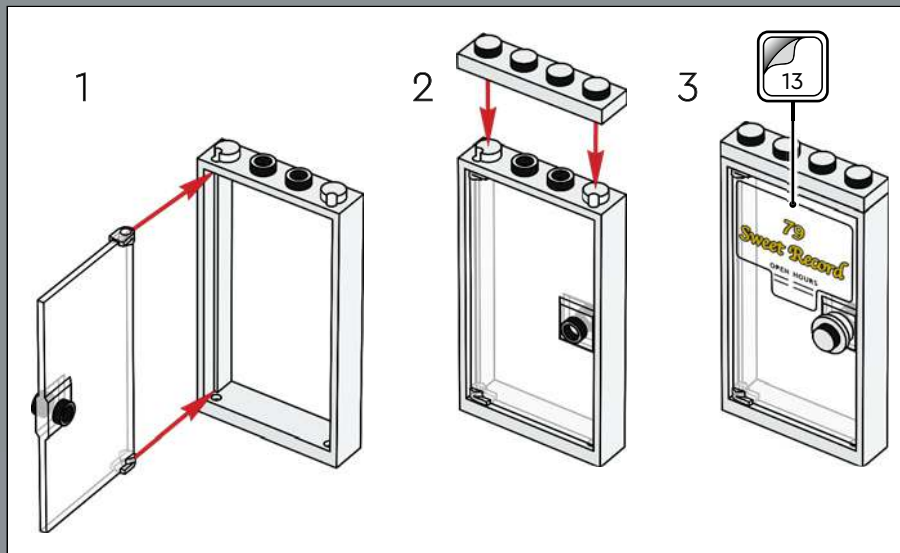
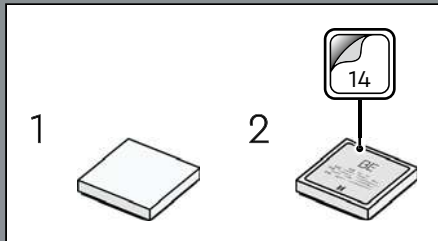

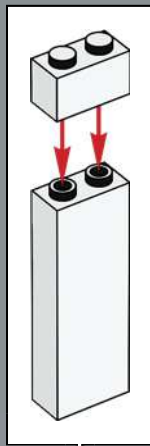
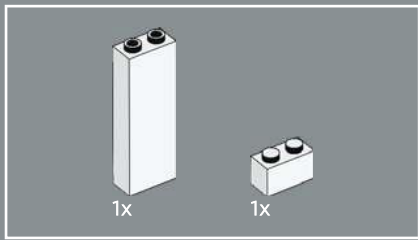

35

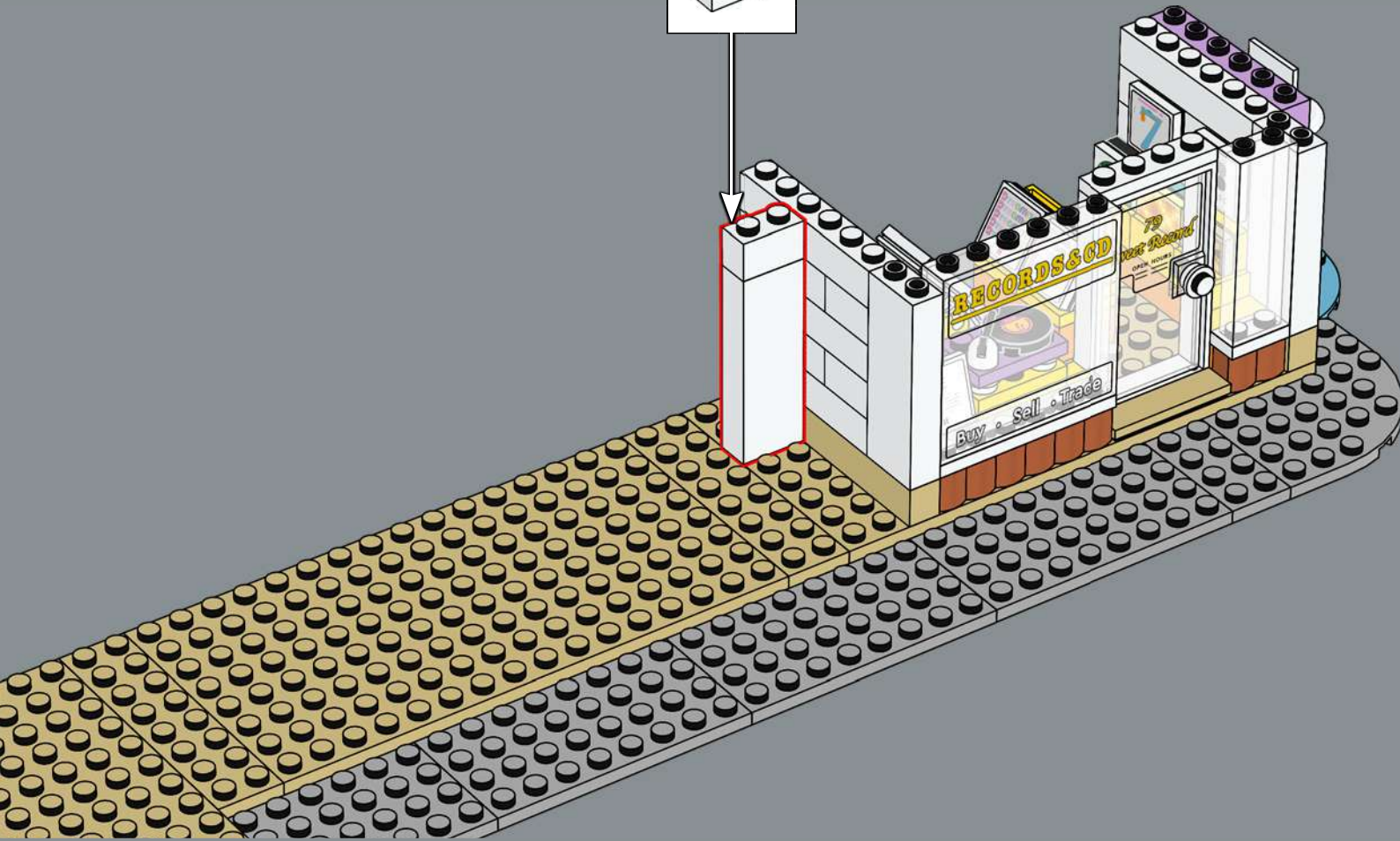

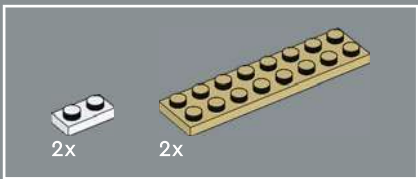

36

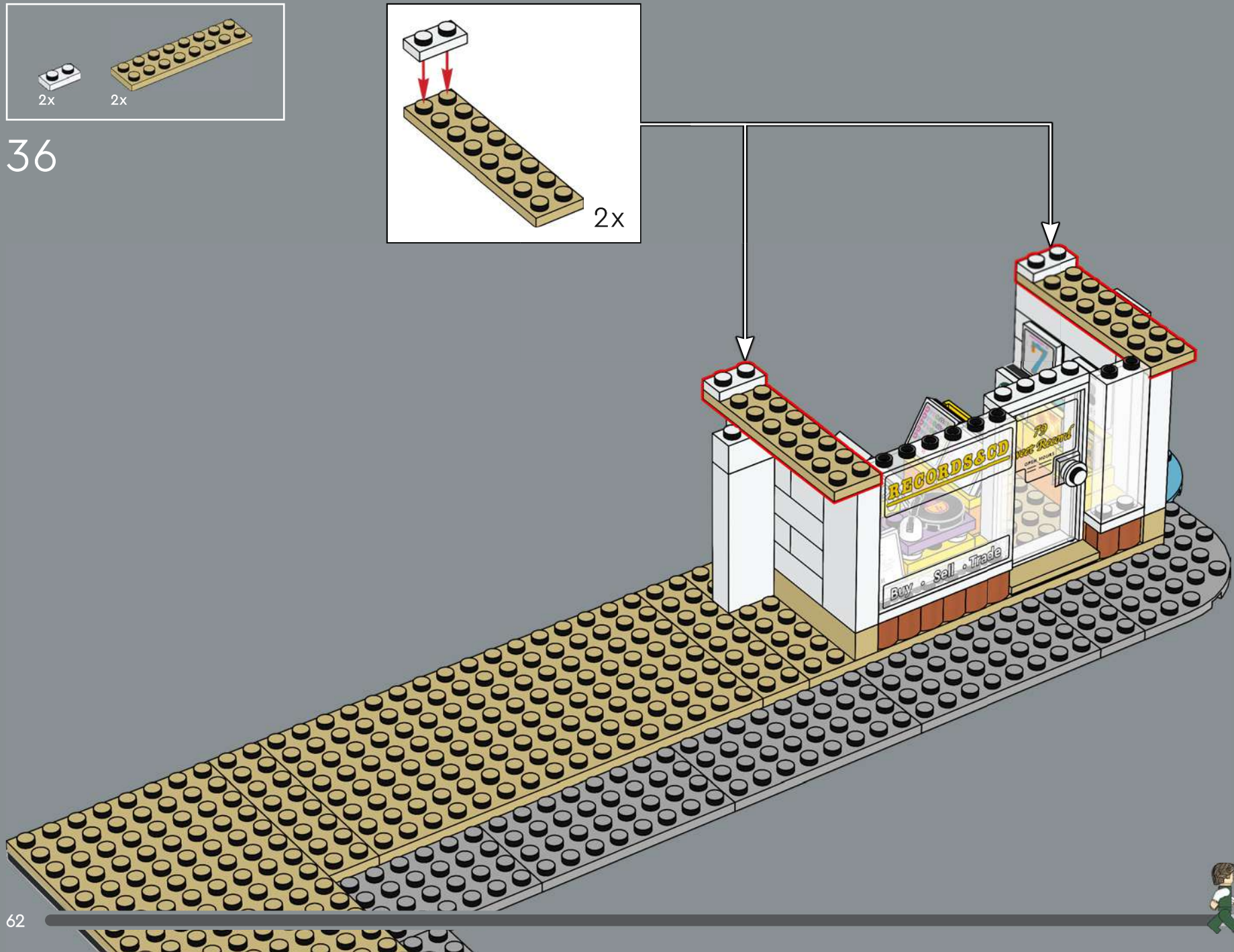
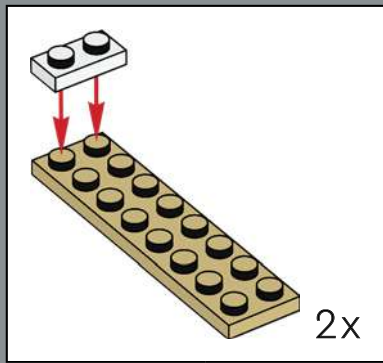

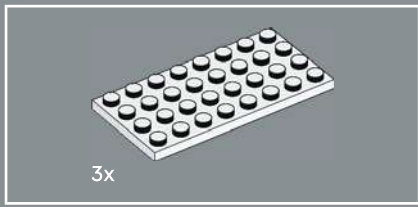

37

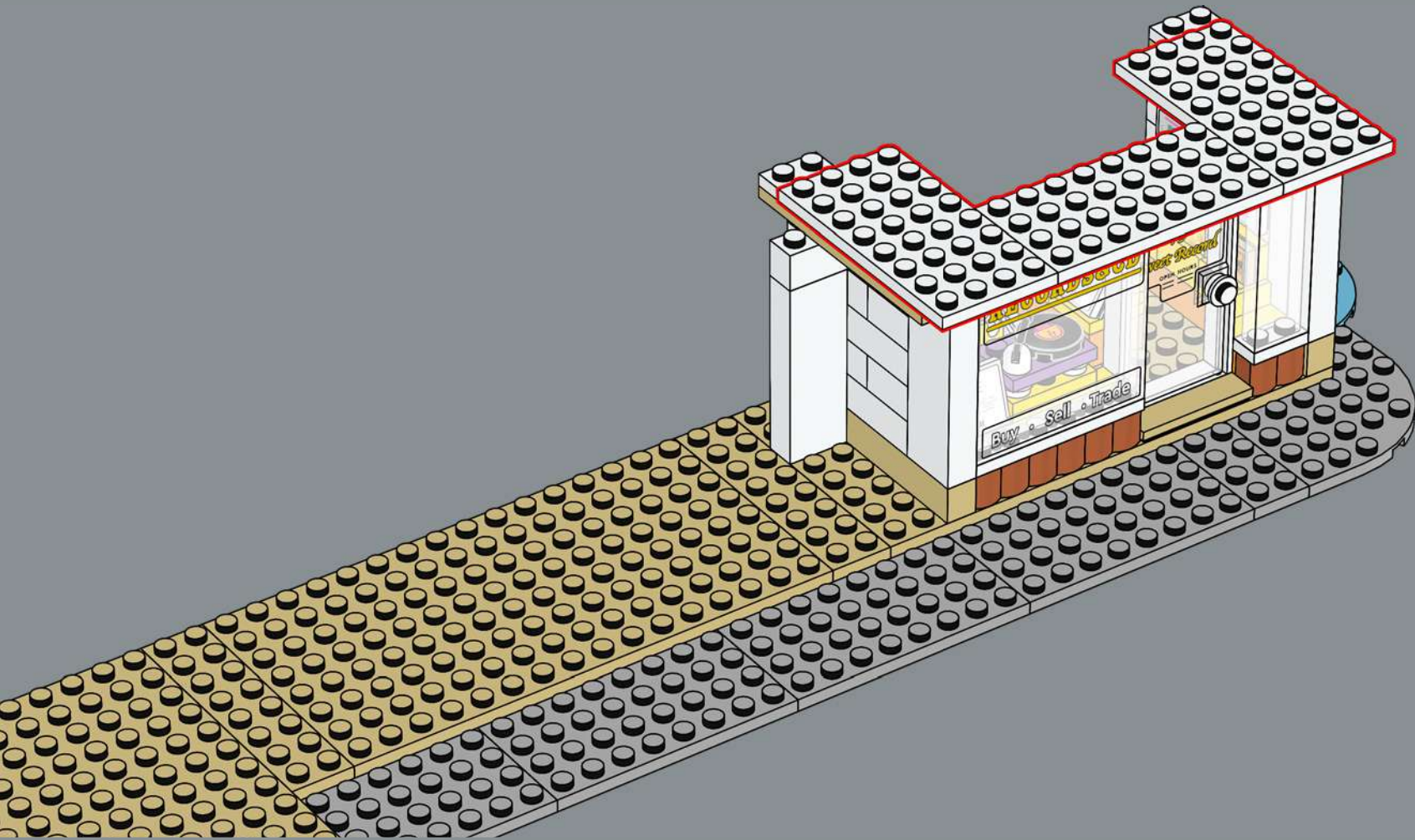

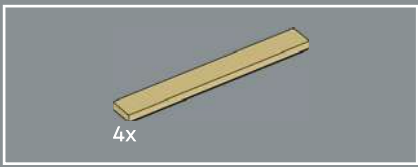

38

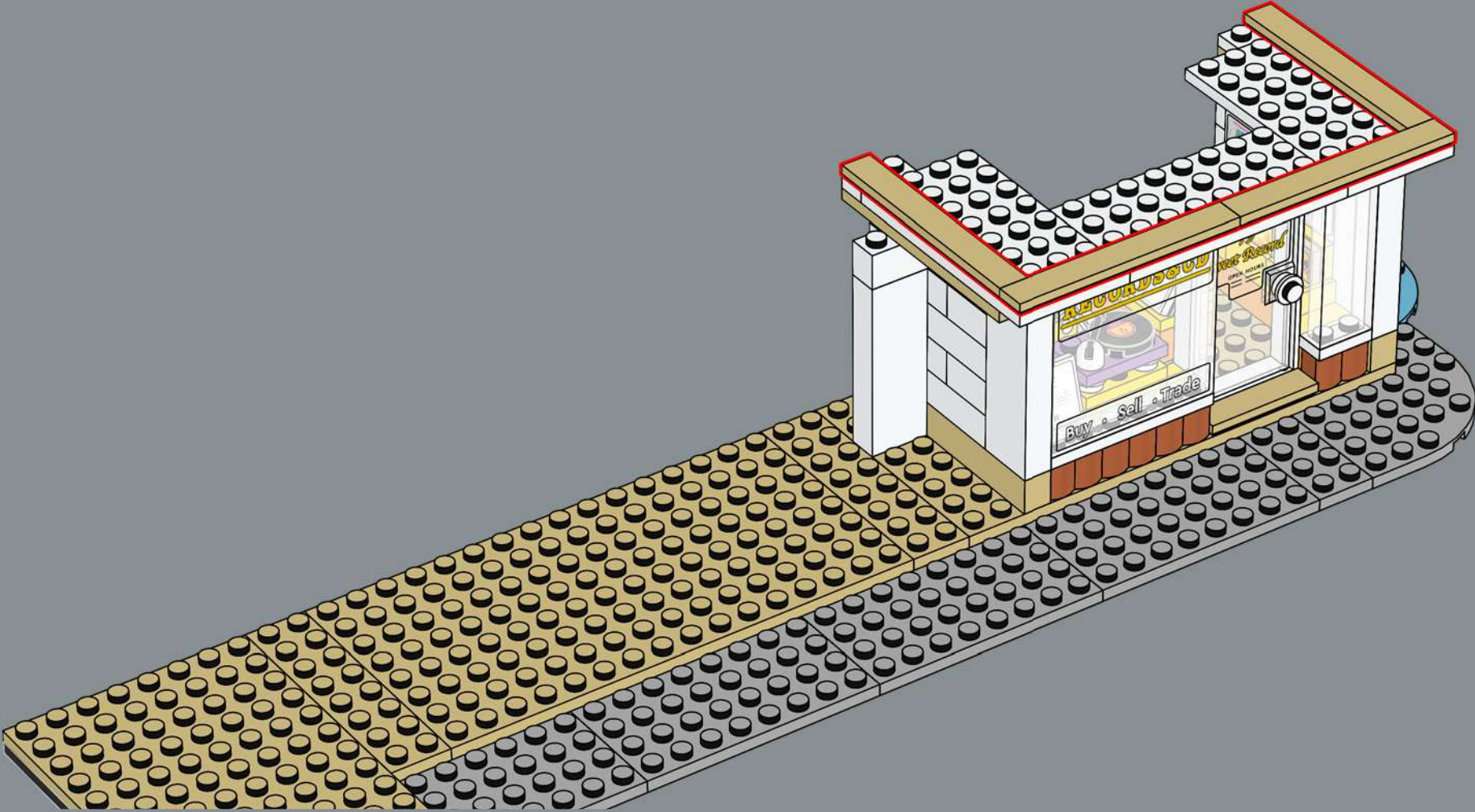

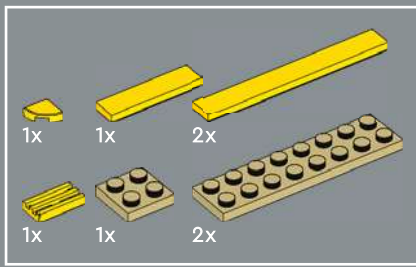

39

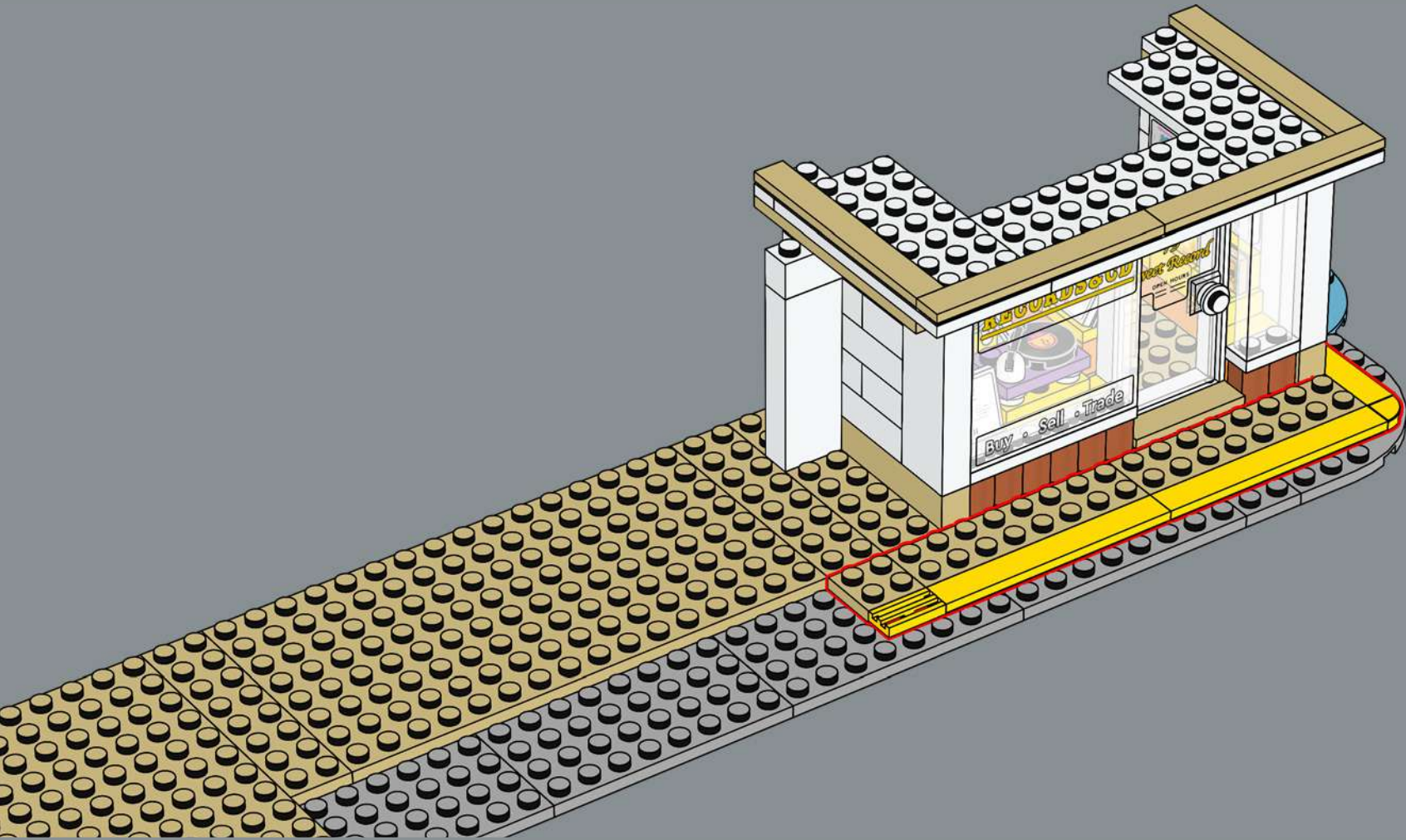

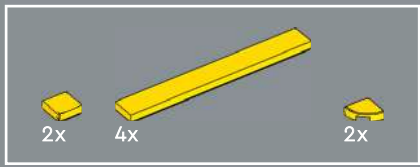

40

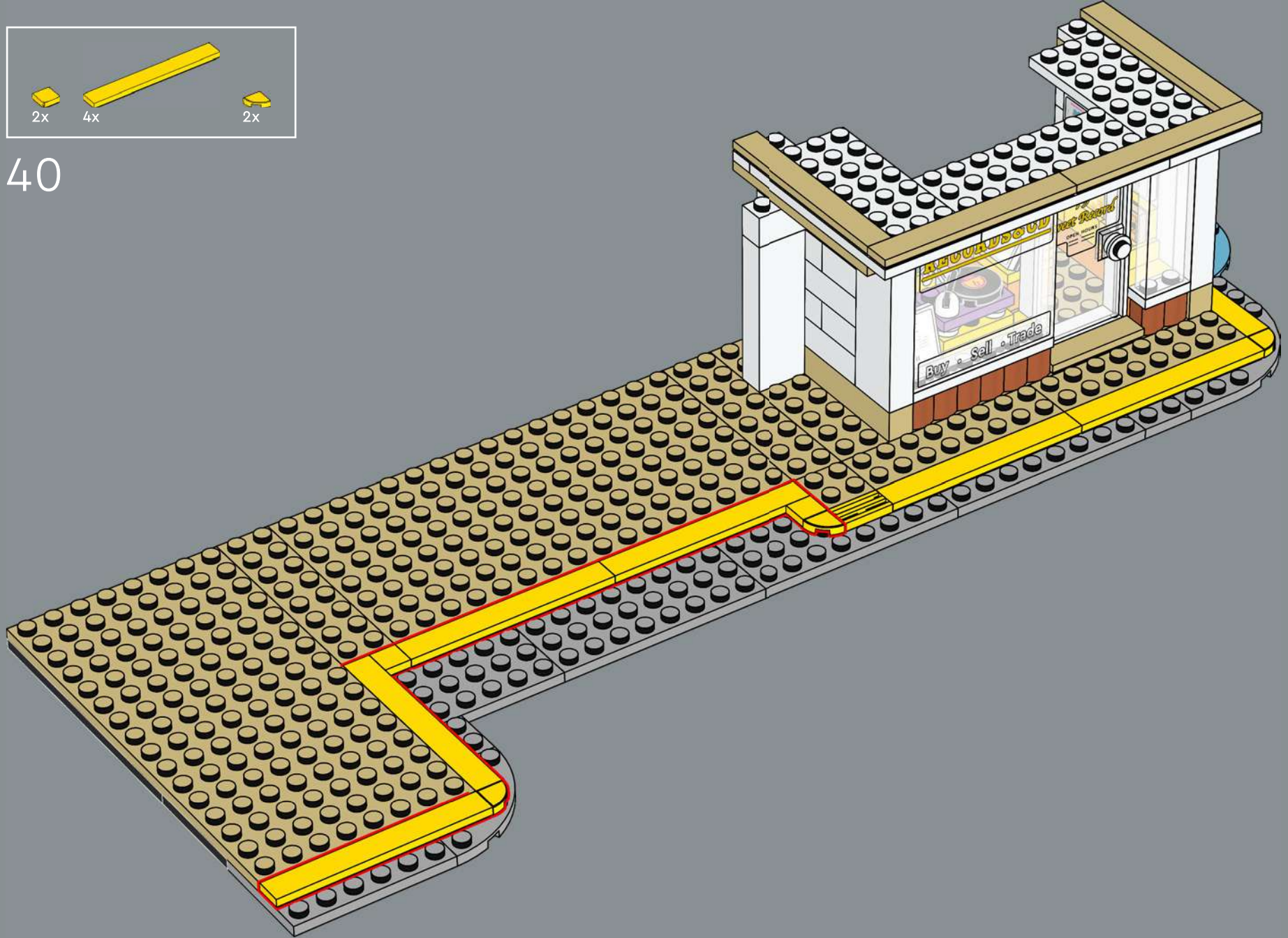

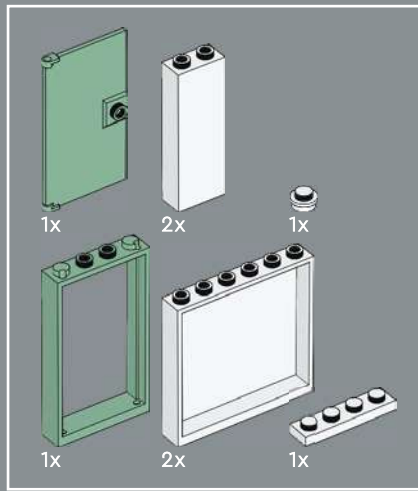

41

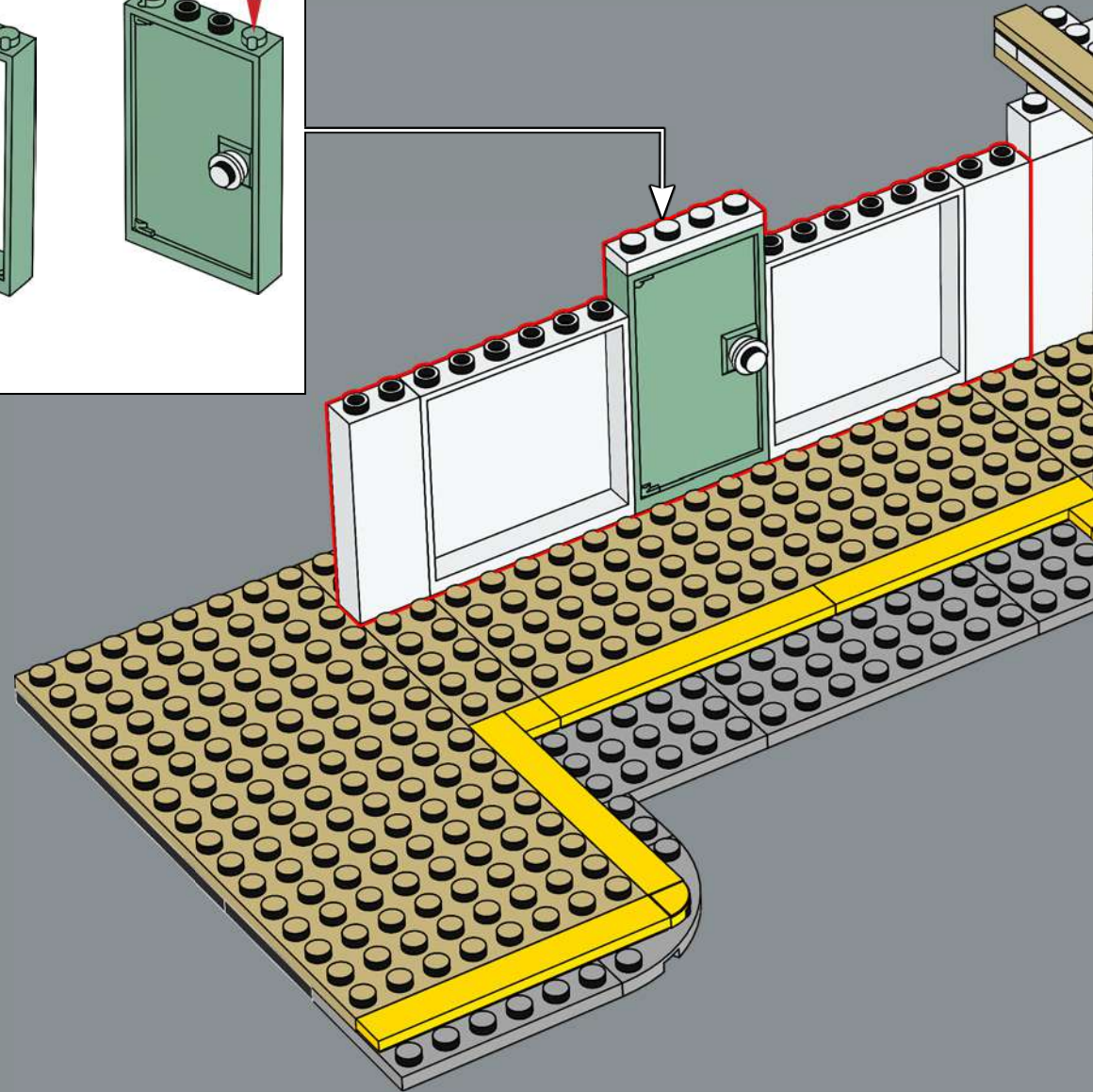
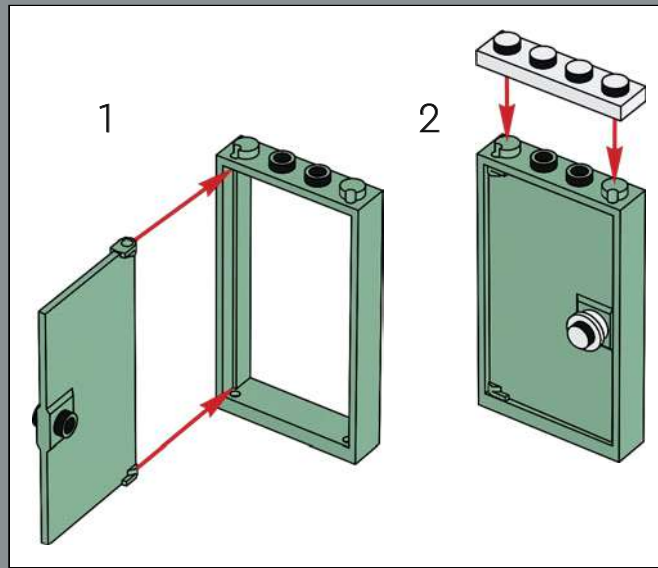

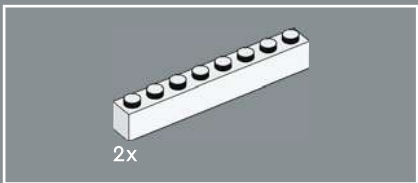

42

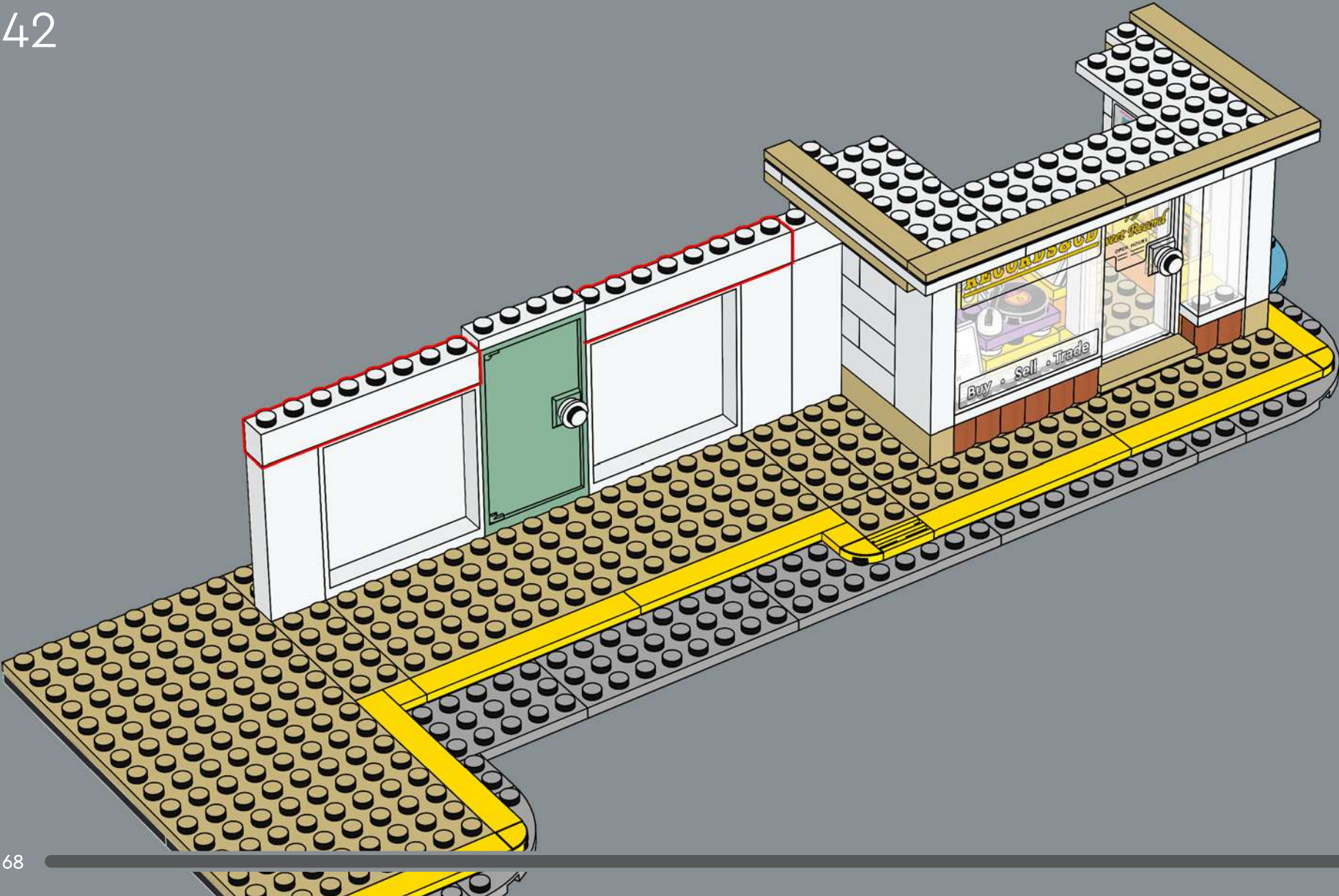

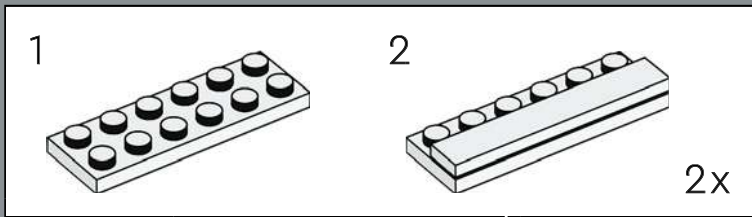
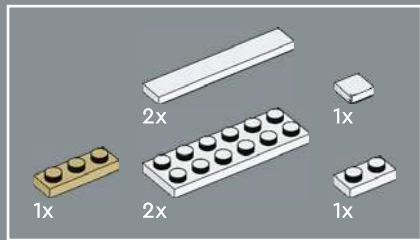

43

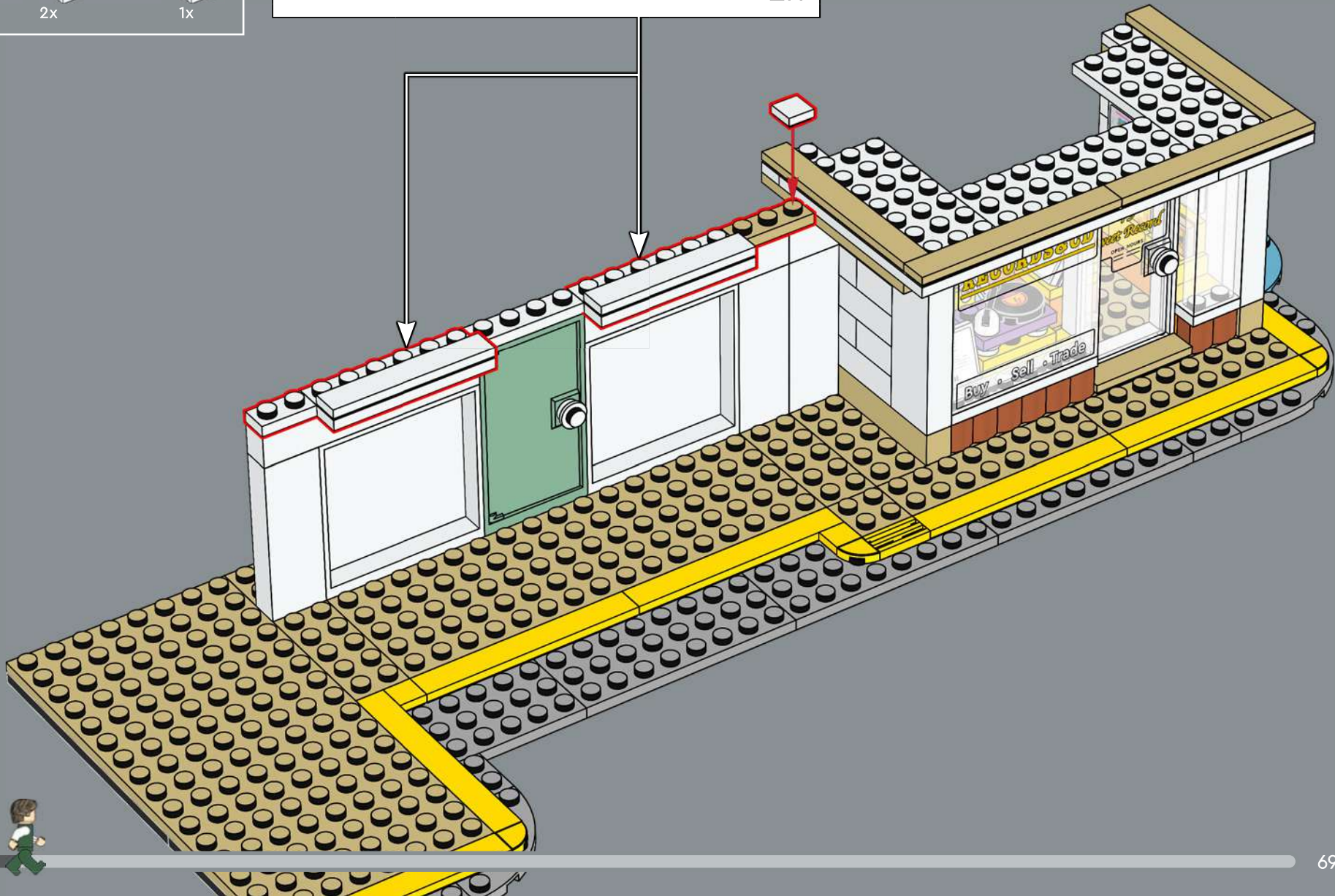

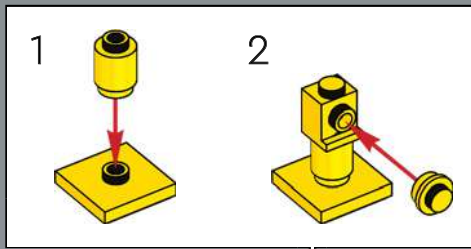
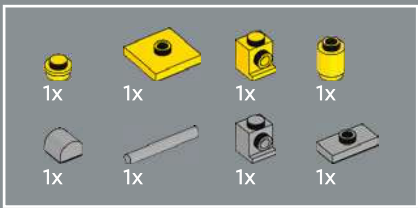

44

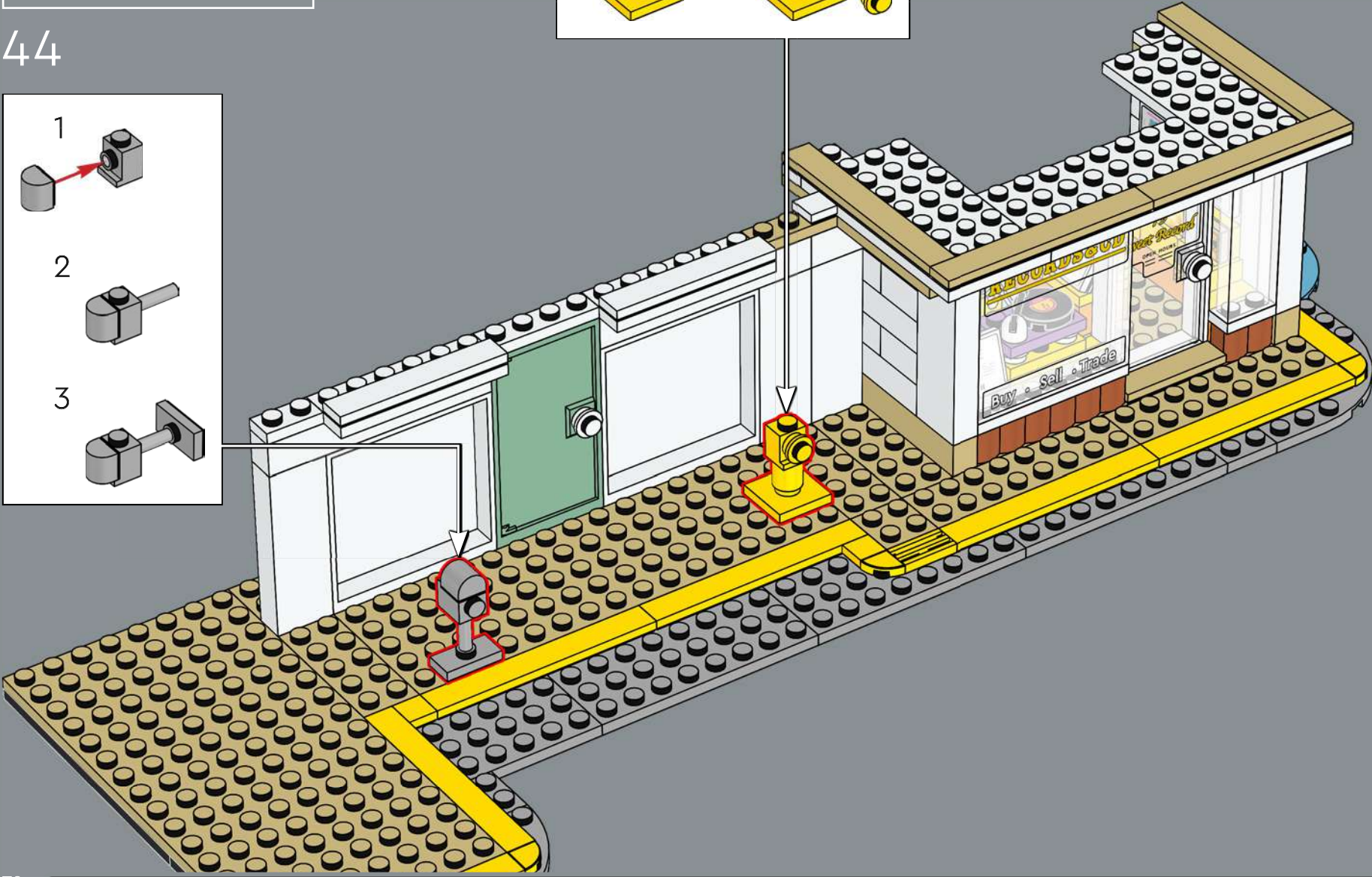
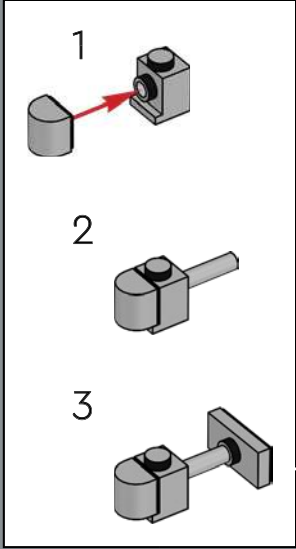

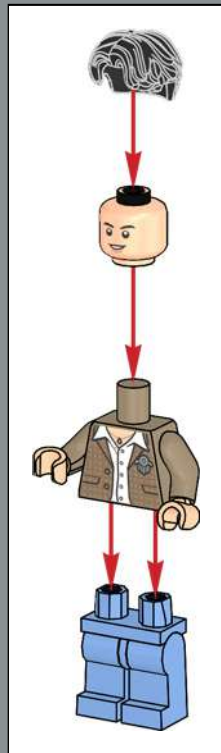

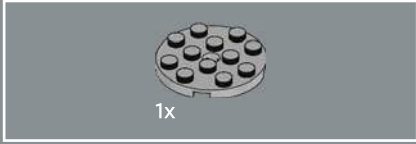
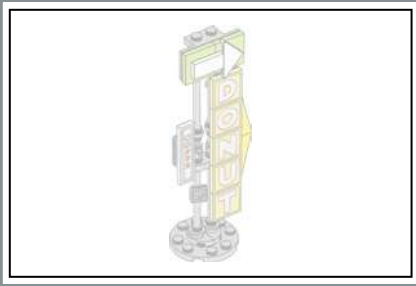

1

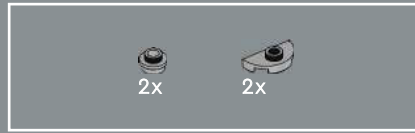

2

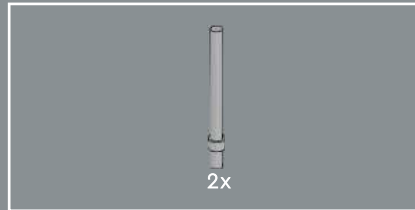
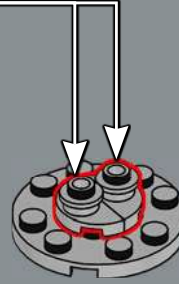
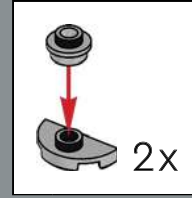

3

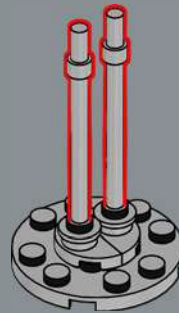



4

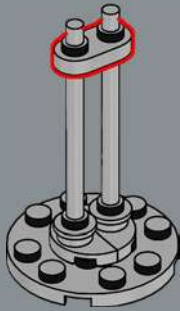

5

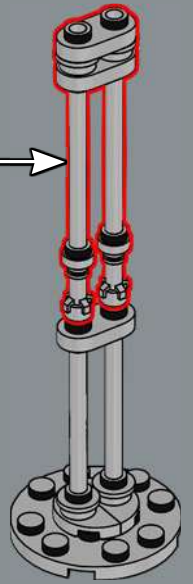
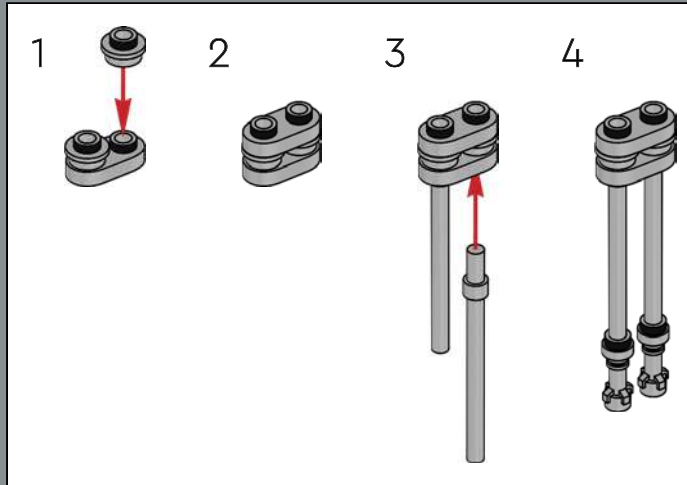

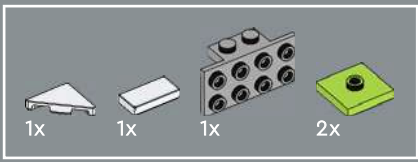

6

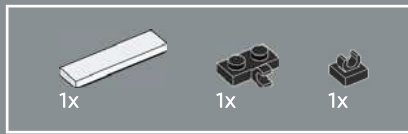
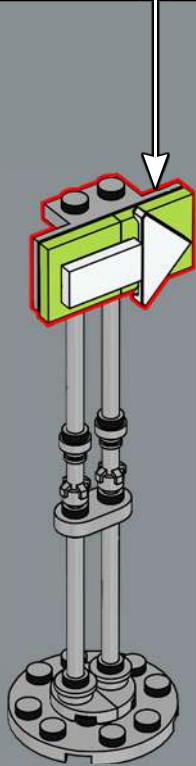
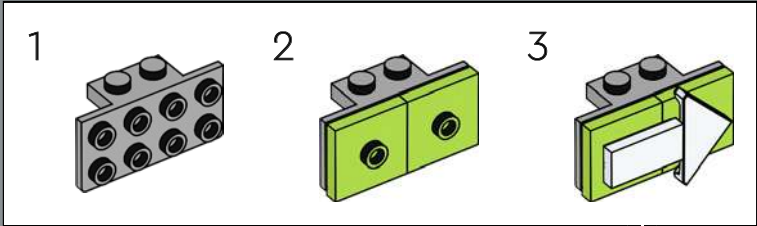

7

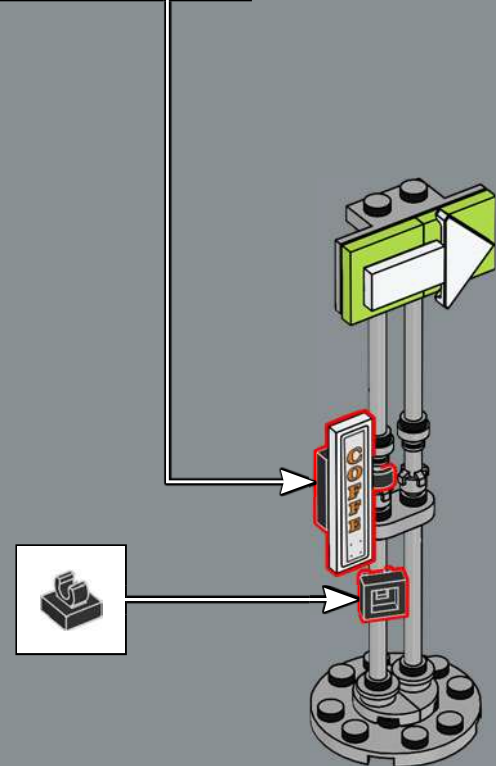
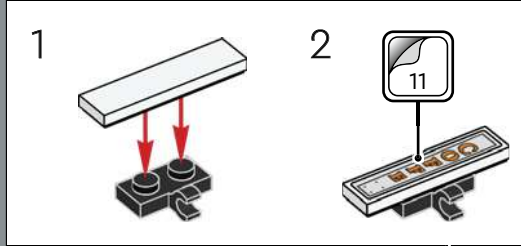

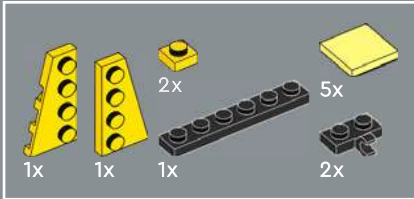
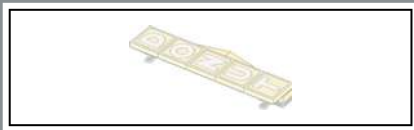

8

1

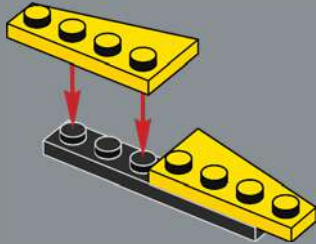

2

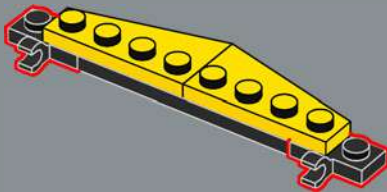

3

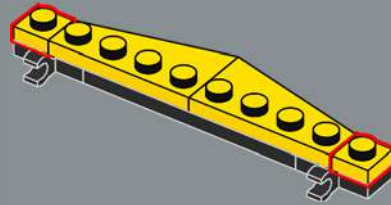

4

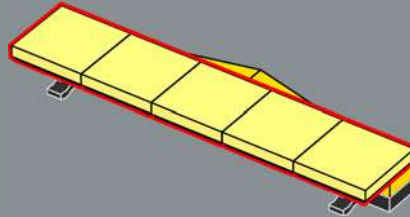

5

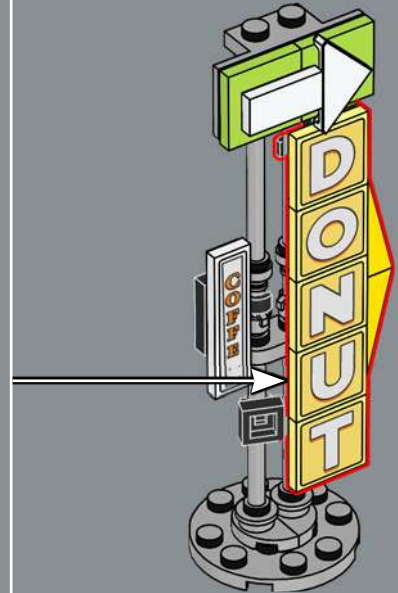
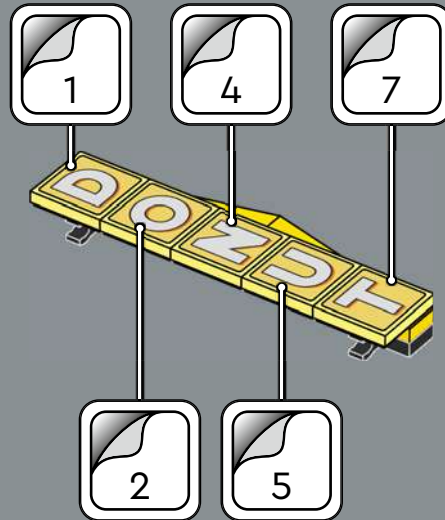



1x

45

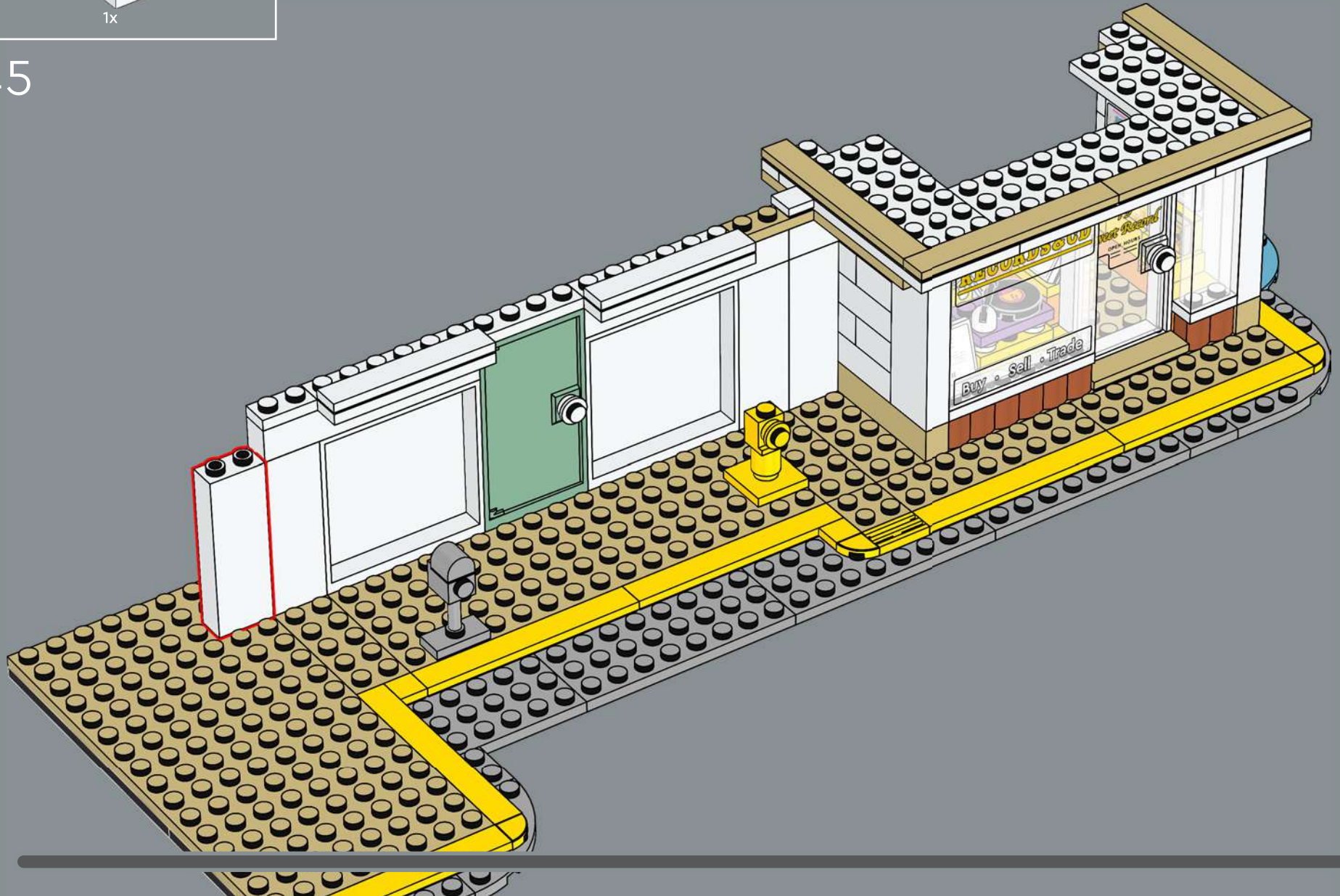

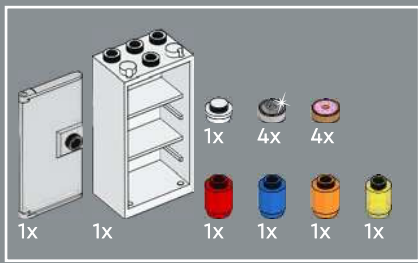

46

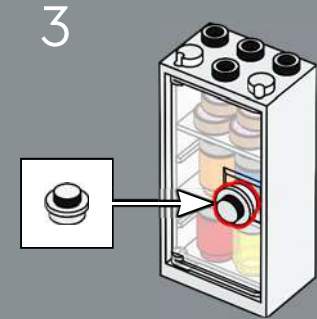
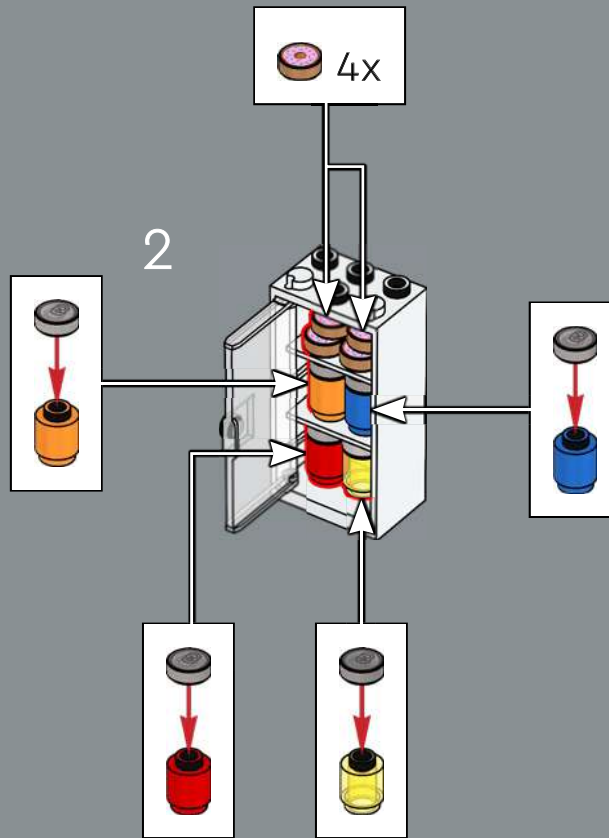
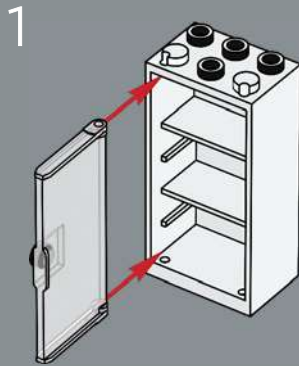

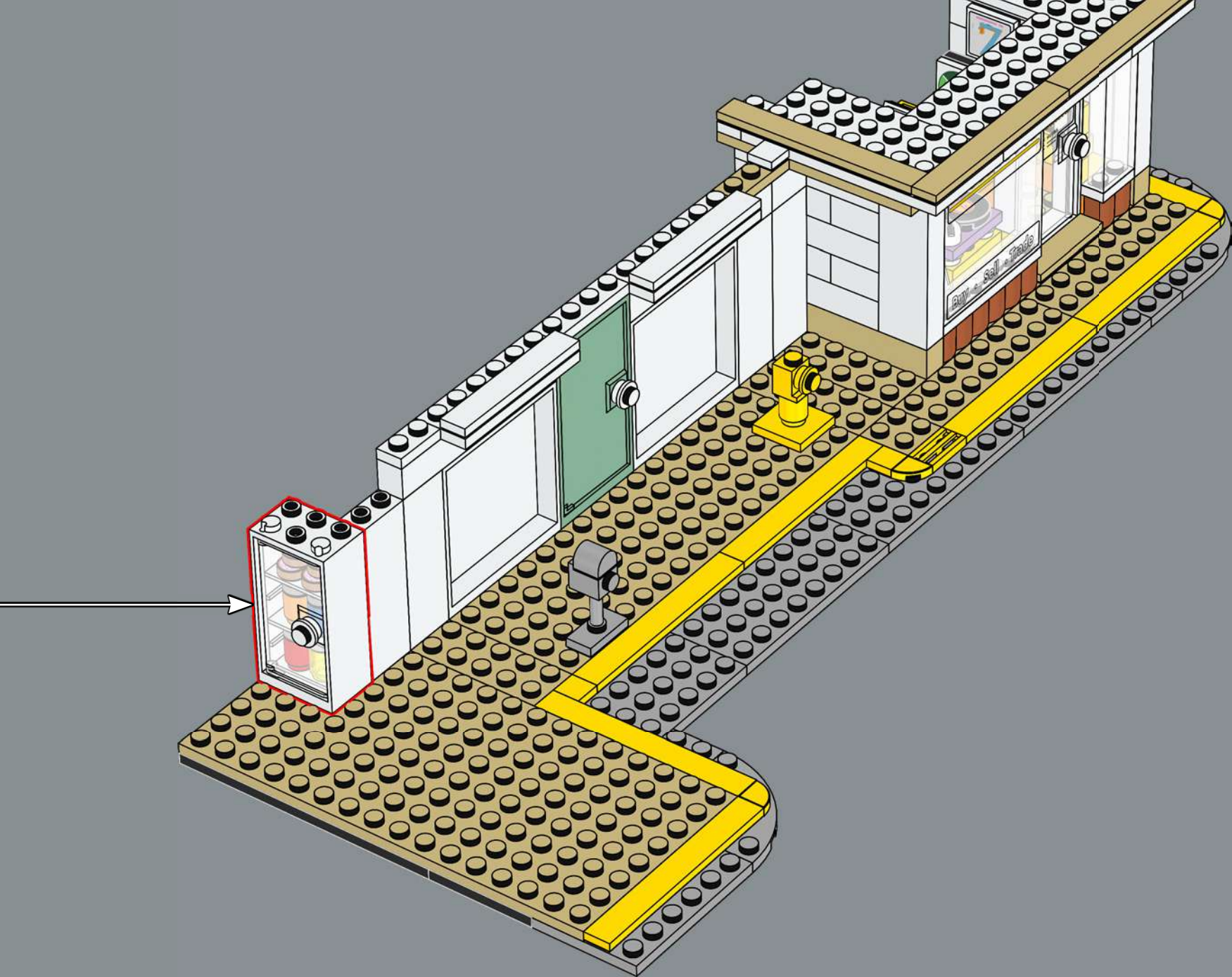

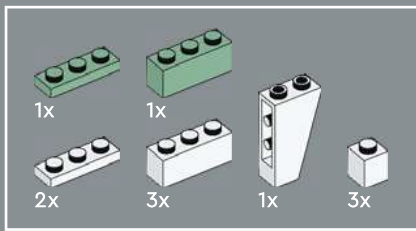

47

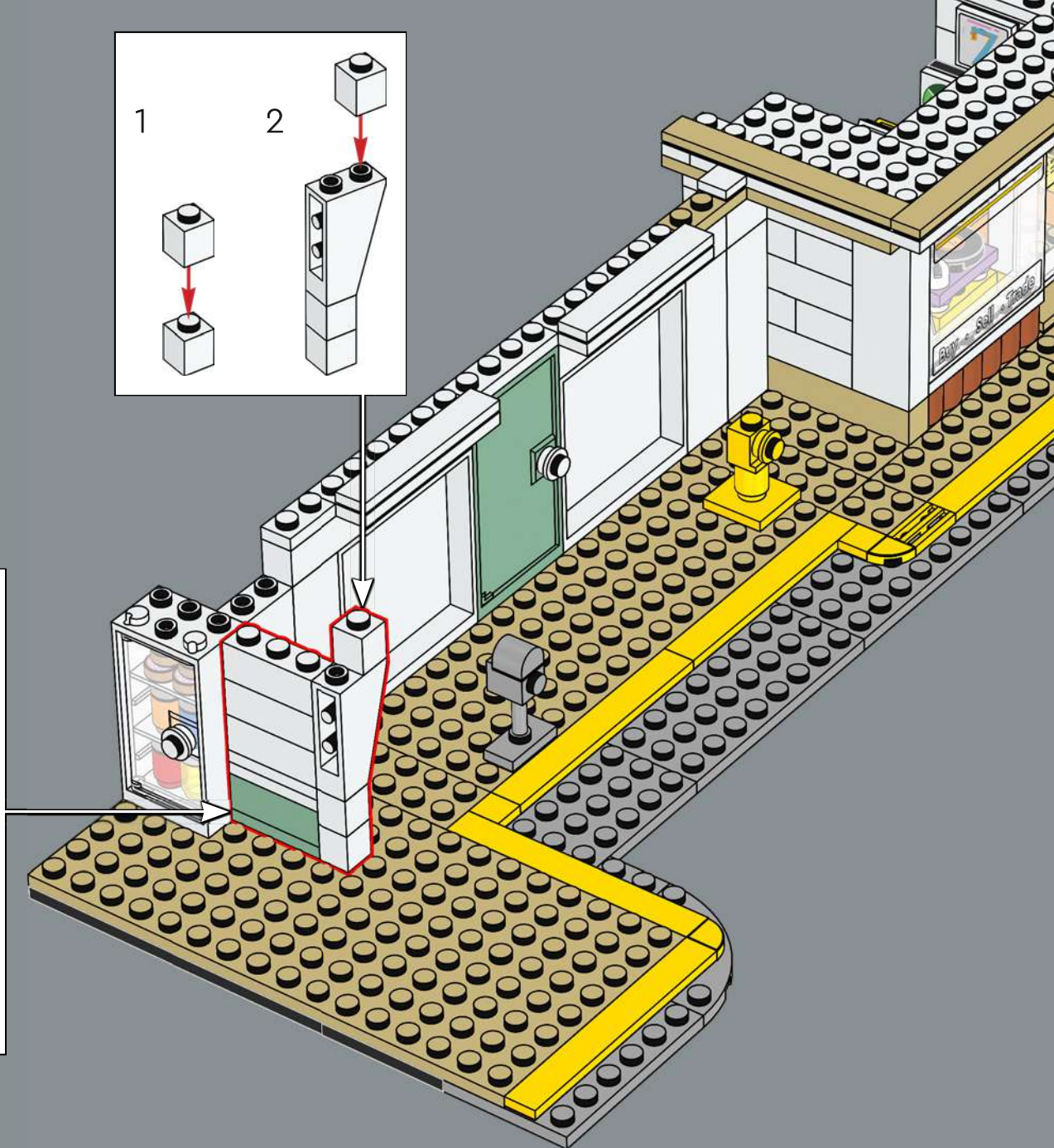
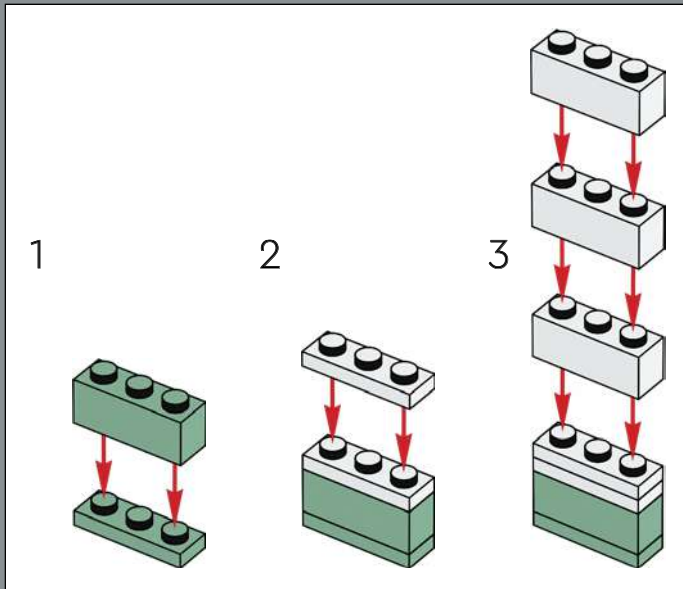
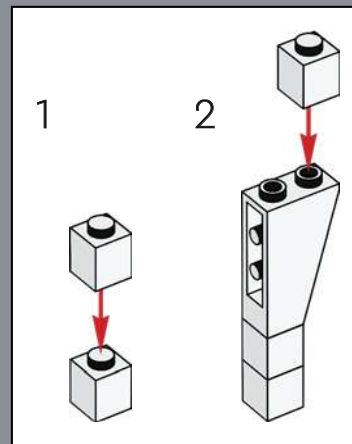

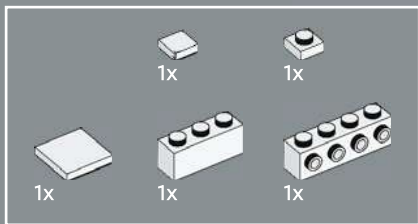

48

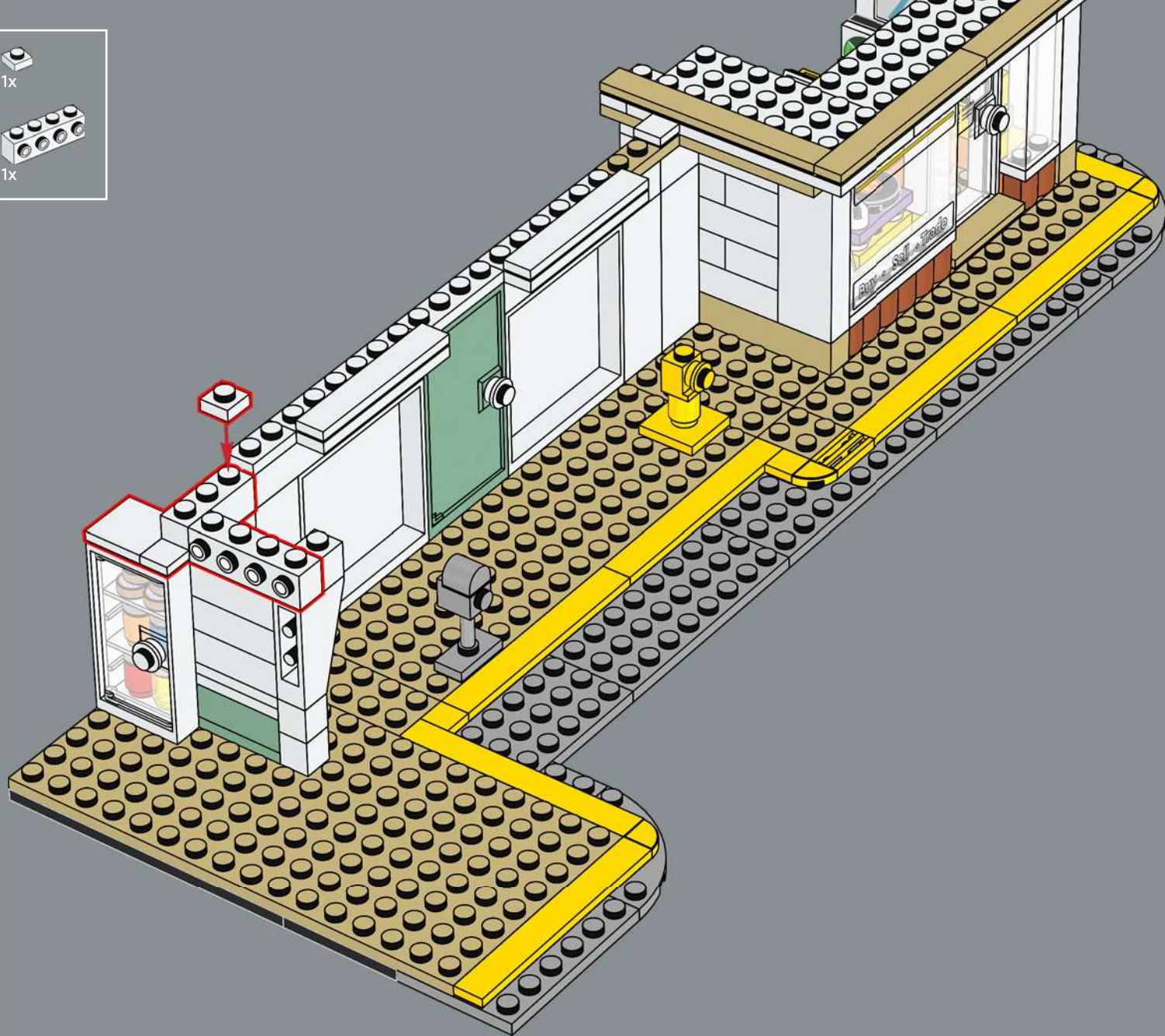

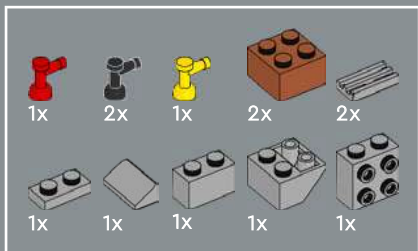

49

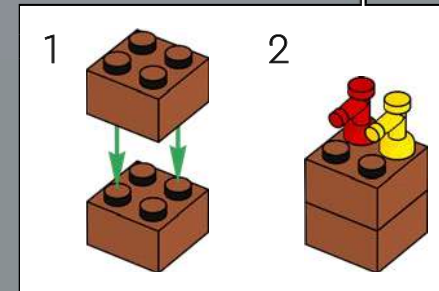
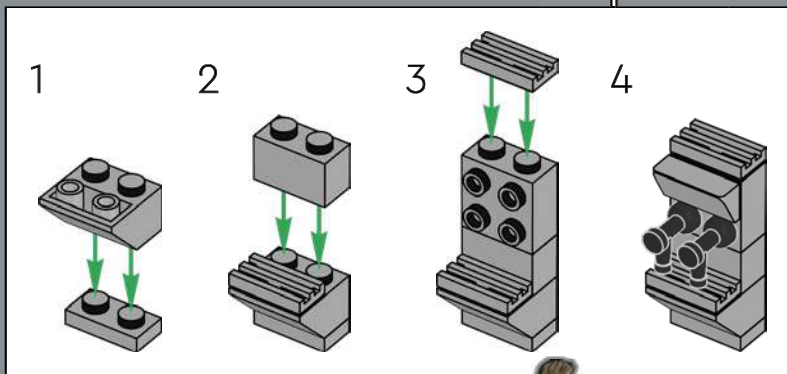
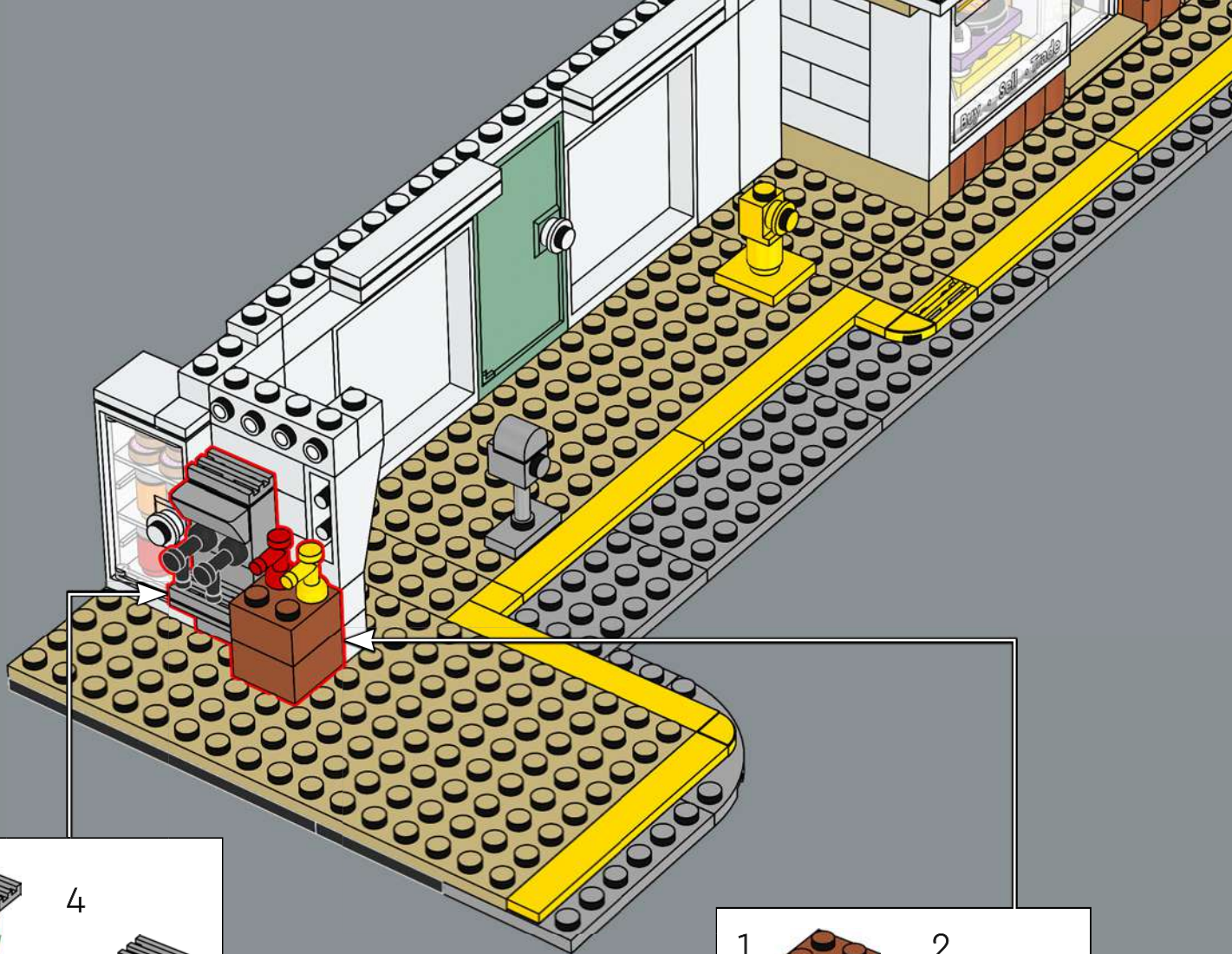

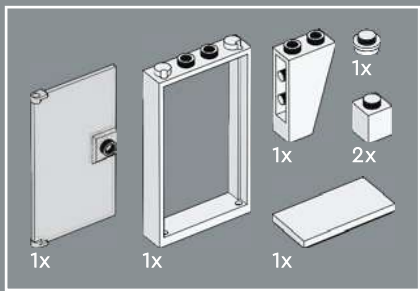

50

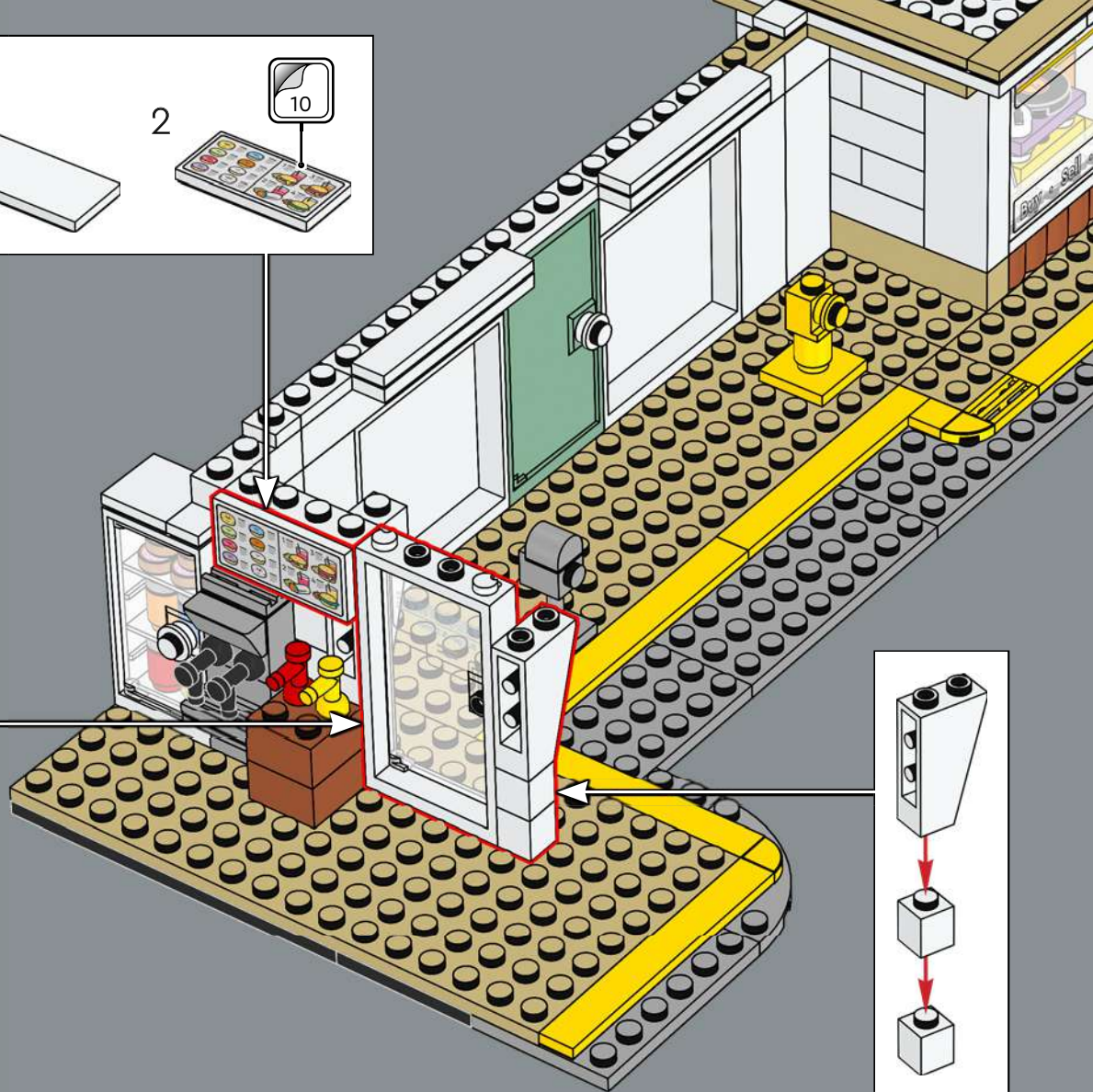
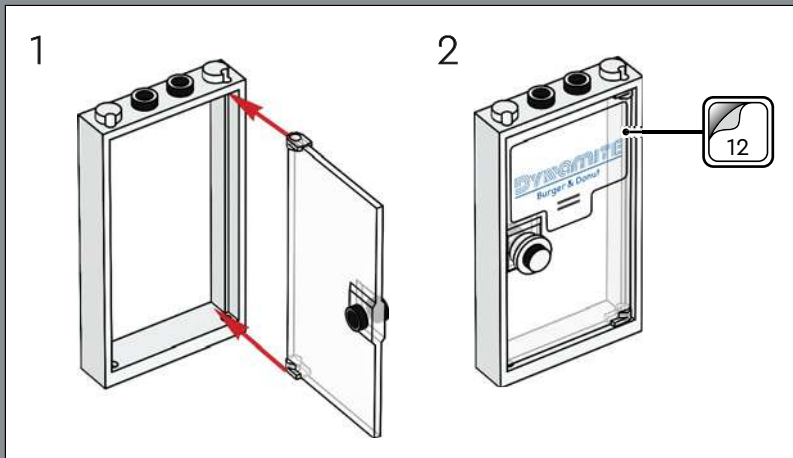
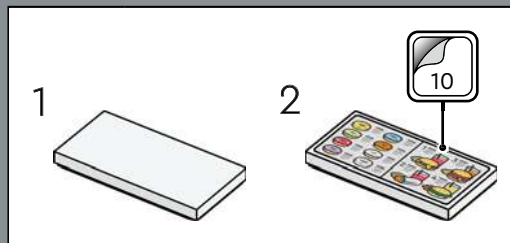

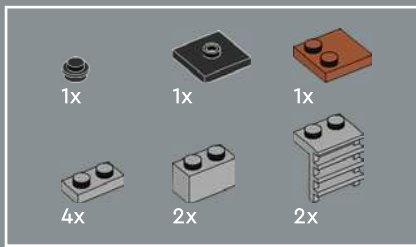

51

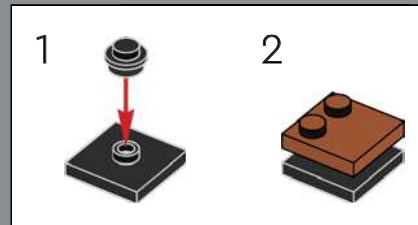
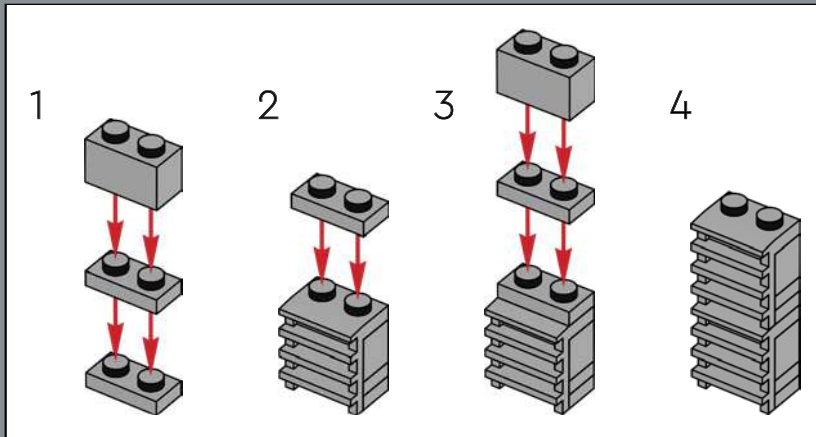

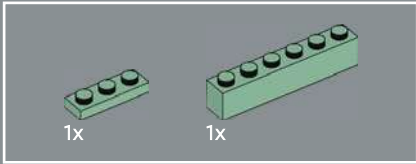

52

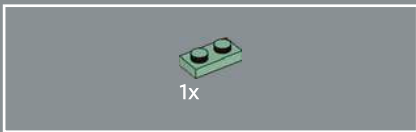
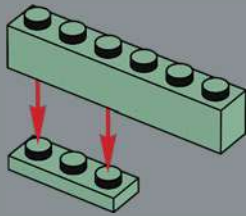

53

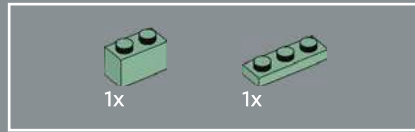
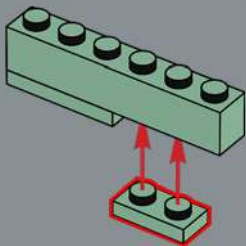

54

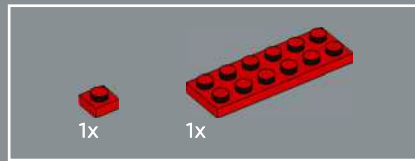
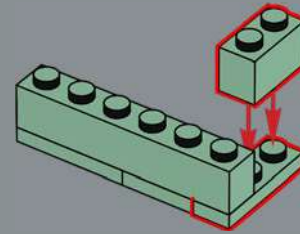

55

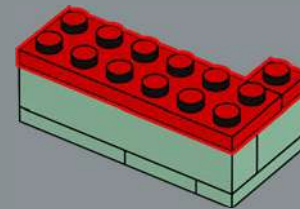



56

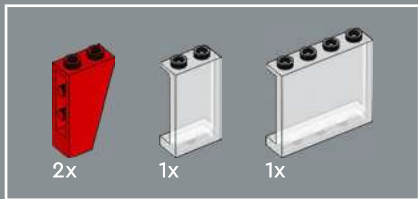
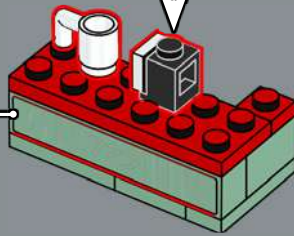
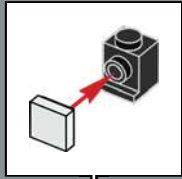

57

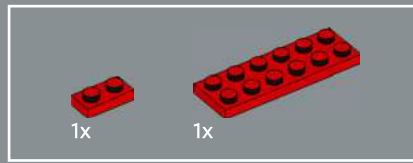
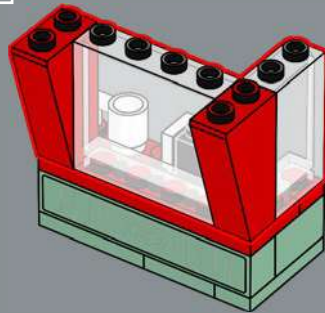

58

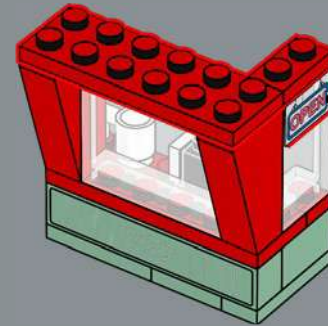

59

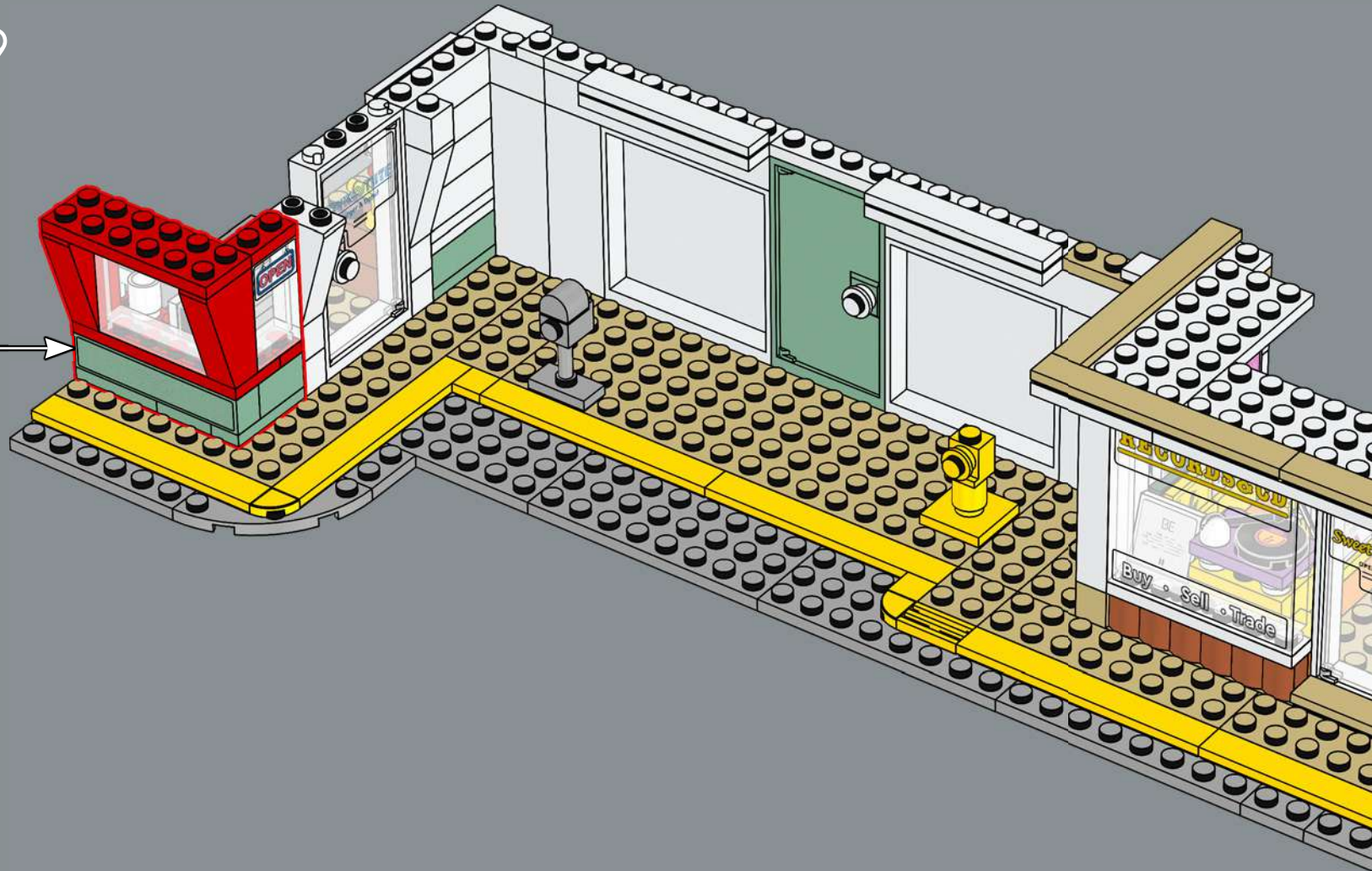

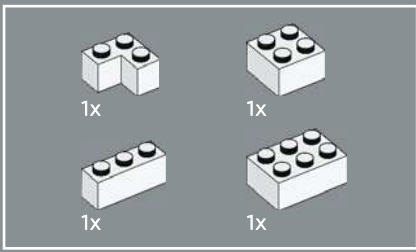

60

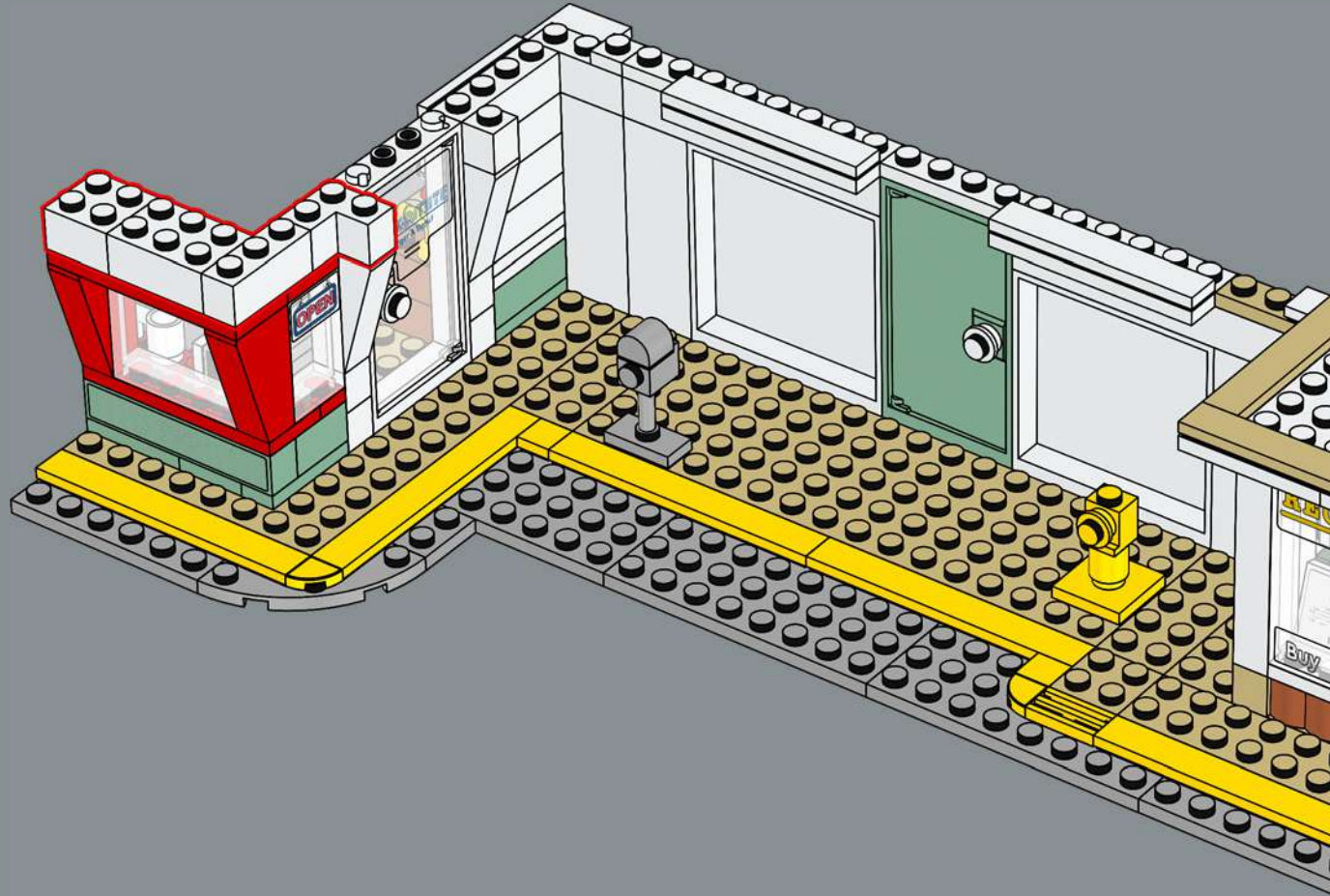

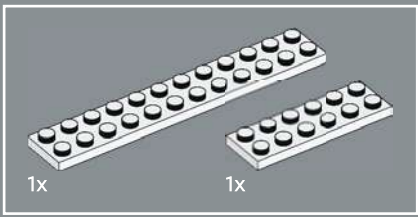

61

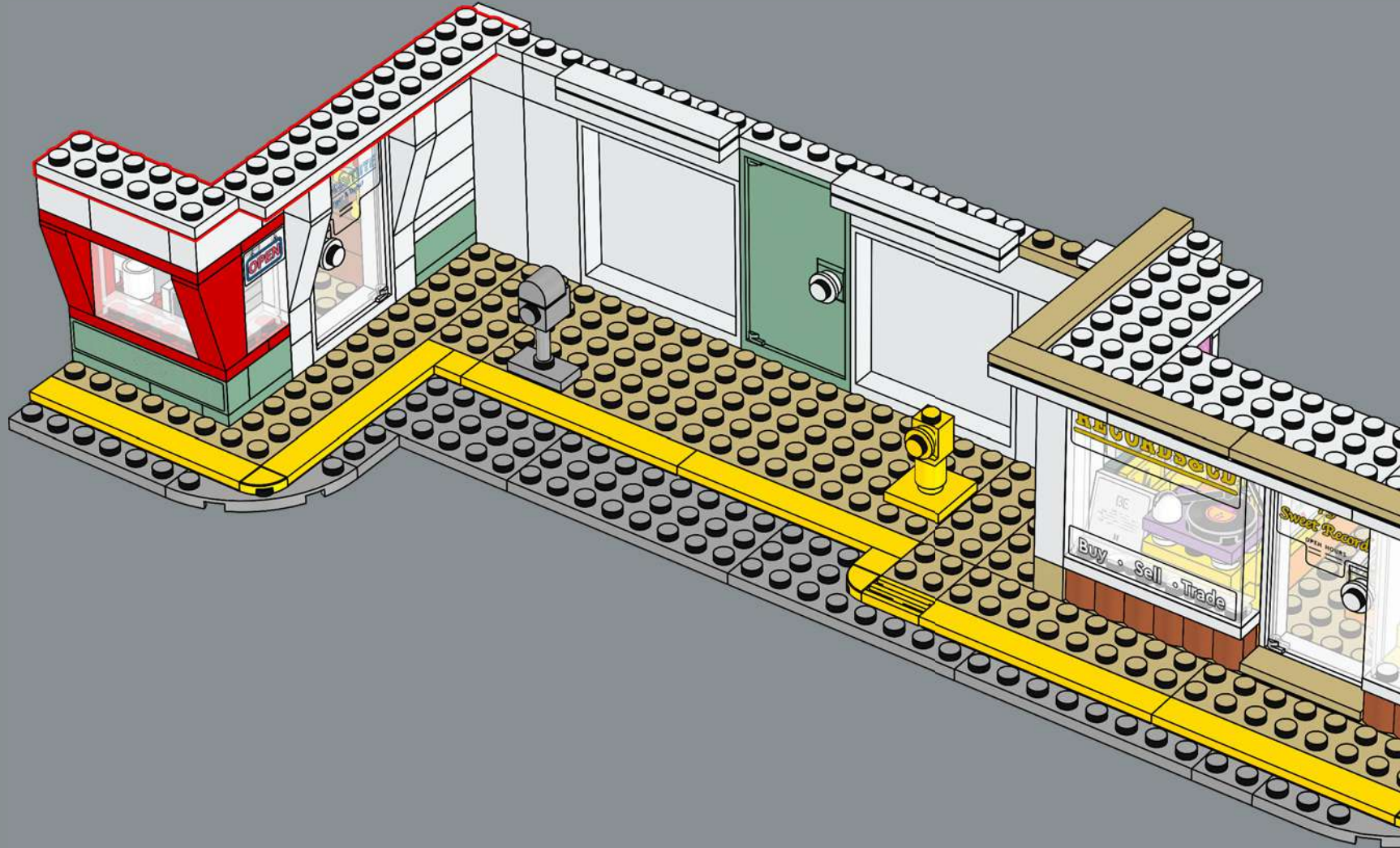

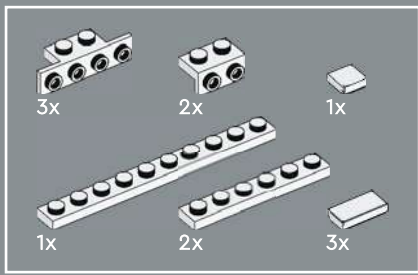

62

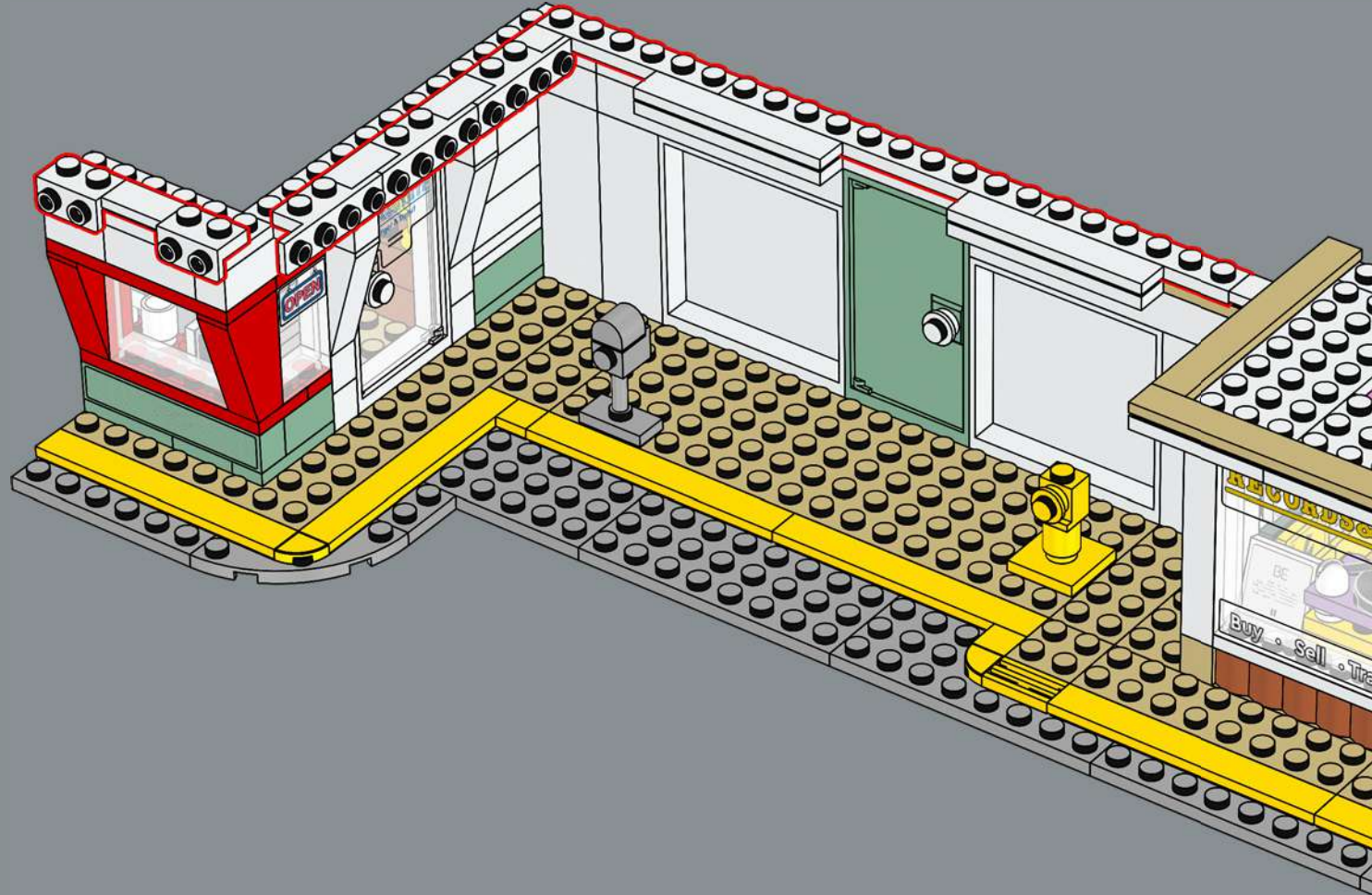

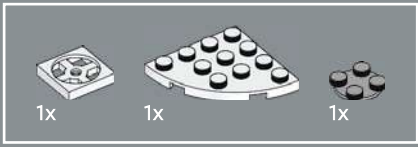

63

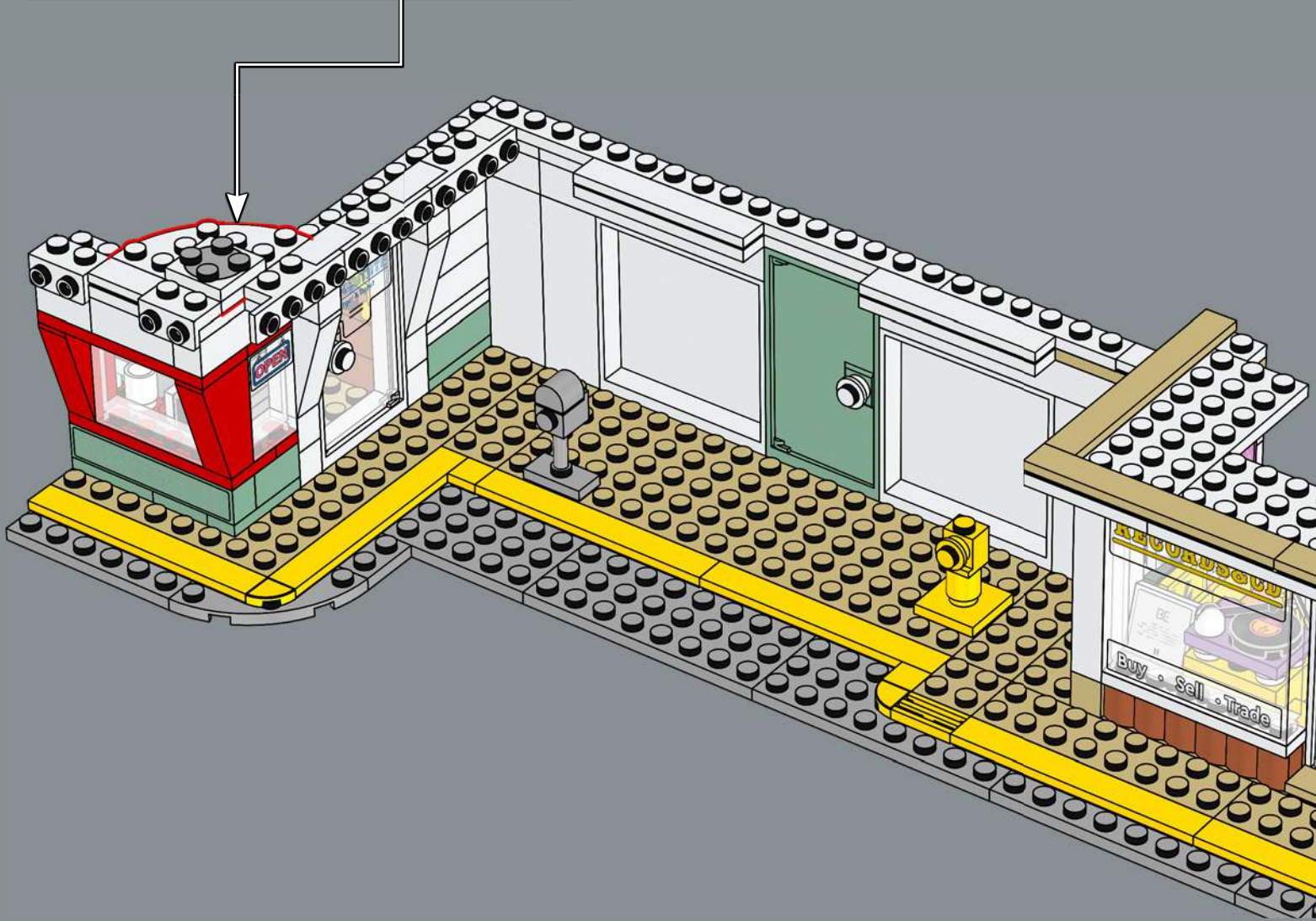
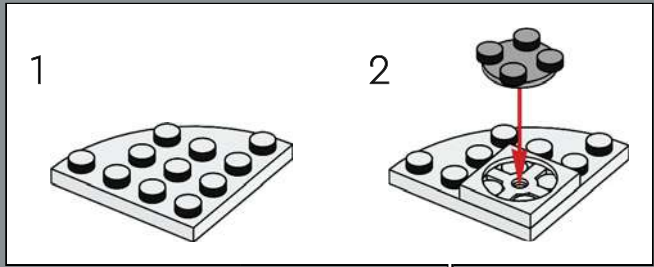

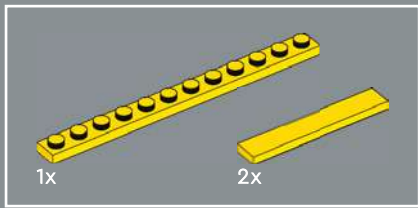

64

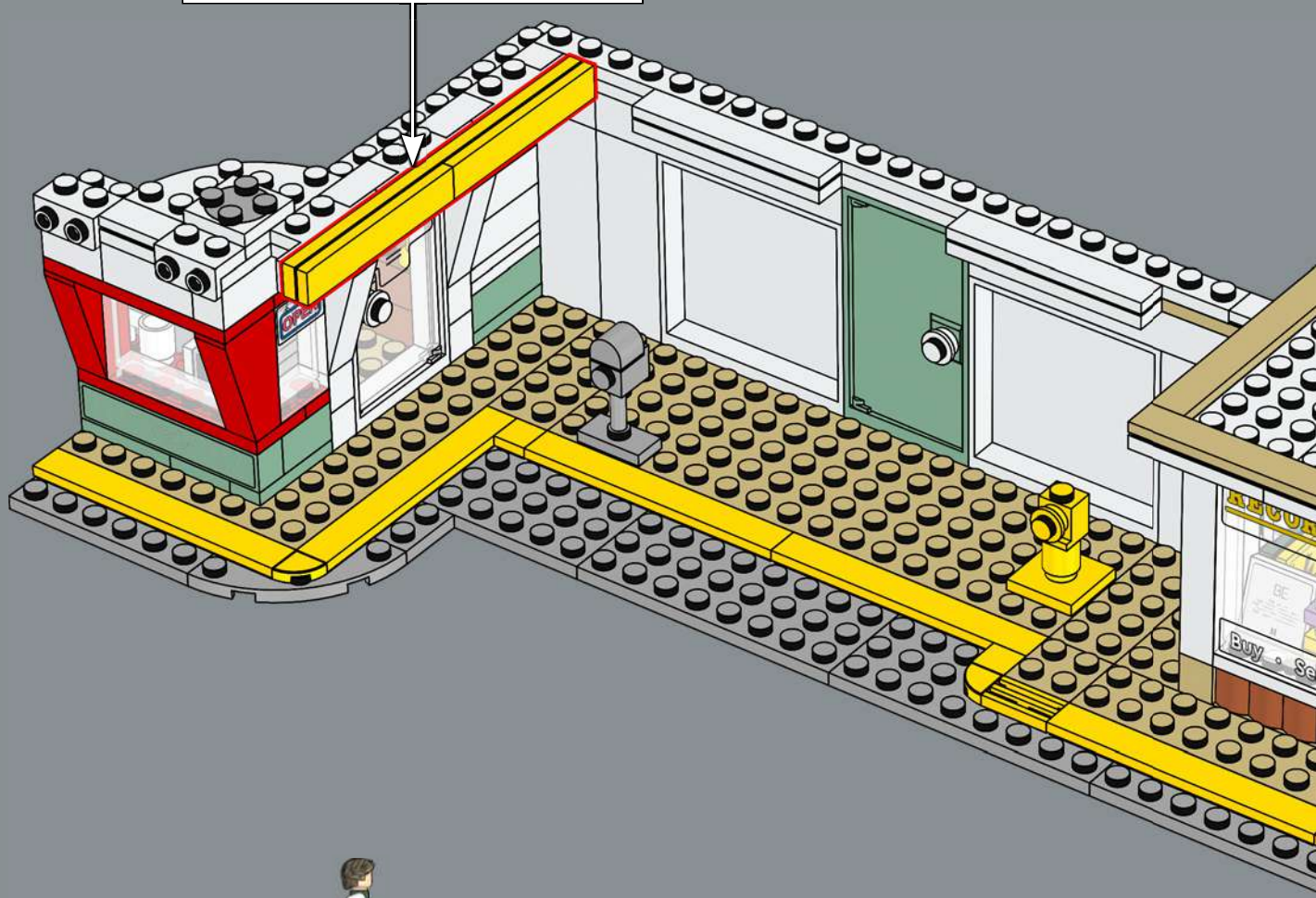
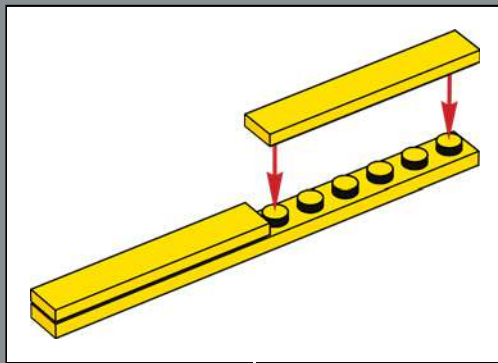

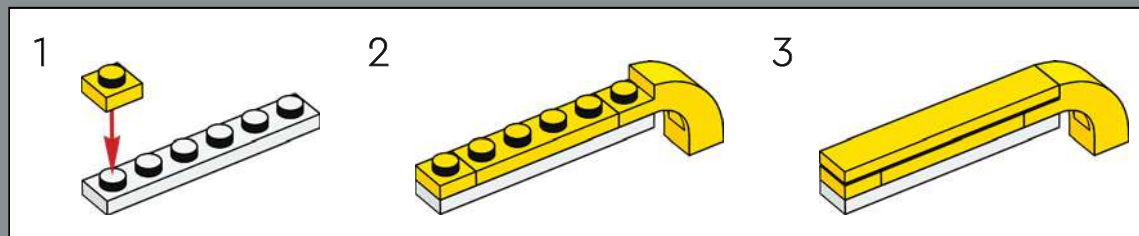
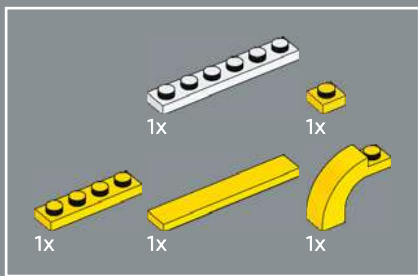

65

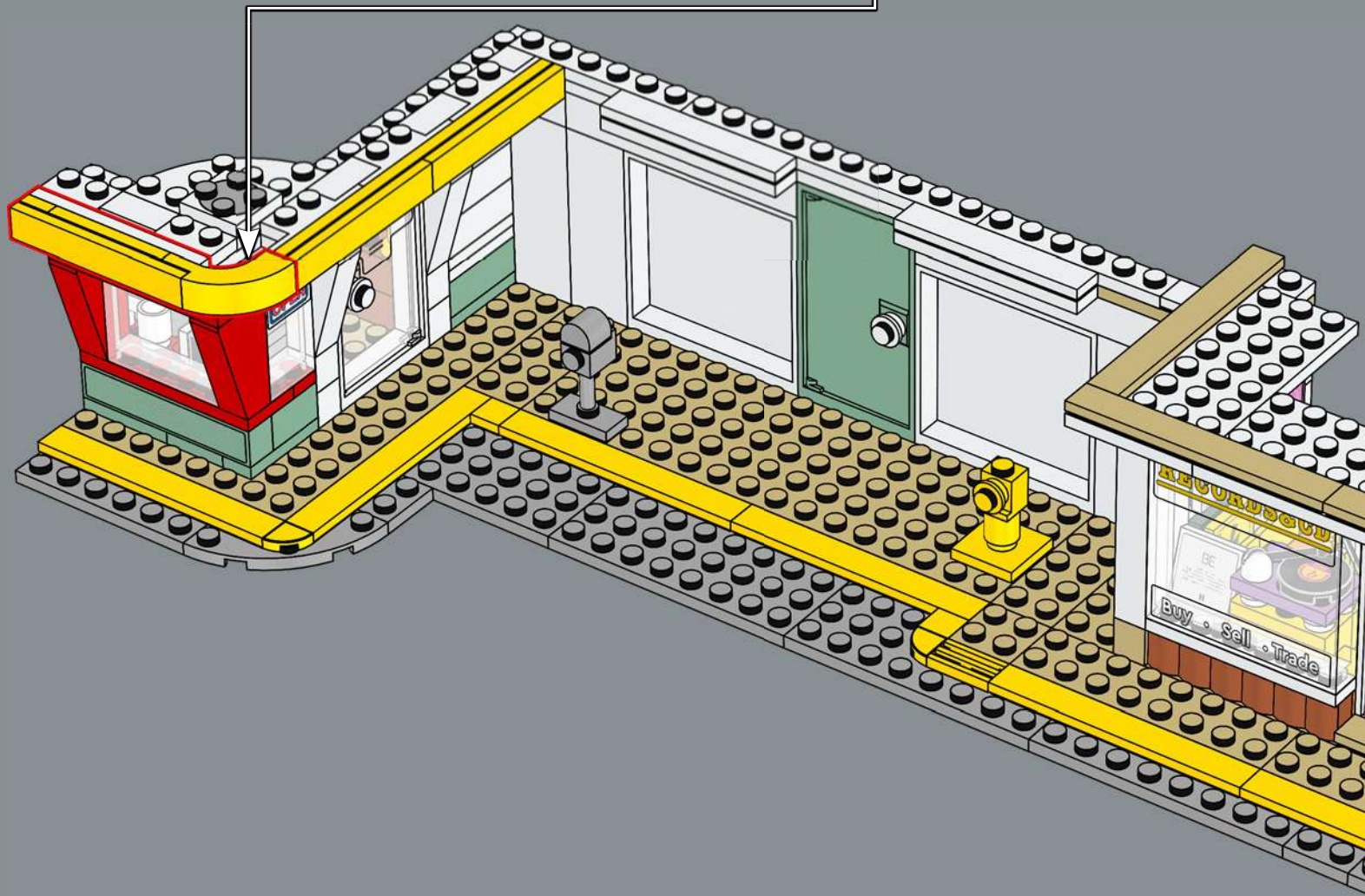

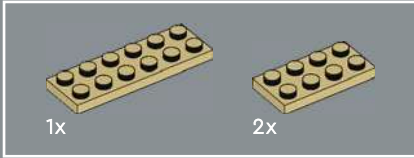
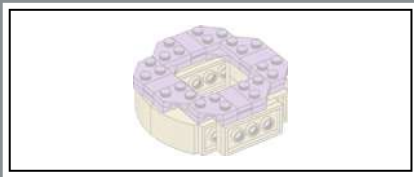

66

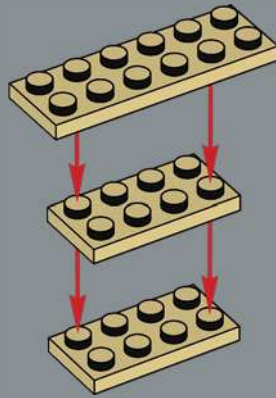

67

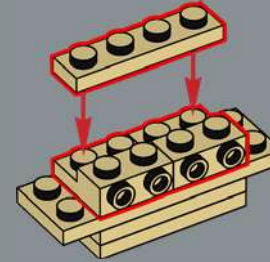

68

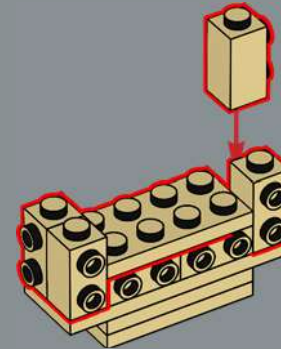



4x

69

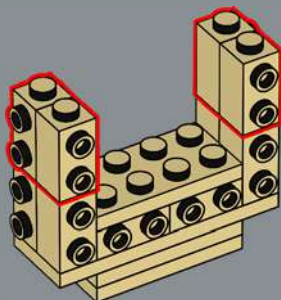

2x

70

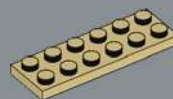
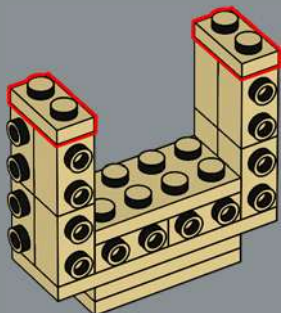

1x

71

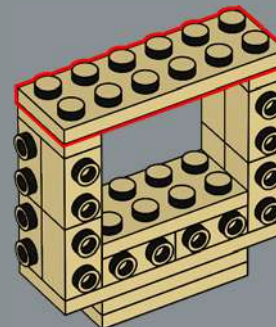

1x



3x

72

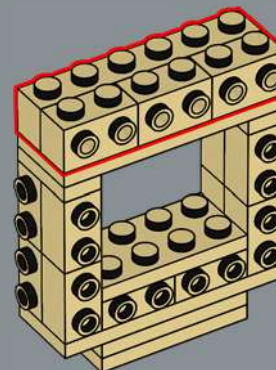

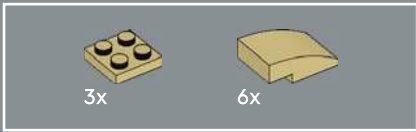

73

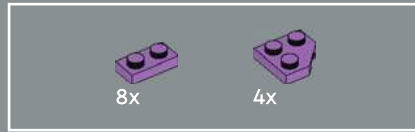
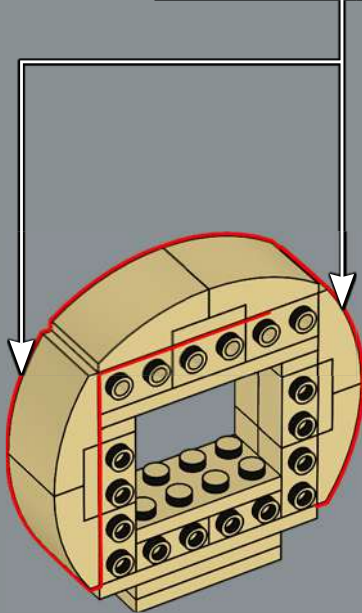
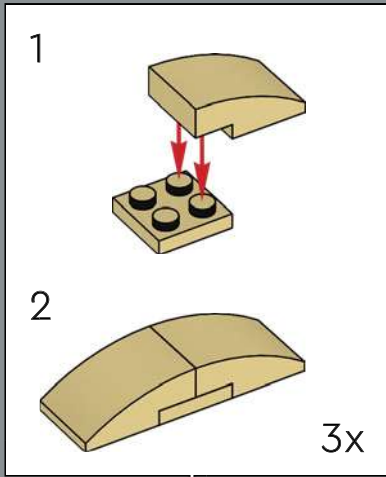

74

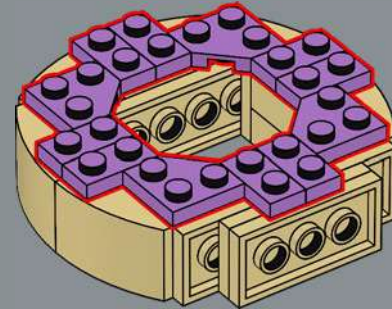

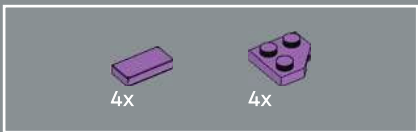

75

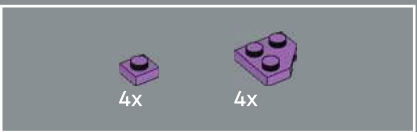
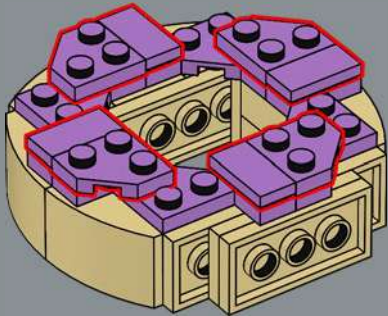

76

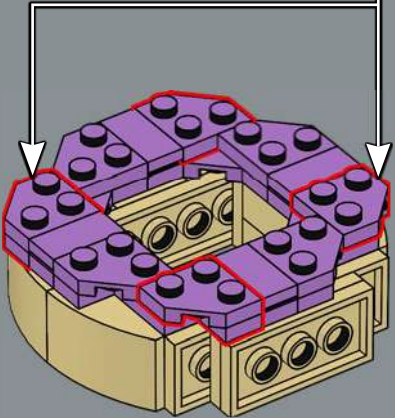
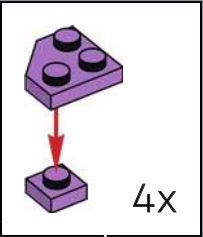

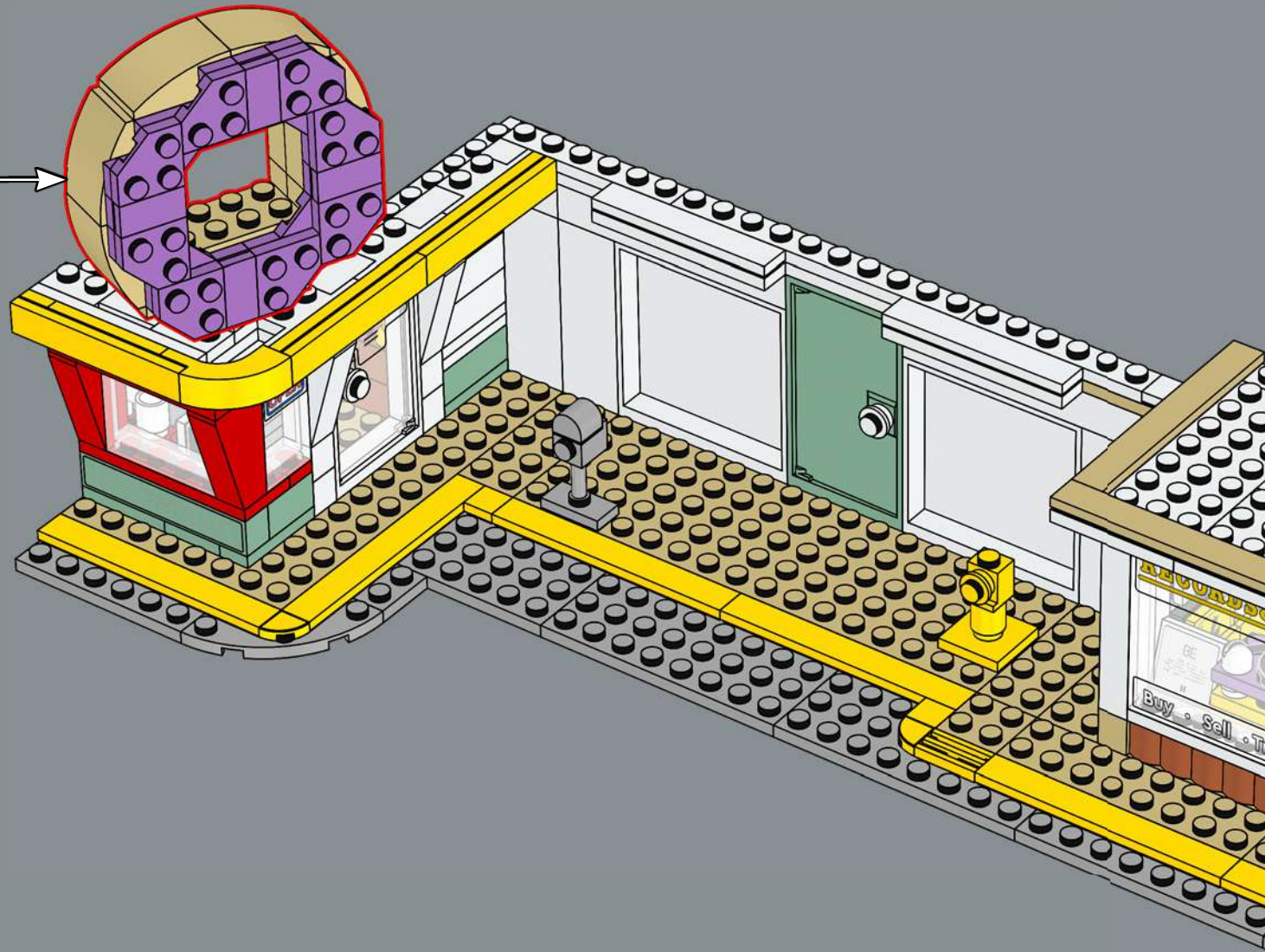

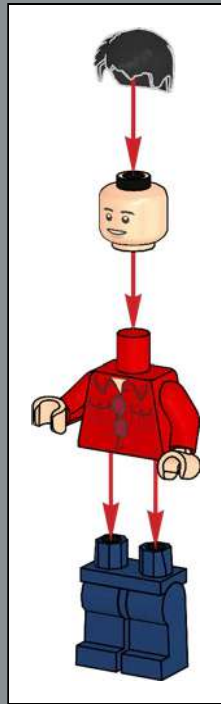

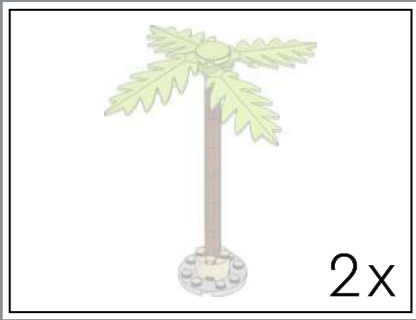

1

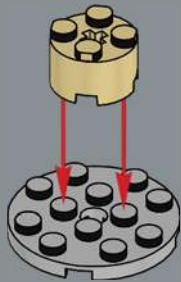

2

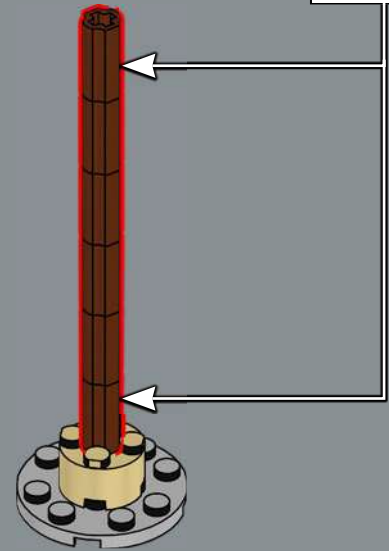
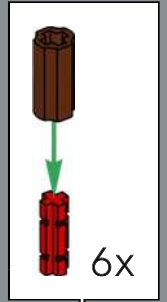

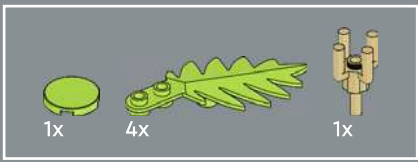

3

1

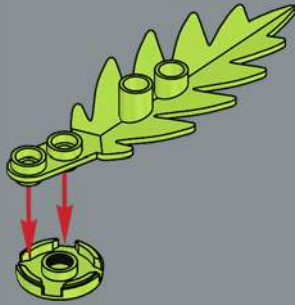

2

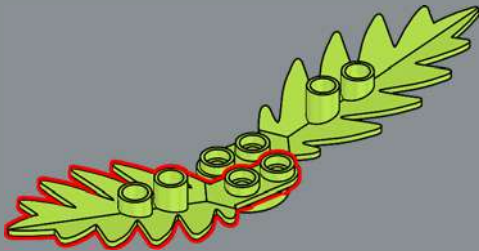

3

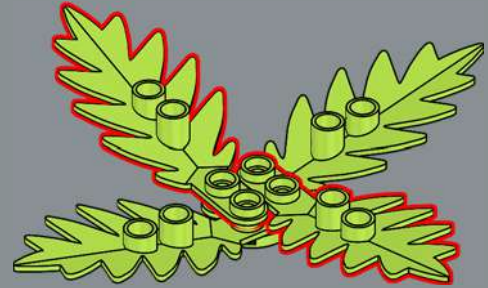

4

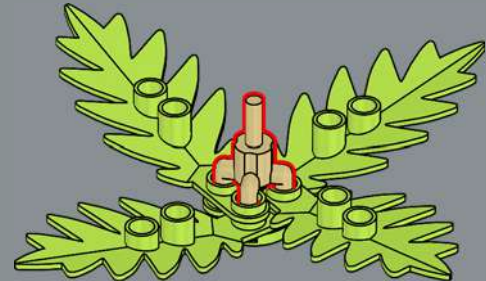



2x



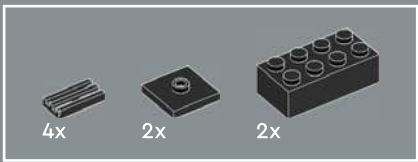

78

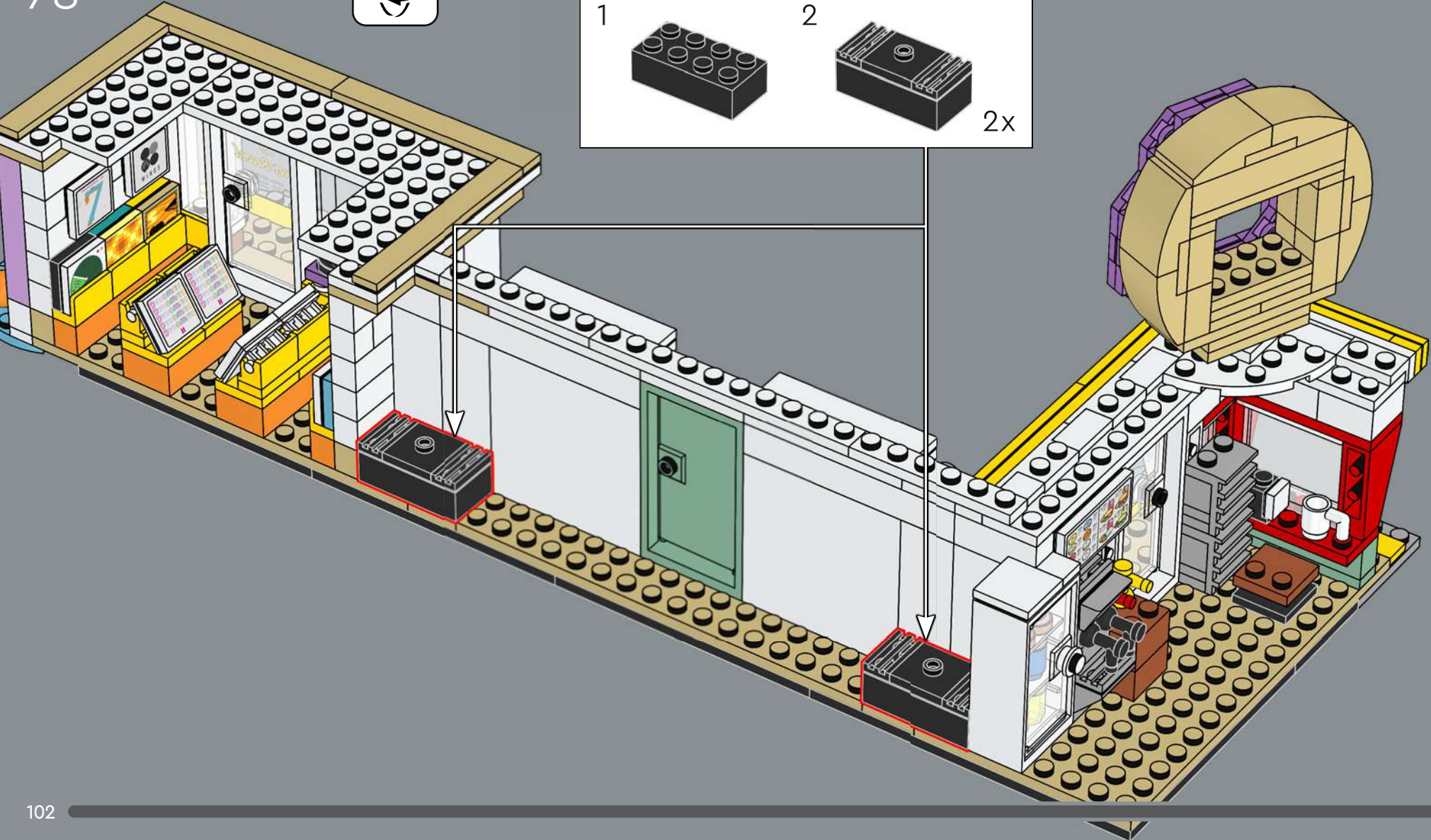
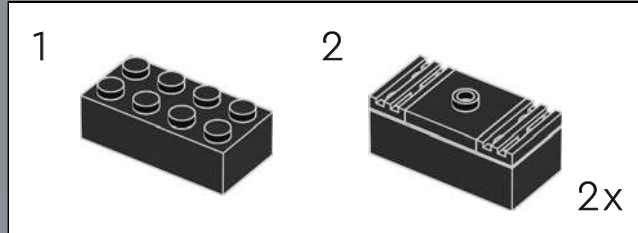

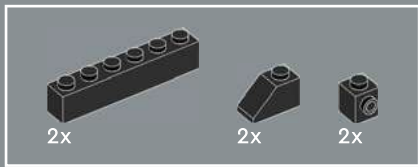

79

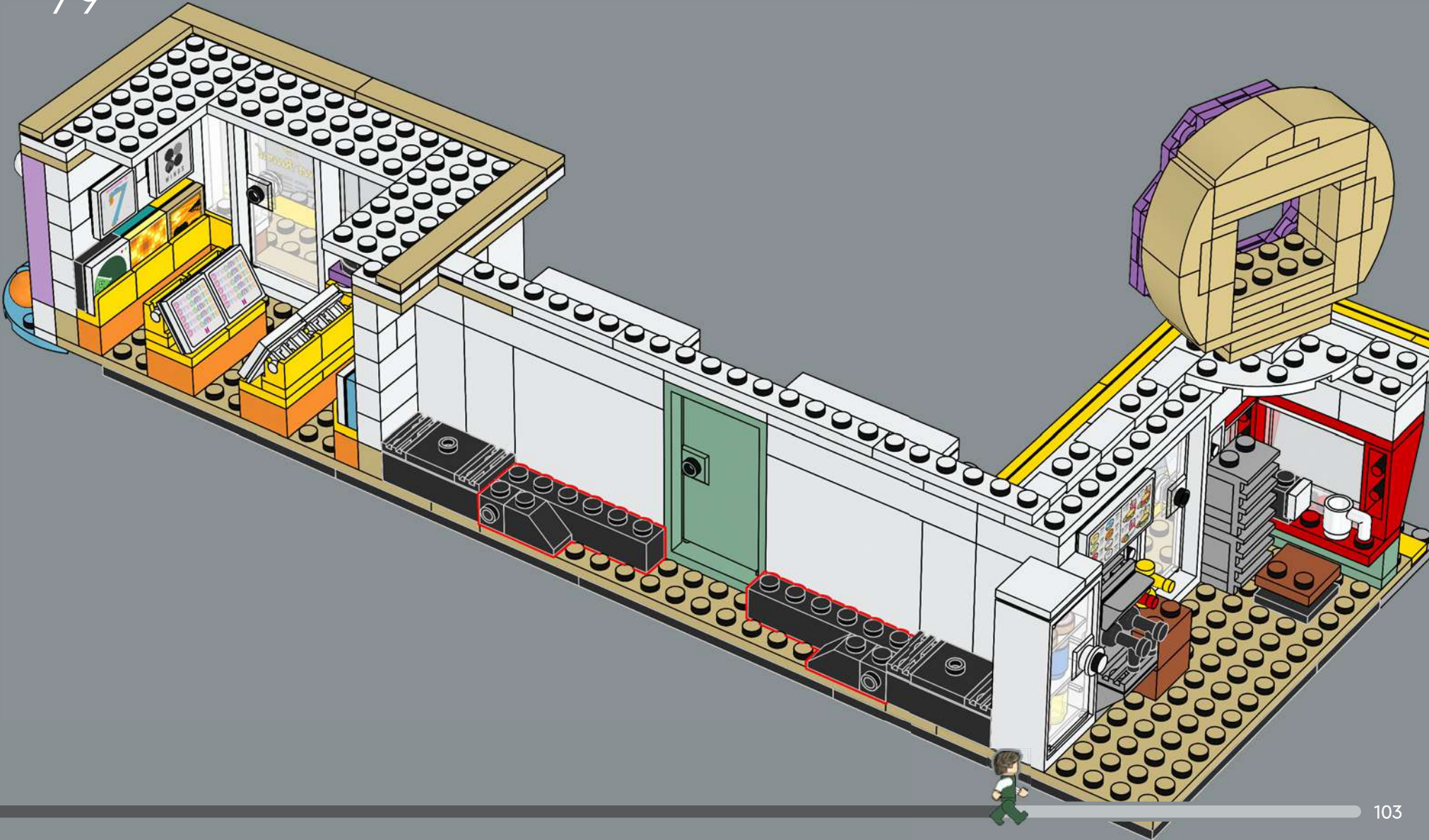

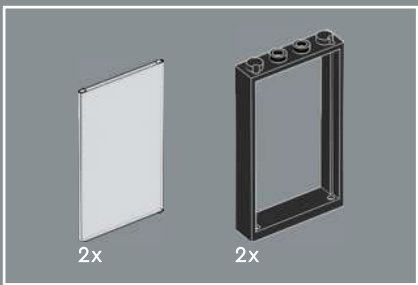

80

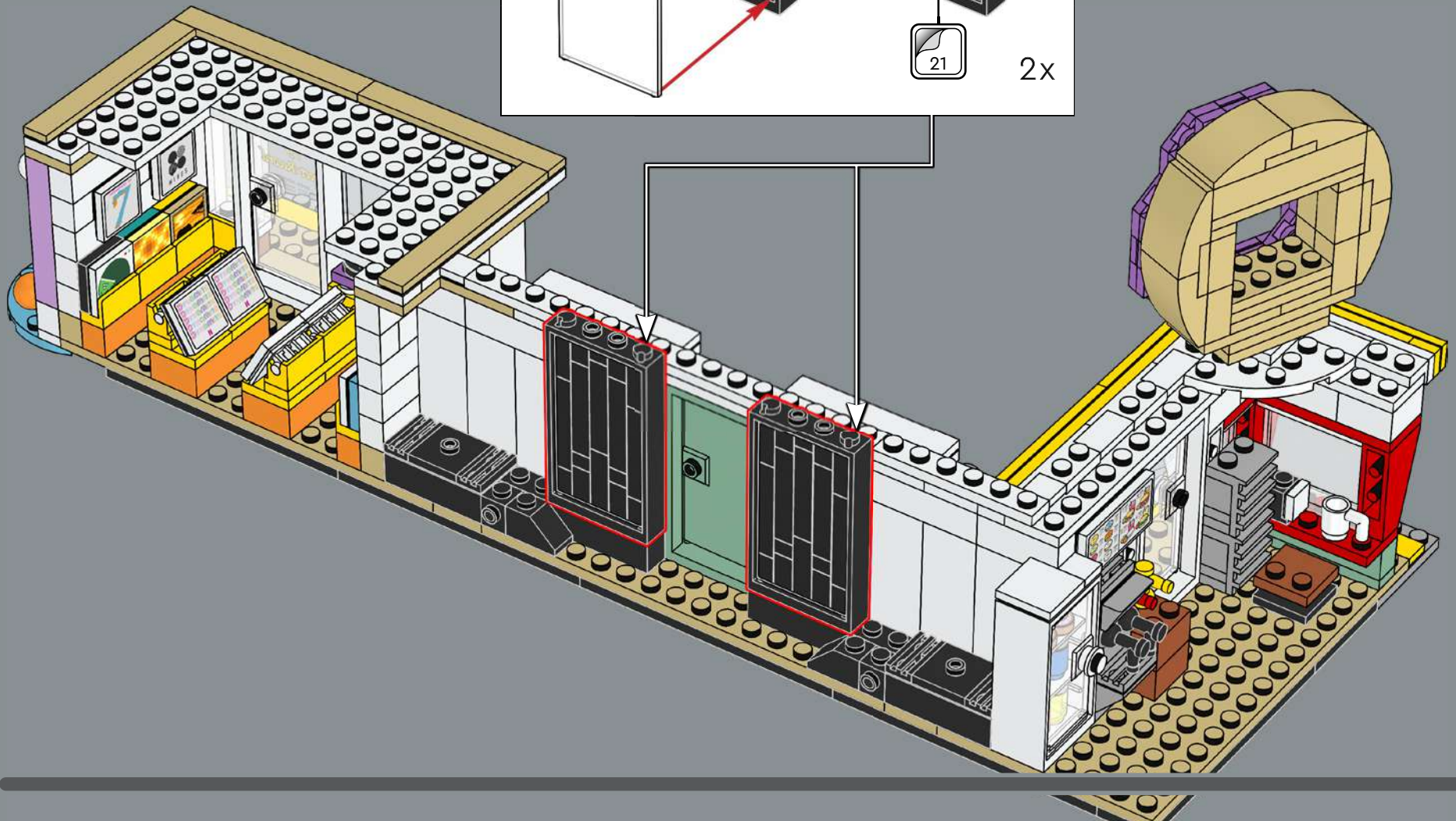
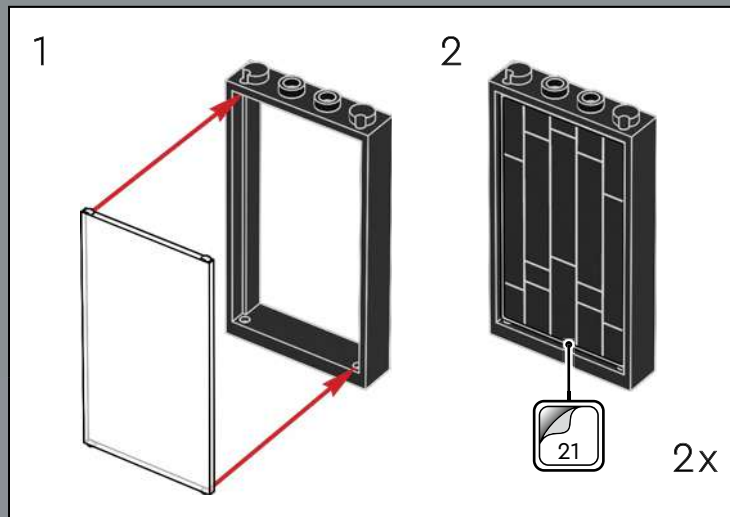

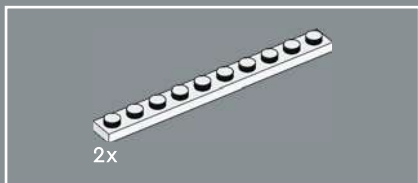

81

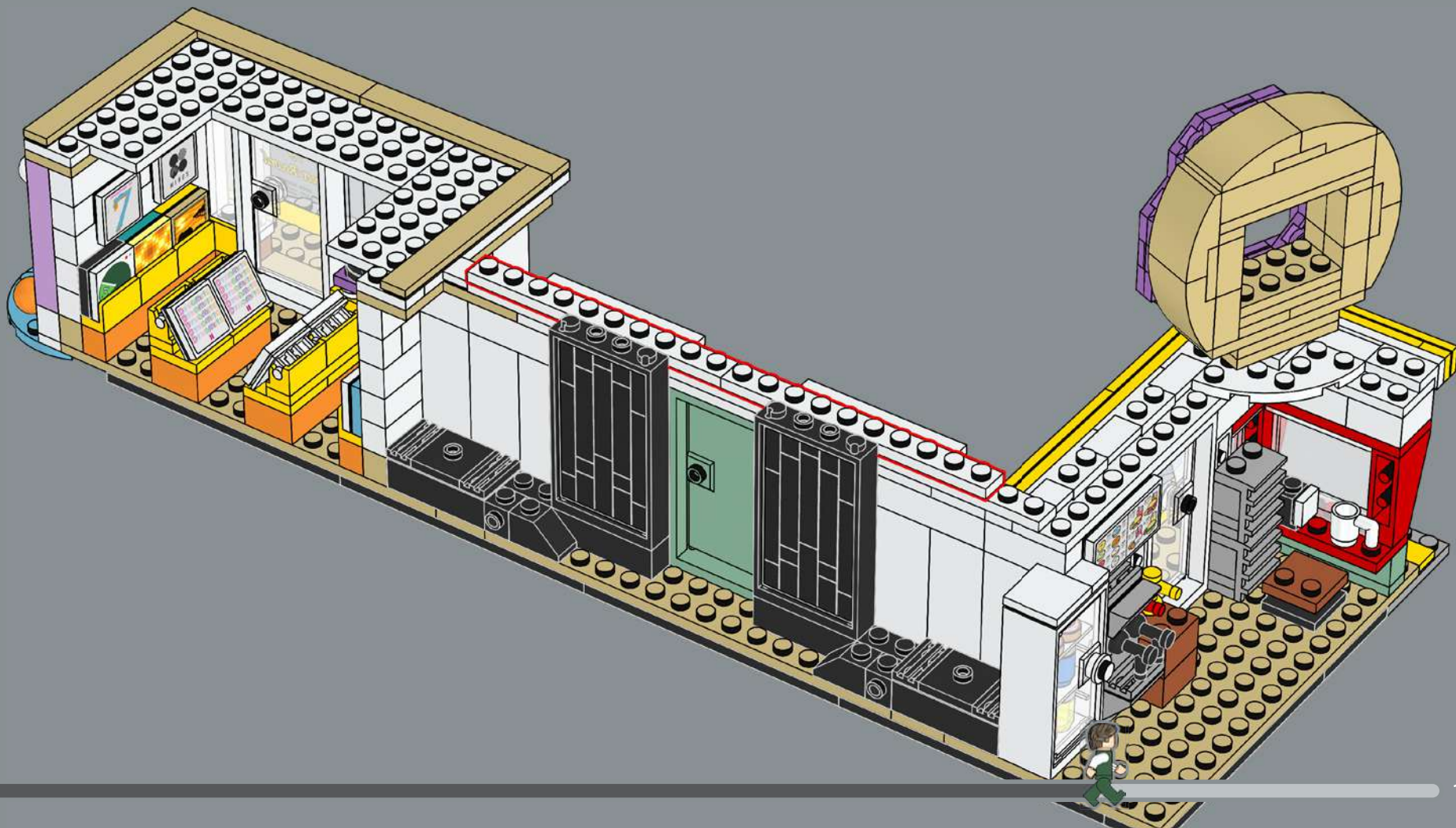

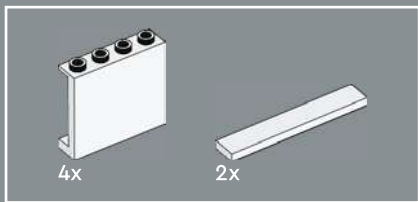

83

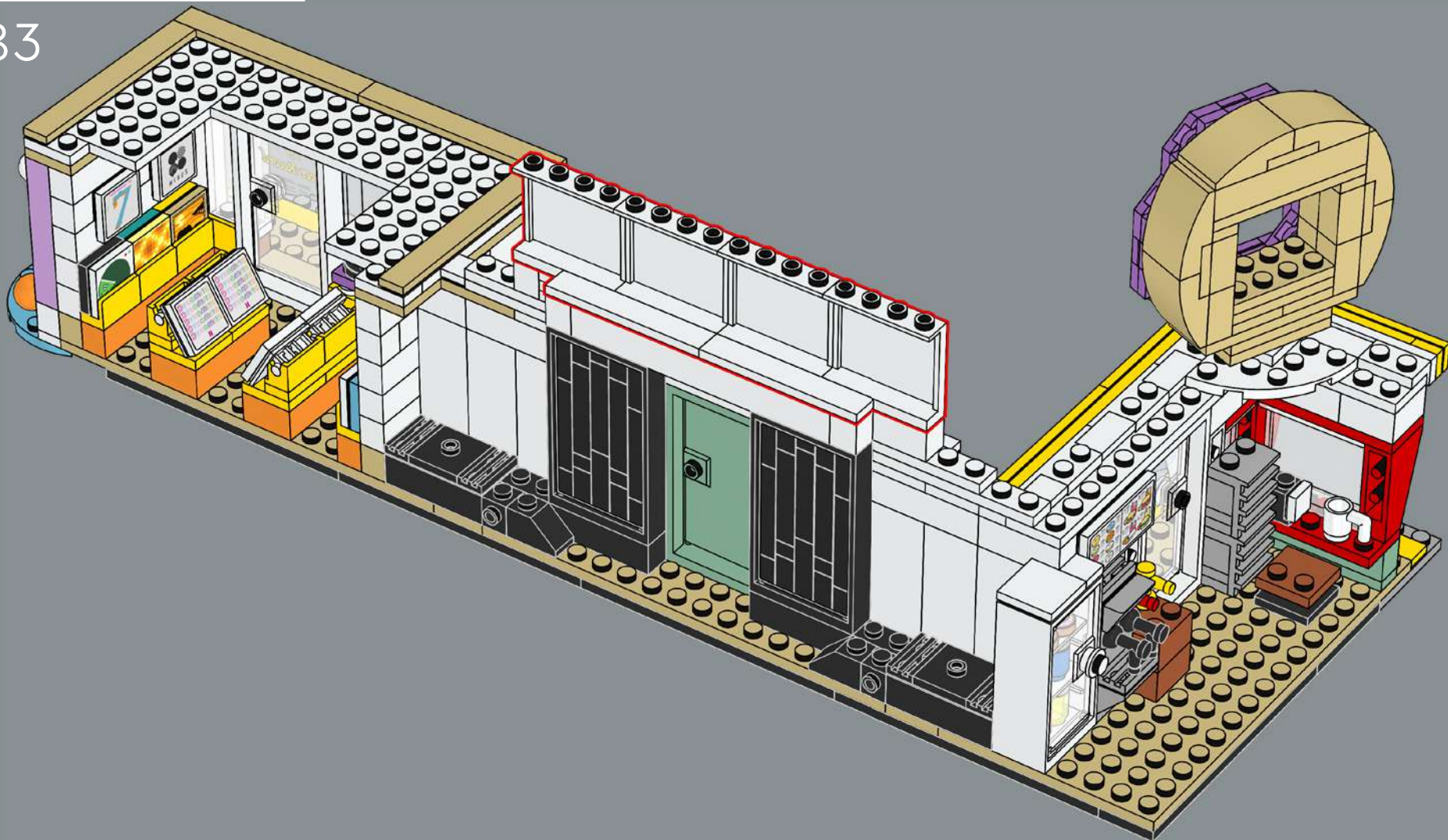

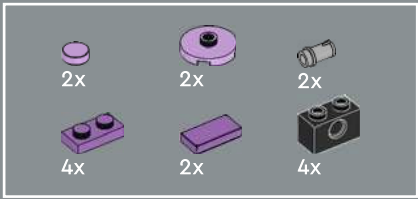

84

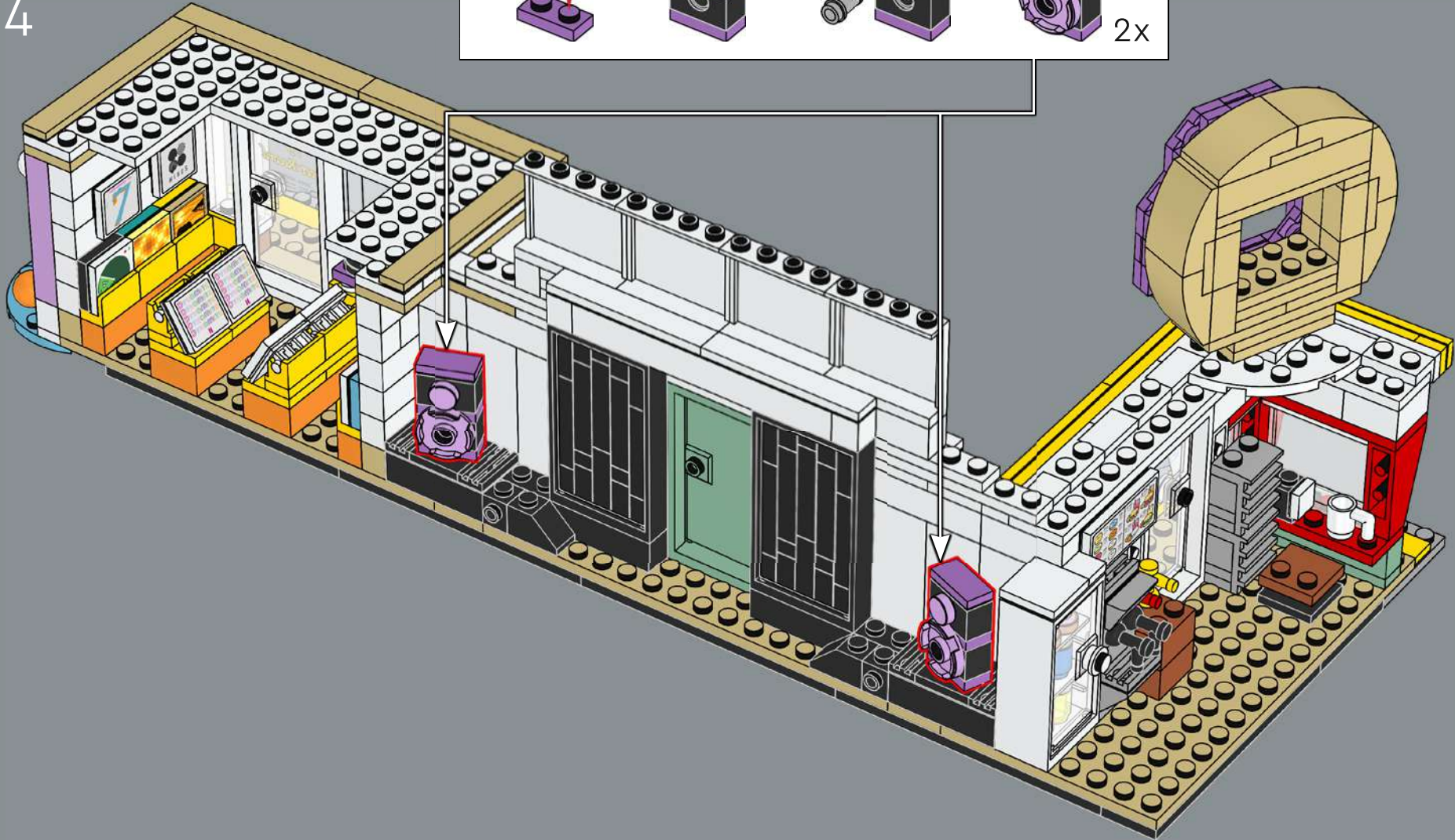
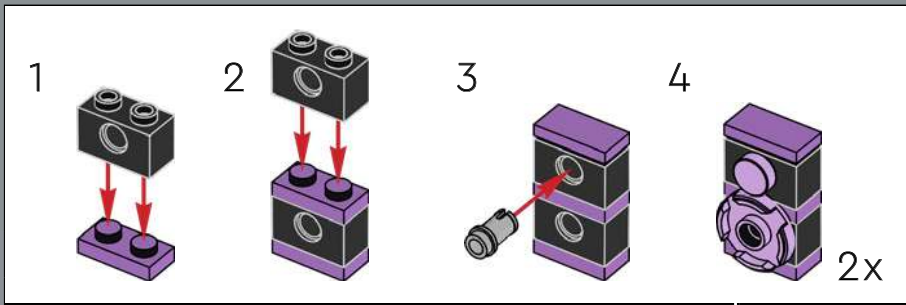

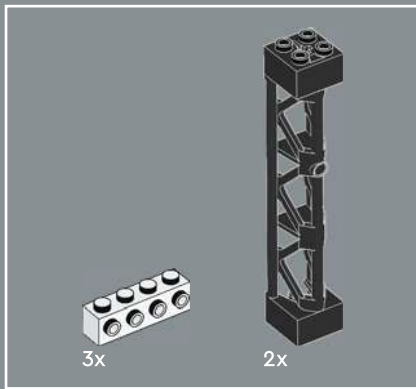

85

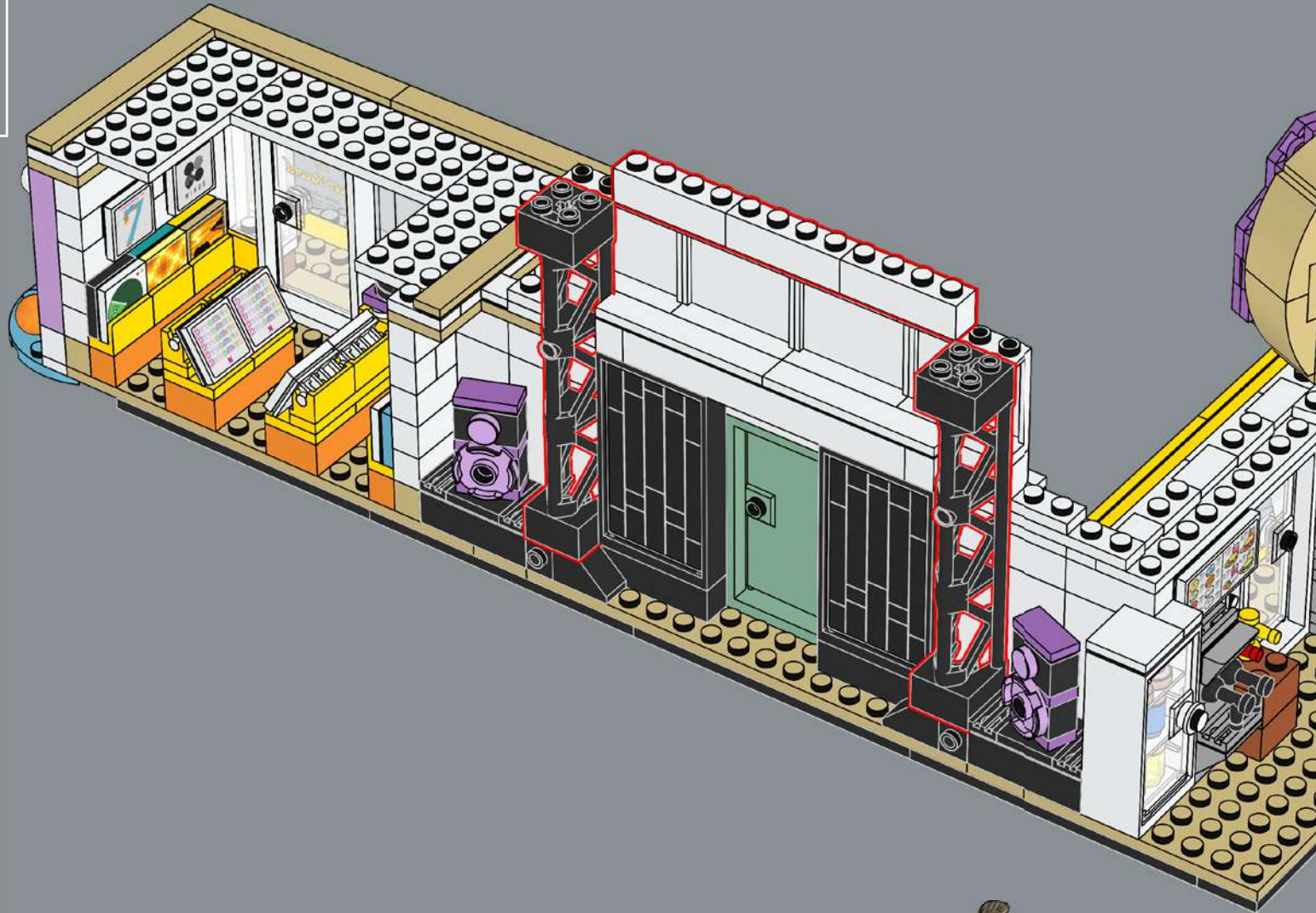

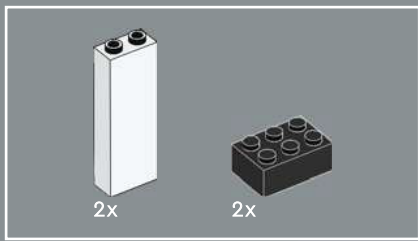

86

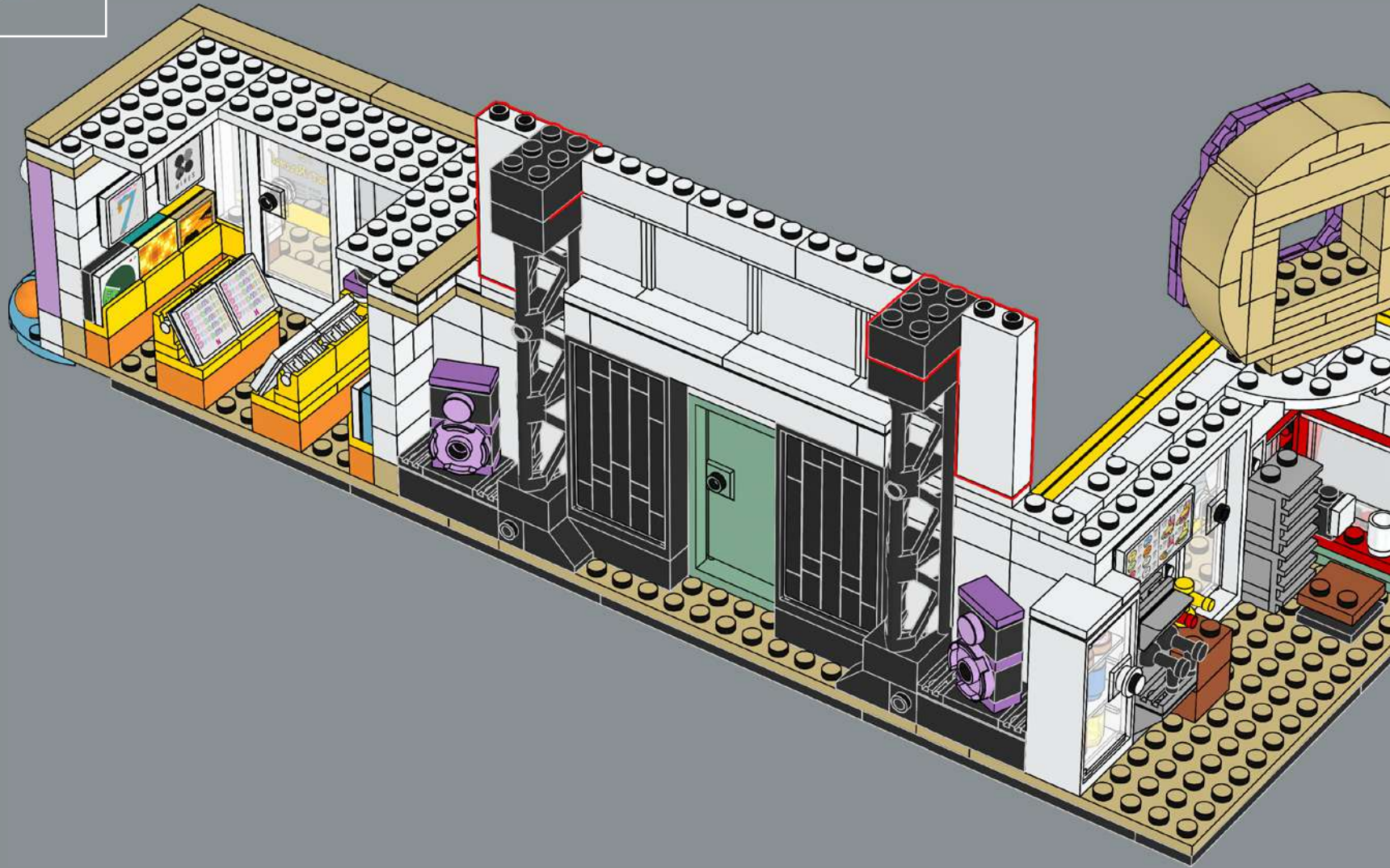

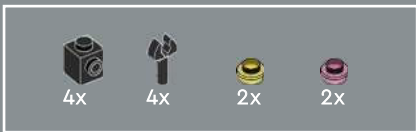

87

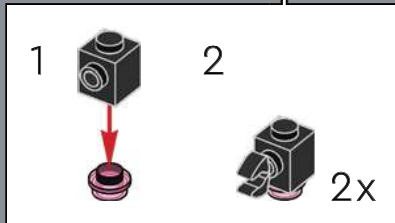
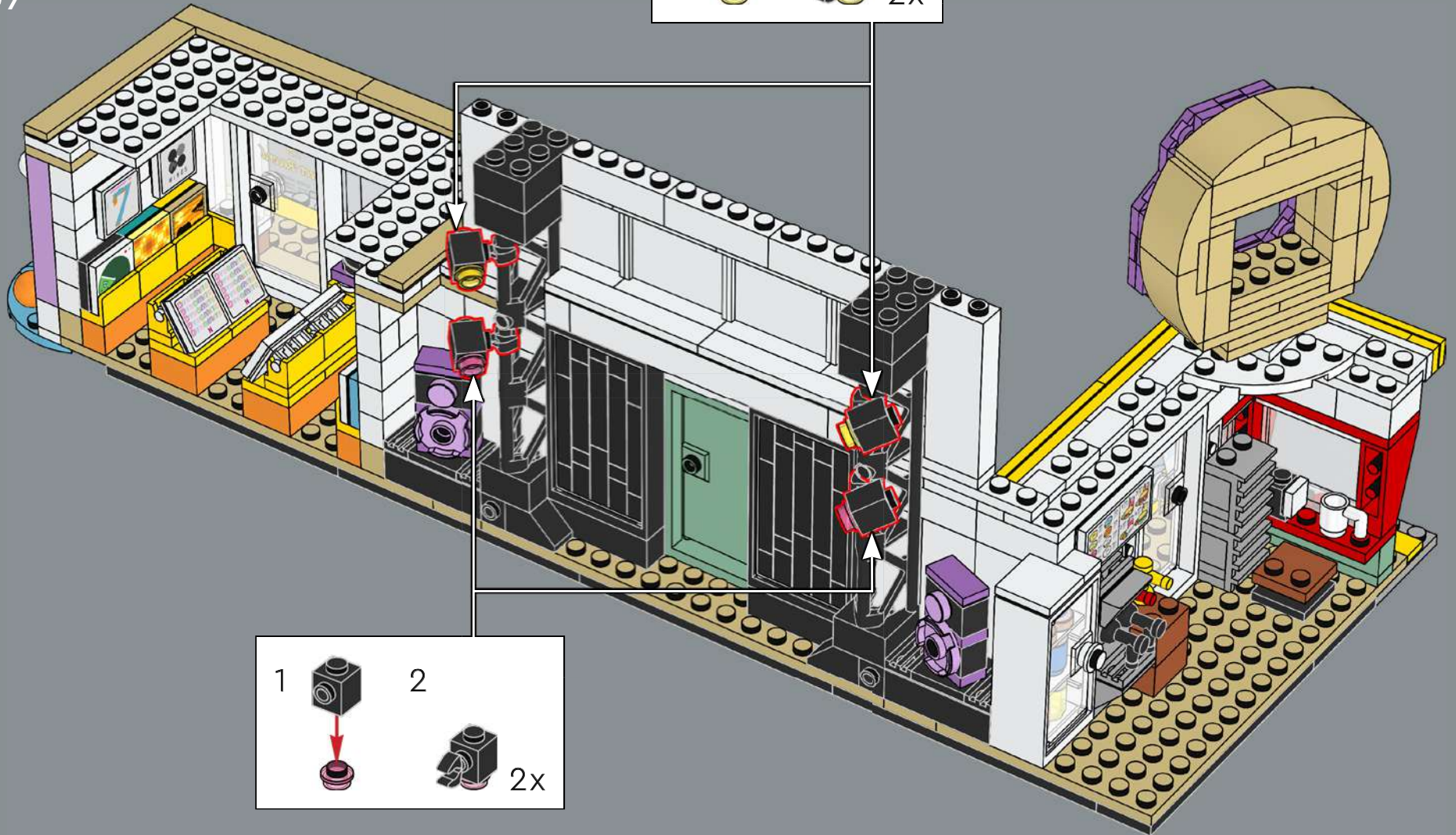
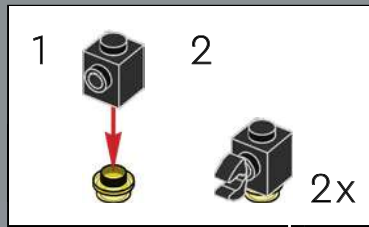

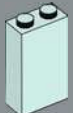

8x



88

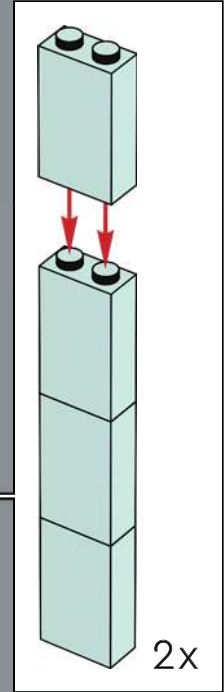

2x

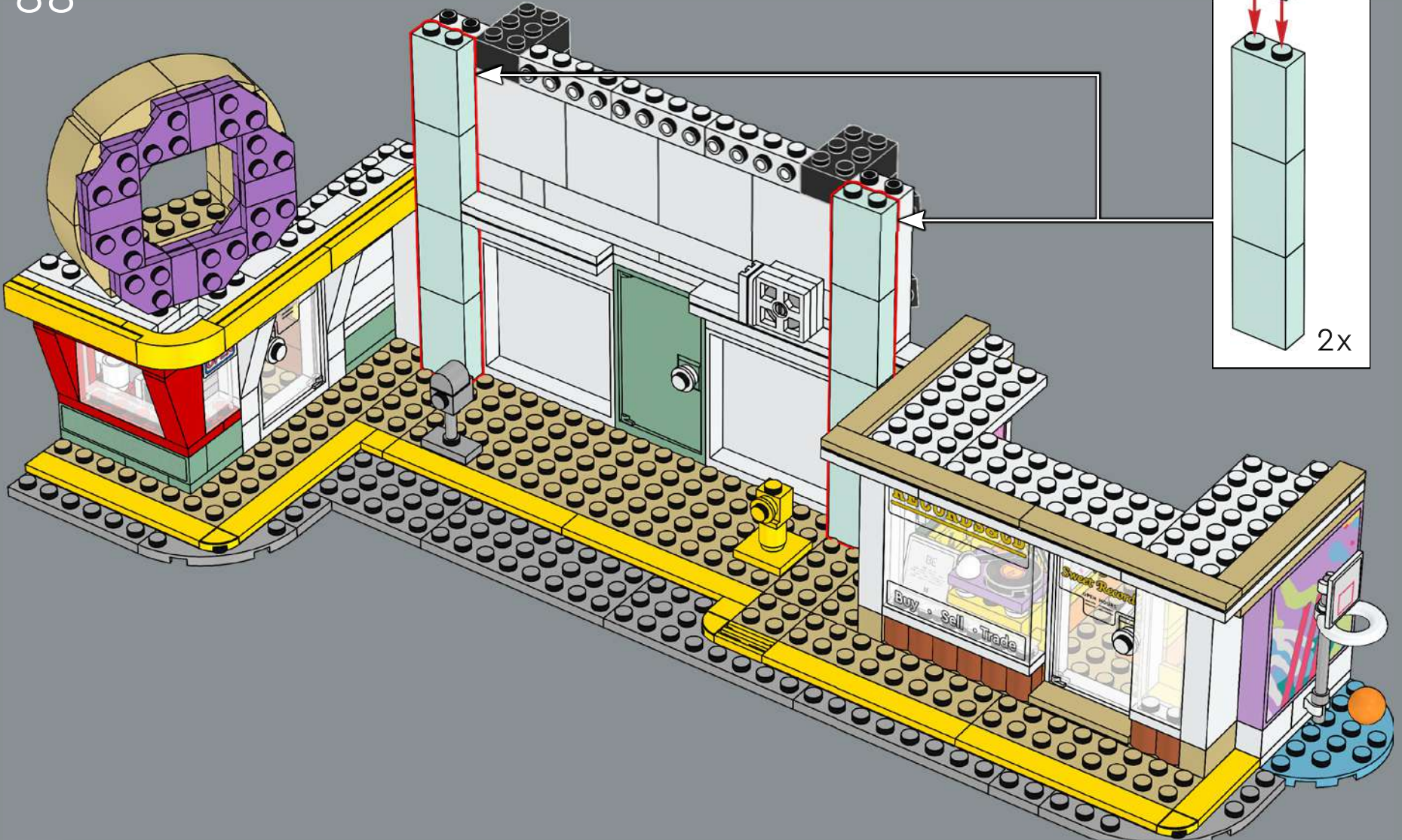

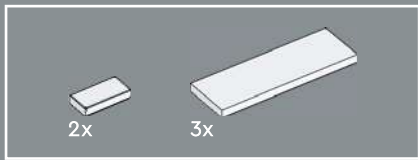

89

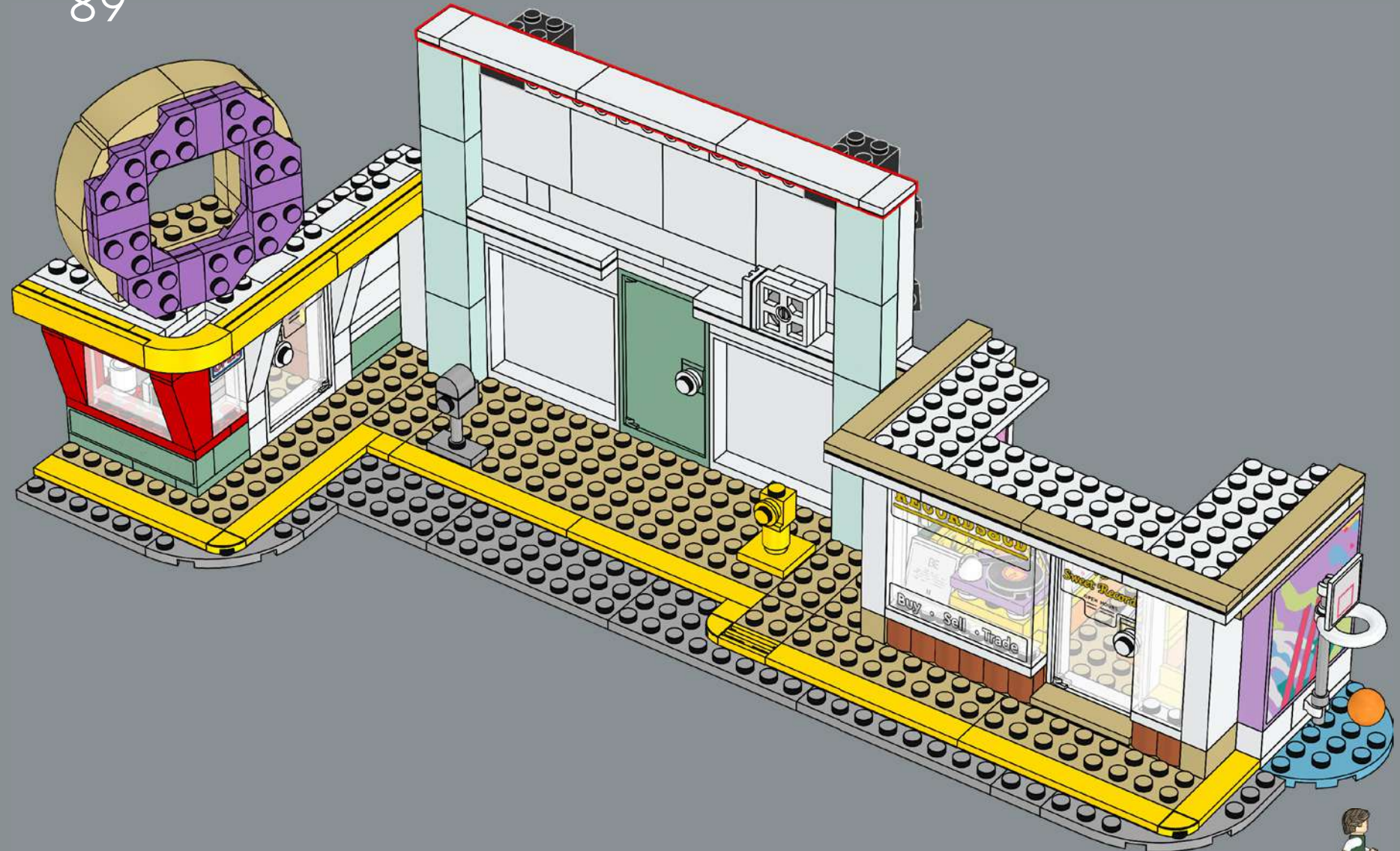

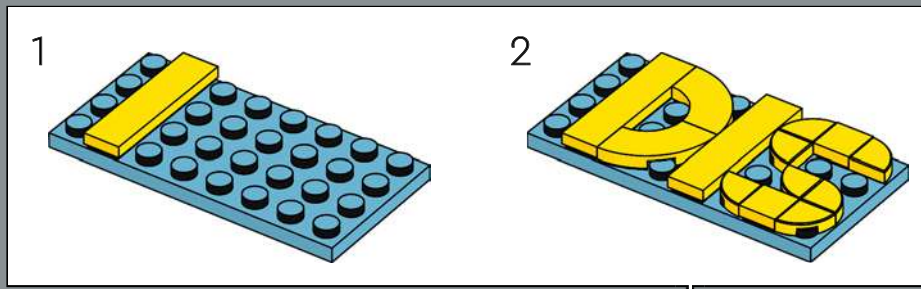
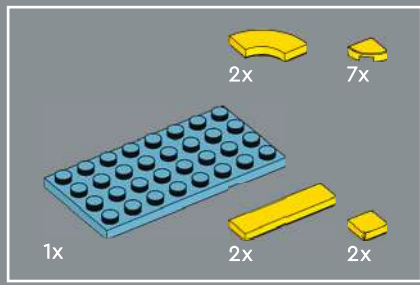

90

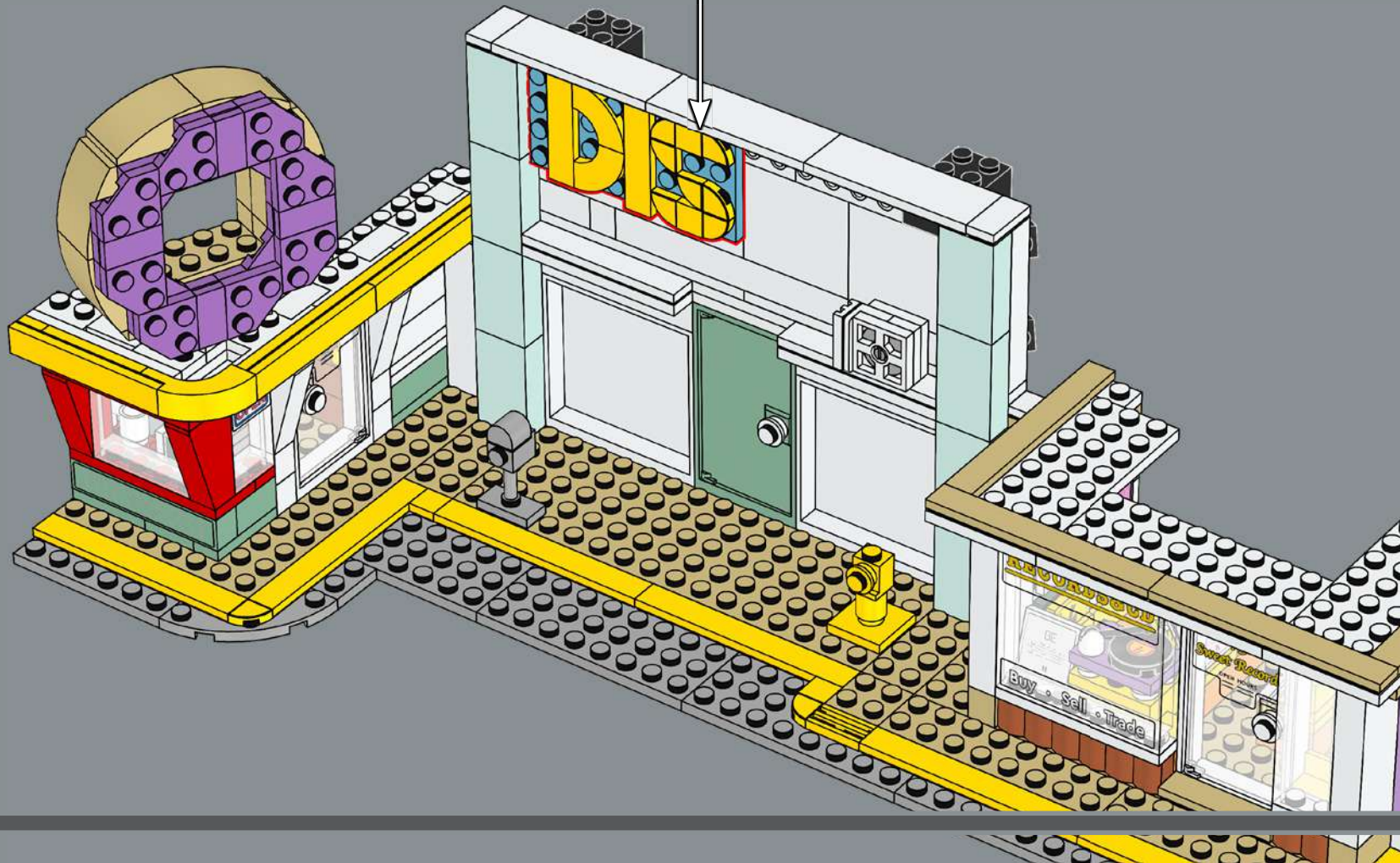

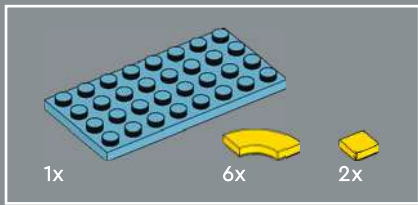

91

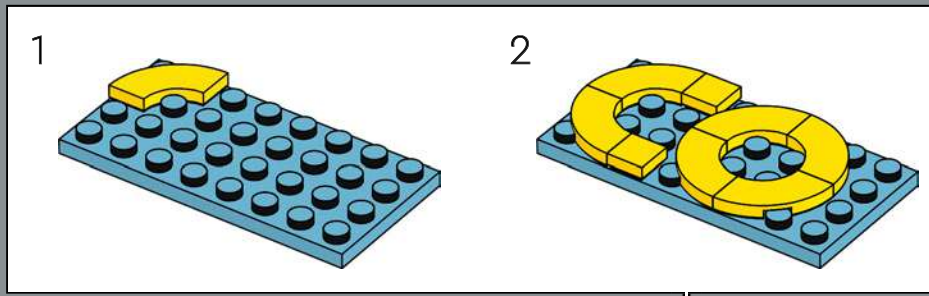

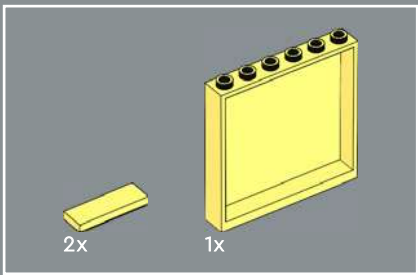

92

1

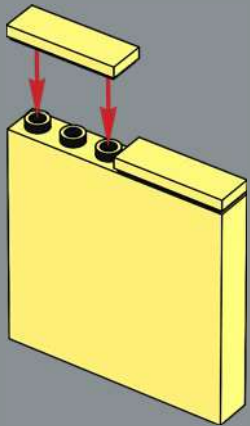

2







IDEAS

SHARE YOUR IDEA
TEILE DEINE IDEE
PARTAGEZ VOTRE IDÉE
CONDIVIDI LA TUA IDEA
COMPARTI TU IDEA
PARTILHA A TUA IDEIA
分享创意
PODZIEL SIĘ POMYSŁEM

SDÍLEJTE SVÉ NÁPADY
ZDIEĽAJTE SVOJE NÁPADY
OSZD MEG AZ ÖTLETED!
İMPARTIŞEŞTE IDEEA TA
СПОДЕЛЕТЕ ИДЕИТЕ СИ
PARĀDI SAVU IDEJU
JAGA OMA IDEED
PASIDALINK SAVO IDĒJA

GATHER SUPPORT
HOL DIR UNTERSTÜTZUNG
RECUEILLES DES VOTES
CHIEDI DI ESSERE SUPPORTATO
CONSIGUE APOYOS
OBTÉM APOIO
争取支持
ZDOBĄDŹ GŁOSY

ZÍŠKEJTE PODPORU
ZÍŠKAJTE PODPORU
SZEREZZ TÁMOGATÁST!
CERE SPRIJIN
ПОЛУЧЕТЕ ПОДКРЕПА
IEGŪSTI ATBALSTU
KOGU TOETUST
RINK PALAIKYMA



LEGO® REVIEW
LEGO® PRÜFUNG
EXAMEN PAR LEGO®
REVIEW LEGO®
REVISIÓN DE LEGO®
AVALIAÇÃO LEGO®
乐高®审核
OCENA LEGO®

OUZENÍ DESIGNÉRY LEGO®
POSÚDENÉ DIZAJNÉRMÍ LEGO®
LEGO® VÉLEMÉNYEZÉS
VERIFICARE LEGO®
ПРЕГЛЕД НА LEGO®
LEGO® RECENZIA
LEGO® ARVUSTUS
LEGO® APŽVALGA

NEW LEGO® PRODUCT®
NEUES LEGO® PRODUKT
NOUVEAU PRODUIT LEGO®
NUOVO PRODOTTO LEGO®
NUEVO PRODUCTO LEGO®
NOVO PRODUTO LEGO®
全新乐高®产品
NOWY PRODUKT LEGO®

NOVÁ STAVEBNICE LEGO®
NOVÁ STAVEBNICA LEGO®
ÚJ LEGO® TERMÉK
PRODUS LEGO® NOU
НОВ ПРОДУКТ LEGO®
JAUNS LEGO® PRODUKTS
UUS LEGO® TOODE
NAUJAS LEGO® PRODUKTAS



ideas.LEGO.com

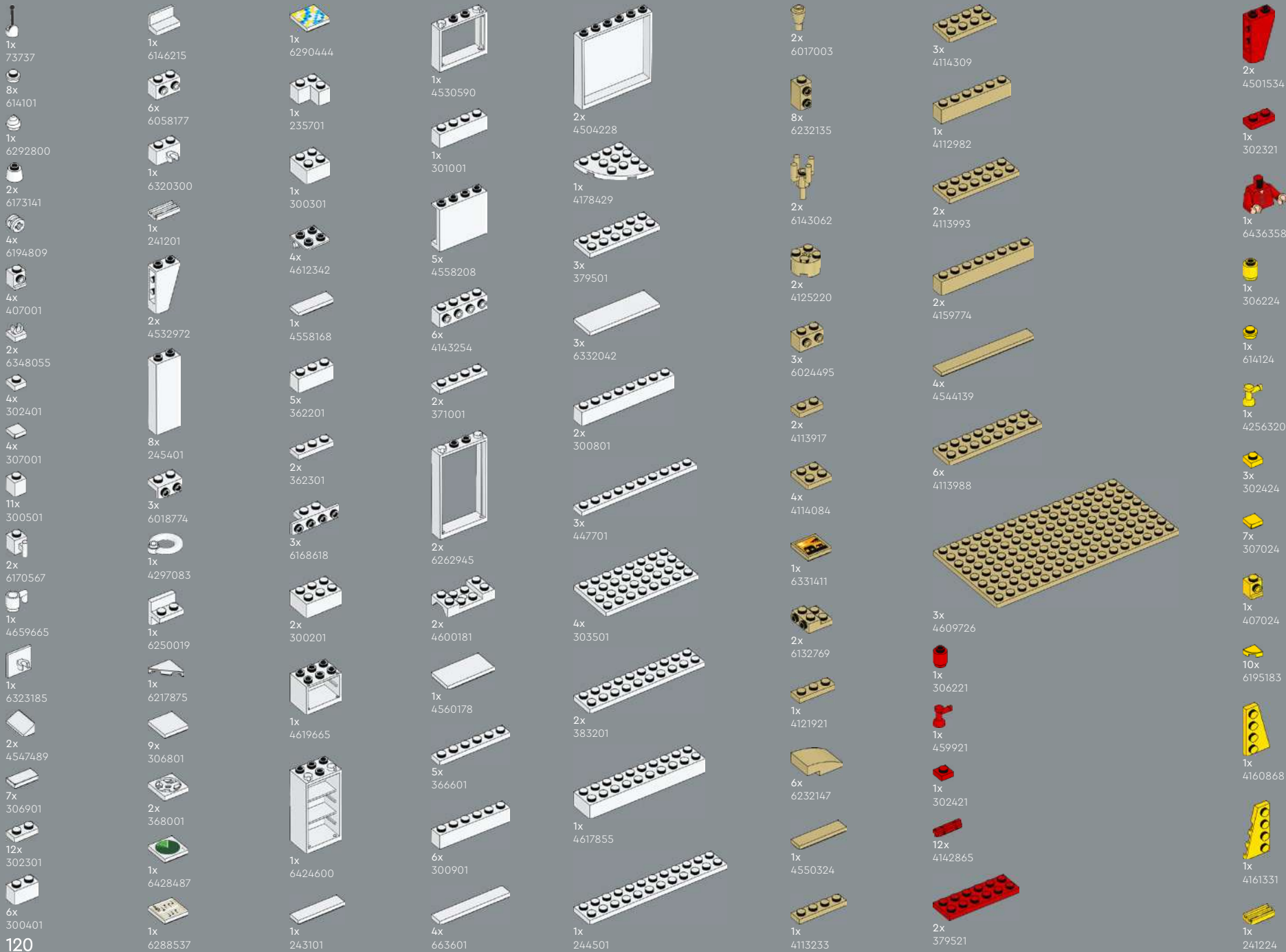

 8x 6146219	 1x 6353940	 1x 614126	 3x 6104328	 2x 300226	 2x 6254254	 2x 6258607	 1x 6220715	 2x 4162916
 4x 393724	 1x 6436307	 4x 6278152	 2x 6284070	 2x 301026	 1x 6211814	 1x 6253216	 2x 4518029	 1x 4226869
 1x 6223076	 1x 6436307	 2x 459926	 4x 241226	 2x 301026	 1x 6251285	 1x 6253735	 1x 6307452	 2x 6013102
 5x 6224666	 1x 6424855	 6x 300526	 2x 4121966	 2x 6337273	 1x 6424601	 1x 6253735	 1x 4121739	 2x 6013102
 8x 6275508	 4x 4666352	 4x 302426	 2x 303926	 2x 300126	 1x 6424601	 1x 6253735	 2x 6126063	 1x 306223
 1x 6126050	 2x 6212081	 1x 6335388	 3x 4565323	 5x 302026	 2x 6256058	 1x 6249390	 1x 4118787	 1x 6436245
 1x 4652261	 1x 6394948	 1x 407026	 4x 302126	 4x 6076678	 2x 6247362	 2x 6092766	 3x 4189007	 1x 6436295
 1x 300224	 1x 6436424	 6x 4558954	 2x 302226	 5x 300926	 2x 6247362	 2x 6056291	 3x 4189007	 1x 4616581
 3x 371024	 1x 6436424	 1x 4526110	 2x 302226	 1x 366626	 1x 6245269	 2x 6056291	 3x 4189007	 1x 4655080
 3x 243124	 1x 6431014	 4x 4516843	 2x 4667463	 5x 383226	 1x 6245269	 1x 4267425	 3x 4189007	 1x 4655080
 3x 663624	 3x 4593678	 1x 6420572	 2x 4667463	 1x 611126	 1x 6253681	 1x 6436300	 3x 4189007	 3x 6069257
 6x 4189400	 13x 370026	 4x 362226	 2x 6424625	 4x 4514845	 1x 6245253	 8x 6328085	 3x 4189007	 1x 6330616
 1x 4514844	 3x 6313116	 1x 6162892	 2x 6371406	 3x 246526	 1x 6245253	 1x 6424854	 12x 4531751	 8x 6434148

- 4x 6327722
- 4x 6168647
- 2x 4539481
- 1x 4226995
- 5x 6170418
- 9x 6275844
- 2x 4211483
- 1x 4211476
- 1x 6262085
- 3x 6248890
- 2x 6420741
- 1x 4568637
- 2x 4540203
- 1x 4211383
- 1x 4211357
- 1x 6066097
- 5x 4211398
- 2x 4211350
- 3x 4211388
- 1x 6123809
- 2x 6285243

- 4x 6322904
- 1x 6093527
- 1x 6435857
- 1x 6118827
- 3x 4515351
- 1x 4211395
- 1x 4579294
- 1x 4211452
- 1x 4211404
- 1x 6368430
- 4x 4211408

- 1x 6060795
- 2x 6031883
- 3x 6092768
- 1x 6353189
- 2x 6424476
- 1x 4615728
- 1x 6002148
- 1x 6424856
- 1x 6346547
- 1x 6342692
- 1x 6177081

- 9x 6133119
- 1x 6436391
- 1x 6058014
- 5x 6286832
- 1x 6335367
- 1x 6296492
- 2x 6195265
- 1x 6248756
- 3x 6296524
- 1x 6309939
- 1x 6248761

- 1x 6422515
- 1x 6422517
- 1x 6422519
- 1x 6422513
- 1x 6422509
- 1x 6422511
- 1x 6422521
- 1x 6436364
- 1x 4529672
- 2x 6322820
- 2x 6223598
- 1x 6249322

- 1x 6005307
- 1x 6436401
- 1x 4625032
- 1x 6029690
- 2x 6104130
- 4x 4619521
- 12x 4619512
- 6x 6152645
- 12x 6424858
- 1x 6344844
- 4x 6329593
- 2x 6248536
- 1x 6259706
- 1x 6313132



 [LEGO.com/service](https://www.LEGO.com/service)



YOU COULD WIN



YOU COULD WIN

Your feedback will help shape the future development of this product series.

Visit:

DU KÖNNTEST GEWINNEN

Dein Feedback trägt zur Weiterentwicklung dieser Produktreihe bei.

Geh auf:

VOUS POURRIEZ GAGNER

Vos commentaires nous aideront à concevoir les futurs produits de cette gamme.

Visitez :

POTRESTI VINCERE TU

La tua opinione ci aiuterà a migliorare la creazione futura di questa linea di prodotti.

Visita:

PUEDES GANAR

Tu opinión contribuirá al futuro de esta serie de productos.

Visita:

轻松获奖

您的反馈将有助于我们在今后改进本产品系列。

请访问:

[LEGO.com/productfeedback](https://www.lego.com/productfeedback)

You also have the chance to win a LEGO® set.

Terms and conditions apply.*

Außerdem hast du die Chance, ein LEGO® Set zu gewinnen.

Es gelten die Teilnahmebedingungen.*

Vous pourriez également gagner un ensemble LEGO®.

Des conditions s'appliquent.*

Hai anche la possibilità di vincere un set LEGO®.

Termini e condizioni sono applicabili.*

También tienes la oportunidad de ganar un set LEGO®.

Aplican términos y condiciones.*

您还有机会赢取乐高®套装。

条款和条件适用。*

*[LEGO.com/productfeedback-terms](https://www.lego.com/productfeedback-terms)

