



KB0818



KB0840



KB0841



KB0842



KB0814



KB0815



KB0816



KB0817



[www.blockki.fun](http://www.blockki.fun)



KB0819



MANUAL  
84  

# MY FIRE BRIGADE



6+

KB0819





x1

x2

x1

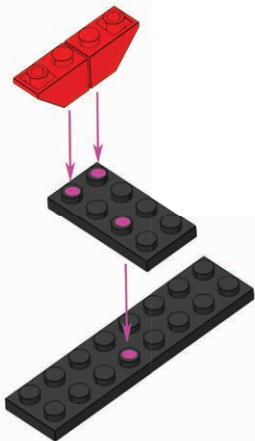

2



x1



x1



x2

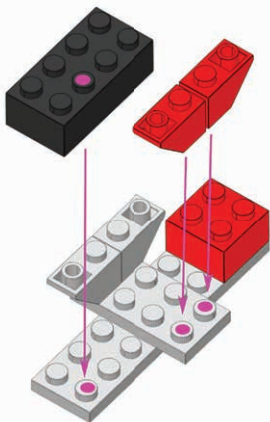



x4



4

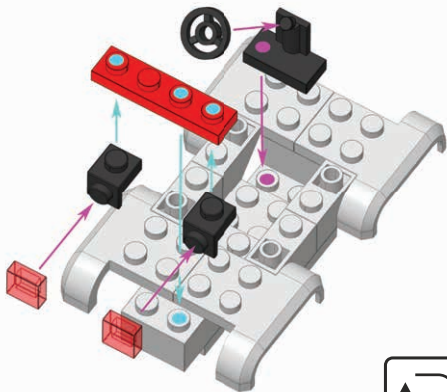
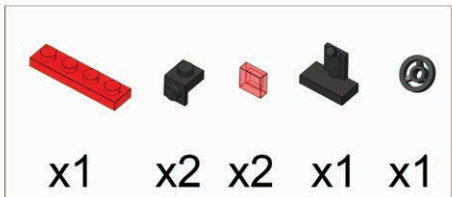

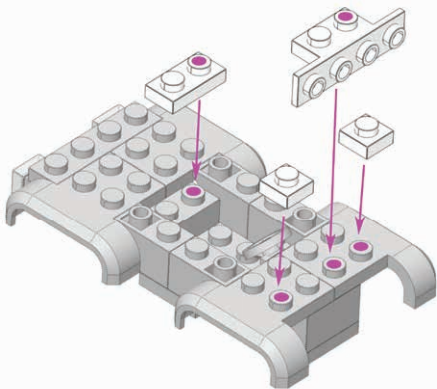
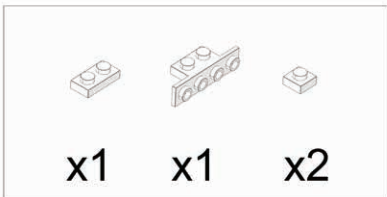



6

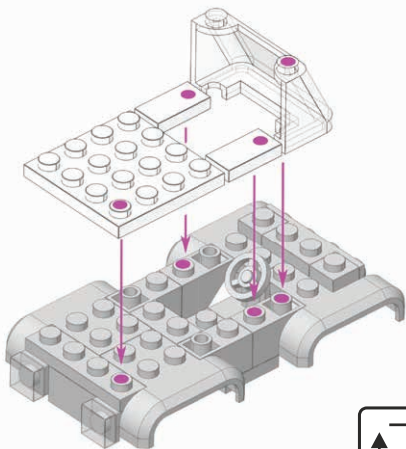
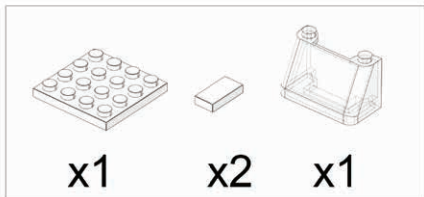



x1

x1

x1

x2

x2

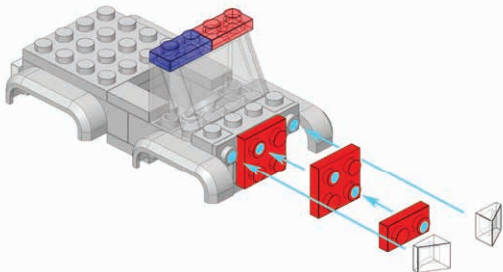

8

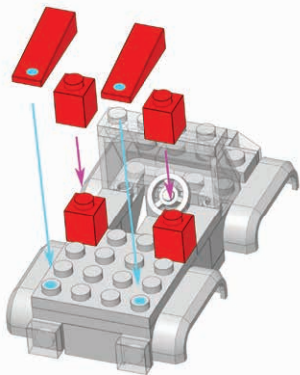
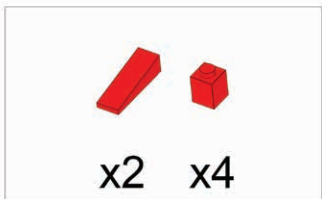



10

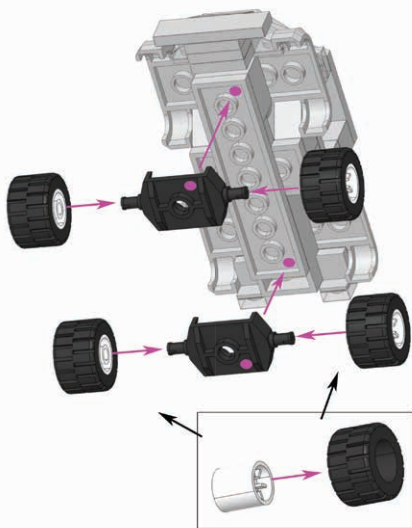

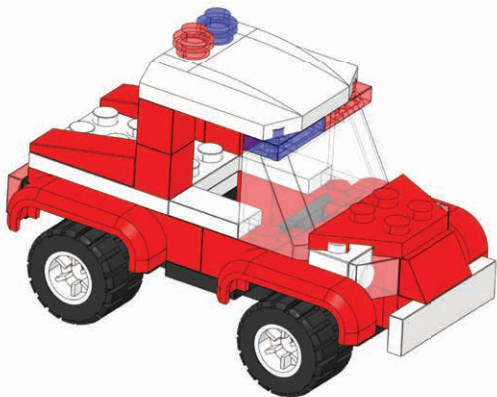

# 12



x1



x1



x1



x1

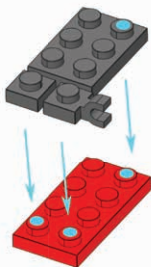



x2



x2



x4

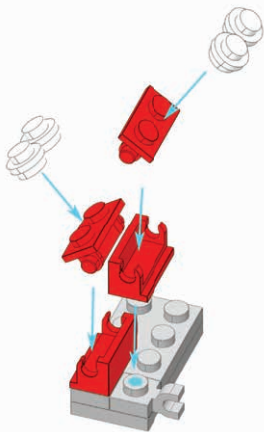



14



x2

x1





16

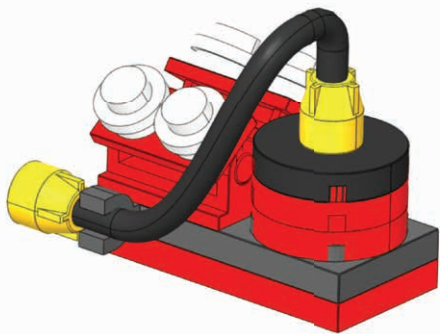





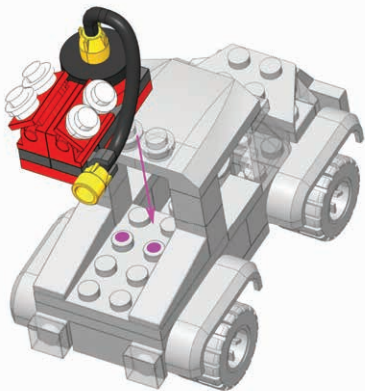

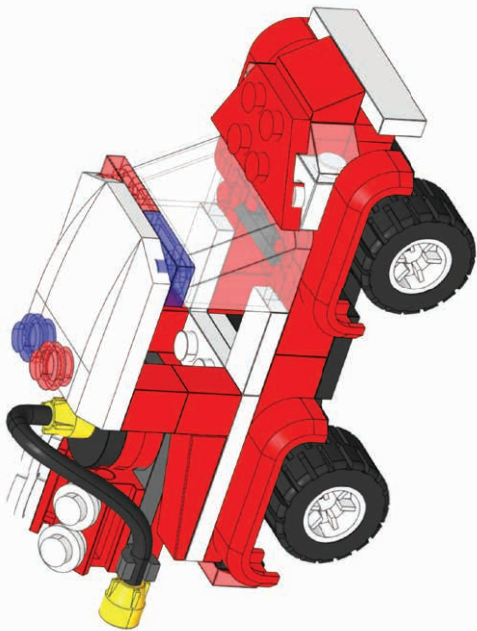



x1





	x1		x1
	x1		x1
	x1		x1
	x2		x1

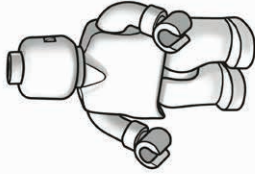
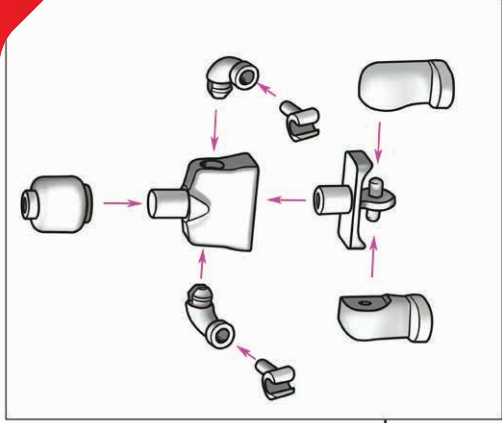

the 1990s, the number of people with diabetes has increased in all industrialized countries. In the Netherlands, the prevalence of diabetes is 6.5% (1.5% of the population with type 1 diabetes and 5% with type 2 diabetes) [1].

Diabetes is a chronic disease with a long asymptomatic period. The asymptomatic period is the period between the onset of the disease and the first symptoms. The asymptomatic period is the period between the onset of the disease and the first symptoms. The asymptomatic period is the period between the onset of the disease and the first symptoms.

The asymptomatic period is the period between the onset of the disease and the first symptoms. The asymptomatic period is the period between the onset of the disease and the first symptoms. The asymptomatic period is the period between the onset of the disease and the first symptoms.

The asymptomatic period is the period between the onset of the disease and the first symptoms. The asymptomatic period is the period between the onset of the disease and the first symptoms. The asymptomatic period is the period between the onset of the disease and the first symptoms.

The asymptomatic period is the period between the onset of the disease and the first symptoms. The asymptomatic period is the period between the onset of the disease and the first symptoms. The asymptomatic period is the period between the onset of the disease and the first symptoms.

The asymptomatic period is the period between the onset of the disease and the first symptoms. The asymptomatic period is the period between the onset of the disease and the first symptoms. The asymptomatic period is the period between the onset of the disease and the first symptoms.

The asymptomatic period is the period between the onset of the disease and the first symptoms. The asymptomatic period is the period between the onset of the disease and the first symptoms. The asymptomatic period is the period between the onset of the disease and the first symptoms.

The asymptomatic period is the period between the onset of the disease and the first symptoms. The asymptomatic period is the period between the onset of the disease and the first symptoms. The asymptomatic period is the period between the onset of the disease and the first symptoms.

