



Disney

43223





 **FR**
DONNEZ
OU
RECYCLEZ

 OU  OU 

ASSOCIATION MAGASIN DÉCHÈTERIE

Adresses sur quefairedemesdechets.fr



LEGO.com/sustainable-packaging



BUILDER



Apple and the Apple logo are trademarks of Apple Inc., registered in the U.S. and other countries and regions. App Store is a service mark of Apple Inc. Google Play and the Google Play logo are trademarks of Google LLC. Tencent and the Tencent logo are trademarks of Tencent Inc.

Q [LEGO.com/devicecheck](https://www.lego.com/devicecheck)

EN Ask parents' permission before going online | **DE** Eltern um Erlaubnis bitten, bevor du online gehst | **FR** Demande l'autorisation d'un parent avant d'aller en ligne | **IT** Chiedi il permesso ai tuoi genitori prima di andare online | **ES** Pídeles permiso a tus papás antes de conectarte a Internet | **PT** Peça autorização aos pais antes de acederes online | **ZH** 上网前应先征得父母的同意 | **PL** Poproś rodziców o zgodę, zanim wejdiesz do Internetu | **CS** Než půjdeš na internet, požádej rodiče o svolení | **SK** Skôr než pôjdeš na internet, vypýtaj si povolenie od rodičov | **HU** Kérj szülői engedélyt, mielőtt online csatlakoznál! | **RO** Cere permisiunea părinților înainte de a te conecta online | **BG** Поискайте разрешение от родител, преди да влезете онлайн | **LV** Pirms došanās tiešsaistē palūdz atļauju vecākiem | **ET** Enne Interneti kasutamist küsi vanematelt luba | **LT** Prieš prisijungdami prie interneto, atsilkauskite tėvų

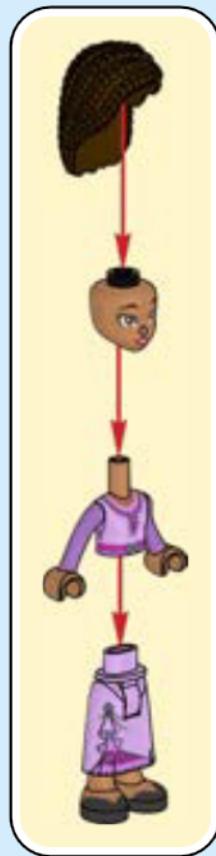

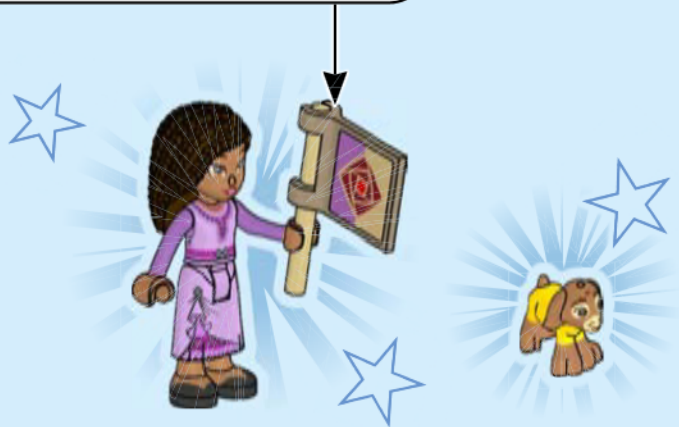

1



2



3





1

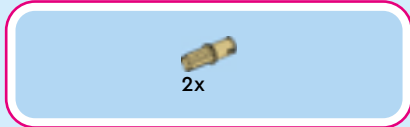

2





3



4



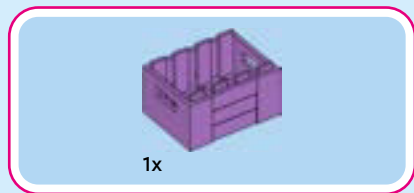

5

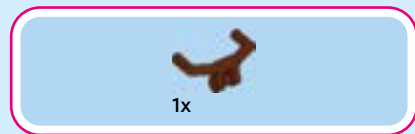
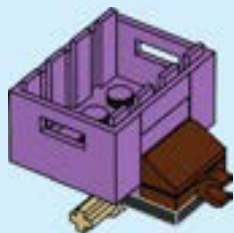

6

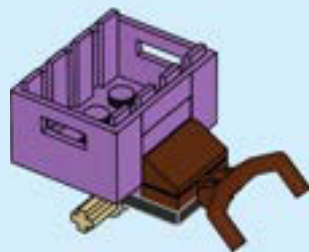



2x

7

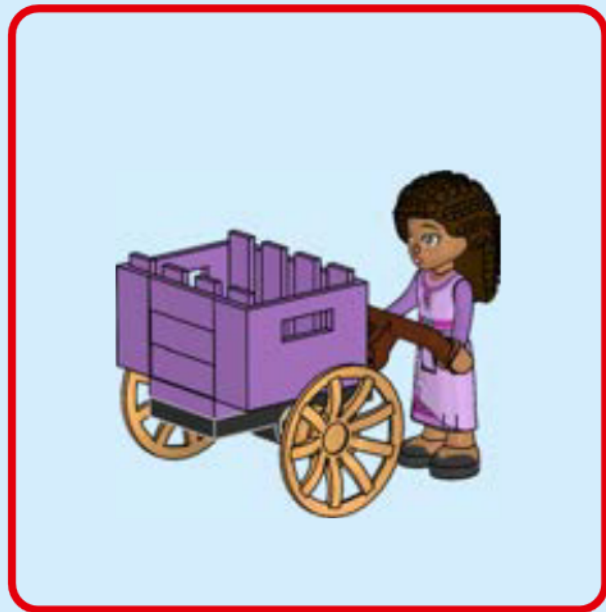



1



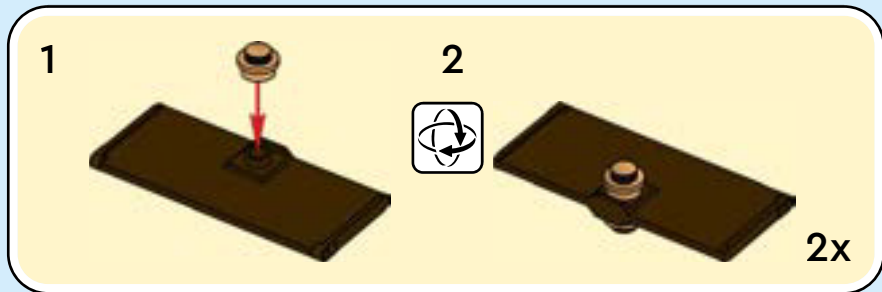
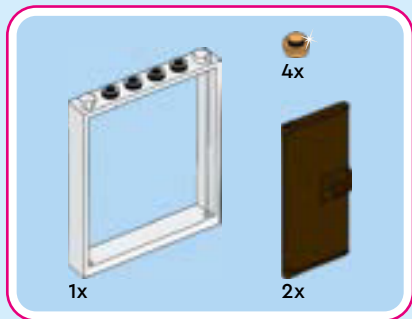

2

1

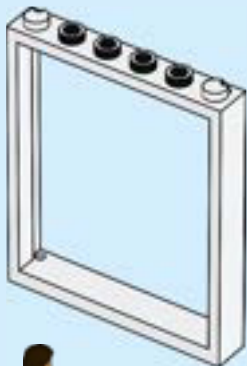

2

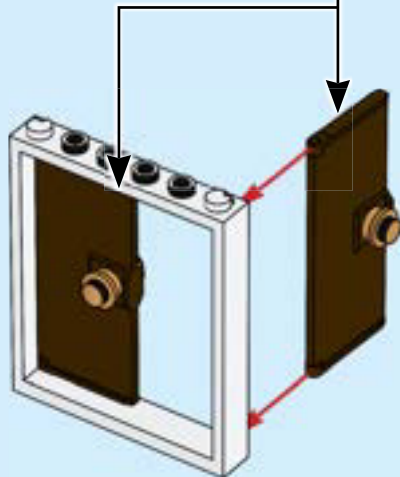

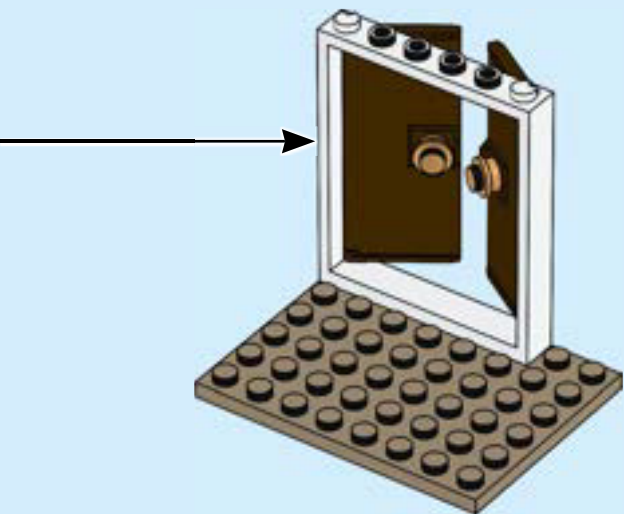

3

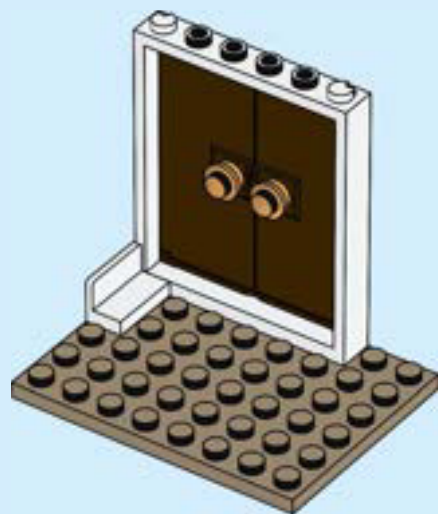

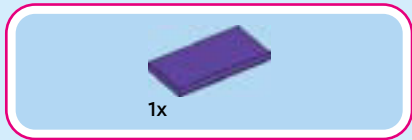

4

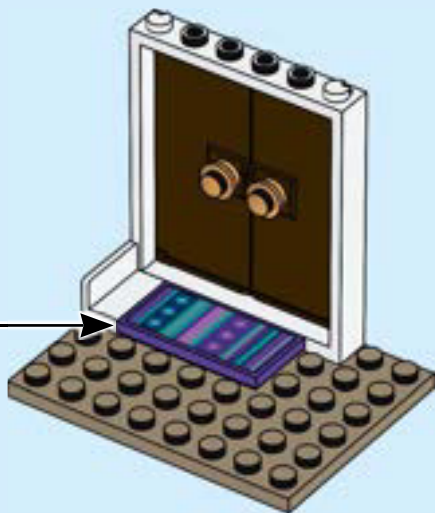
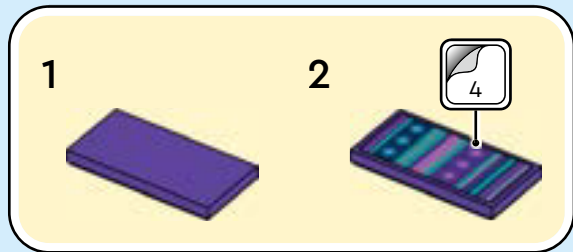

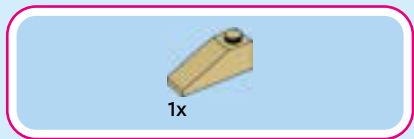

5

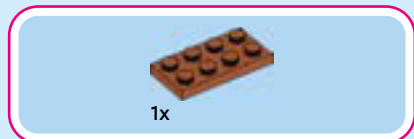
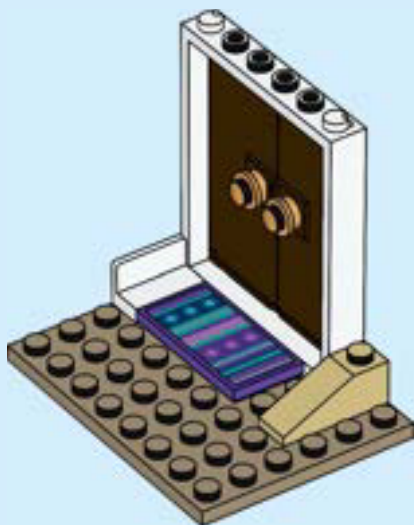

6

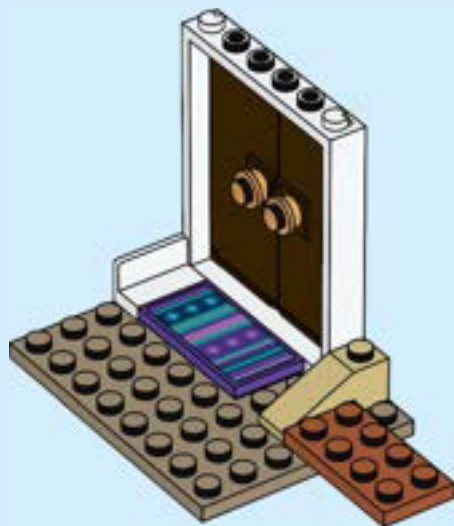



7

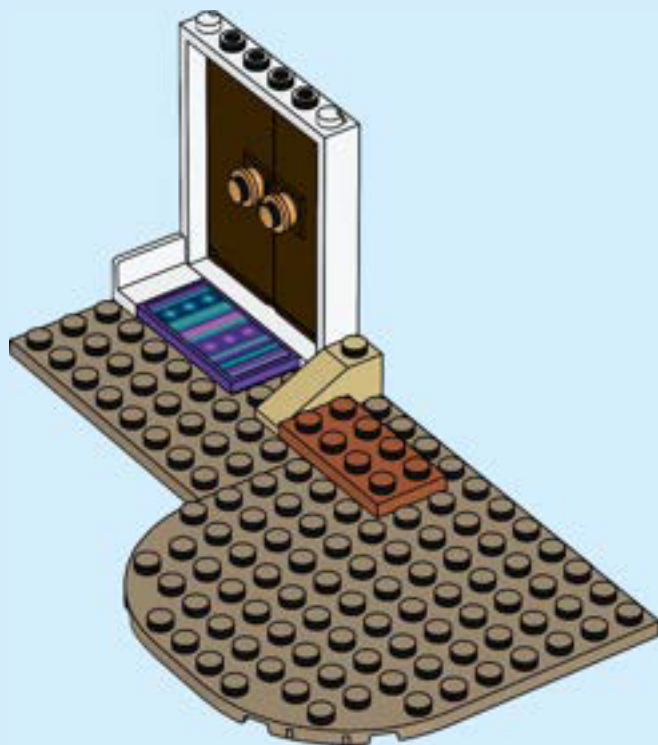



1x

8

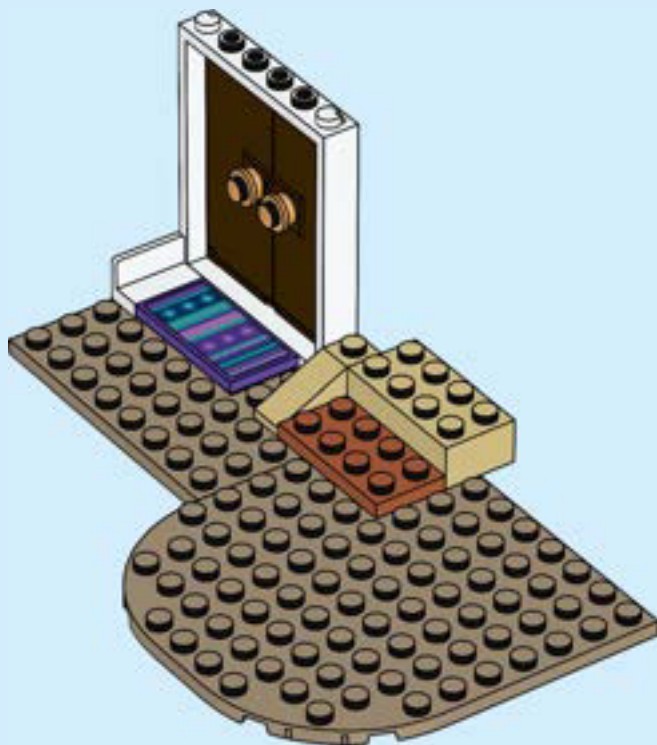



1x

9

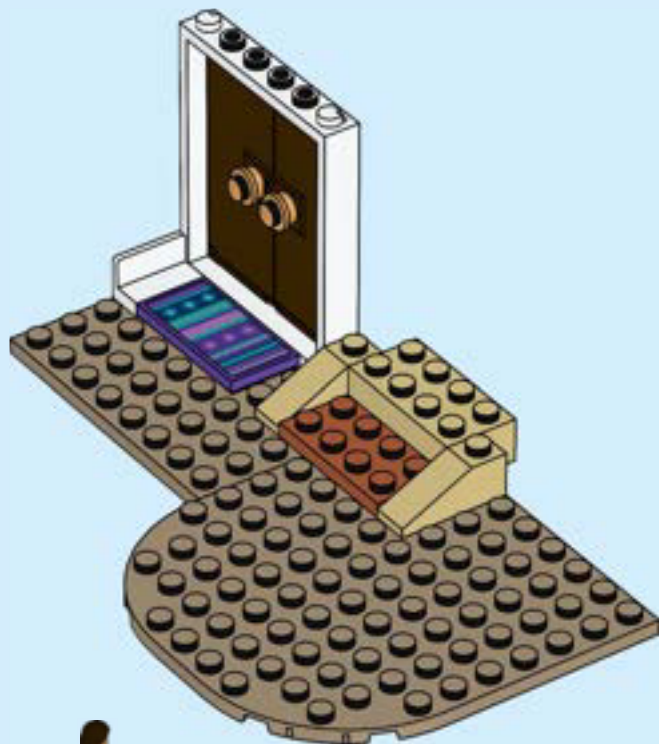



10

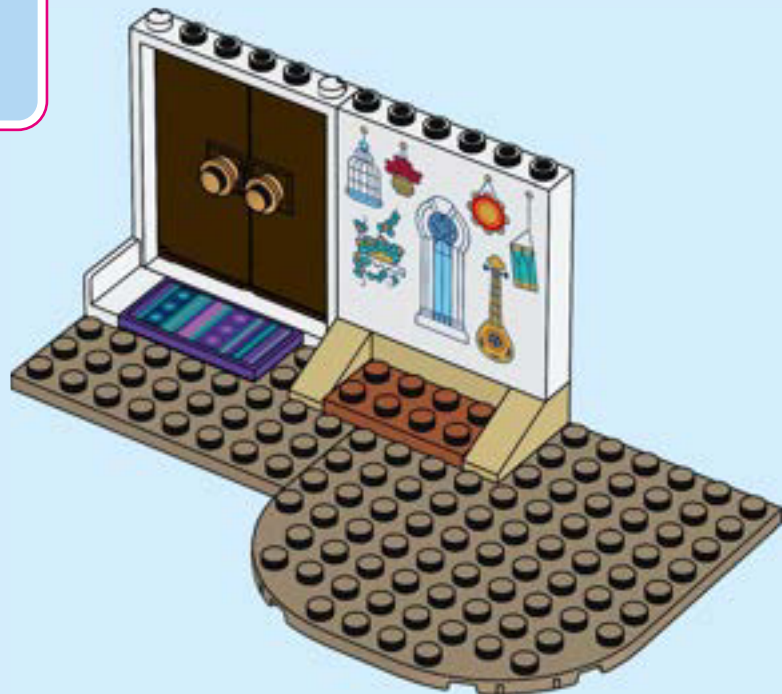



2x

11

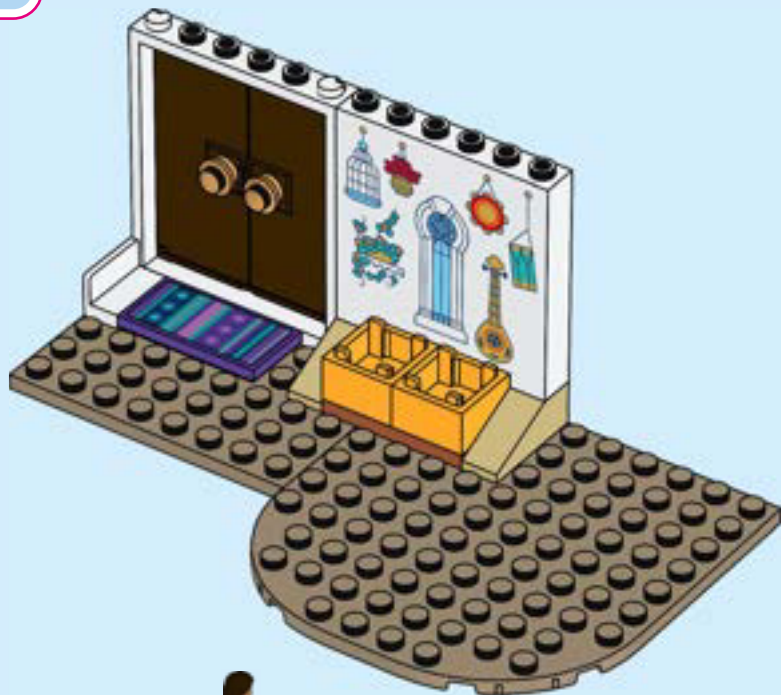



12

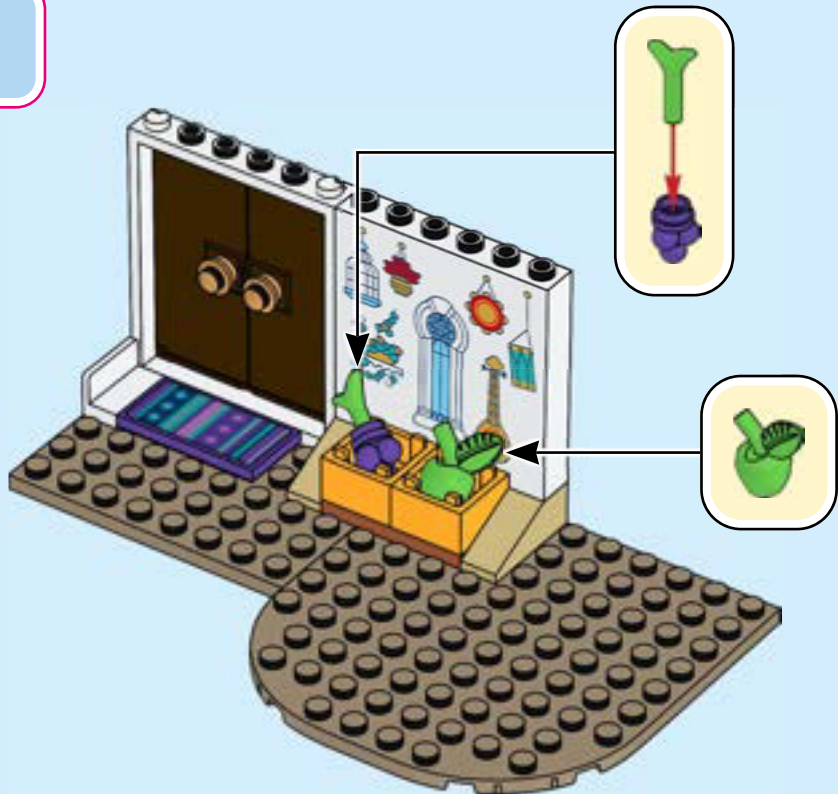

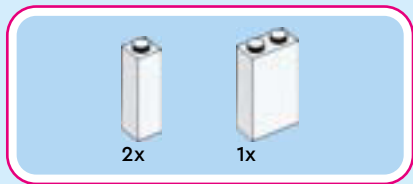

13

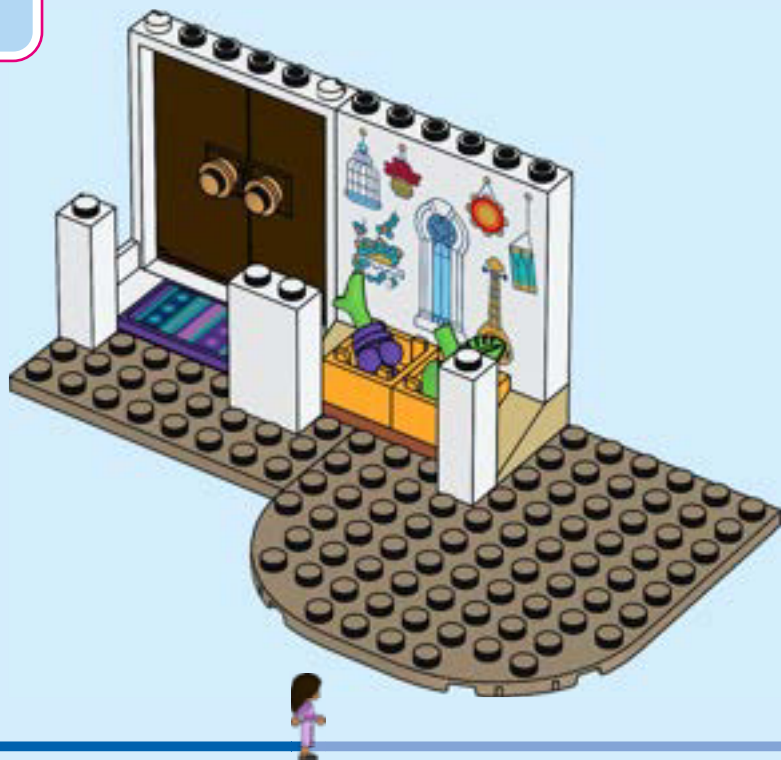



1x



2x

14

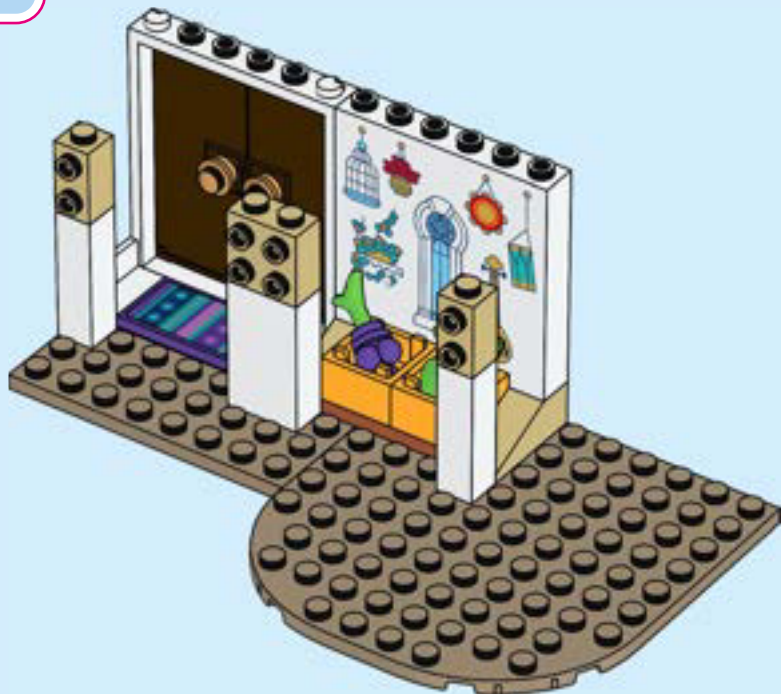



2x



1x

15

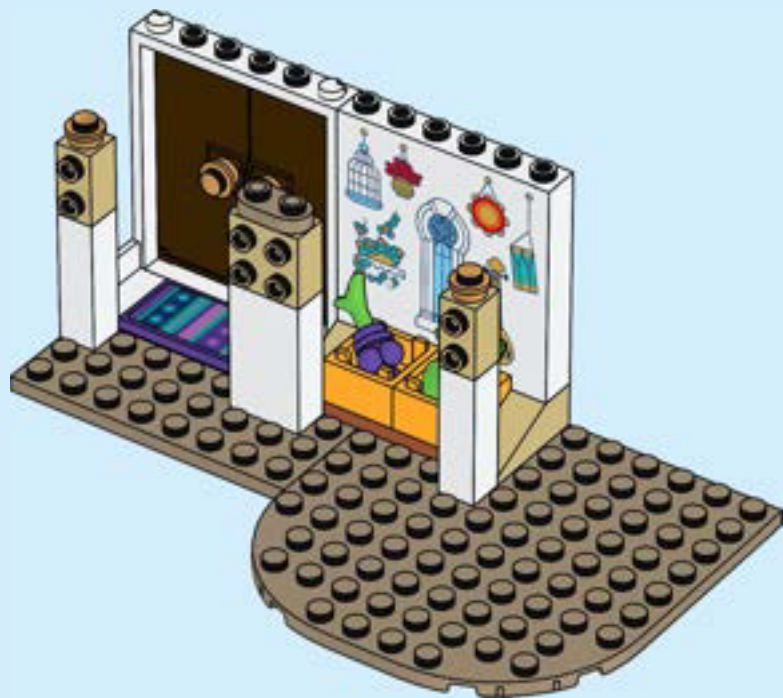



2x

16

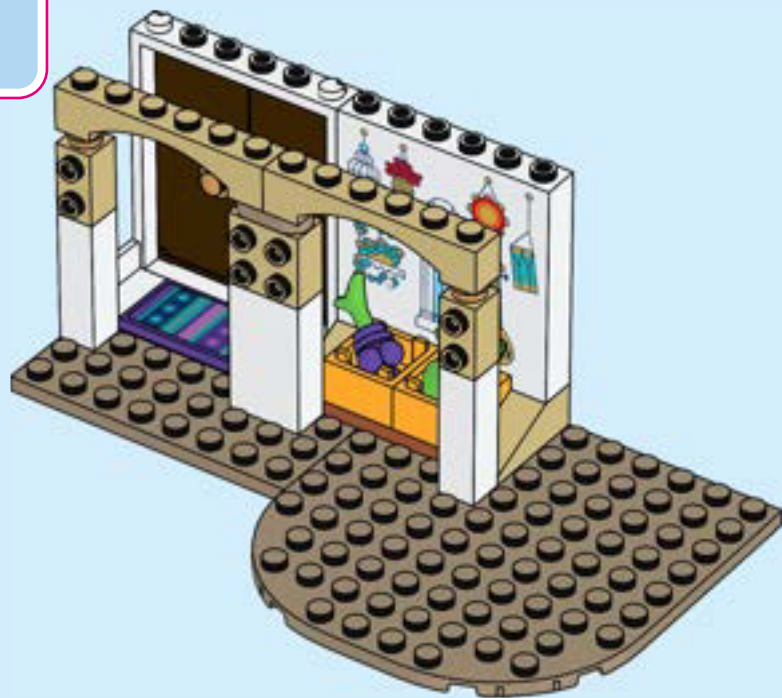



1x

17

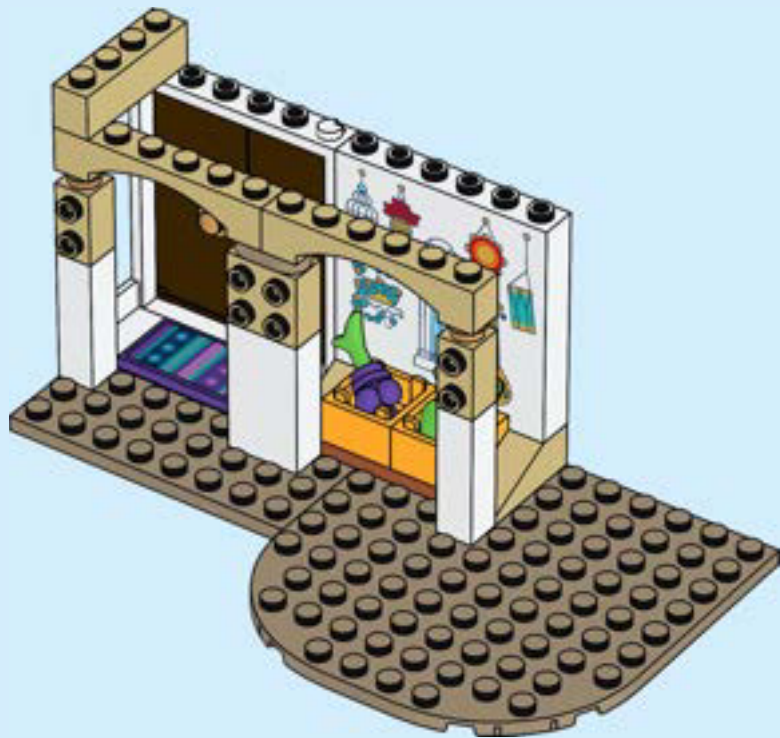



2x

18

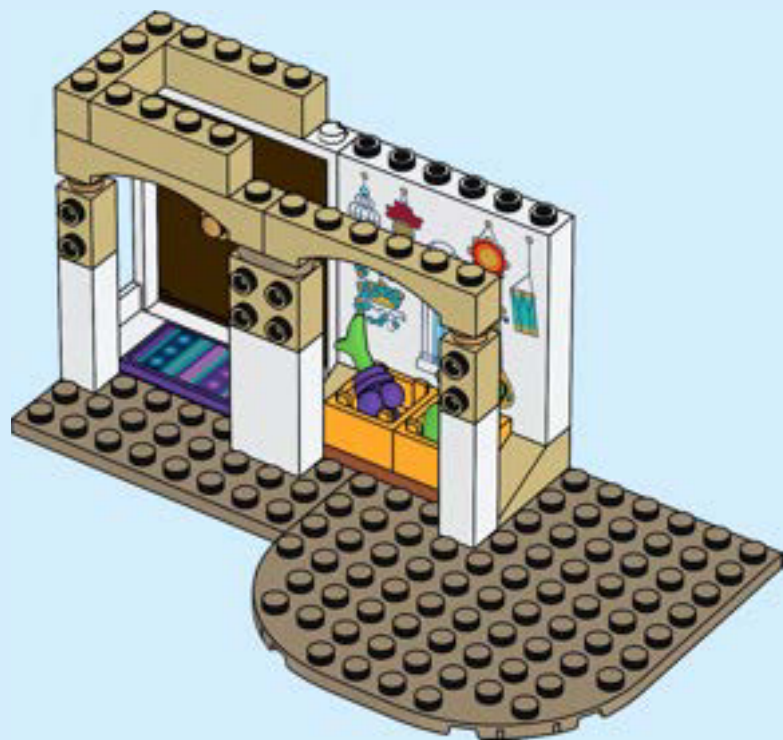



1x

19

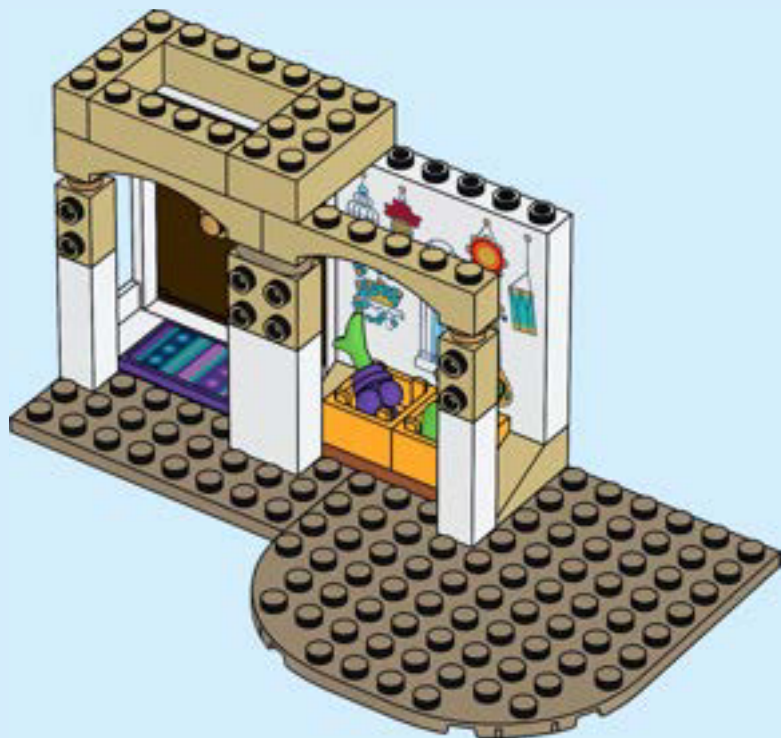



2x

20

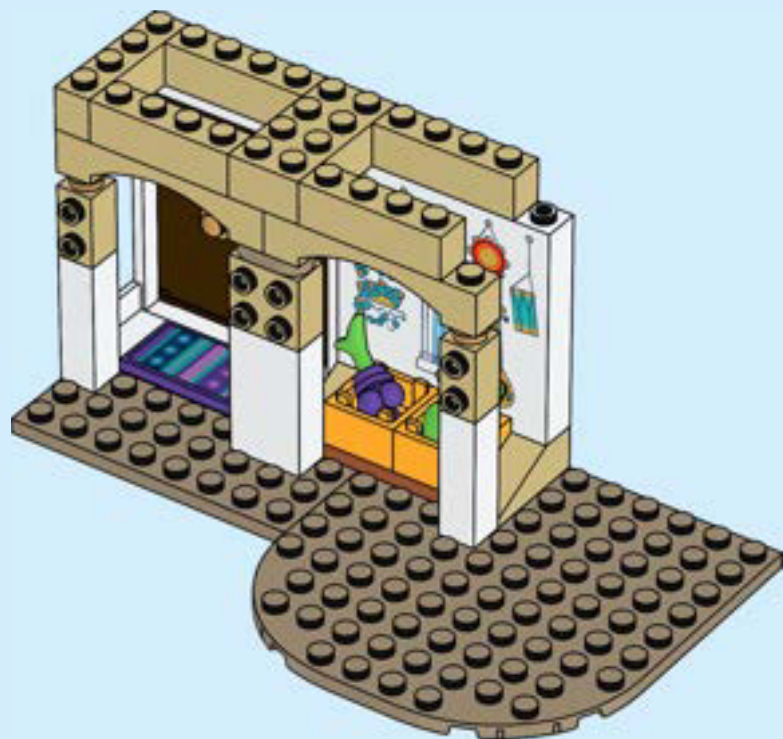

21

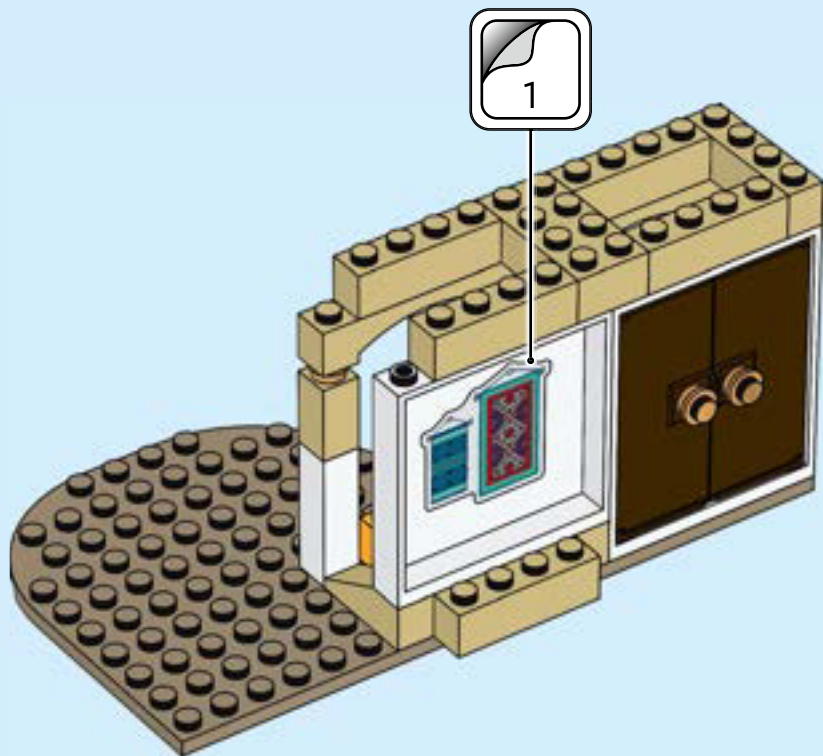
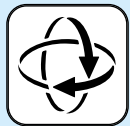



22

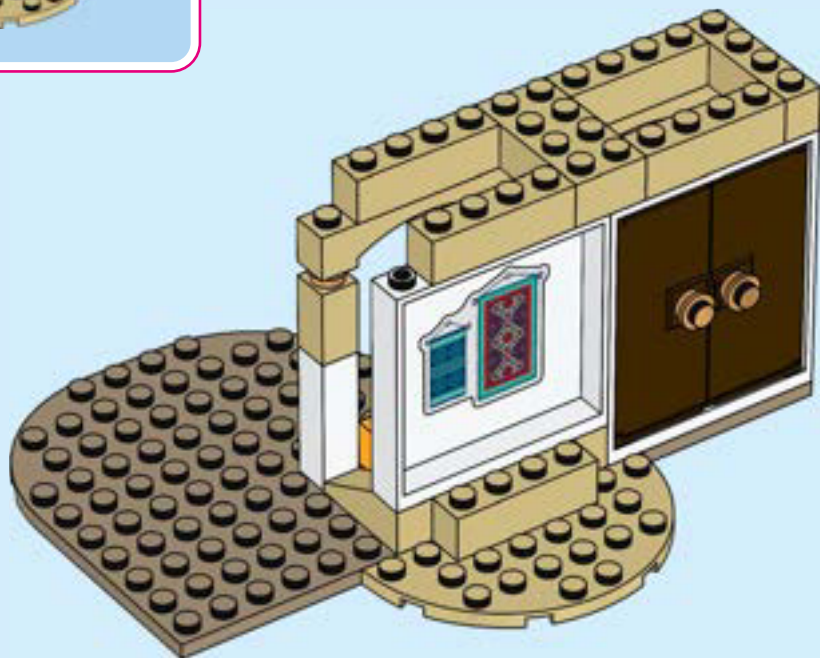



2x



1x

23

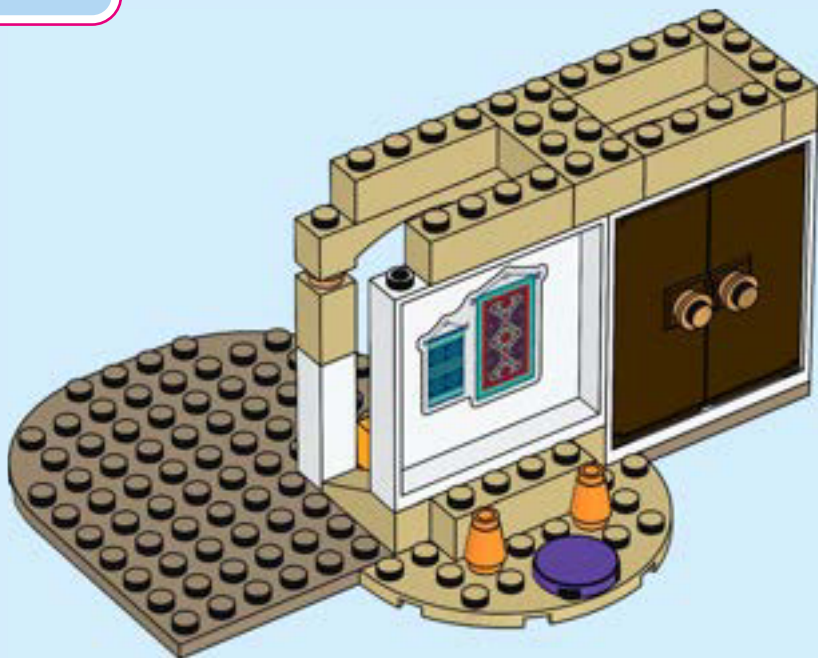

24

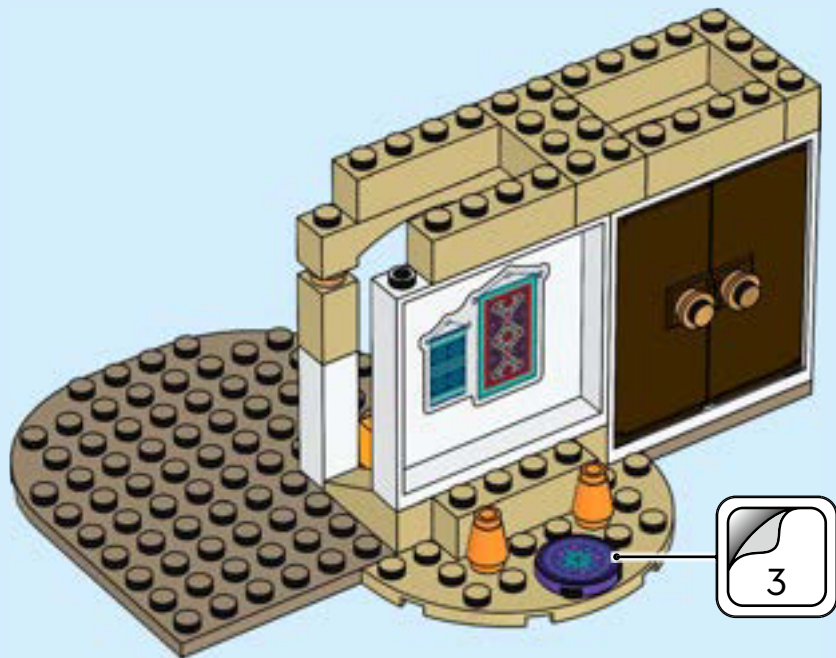



1x

25

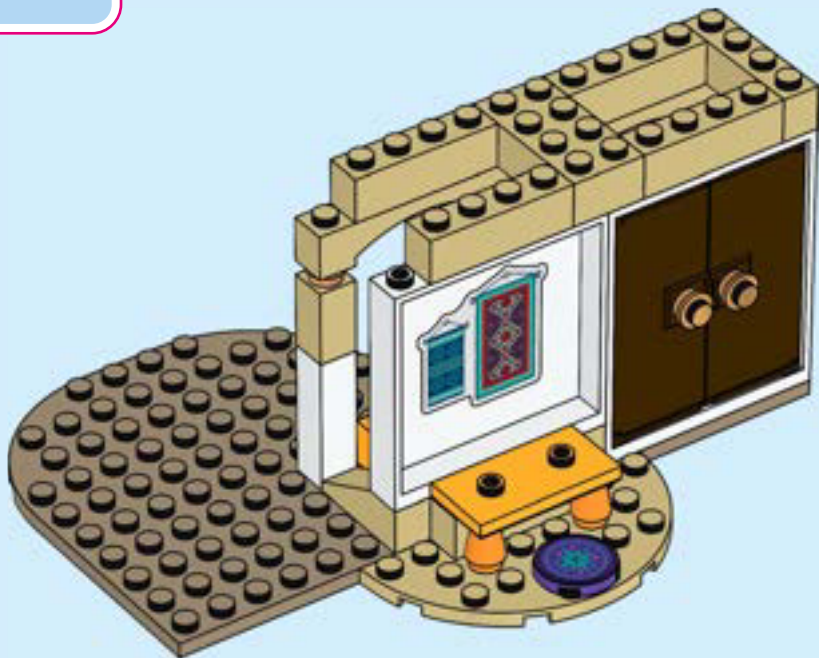



1x



1x



1x

26



1



2





1x

27





1x

28





1x



1x

29

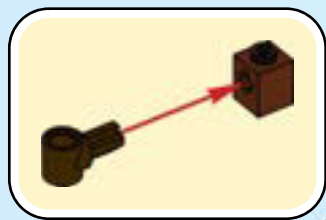



1x

30





1x

31





2x

32





1x

33

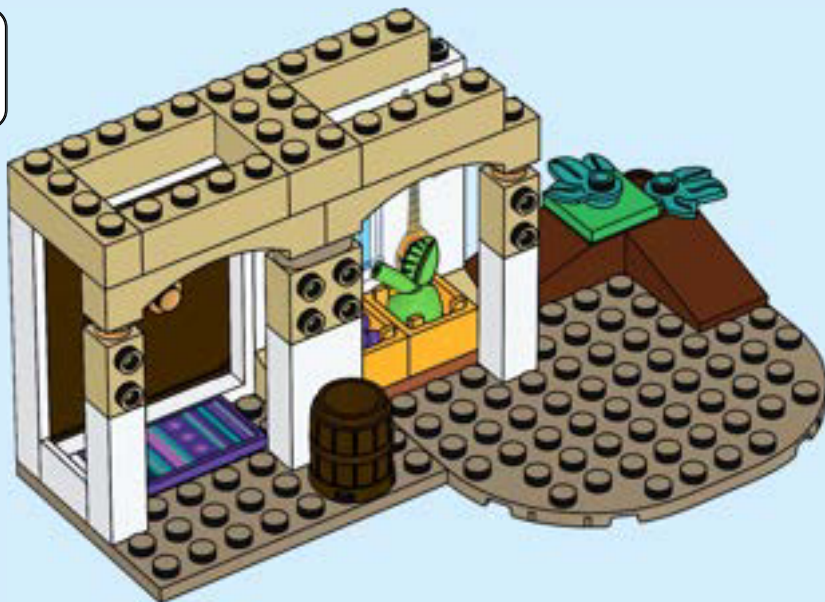



1x



1x

34

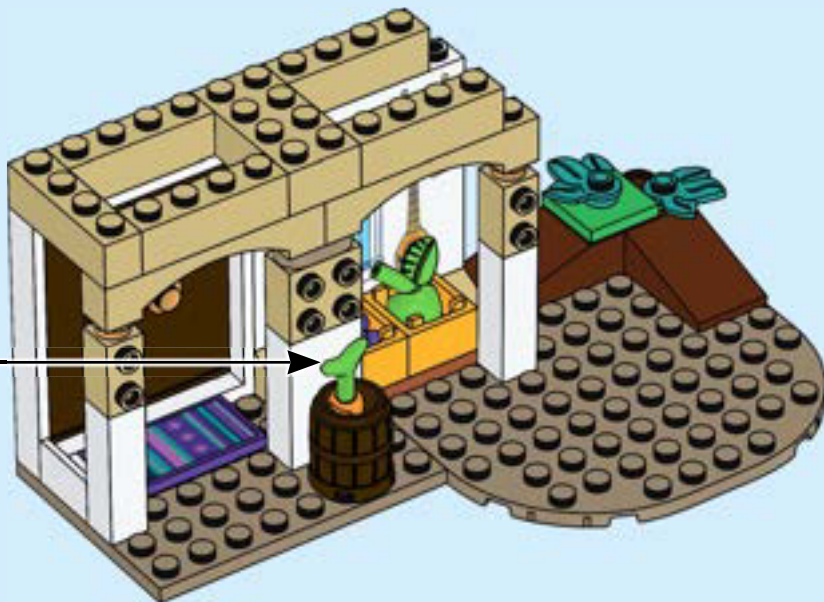
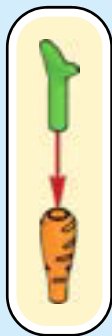





1x

35

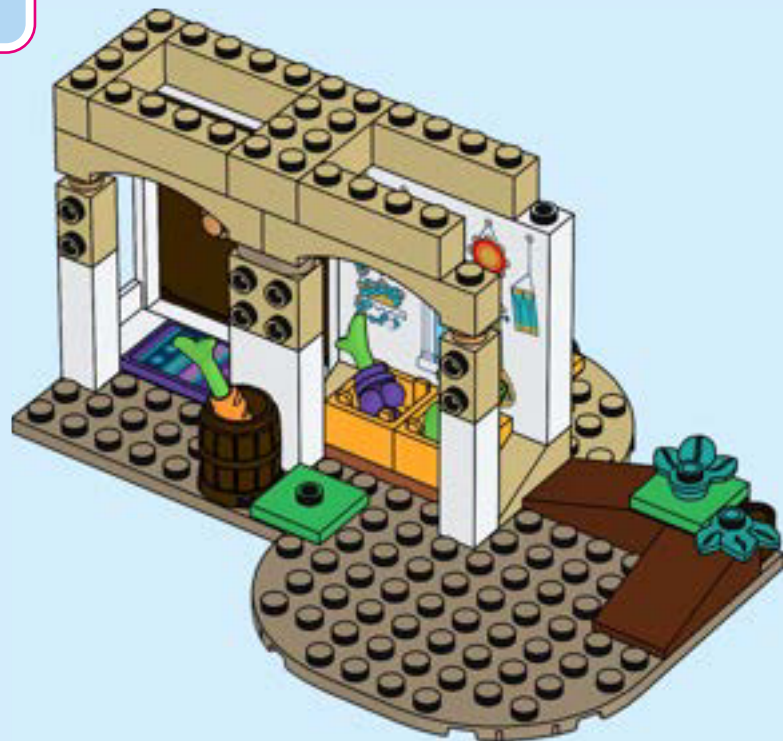



1x

36

1



2



5

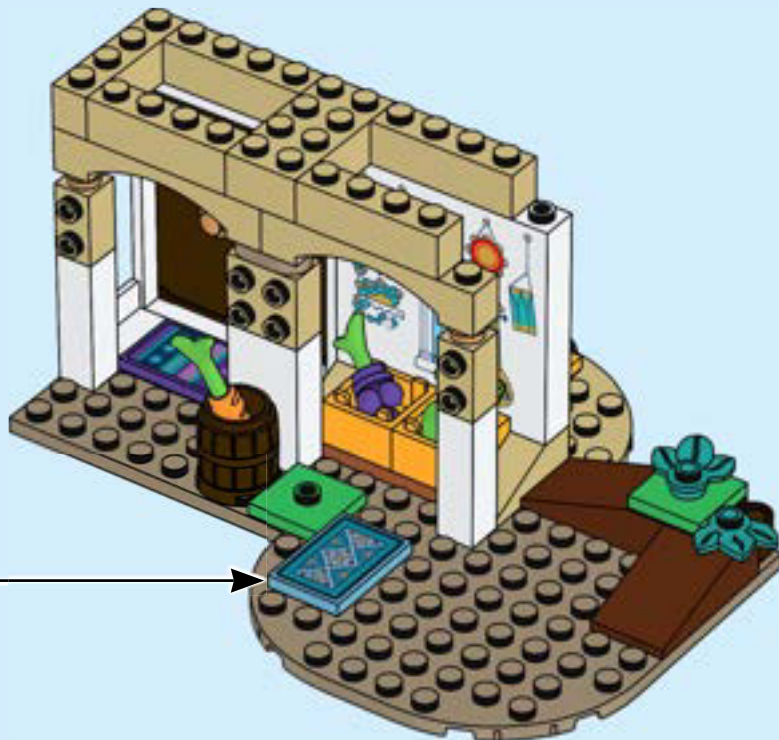



2x

37

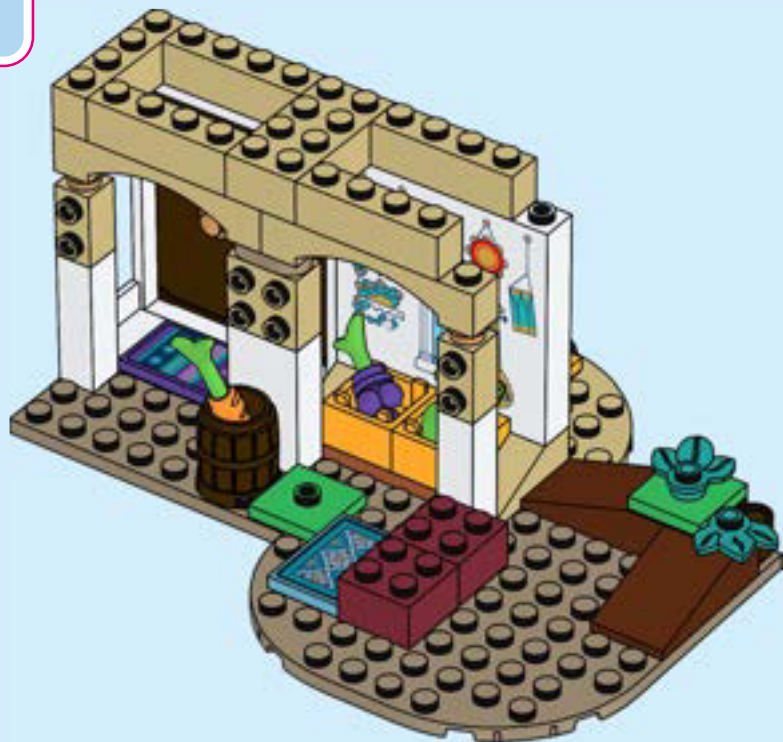



2x



1x

38

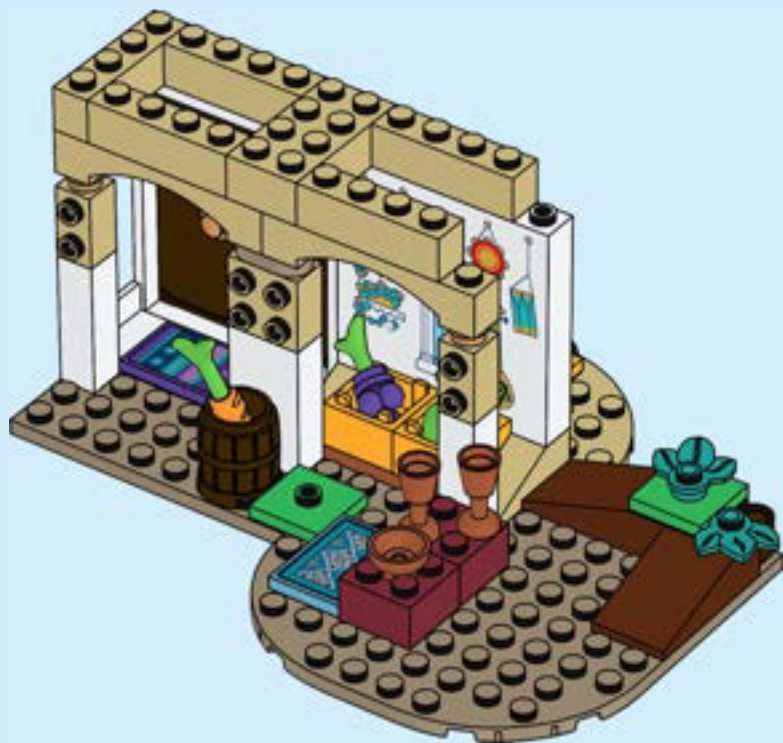

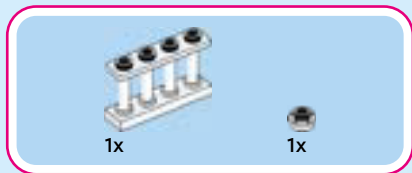

39





1x

40

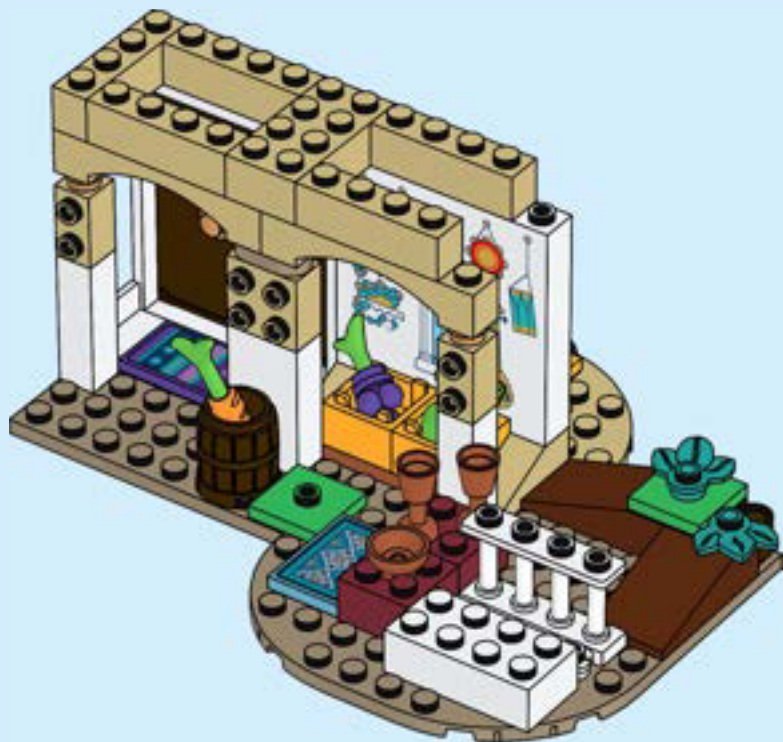



1x

41

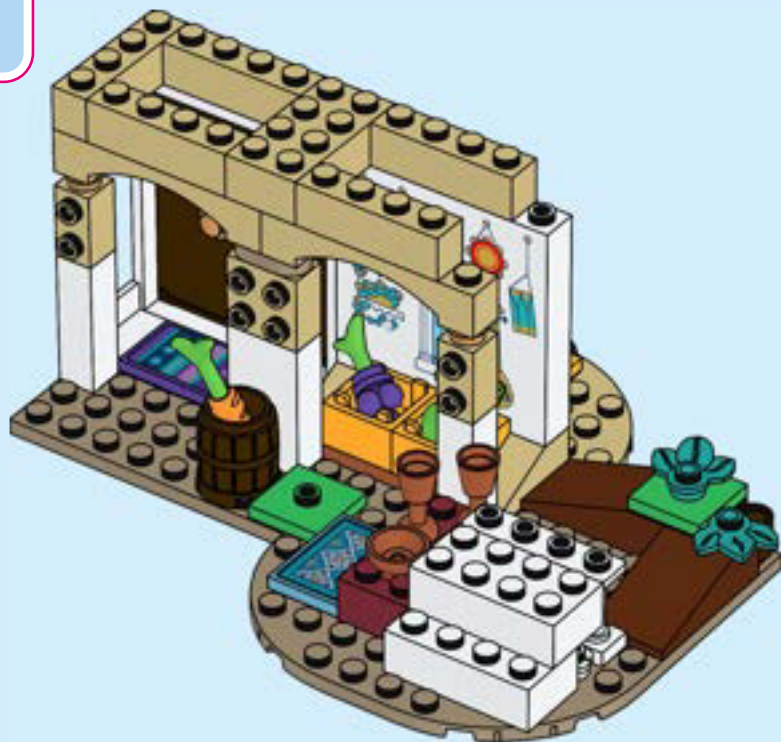



1x

42

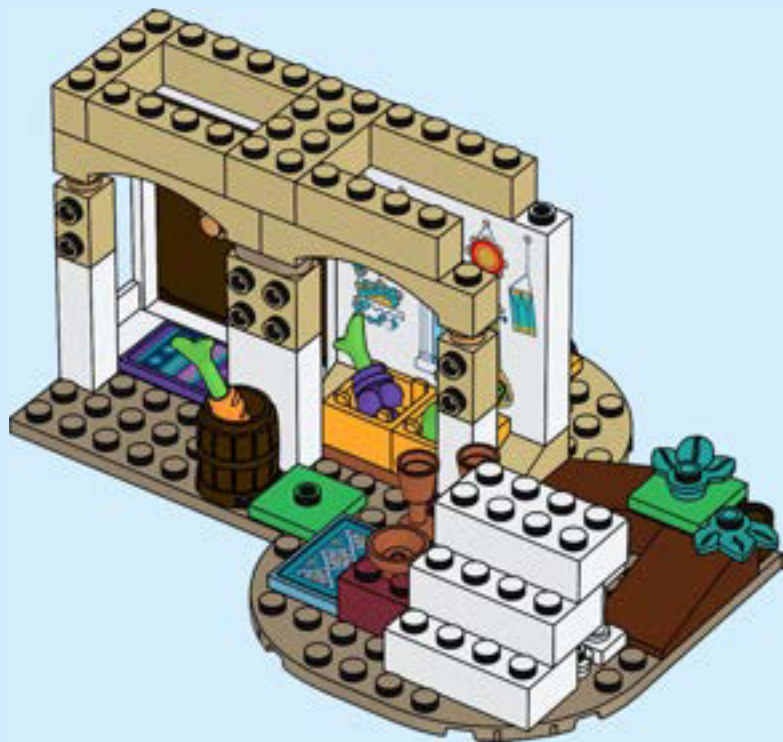



2x

43





44

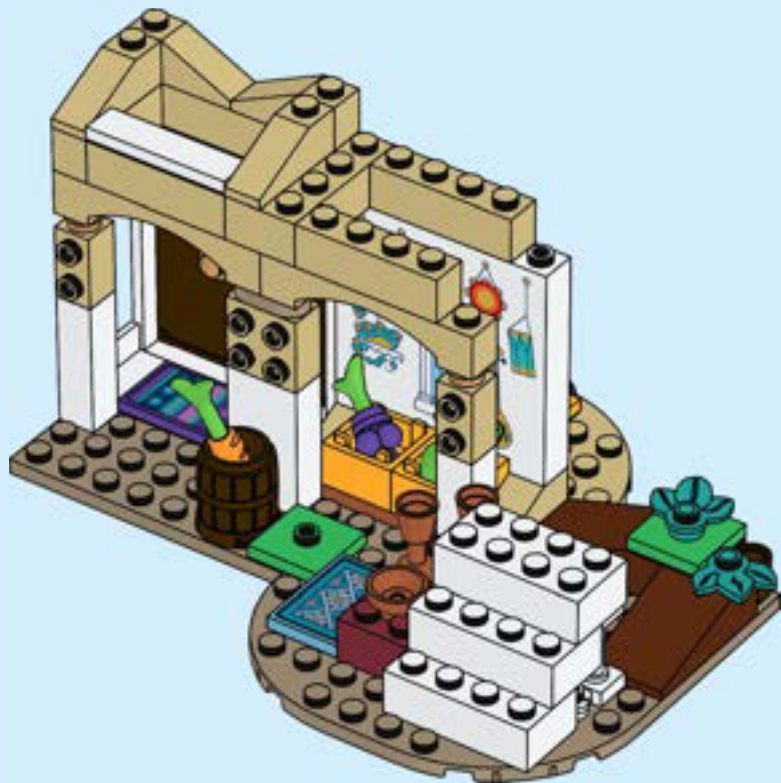

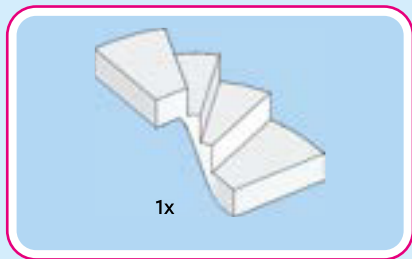

45

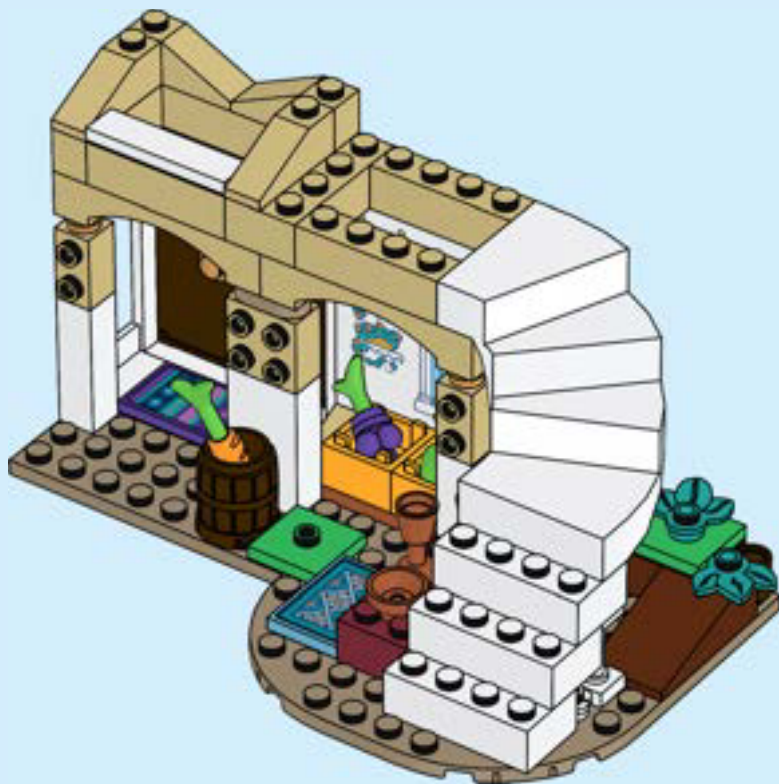



46

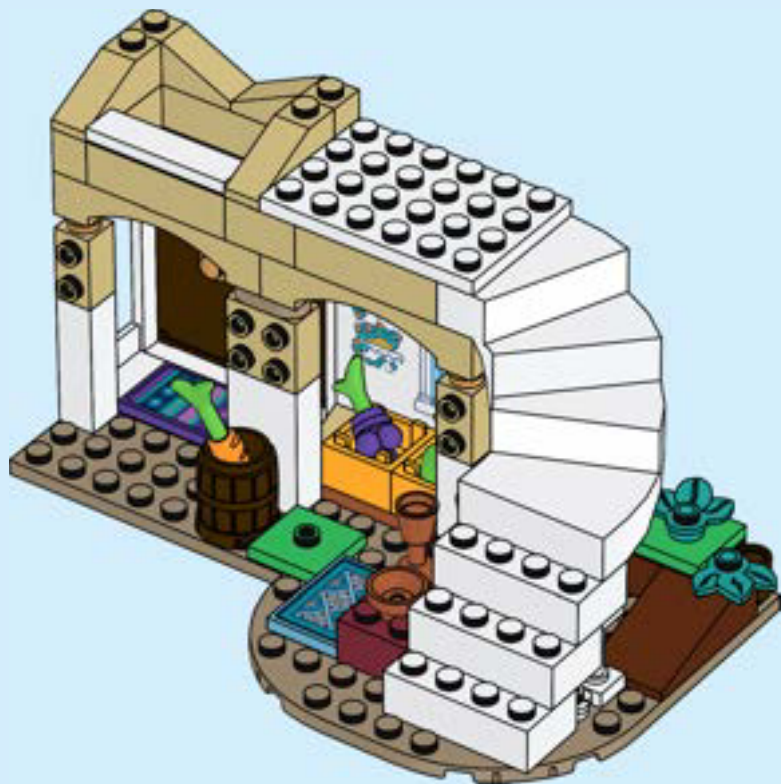



1x



1x

47

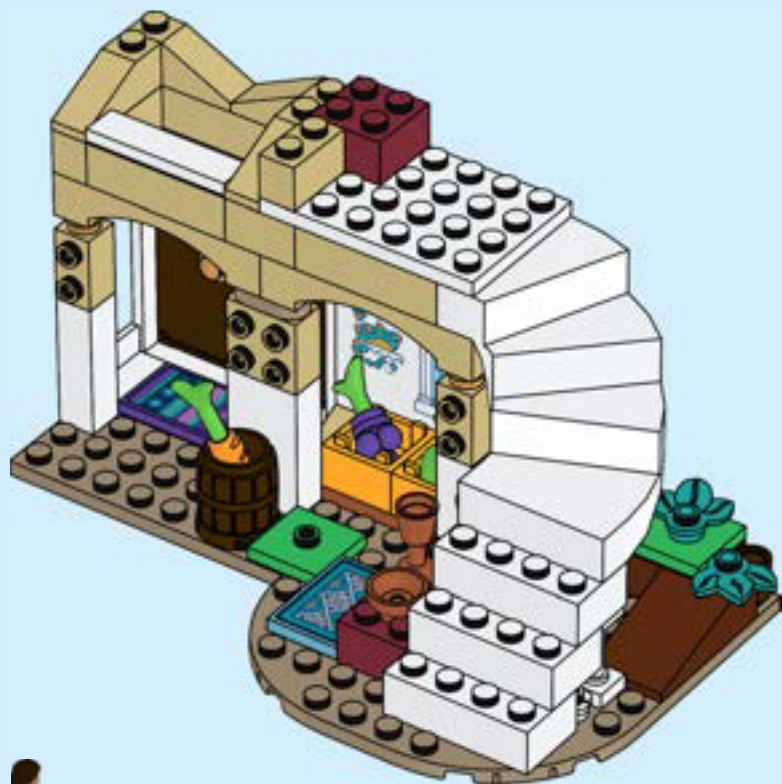



1x

48

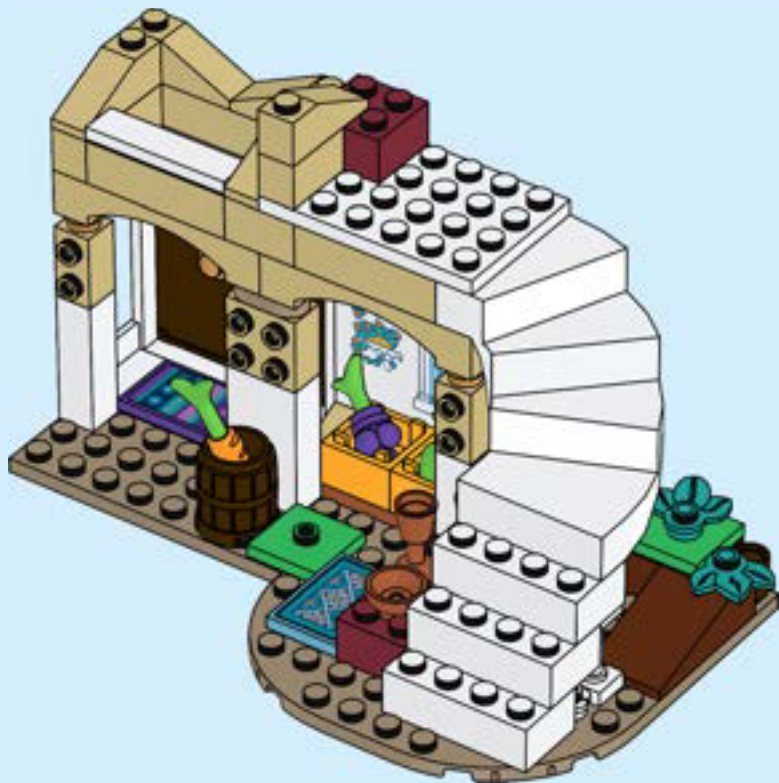

3x

49

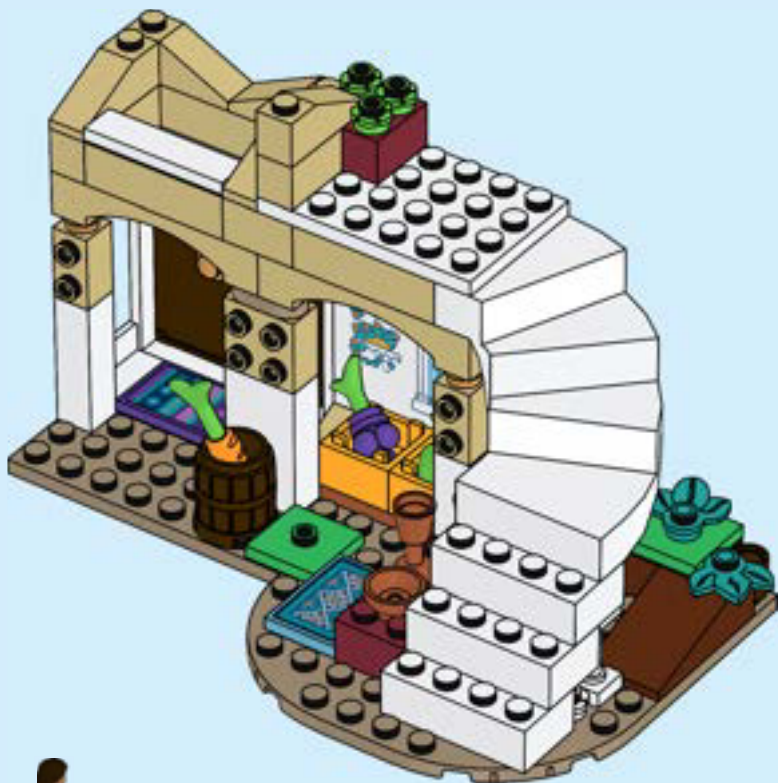



3x

50

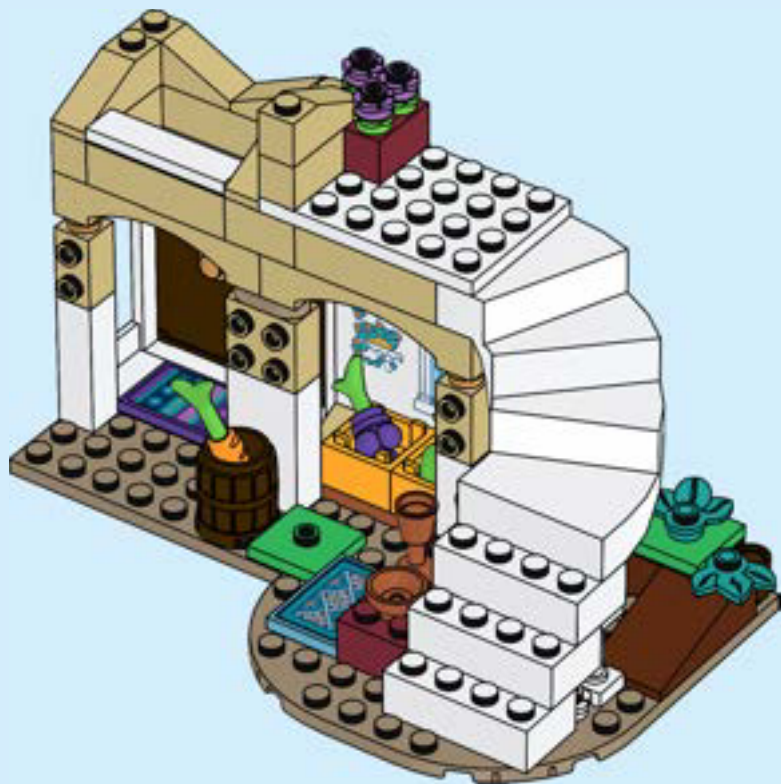

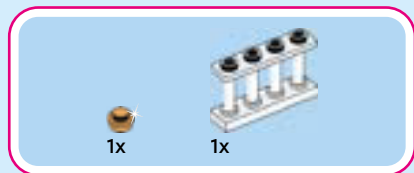

51

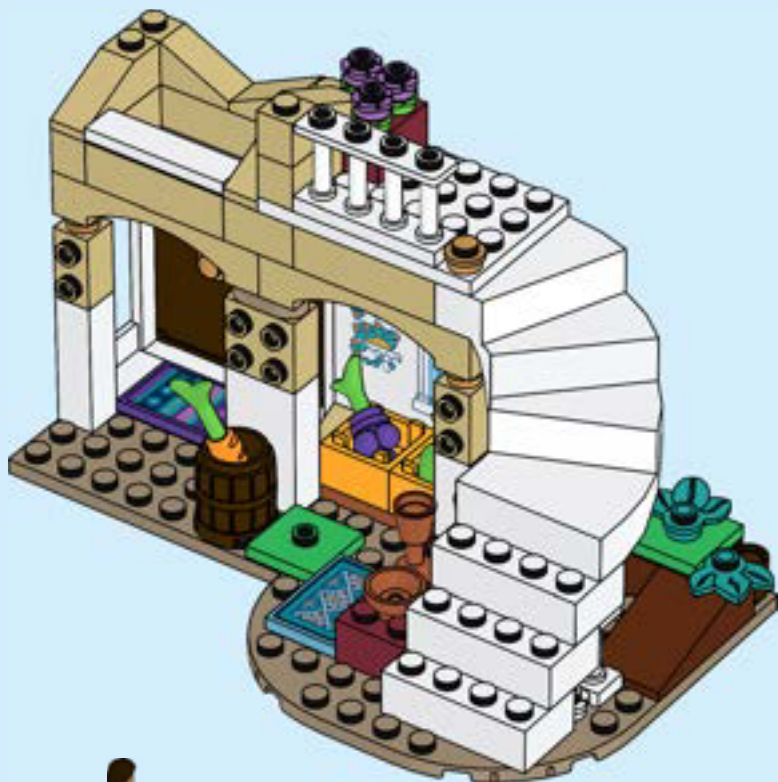



1x

52

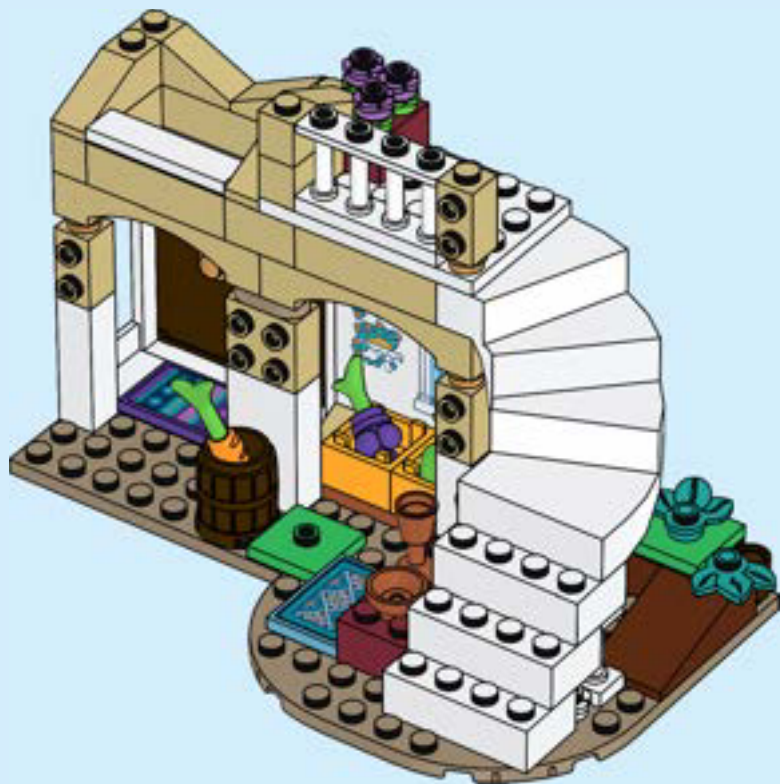



1x



1x

53

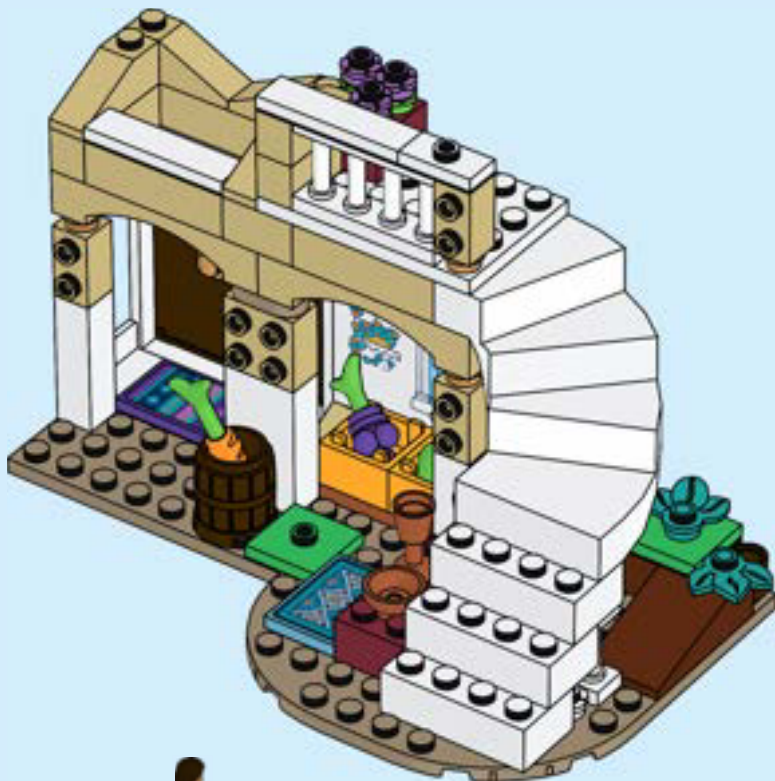



1x



1x

54

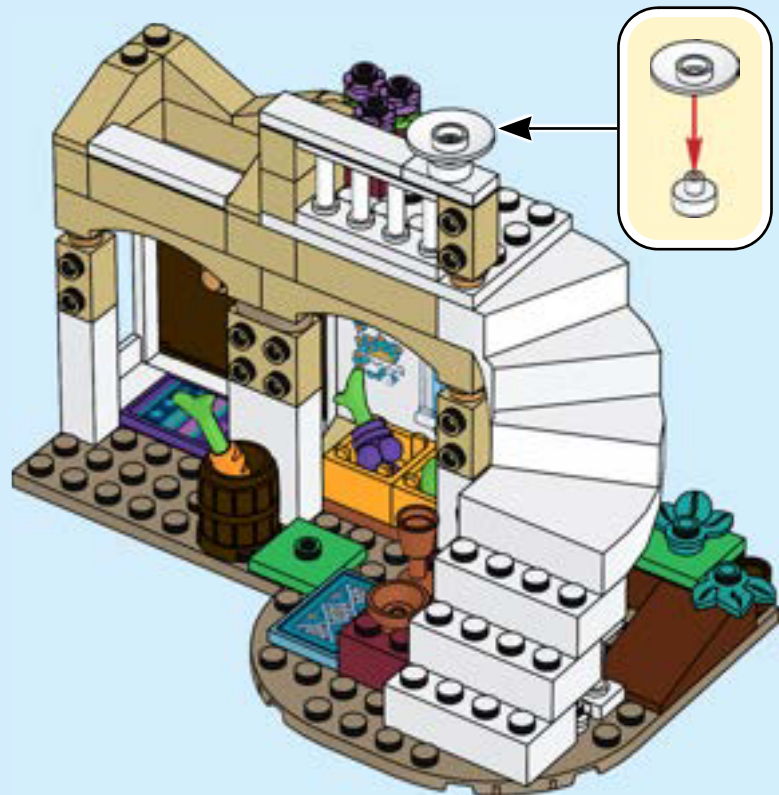



1x

55

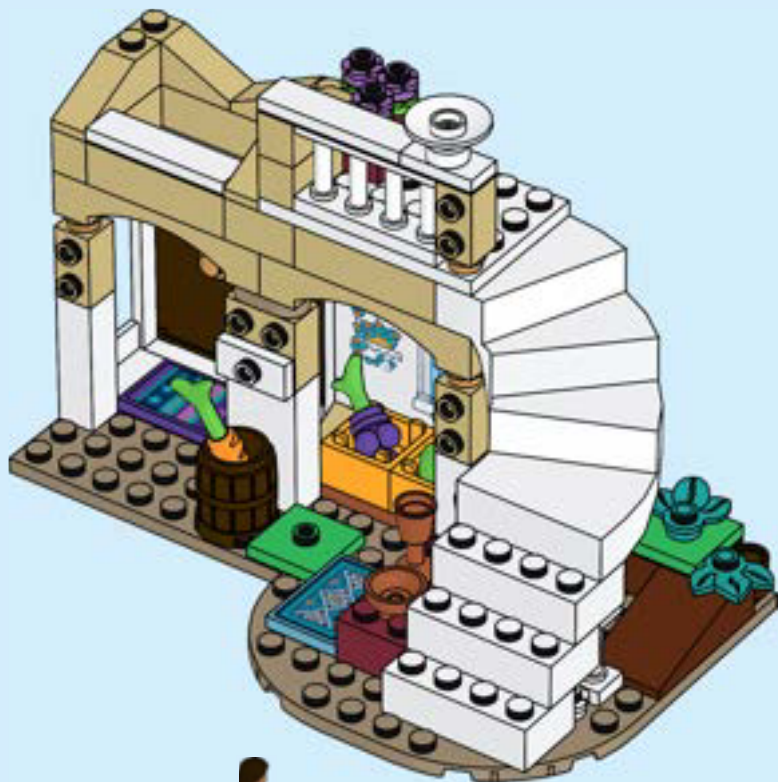



4x

56

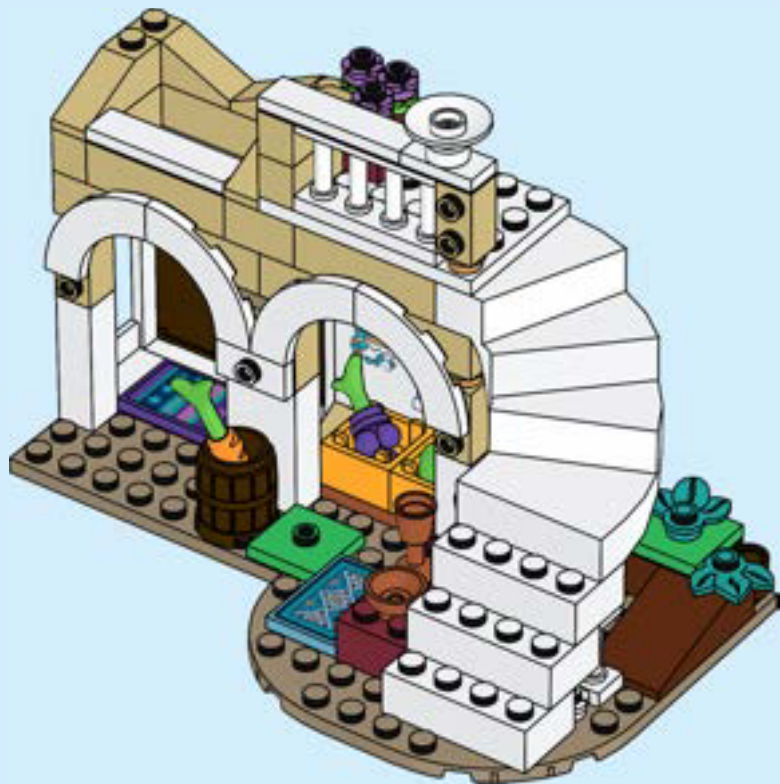



3x

57





2x

58

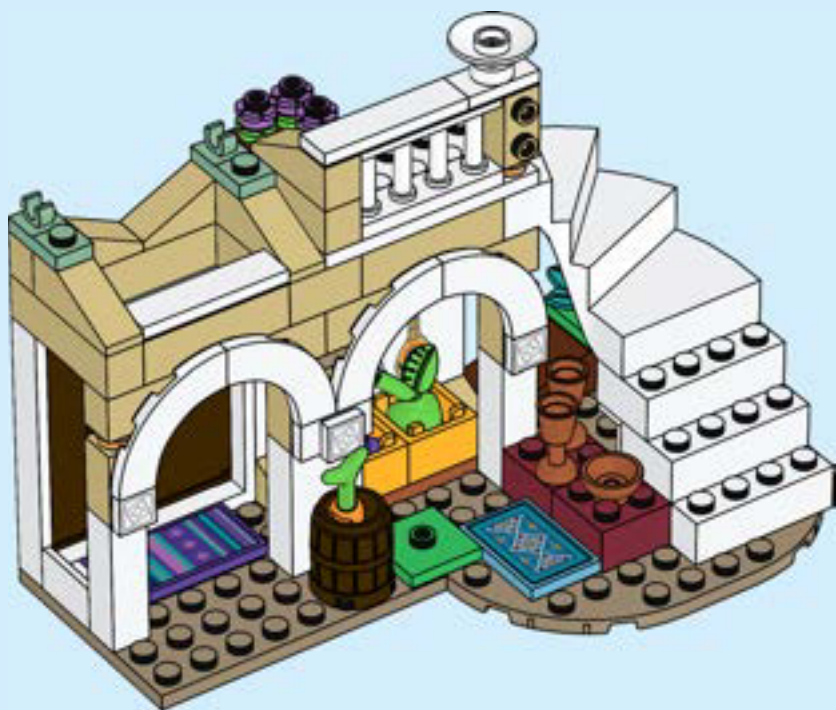

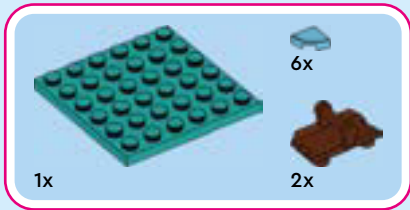

59

1



2

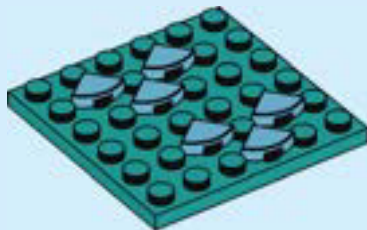

3

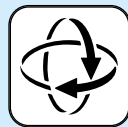

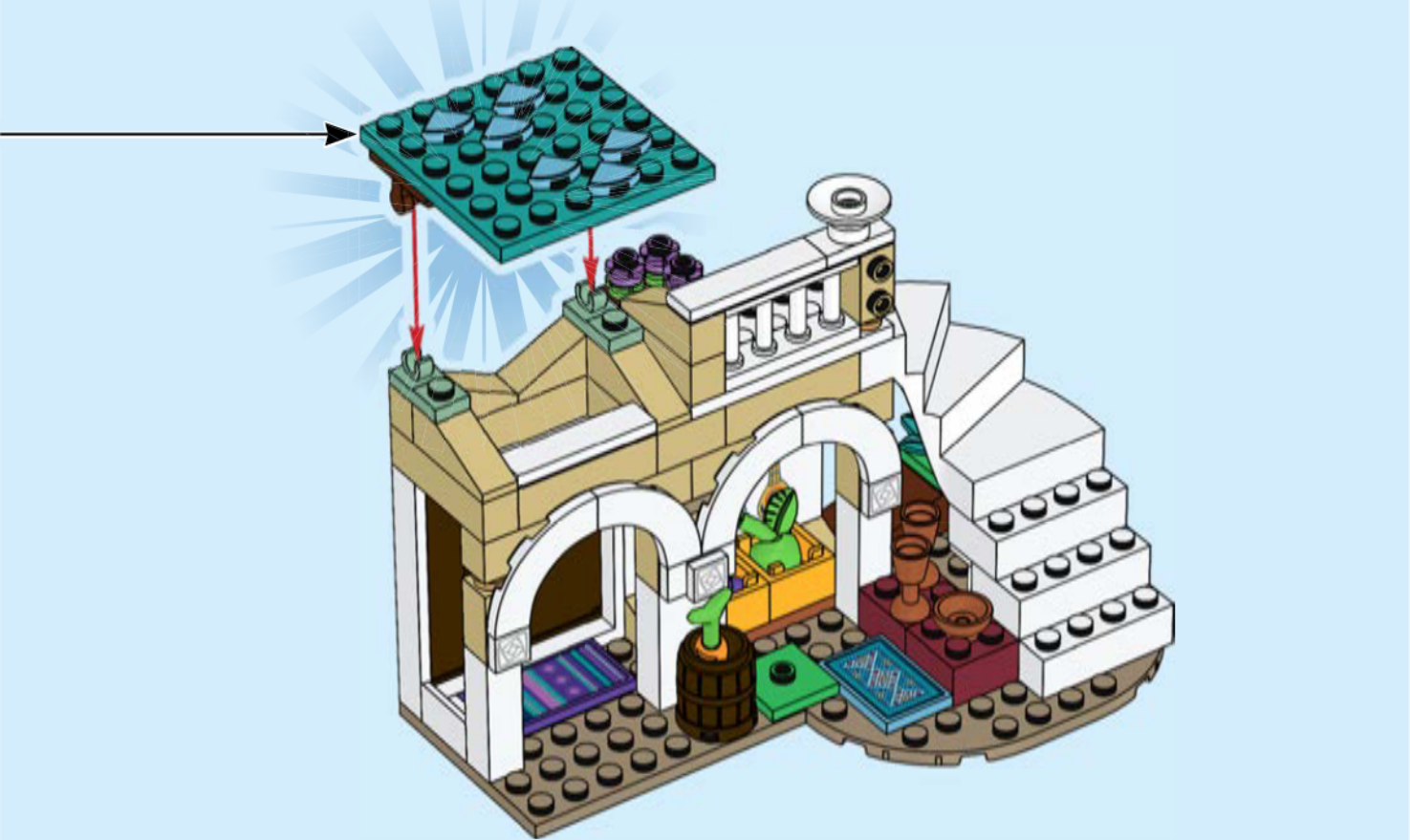

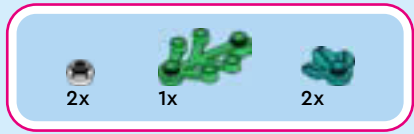

60



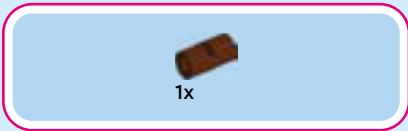

61

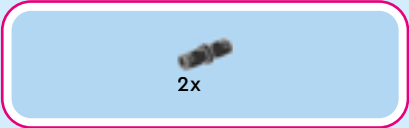

62

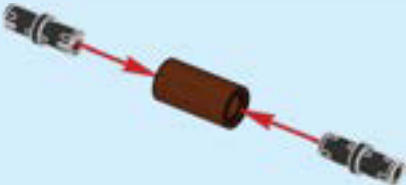



1x



1x

63



1x

64



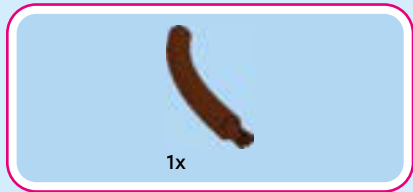

1x

65

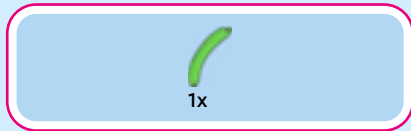

1x

66



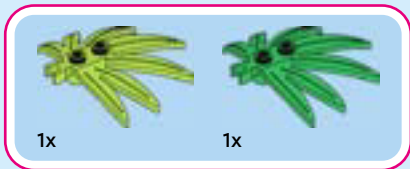

67





1x

68



69





1x



1x

70

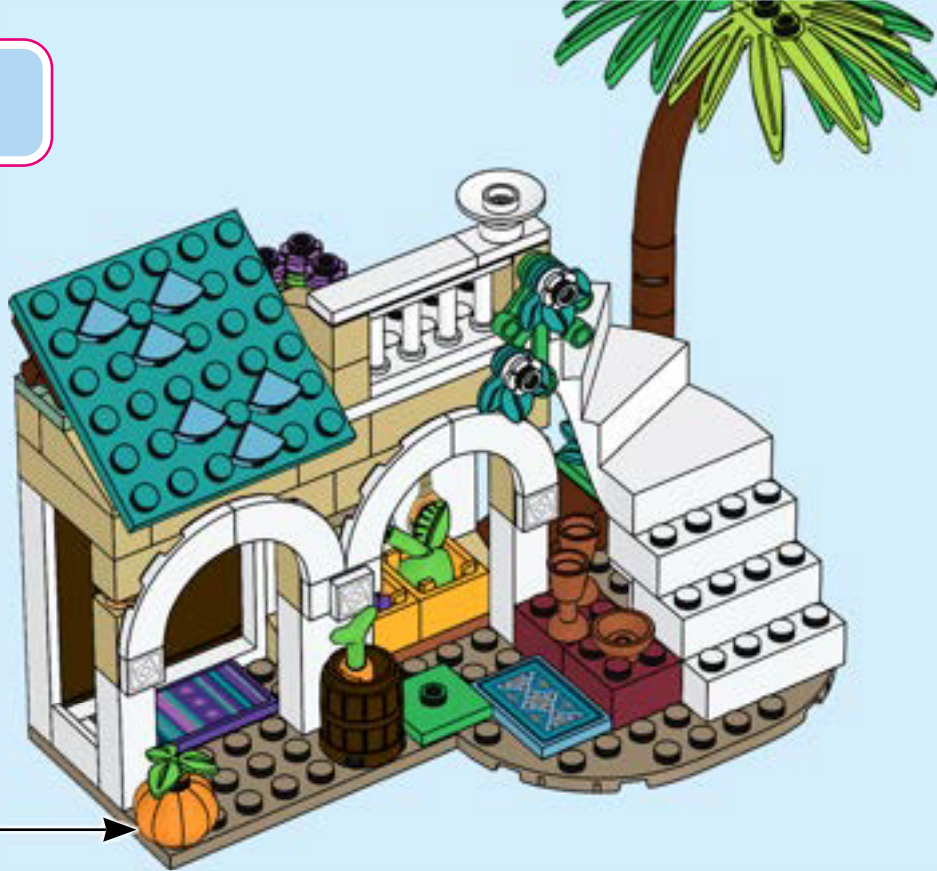

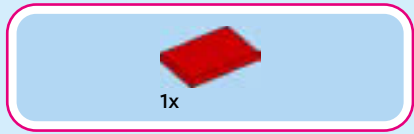

71

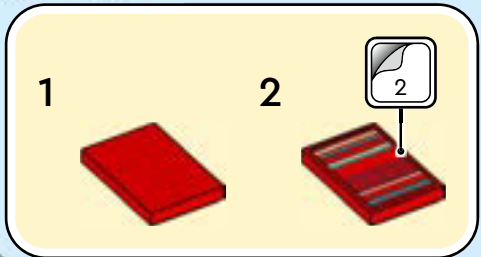
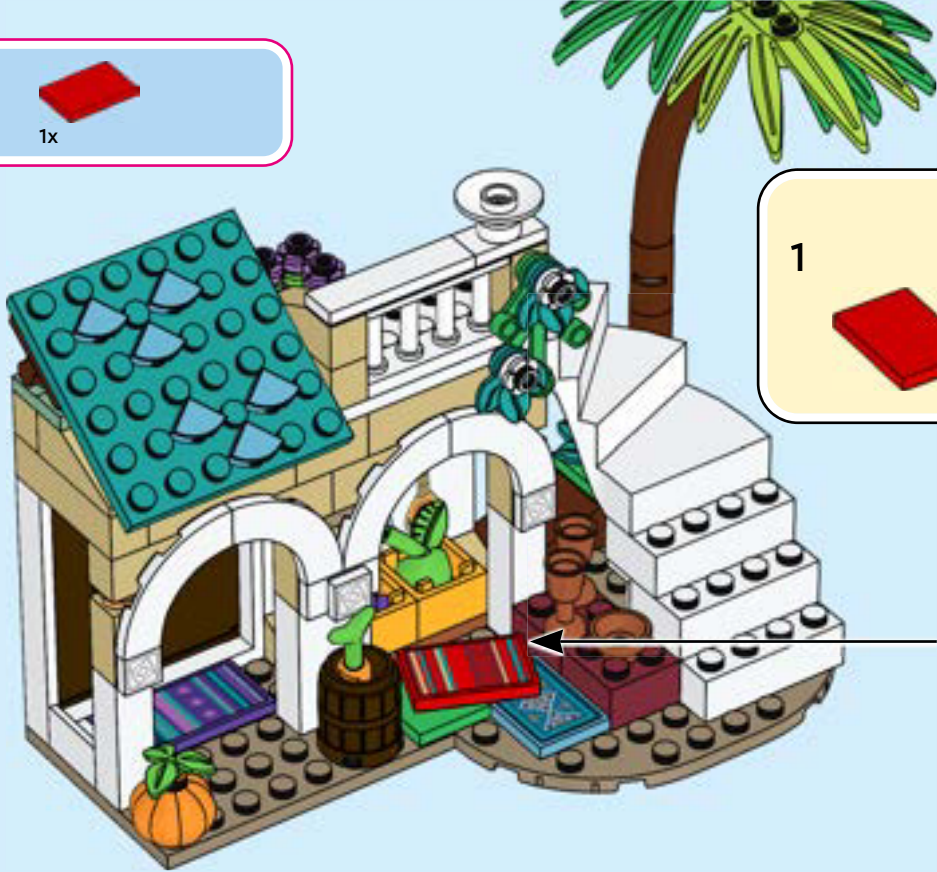



1x



1x

72







3x
6206149



1x
6186681



3x
6455001



1x
6235083



1x
474001



2x
6051511



2x
6055541



1x
6153776

82



1x
6146215



2x
243101



4x
6373439



2x
6047813



3x
300101

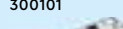

1x
6256127



1x
6464391



1x
303201



1x
6458979



3x
6232135



2x
4666579



1x
6214334



1x
4109995



7x
6058090



1x
6116614



5x
4113916



2x
4114319



2x
4618876



1x
6123812



1x
6189130



1x
6455021



2x
6223655



1x
6247369



1x
6245306



3x
6206150



1x
6430093



1x
6413063



1x
6235080



2x
4119479



2x
6389692



1x
6268814



2x
6313099



1x
6420470



2x
6420468



1x
4535928



1x
6247364



2x
4518029



1x
6267125



1x
6424015



4x
6270179



1x
6251830

3x
6279875



1x
6194233



1x
6313098



2x
6231386



1x
6365489



1x
4251796



1x
6463586

1x
6060731



1x
6397610



1x
6035291



3x
6173132



1x
6313124



1x
6327818



1x
6326087



2x
6328480



2x
4225869



2x
6385882



7x
4523159



1x
6424008



1x
6278447



1x
6097501



1x
6167472



2x
6439231



1x
6369683



1x
6455310



1x
6134197



1x
6278987



2x
6452420



1x
6454983



1x
6460972



1x
6455038



6x
6150307



1x
6233166



2x
6360075



3x
4539104



3x
6209684



1x
6461097



1x
6344844



1x
6460299



[LEGO.com/service](https://www.lego.com/service)



YOU COULD **WIN**



Scan this QR code or go to **LEGO.COM/PRODUCTFEEDBACK** and give us your short feedback about this LEGO® set for a chance to win a cool LEGO prize.

Terms and Conditions apply*

EN: YOU COULD WIN. Terms and Conditions apply* **DE: Du könntest GEWINNEN.** Es gelten die Teilnahmebedingungen* **FR: Tu pourrais GAGNER.** Des conditions s'appliquent* **IT: Potresti VINCERE tu.** Termini e condizioni sono applicabili* **ES: Puedes GANAR.** Aplican términos y condiciones* **PT: Poderá GANHAR.** Aplicam-se termos e condições* **ZH: 轻松获奖. 条款和条件适用*** **PL: Szansa na WYGRANĄ.** Obowiązują warunki korzystania* **CS: Máte šanci VYHRÁT.** Platí všeobecné smluvní podmínky* **SK: Máte šancu VYHRAŤ.** Platia všeobecné zmluvné podmienky* **HU: TE IS NYERHETSZ.** Felhasználási feltételek érvényesek* **RO: Ai putea CÂȘTIGA.** Se aplică termenii și condiții* **BG: Можете да СПЕЧЕЛИТЕ.** Има определени правила и условия* **LV: Tu vari LAIMĒT.** Ir spēkā noteikumi un nosacījumi.* **ET: Sul on võimalus VÕITA.** Kehtivad tingimused* **LT: Jūs galite LAIMĖTI.** Taikomos sąlygos*

*[LEGO.com/productfeedback/terms](https://www.lego.com/productfeedback/terms)