





ARID PLANTS

▣ Arid or desert plants are some of the toughest species you will find. They have evolved to survive in climate zones with harsh winds, intense heat and only very sporadic precipitation. They typically store what little moisture they can attract in plump pods and save it for... well, not a rainy day, but long dry spells instead. Radiant flowers help them attract pollinators, giving them an edge over any competition in their surroundings.



(Dudleya brittonii)

BRITTON'S LIVEFOREVER

A succulent native only to Baja California, Mexico.



(Opuntia humifusa)

EASTERN PRICKLY PEAR

A cactus native to large parts of the eastern United States and north-eastern Mexico.



(Mammillaria crinita f. zeilmanniana)

PINCUSHION CACTUS

Native to Mexico, and areas in the south-western United States, the Caribbean and South America.



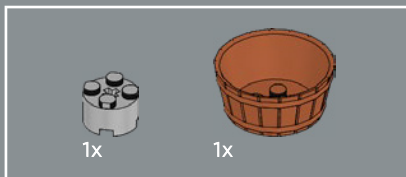

1

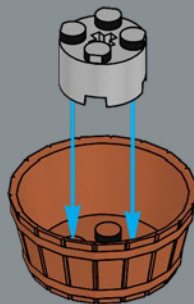



2

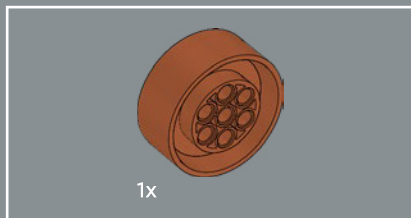
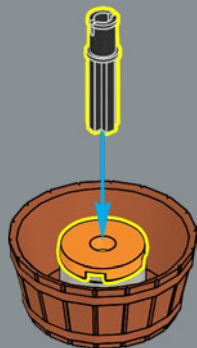

3

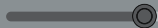
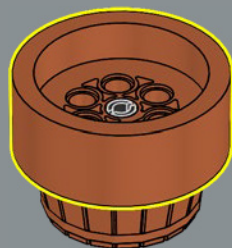



4

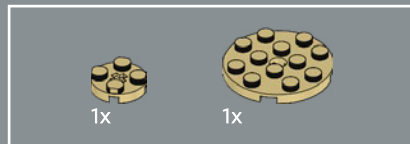
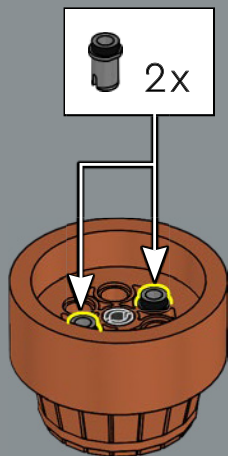

5

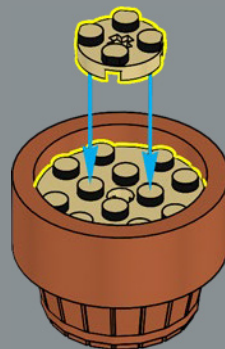

This colourful succulent was named after Nathaniel Lord Britton, an American botanist who first categorised the *Dudleya* genus.



4x

6

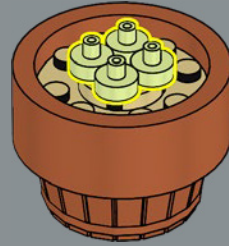

To capture a nice gradient of spiky leaves, we added a new colour for the 1x1 plate with a tooth. So, if you have any LEGO® animals in your house, you could always give them lovely light lavender teeth.



7

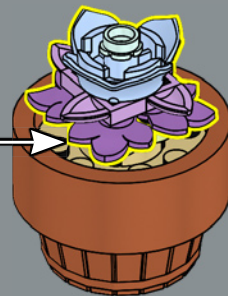
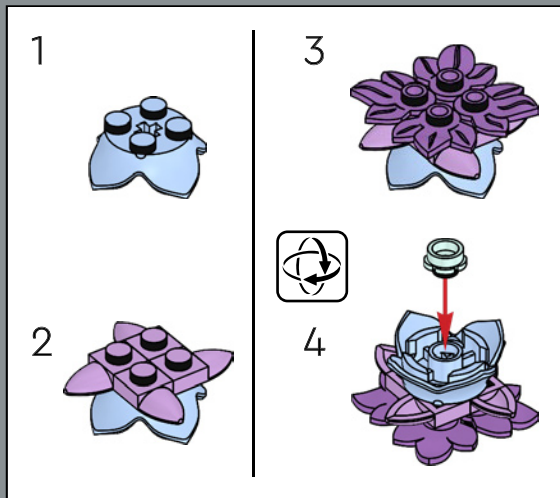

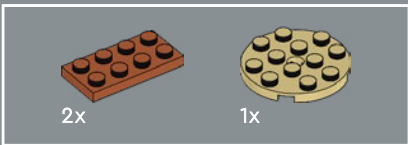
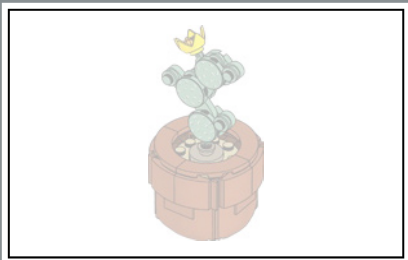

1

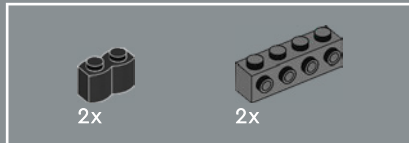
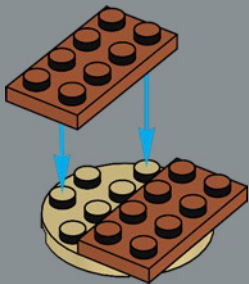

2

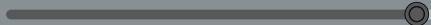
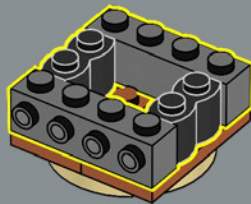

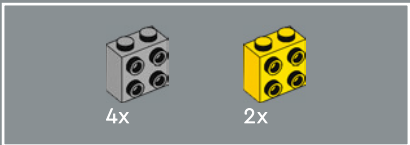

3

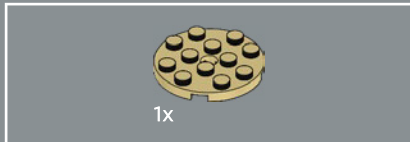
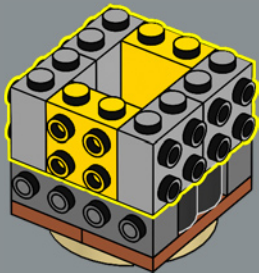

4

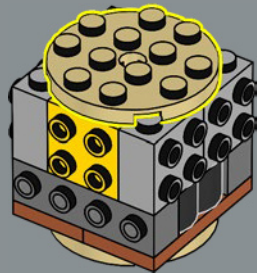

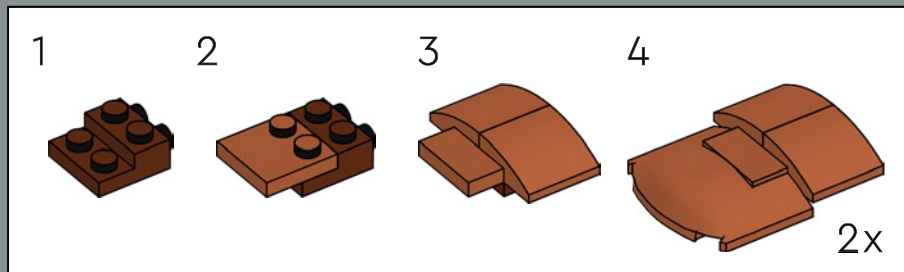
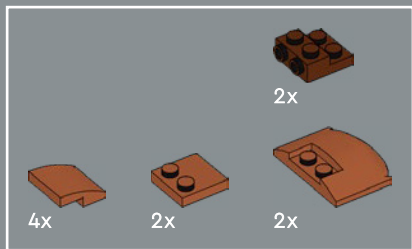

5

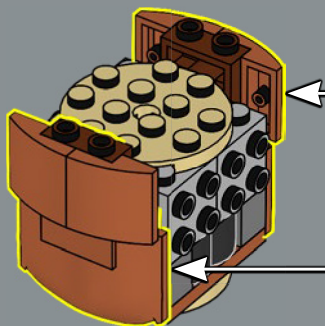

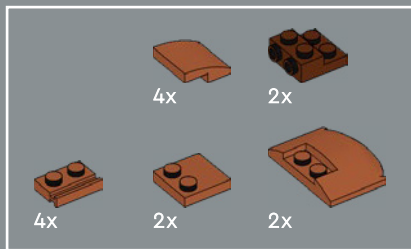

6

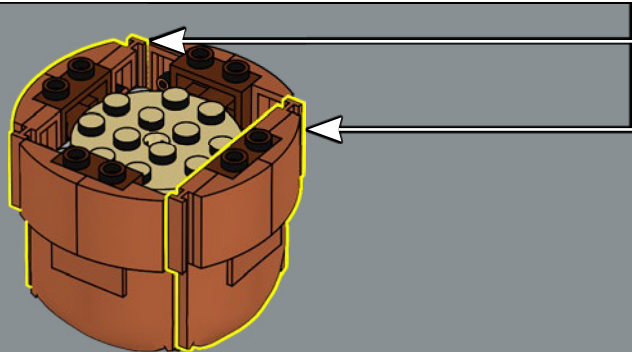
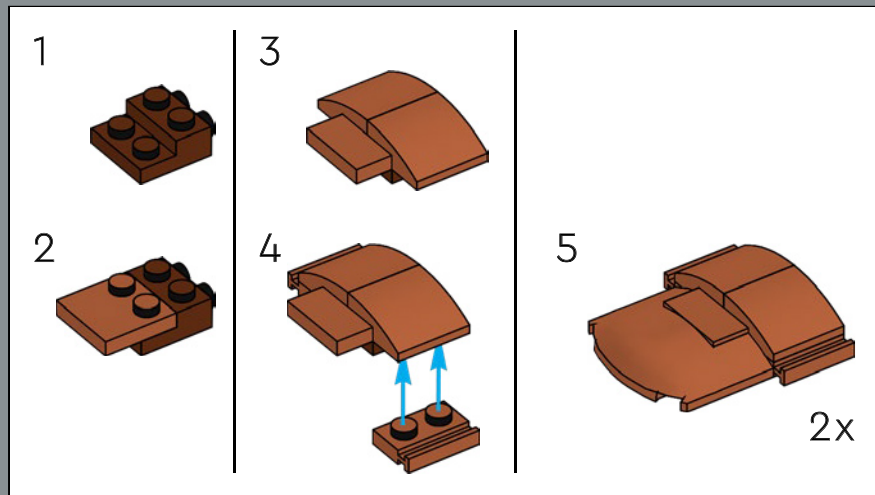

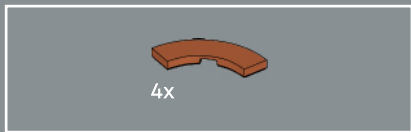

7

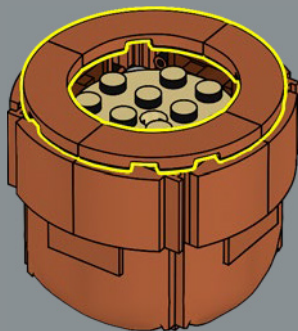

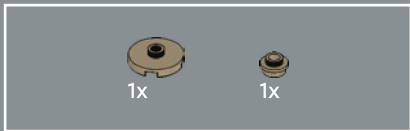

8

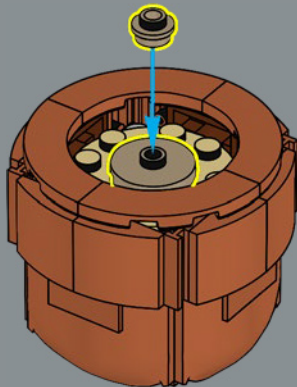

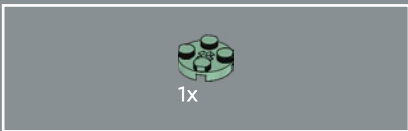
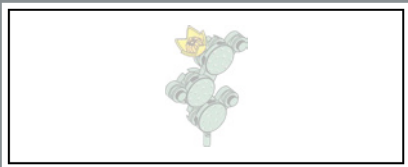

9



10

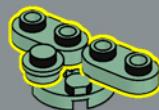

11

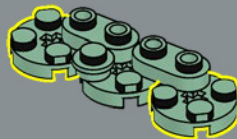

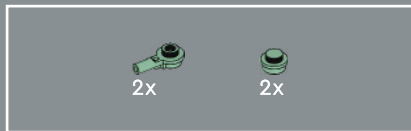

12

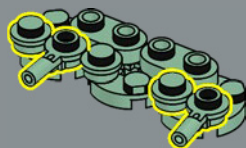

13

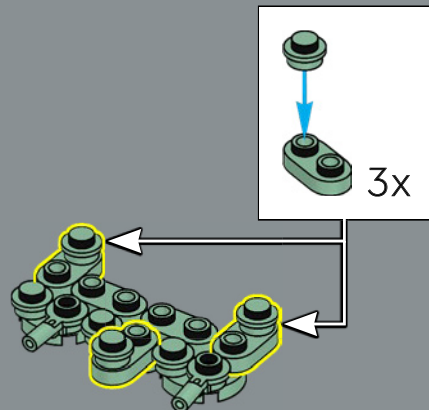



14

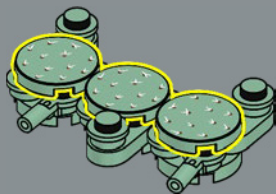

The round printed 2x2 LEGO® tiles are in a new sandy green colour and feature a fun new spiky deco to capture the look of an Eastern prickly pear.

15

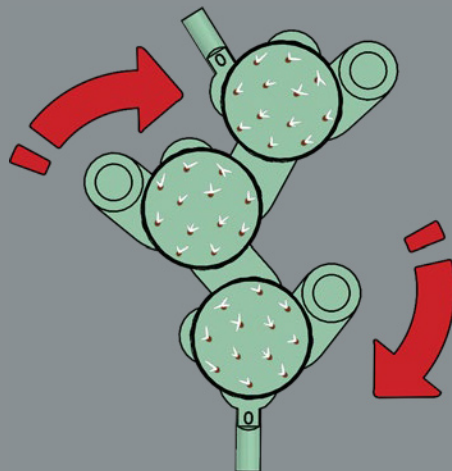

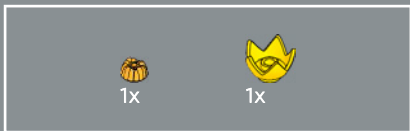

16

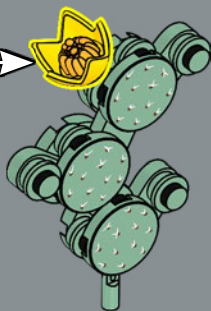
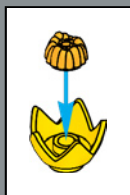

17

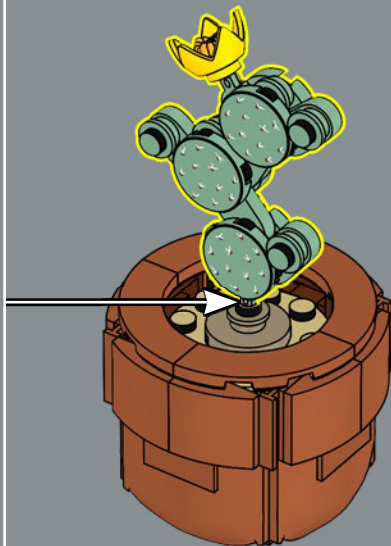

Did you know that prickly pear fruit is edible?
And so are the big green 'pads'. Just be sure to
remove the spines before eating!

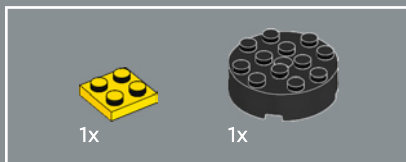

1

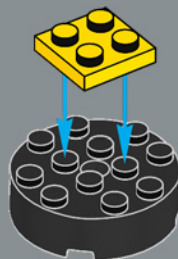



2

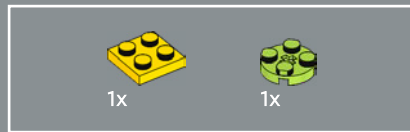
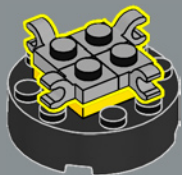

3

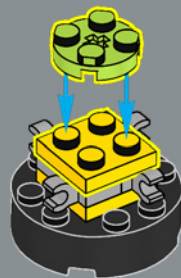



4



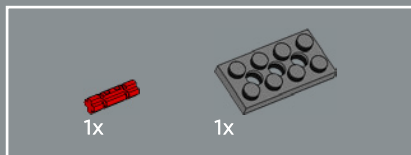

5

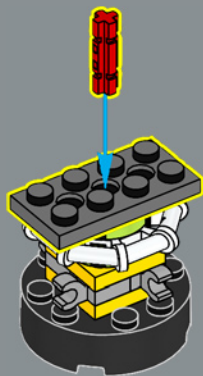

6

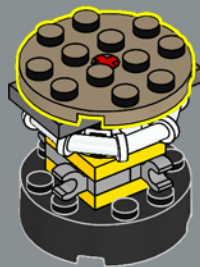

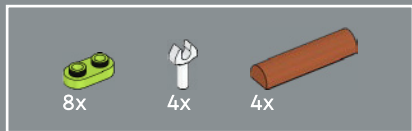

7

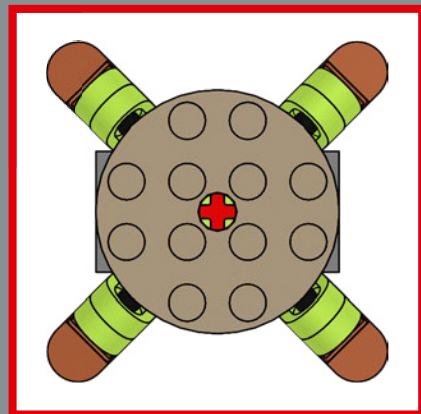
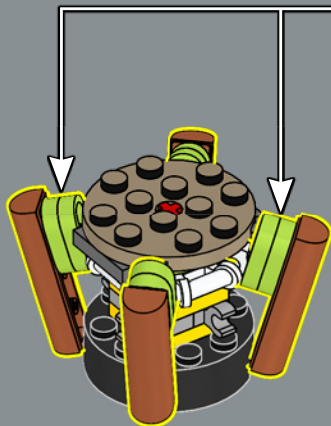
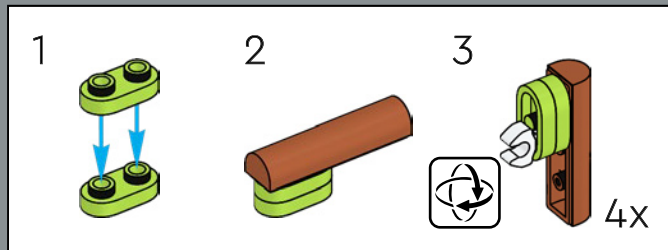

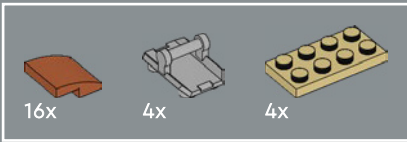

8

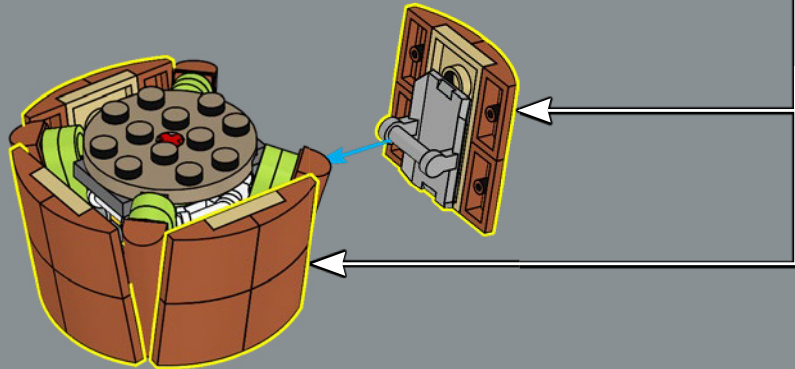
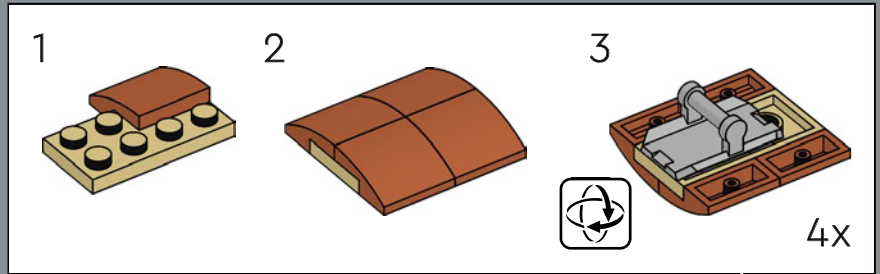

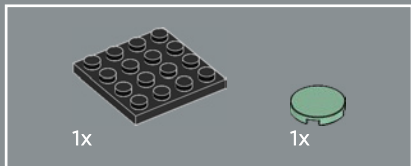
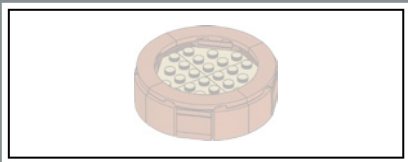

9

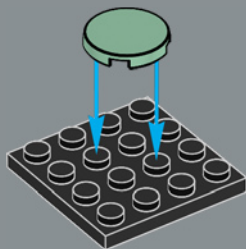

10

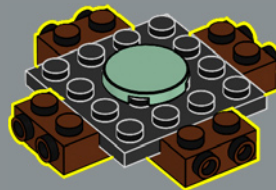



11

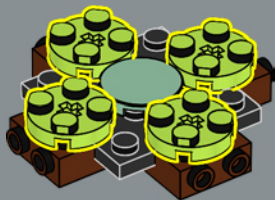

12

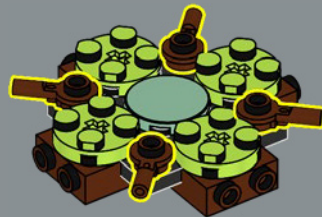

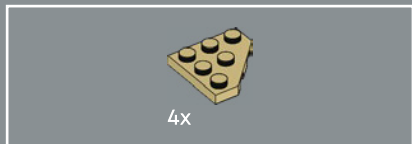

13

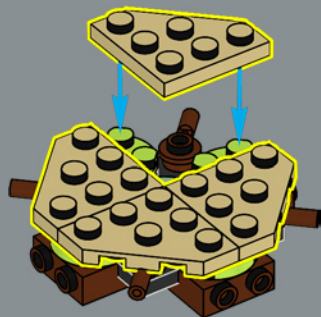

14

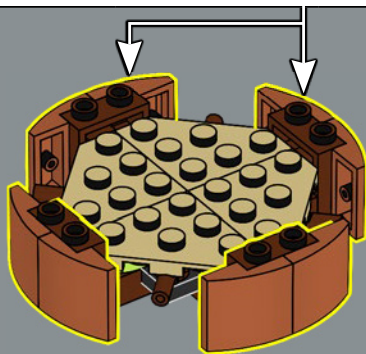
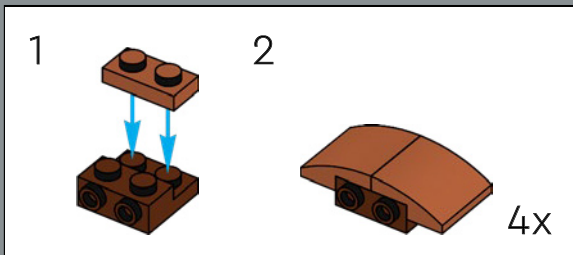

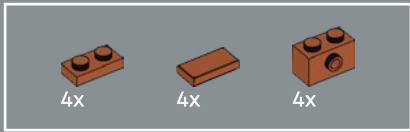

15

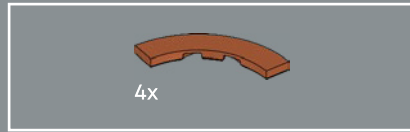
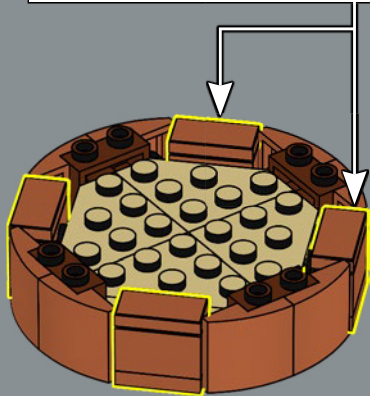
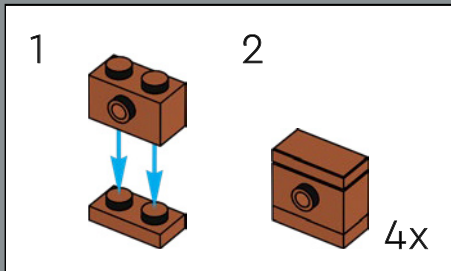

16

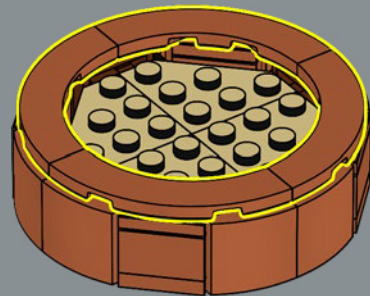

17

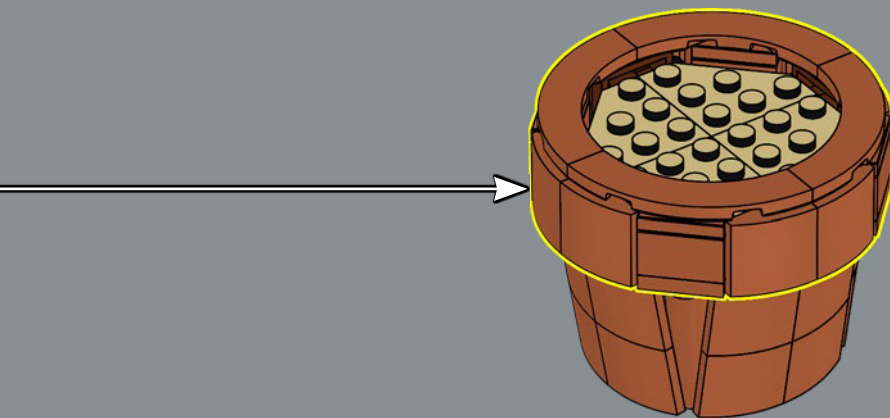

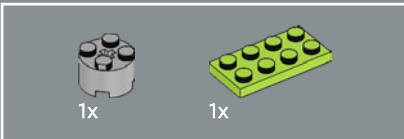
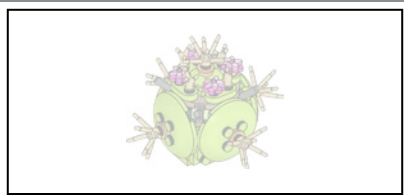

18

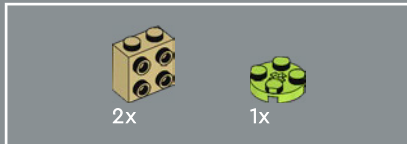
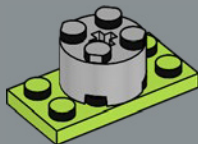

19

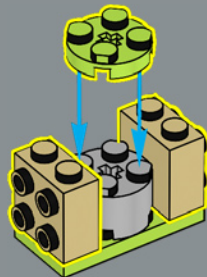



20

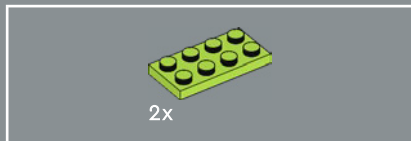
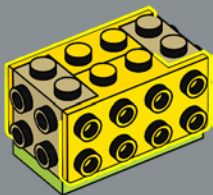

21

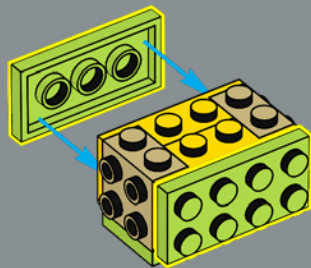



22

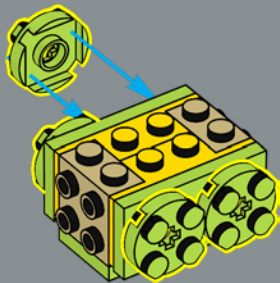

23

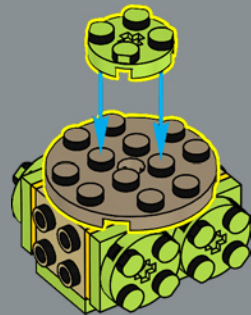



8x

24

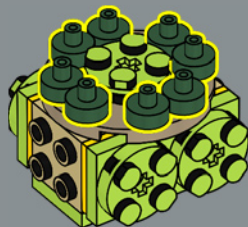



25

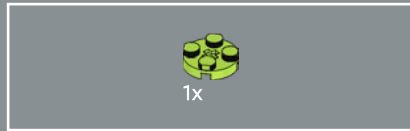
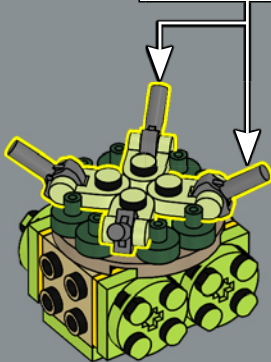
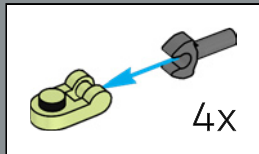

26

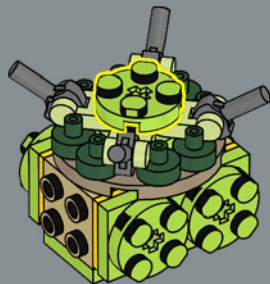



27

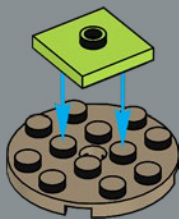

28

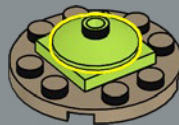



1x



4x

29

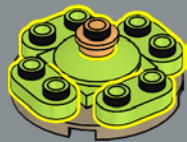

4x

30





4x

31



4x

32





33



34

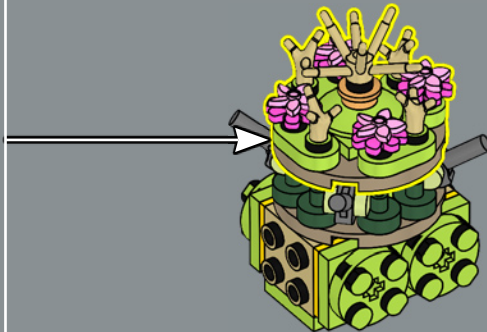

Several species of pincushion cactus grow a lovely crown of flowers in vivid colours.



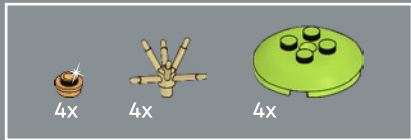

35

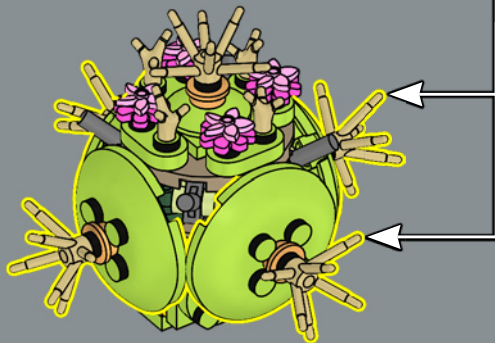
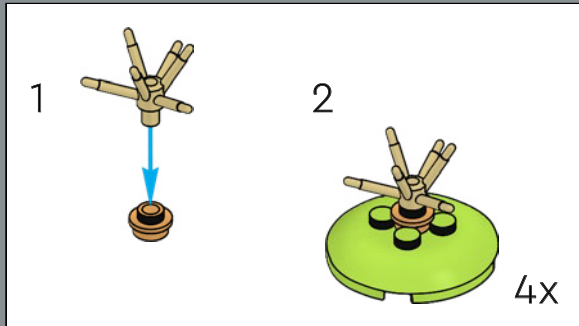

After being catalogued for the first time in the late 1920s, *Mammillaria crinata* f. *zeilmanniana* was largely unknown, until it was rediscovered in 1988 within a specific canyon area in Mexico.

36

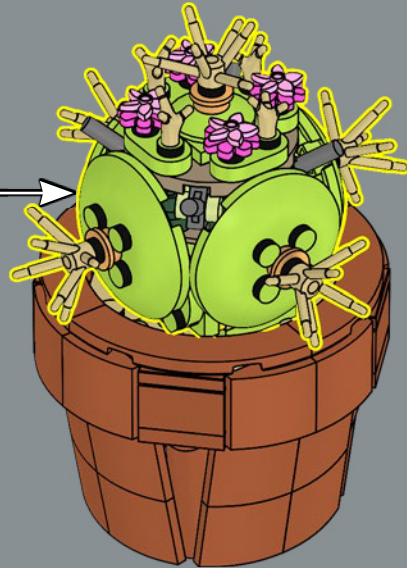



4x



8x



4x



4x

37

1

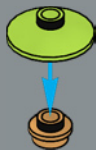

2



3



4x

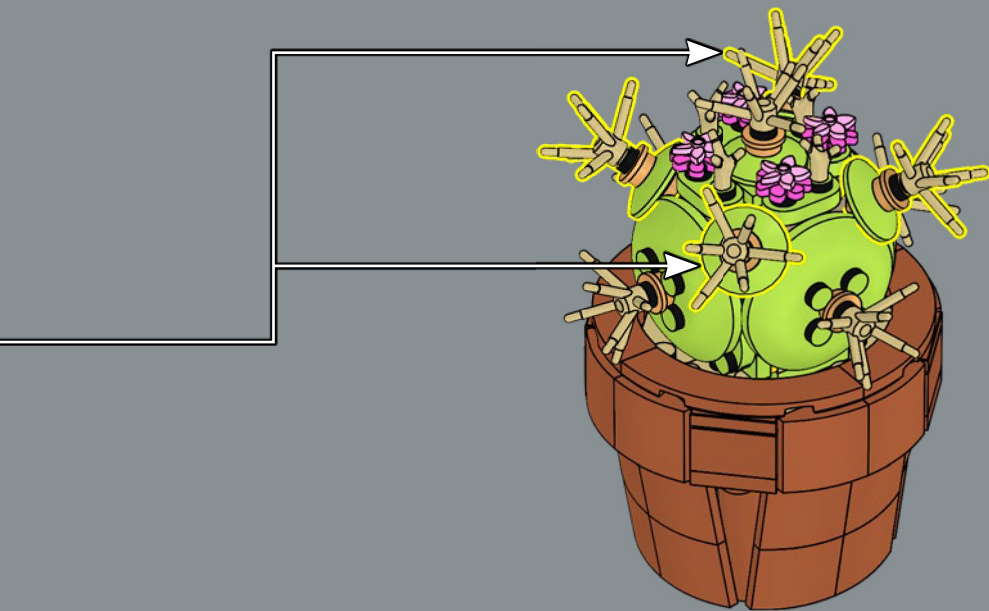



12x
6439046



3x
6302268



8x
6210269



2x
6468074



6x
4644456



1x
6074954



3x
6009016



12x
4114309



3x
4142865



1x
6170487



3x
6089119



2x
6399780



4x
6324176



1x
6449709



1x
6132541



1x
6168644



3x
4558957



2x
302228



13x
4140562



2x
6439048



1x
6102138



1x
6365630



3x
4243819



4x
6451597



2x
6214334



4x
6368619



2x
6135130



2x
6313592



5x
6382575



4x
6328327



10x
6463564



4x
6348058



4x
6370686



2x
302224



10x
6210271



4x
6468078



4x
4208072



2x
6400110



2x
302221



2x
6118828



2x
6253140



8x
6400649



2x
6138624



2x
4119479



3x
6161772



24x
4570877



12x
6468067



12x
4614158



12x
6228839



96x
6104344



12x
6394948



12x
6439724



12x
6468066



12x
6468071



3x
6462459



6x
4535928



3x
6462460



12x
6468069



4x
6240030



1x
6147052

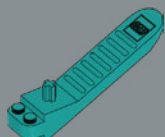

1x
6254100



6x
6211875



13x
6264062



2x
6190251



4x
6468391



13x
6314224



2x
6438450



5x
6121816



2x
6468075



1x
6056291



4x
6468077



3x
4537936



2x
6143445



13x
6300322



5x
6132767

2x
6092591

4x
6038637

6x
6232138

13x
6190252



8x
6454462

5x
6397157

8x
6392975

6x
6403175

5x
6303004

2x
6357616

3x
6468072

3x
6467694

3x
6223237

8x
6468343

4x
6360079

1x
6448317

1x
6456642

1x
4211183

3x
6133765

20x
6306775

6x
6102360

1x
6349130

36x
6470170

1x
6313506

4x
6075207

1x
6170468

12x
6335378

4x
4211526

12x
6123809

12x
6195471

1x
6420921

4x
6439040

7x
6395635

6x
4210725

3x
4227398

1x
6230582

4x
6206151

4x
6096990

3x
6468345

8x
6426463

6x
6468346

5x
6005030

1x
6251854

4x
6210460

4x
6468342

1x
6275487

4x
6223506

12x
6468504

4x
6468079

 [LEGO.com/service](https://www.LEGO.com/service)



YOU COULD WIN



YOU COULD WIN

Your feedback will help shape the future development of this product series.

Visit:

DU KÖNNTEST GEWINNEN

Dein Feedback trägt zur Weiterentwicklung dieser Produktreihe bei.

Geh auf:

VOUS POURRIEZ GAGNER

Vos commentaires nous aideront à concevoir les futurs produits de cette gamme.

Visitez :

POTRESTI VINCERE TU

La tua opinione ci aiuterà a migliorare la creazione futura di questa linea di prodotti.

Visita:

PUEDES GANAR

Tu opinión contribuirá al futuro de esta serie de productos.

Visita:

轻松获奖

您的反馈将有助于我们在今后改进本产品系列。

请访问:

LEGO.com/productfeedback

You also have the chance to win a LEGO® set.

Terms and conditions apply.*

Außerdem hast du die Chance, ein LEGO® Set zu gewinnen.

Es gelten die Teilnahmebedingungen.*

Vous pourriez également gagner un ensemble LEGO®.

Des conditions s'appliquent.*

Hai anche la possibilità di vincere un set LEGO®.

Termini e condizioni sono applicabili.*

También tienes la oportunidad de ganar un set LEGO®.

Aplican términos y condiciones.*

您还有机会赢取乐高®套装。

条款和条件适用。*

*LEGO.com/productfeedback-terms



LEGO and the LEGO logo are trademarks of the LEGO Group. ©2024 The LEGO Group. 6494683



Booklet available in English on
Heft in deutscher Sprache erhältlich auf
Livret disponible en français sur
Libretto disponibile in italiano su
Folleto en español disponible en
如需中文版手册, 请访问





[LEGO.com/sustainable-packaging](https://www.lego.com/sustainable-packaging)



 **FR**
DONNEZ
OU
RECYCLEZ

 OU  OU 

ASSOCIATION MAGASIN DÉCHÈTERIE

Adresses sur [quefairedemesdechets.fr](https://www.quefairedemesdechets.fr)

LEGO® VIP

- 1.** SIGN UP
INSCRIVEZ-VOUS
REGÍSTRATE

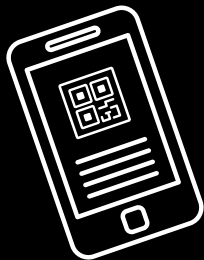

- 2.** EARN POINTS
FOR PURCHASES
GAGNEZ DES
POINTS POUR
VOS ACHATS
GANA PUNTOS
POR TUS COMPRAS



- 3.** REDEEM POINTS FOR REWARDS,
EXPERIENCES, DISCOUNTS & MORE
ÉCHANGEZ DES POINTS CONTRE DES
RÉCOMPENSES, DES EXPÉRIENCES,
DES RÉDUCTIONS ET PLUS ENCORE
CANJEA PUNTOS POR RECOMPENSAS,
EXPERIENCIAS, DESCUENTOS Y
MUCHO MÁS

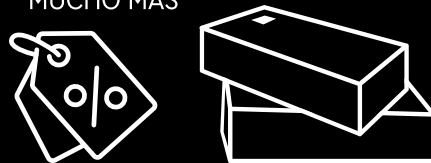

LEGOLAND®





CULTIVATE YOUR CREATIVE FINGER

🪴 'These humble but prolific terracotta pots are the latest addition to our LEGO® Botanical Collection – three groups of iconic and exotic plants, miniaturised to bring classic LEGO charm to your home. From humidity-loving houseplants to desert-dwelling succulents and peculiar carnivores, this vibrant mix of plants works as a group or in smaller sets of three, keeping their colour and their fun year-round. With instructions created to make it easy for you to invite friends or loved ones to join, we hope you'll enjoy your conservatory together!'

THEO BONNER
LEGO® Model Designer





TROPICAL PLANTS

▣ Tropical rainforests cover only around 6% of the Earth's surface, yet they are home to nearly two-thirds of all plant species, including plants with medicinal properties used in the treatment of a variety of illnesses. The warm, humid conditions allow thousands of vibrant, lush flowers, trees and bushes to thrive and serve as shelter and nourishment for animals and humans alike.



(Oxalis triangularis)

FALSE SHAMROCK

A perennial plant native to Argentina, Bolivia, Brazil, Paraguay and Peru.



(Crassula ovata)

JADE PLANT

A large succulent native to South Africa and Mozambique.



(Anthurium andraeanum)

LACELEAF

A flowering plant native to Columbia and Ecuador.

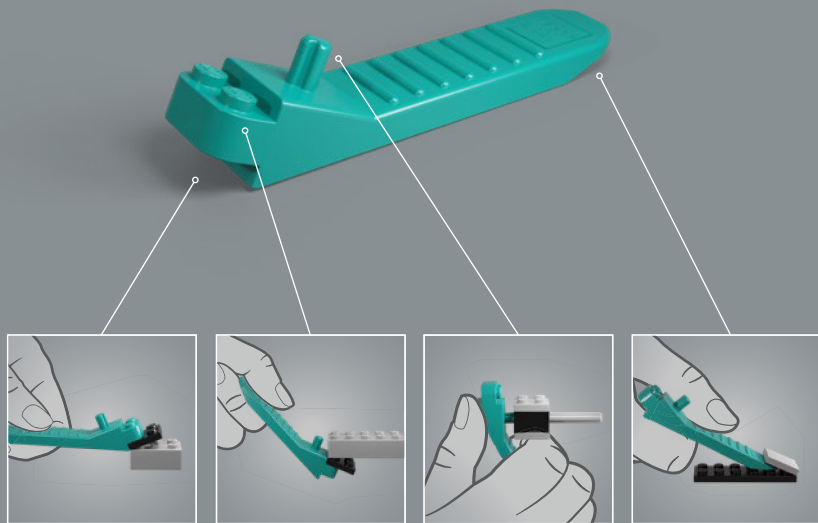

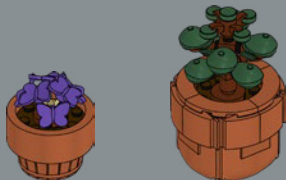

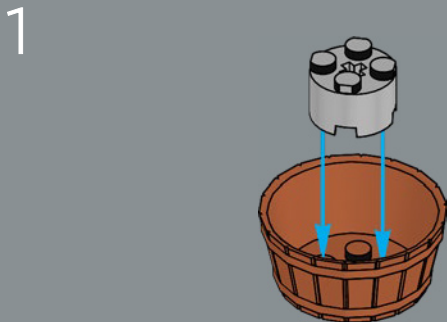
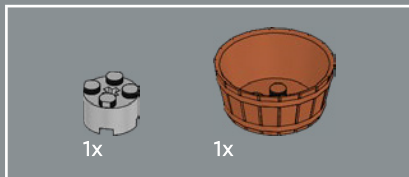

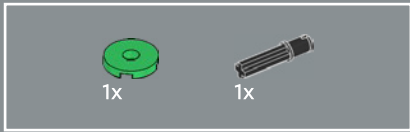

2

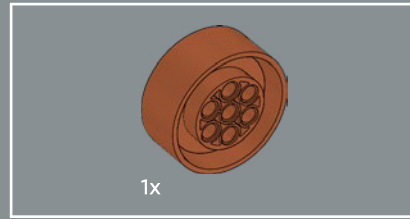
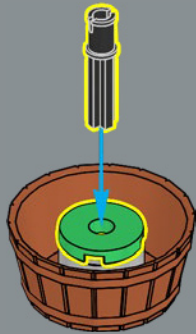

3

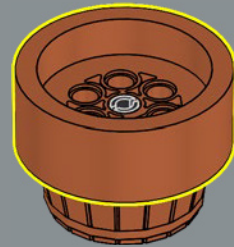



4

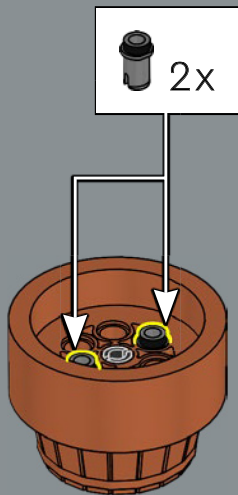

5

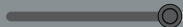

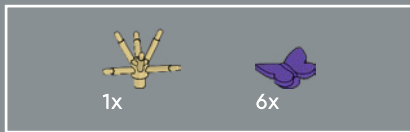

6

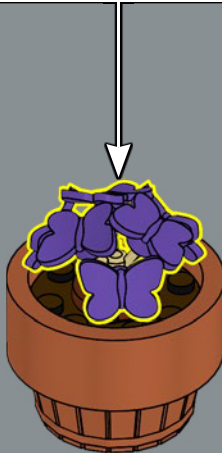
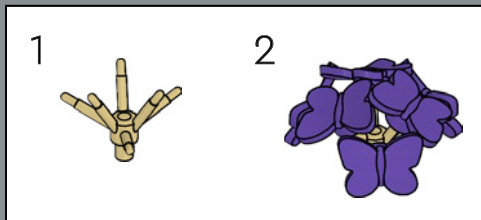

At a glance, *Oxalis triangularis* could be mistaken for a large group of butterflies, so what better way to capture this plant's iconic look than by using the LEGO® butterfly in a brand-new colour.

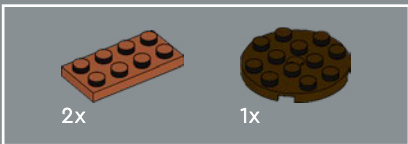
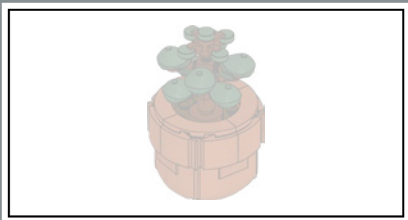

1

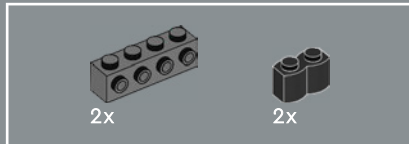
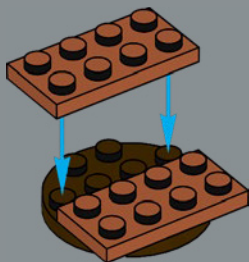

2

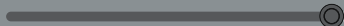
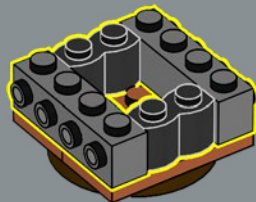

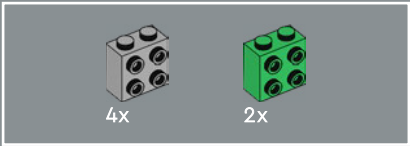

3

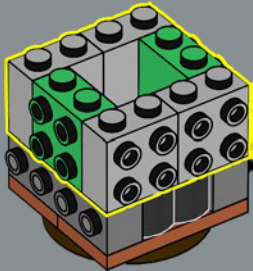

4

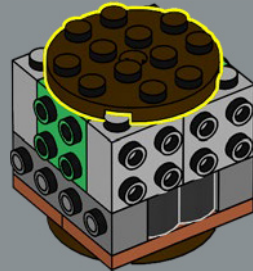

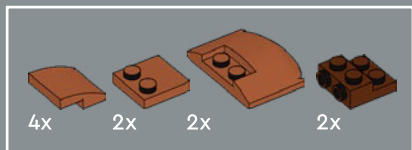

5

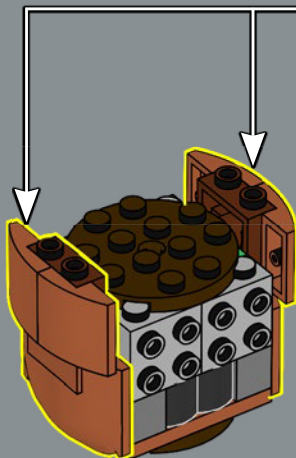
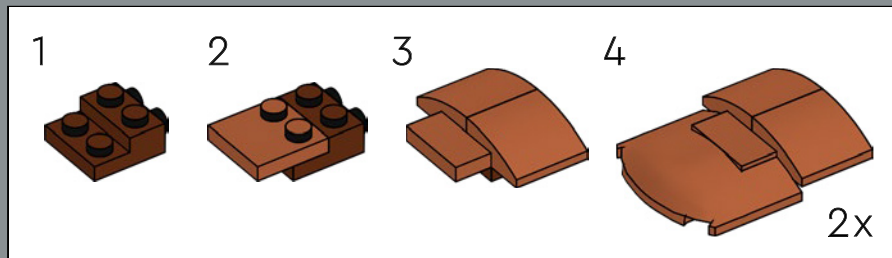

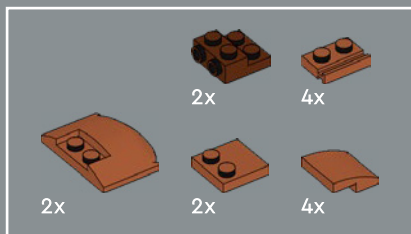

6

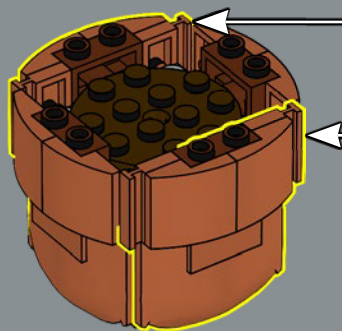
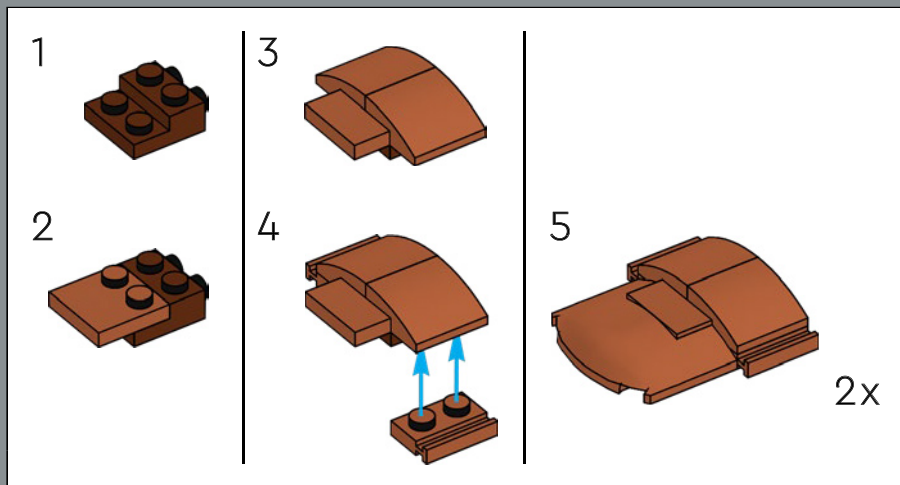

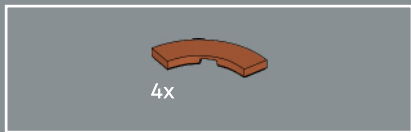

Have you ever considered learning the art of growing bonsai trees?
Jade plants grow quickly, are very accommodating and can easily
be trimmed to your liking.

7

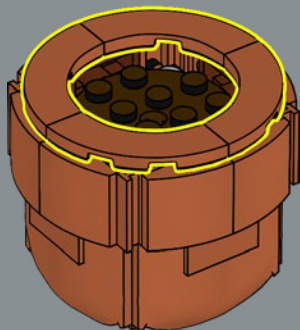



8



9

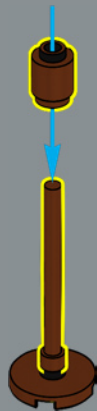



10

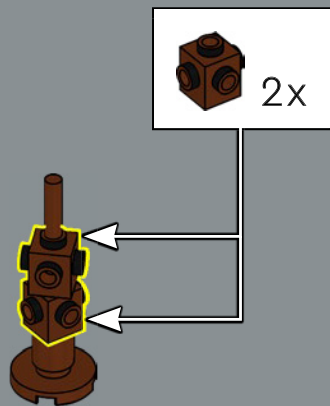

11

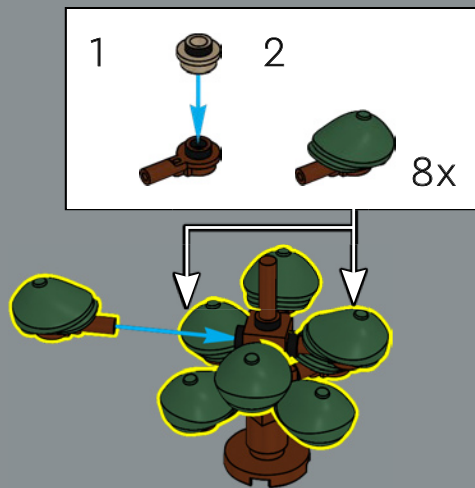



12

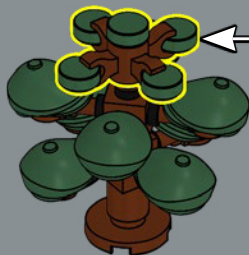

13

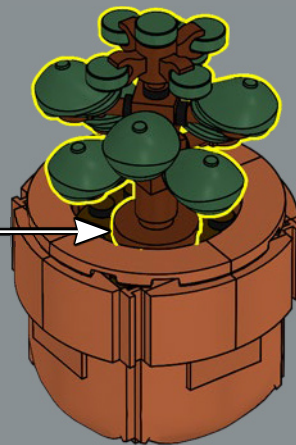

Extra! Extra! Read all about it! Flat cap in a new colour! To replicate the thick leaves of the jade plant, we used eight LEGO® flat caps first seen in the Newspaper Kid Collectible LEGO Minifigure.

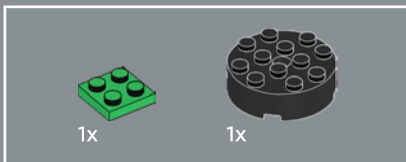
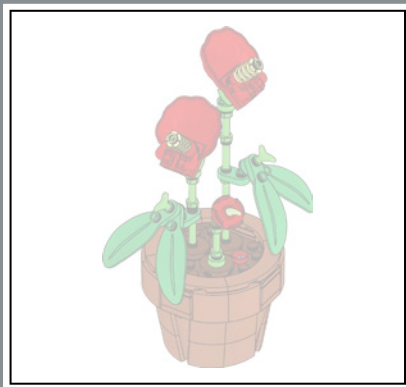

1

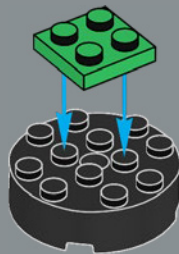

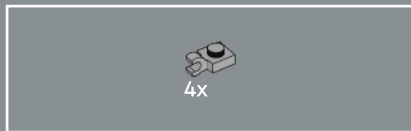

2

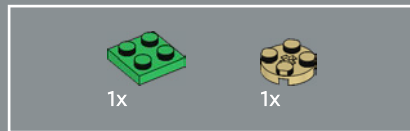
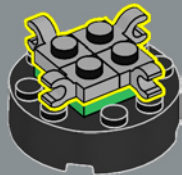

3

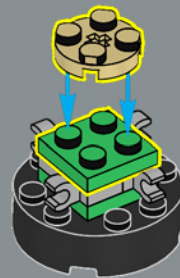

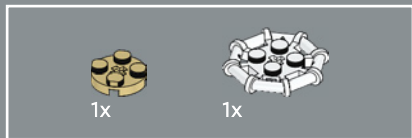

4

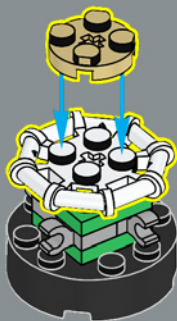

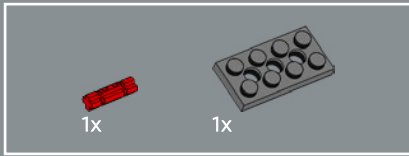

5

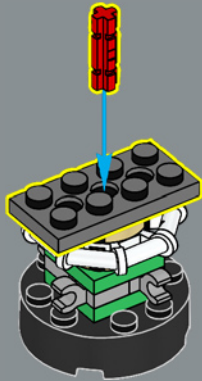

6



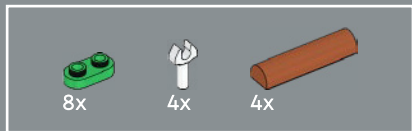

7

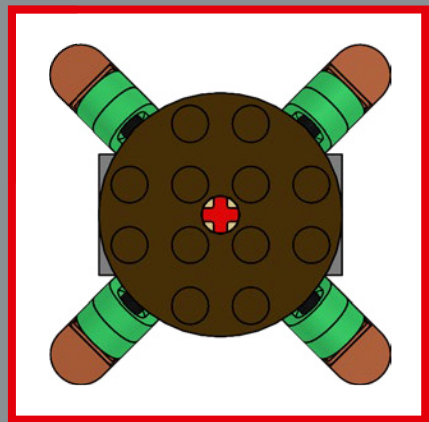
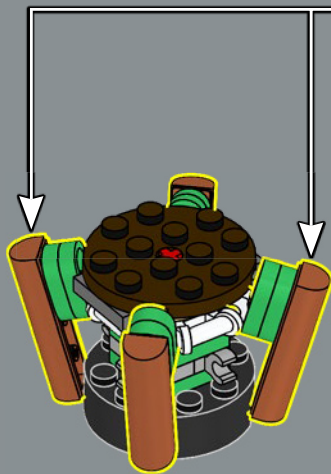
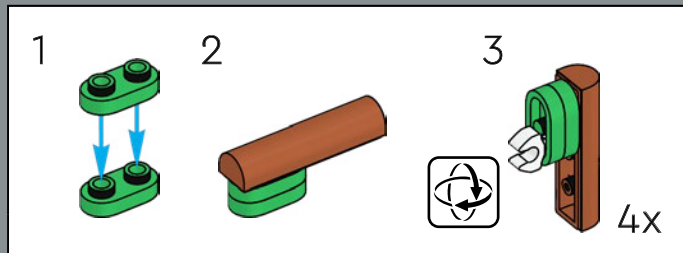

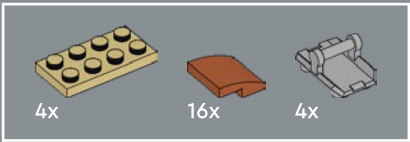

8

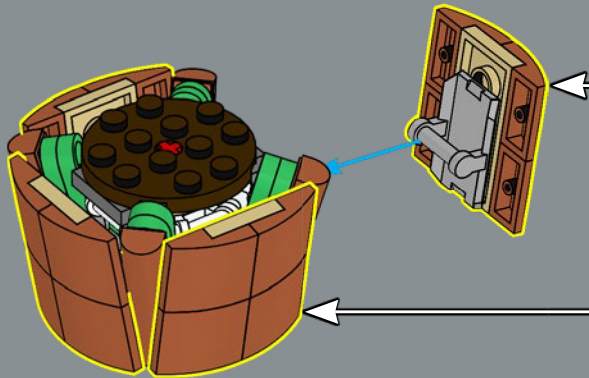
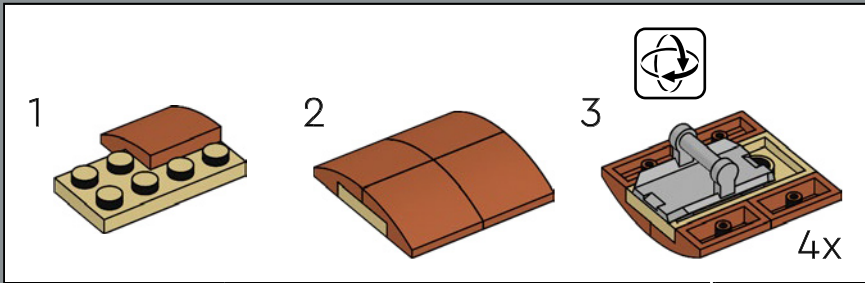

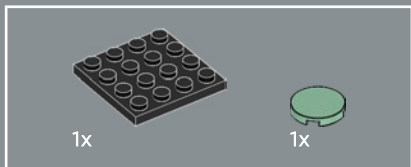
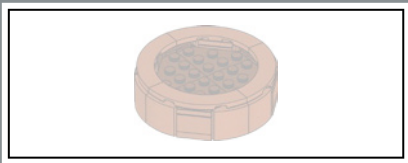

9

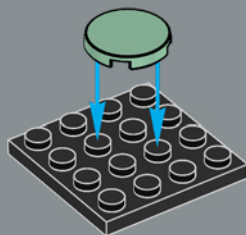



10

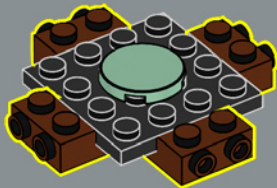

11

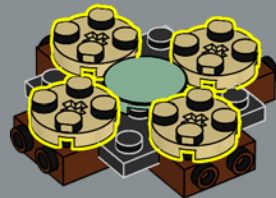



12

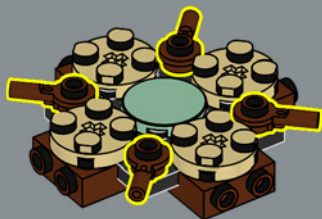

13

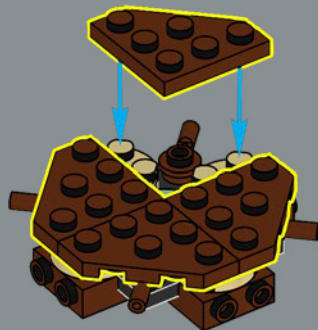



14

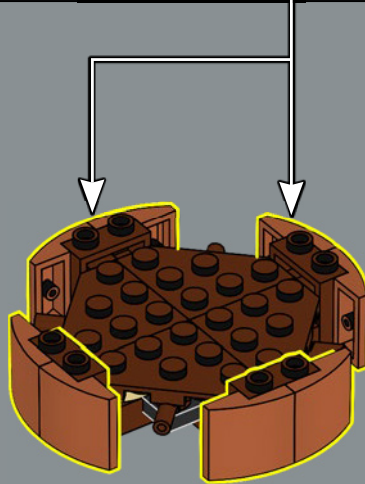
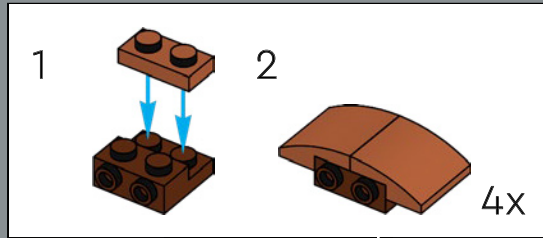

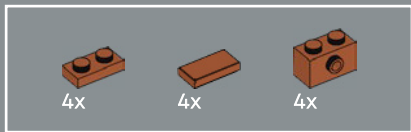

15

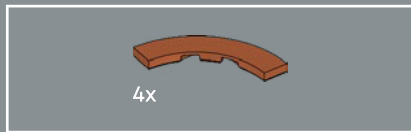
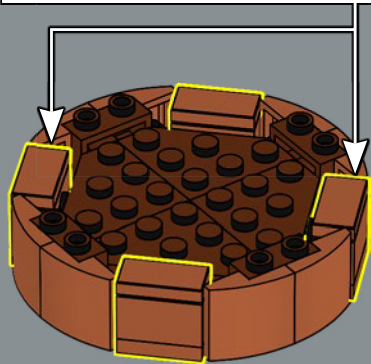
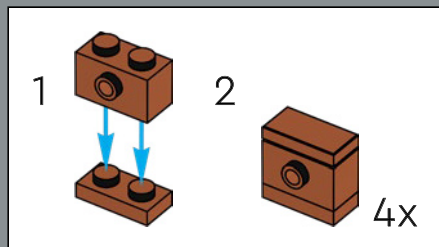

16

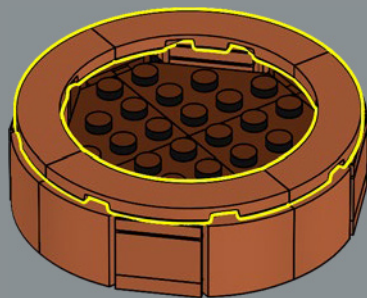

Laceleaves are susceptible to pests like aphids and spider mites, so having a hungry ladybug in the pot is a good way to keep your plant healthy.



17

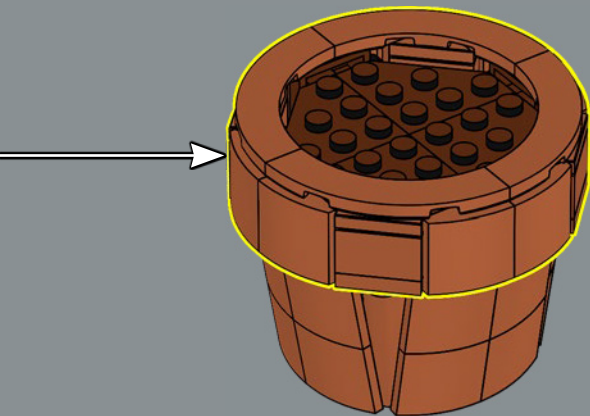

18

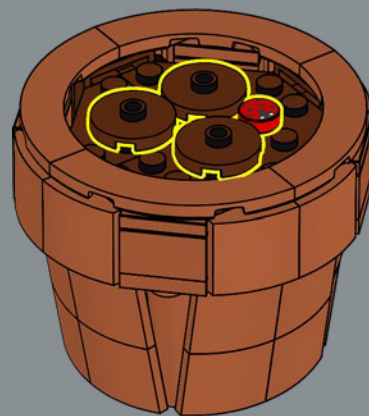



19

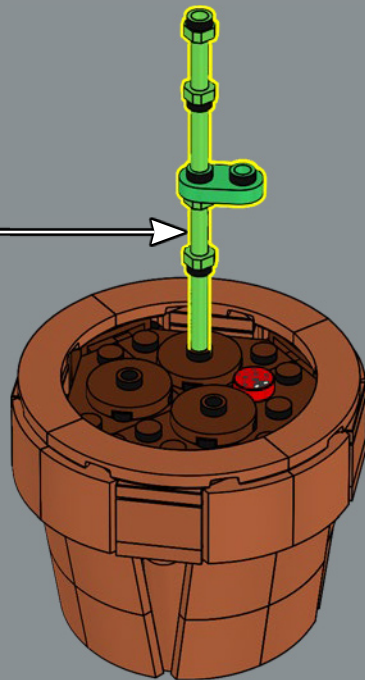
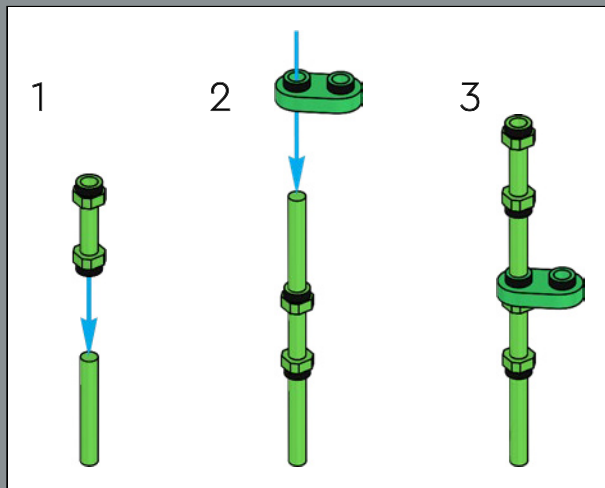

You may also know laceleaf (or Anthurium) by one of its many other names, for example, flamingo flower or painter's palette. We love the abundance of alliteration here!



20

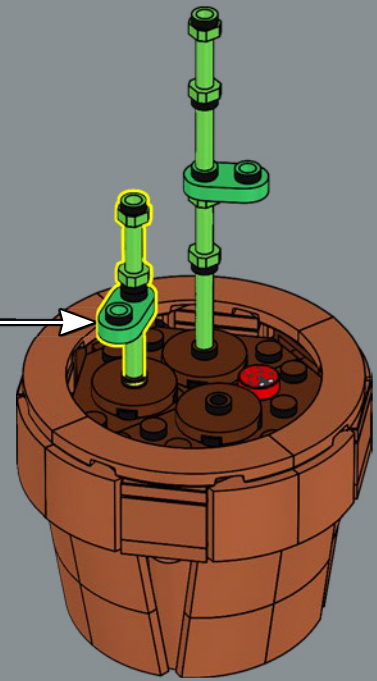
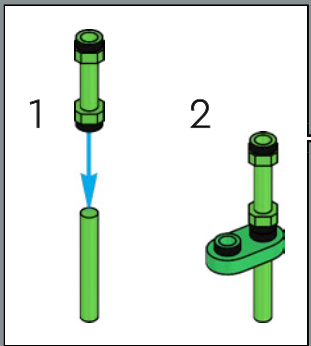

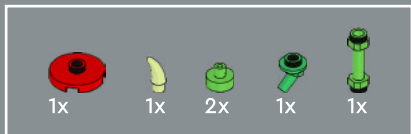

21

1



2

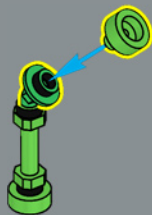

3



4



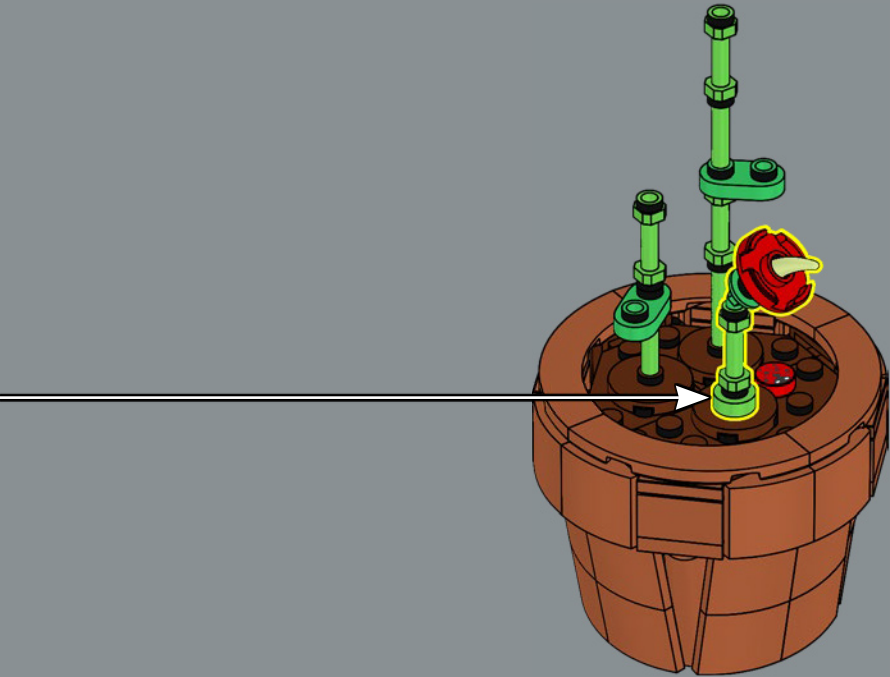

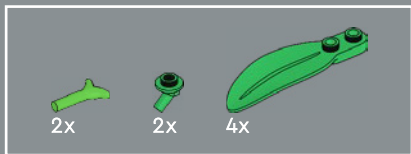

22

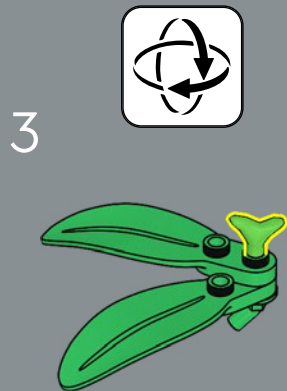
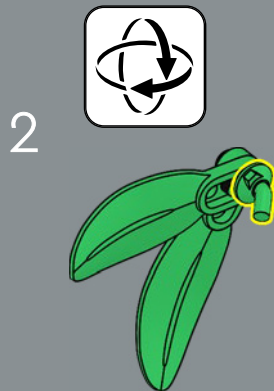
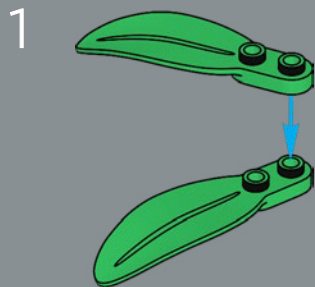

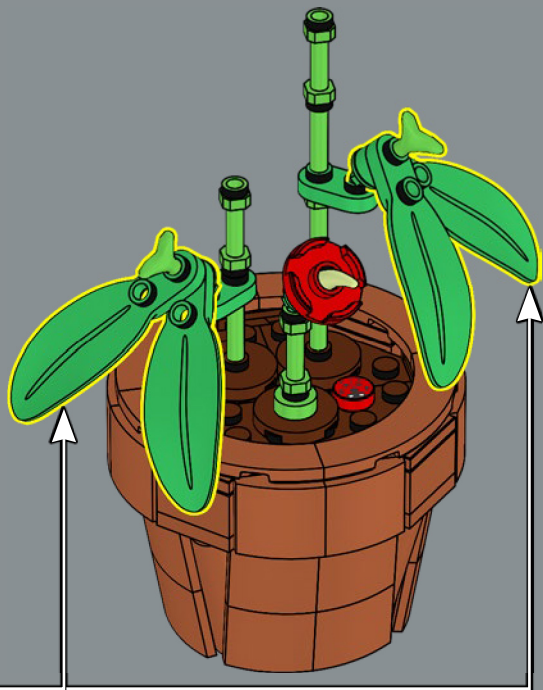

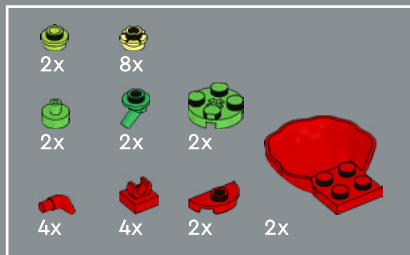
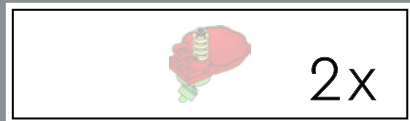

23

1

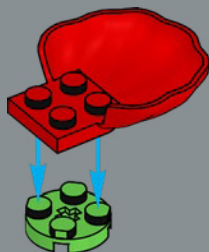

2

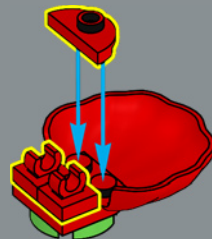

To capture the iconic ridged flower of the laceleaf, we used LEGO® clam shell elements in a new colour.

3

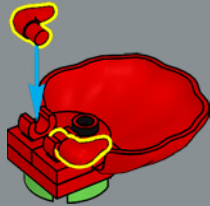

4

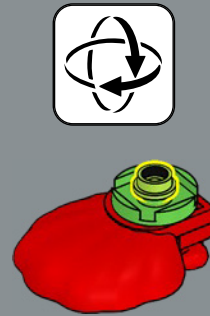

5

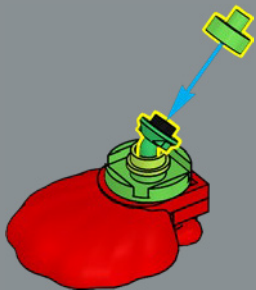

6

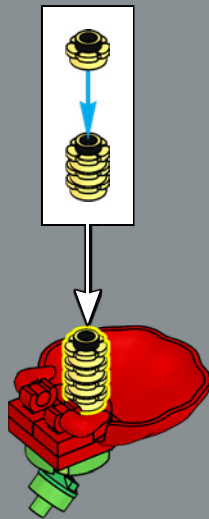

2x

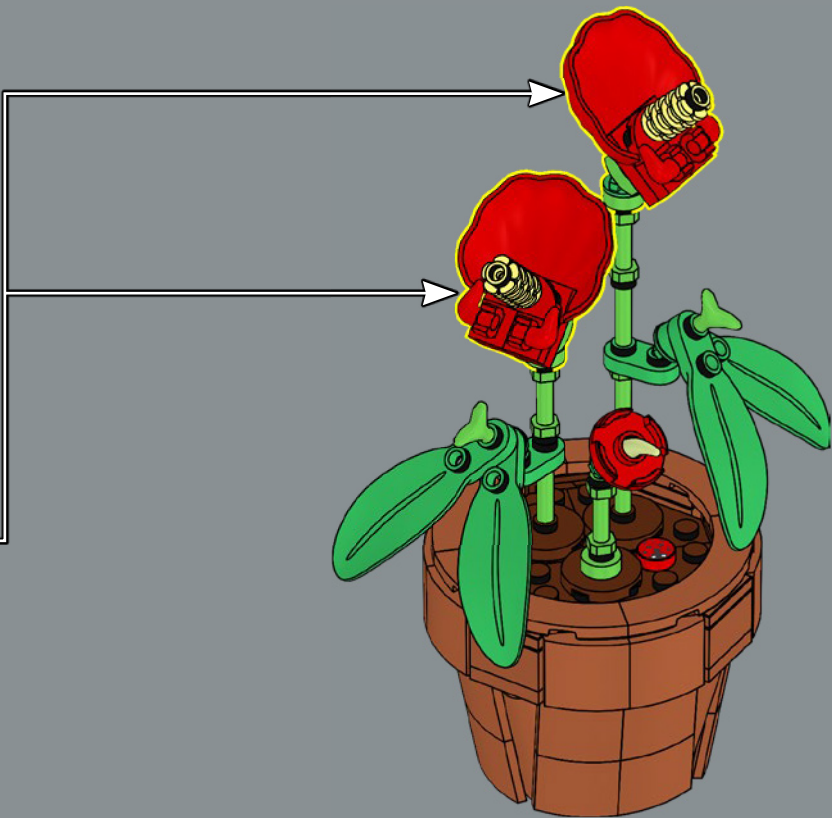



LEGO and the LEGO logo are trademarks of the LEGO Group. ©2024 The LEGO Group. 6494681

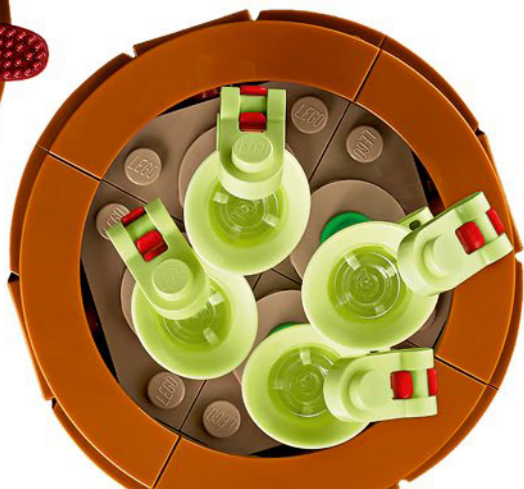



CARNIVOROUS PLANTS

▣ These plants have developed the most cunning ways to lure in and trap their prey. With snares, pitfalls, adhesives, snap traps and other curious contraptions, these captivating creations almost seem like hybrids between flora and fauna. Over 600 different known species can gobble up a veritable buffet of gullible animals, from insects and larvae to crustaceans and even smaller mammals!



VENUS FLYTRAP

Native to North Carolina and South Carolina in the United States.



RED SUNDEW

Native to the south-eastern United States.



**YELLOW
PITCHER PLANT**

Native to the south-eastern United States.



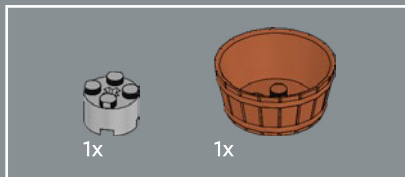

1

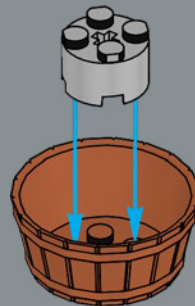

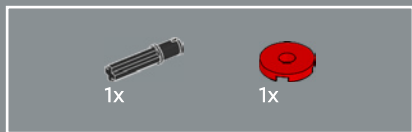

2

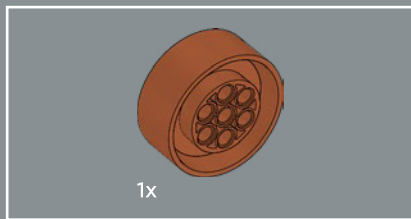
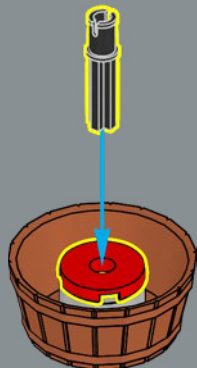

3

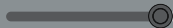
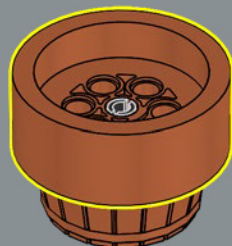



4

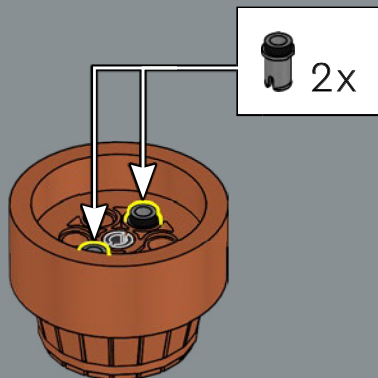

5

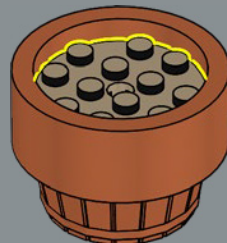

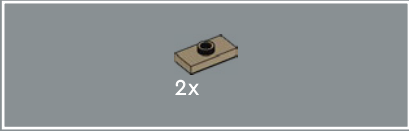

6

The Venus flytrap has sensor hairs around its two leaves that trigger its trap; when an insect touches the hairs, it will cause the jaws to close and capture the prey inside.

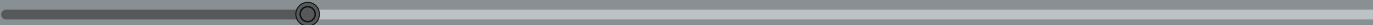
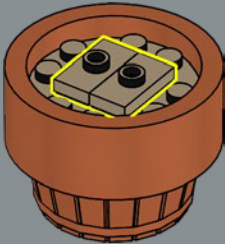



7



8





2x

9

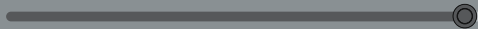



10

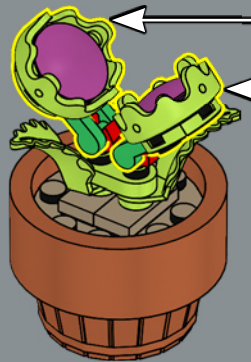
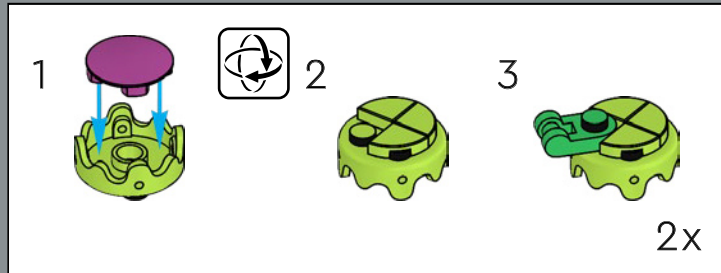

Does this piece used for the jaws of the flytrap remind you of anything? The element was originally designed as icing for a cake. This is the first time it has been used in lime green.

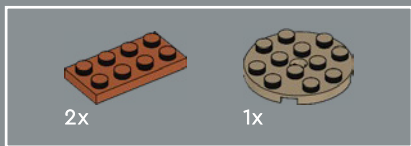
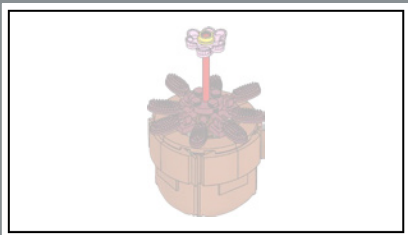

1

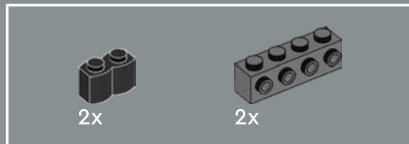
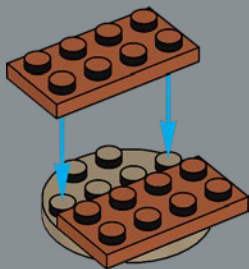

2

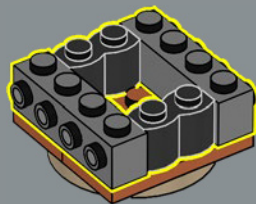

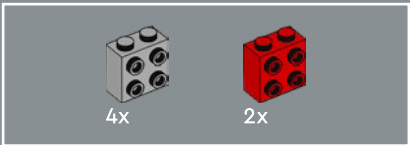

3

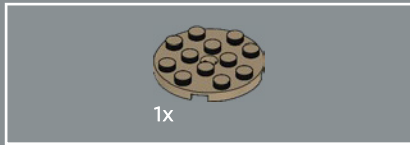
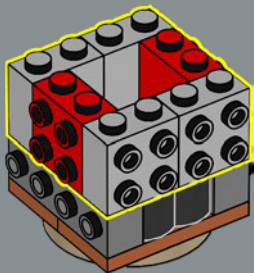

4

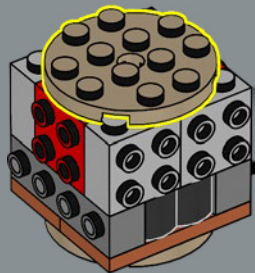

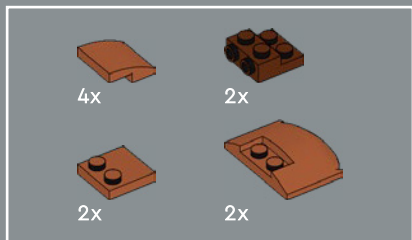

5

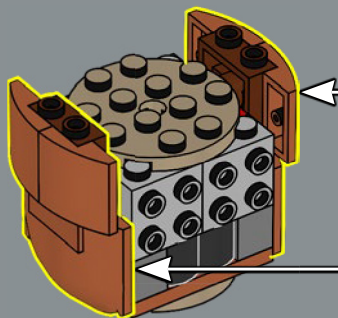
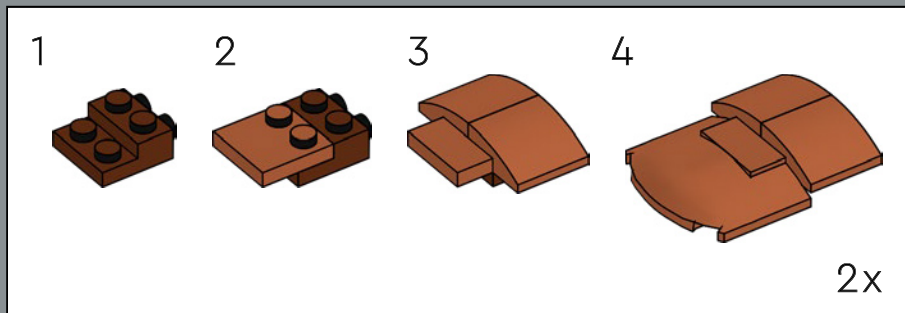

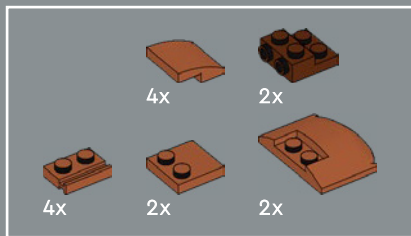

6

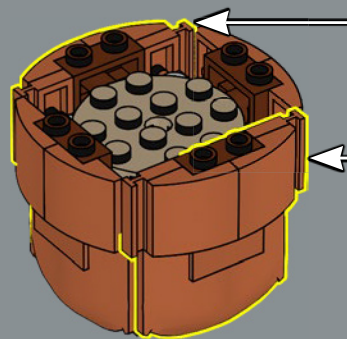
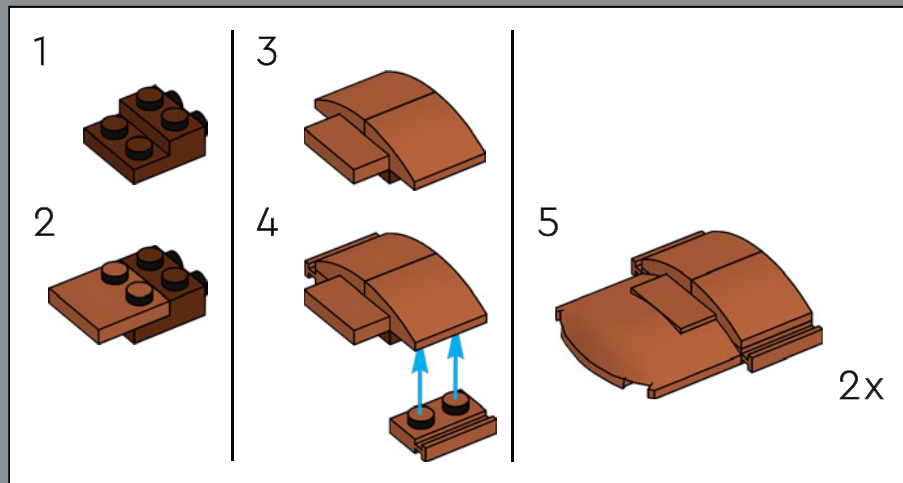

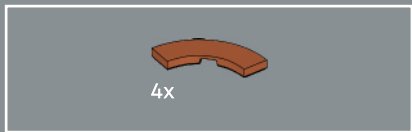

7

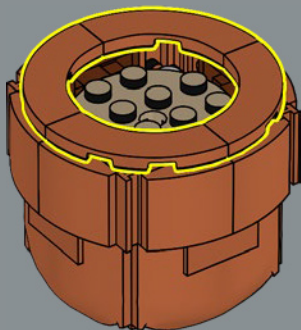

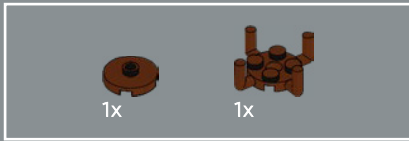

8

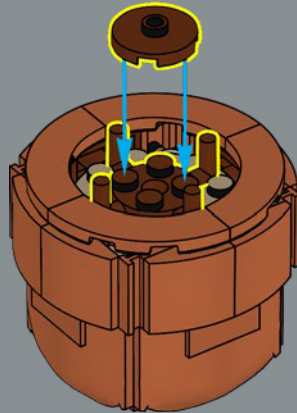

This carnivorous plant uses thousands of tiny hairs, each tipped with a bead of sticky liquid, to trap its prey. Once the insect is stuck to the leaves, they will curl inwards around the unsuspecting little bug.



1x



1x

9



1x



1x

10





11

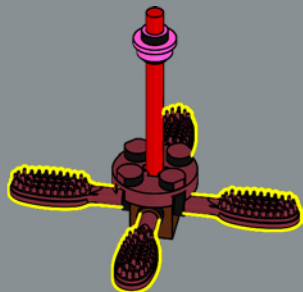

12

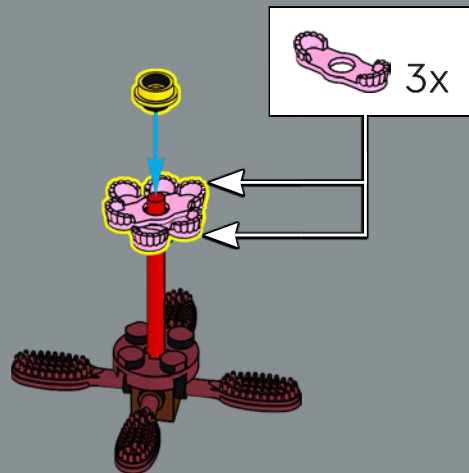

Pink epaulets make the leaves of the sundew flower, a first in this colour. If you happen to have a LEGO® Captain Red Beard minifigure, you could turn him into Captain Pink Beard.

13

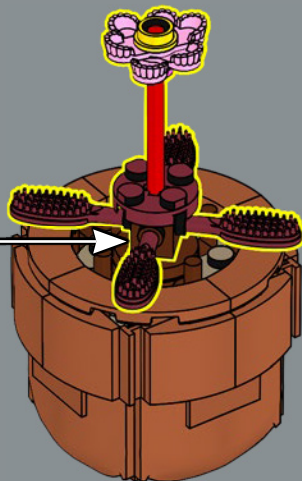

Could it be? Yes, these are actually little LEGO® hairbrushes.

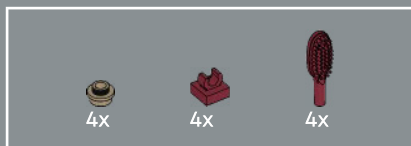

14

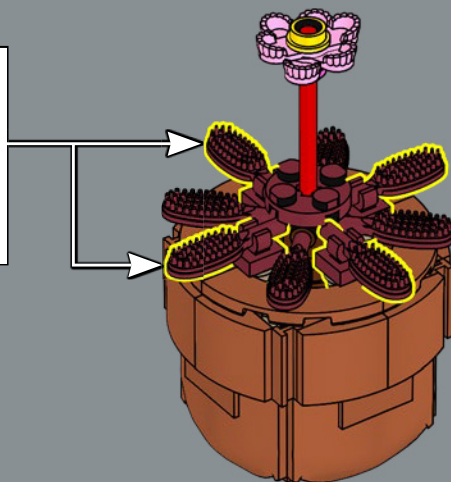
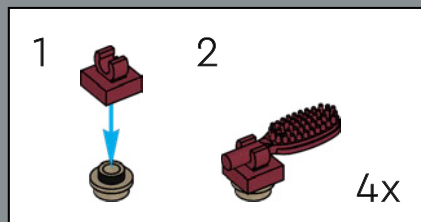

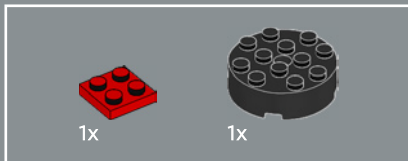
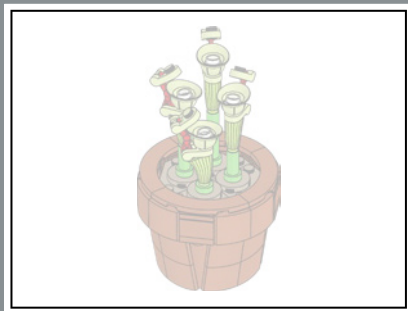

1

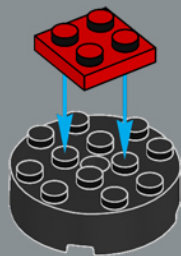



2

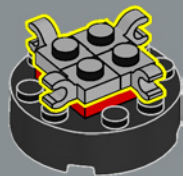

3

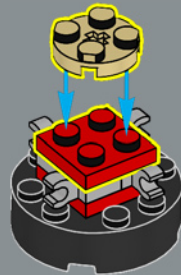

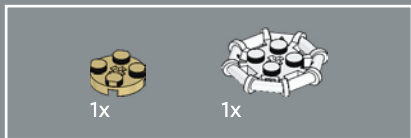

4



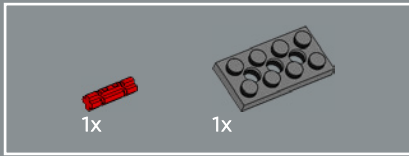

5

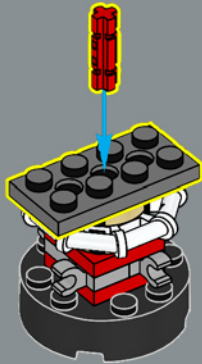

6



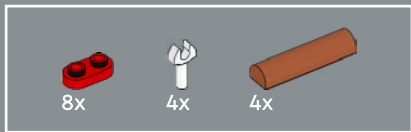

7

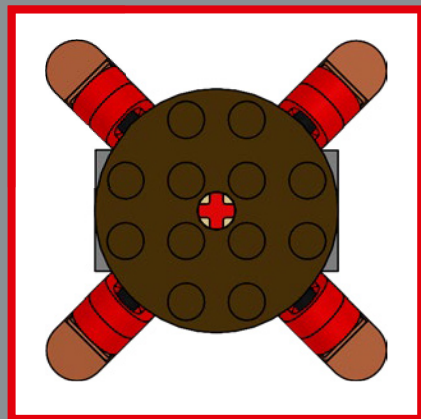
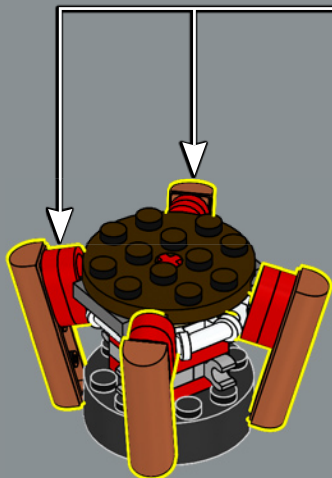
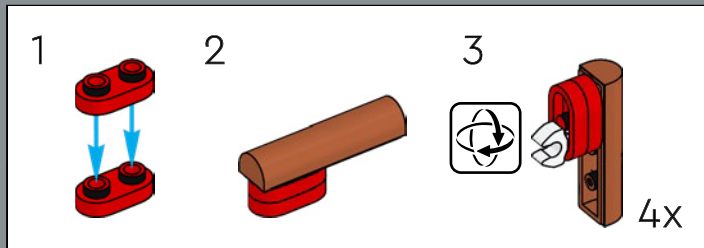

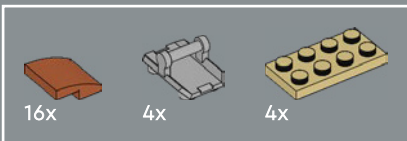

8

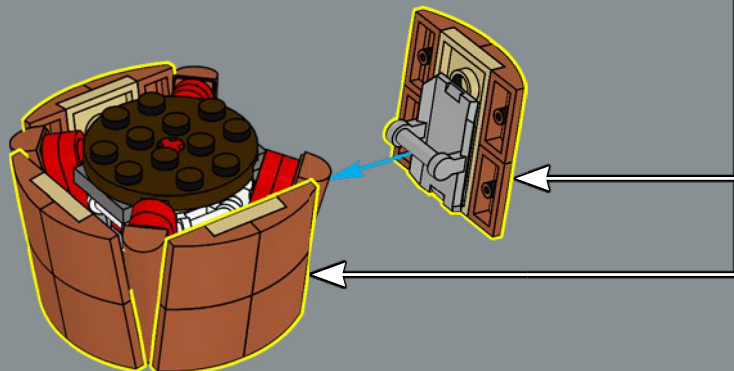

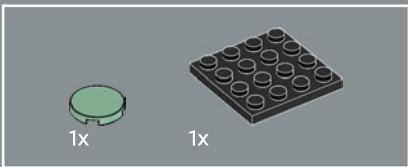
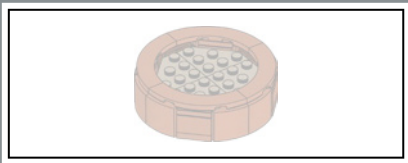

9

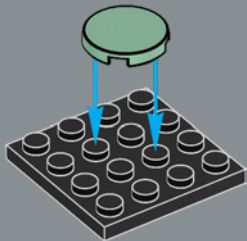



10

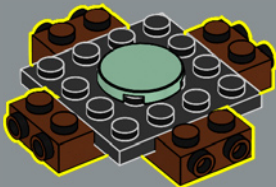

11

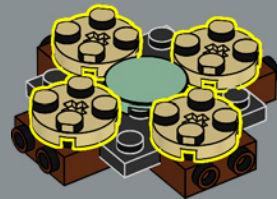



12

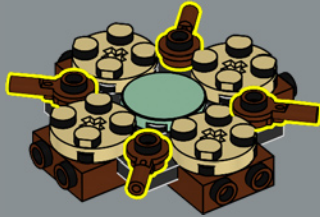

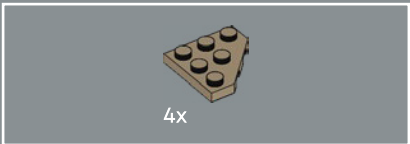

13

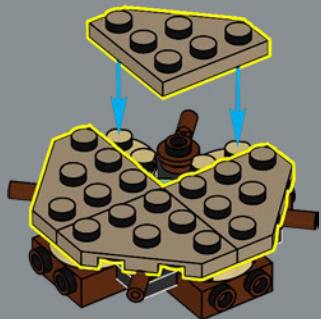



14

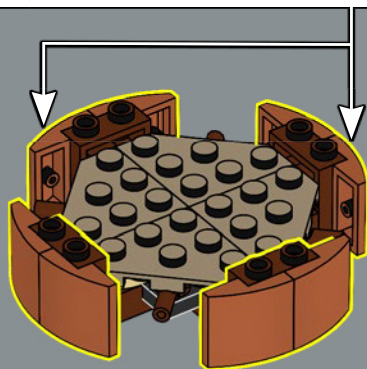
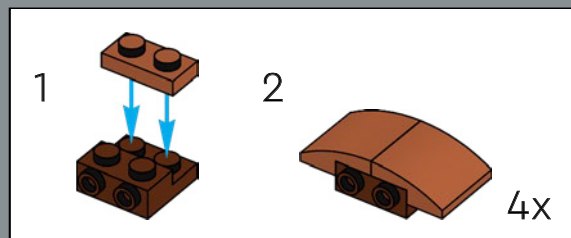

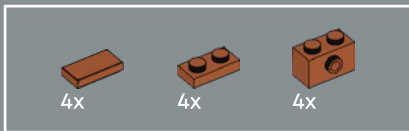

15

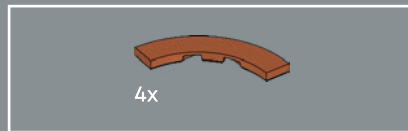
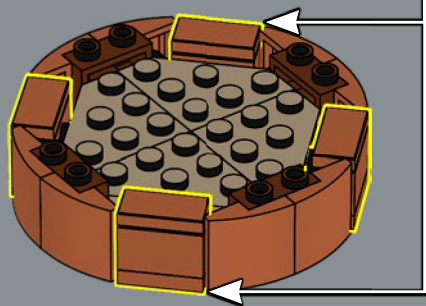
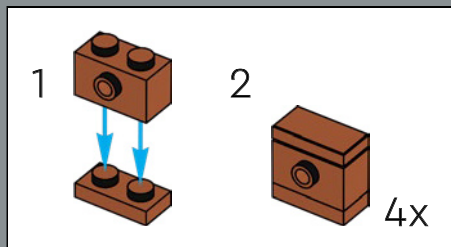

16

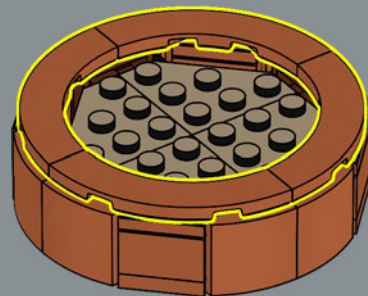

17

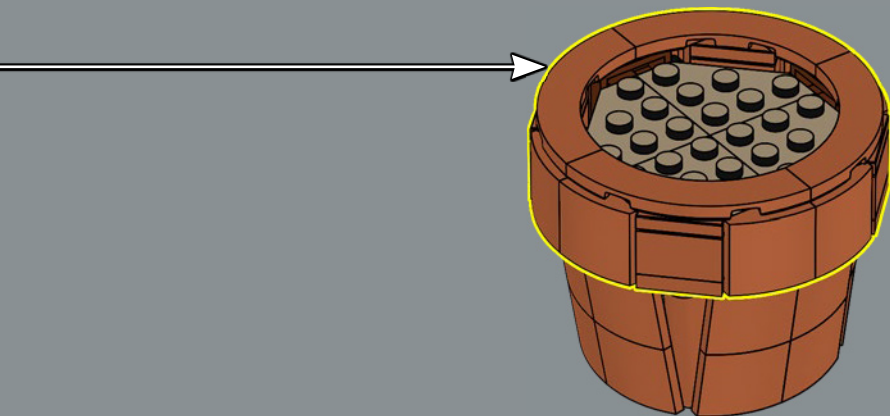

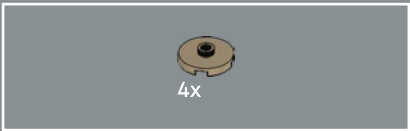

18

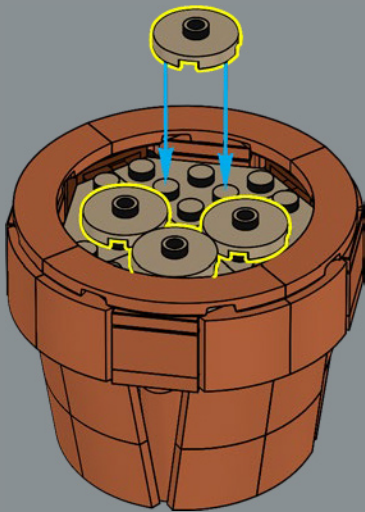



4x

19

Nothing is more refreshing than a pitcher of digestive enzymes!
The cups of these plants are filled with digestive juices to break
down the unfortunate insects that fall in.

To prevent accidental activations, two sensor hairs need to be
triggered before the trap closes.

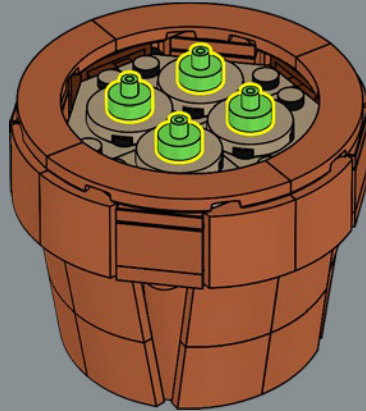



20

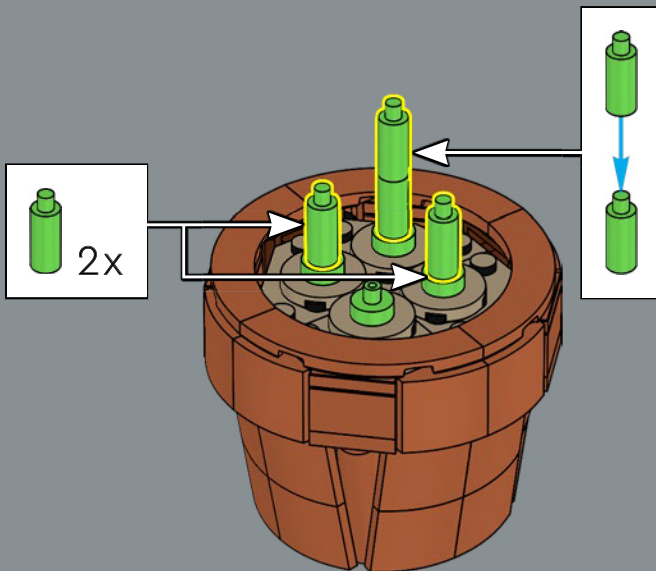



Interesting elements alert: These pitcher plants use an explorer helmet in bright spring green for the opening of the pitcher, and a lime green broom head for the stalk.



21

1

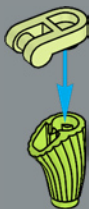

2



3



4



4x

Surprisingly, the leaf that grows above the pitcher cannot move and seal the pitcher. Instead, it prevents rain from entering and diluting the liquid within.

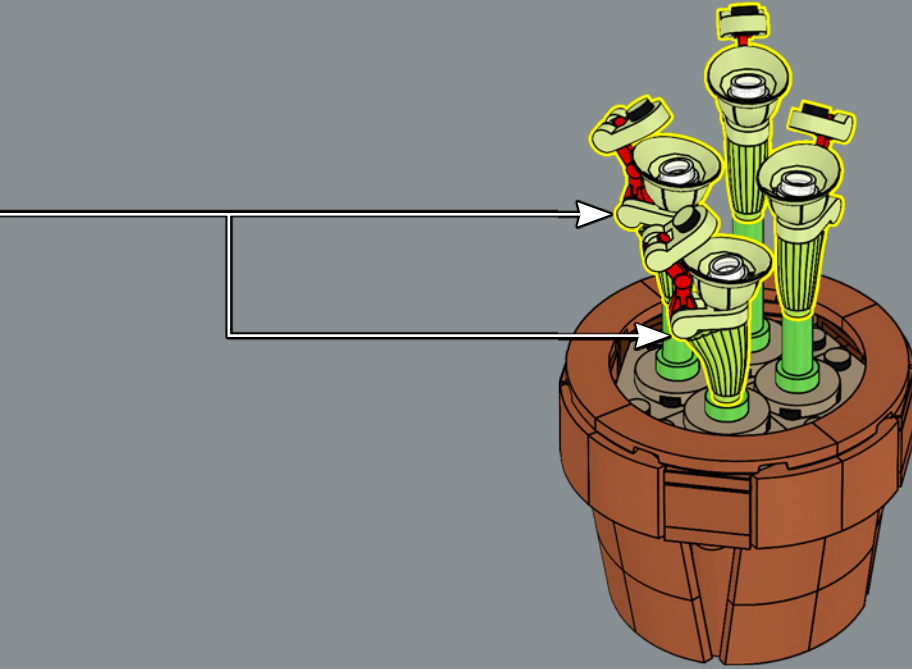



LEGO and the LEGO logo are trademarks of the LEGO Group. ©2024 The LEGO Group. 6494682