



CITY

60428



Q LEGO® Builder



LEGO.com/sustainable-packaging



FR
DONNEZ
OU
RECYCLEZ

 OU  OU 

ASSOCIATION MAGASIN DÉCHÈTERIE

Adresses sur quefairedemesdechets.fr



BUILDER



Apple and the Apple logo are trademarks of Apple Inc., registered in the U.S. and other countries and regions. App Store is a service mark of Apple Inc. Google Play and the Google Play logo are trademarks of Google LLC. Tencent and the Tencent logo are trademarks of Tencent Inc.



EN Ask parents' permission before going online | **DE** Eltern um Erlaubnis bitten, bevor du online gehst | **FR** Demande l'autorisation d'un parent avant d'aller en ligne | **IT** Chiedi il permesso ai tuoi genitori prima di andare online | **ES** Pídeles permiso a tus papás antes de conectarte a Internet | **PT** Pede autorização aos pais antes de acederes online | **ZH** 上网前应先征得父母的同意 | **PL** Poproś rodziców o zgodę, zanim wejdiesz do Internetu | **CS** Než půjdeš na internet, požádej rodiče o svolení | **SK** Skôr než pôjdeš na internet, vypýtaj si povolenie od rodičov | **HU** Kérj szülői engedélyt, mielőtt online csatlakoznál! | **RO** Cere permisiunea părinților înainte de a te conecta online | **BG** Поискайте разрешение от родител, преди да влезете онлайн | **LV** Pirms došanās tiešsaistē palūdz atļauju vecākiem | **ET** Enne Interneti kasutamist küsi vanematelt luba | **LT** Prieš prisijungdami prie interneto, atsiklauskite tėvų





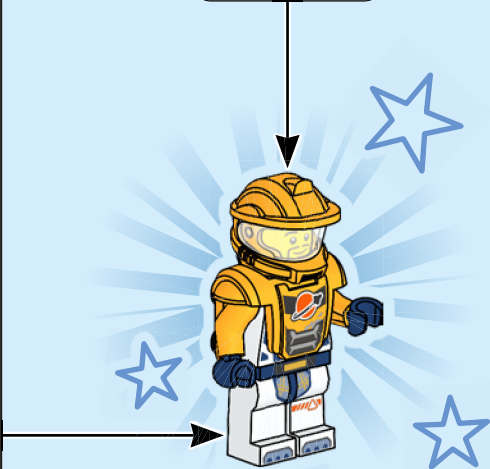
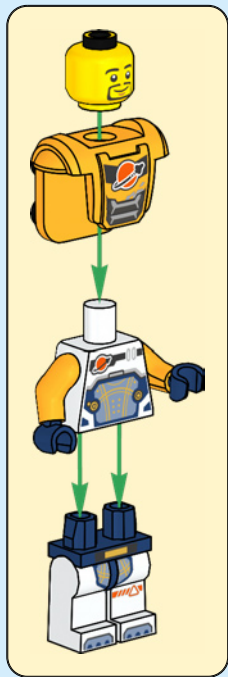

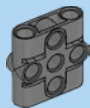

1x

1

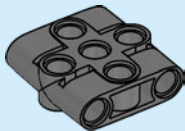

6





3x

2

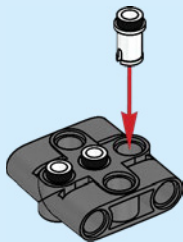

1x

3

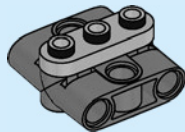



1x



1x

4

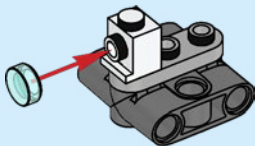

8



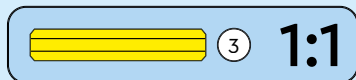
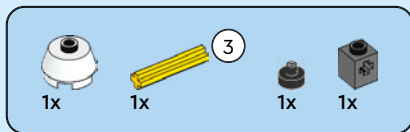

5

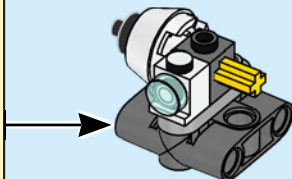
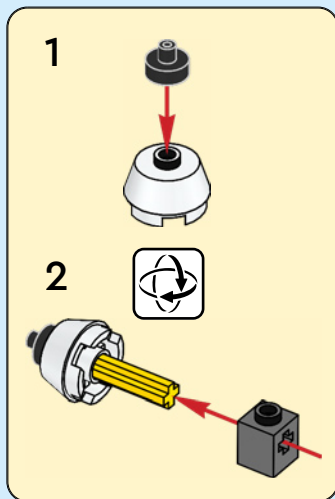

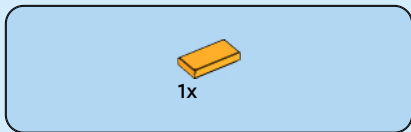

6

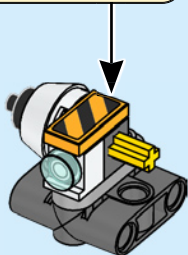
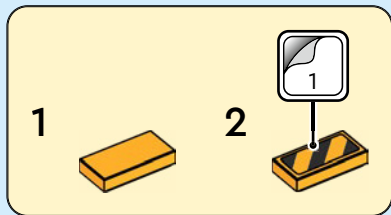

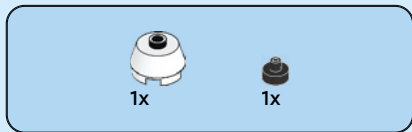

7

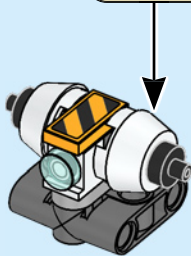
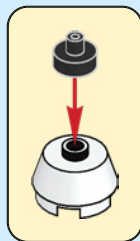



8

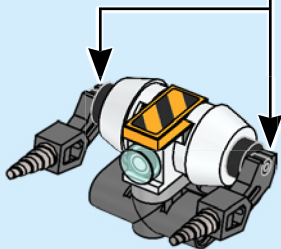
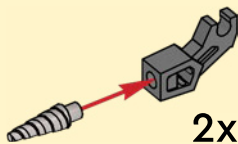

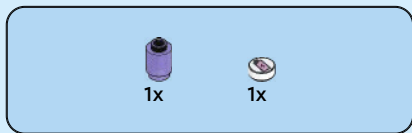

9

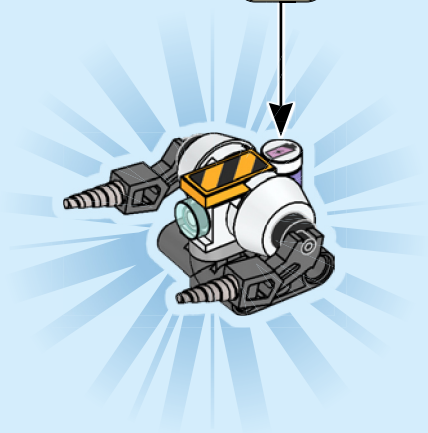
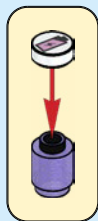



1x



1x

1

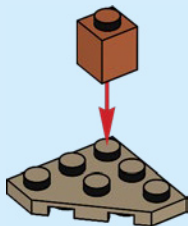



1x



1x

2

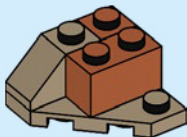

1x

3

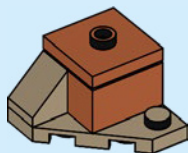



1x

4

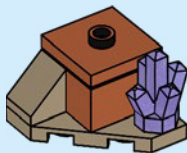



1x



1x

5

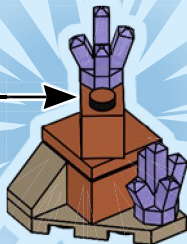
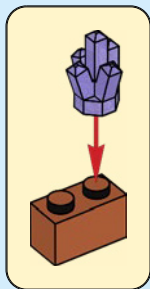

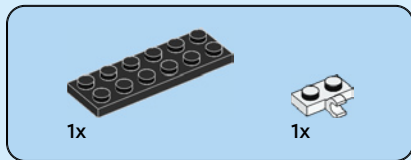
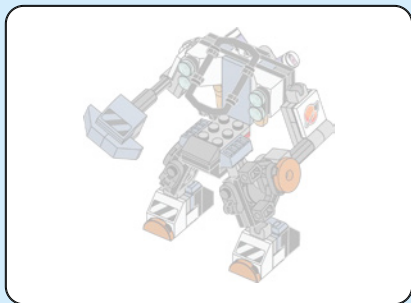

1

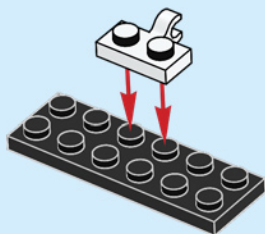

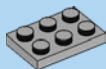

1x

2

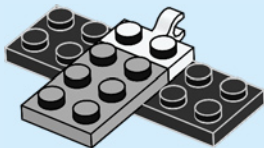

2x



2x

3

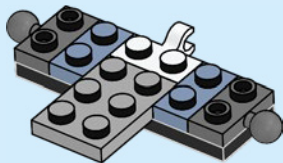

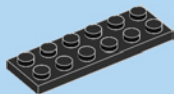

1x

4

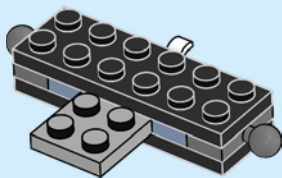



1x



2x

5

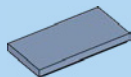
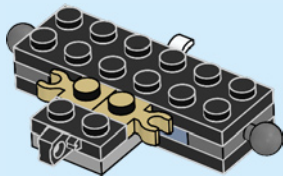

1x

6

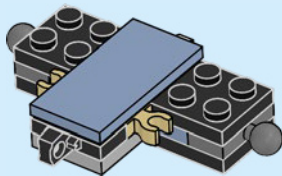



2x

7

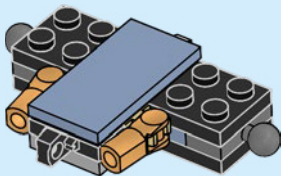

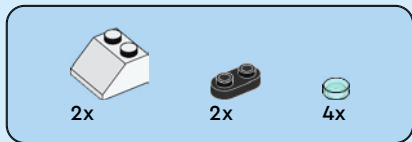

8

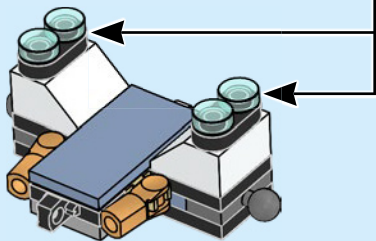
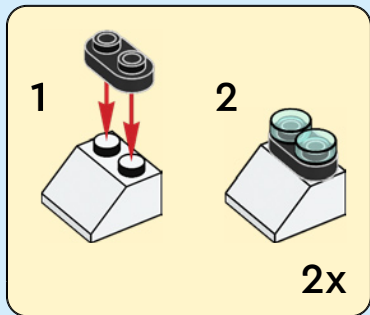



1x



1x

9

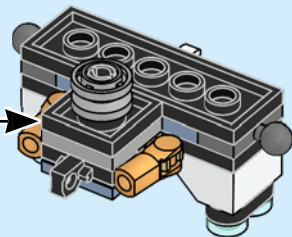
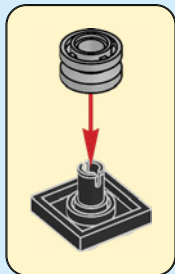



1x

10

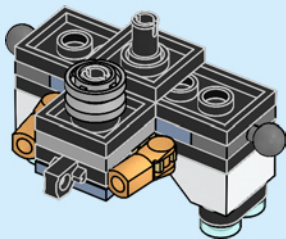



1x



2x



2x

11

1

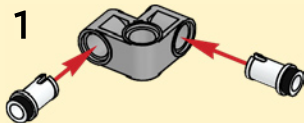

2

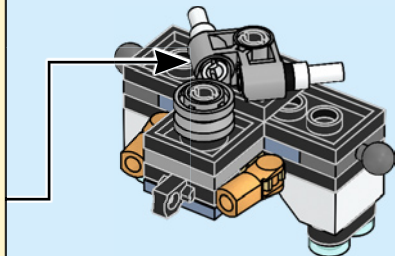
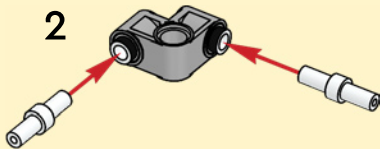

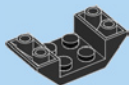

1x

12

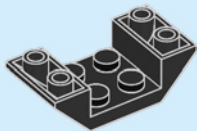



2x

13

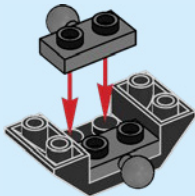

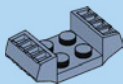

1x

14

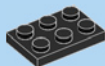
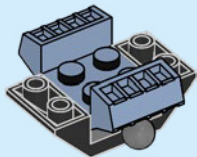

1x



1x

15

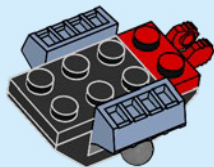

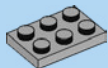

1x



1x

16

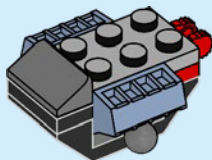

17

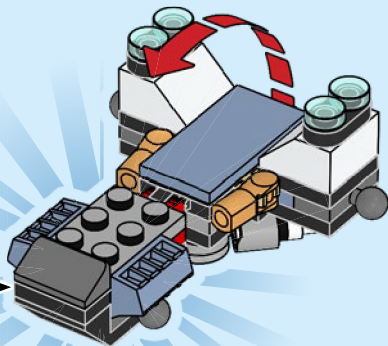
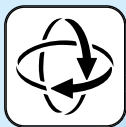



2x



2x

18

1



2

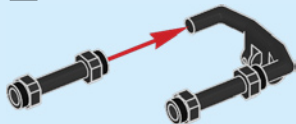

3

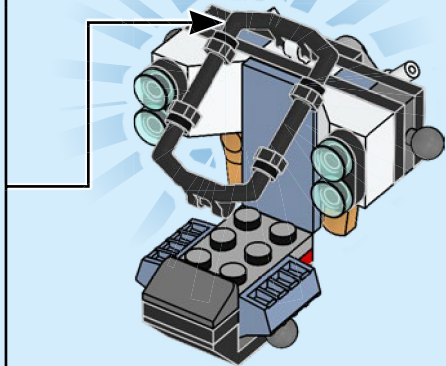
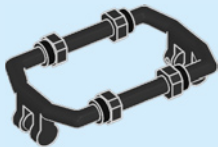



1x



1x

19

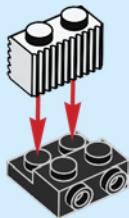



1x

20

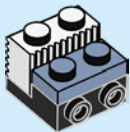

1x

21

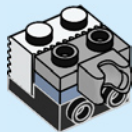



1x



1x

22

1

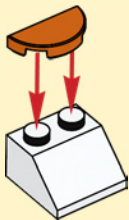

2





1x

23

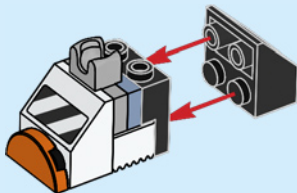
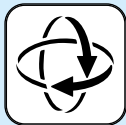

1x

24

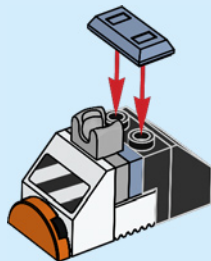

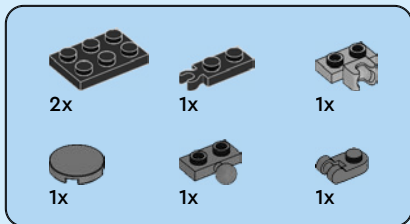

25

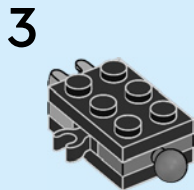
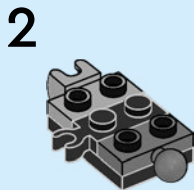
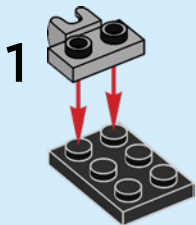

4

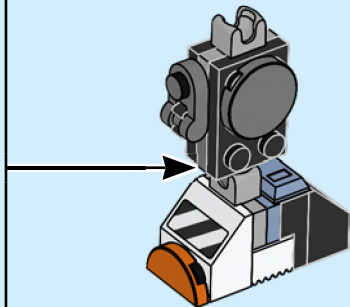
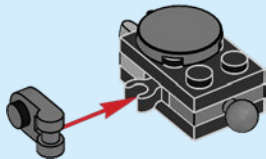

26

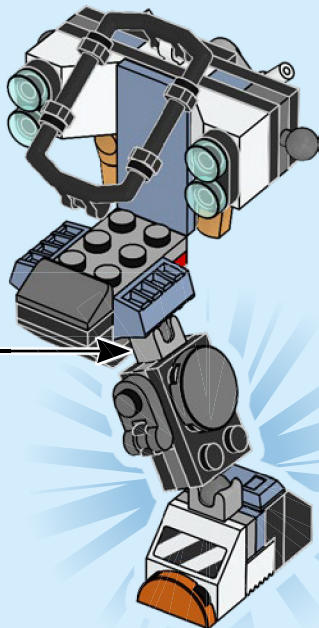



1x



1x

27

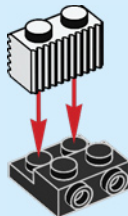



1x

28

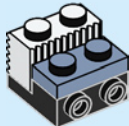



1x

29

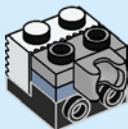



1x



1x

30

1

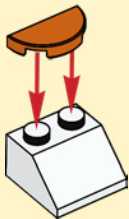

2





1x

31

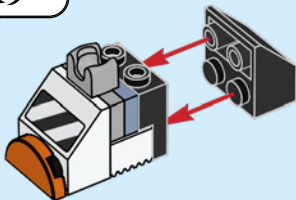
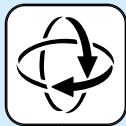

1x

32

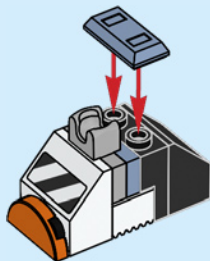

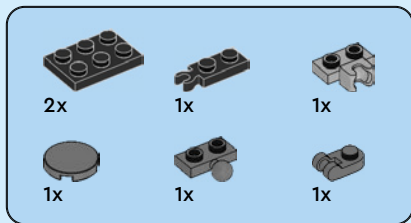

33

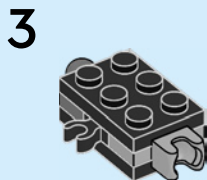
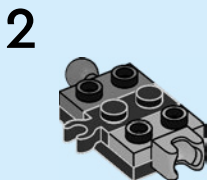
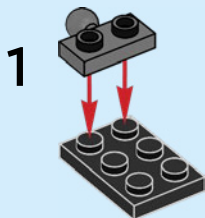

4

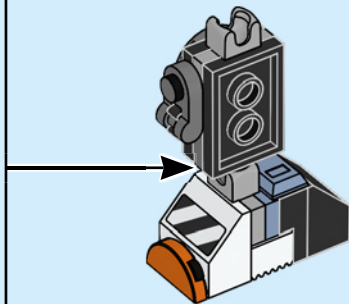
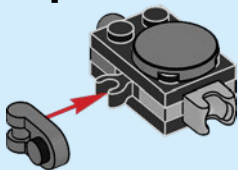

34

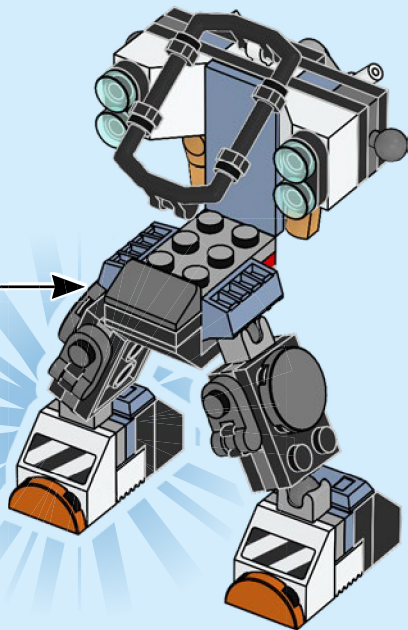

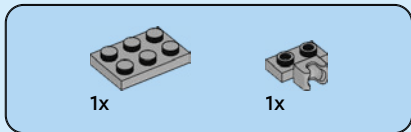
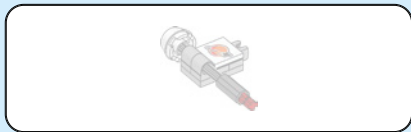

35

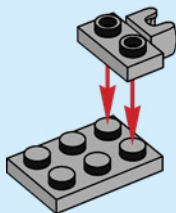



2x

36

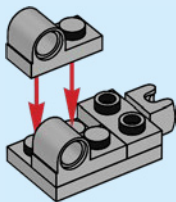



1x

37

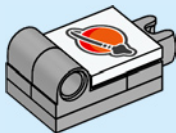

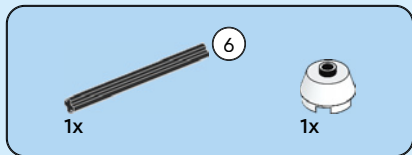

38

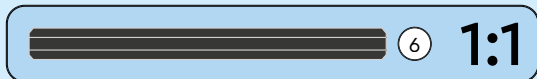
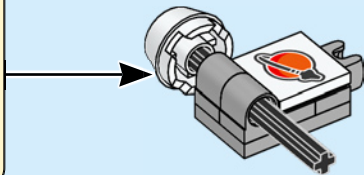
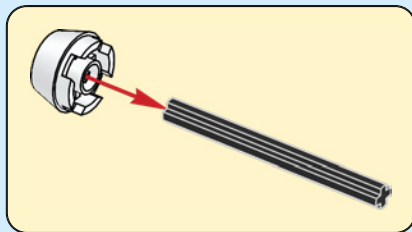



1x



1x

39

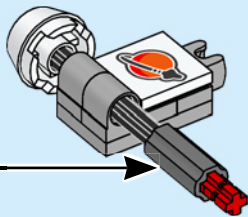
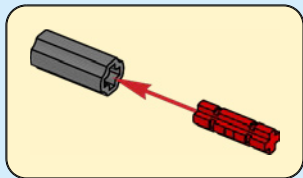

40

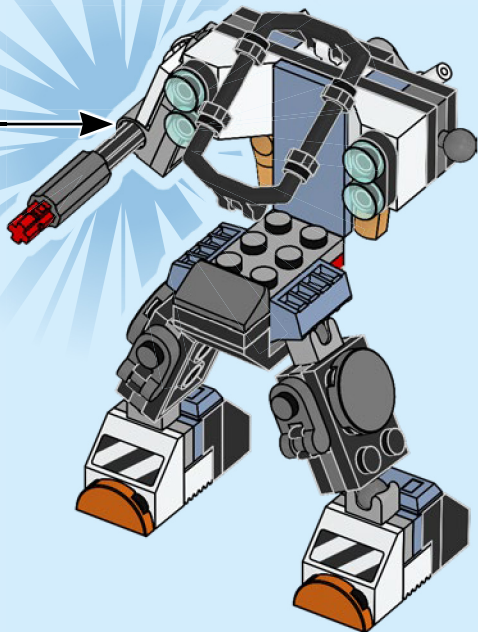



1x



1x



1x



1x



2x

41

1

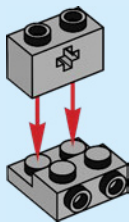

2

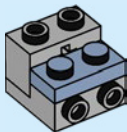

3

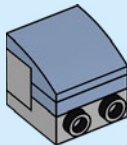

4

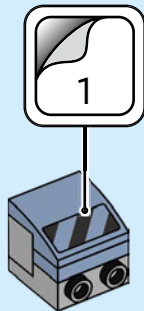

5

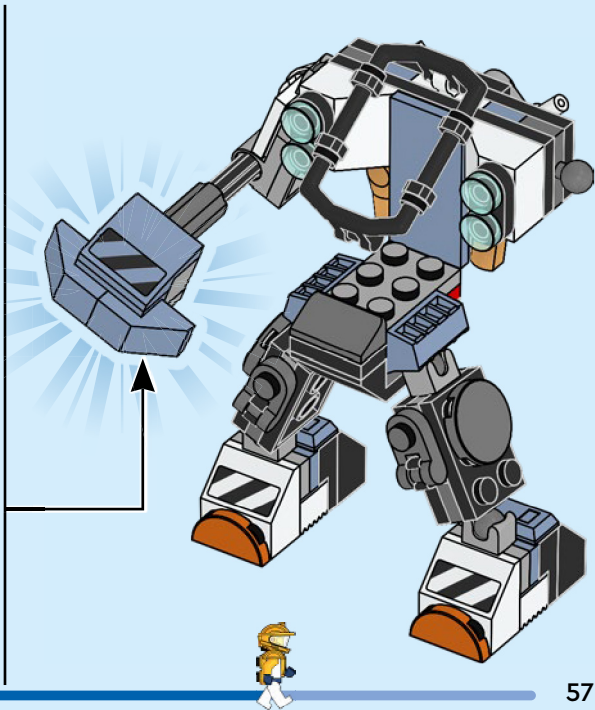
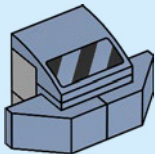

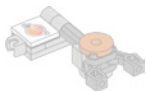

1x



1x

42

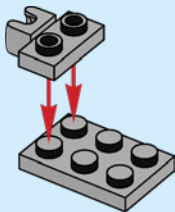



2x

43

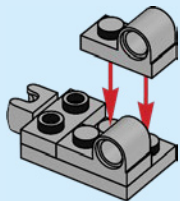

1x

44

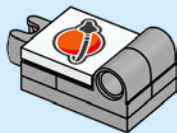

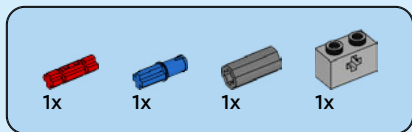

45

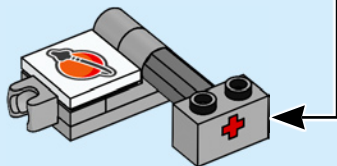
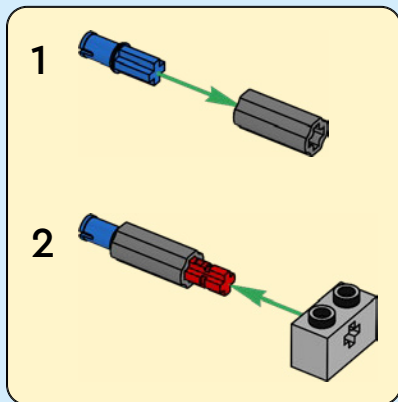



1x

46

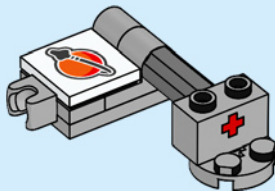



1x

47

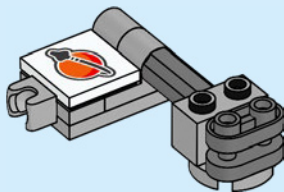



1x

48

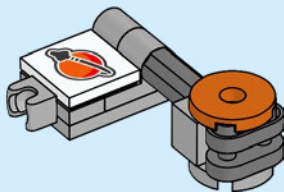



2x

49

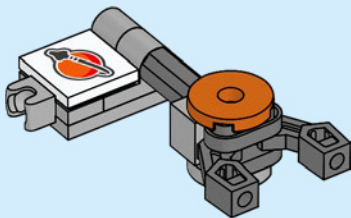

50

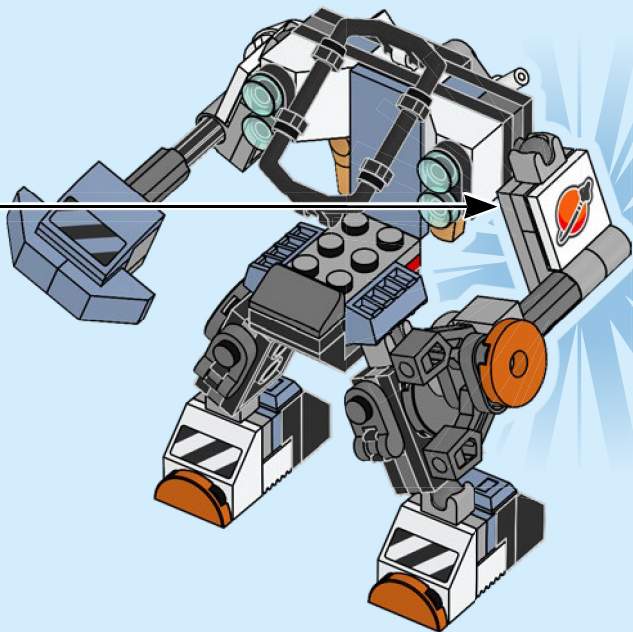

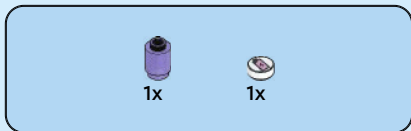

51

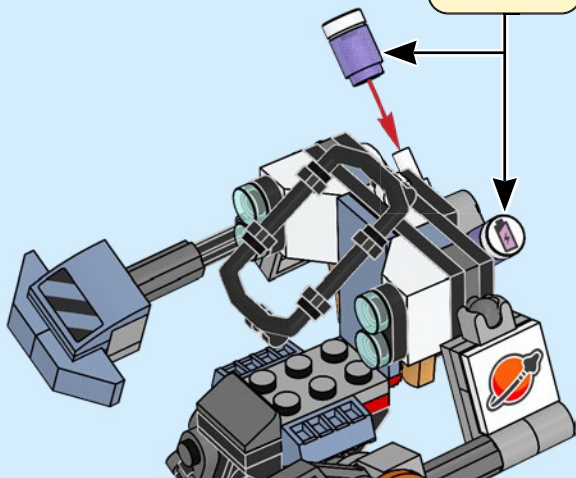
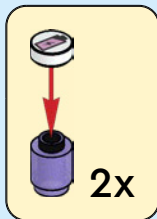

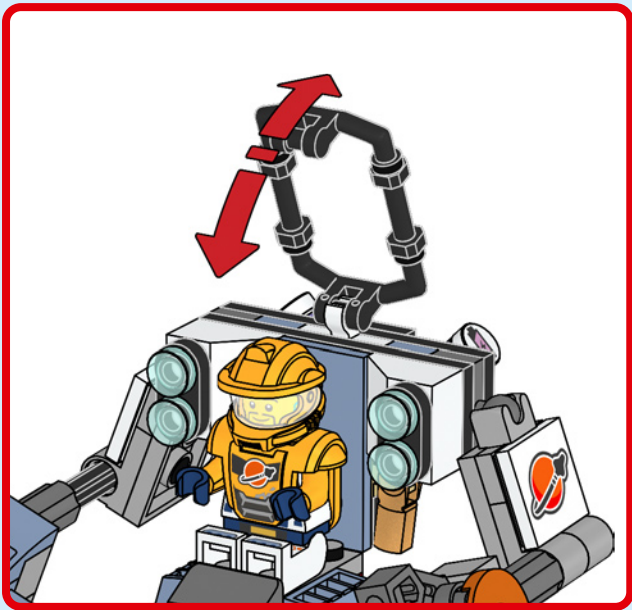





CITY

SPACE



60430



60433



60431

60434



Space
Weltraum
L'espace

Spazio
Espacio
Espaceo

太空
Kosmos
Vesmír

Világűr
Spațiu
Kosmos

Kosmos
Erdvé



3x
6465627



5x
6388018



1x
407001



2x
6357680



3x
4649167



2x
287701



1x
6313115



4x
303901

70



2x
6465626



1x
6473469



2x
6352222



2x
4142865



1x
6266205



1x
6462019



1x
4622062



1x
6465625



2x
6331084



2x
6186675



2x
6210270



1x
6266244



2x
6350725



2x
6425507



2x
6328479



2x
6469445



2x
6078610



5x
302126



1x
4188534



1x
370626

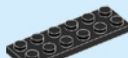

2x
379526



1x
6254484



2x
4579659



1x
6315197



1x
6244787



5x
6274739



5x
6198156



2x
6372479



2x
6248952



1x
6166865



1x
6405003



1x
6124349



1x
4211758



1x
4211880



1x
4211475



6x
6043656



4x
6225230



2x
6206249



1x
6446028



1x
6469440



4x
4211396



1x
6362259



1x
6390673



2x
6388119



1x
4567887



2x
6056296



2x
4516546



4x
6276870



6x
6039479



1x
6317653



1x
4206482



1x
6419095



1x
6130007



2x
6474749



1x
6471811



2x
6296657



1x
4530678



1x
6038637



1x
6465624



2x
6214214



3x
6464814



2x
6442192

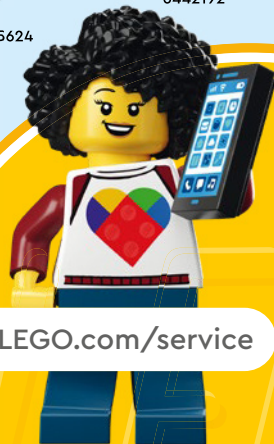

[LEGO.com/service](https://www.LEGO.com/service)

YOU COULD

WIN



Scan this QR code or go to
LEGO.COM/PRODUCTFEEDBACK and give us
your short feedback about this LEGO® set
for a chance to win a cool LEGO prize.

Terms and Conditions apply*

EN: YOU COULD WIN. Terms and Conditions apply* **DE: Du könntest GEWINNEN.** Es gelten die Teilnahmebedingungen* **FR: Tu pourrais GAGNER.** Des conditions s'appliquent* **IT: Potresti VINCERE tu.** Termini e condizioni sono applicabili* **ES: Puedes GANAR.** Aplican términos y condiciones* **PT: Poderá GANHAR.** Aplicam-se termos e condições* **ZH: 轻松获奖.** 条款和条件适用* **PL: Szansa na WYGRANĄ.** Obowiązują warunki korzystania* **CS: Máte šanci VYHRÁT.** Platí všeobecné smluvní podmínky* **SK: Máte šancu VYHRÁT.** Platia všeobecné zmluvné podmienky* **HU: TE IS NYERHETSZ.** Felhasználási feltételek érvényesek* **RO: Ai putea CÂȘTIGA.** Se aplică termenii și condiții* **BG: Можете да СПЕЧЕЛИТЕ.** Има определени правила и условия* **LV: Tu vari LAIMĒT.** Ir spēkā noteikumi un nosacījumi.* **ET: Sul on võimalus VÕITA.** Kehtivad tingimused* **LT: Jūs galite LAIMĖTI.** Taikomos sąlygos*

*[LEGO.com/productfeedback-terms](https://www.lego.com/productfeedback-terms)

LEGO and the LEGO logo are trademarks of the LEGO Group. ©2024 The LEGO Group.

6492738