



MARVEL

76281



Q LEGO® Builder



LEGO.com/sustainable-packaging



FR
DONNEZ
OU
RECYCLEZ



OU



OU



ASSOCIATION MAGASIN DÉCHÈTERIE

Adresses sur quefairedemesdechets.fr

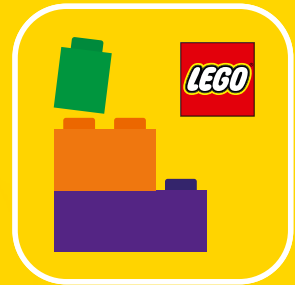

Q LEGO® Builder

BUILDER

Download on the
App Store

GET IT ON
Google Play

腾讯应用宝
安卓应用商店

Apple and the Apple logo are trademarks of Apple Inc., registered in the U.S. and other countries and regions. App Store is a service mark of Apple Inc. Google Play and the Google Play logo are trademarks of Google LLC. Tencent and the Tencent logo are trademarks of Tencent Inc.

Q LEGO.com/devicecheck

EN Ask parents' permission before going online | DE Eltern um Erlaubnis bitten, bevor du online gehst | FR Demande l'autorisation d'un parent avant d'aller en ligne | IT Chiedi il permesso ai tuoi genitori prima di andare online | ES Pídeles permiso a tus papás antes de conectarte a Internet | PT Peça autorização aos pais antes de acederes online | ZH 上网前应先征得父母的同意 | PL Poproś rodziców o zgodę, zanim wejdiesz do Internetu | CS Než půjdeš na internet, požádej rodiče o svolení | SK Skôr než pôjdeš na internet, vypýtaj si povolenie od rodičov | HU Kérj szülői engedélyt, mielőtt online csatlakoznál! | RO Cere permisiunea părinților înainte de a te conecta online | BG Поискайте разрешение от родител, преди да влезете онлайн | LV Pirms došanās tiešsaistē palūdz atļauju vecākiem | ET Enne Interneti kasutamist küsi vanematelt luba | LT Prieš prisijungdami prie interneto, atsilkauskite tėvų

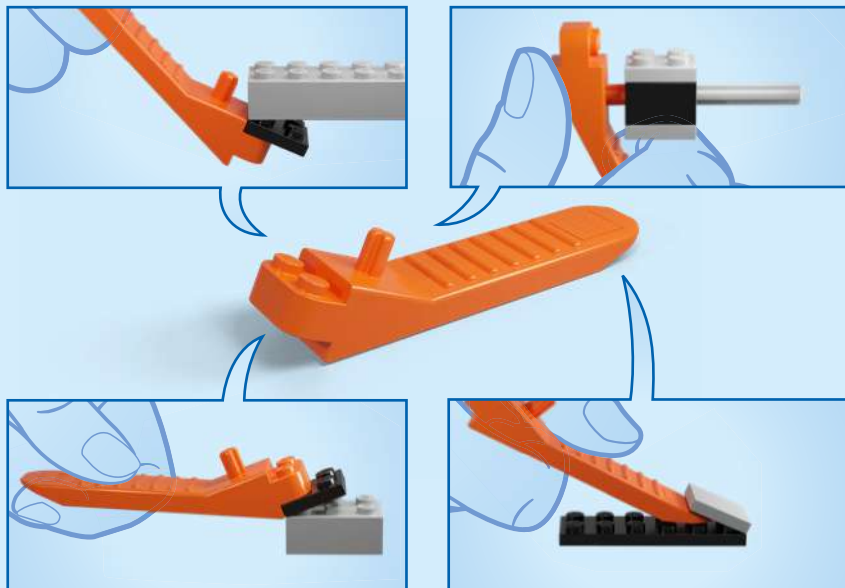

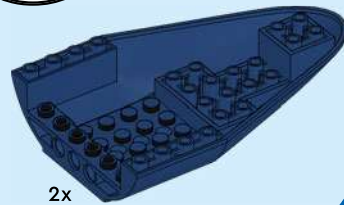
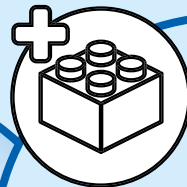
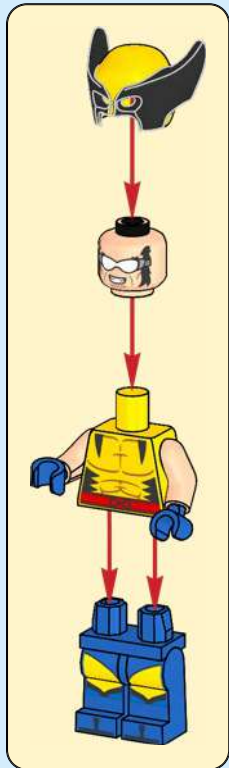

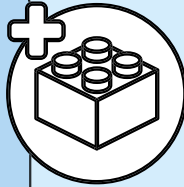
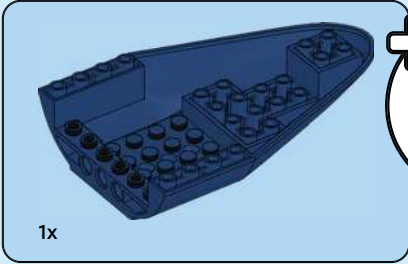
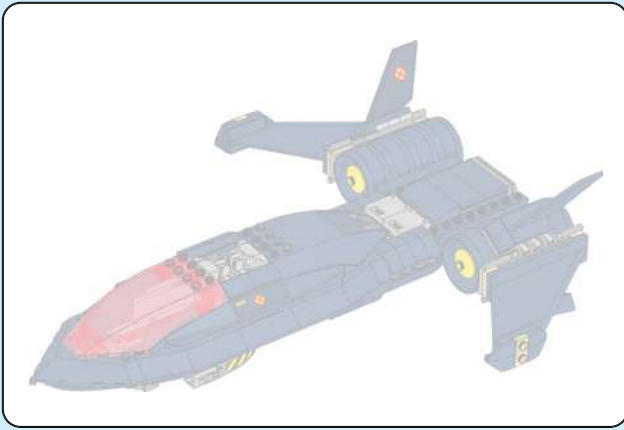

1

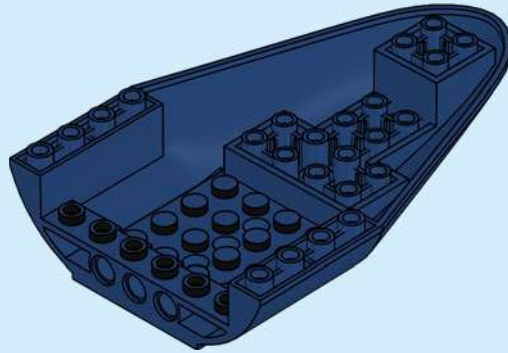



2

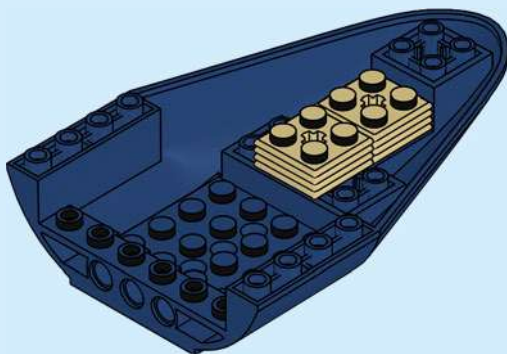

3

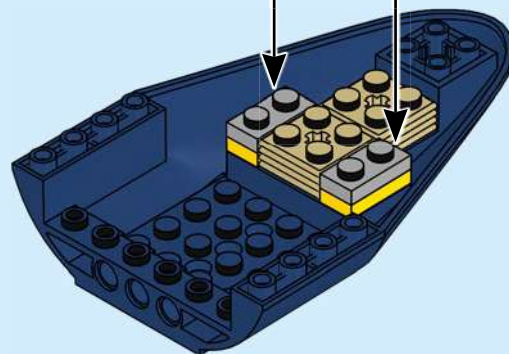
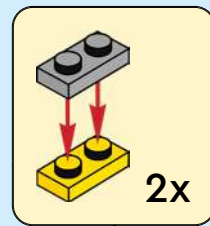



2x

4

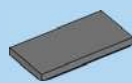
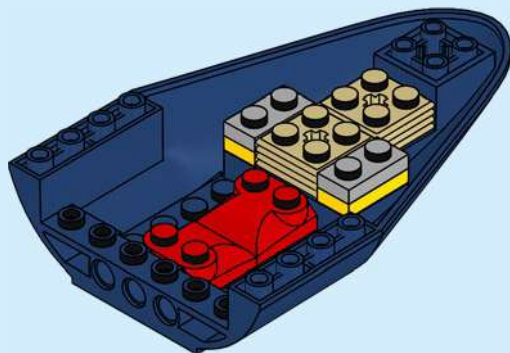

1x

5

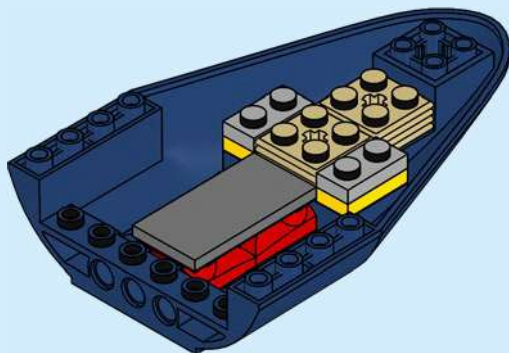

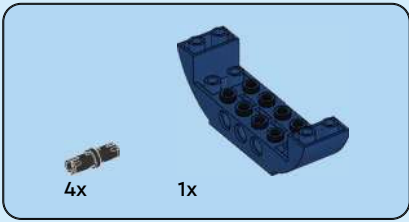

6

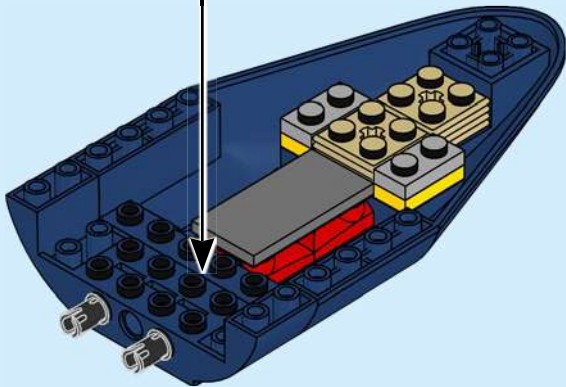
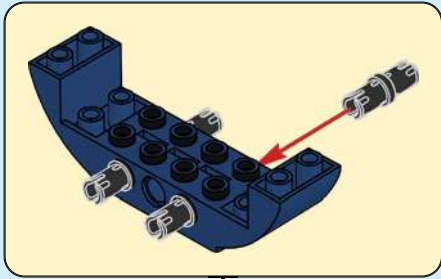

7

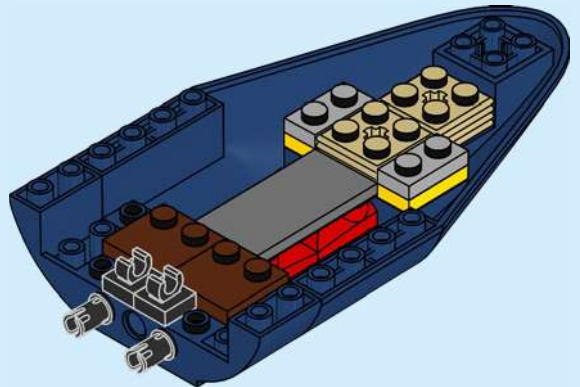

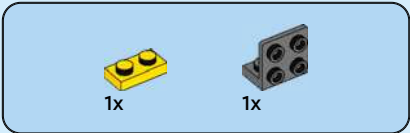

8

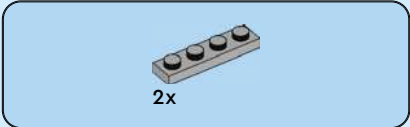
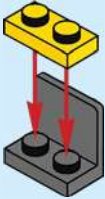

9

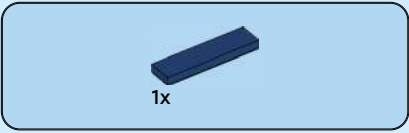
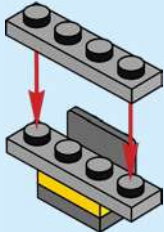

10

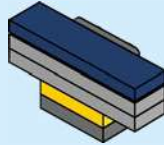

11

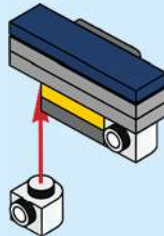

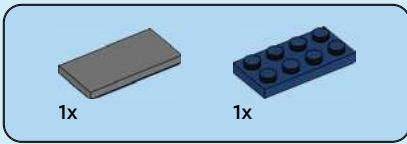

12

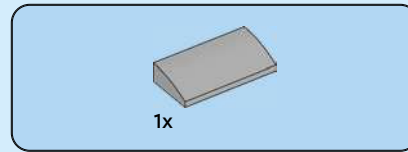
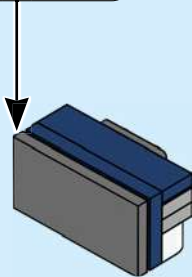
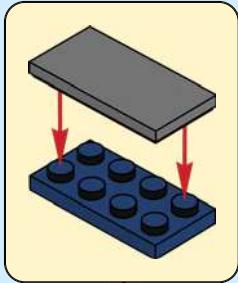

13

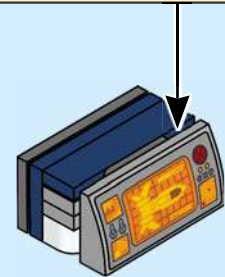
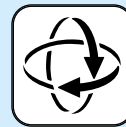
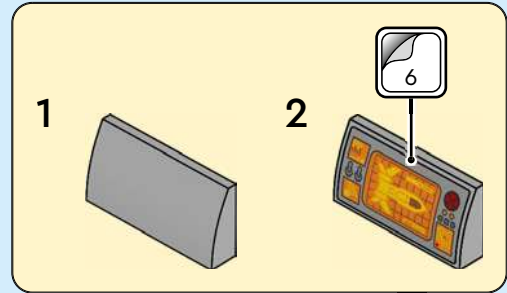

14

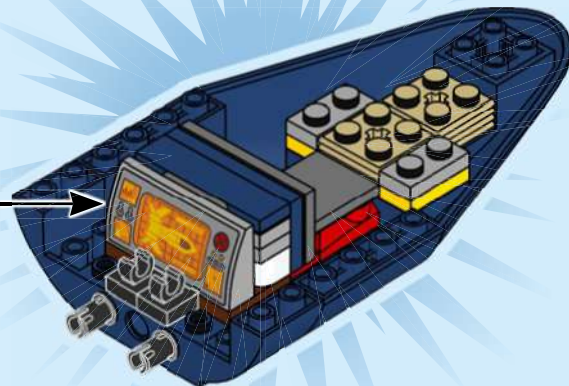

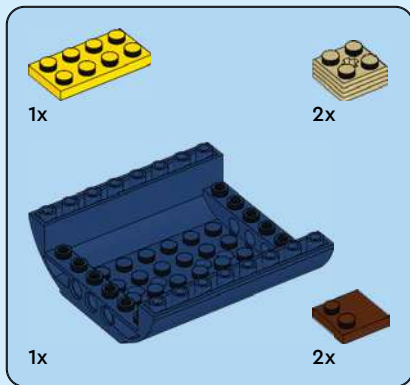

15

1

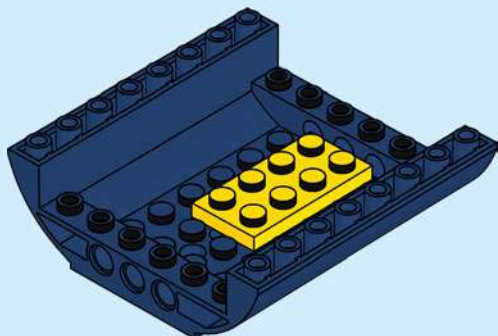

2

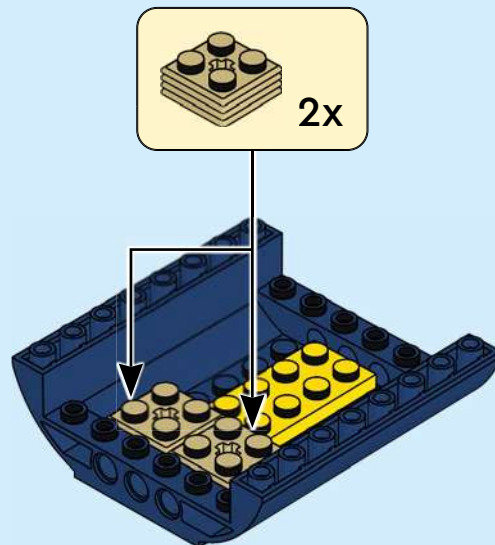

3

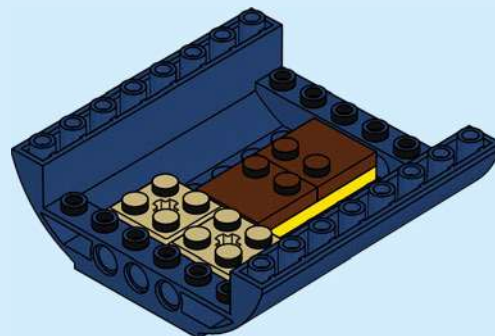

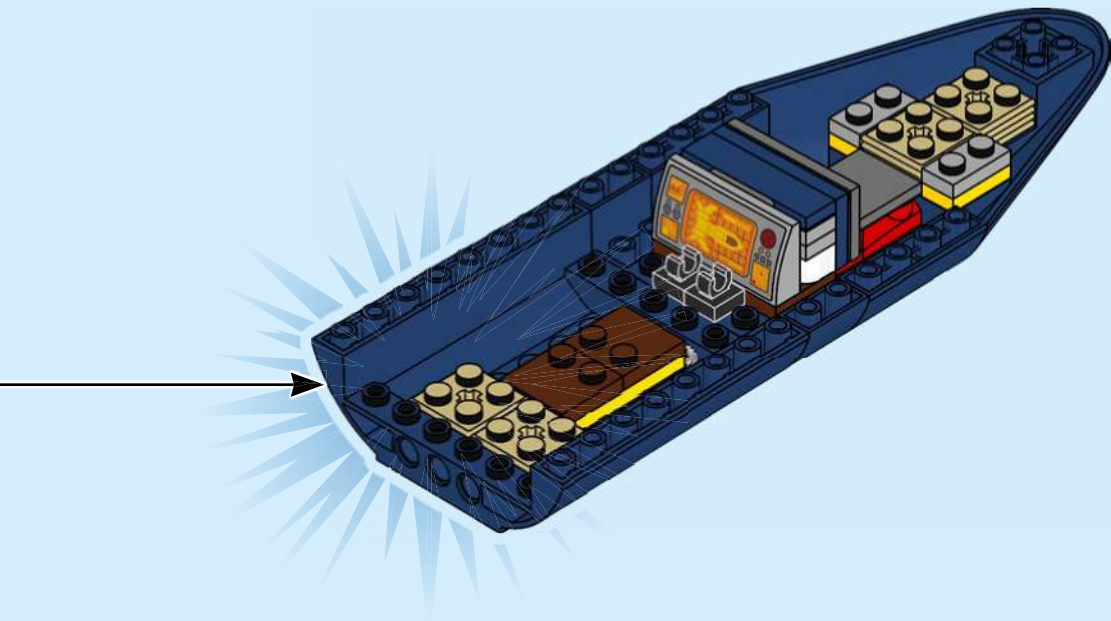

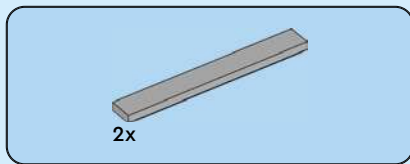

16

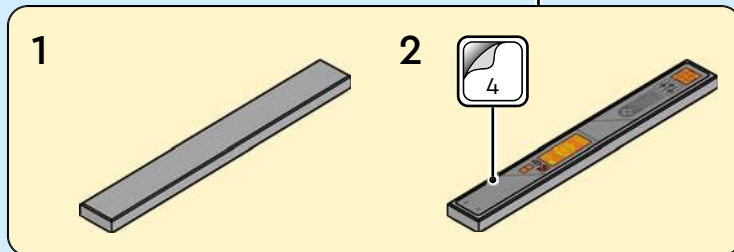
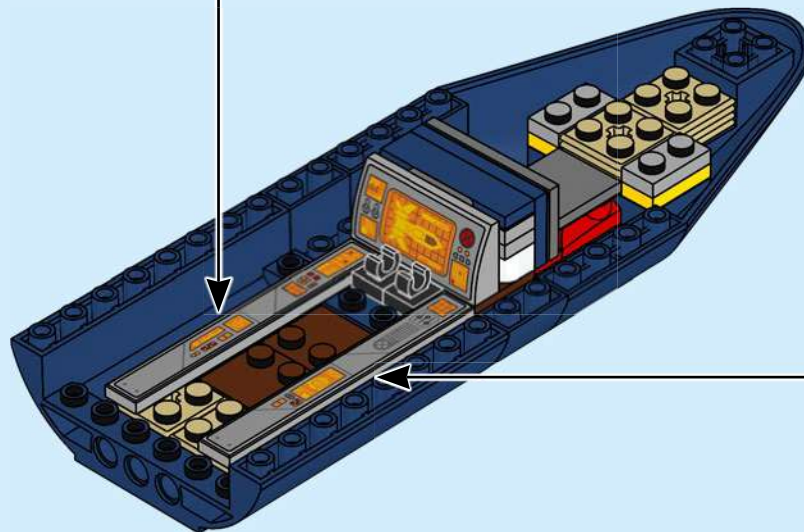
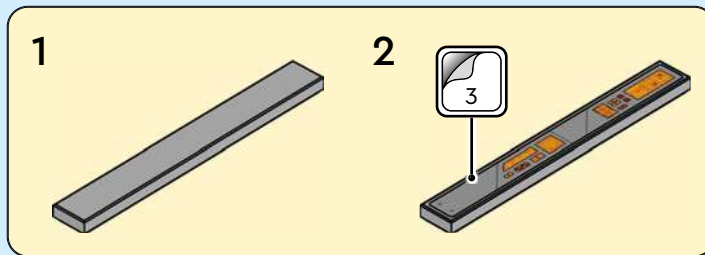

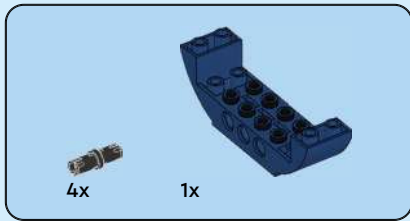

17

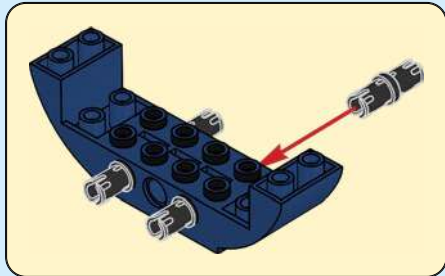

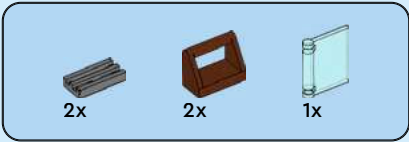

18



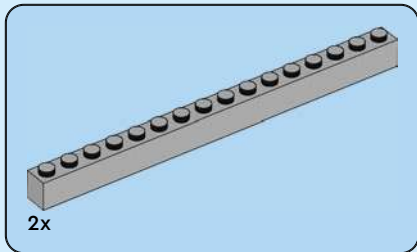

19

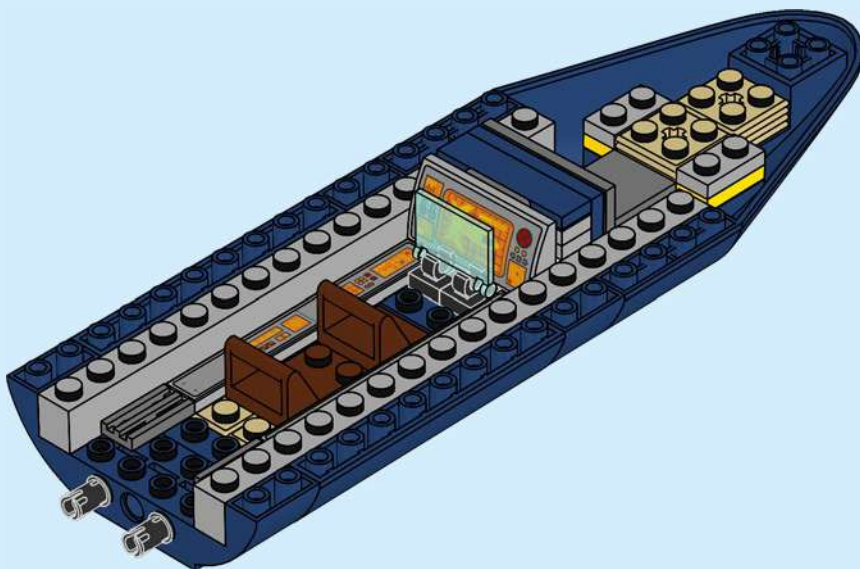

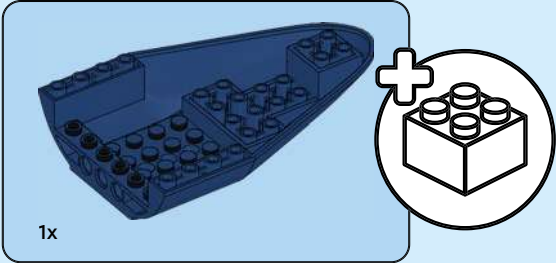
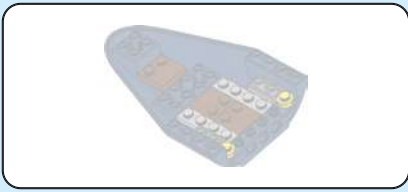

20

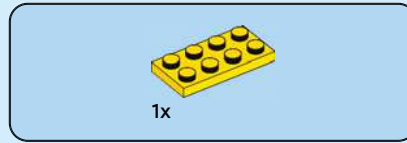
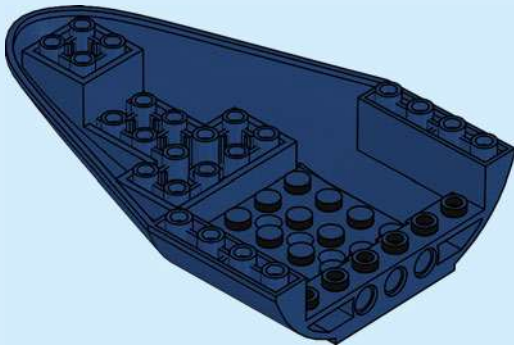

21

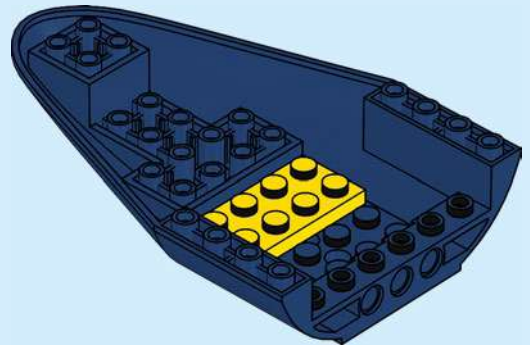

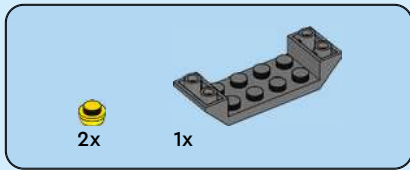

22

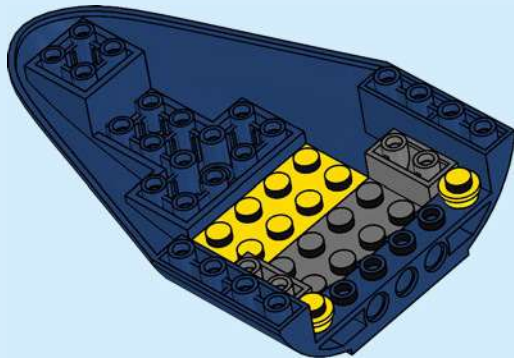

23

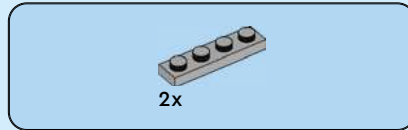
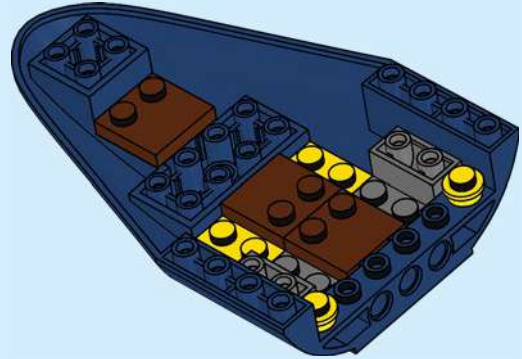

24

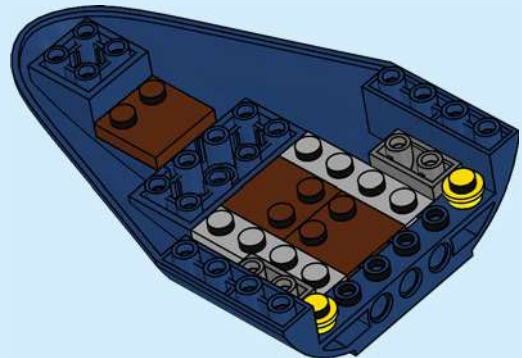

25

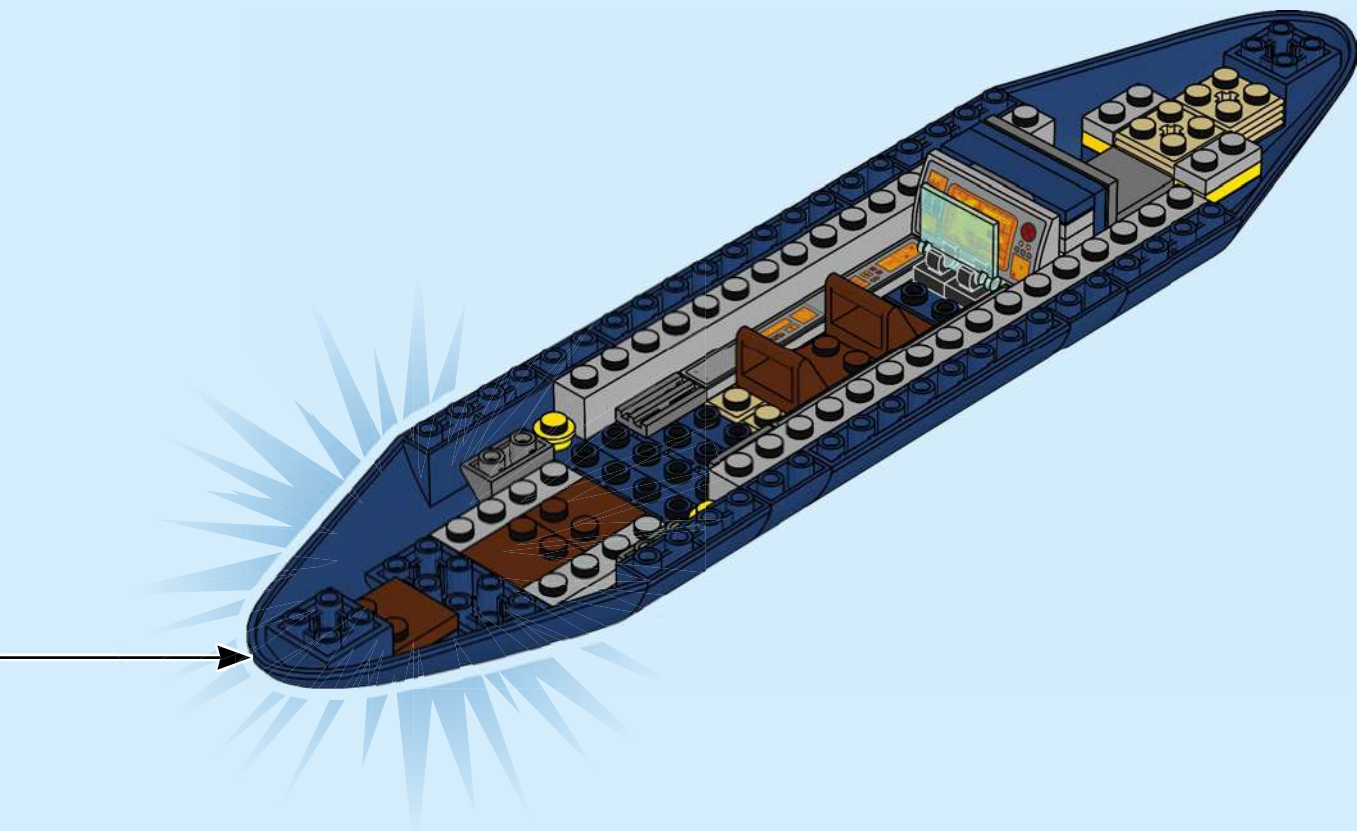

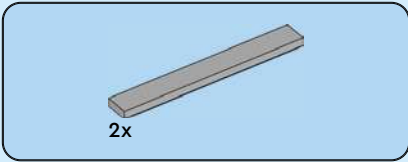

26

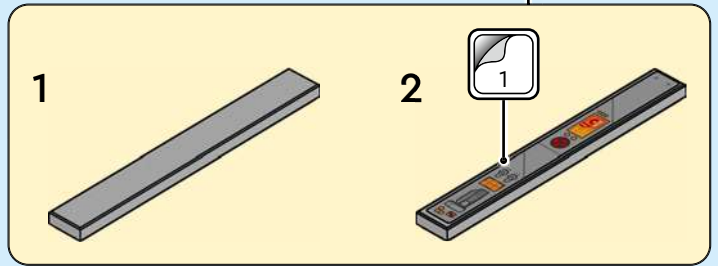
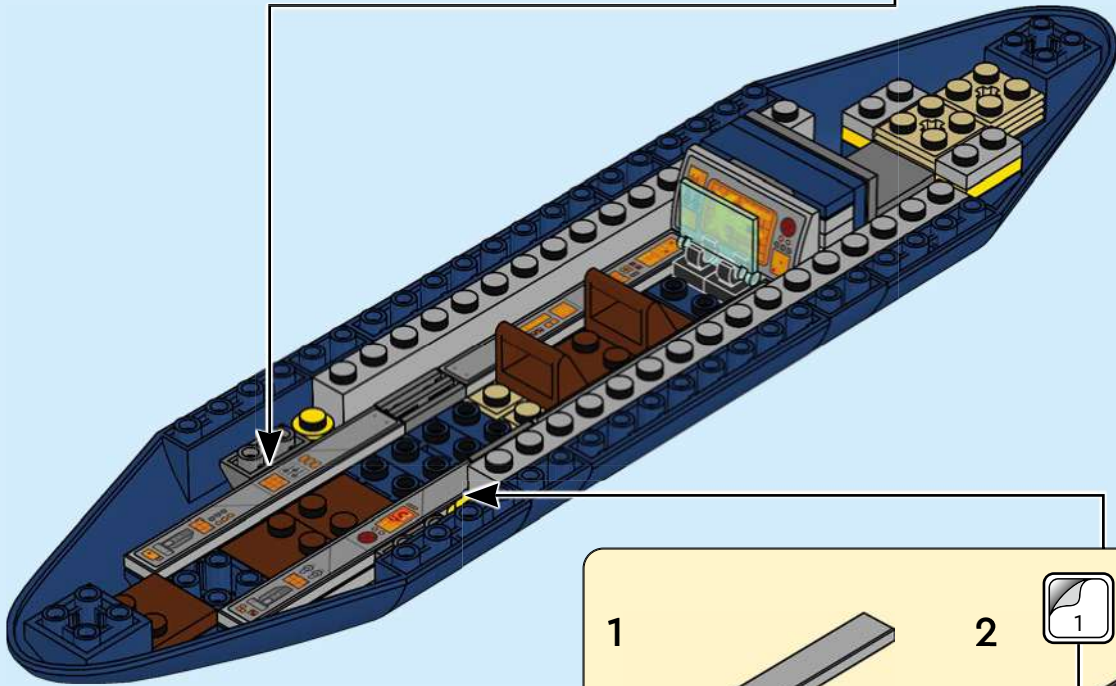
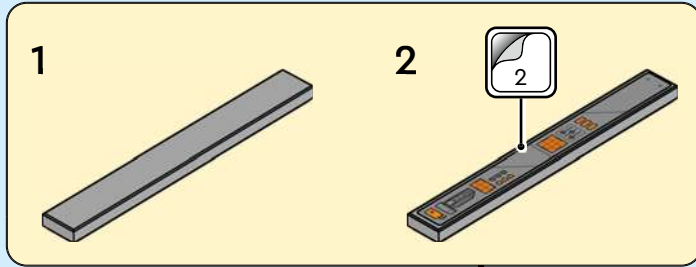

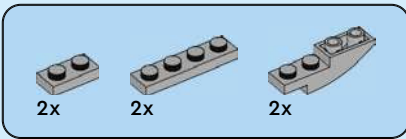

27

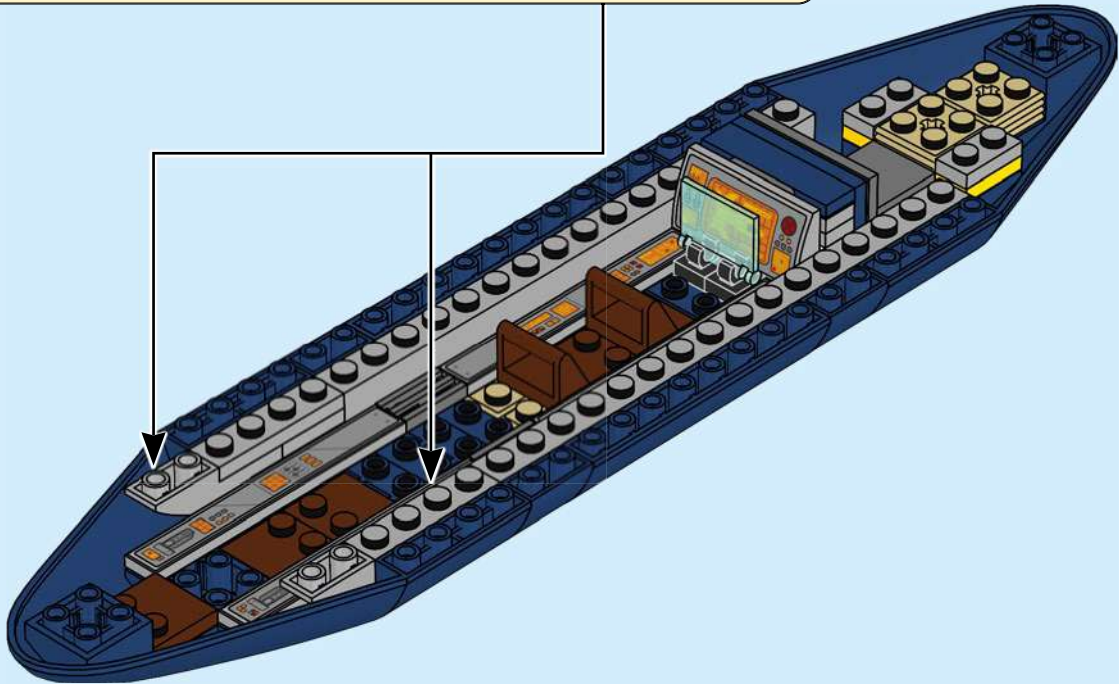
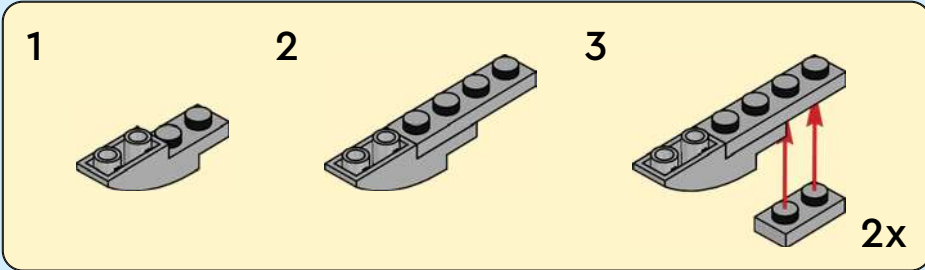

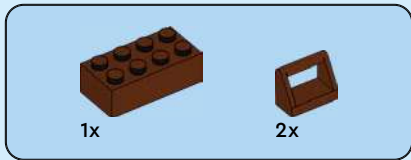

28

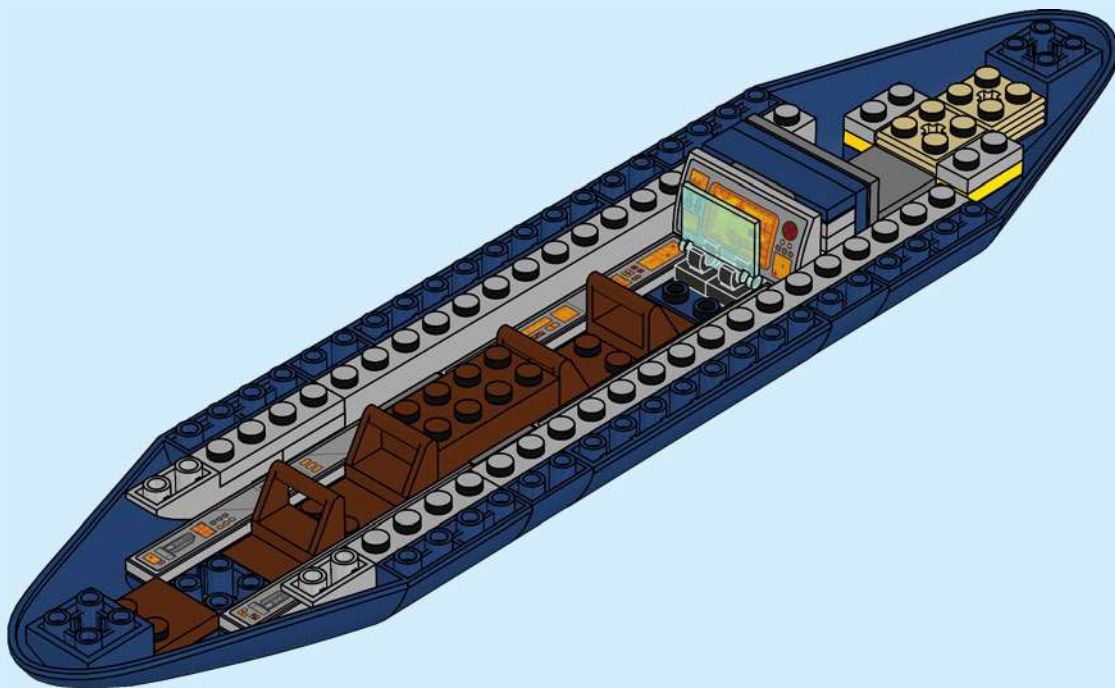

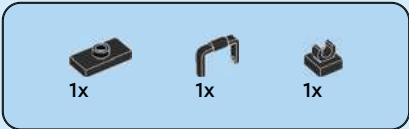

29

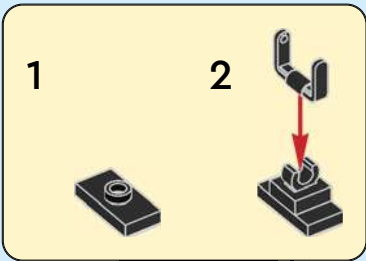

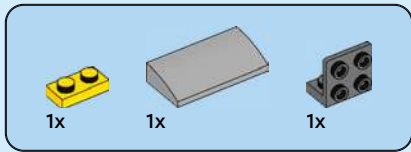

30

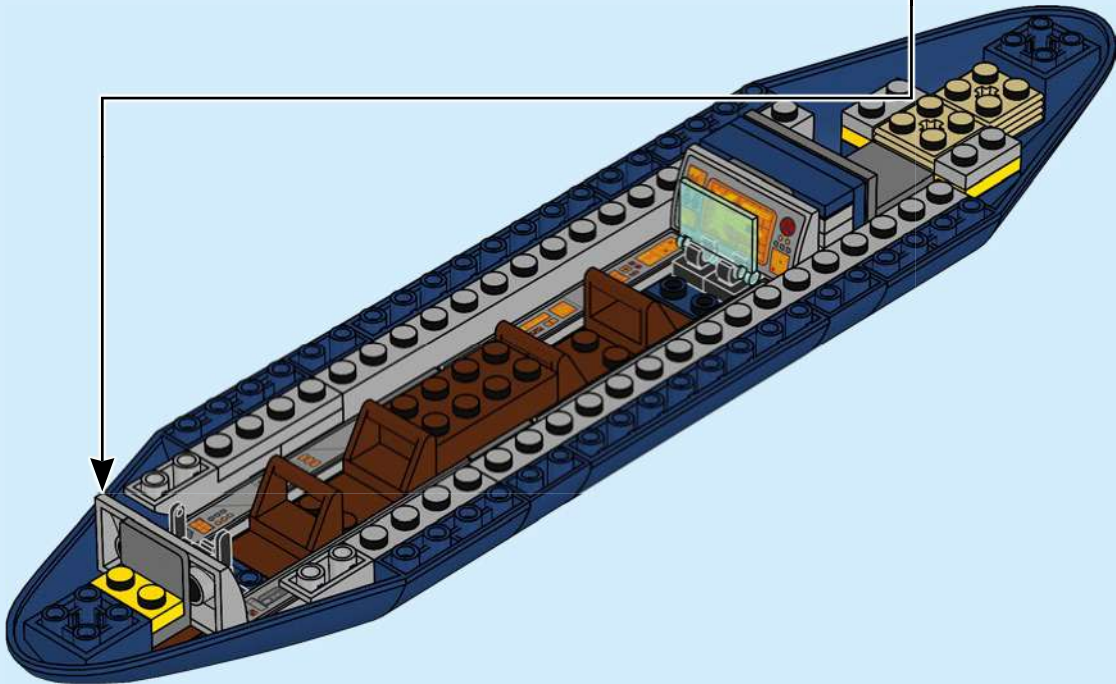
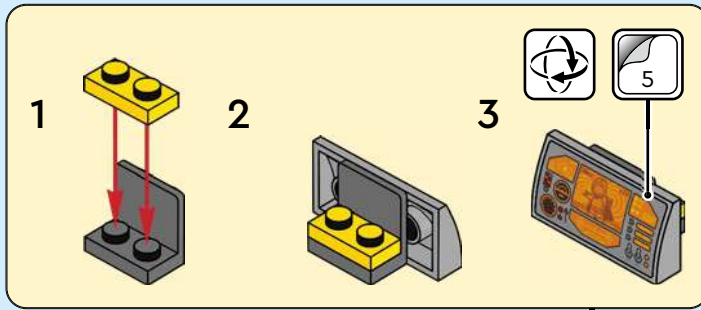

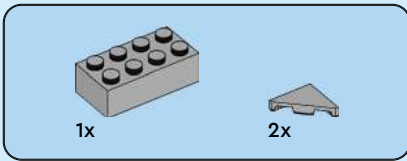

31

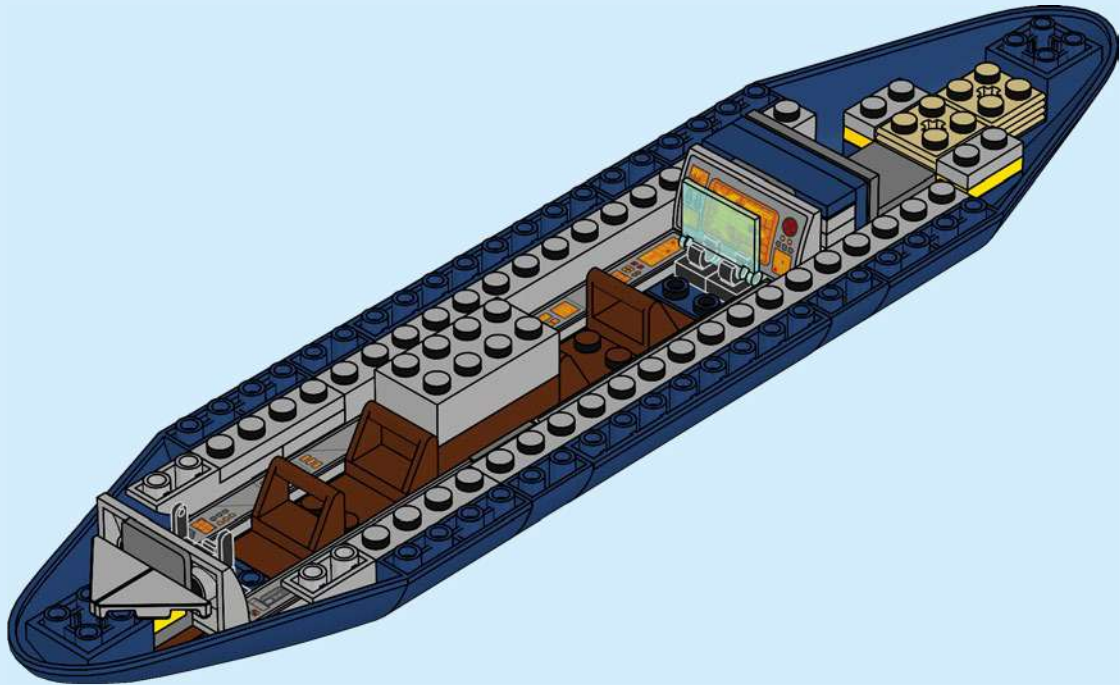



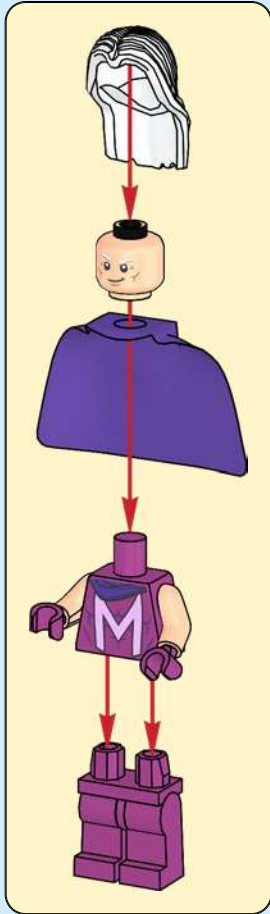

1



2

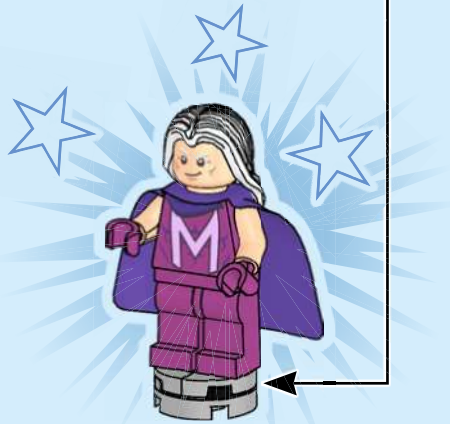



2x

32

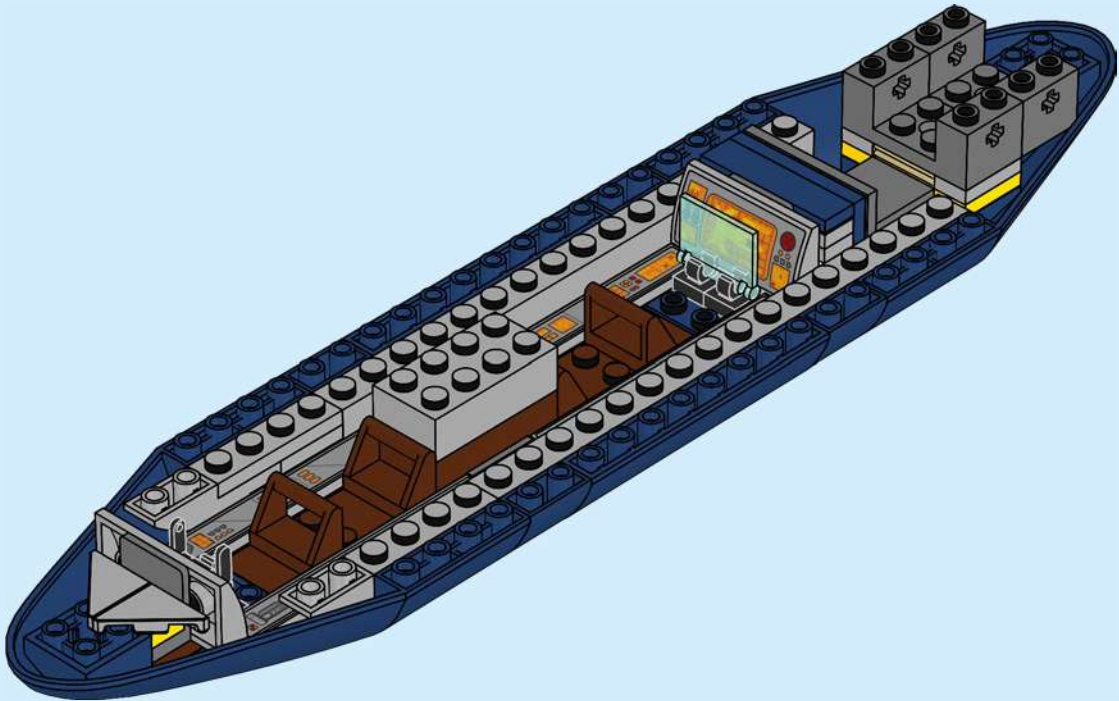

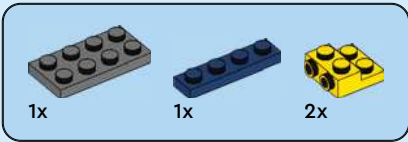

33

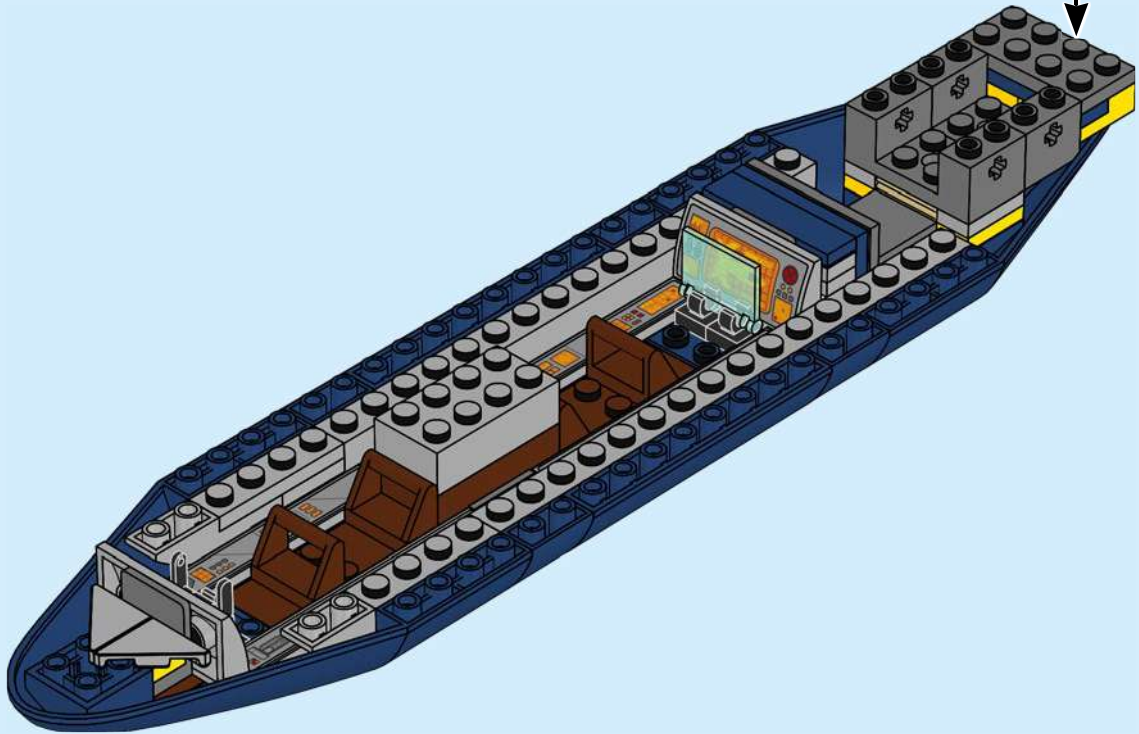
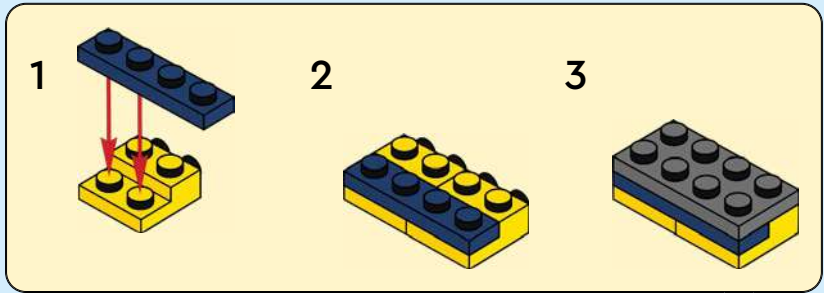

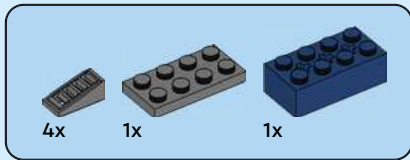

34

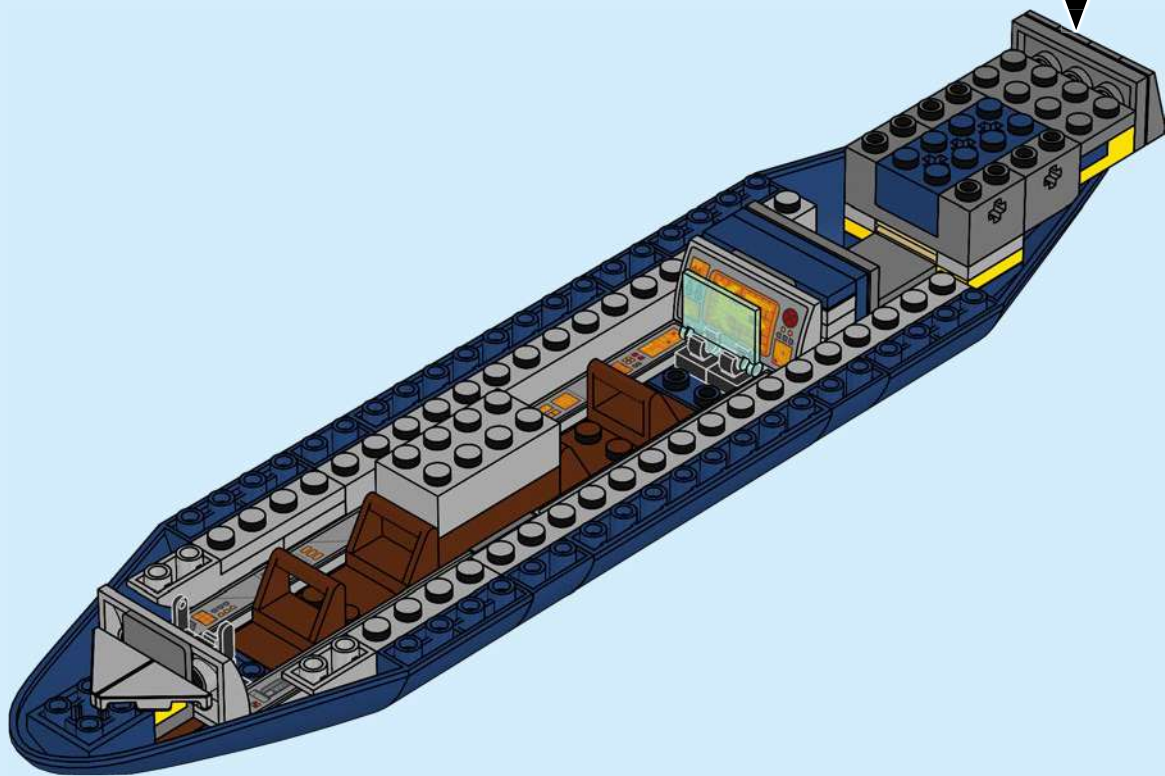
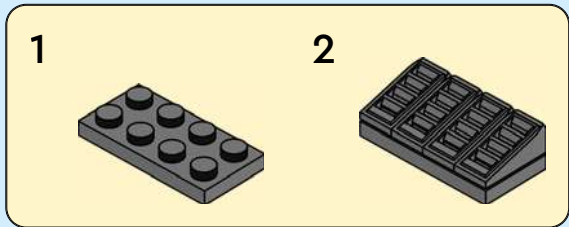

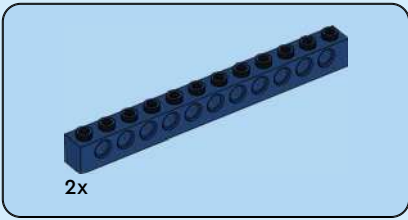

35

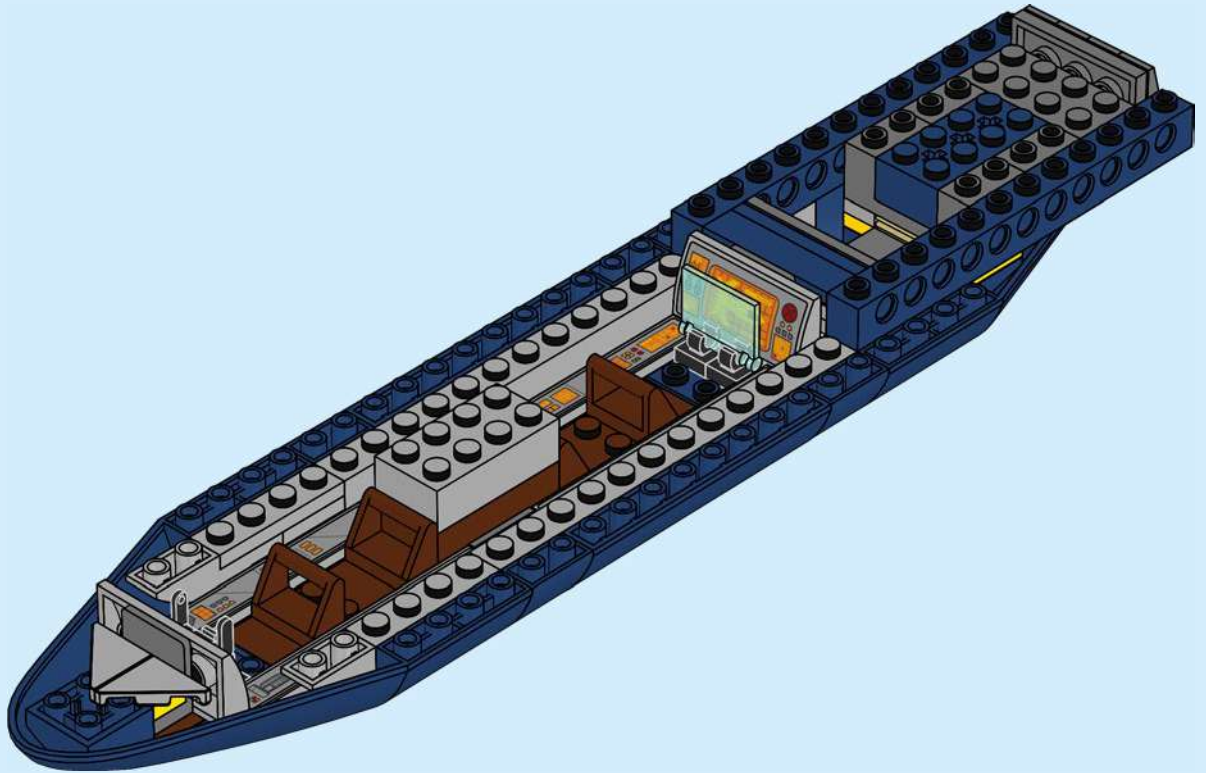

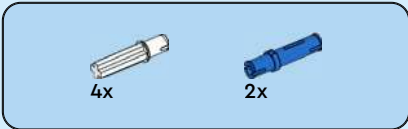

36

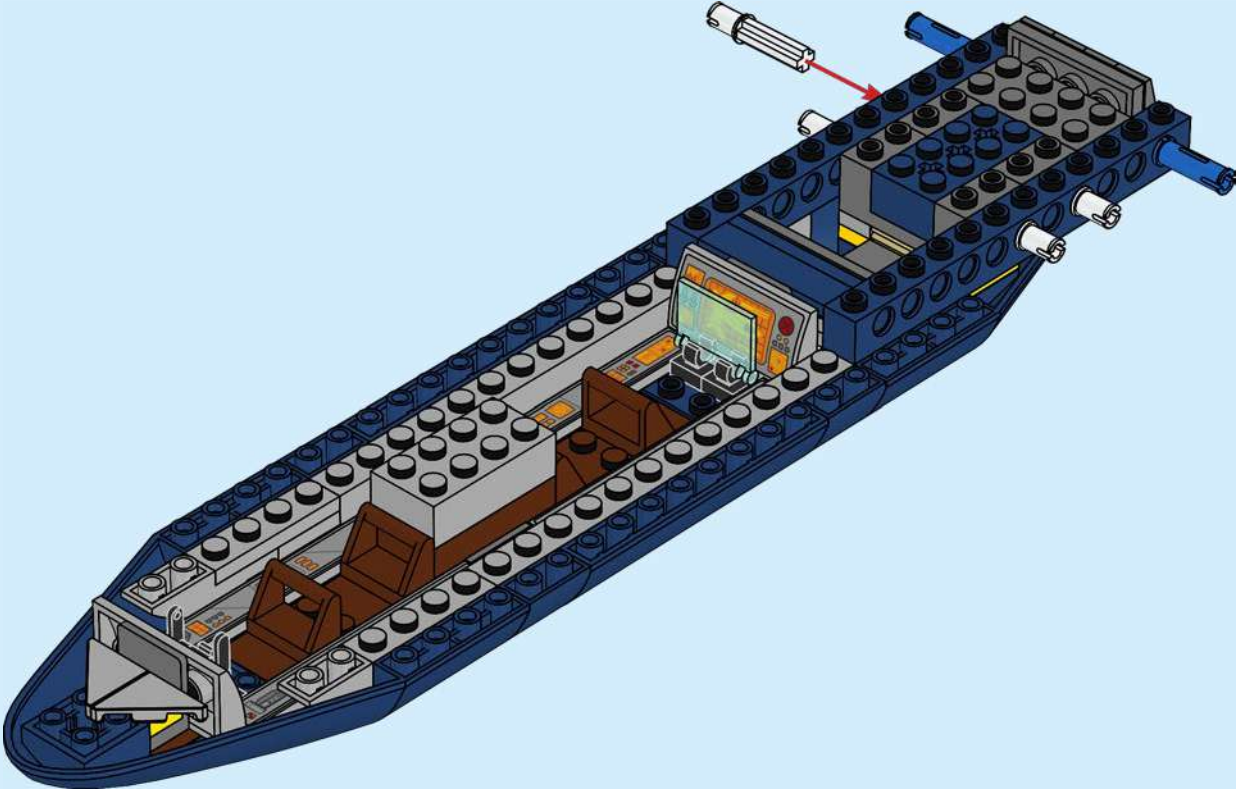

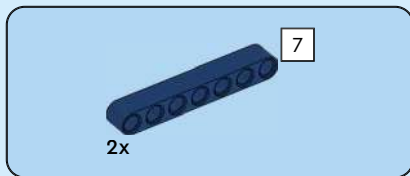

37

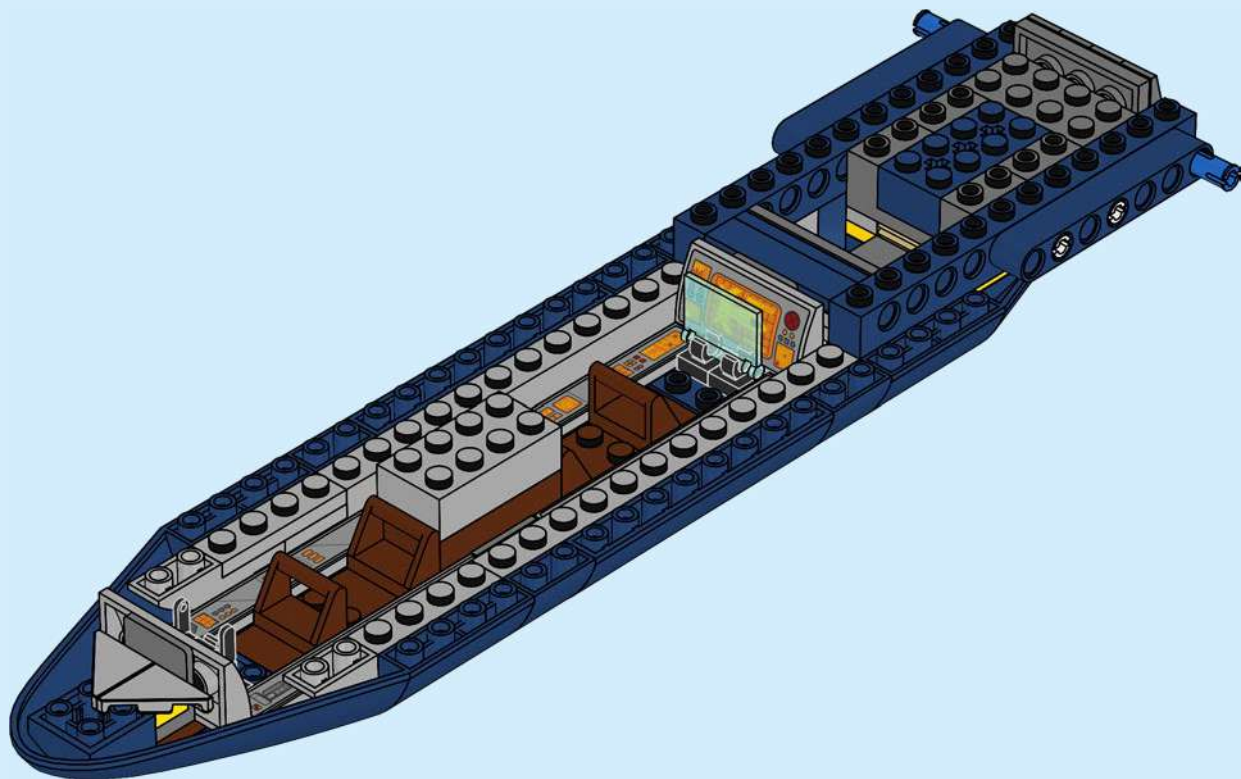



6x

38

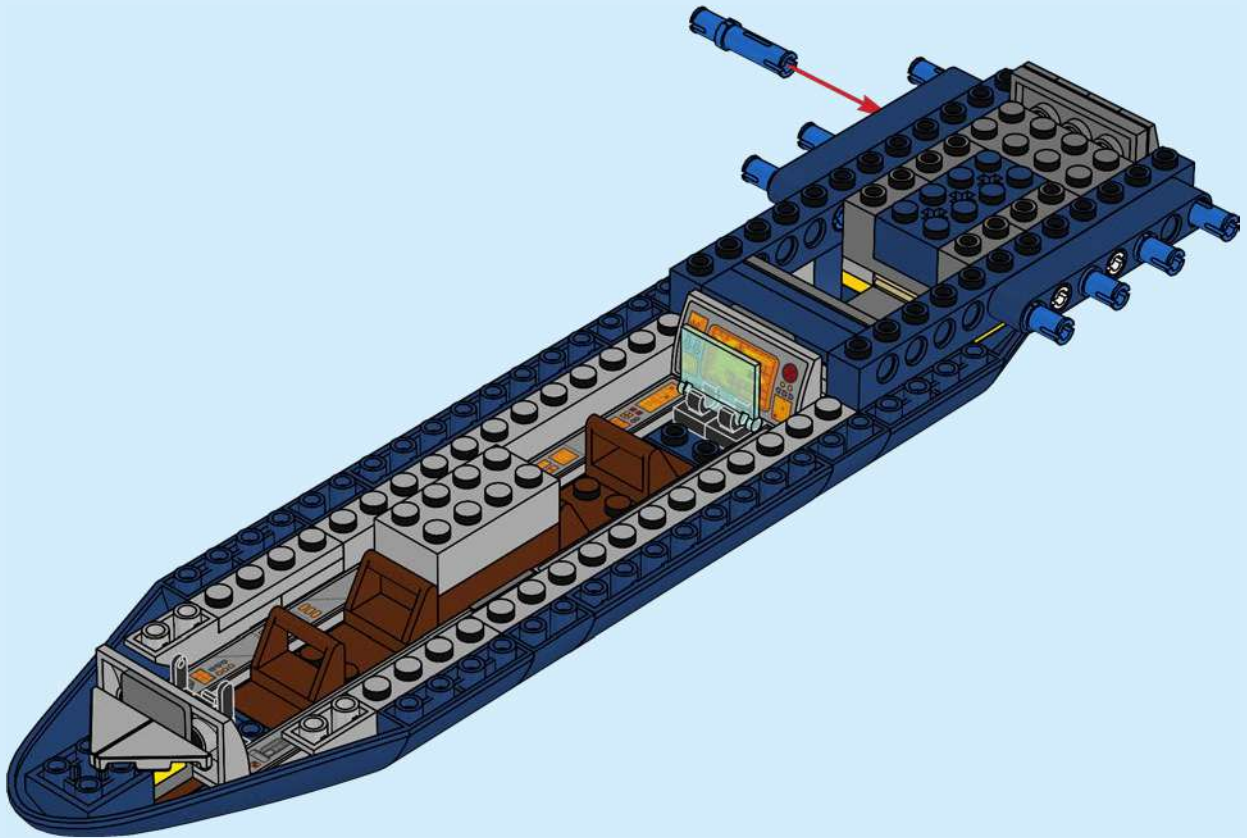

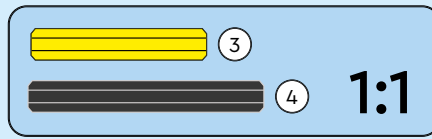
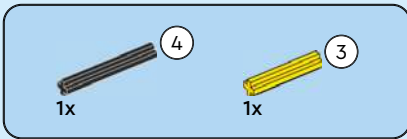

39

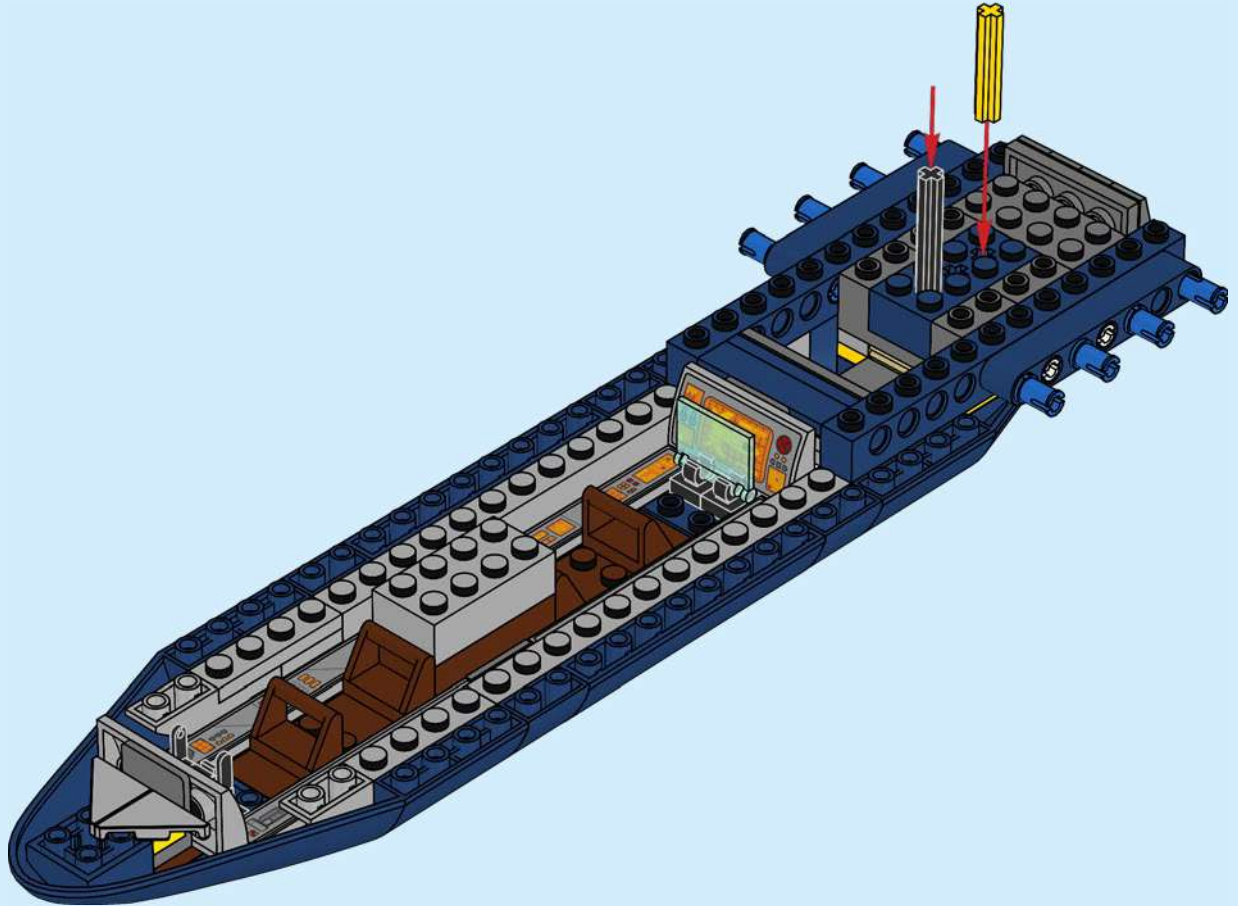



2x

40

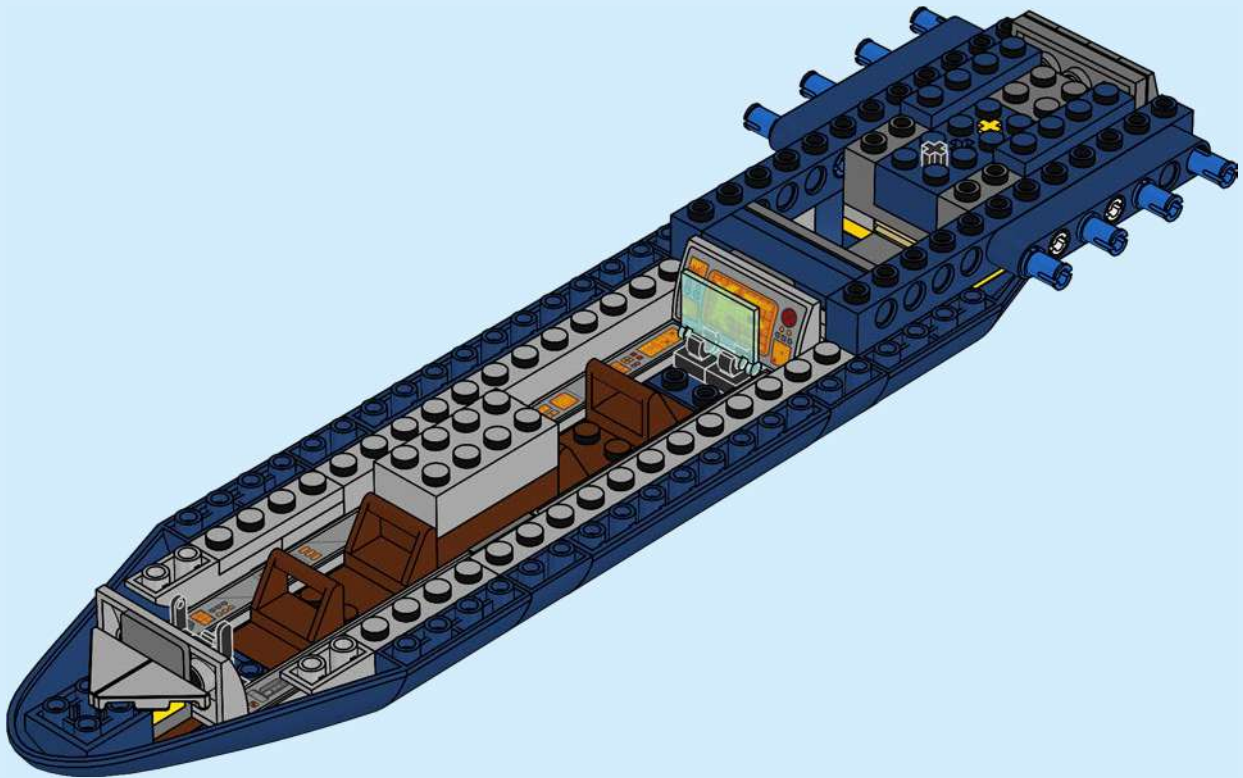

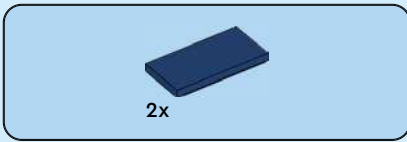

41

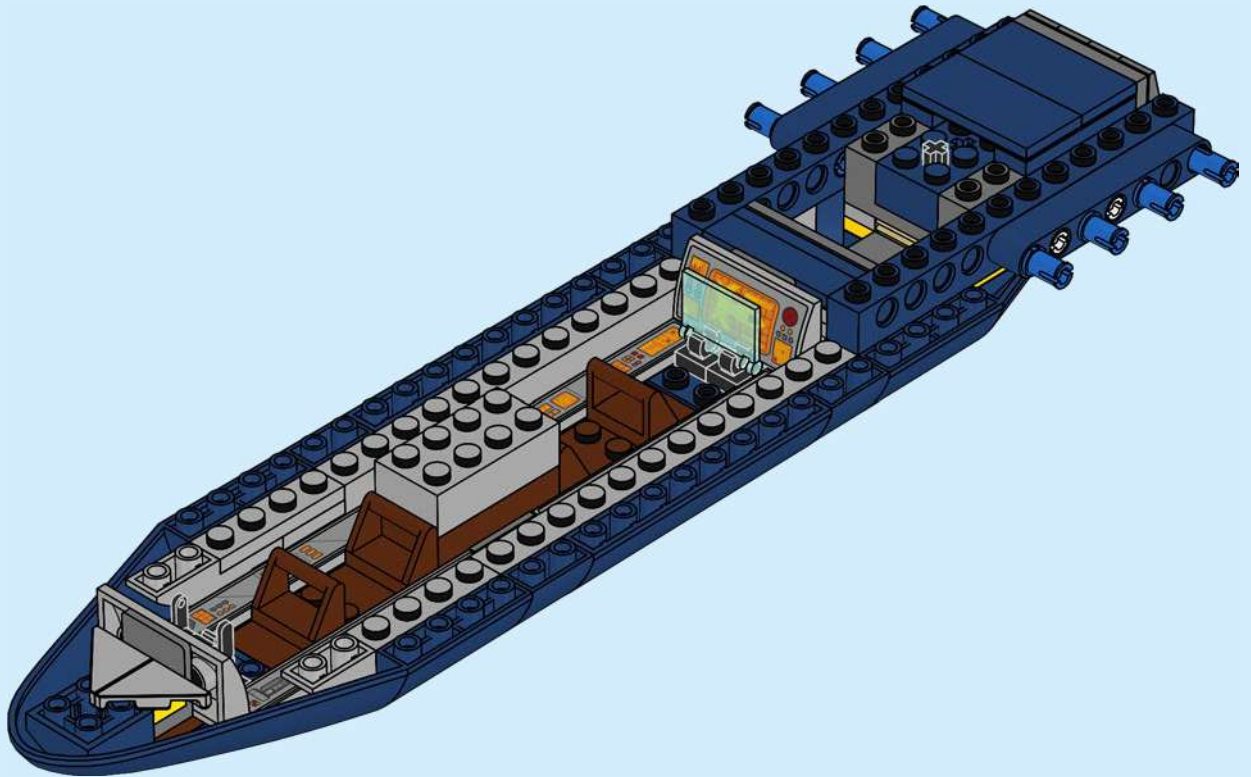



8x



8x

42



8x

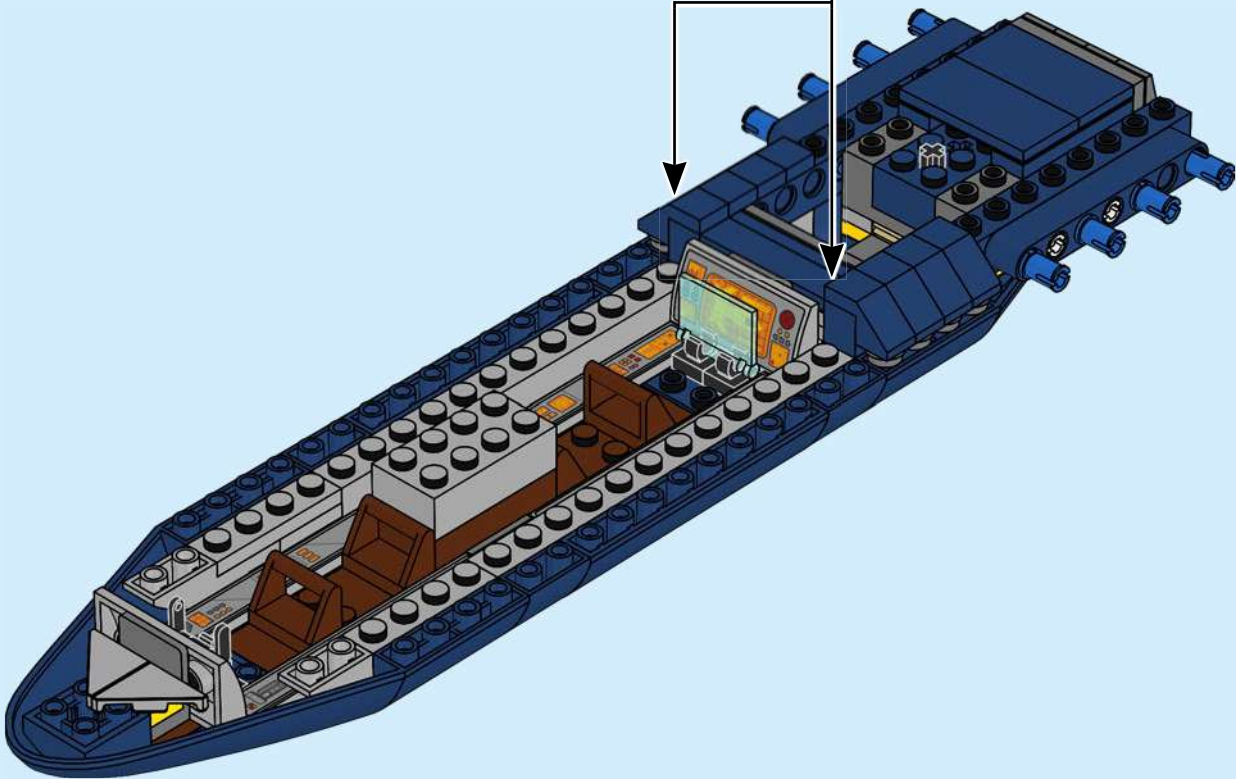

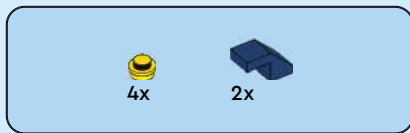

43

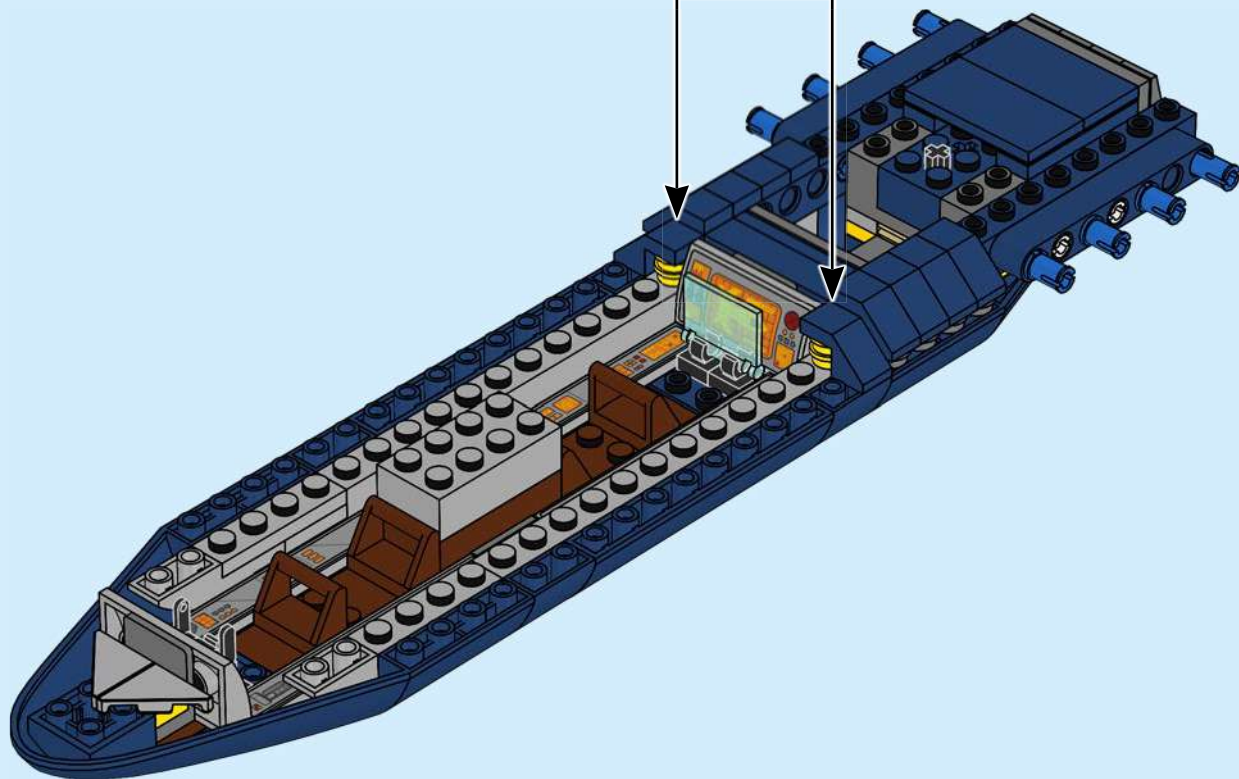
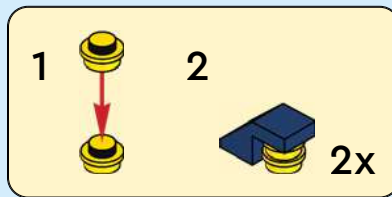

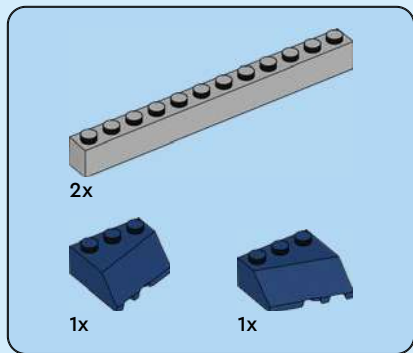

44

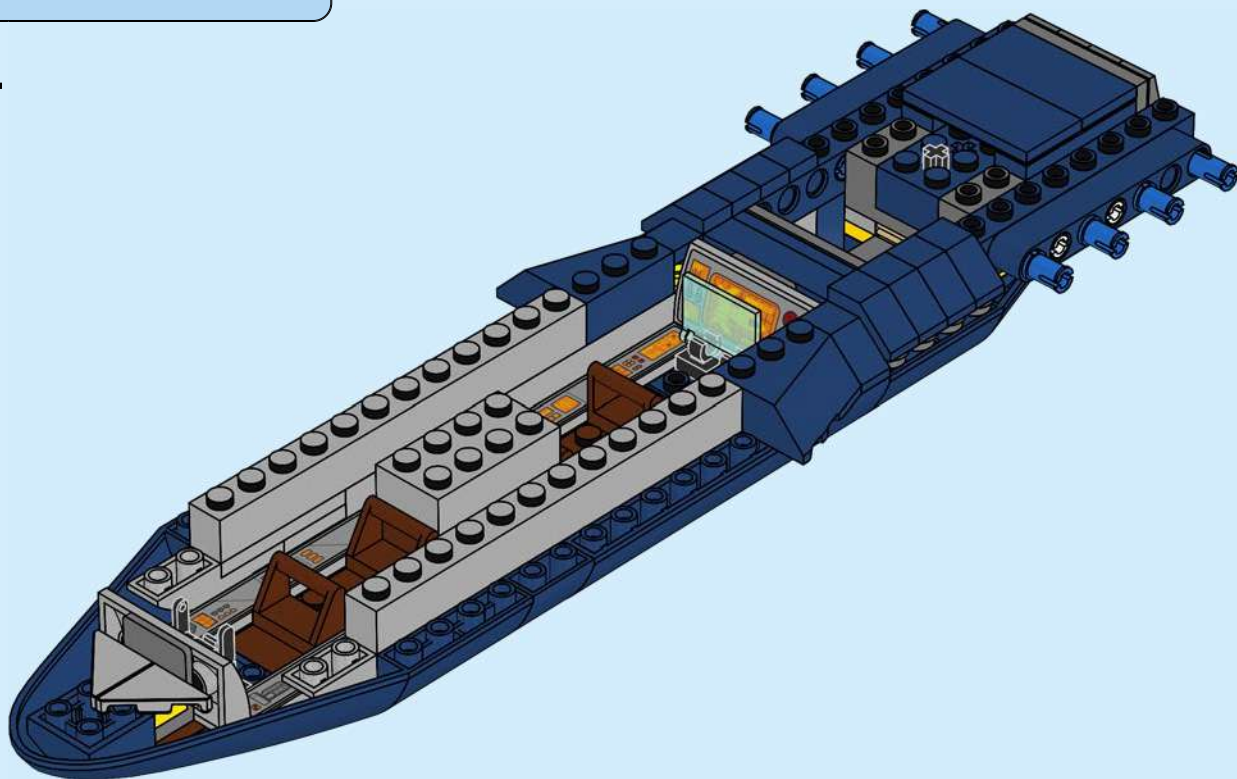

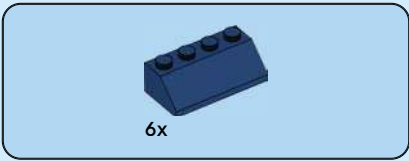

45

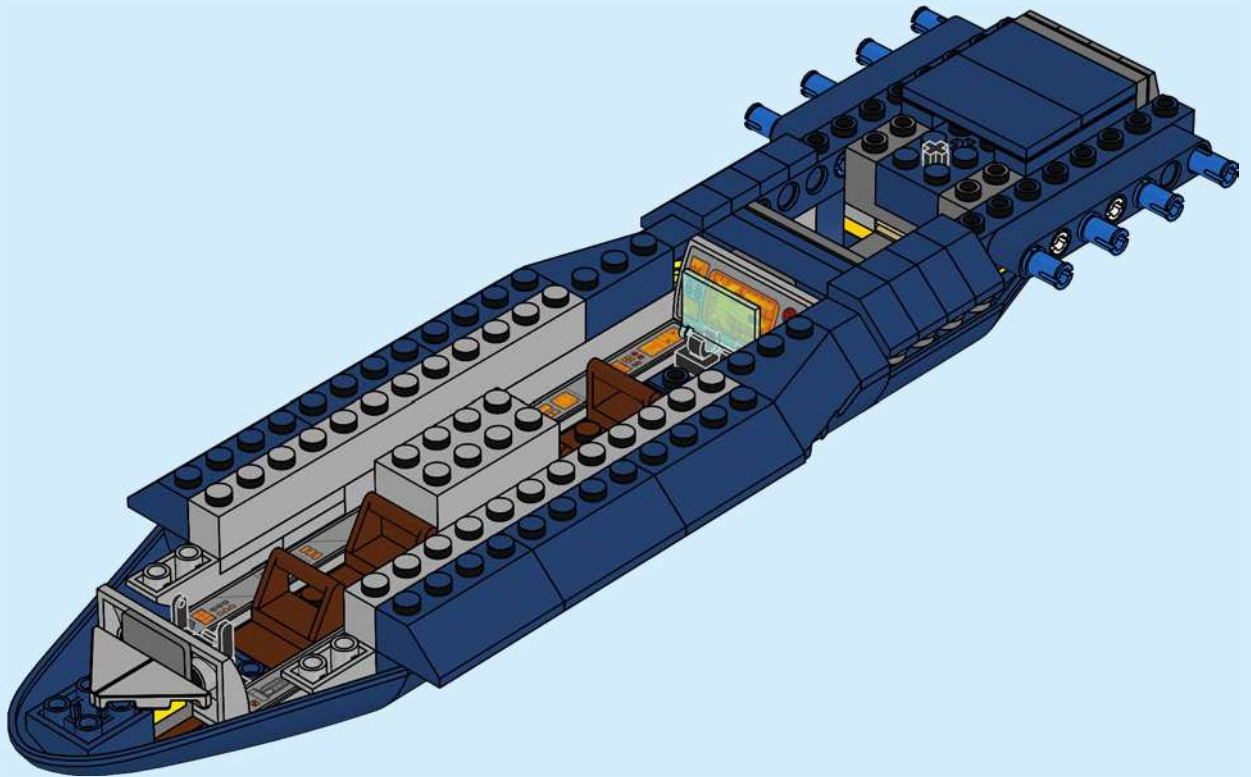



4x

46

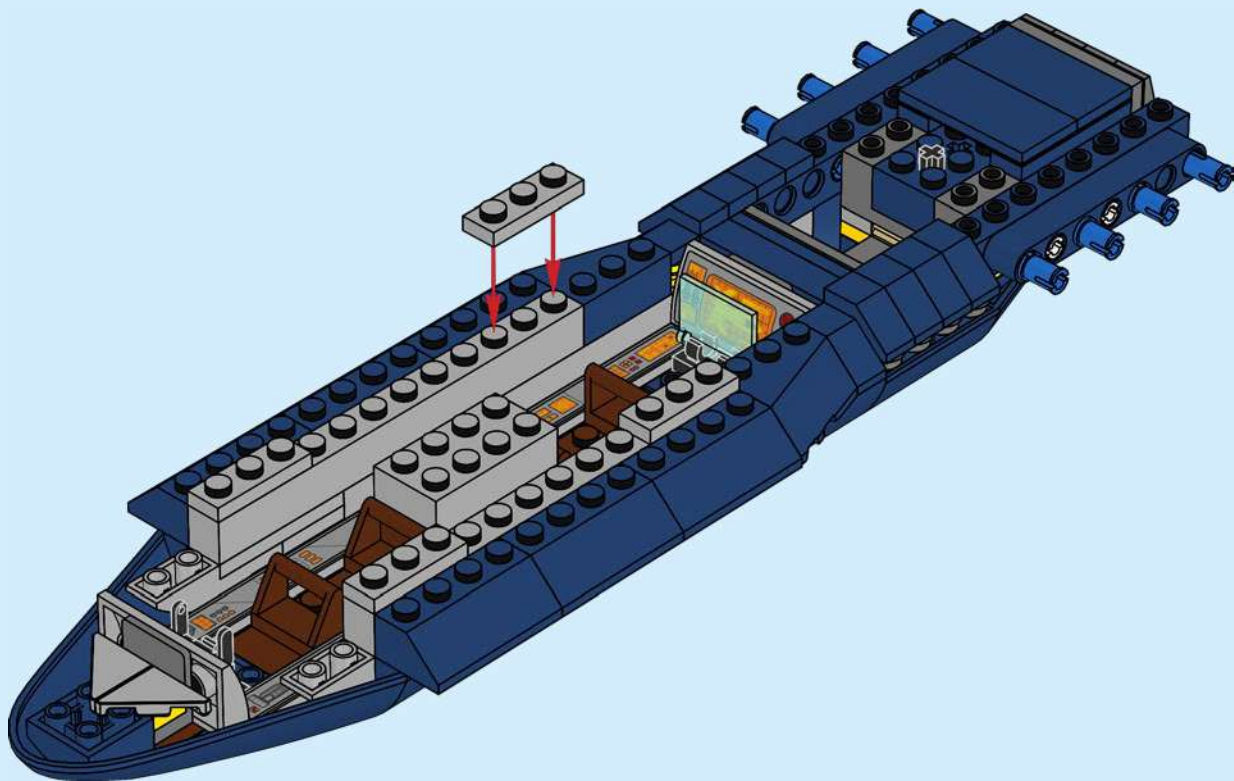

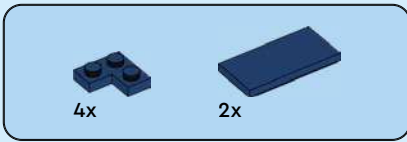

47

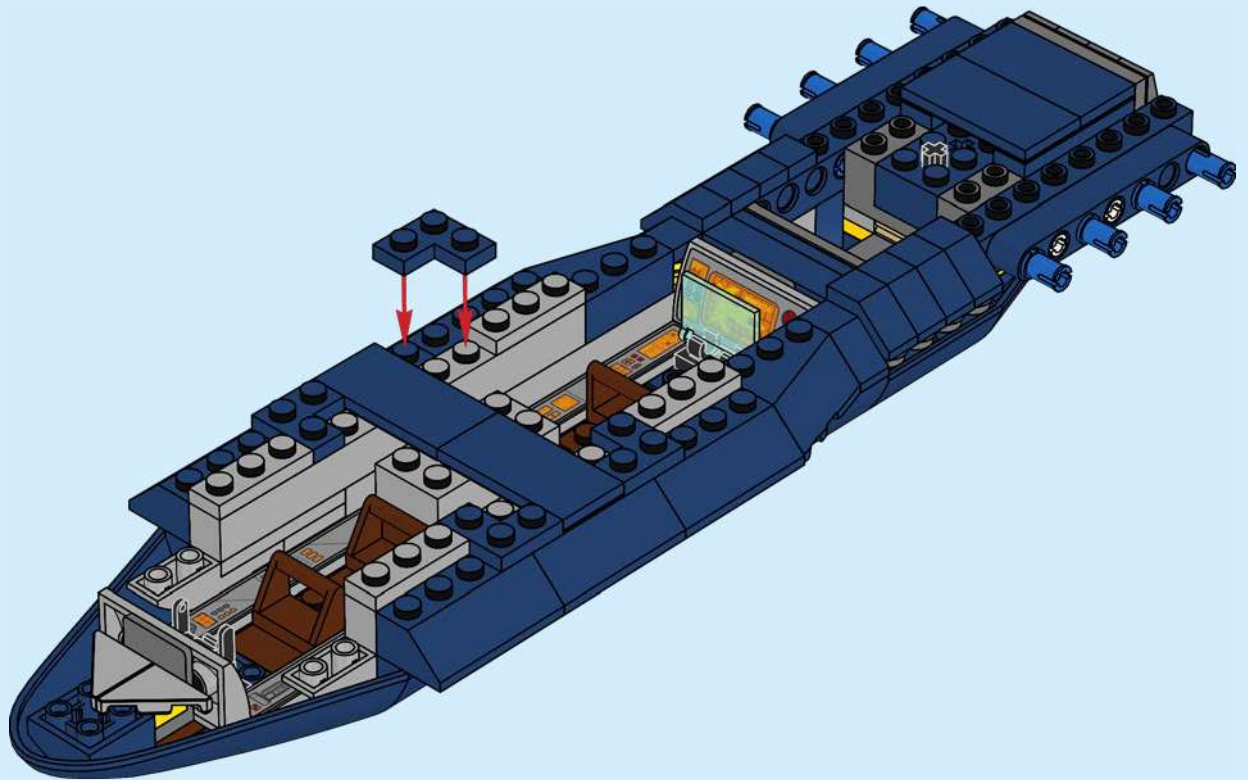

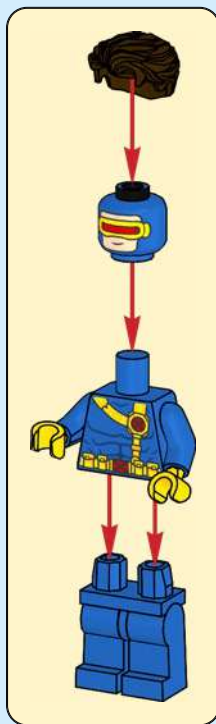

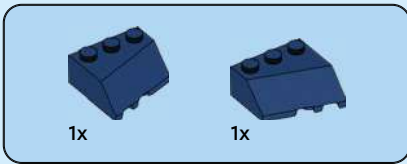

48

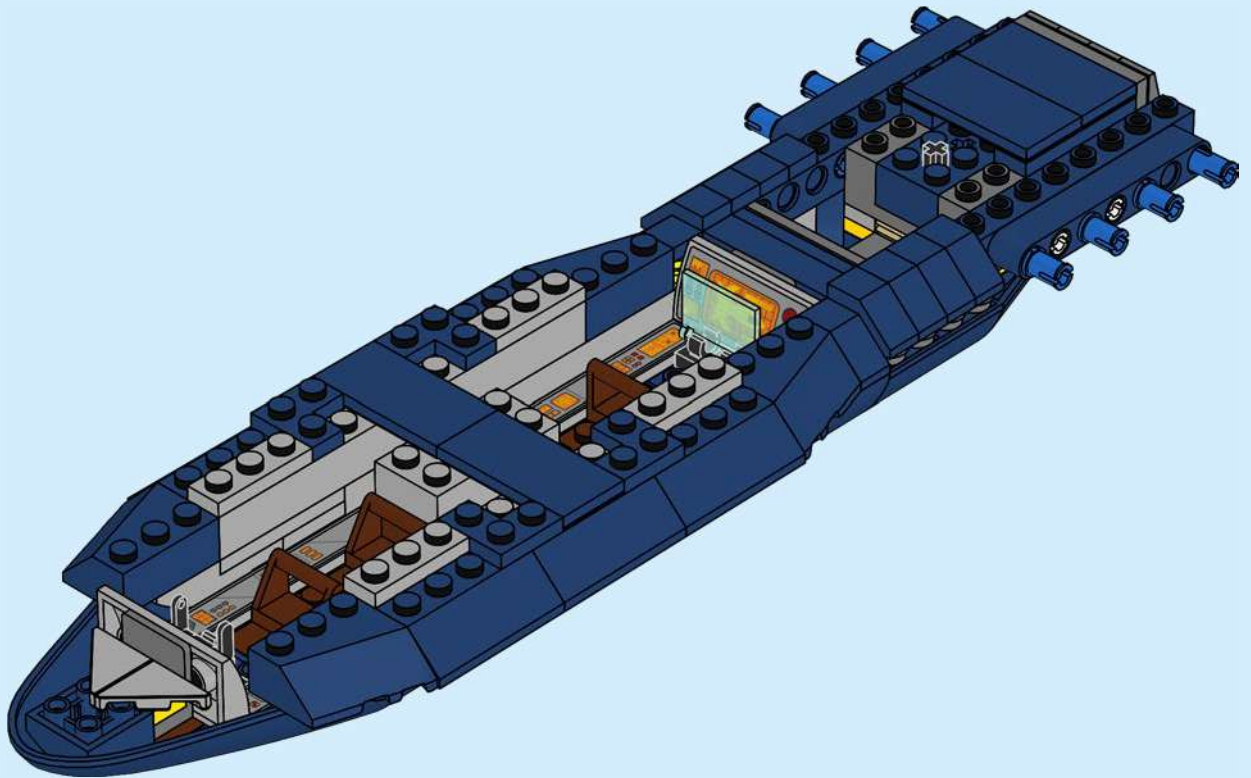



4x

49

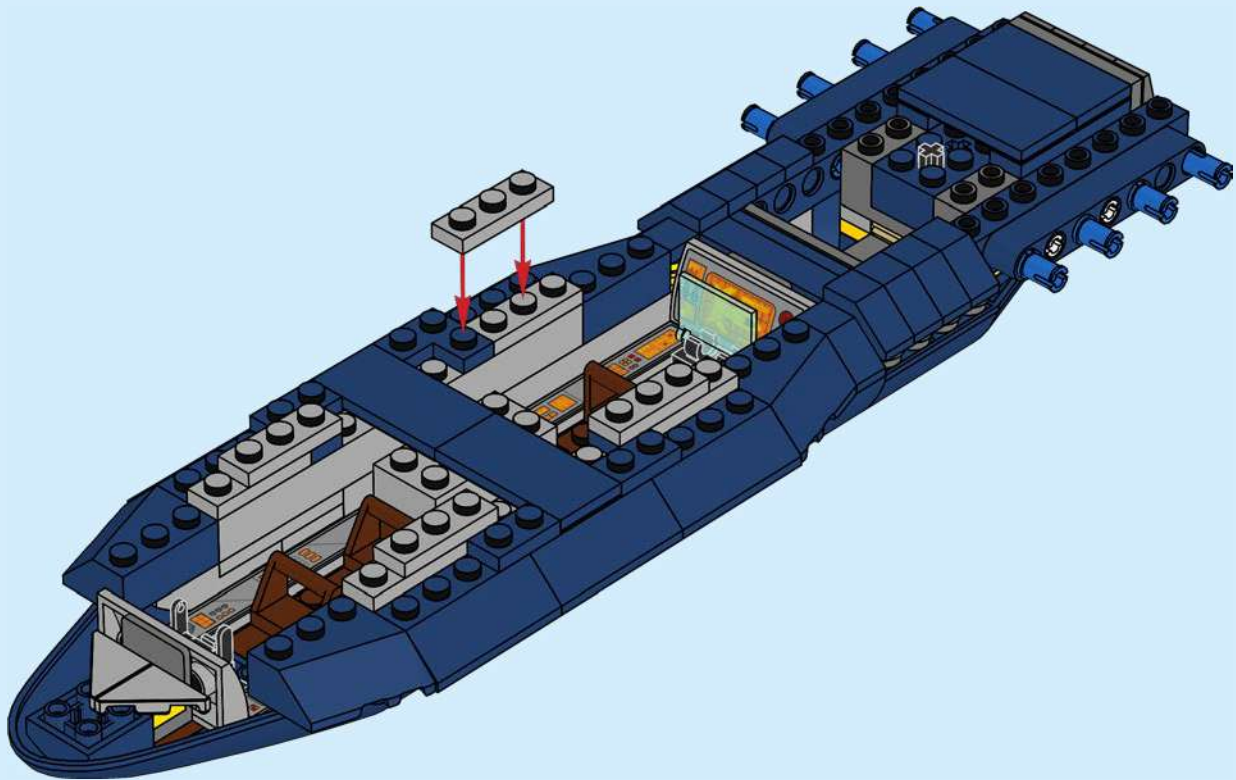



4x

50

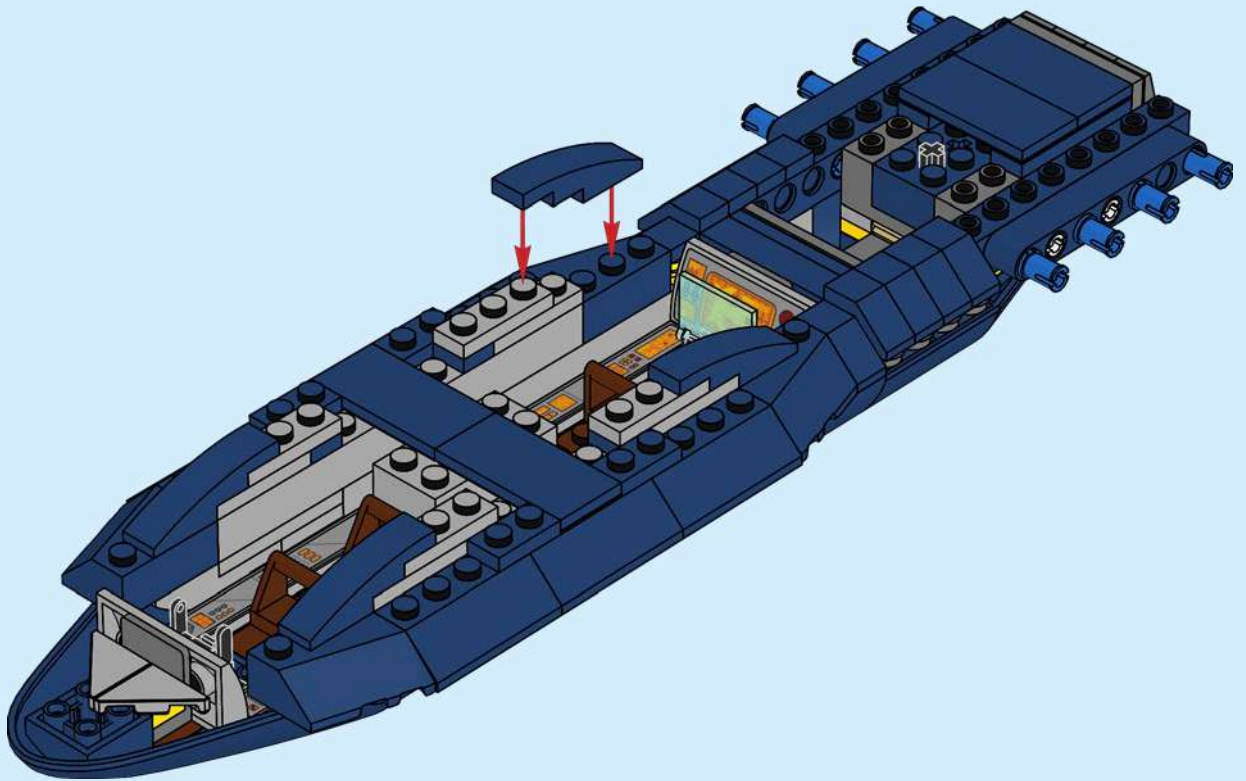

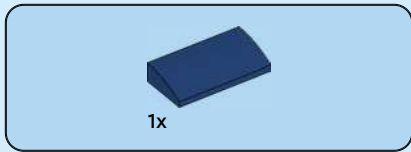

51

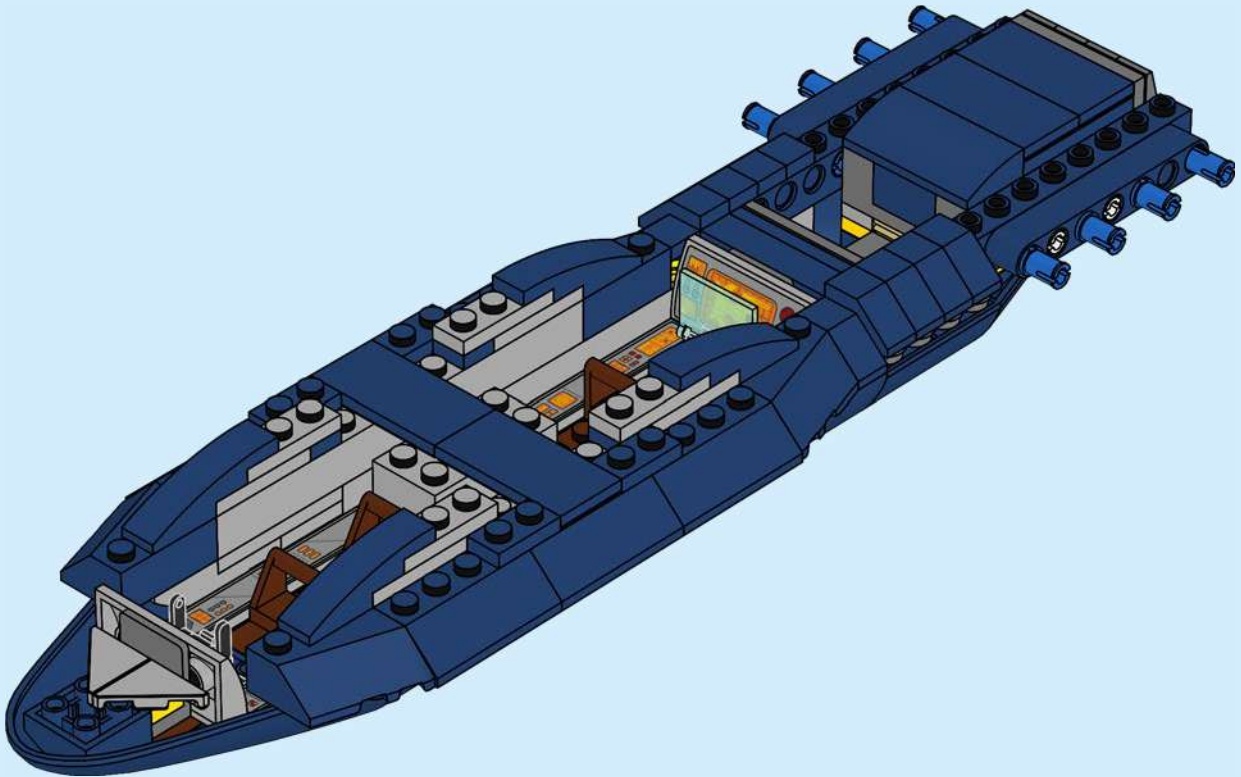



4x

52

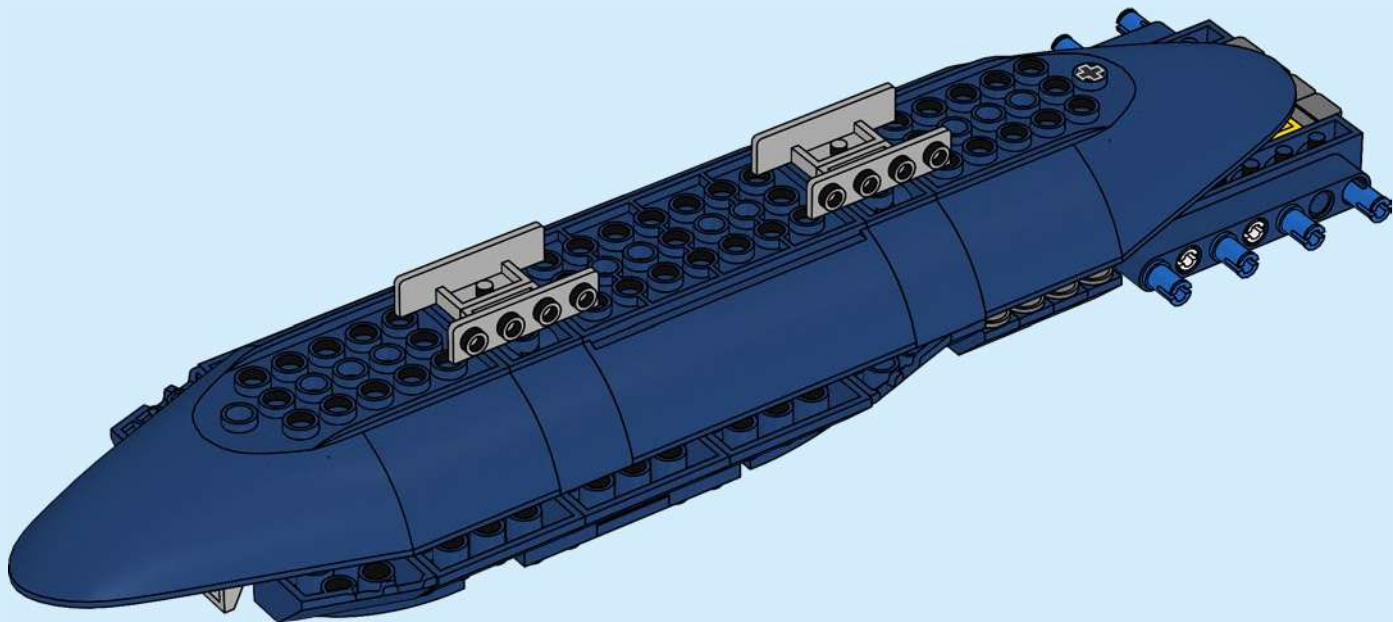



4x

53

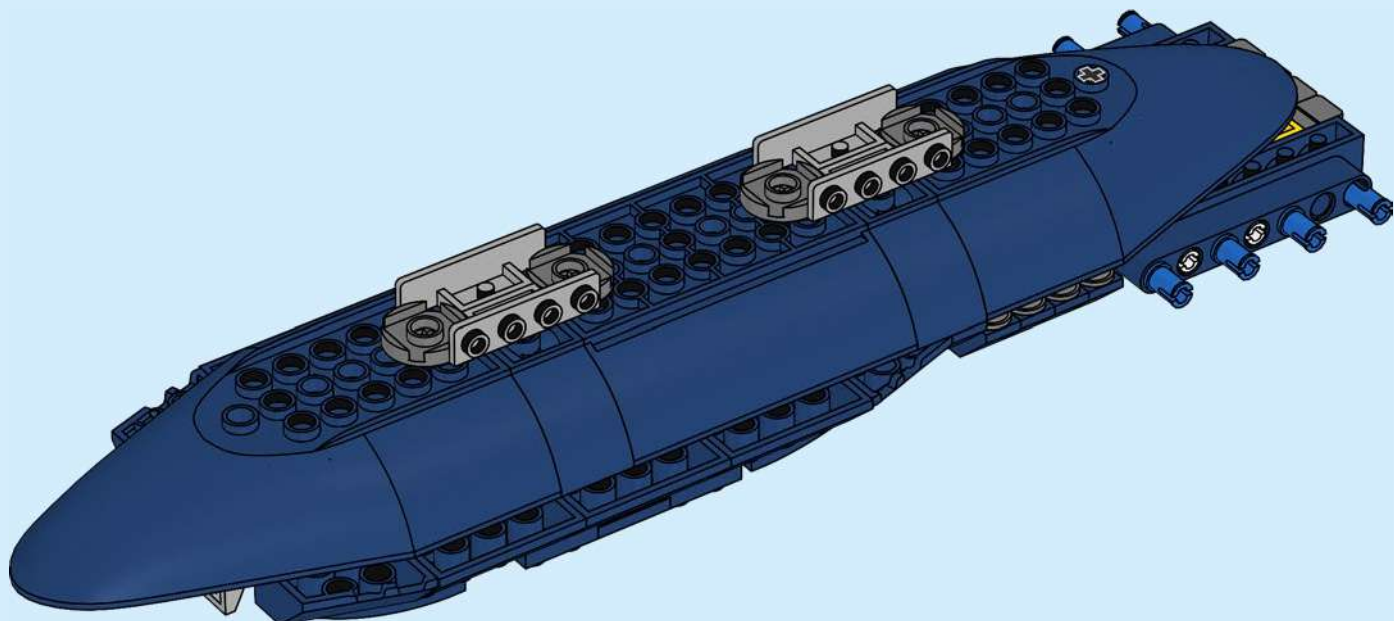



4x

54

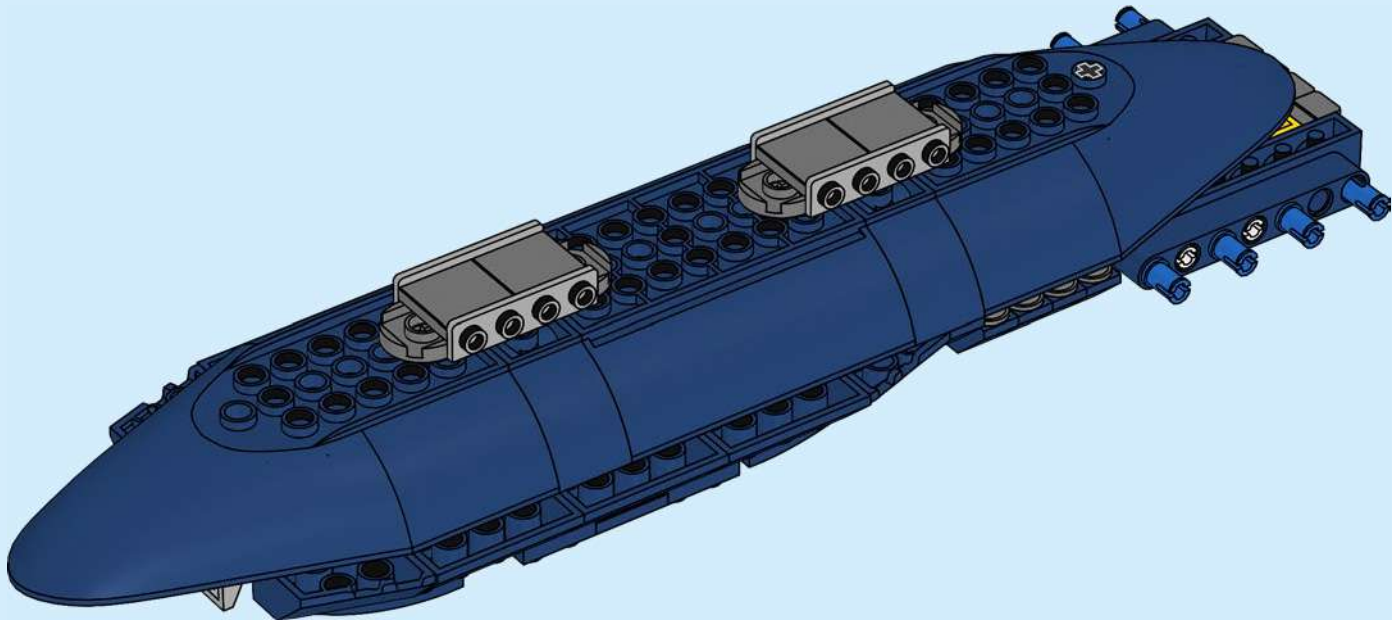



4x

55

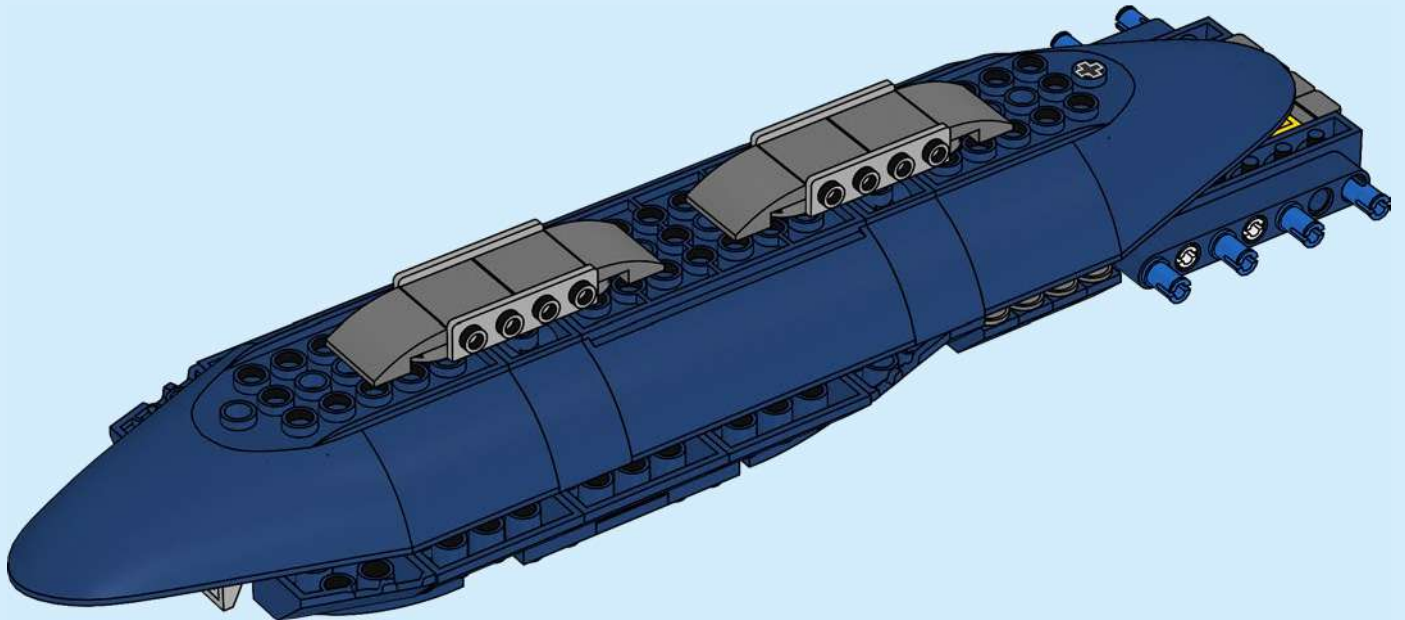



4x

56

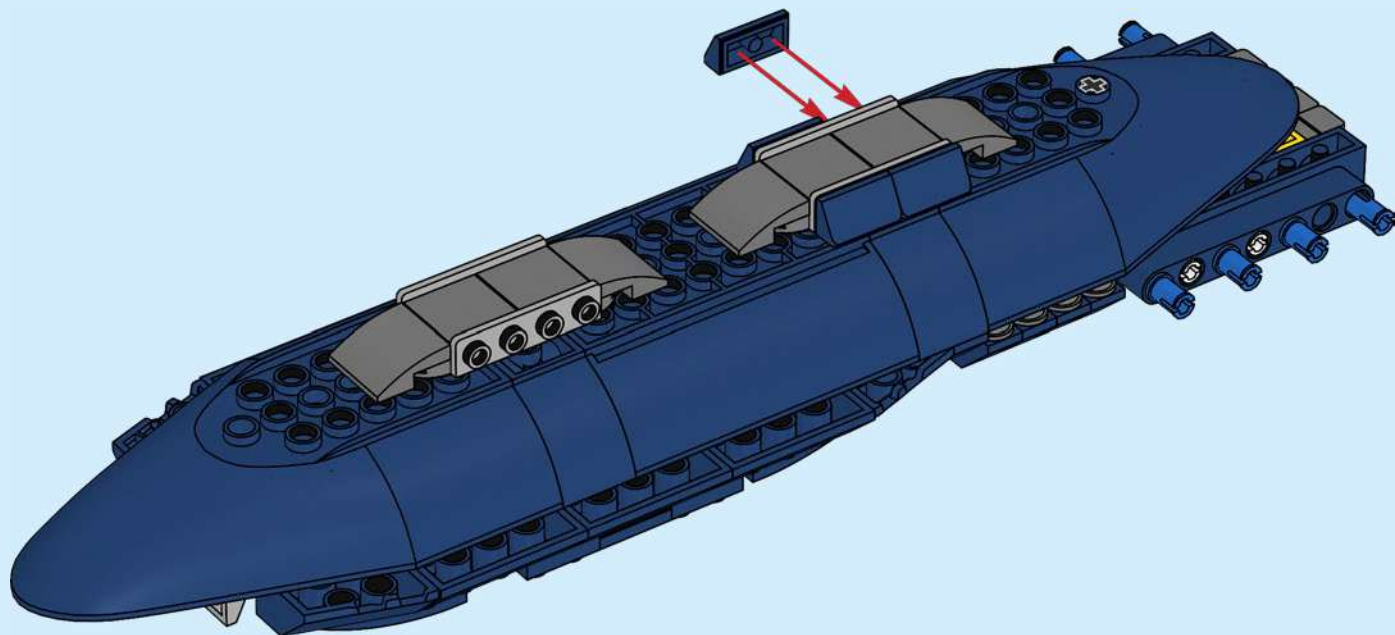

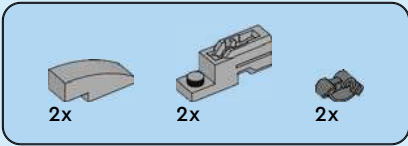

57

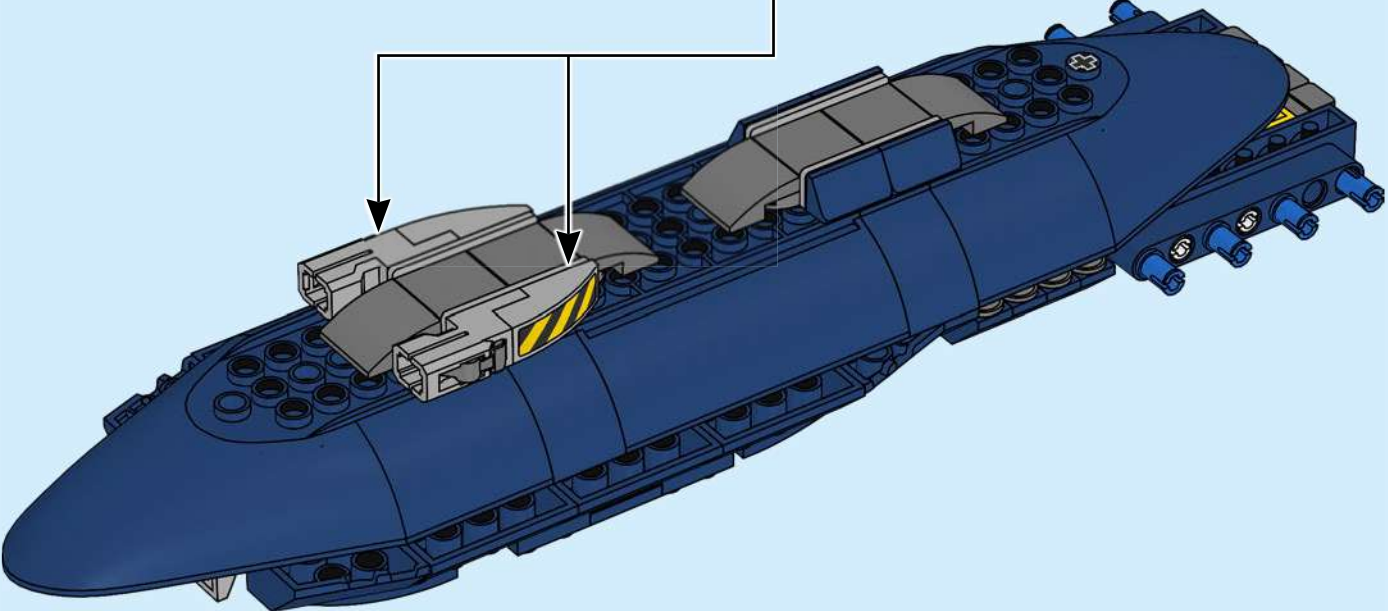
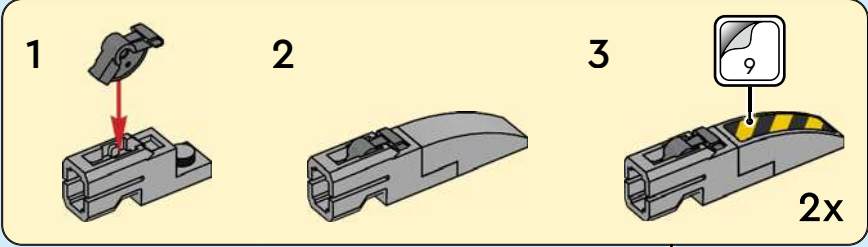

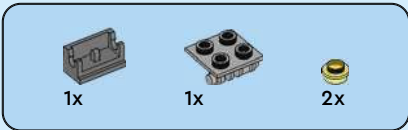

58

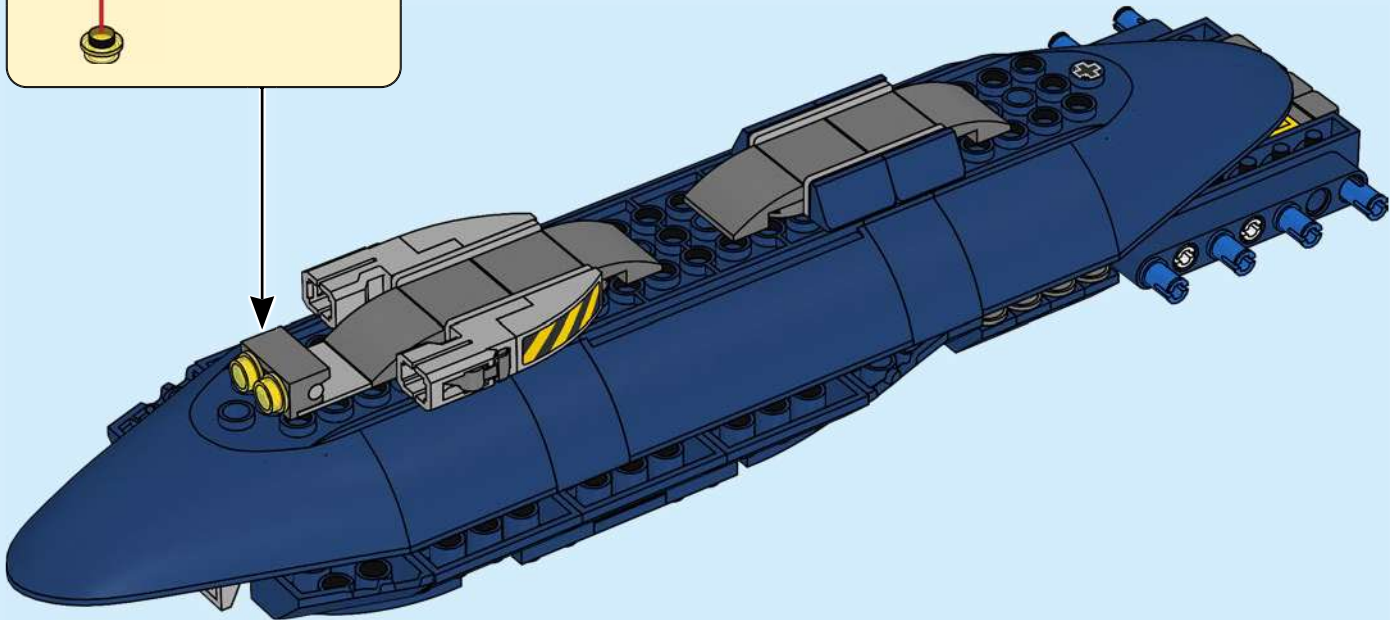
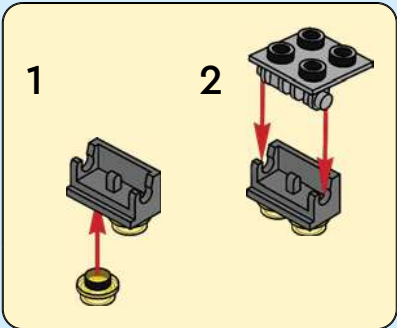



2x

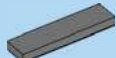

2x



2x



4x

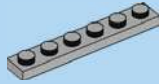

2x



2x



4x

59

1

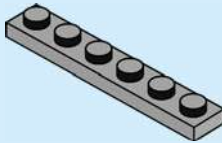

2

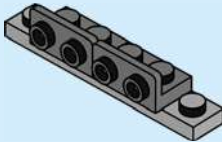

3

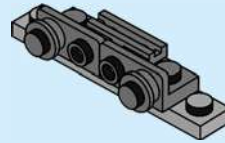

4

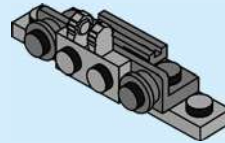

5

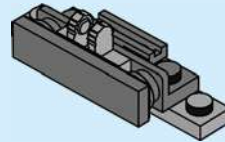

2x

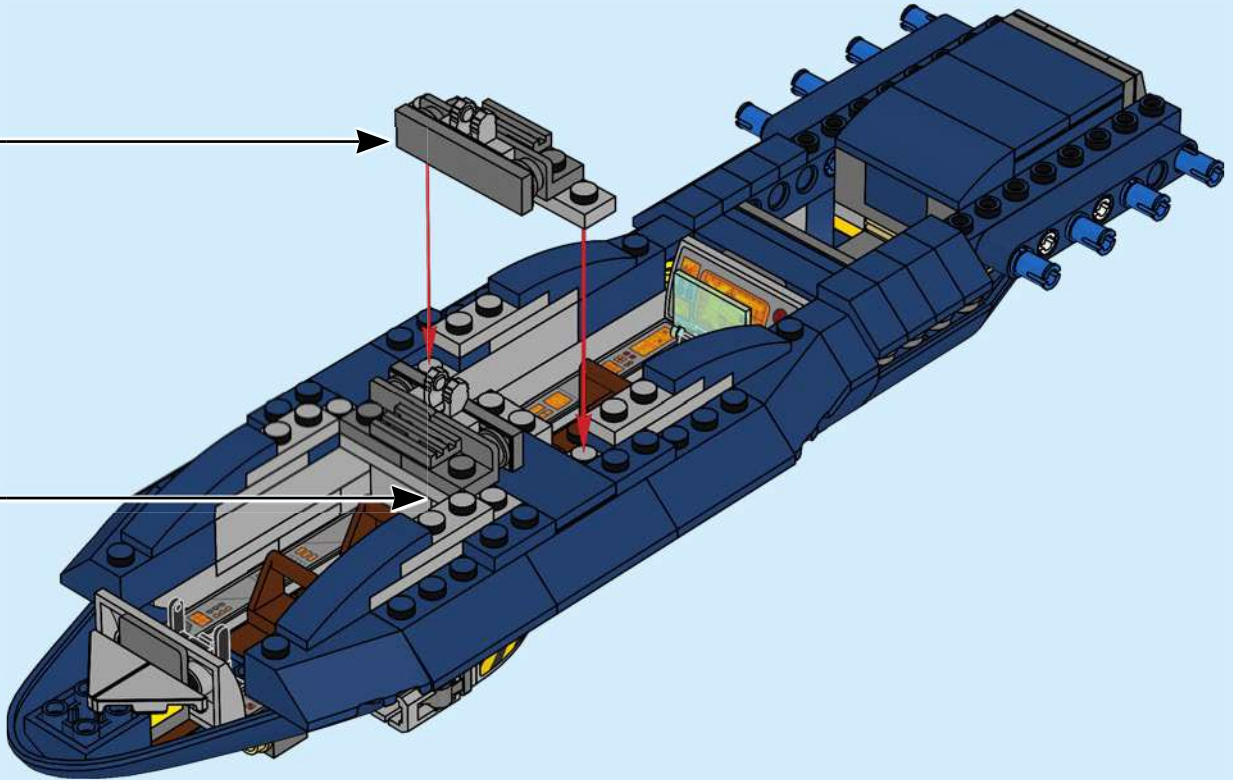



4x



4x

60

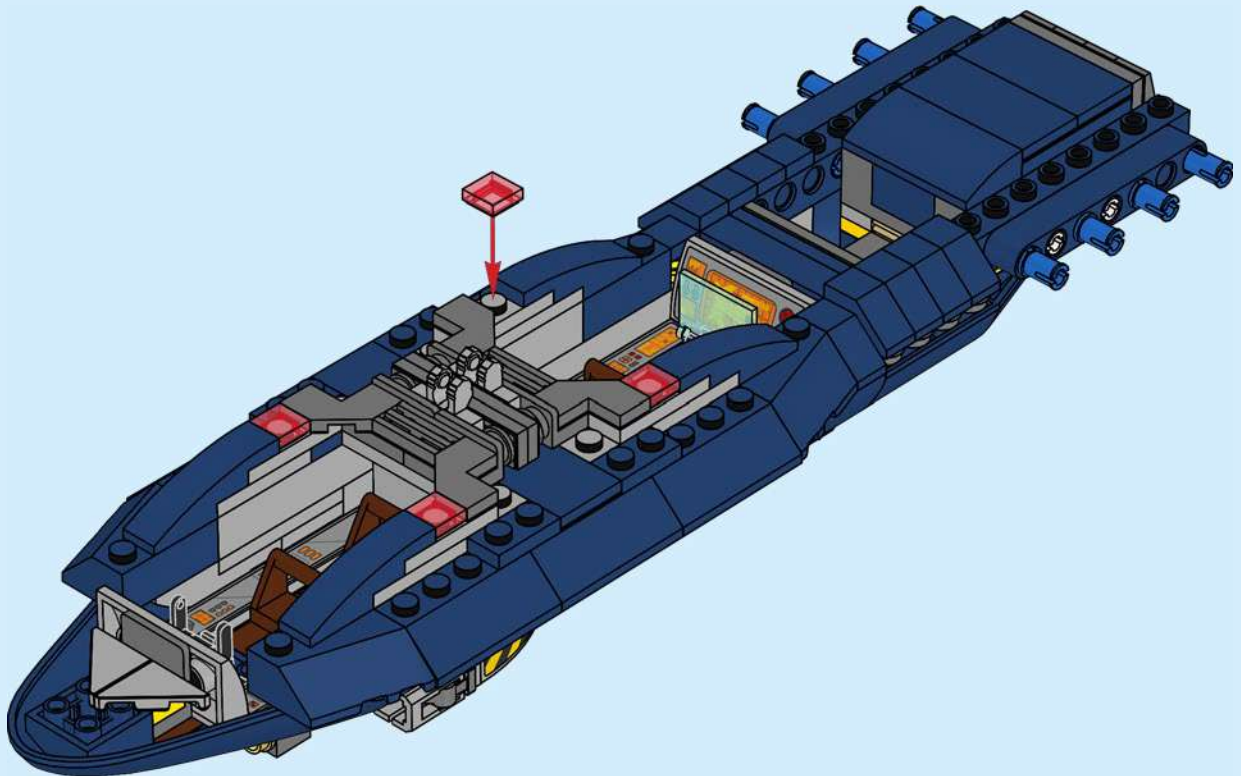

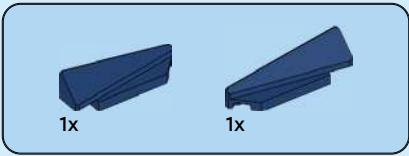

61

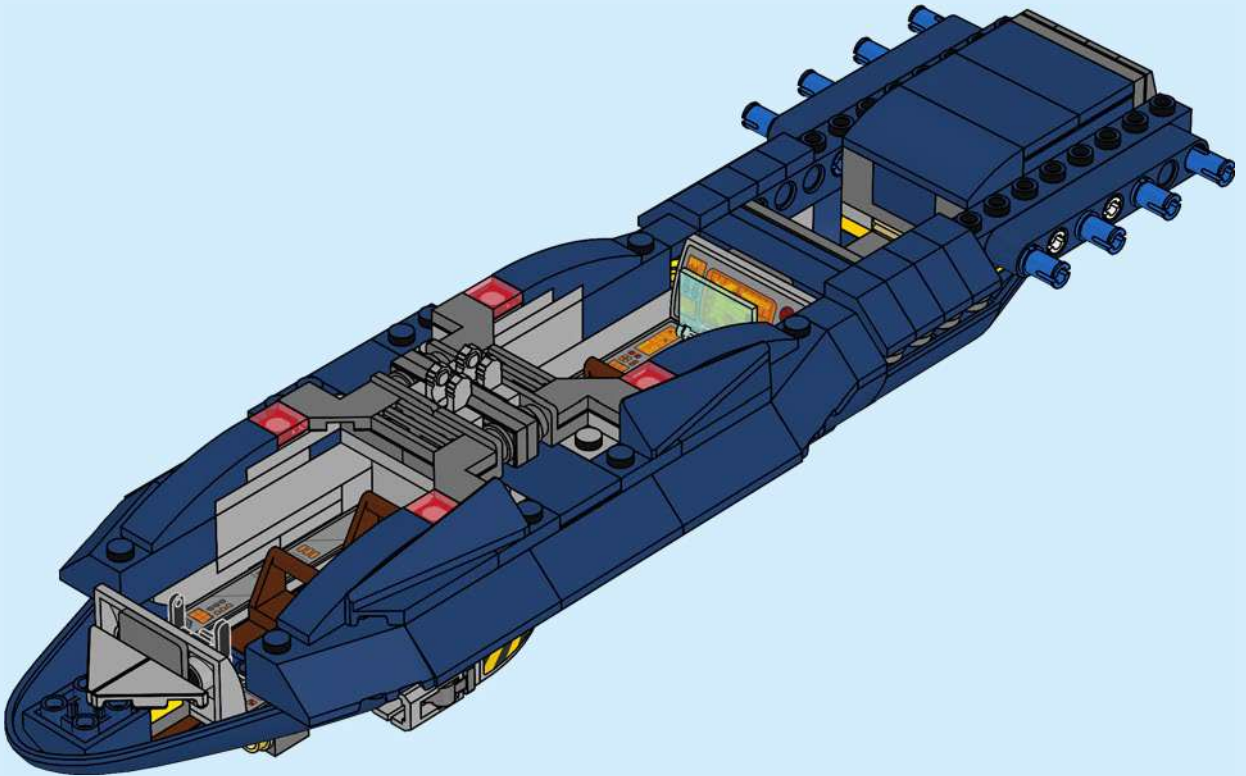

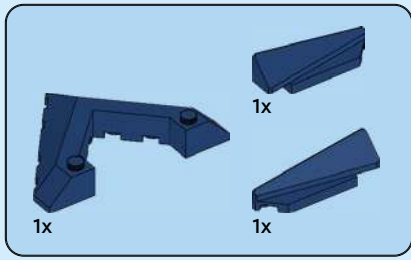

62

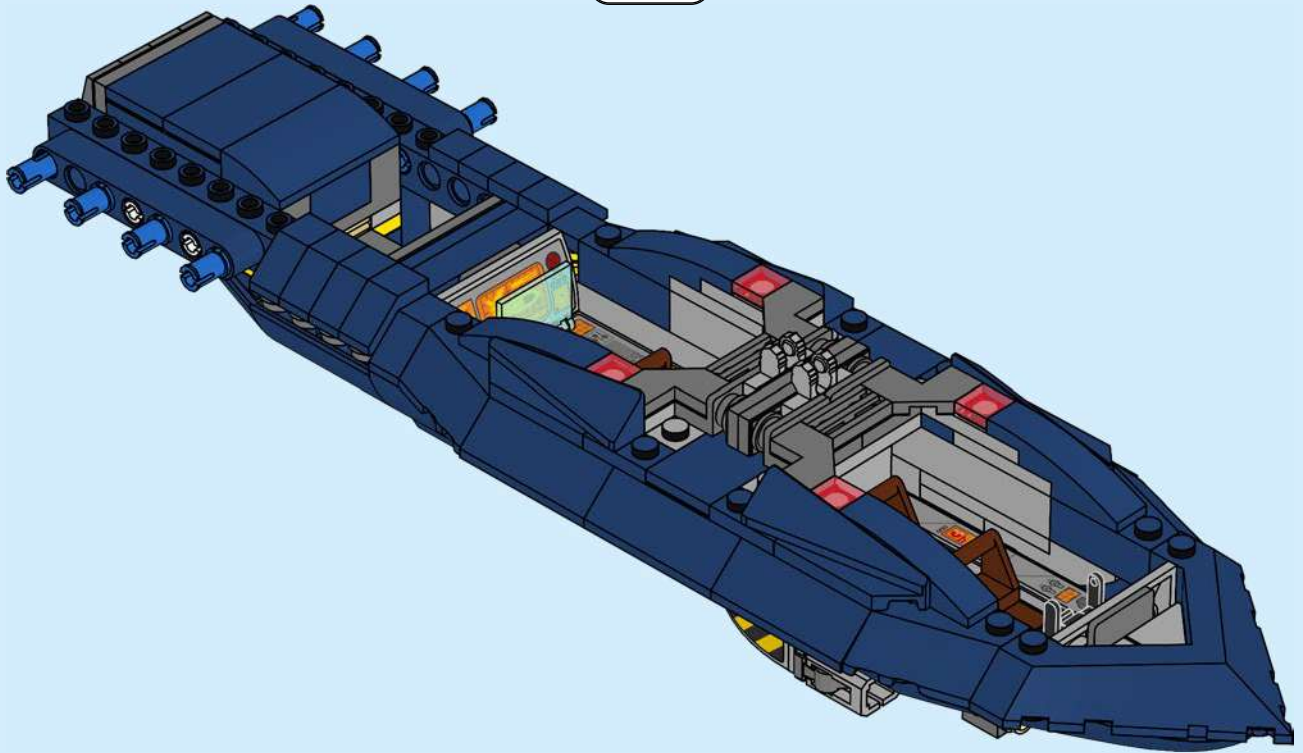

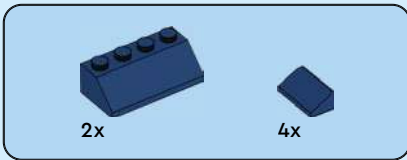

63

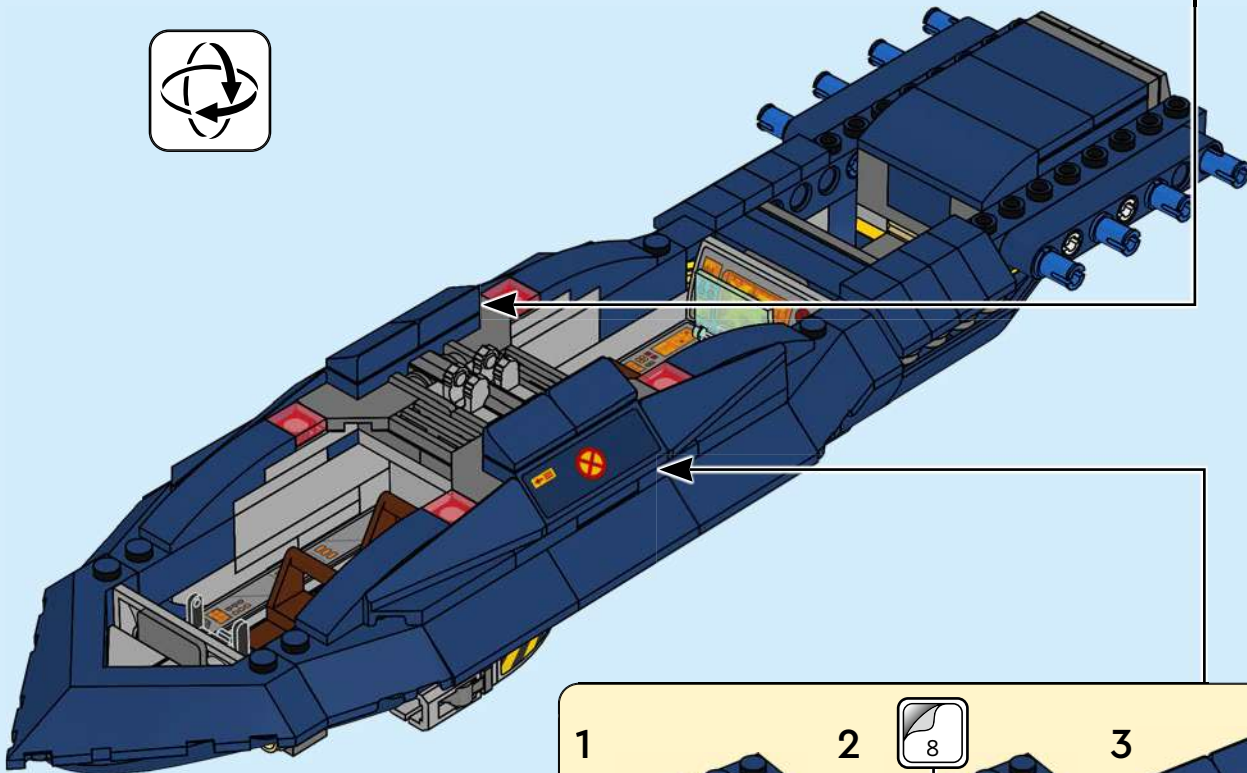
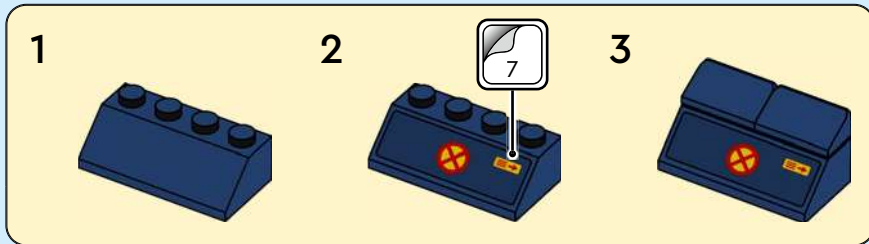

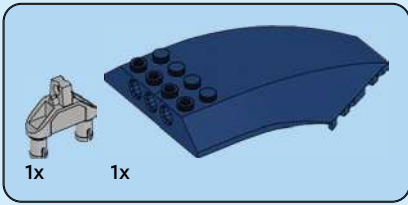

64

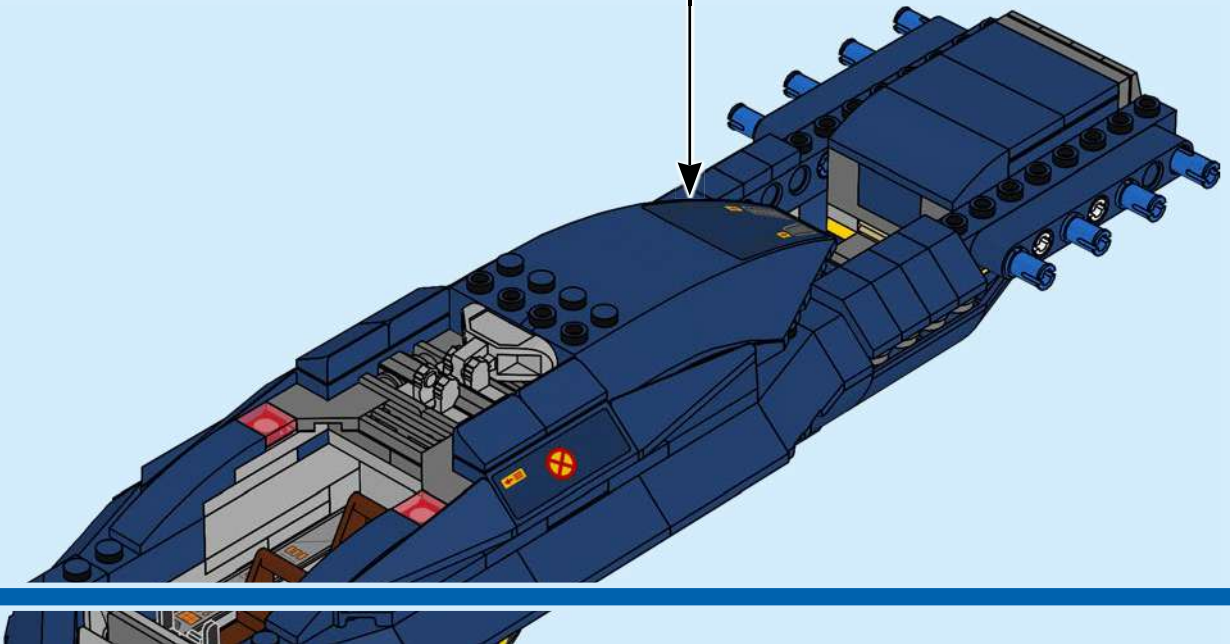
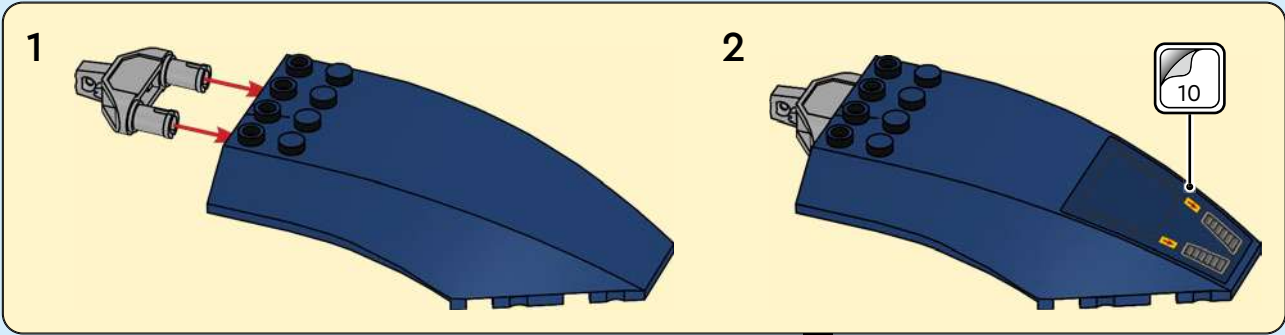

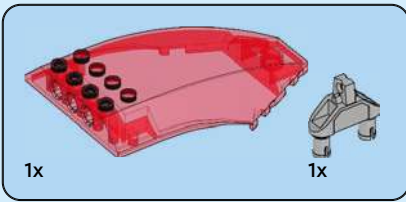

65

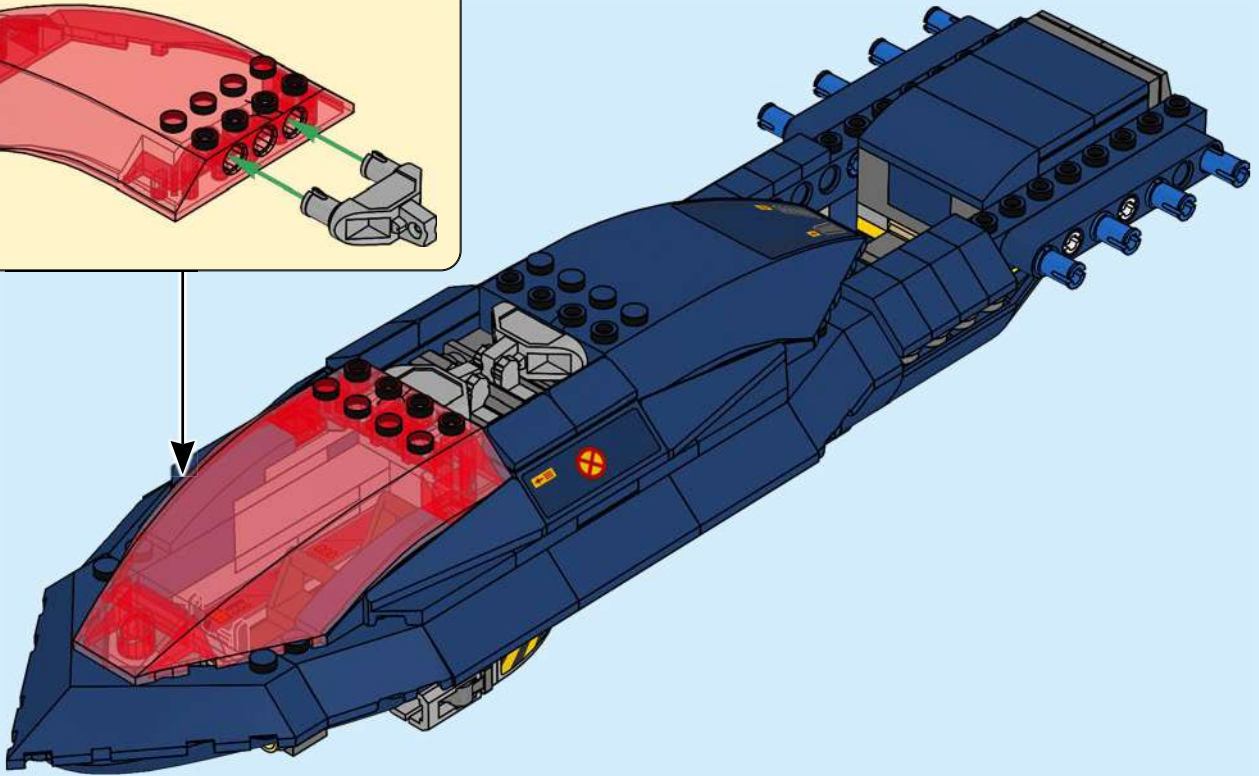
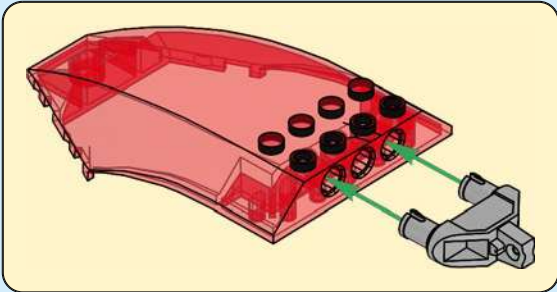

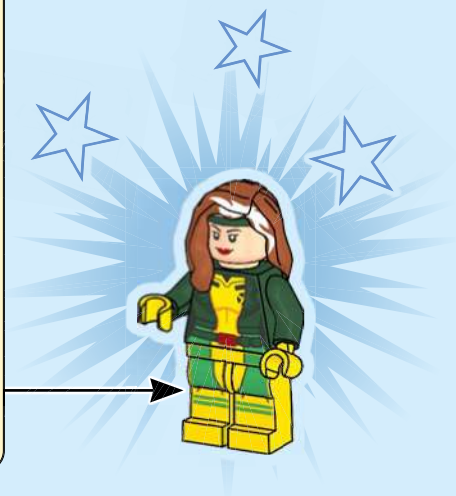
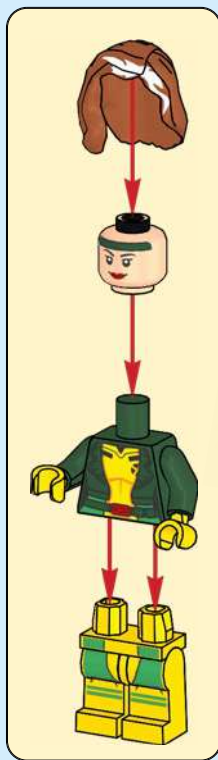

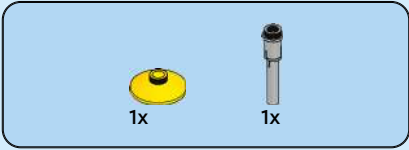

66

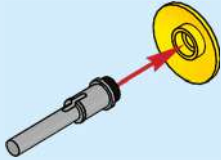

67

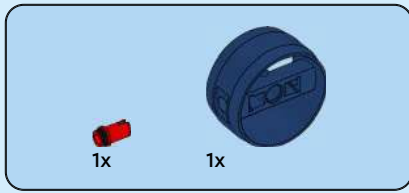

68

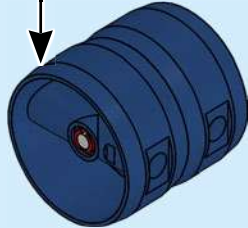
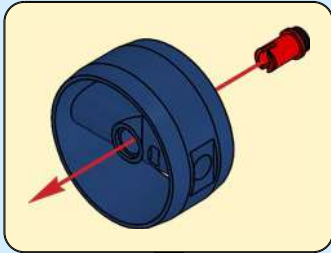

2x



69

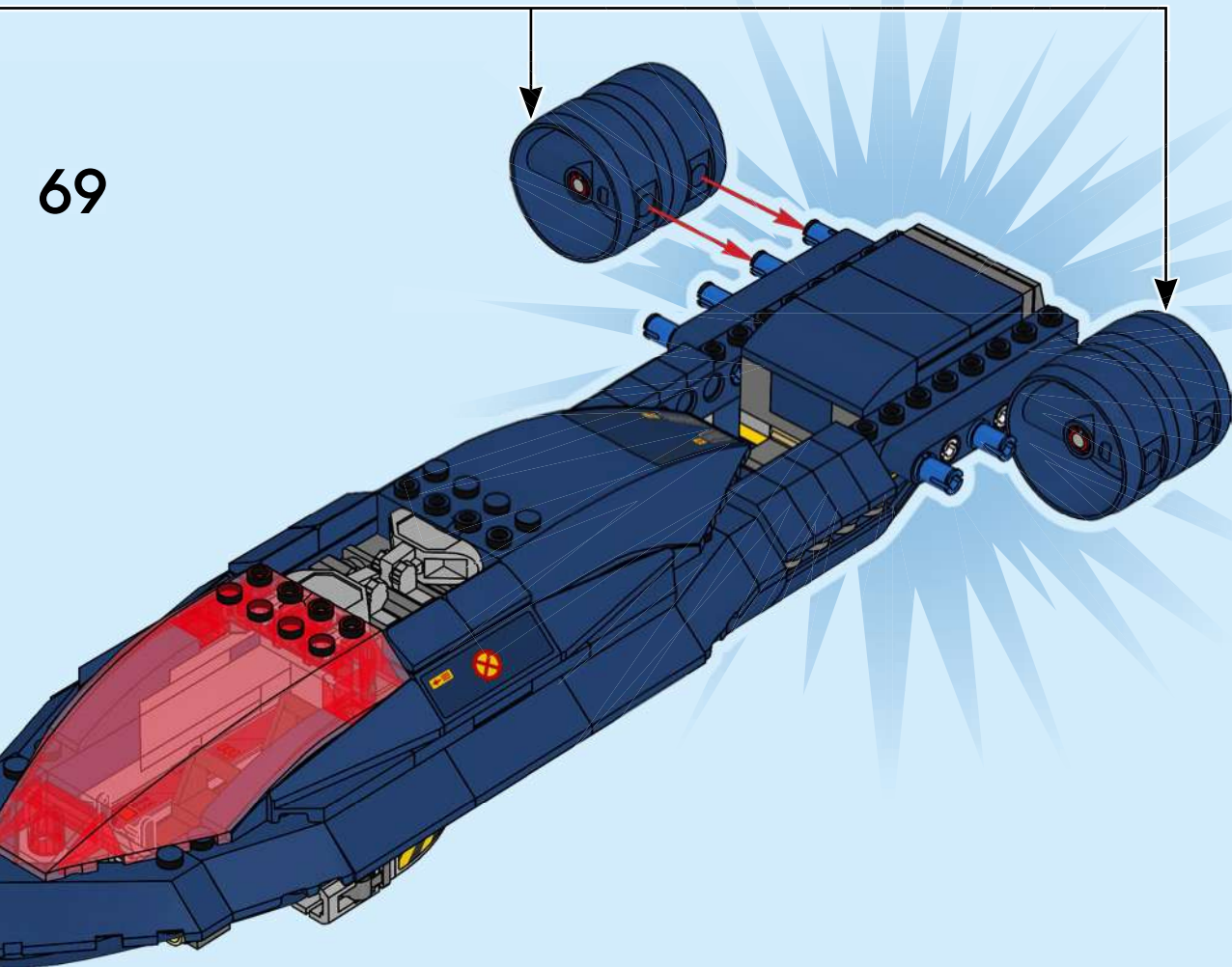

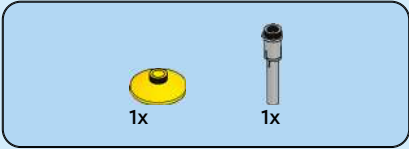

70

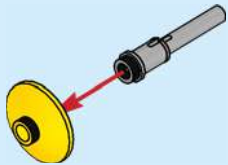

71

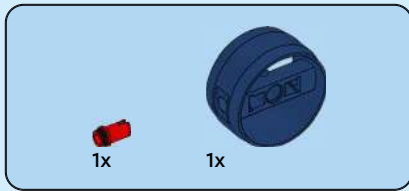
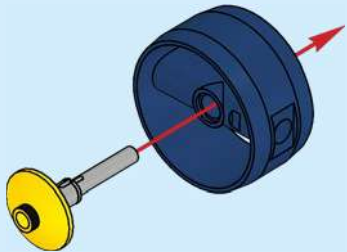

72

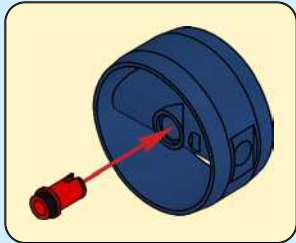

2x



73

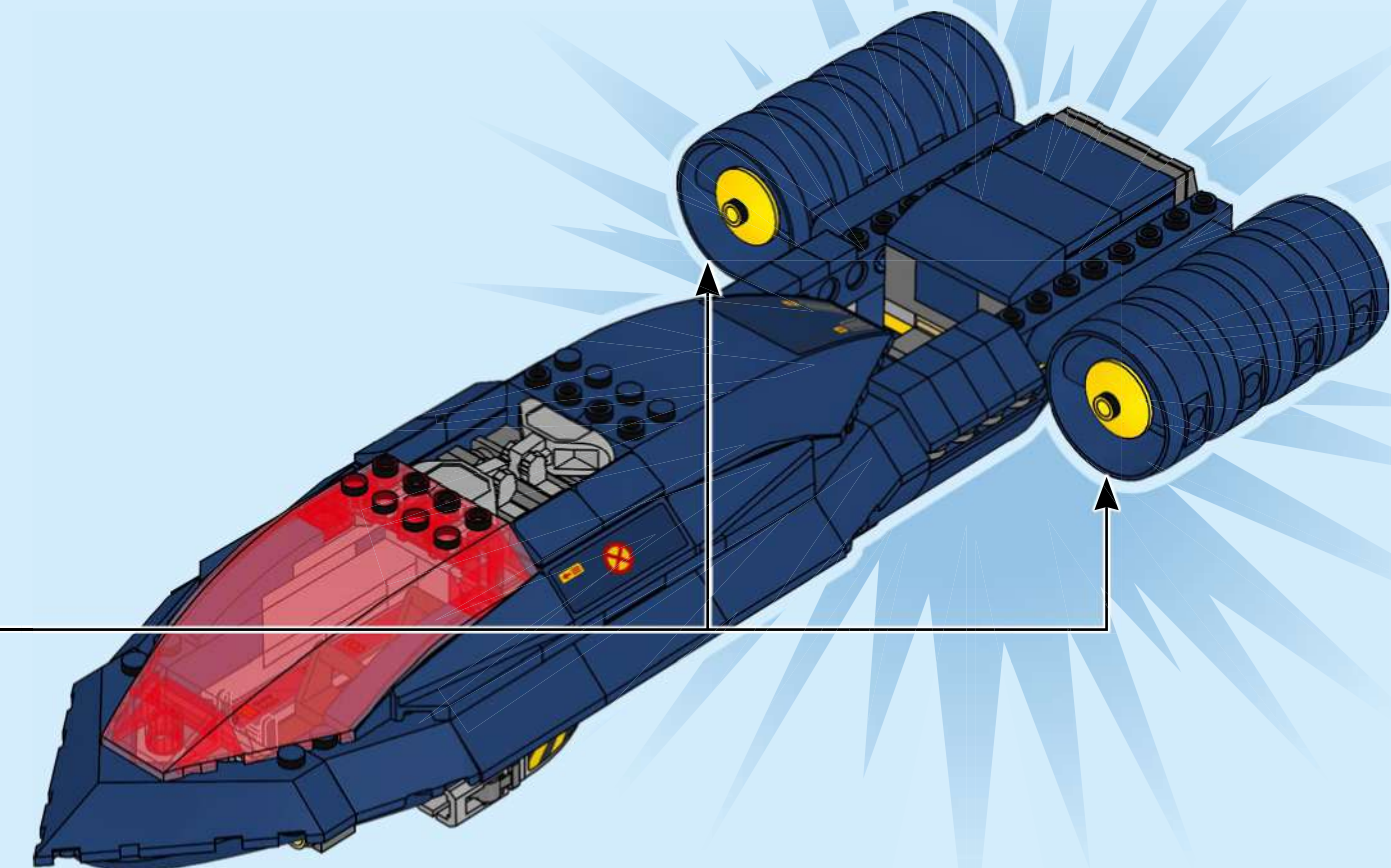

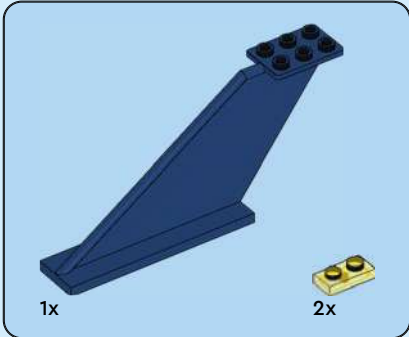
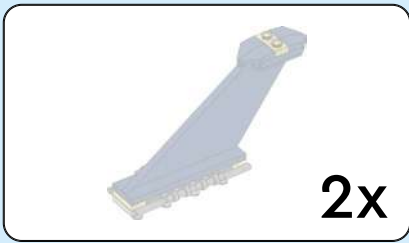

74

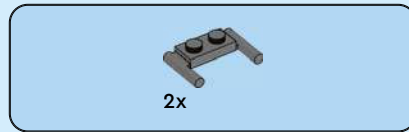
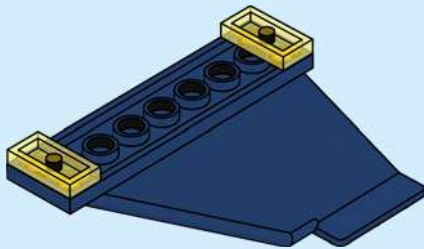

75

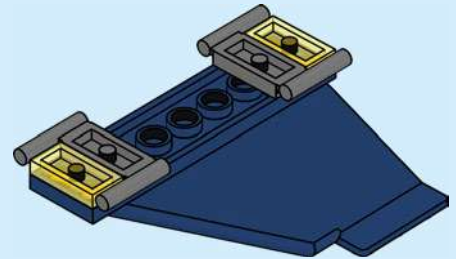



2x

76

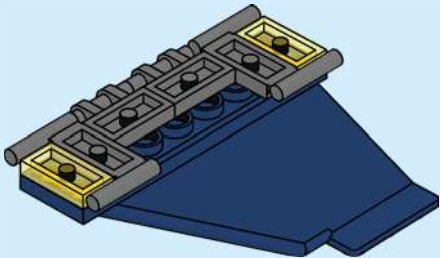

2x

77

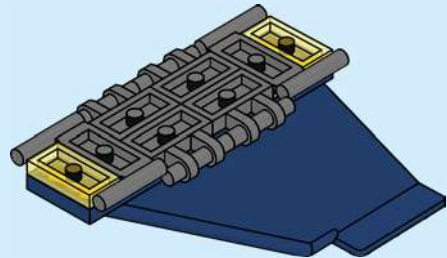



4x

78

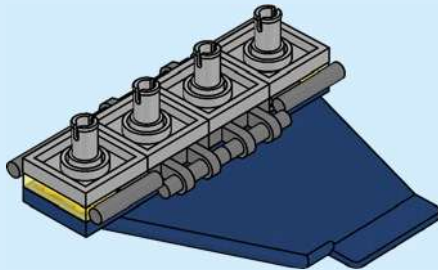

1x

79

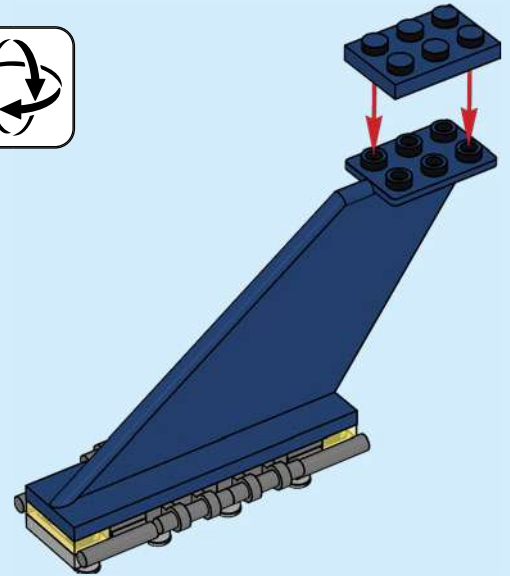
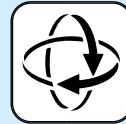



80

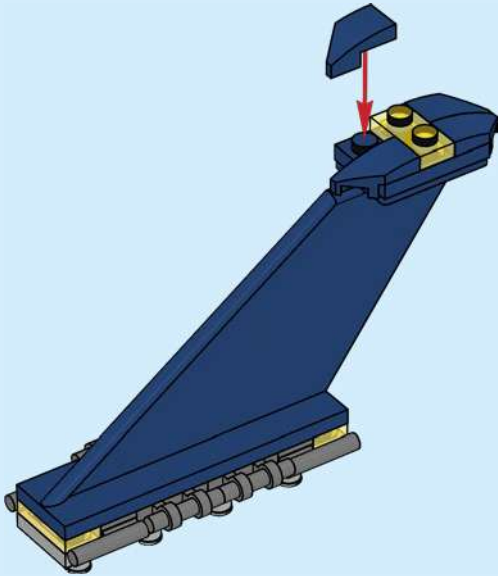

2x

81

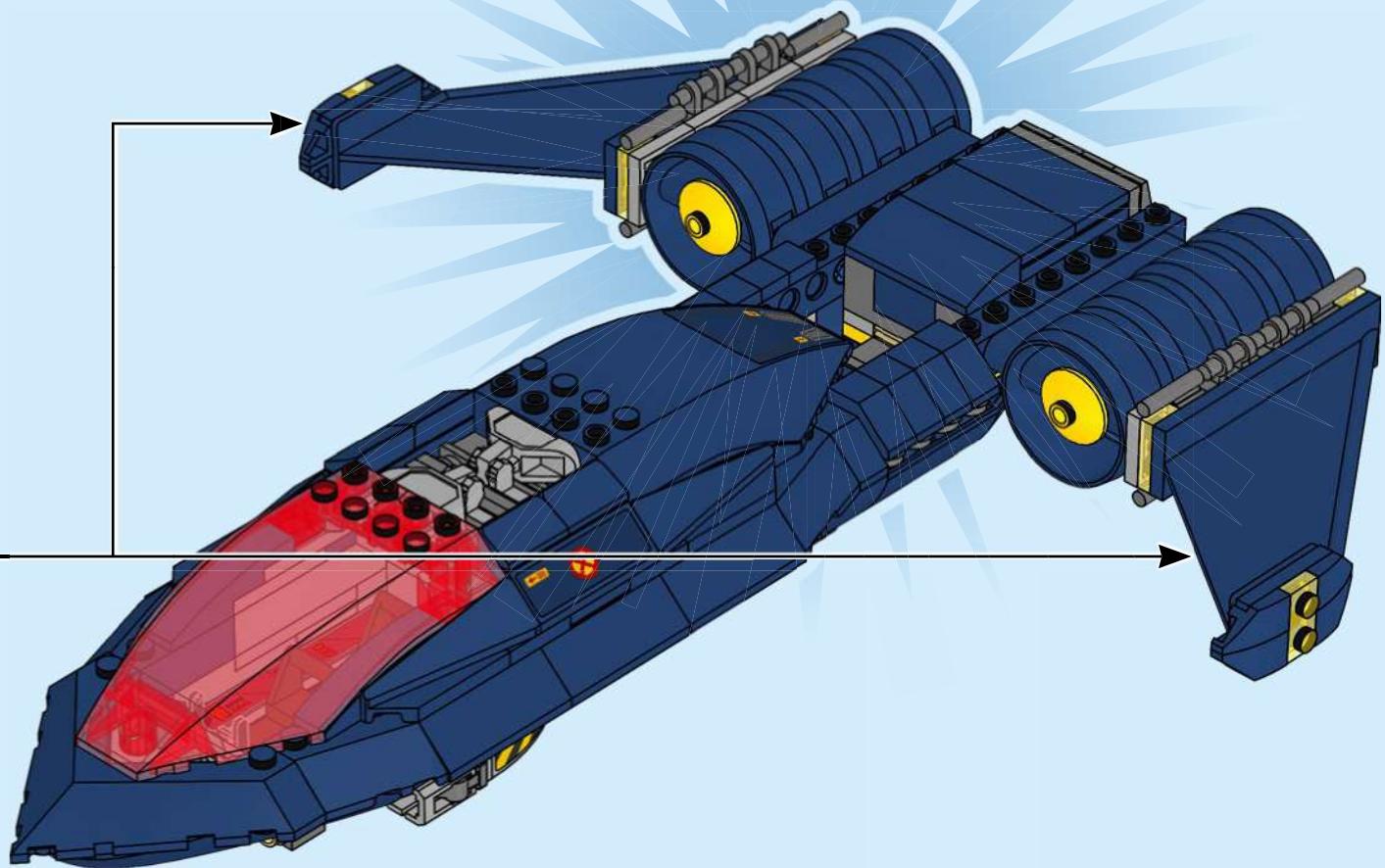

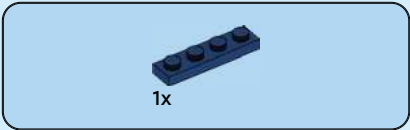

82

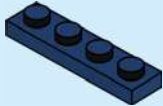

83

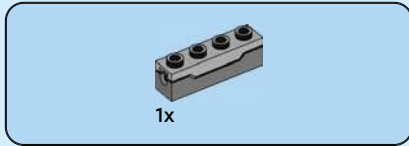
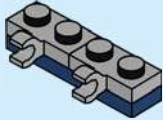

84

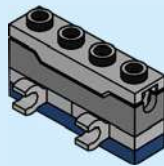

85

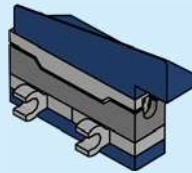

86

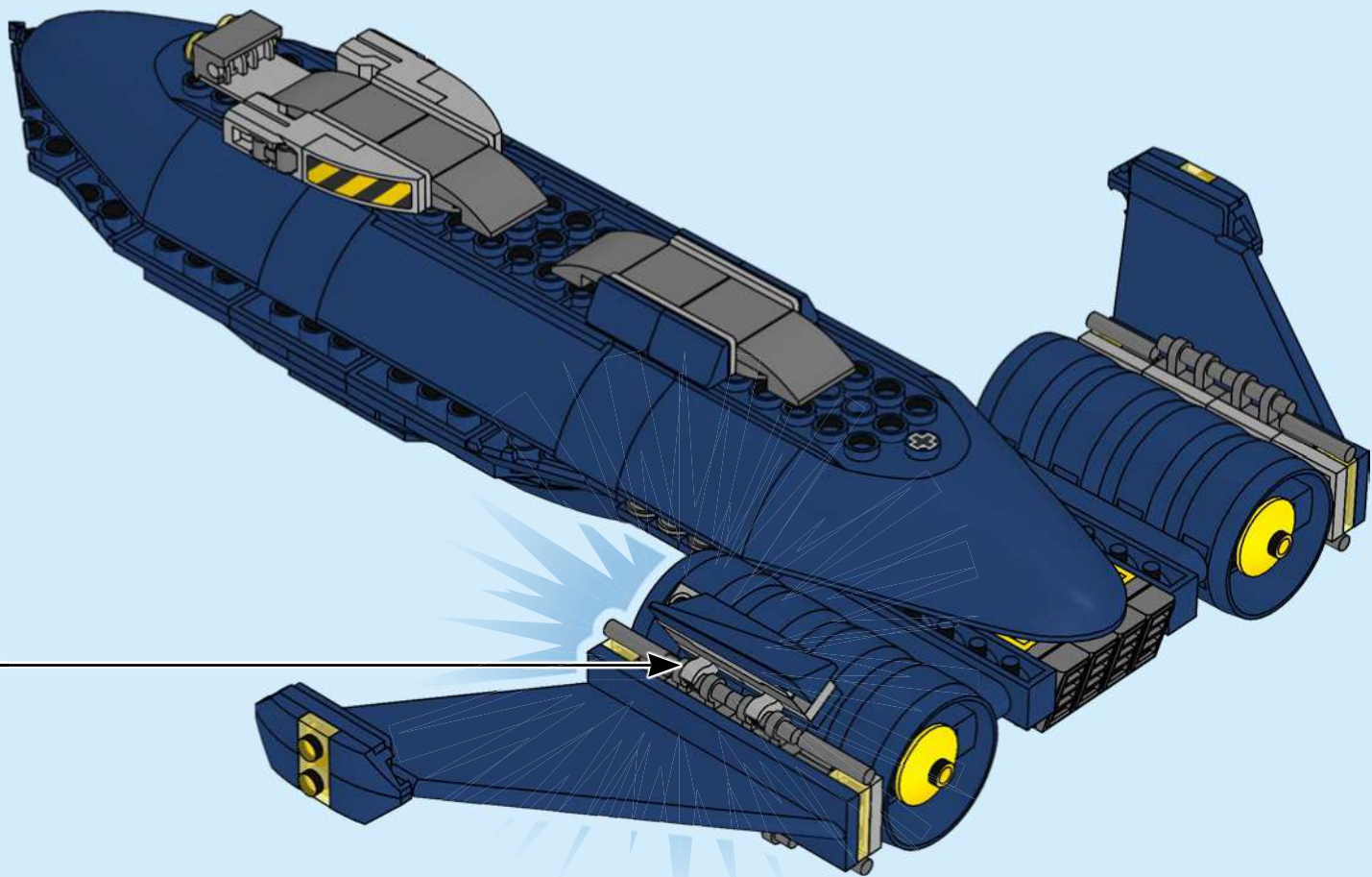
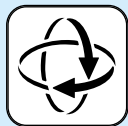

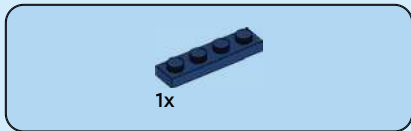

87



88

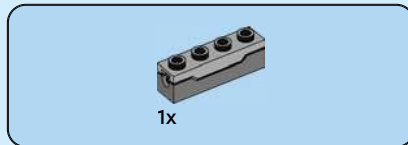
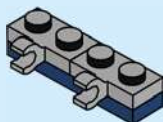

89

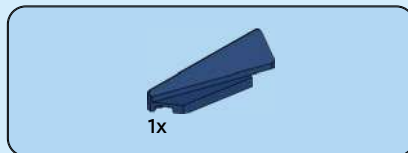
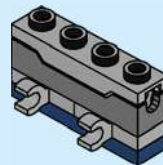

90

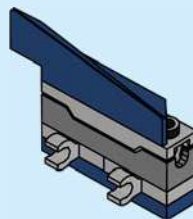

91

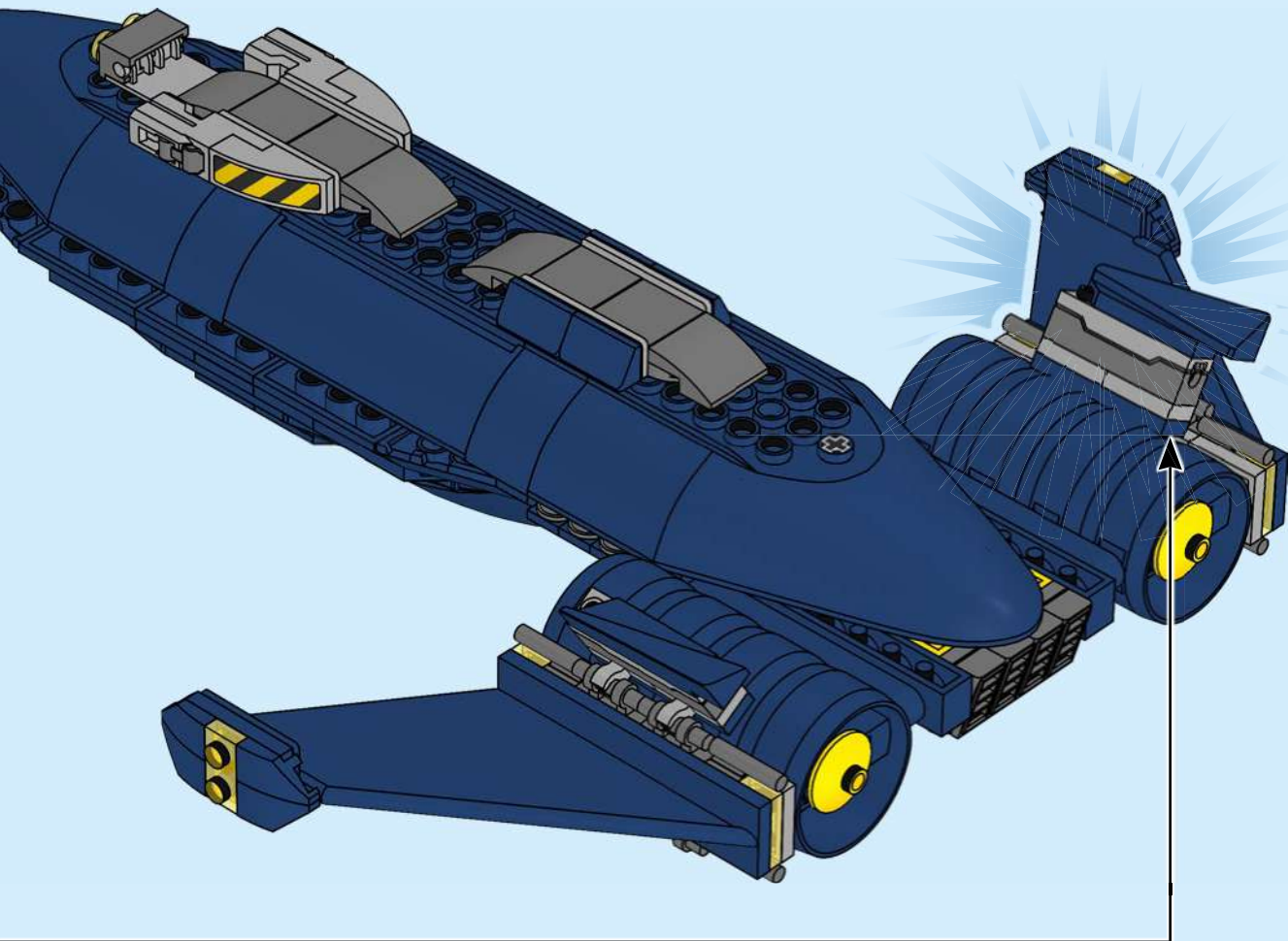



92

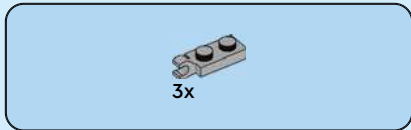
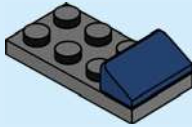

93

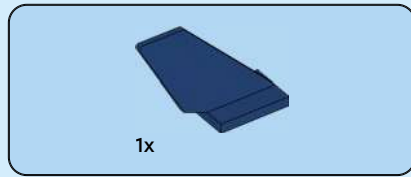
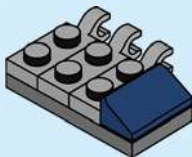

94

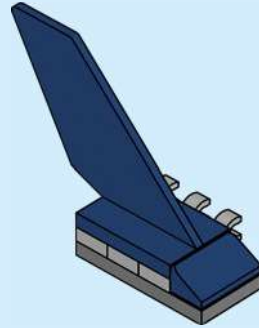

95

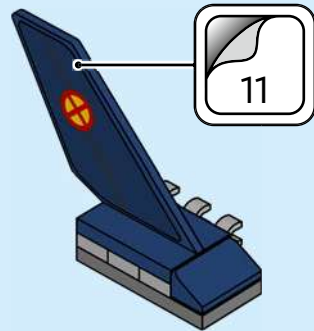

96

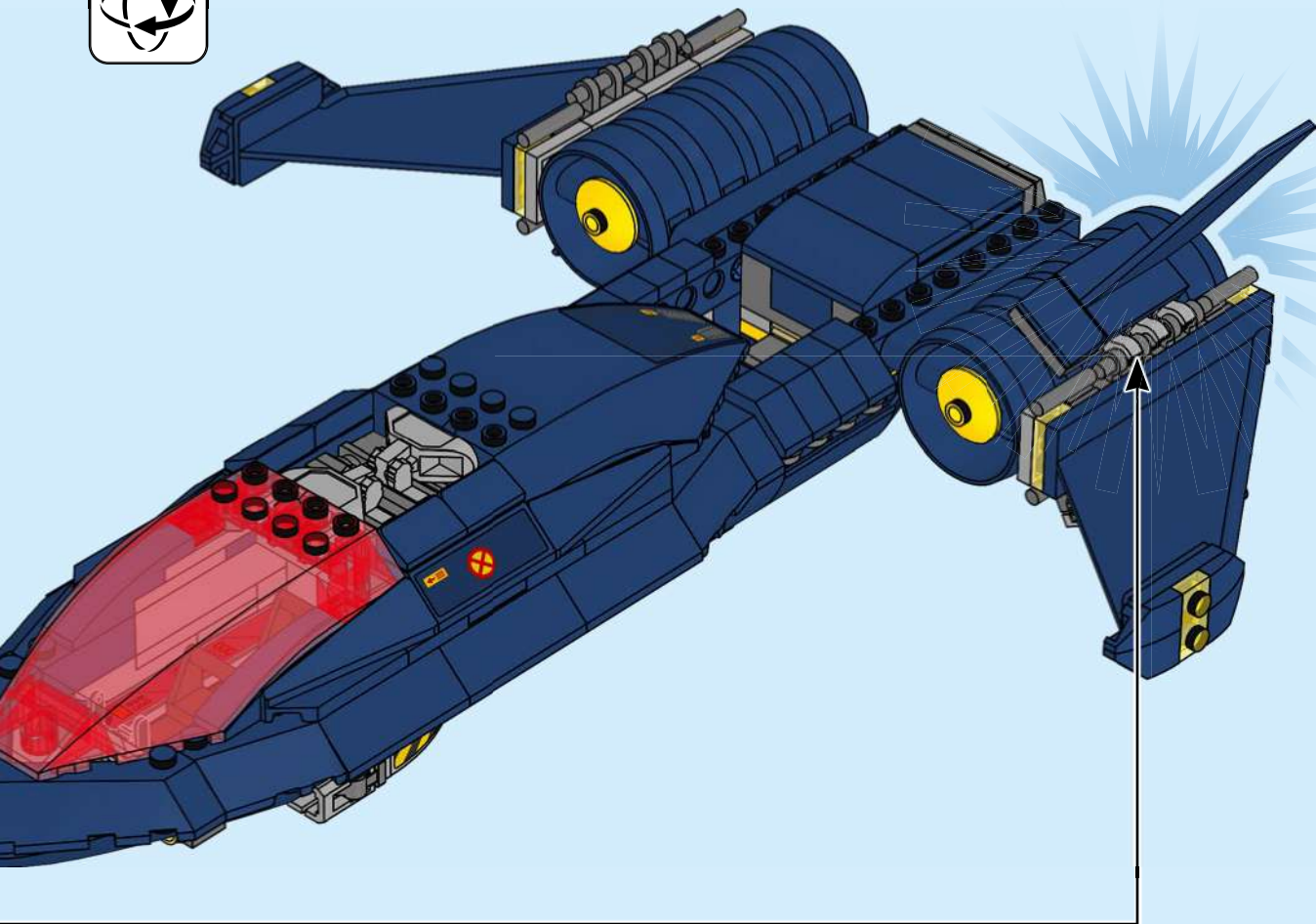



97

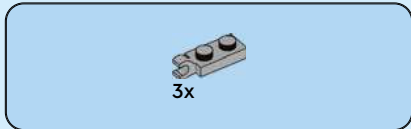

98

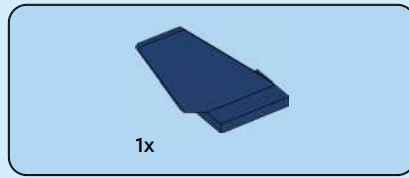
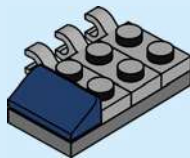

99

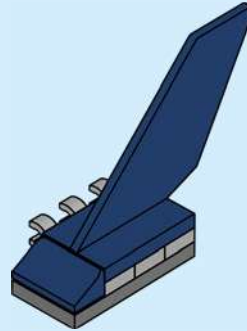

100

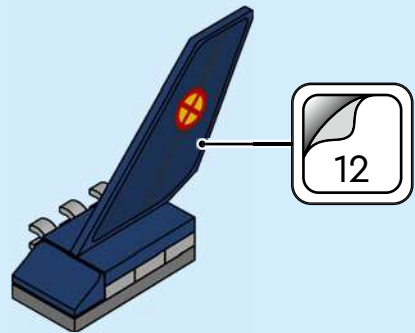

101

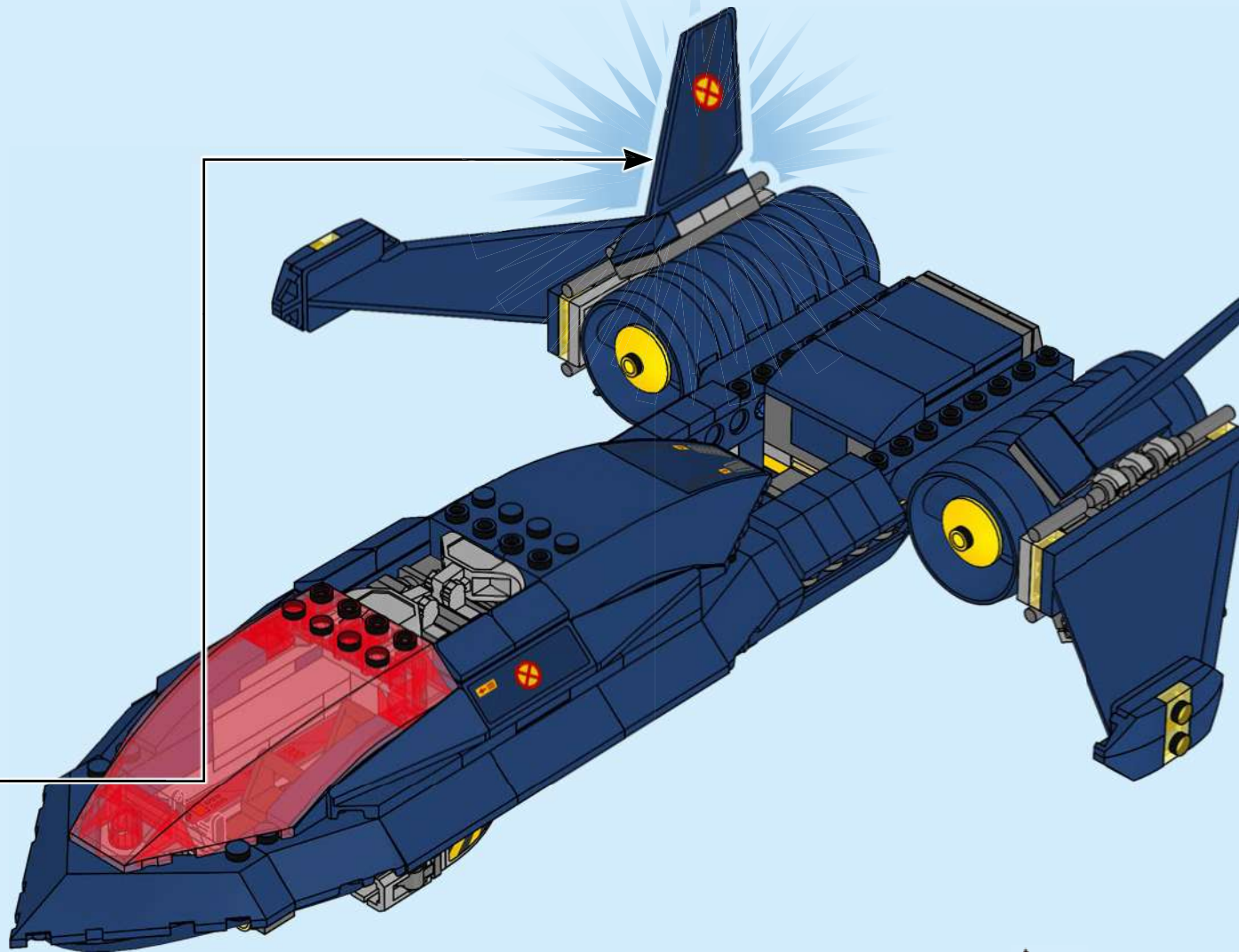

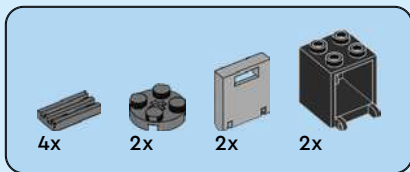

102

1



2



3

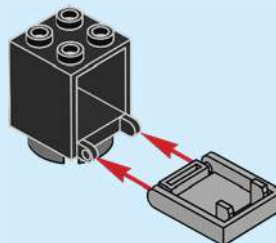

4



2x

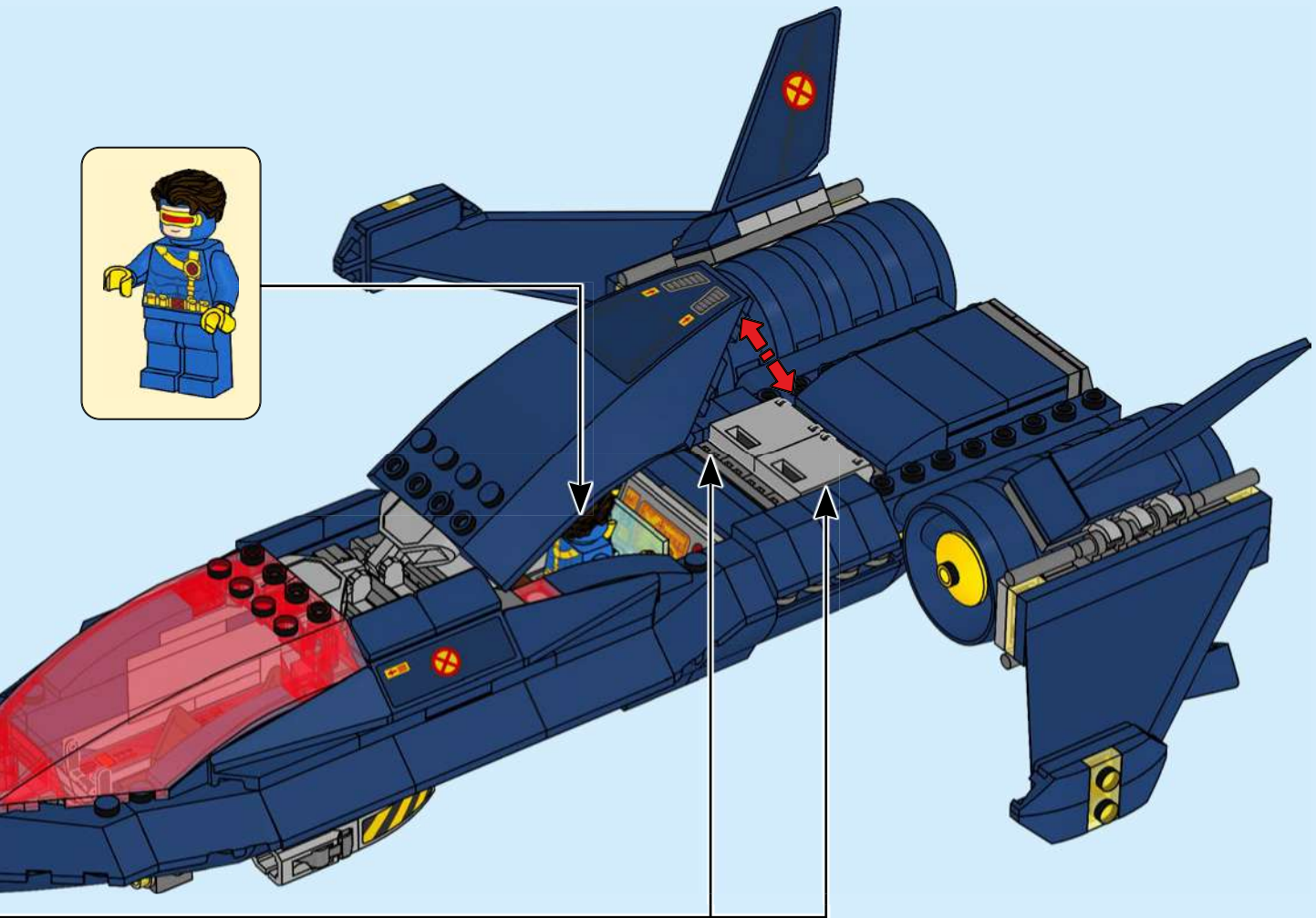

103



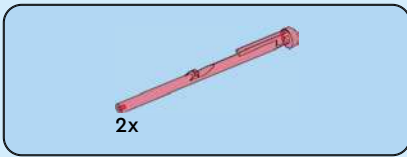

104

1

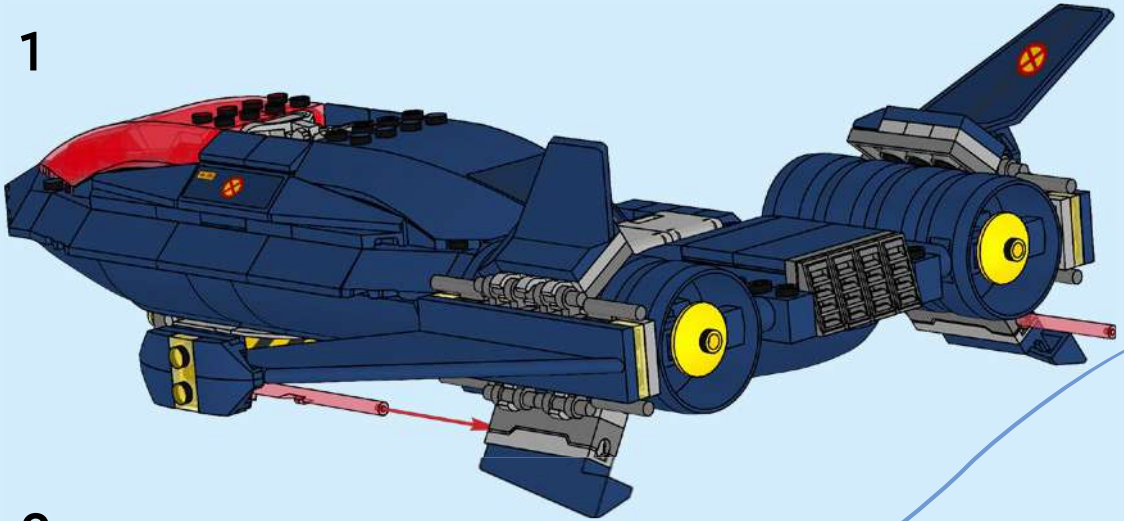

2

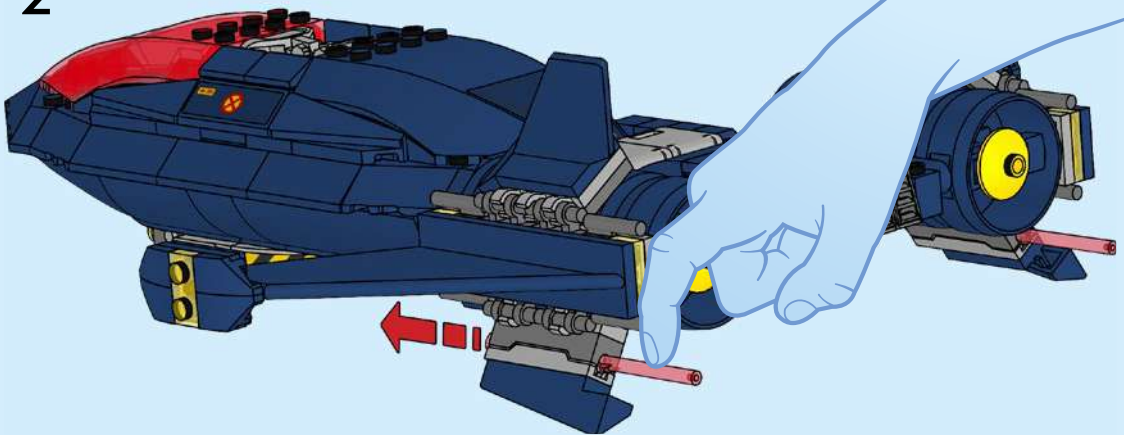

8x



105

1



2

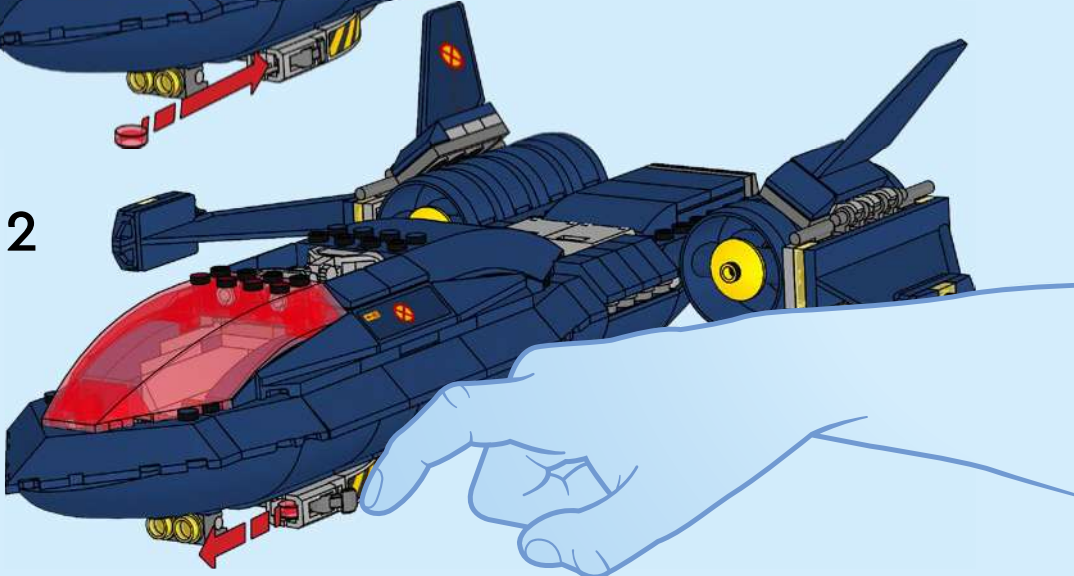



2x
6446788

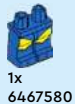

4x
302324



3

4x
6254248

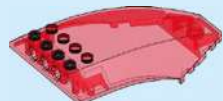

10x
6166857



8x
6482974

8x
4578094

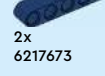
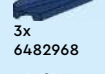
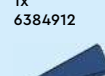
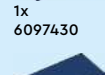

1x
6482966

2x
6482971

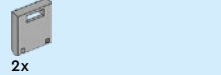
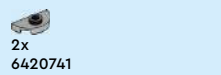
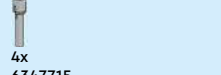
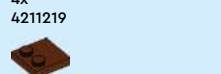
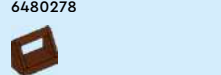
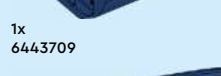
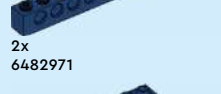

2x
4211492

1x
6130007



8x
6258607

1x
6376786



10x
6216905

4x
4528482



8x
6482974

1x
6097430



1x
6443709

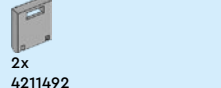
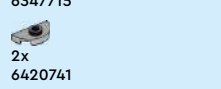
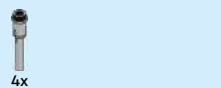
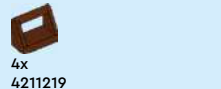

1x
370526



4x
6214811



2x
6440475



2x
6217673



4x
6347715



1x
6467583



4x
6214812



2x
6440475



2x
6217673



2x
6420741



7

4

1x
4211475

4x
6313114

4x
4211398

2x
6266209

2x
6217876

2x
6413107

6x
6319336

1x
4211881

8x
6276848

2x
4251163

8x
4211429

4x
6168615

2x
6360382

2x
6324200

6x
4211445

2x
6132872

1x
4211385

2x
4597901

2x
4211438

4x
4211481

2x
4211522

2x
4211366

1x
6454362

4x
4540386

8x
4210631

1x
4211066

4x
6000606

2x
6308045

8x
4210660

4x
6344820

4x
6013082

4x
6177079

4x
4263176

2x
4211053

2x
6335115

4x
4211065

12x
4210633

2x
6360675

6x
4211042

2x
4560184

1x
6182451

1x
6471850

1x
6467579

1x
6471853

1x
6497097

2x
6004345

1x
6482483



1x
6482973



2x
6482965



 [LEGO.com/service](https://www.LEGO.com/service)

YOU COULD **WIN**

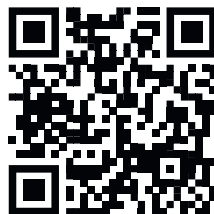

Scan this QR code or go to **LEGO.COM/PRODUCTFEEDBACK** and give us your short feedback about this LEGO® set for a chance to win a cool LEGO prize.

Terms and Conditions apply*



EN: YOU COULD WIN. Terms and Conditions apply* **DE: Du könntest GEWINNEN.** Es gelten die Teilnahmebedingungen* **FR: Tu pourrais GAGNER.** Des conditions s'appliquent* **IT: Potresti VINCERE tu.** Termini e condizioni sono applicabili* **ES: Puedes GANAR.** Aplican términos y condiciones* **PT: Poderá GANHAR.** Aplicam-se termos e condições* **ZH: 轻松获奖. 条款和条件适用*** **PL: Szansa na WYGRANĄ.** Obowiązują warunki korzystania* **CS: Máte šanci VYHRÁT.** Platí všeobecné smluvní podmínky* **SK: Máte šancu VYHRAŤ.** Platia všeobecné zmluvné podmienky* **HU: TE IS NYERHETSZ.** Felhasználási feltételek érvényesek* **RO: Ai putea CÂȘTIGA.** Se aplică termeni și condiții* **BG: Можете да СПЕЧЕЛИТЕ.** Има определени правила и условия* **LV: Tu vari LAIMĒT.** Ir spēkā noteikumi un nosacījumi.* **ET: Sul on võimalus VÕITA.** Kehtivad tingimused* **LT: Jūs galite LAIMĖTI.** Taikomos sąlygos*

*[LEGO.com/productfeedback-terms](https://www.lego.com/productfeedback-terms)

LEGO and the LEGO logo are trademarks of the LEGO Group. ©2024 The LEGO Group.
© 2024 MARVEL