

TITANIC

BOOK 3

THE UNSINKABLE OCEAN LINER

Though the RMS *Titanic* boasted many advanced safety features, outdated maritime safety regulations dictated that the liner only needed to have 20 lifeboats onboard: enough for just one third of her crew and passengers. When she collided with an iceberg at high speed just before midnight on April 14th, 1912 and quickly began to sink, the lack of lifeboats ensured only 710 people survived while more than 1,500 perished. As a direct result of the tragedy, new wide-ranging international safety standards were introduced, many of which are still in force today.

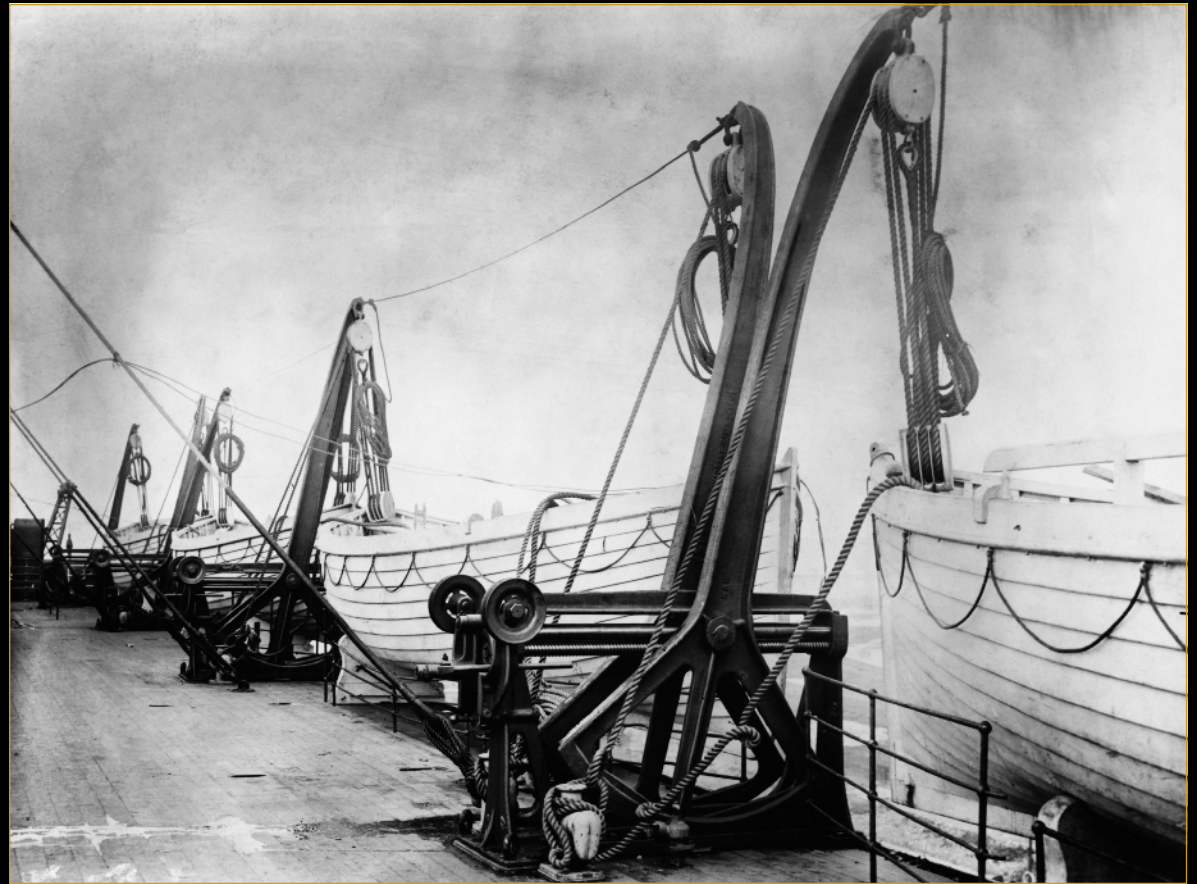

↑ Lifeboats in their davits on the *Titanic*.

IMPRESSIVE SCALE

At its launch, the *Titanic* was the largest man-made vessel ever constructed. She was over 269 meters (882.9 ft.) long and measured 53.3 meters (175 ft.) from the bottom of the hull to the top of her smokestacks. Likewise, the LEGO® version of the RMS *Titanic* is the longest LEGO model created so far and one of the most intricate.

The LEGO version of the Titanic is built at 1:200 scale, the same scale as the LEGO Architecture Statue of Liberty set.

The Titanic was 11 times as long as the blue whale, the largest animal ever known to have lived on Earth.





LEGO.com/brickseparator

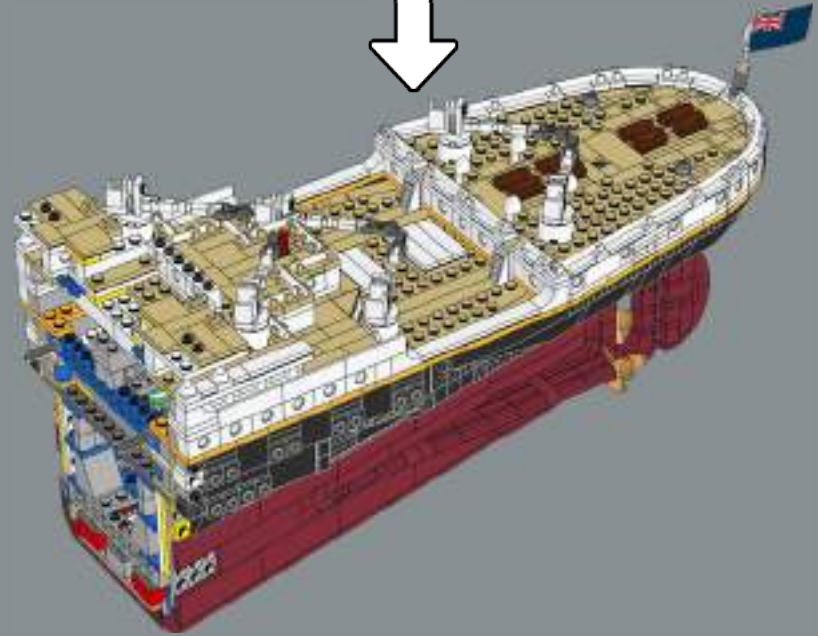
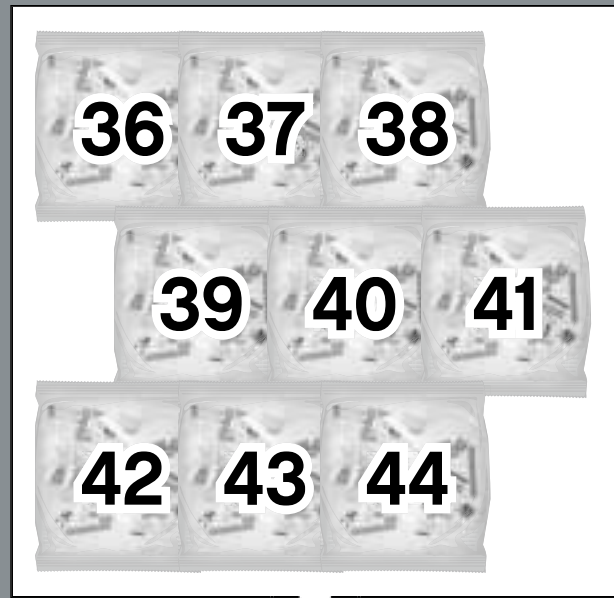
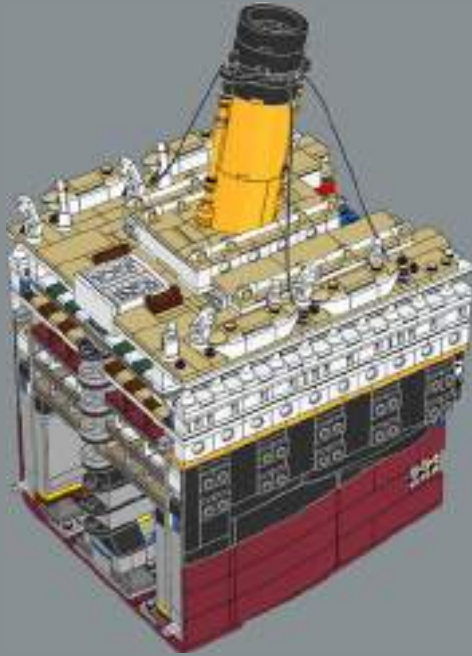
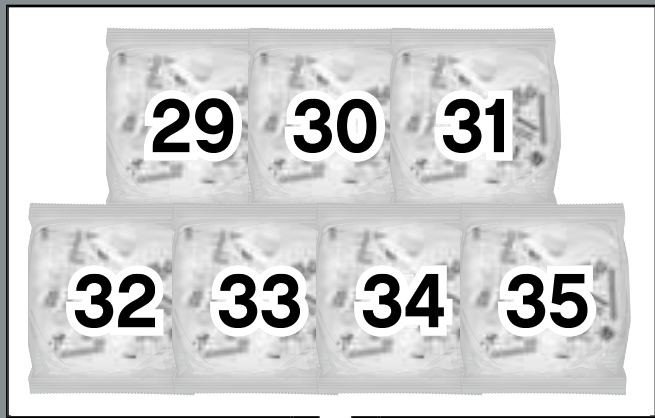

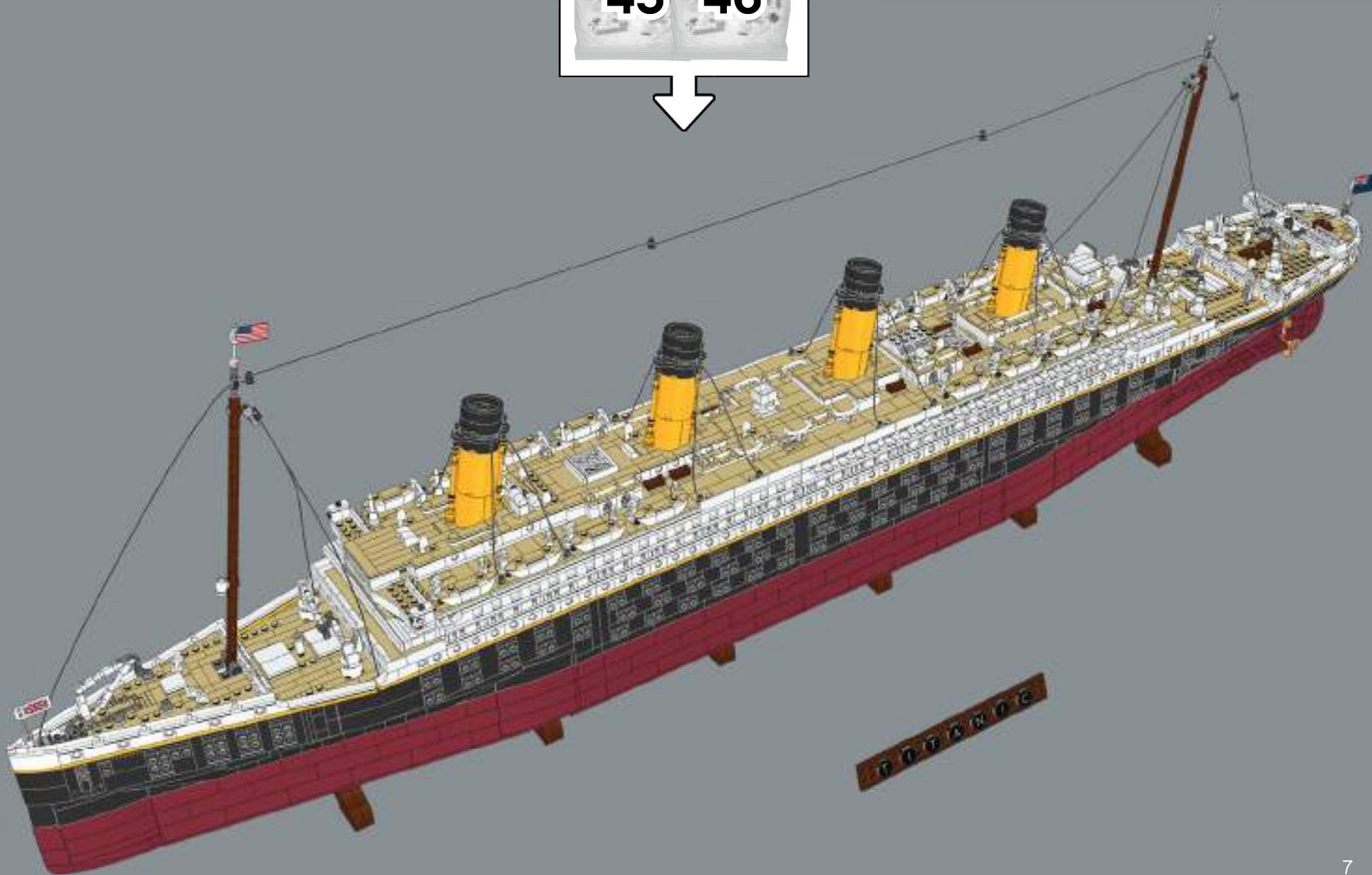
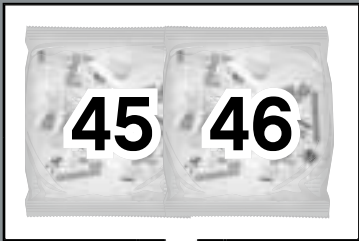

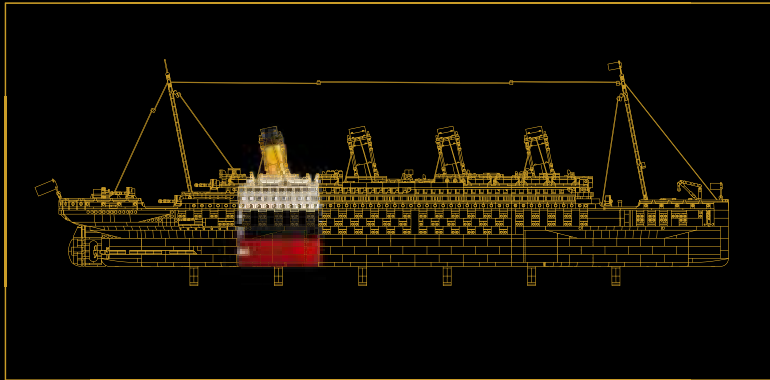

↓ At the top of this section, you will add the ship's reading room and some of its 2nd class cabins.



SECTION 5:

FUNNEL & ENGINE ROOM

In this section the model narrows as it tapers towards the propellers and rudder at the stern of the ship. You will also build the model's final funnel. On the real *Titanic*, this funnel was not connected to any boilers but was included in the design of the ship to make it feel more beautiful and complete.

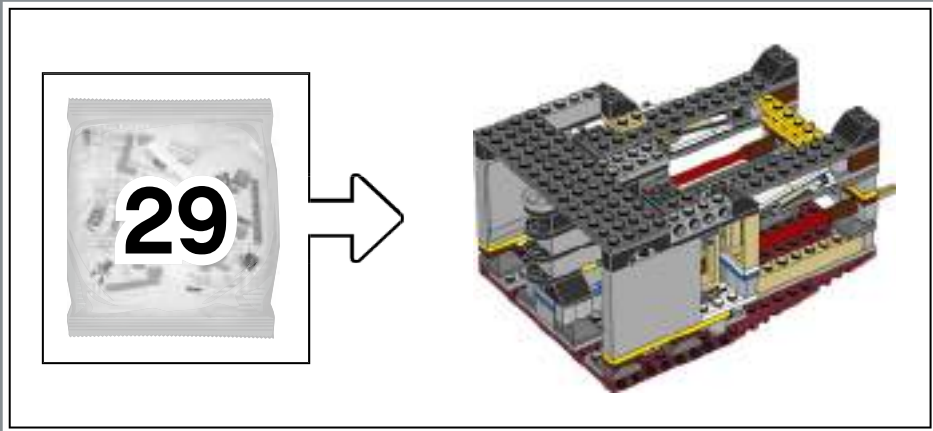

1

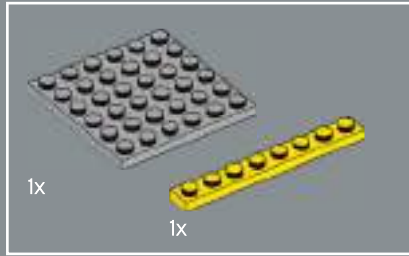
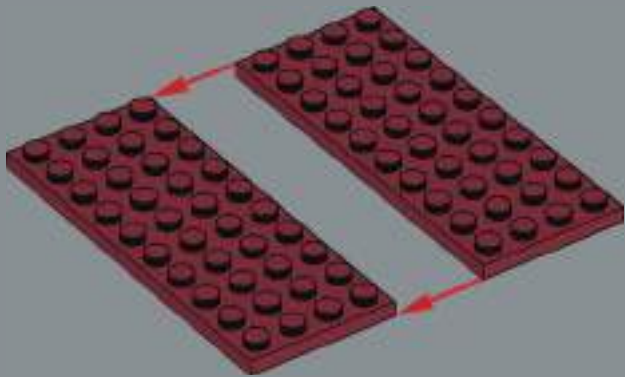

2

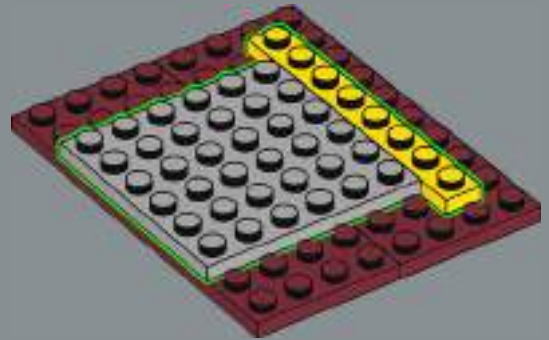

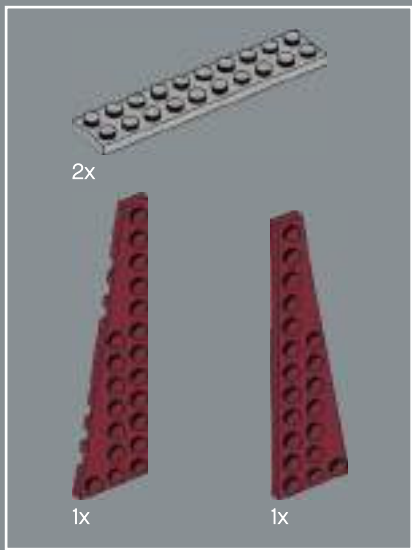

3

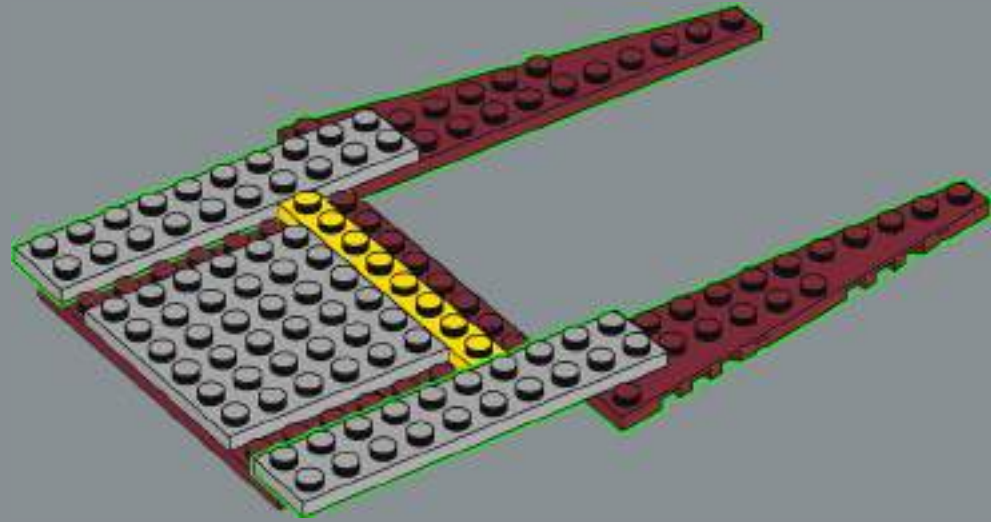

4

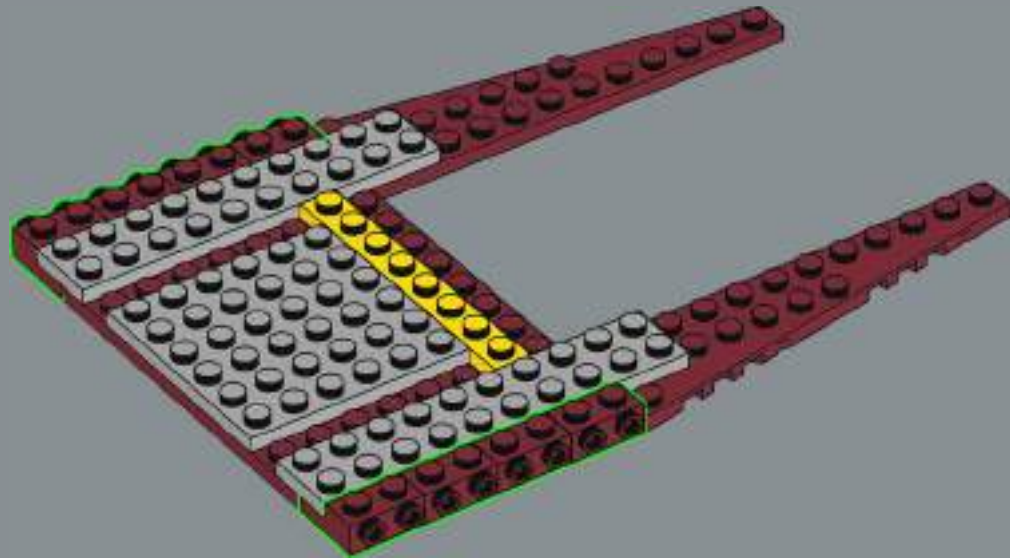

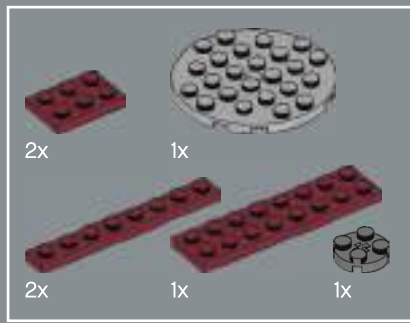

5

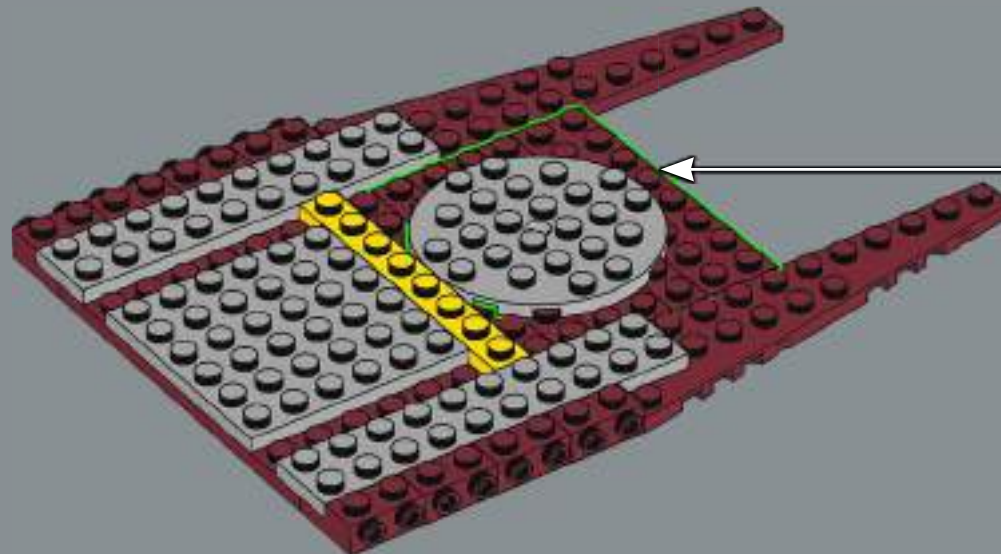
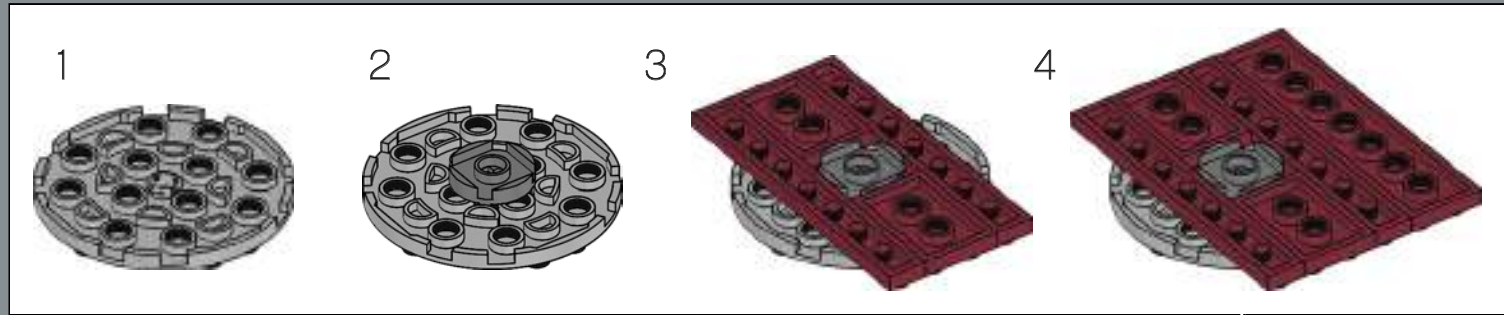

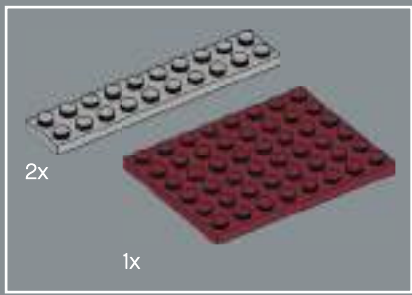

6

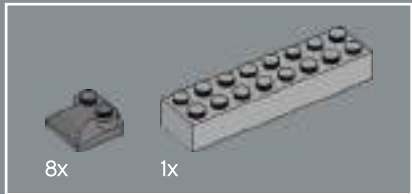
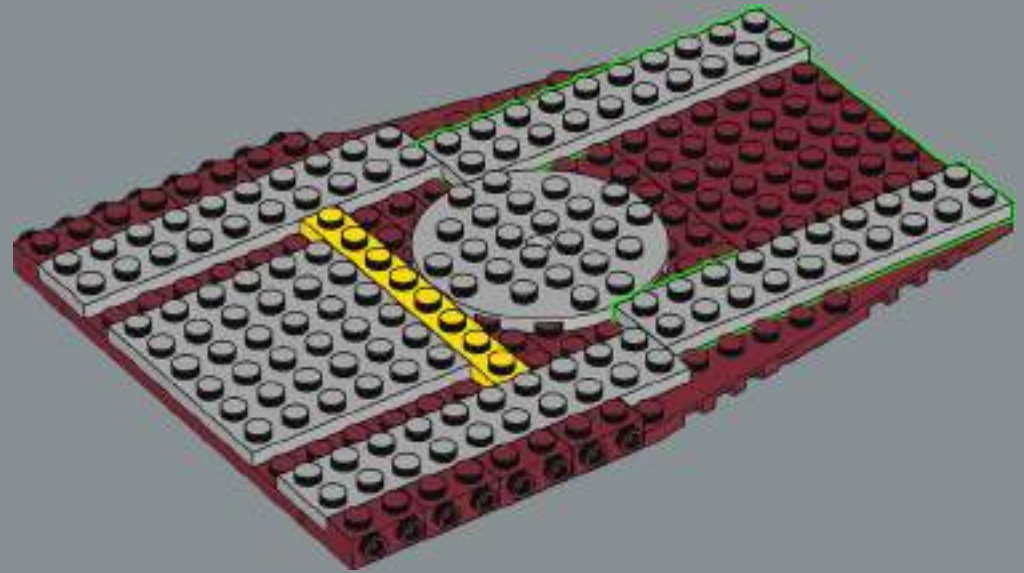

7

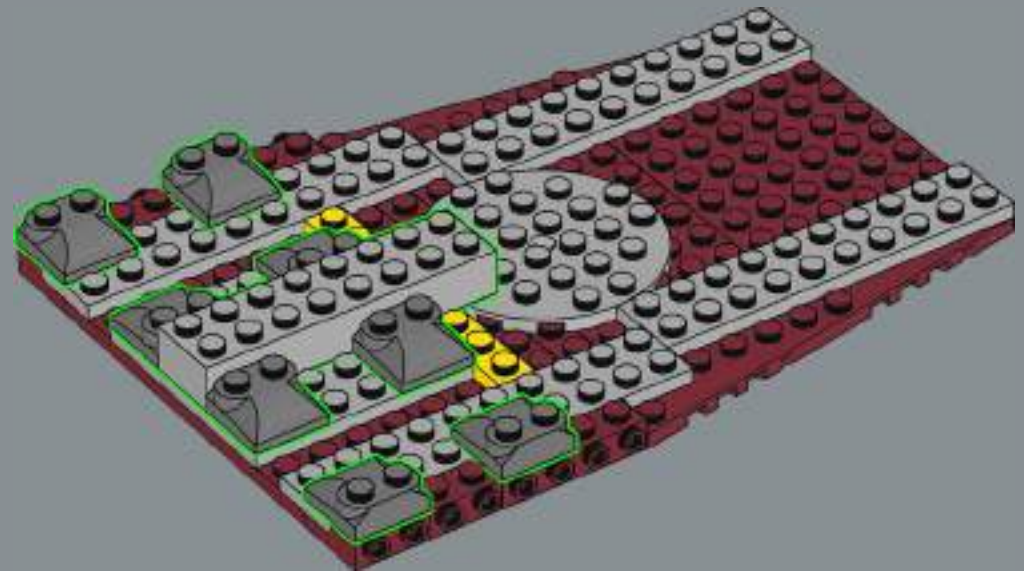



8

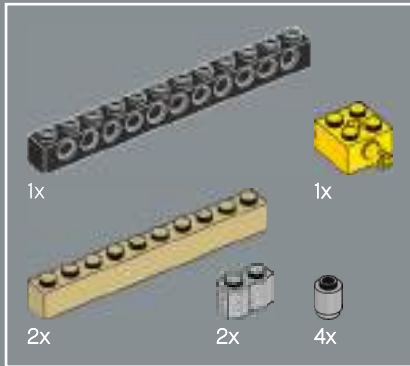
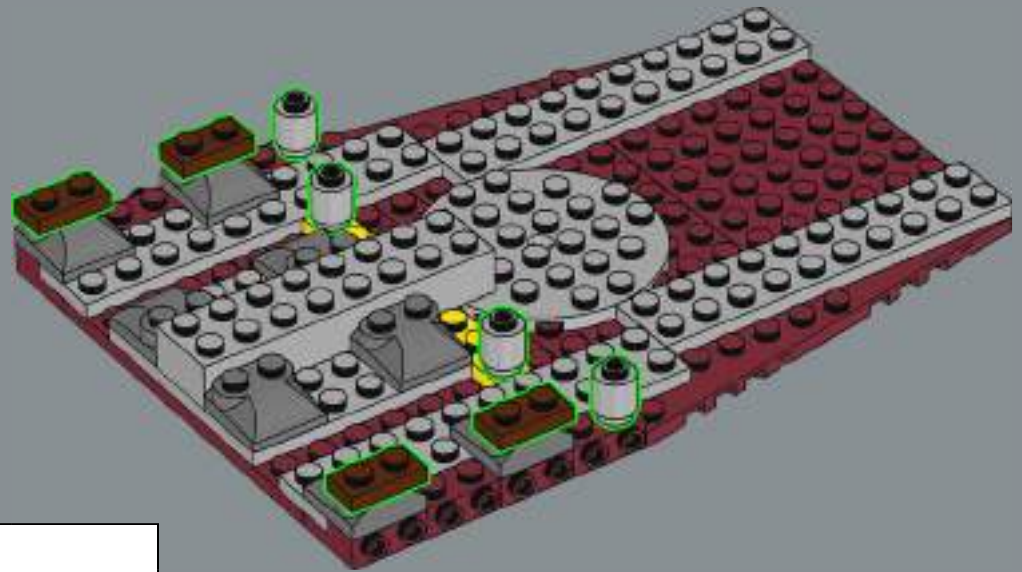

9

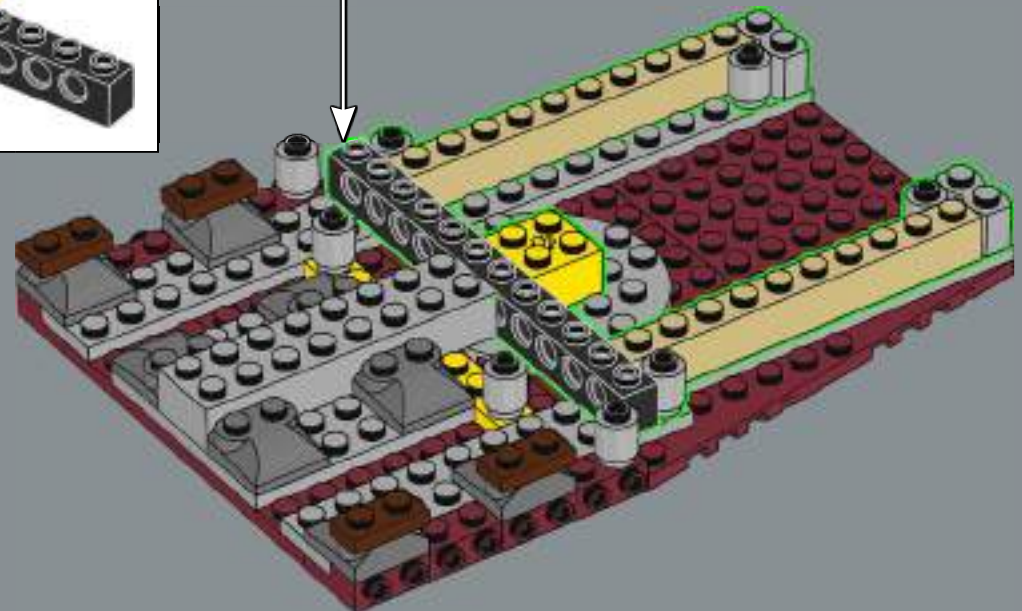
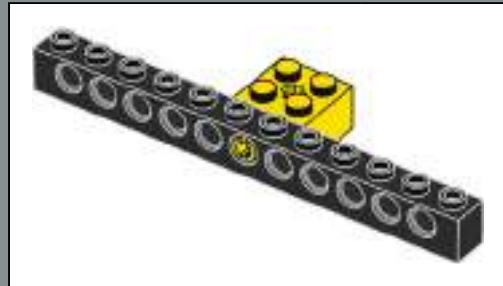

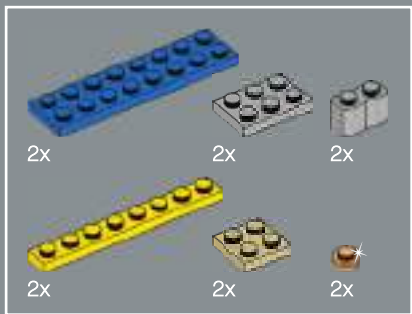

10

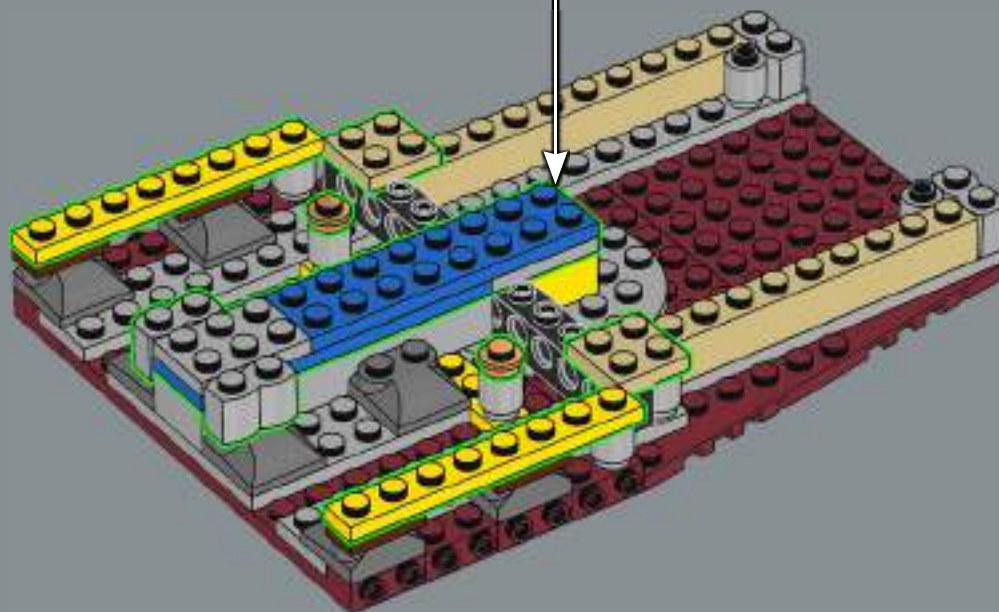
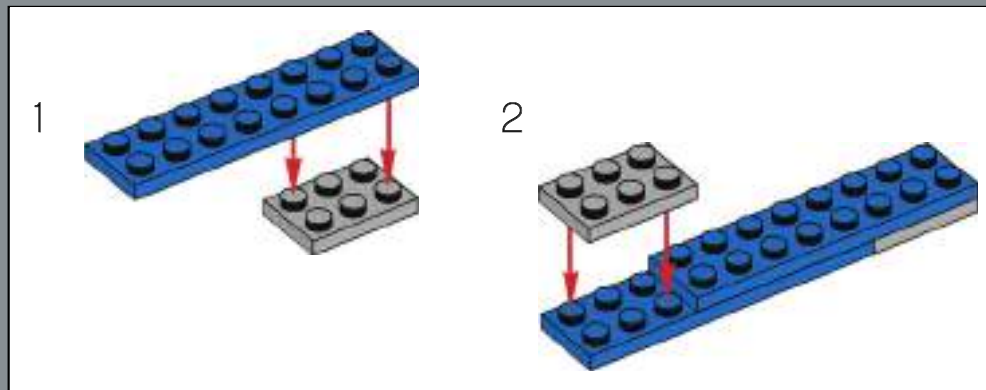

The *Titanic*'s electrical plant was capable of producing more power than an average city power station of the time.

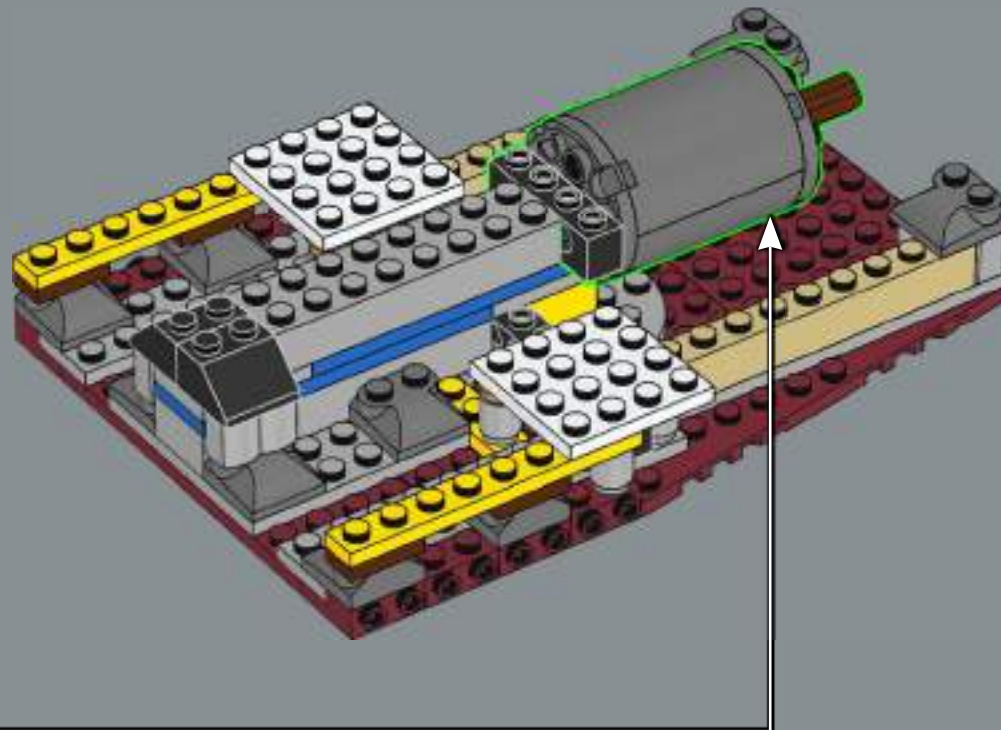

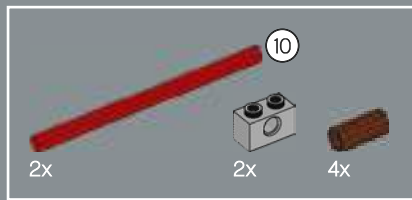

14

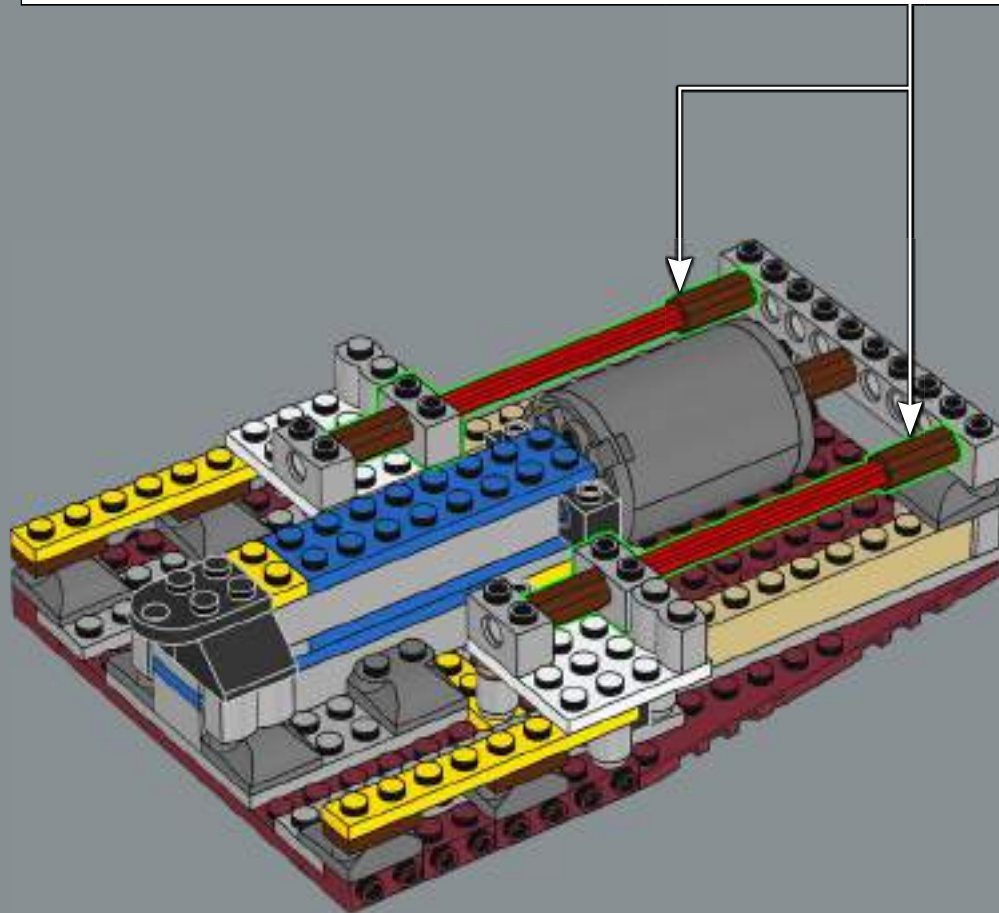
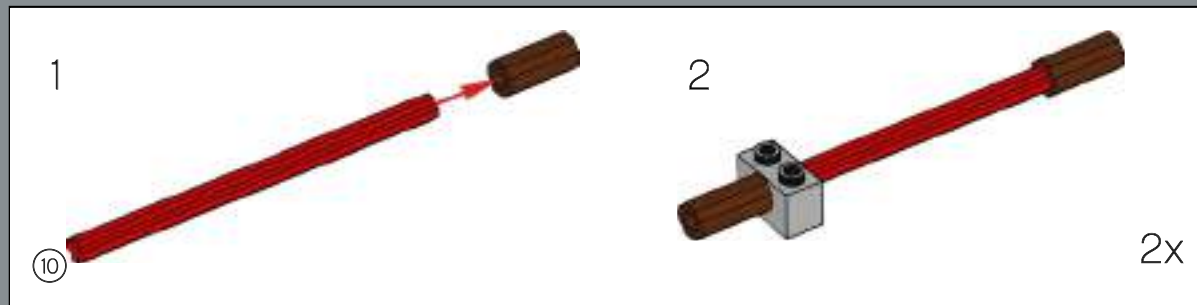



15

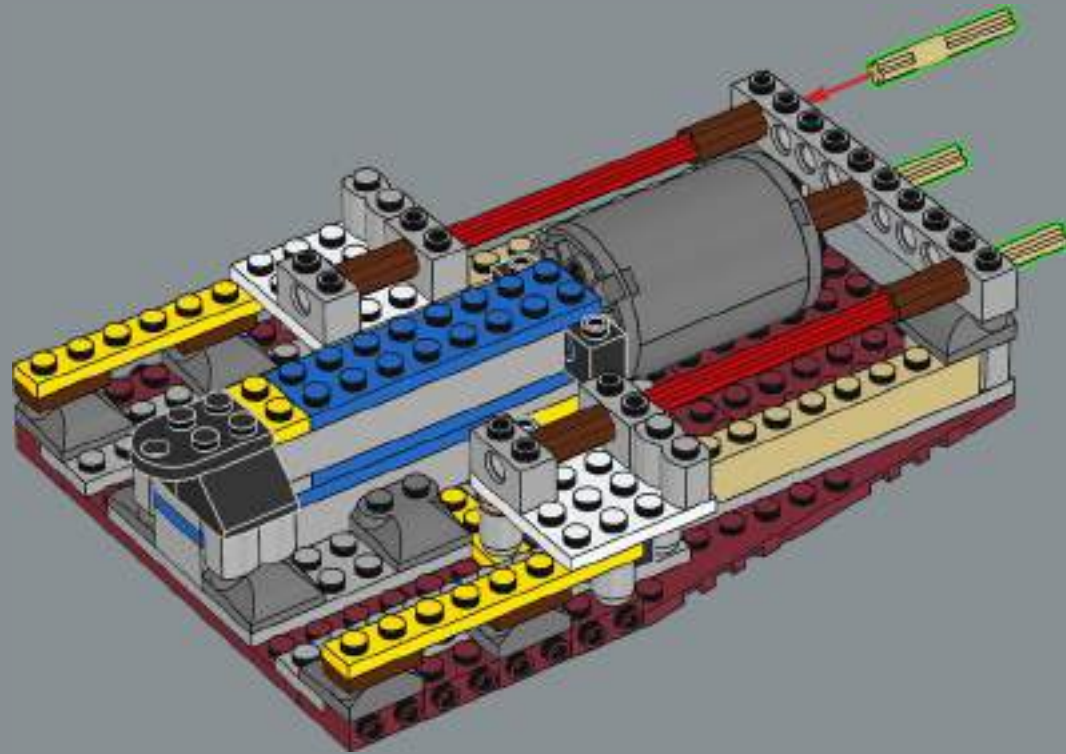

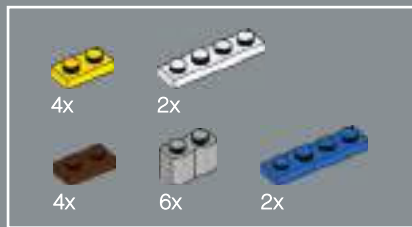

16

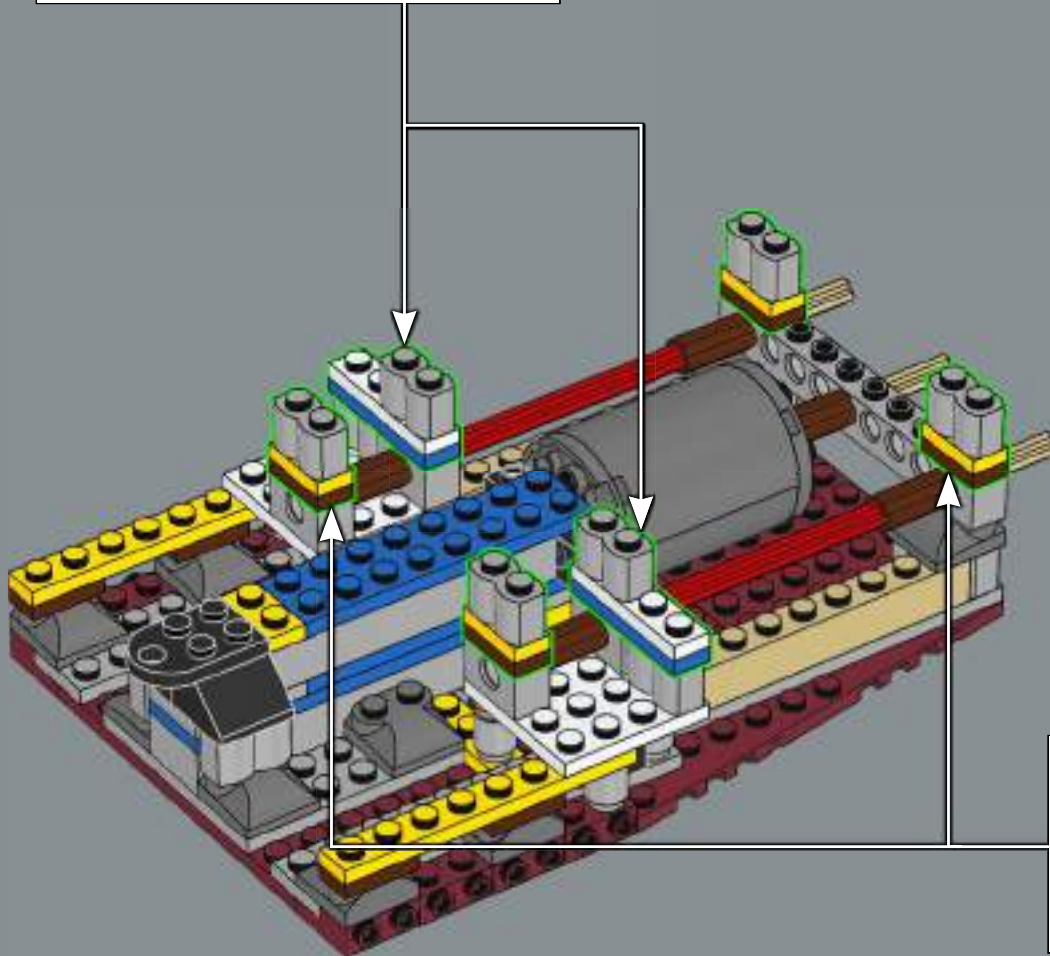
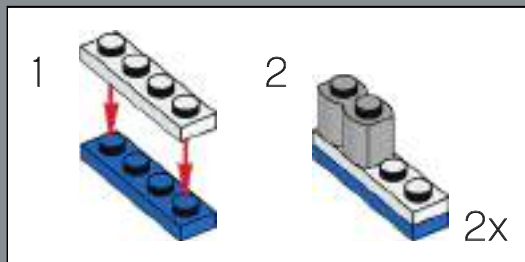

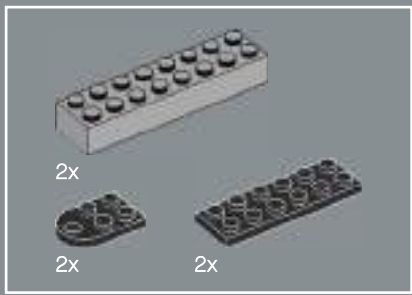

17

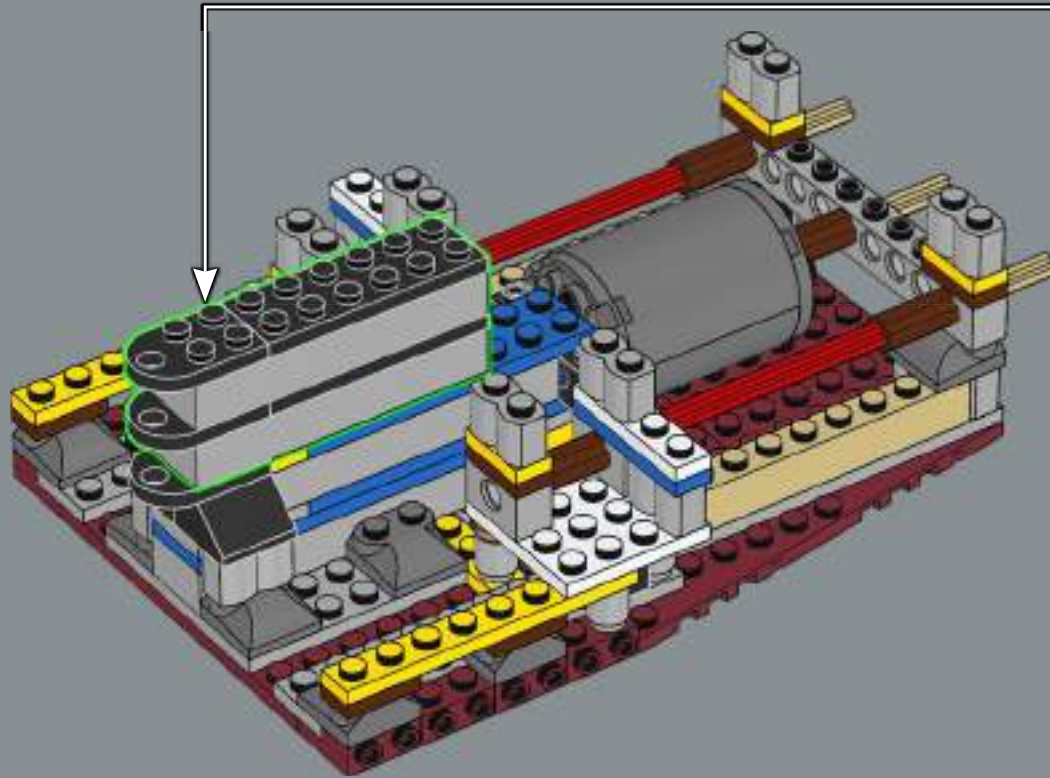
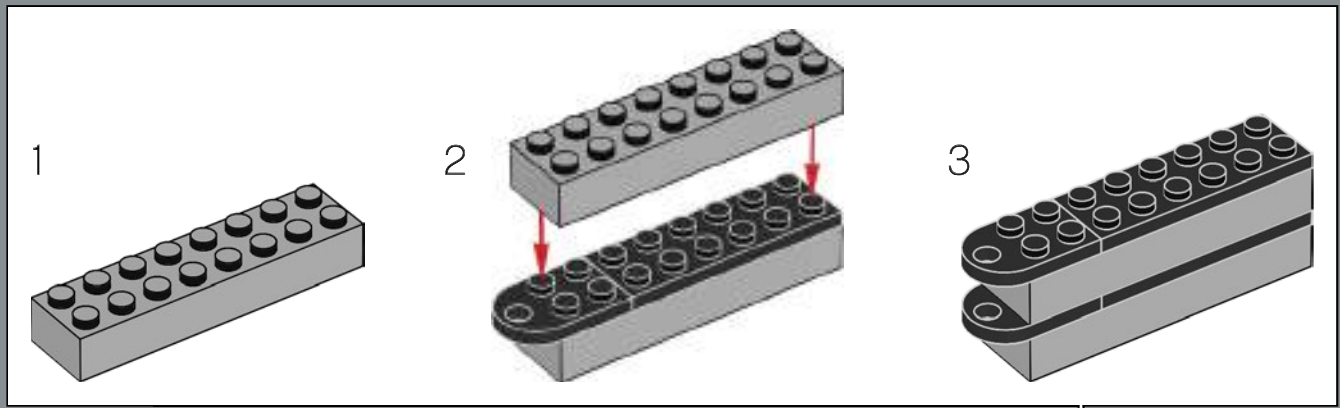

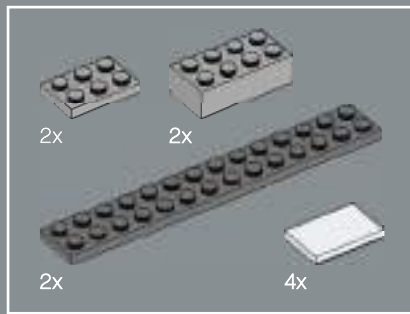

18

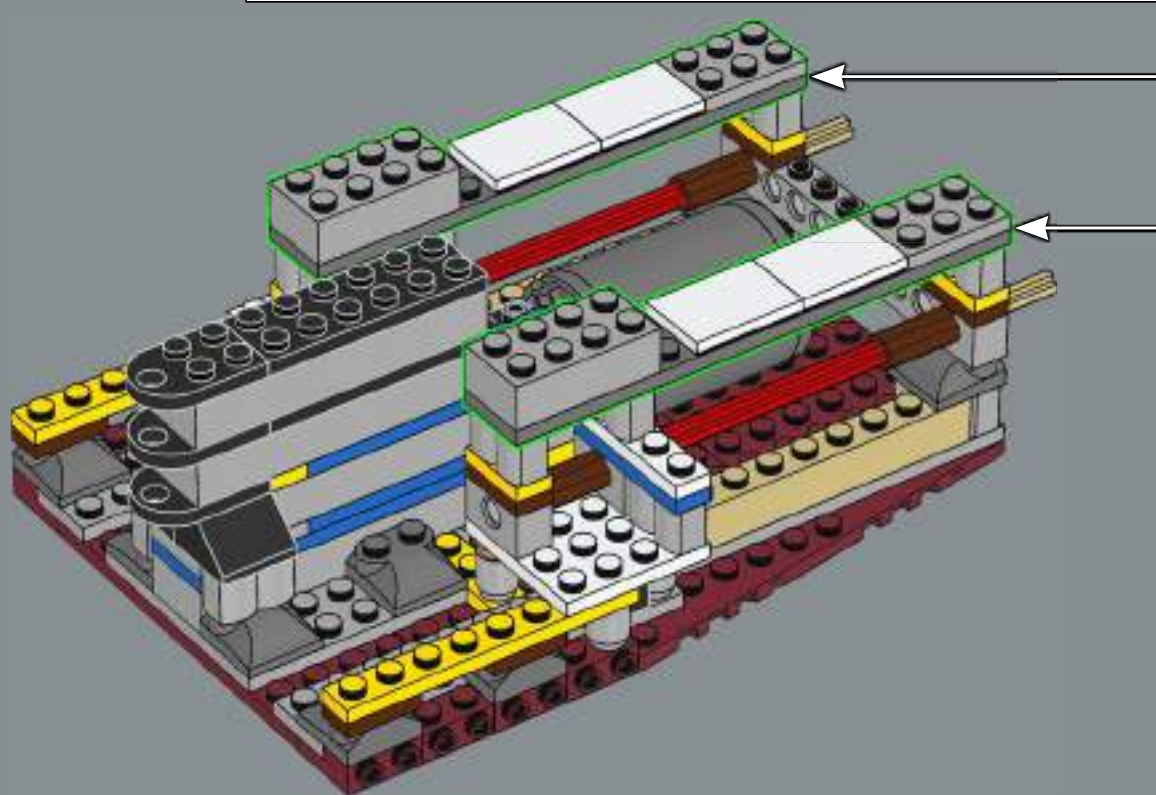
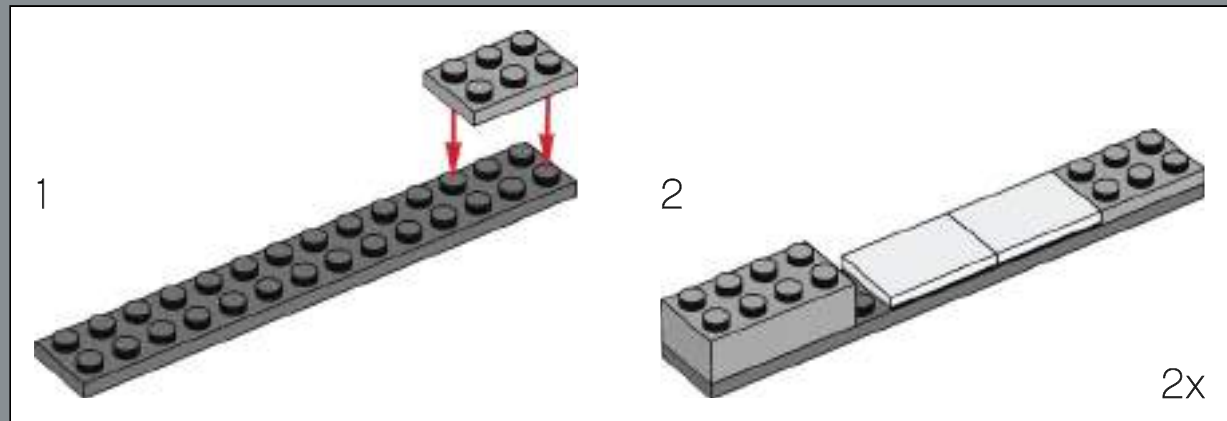



19

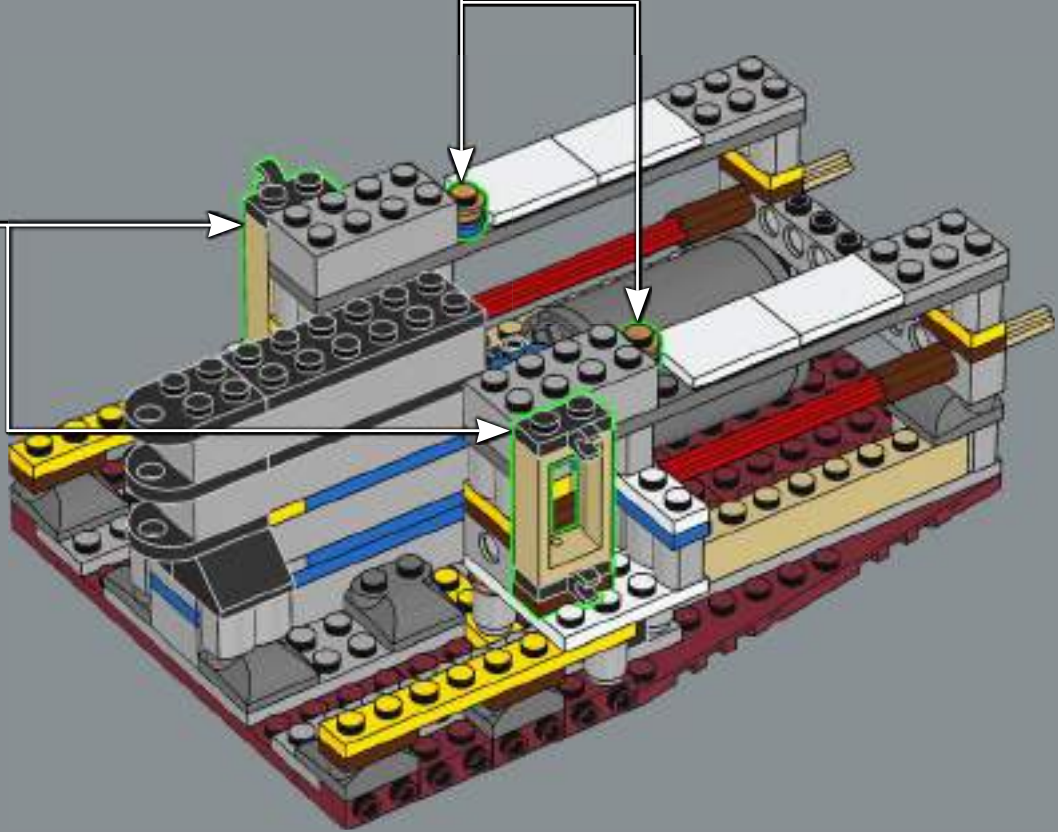
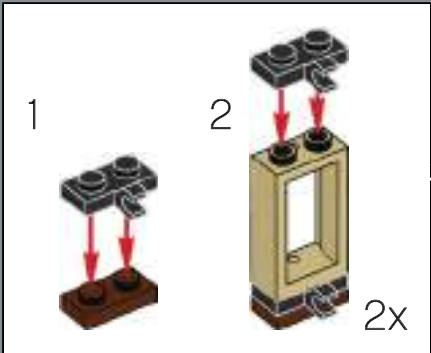



20



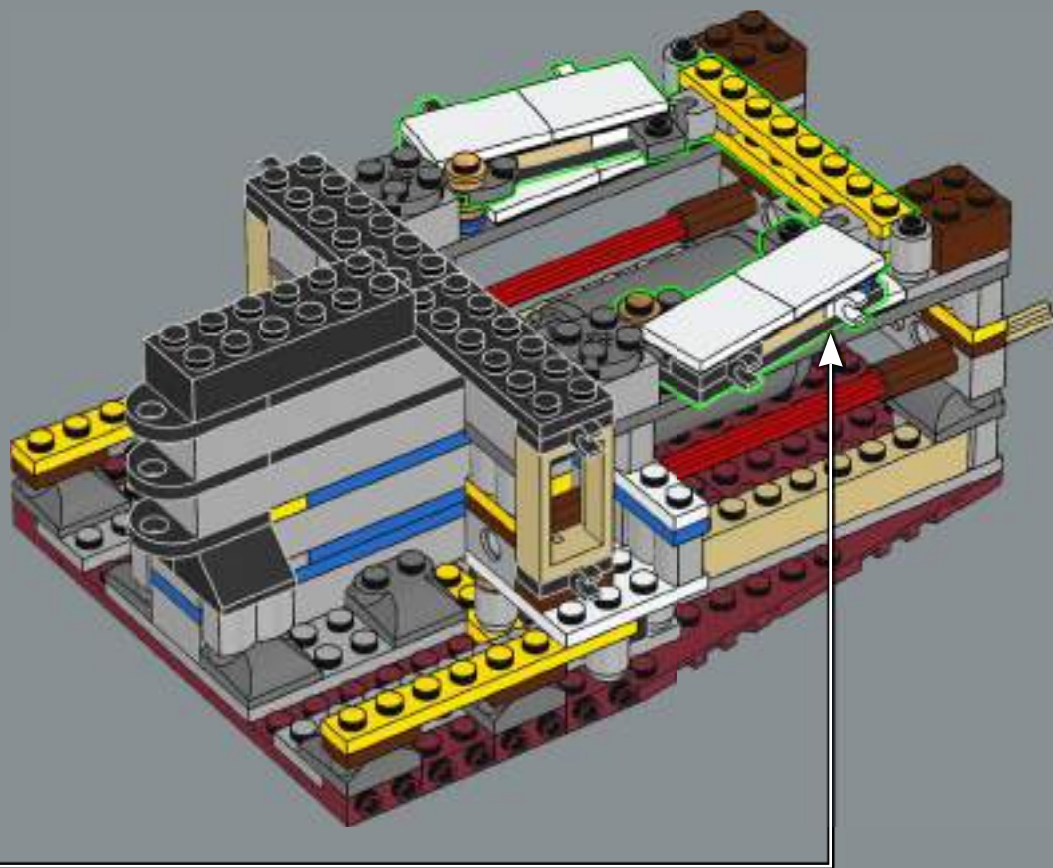

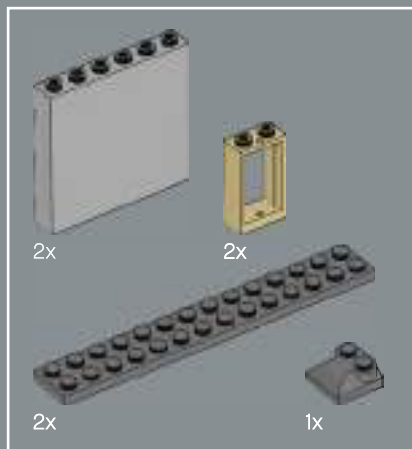

22

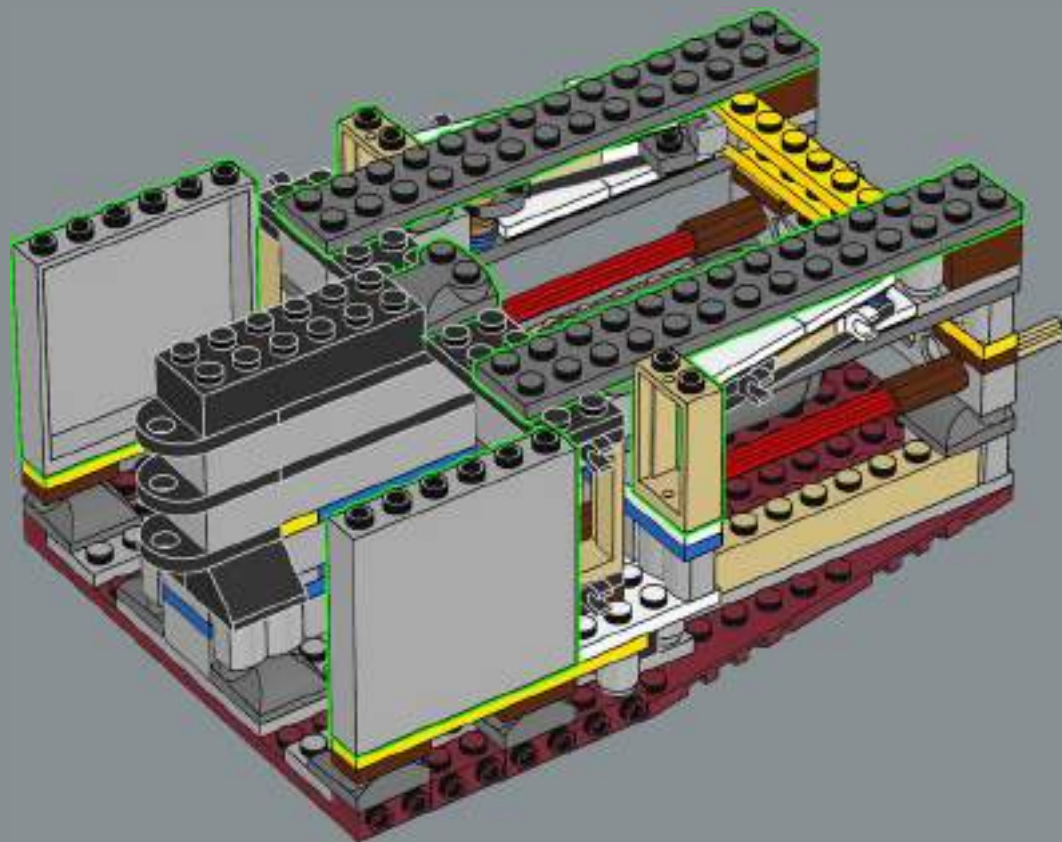



23

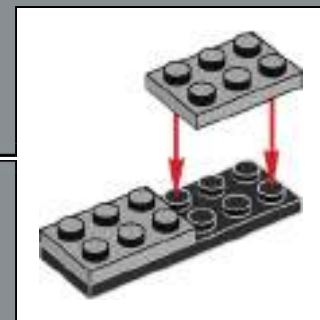
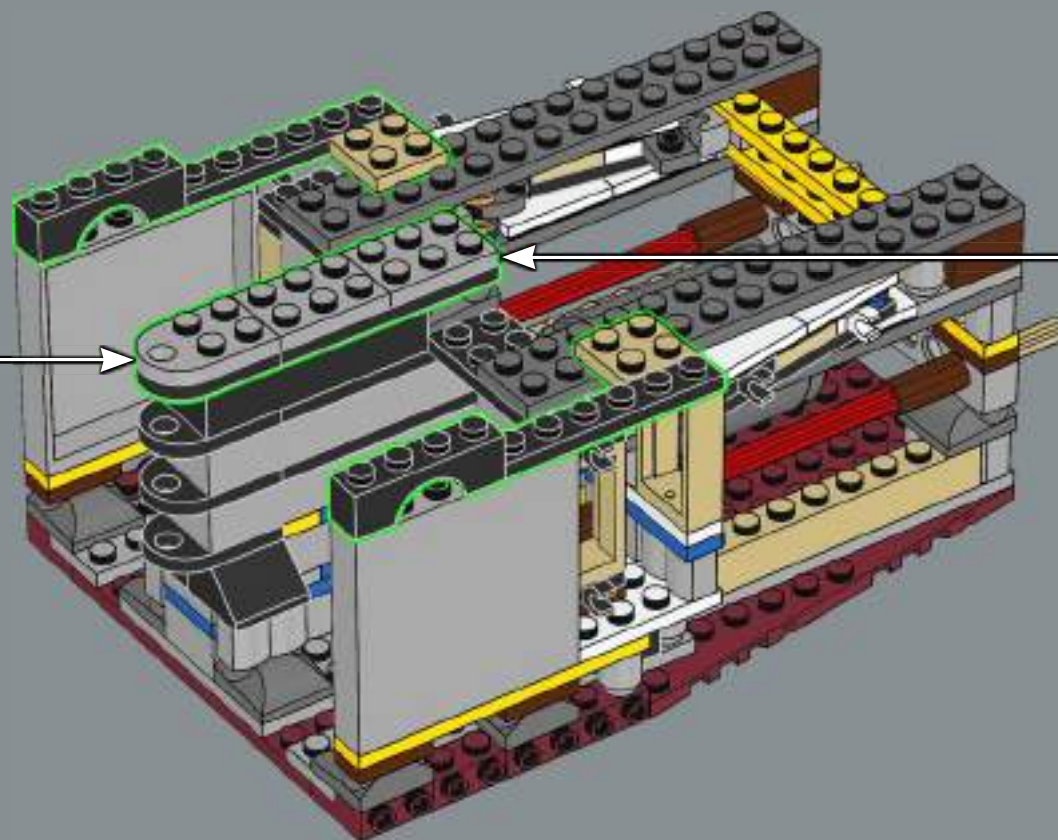
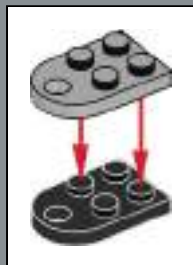

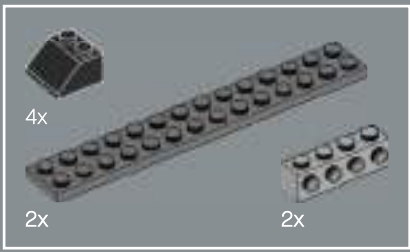

24

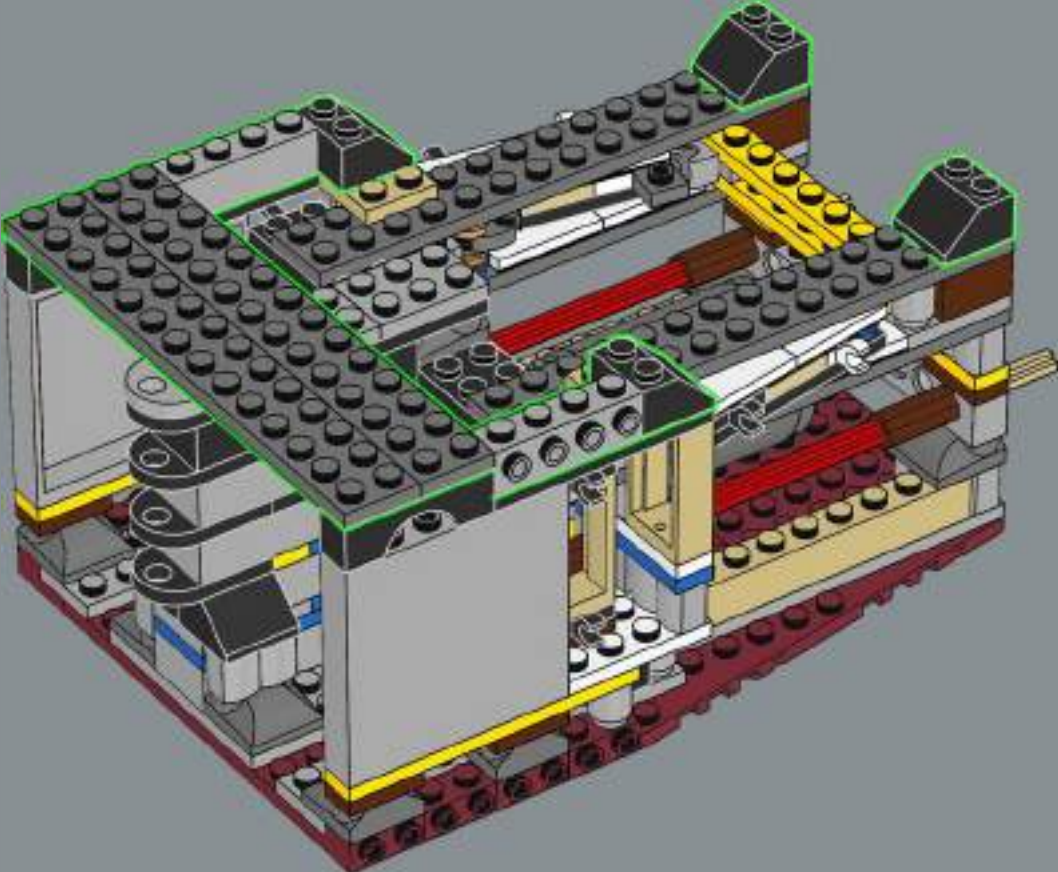

30

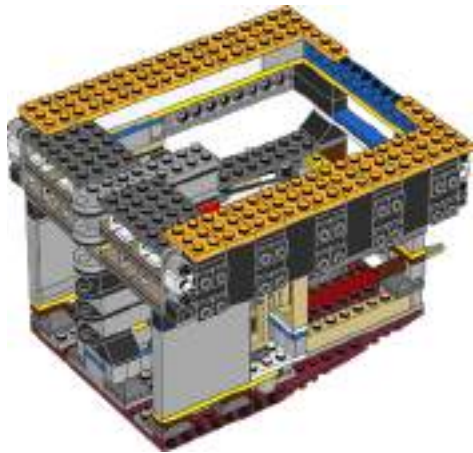
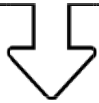

4x

1x



4x



2x



2x

25

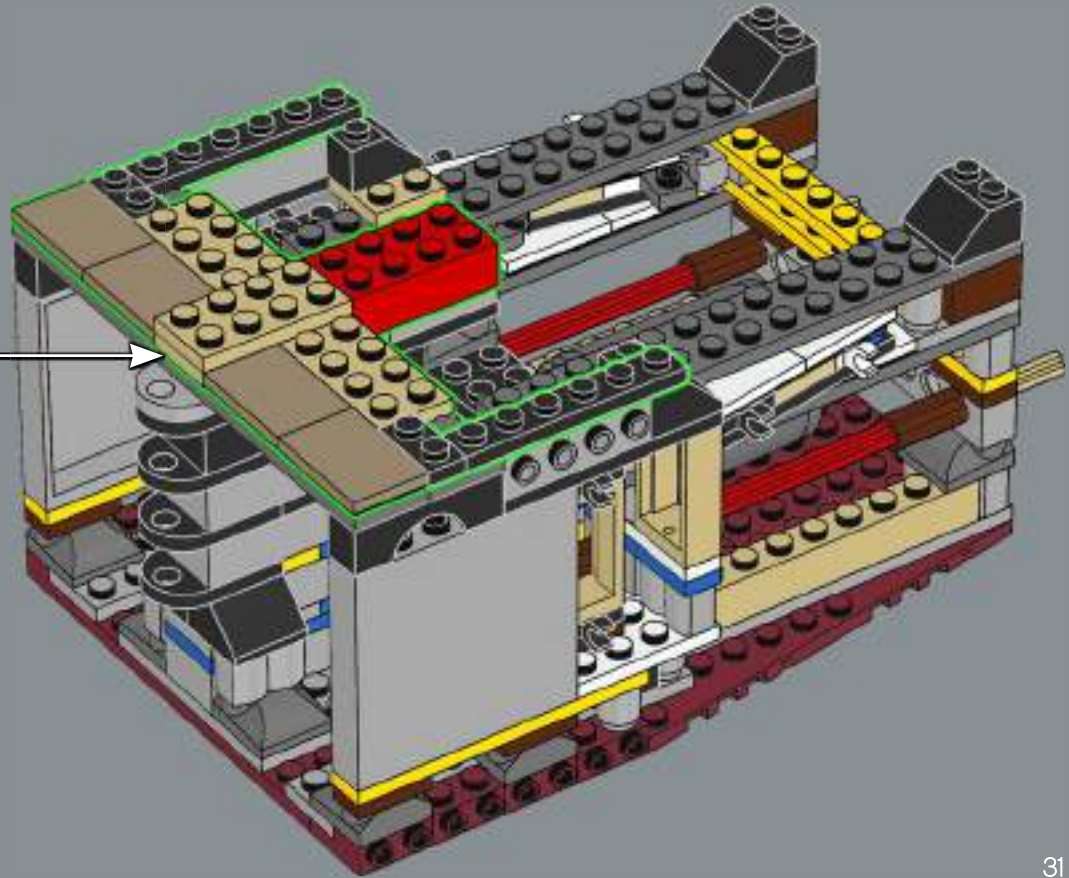
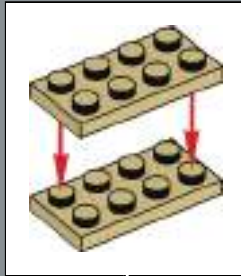



28

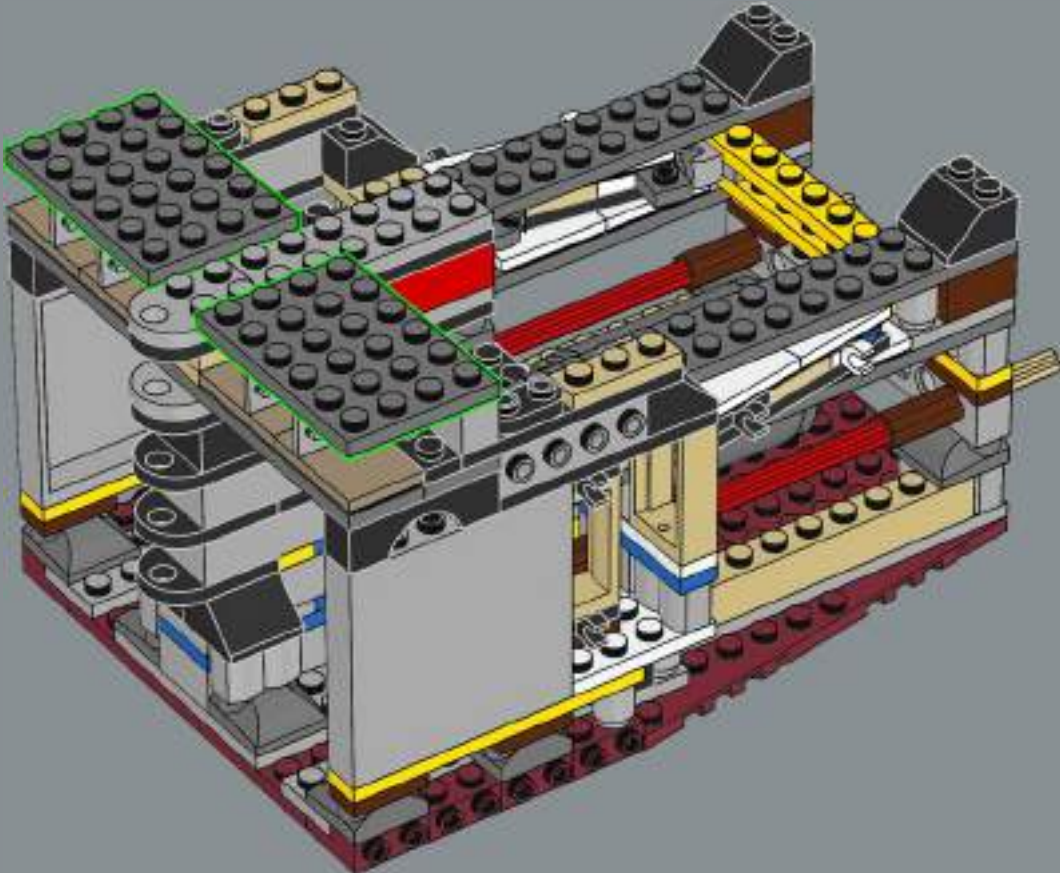

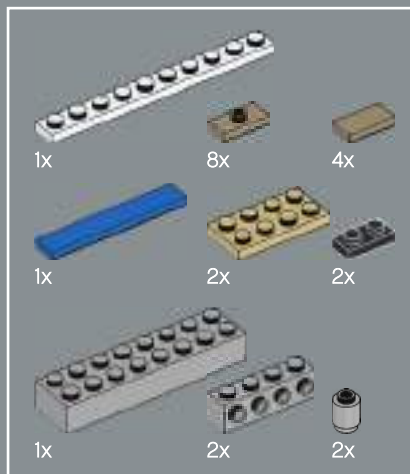

29

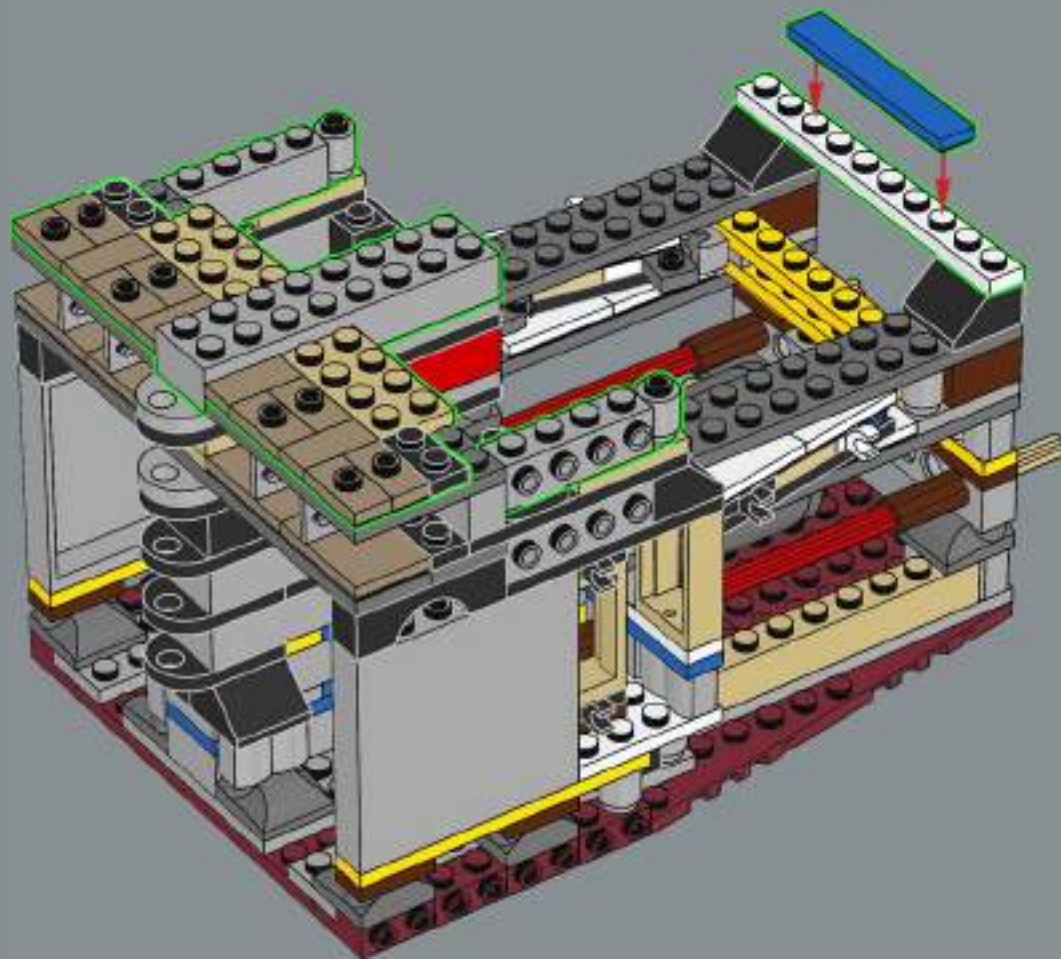

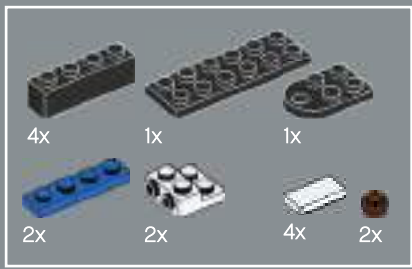

30

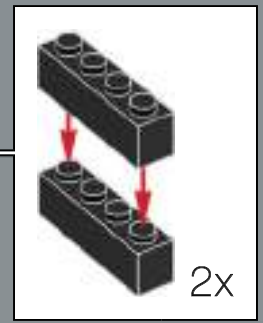
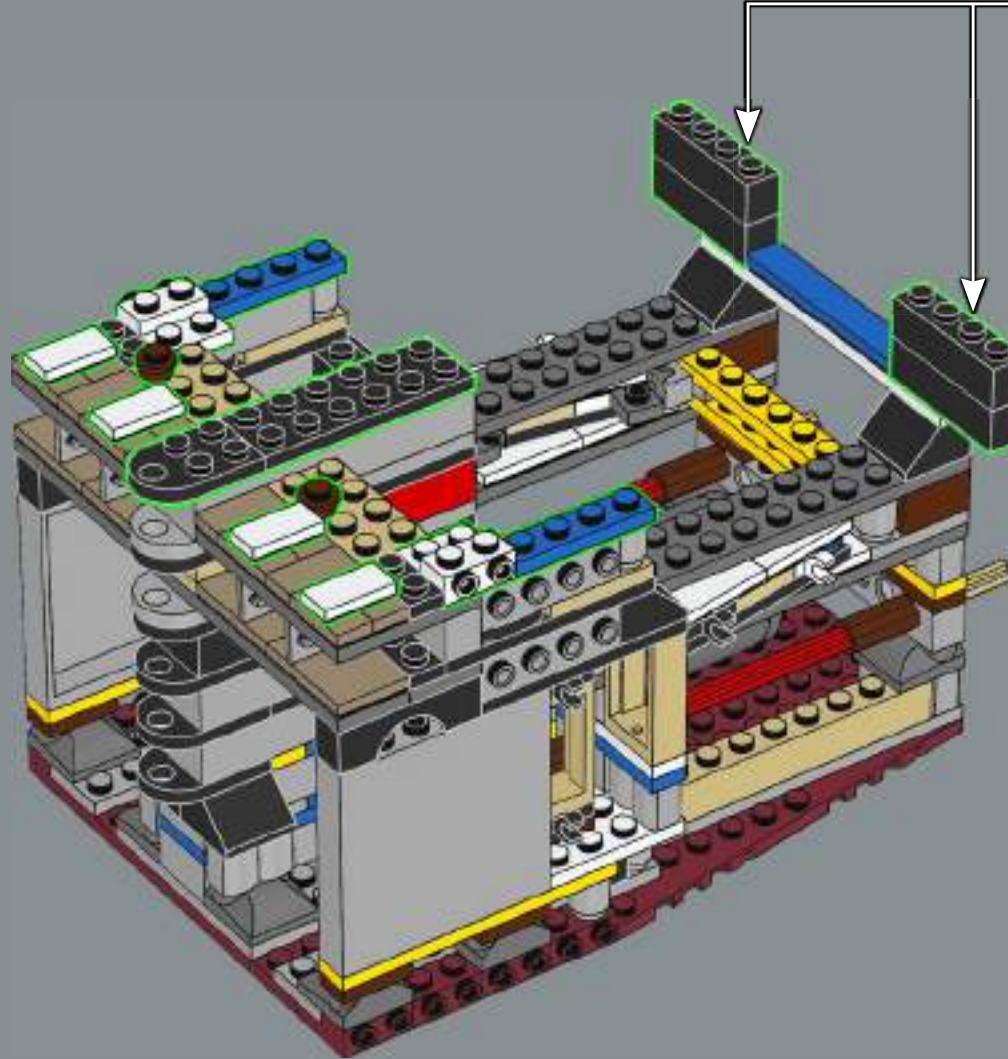

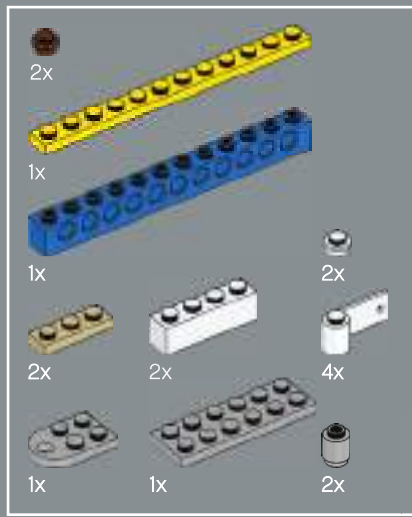

31

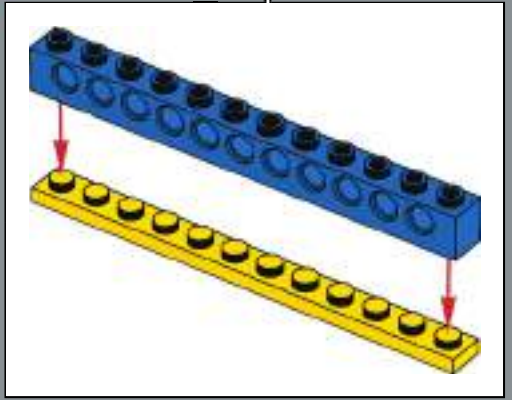

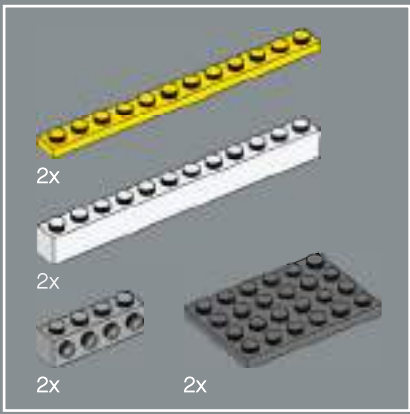

32

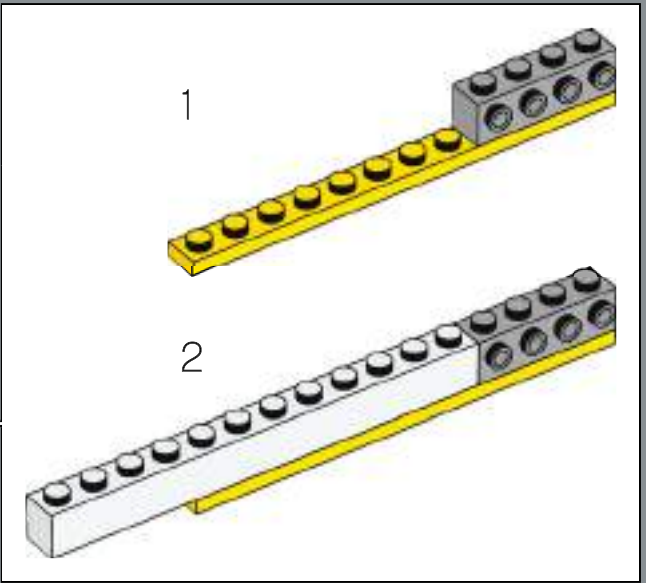
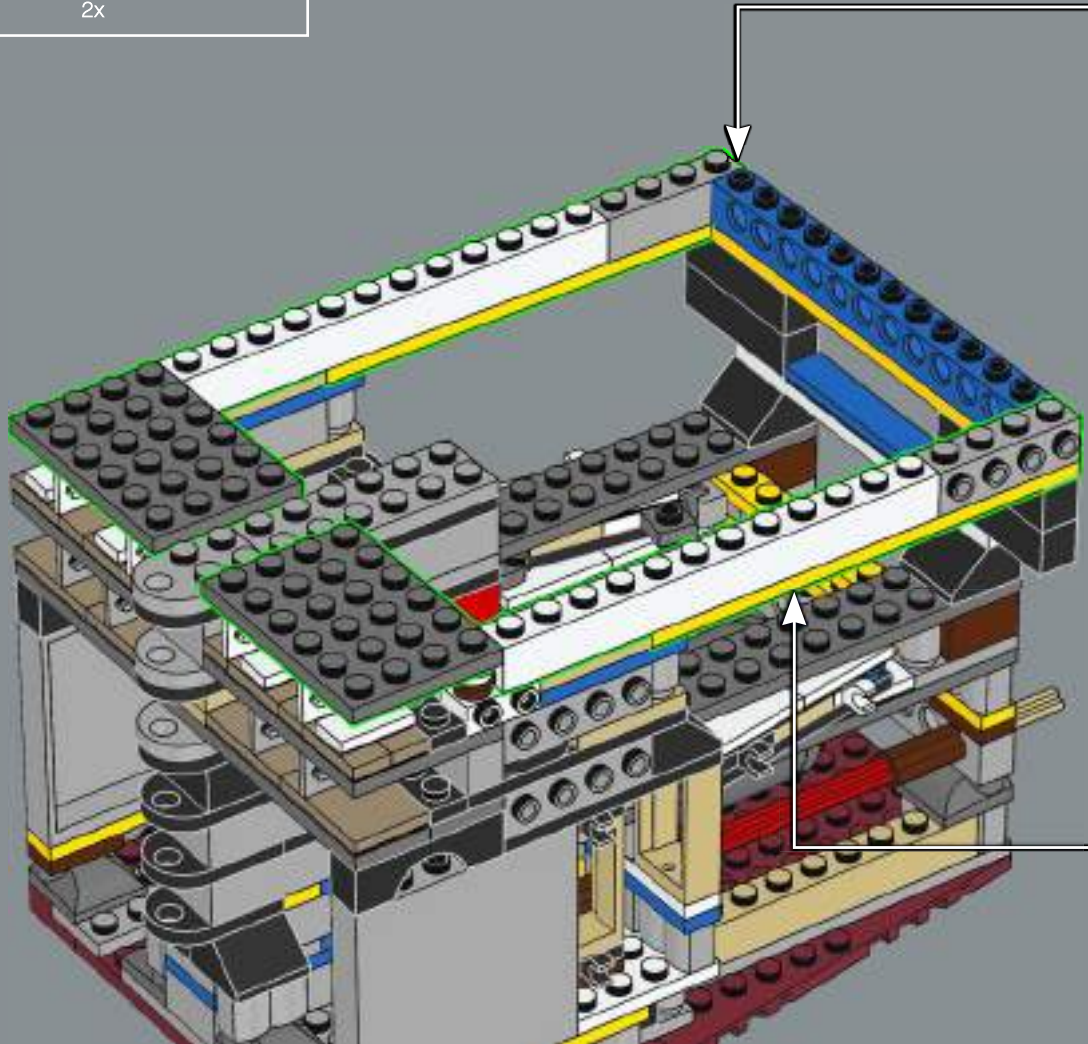
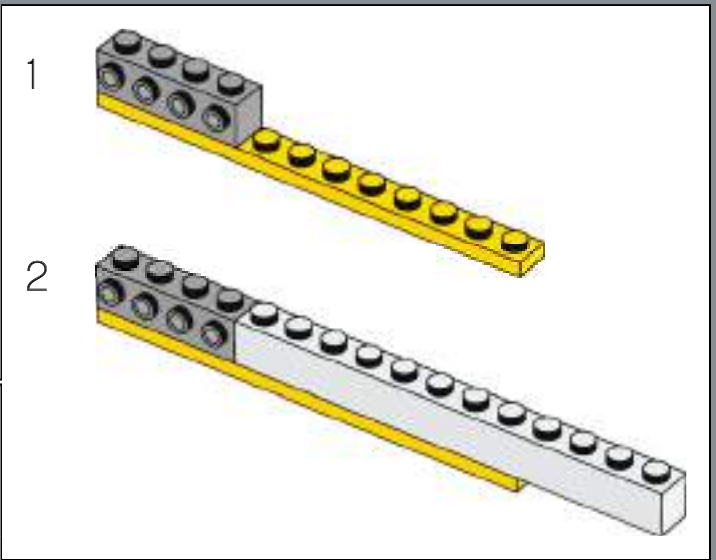

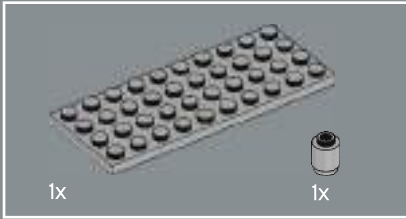

33

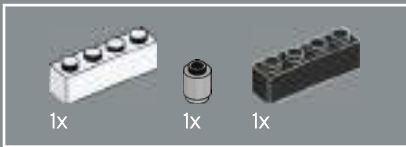
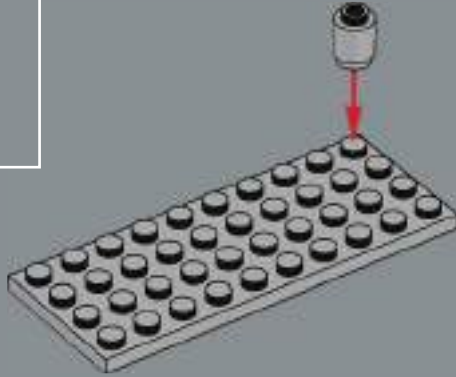

34

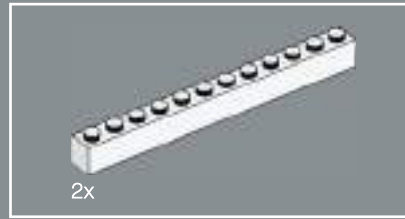
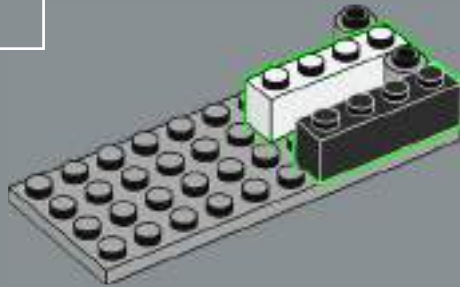

35

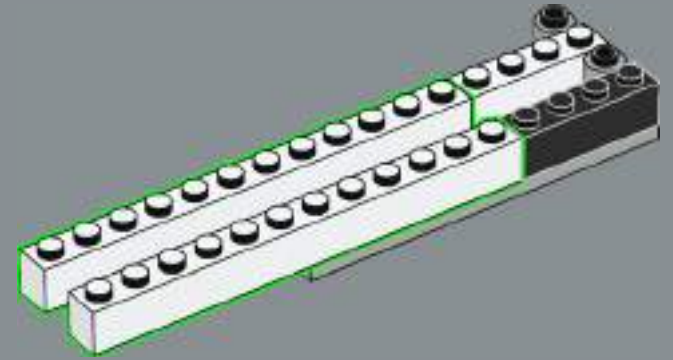

36

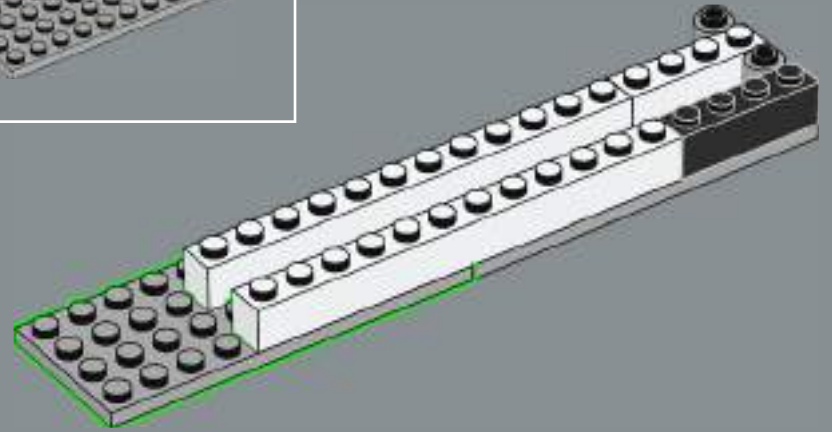



37

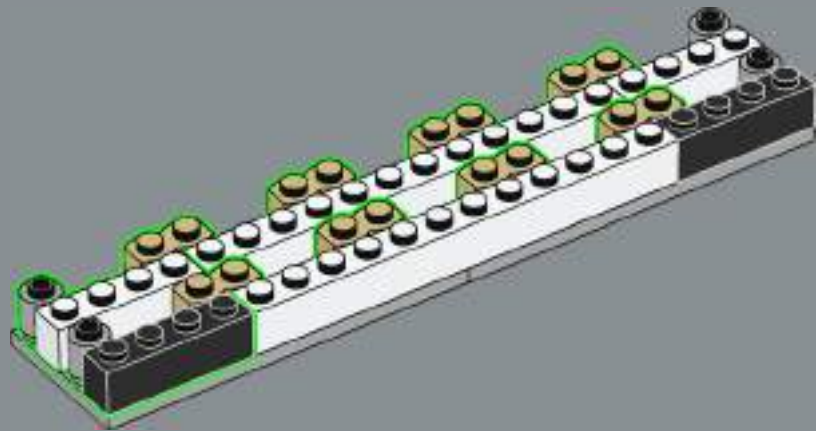

38

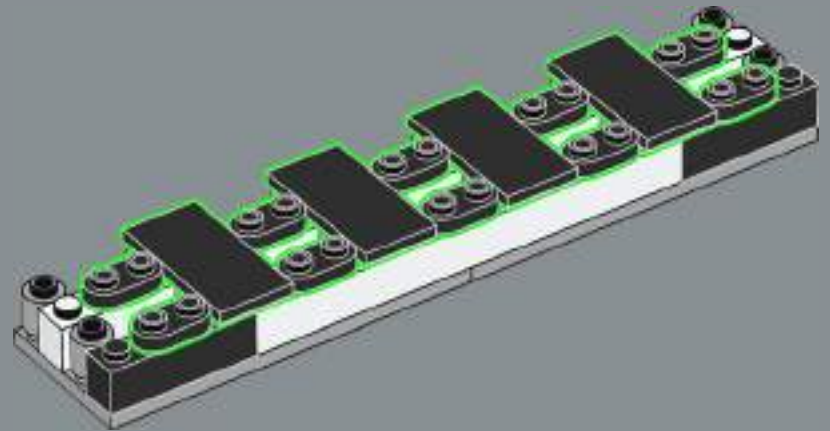



39

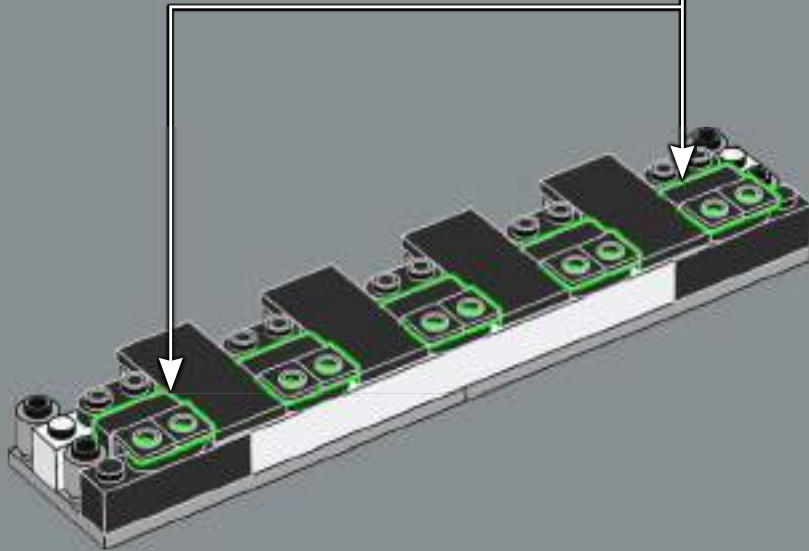
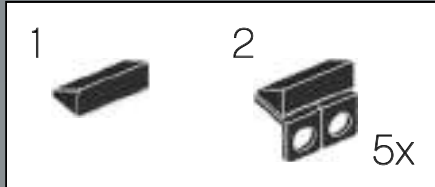

40

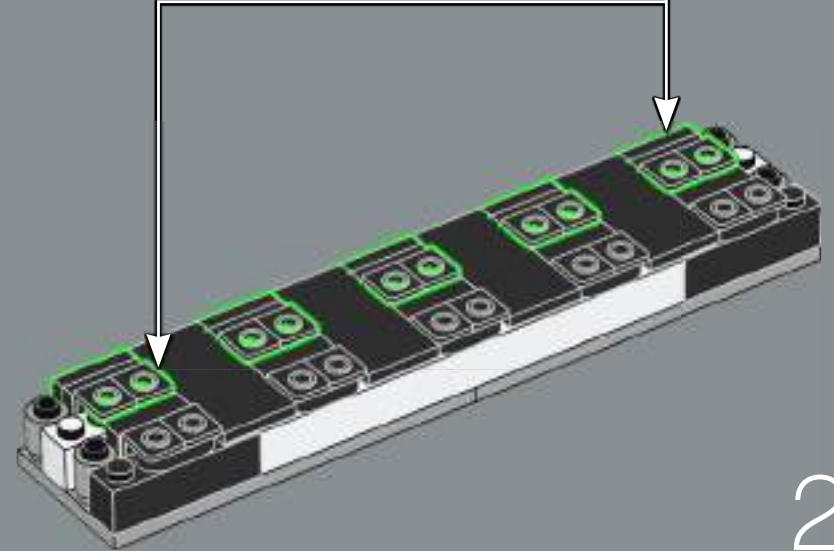
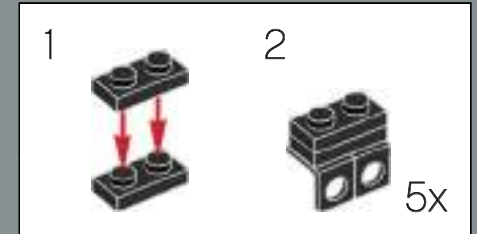

2x

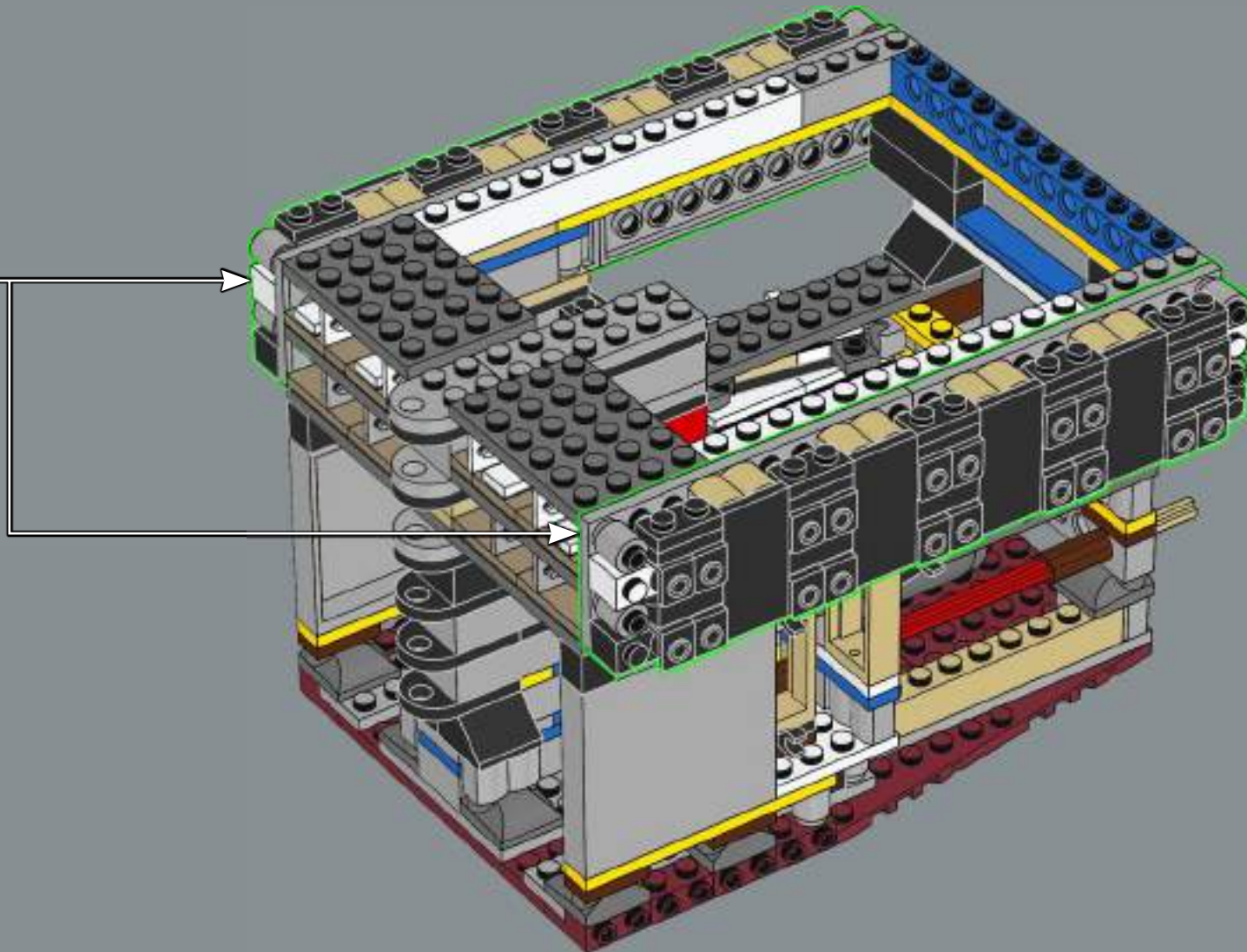



42

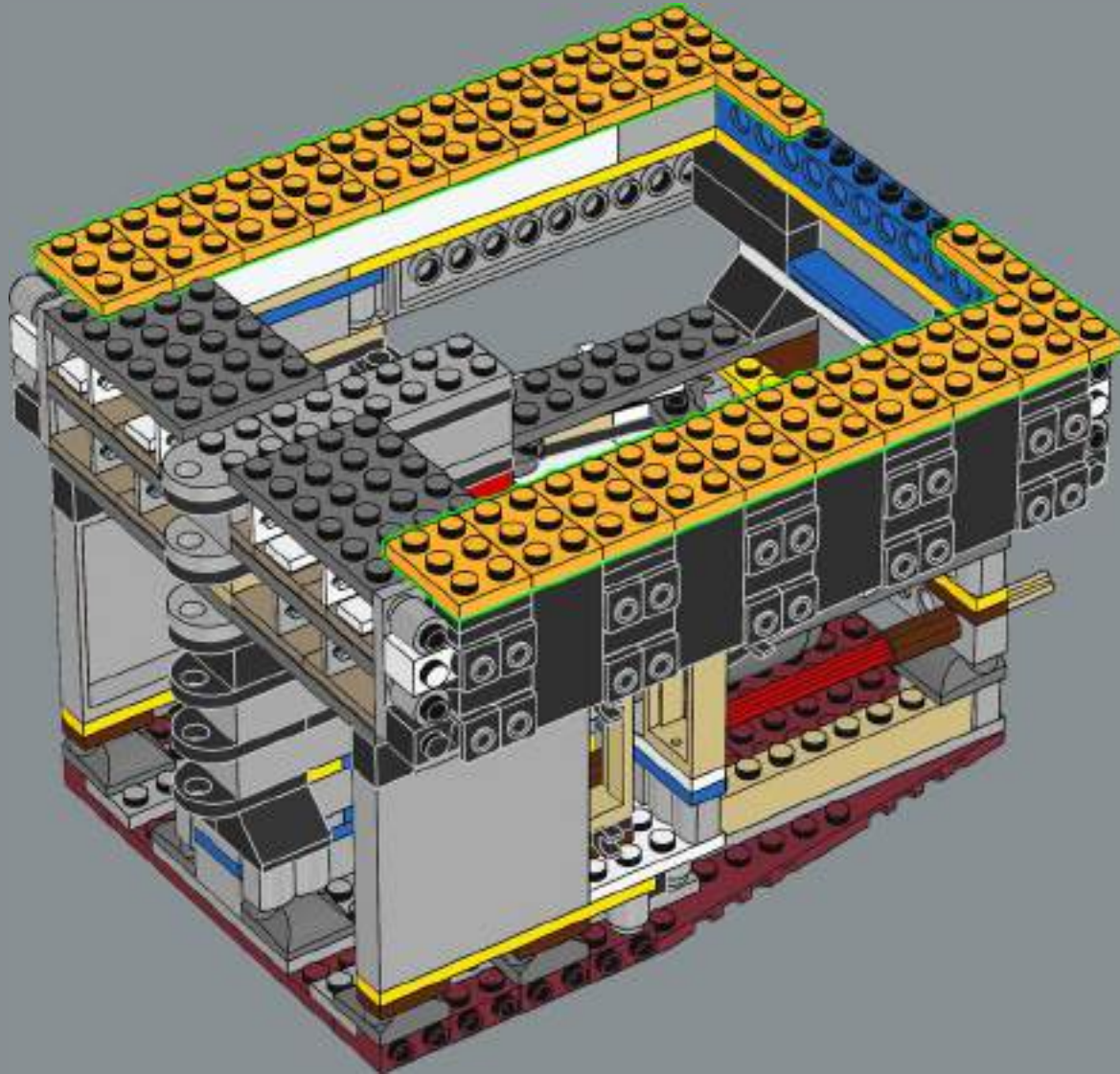

31

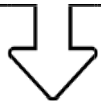

1x



1x

43

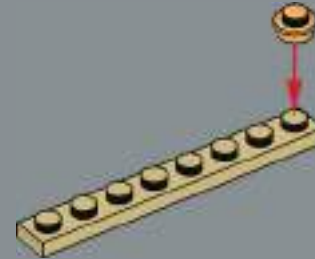

1x

44

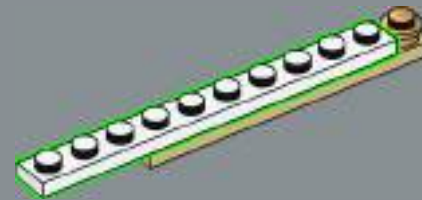

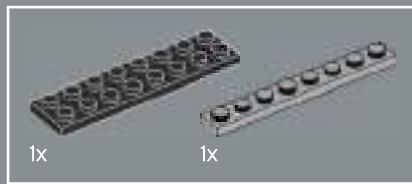

45

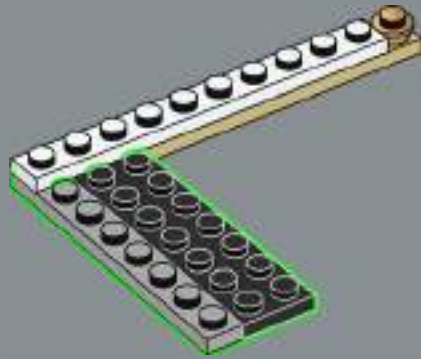

46

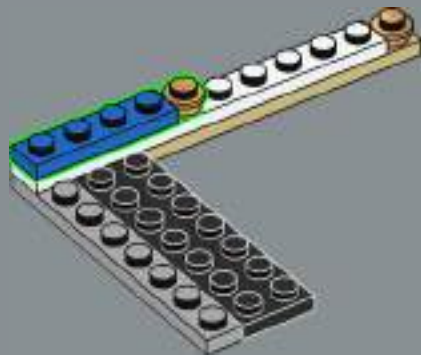

47

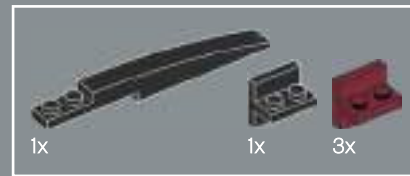
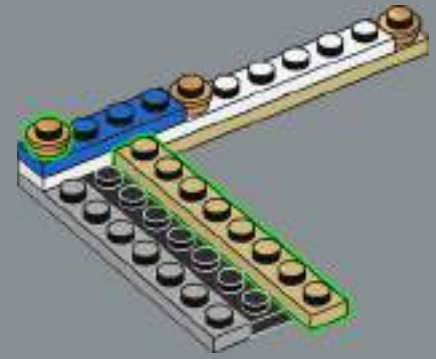

48

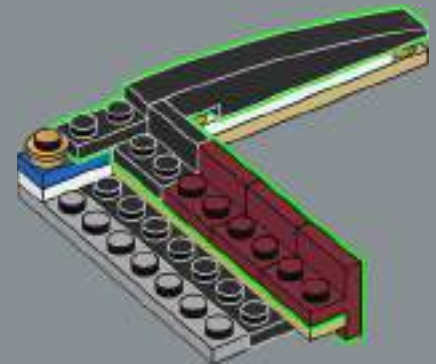

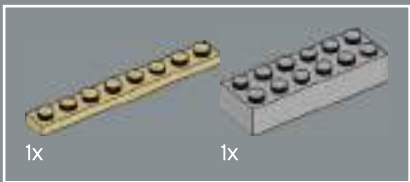

49

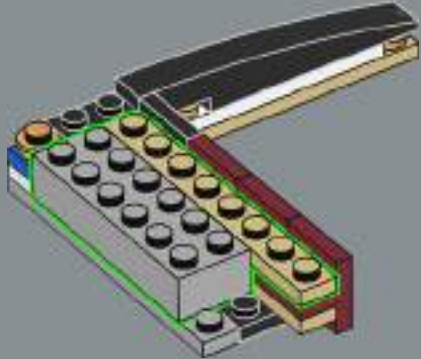

50

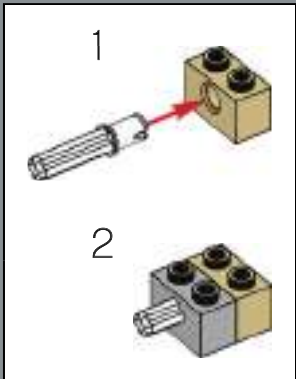
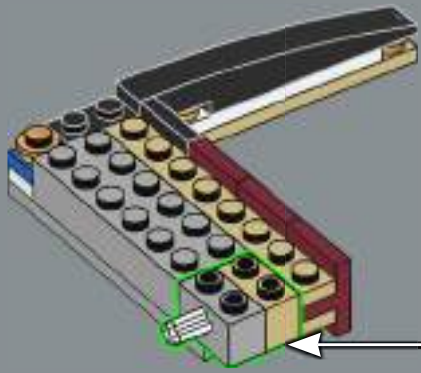

51

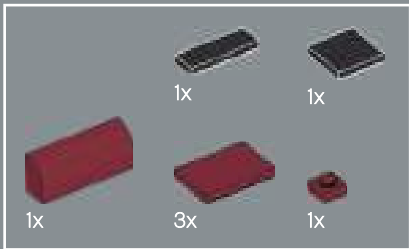
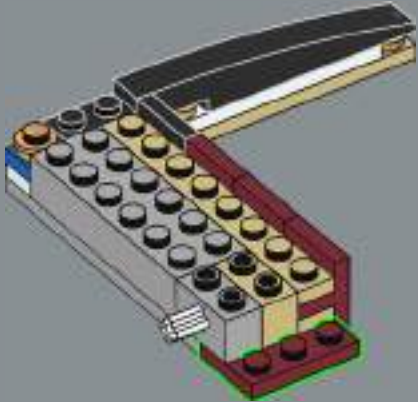

52

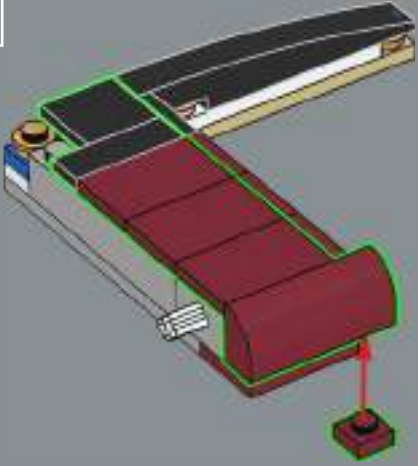

53

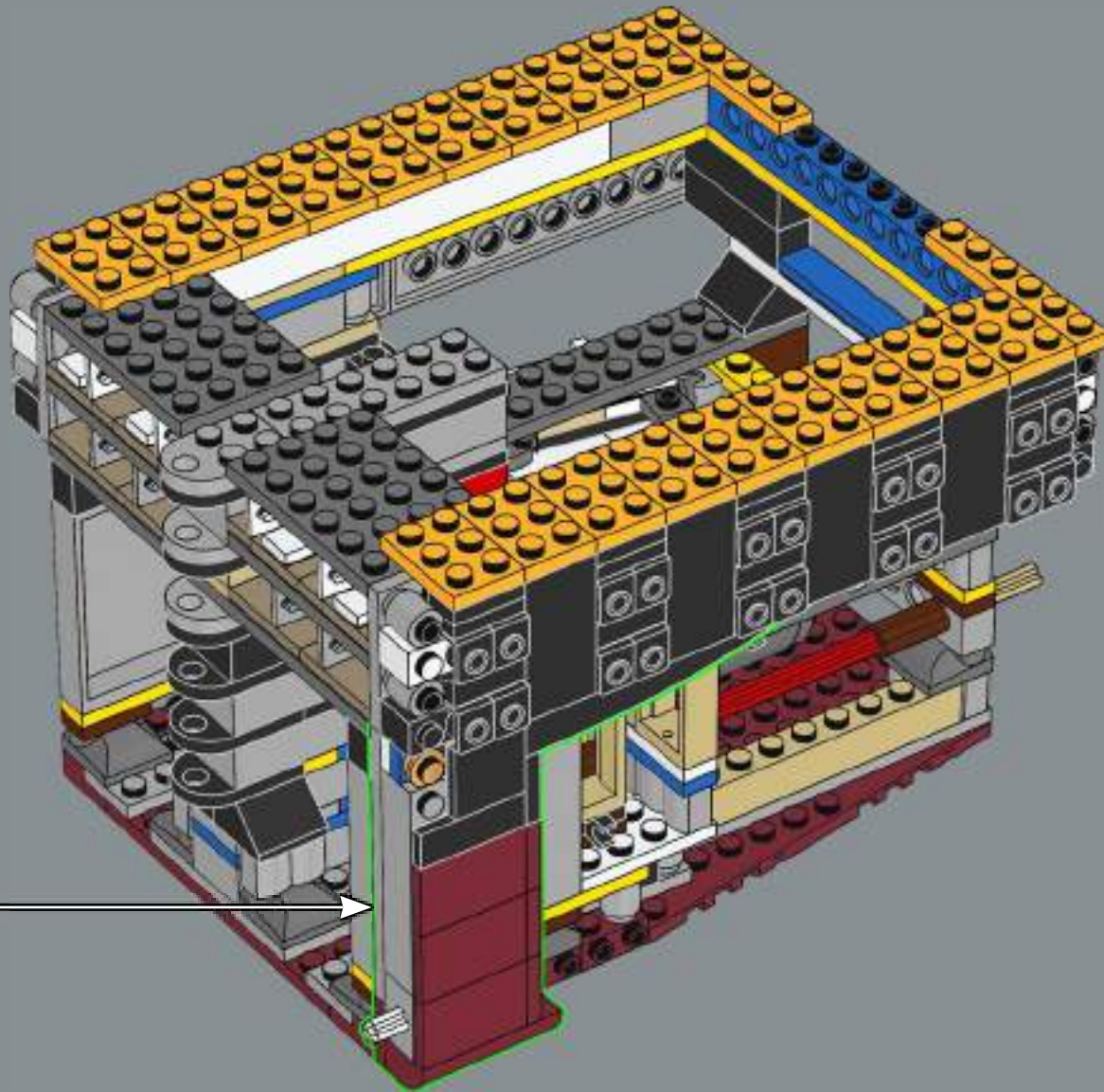

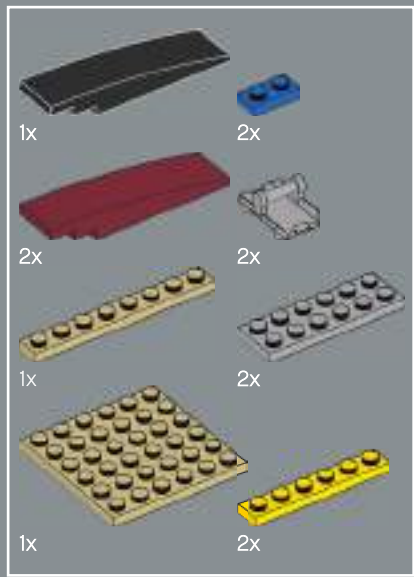

54

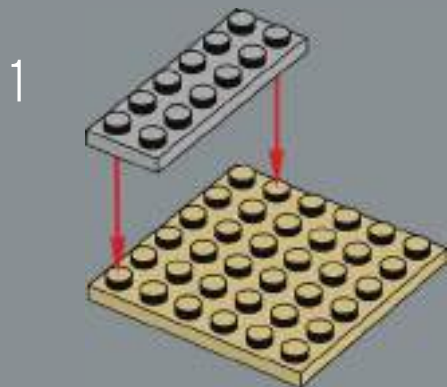

2

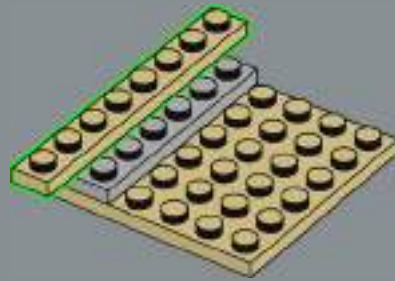

3

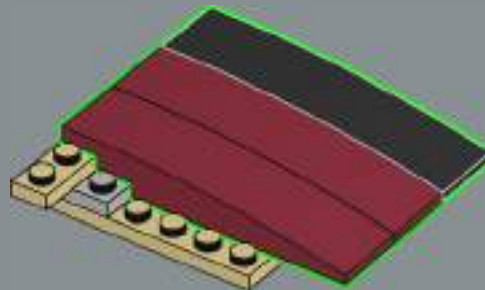

4

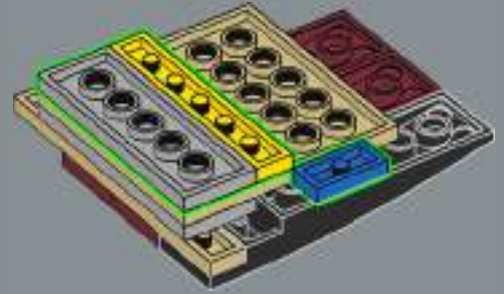

5

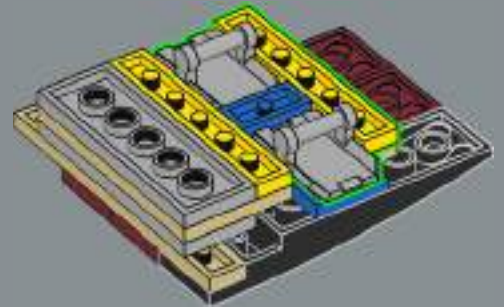

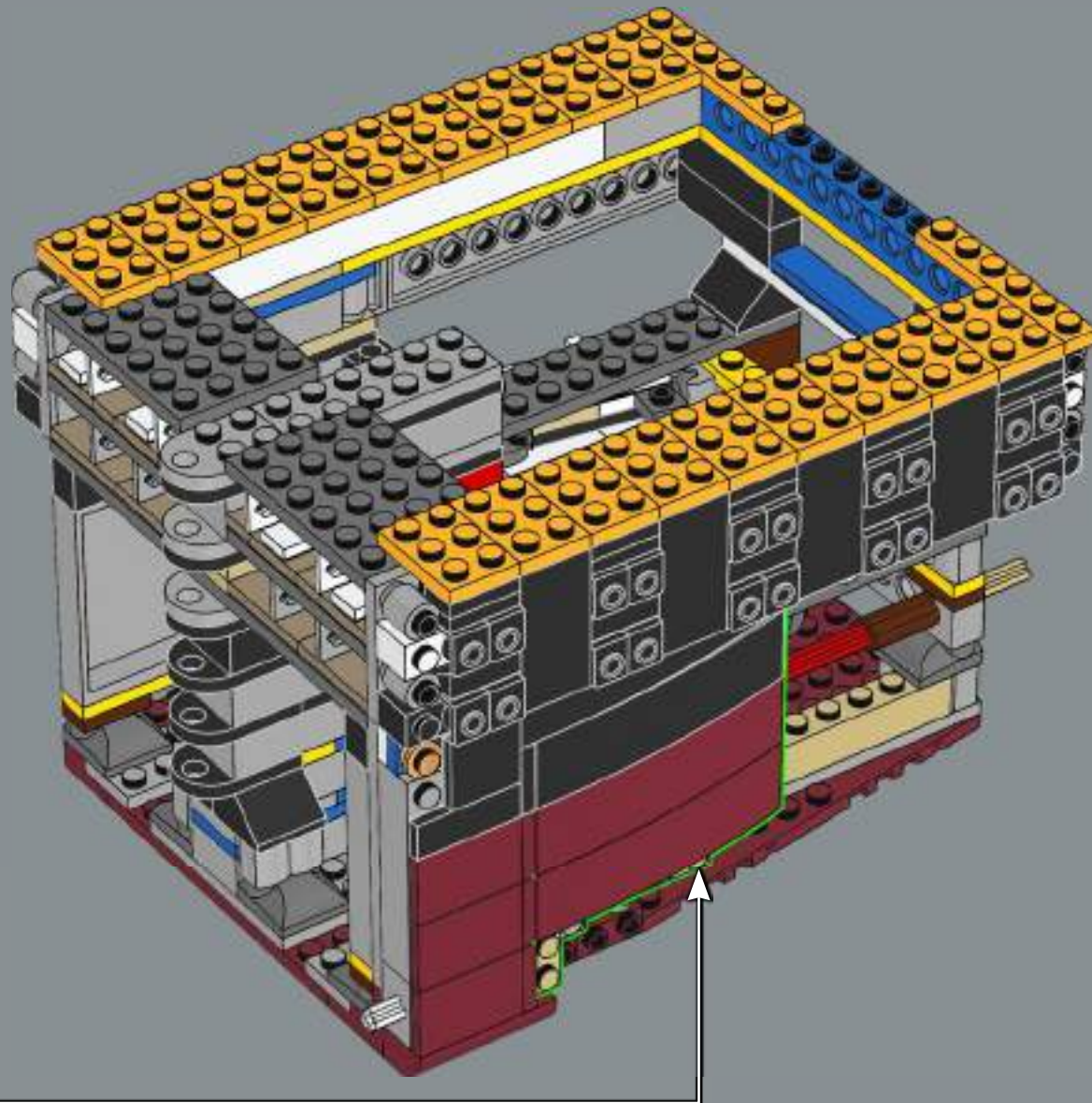

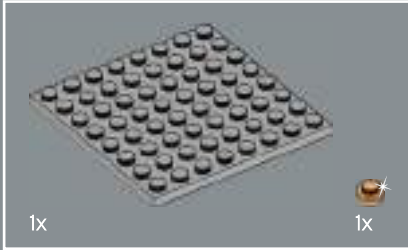

55

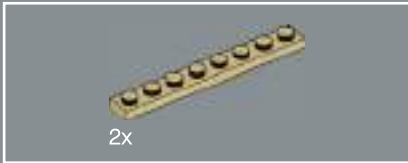
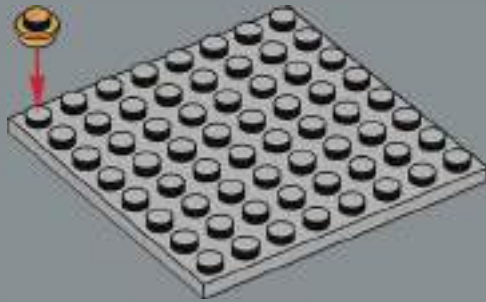

56

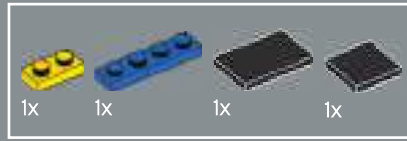
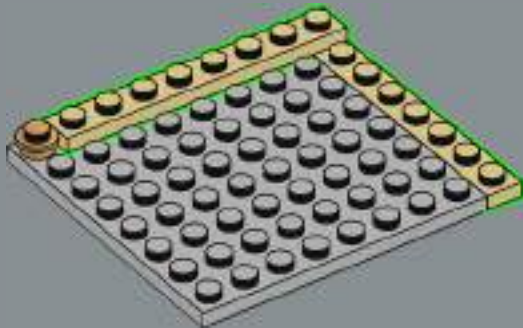

57

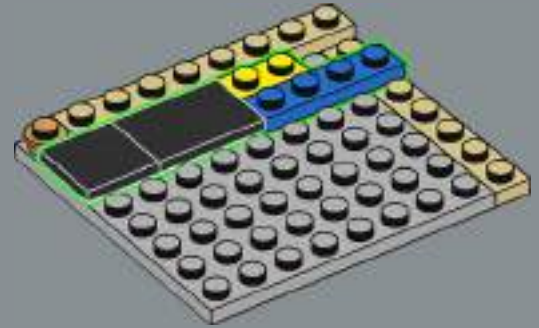

58

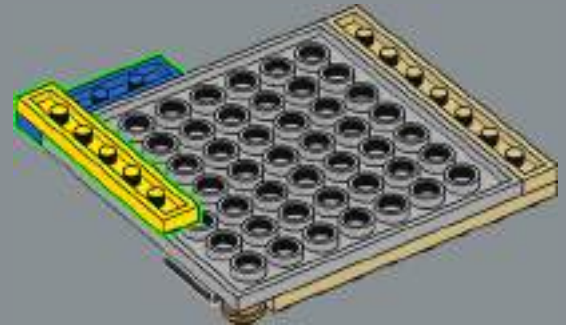

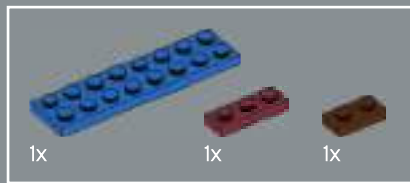

59

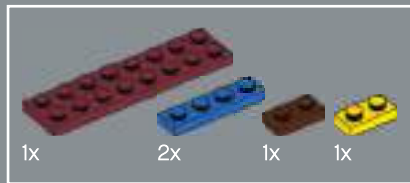
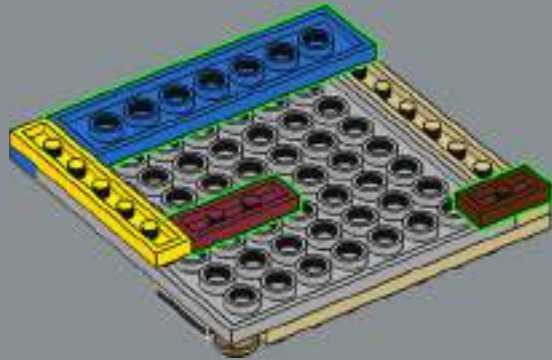

60

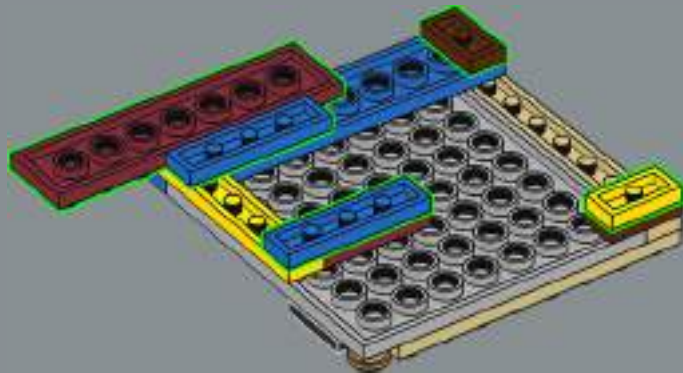

61

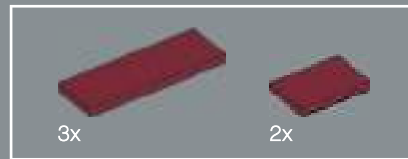
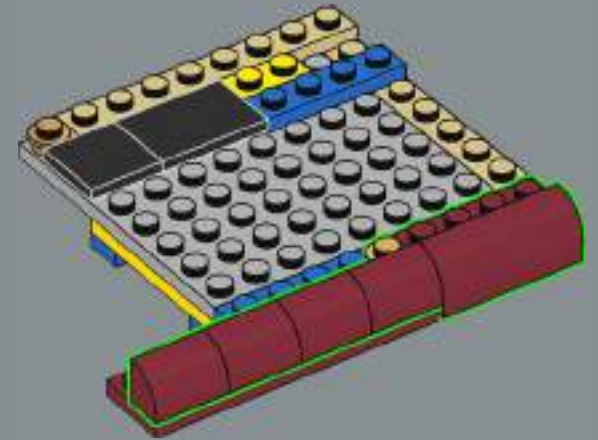

62

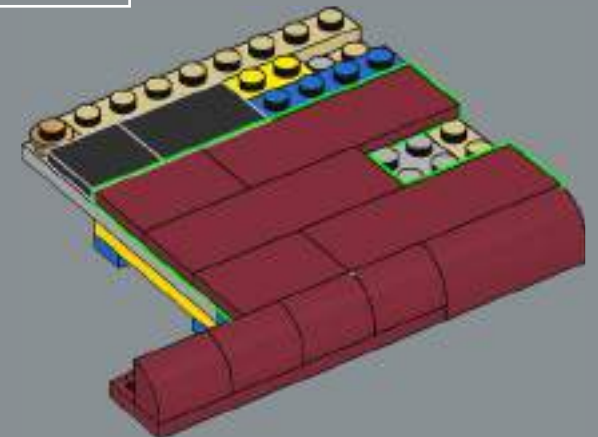



63

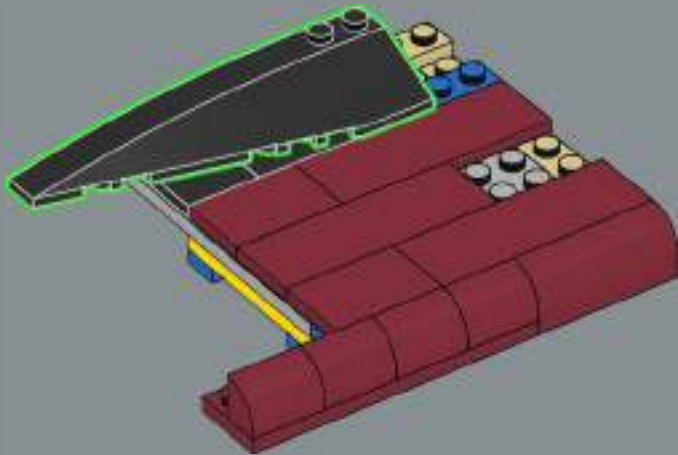

64

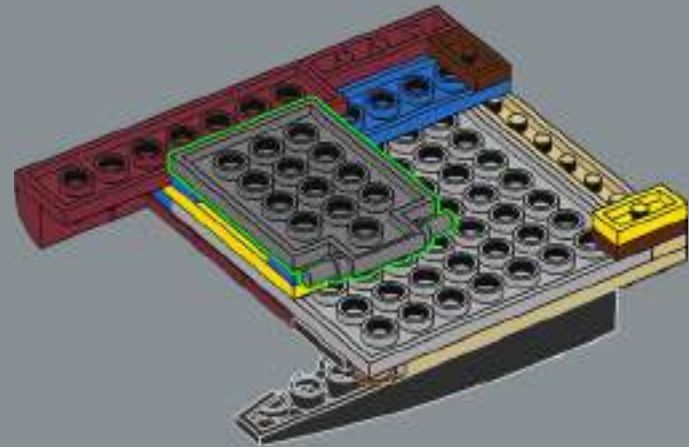

65

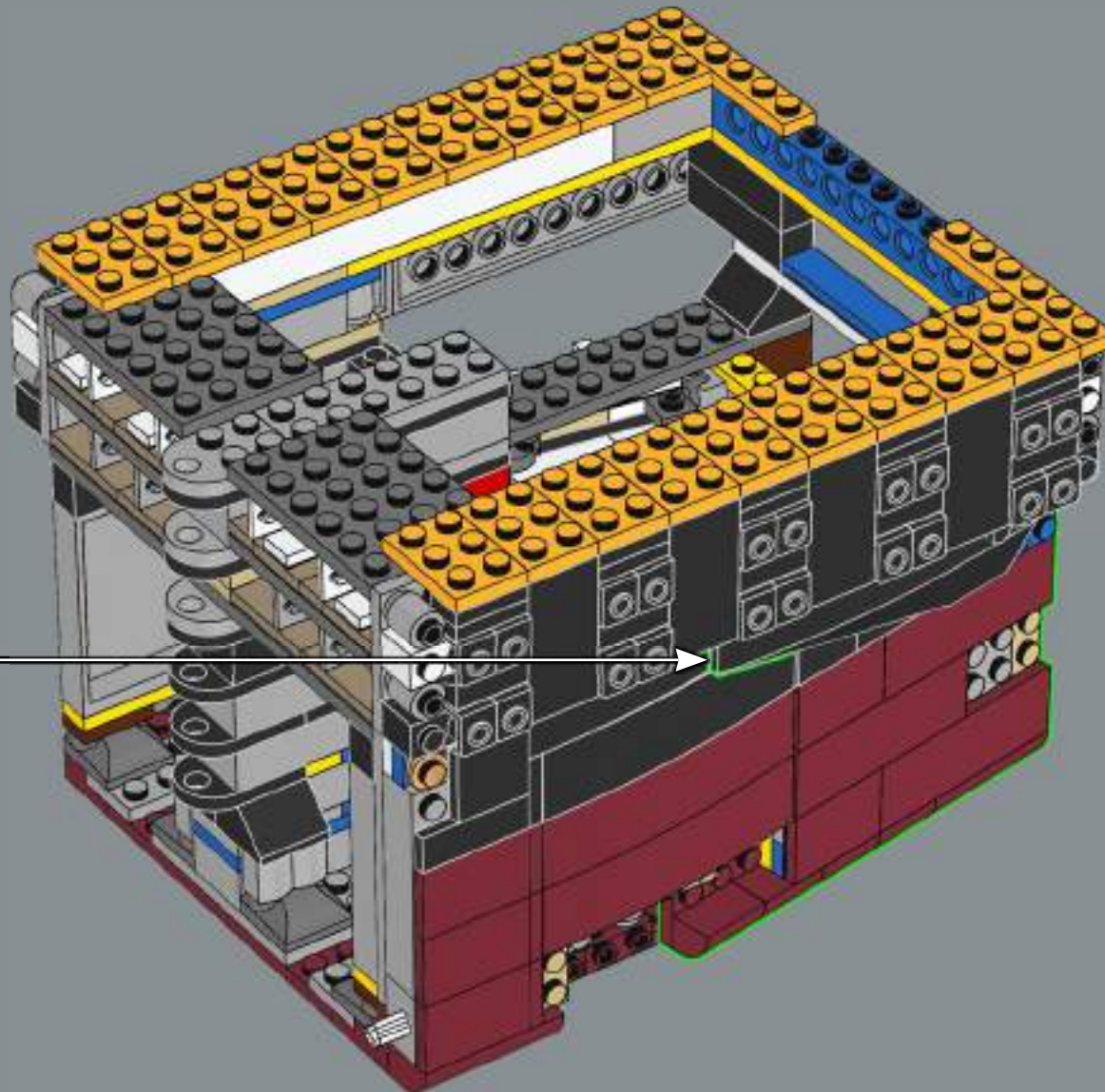

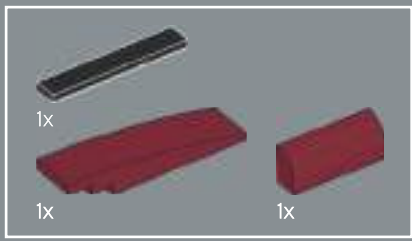

66

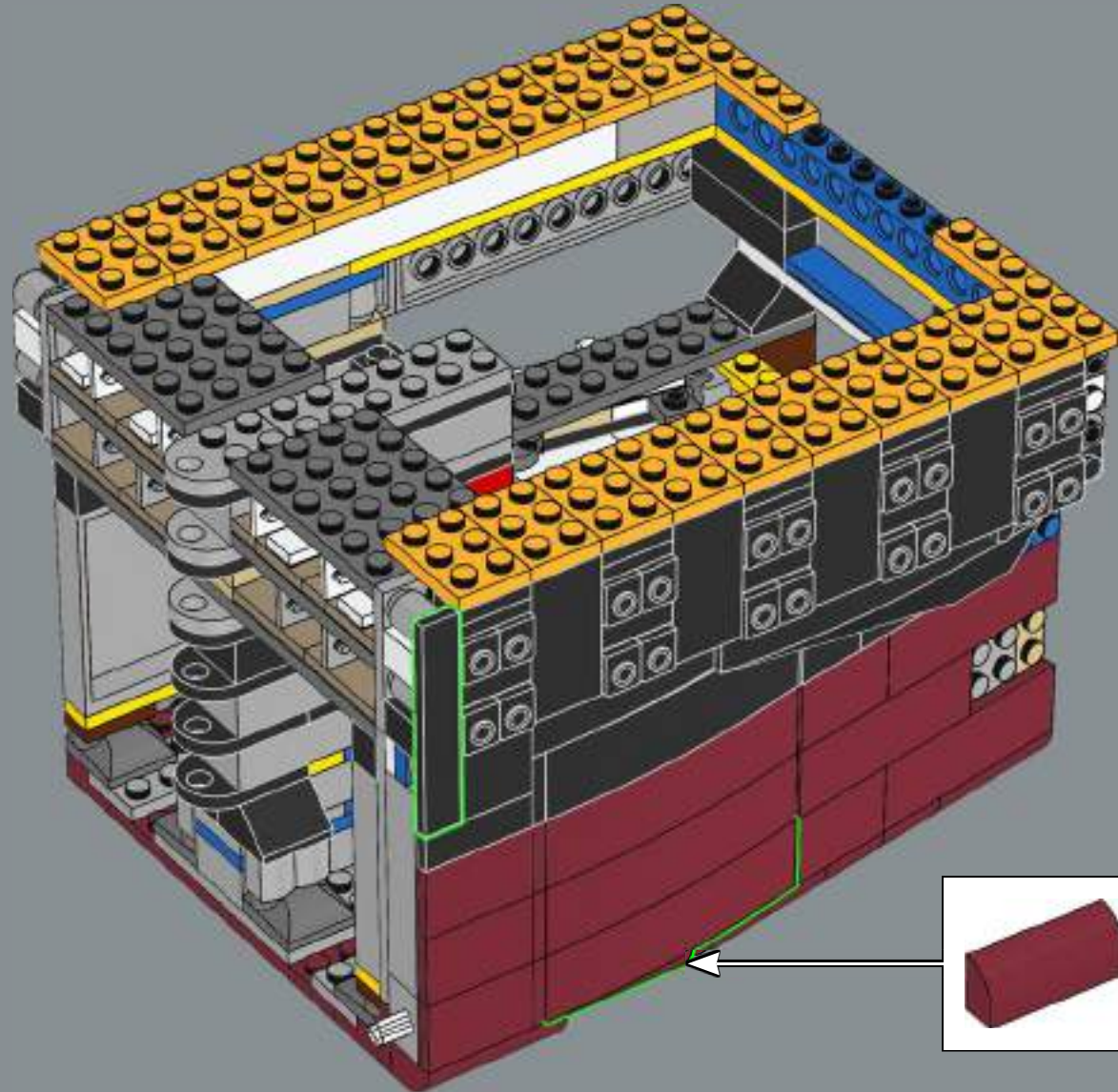



67

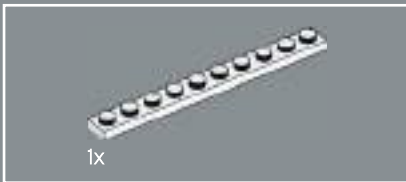

68

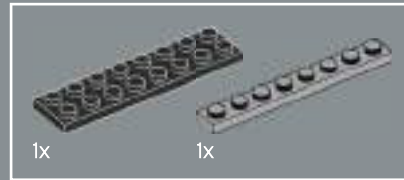
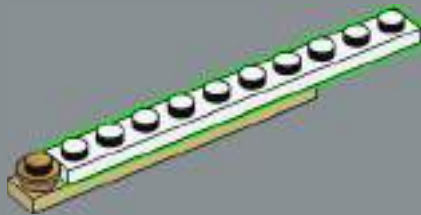

69

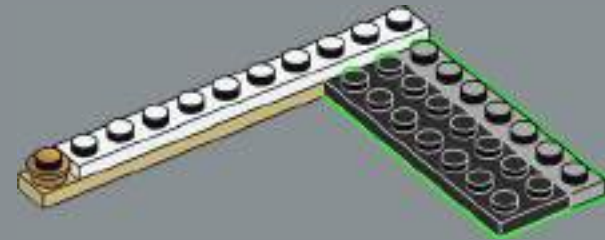

70

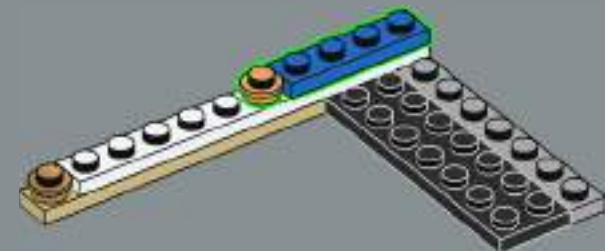



71

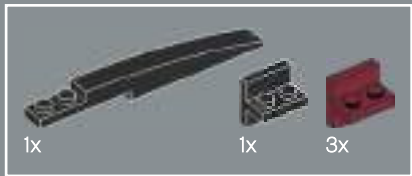
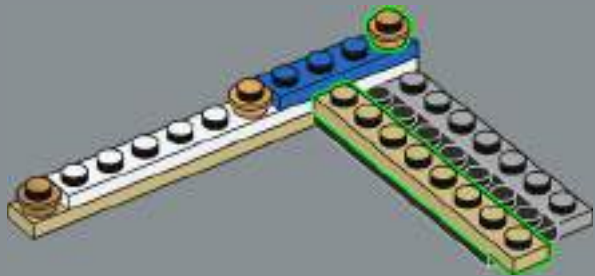

72

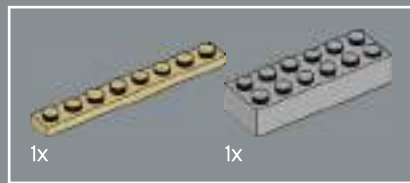
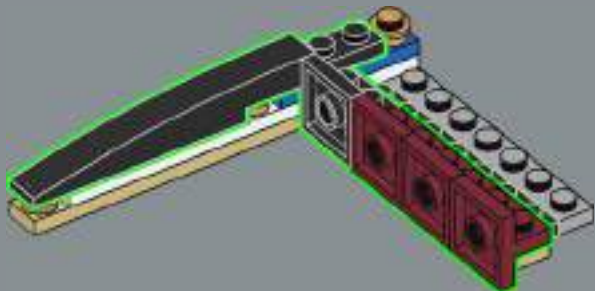

73

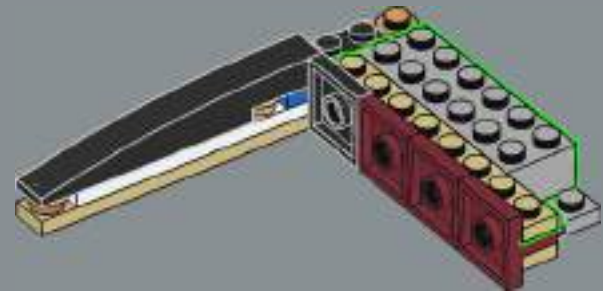



74

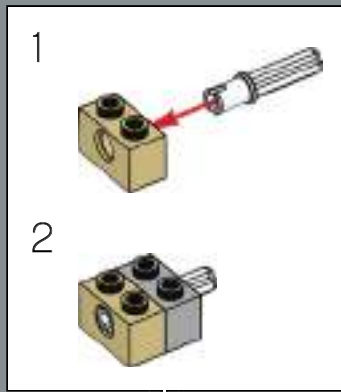

75

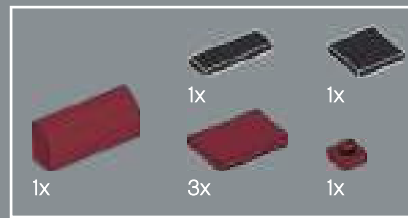
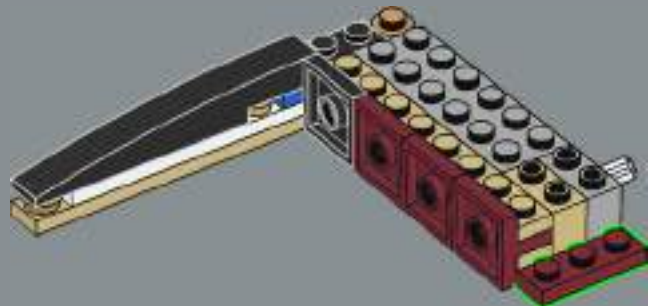

76

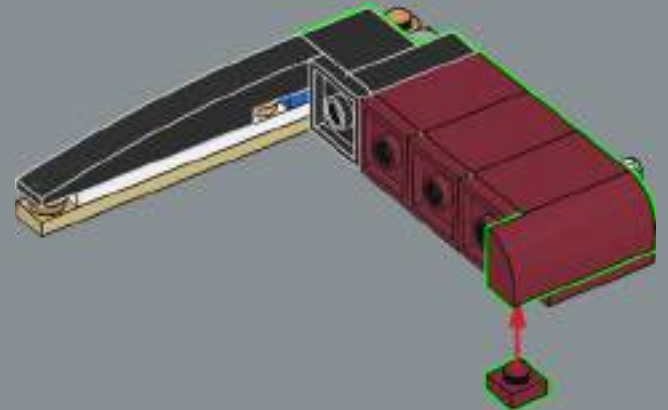

77

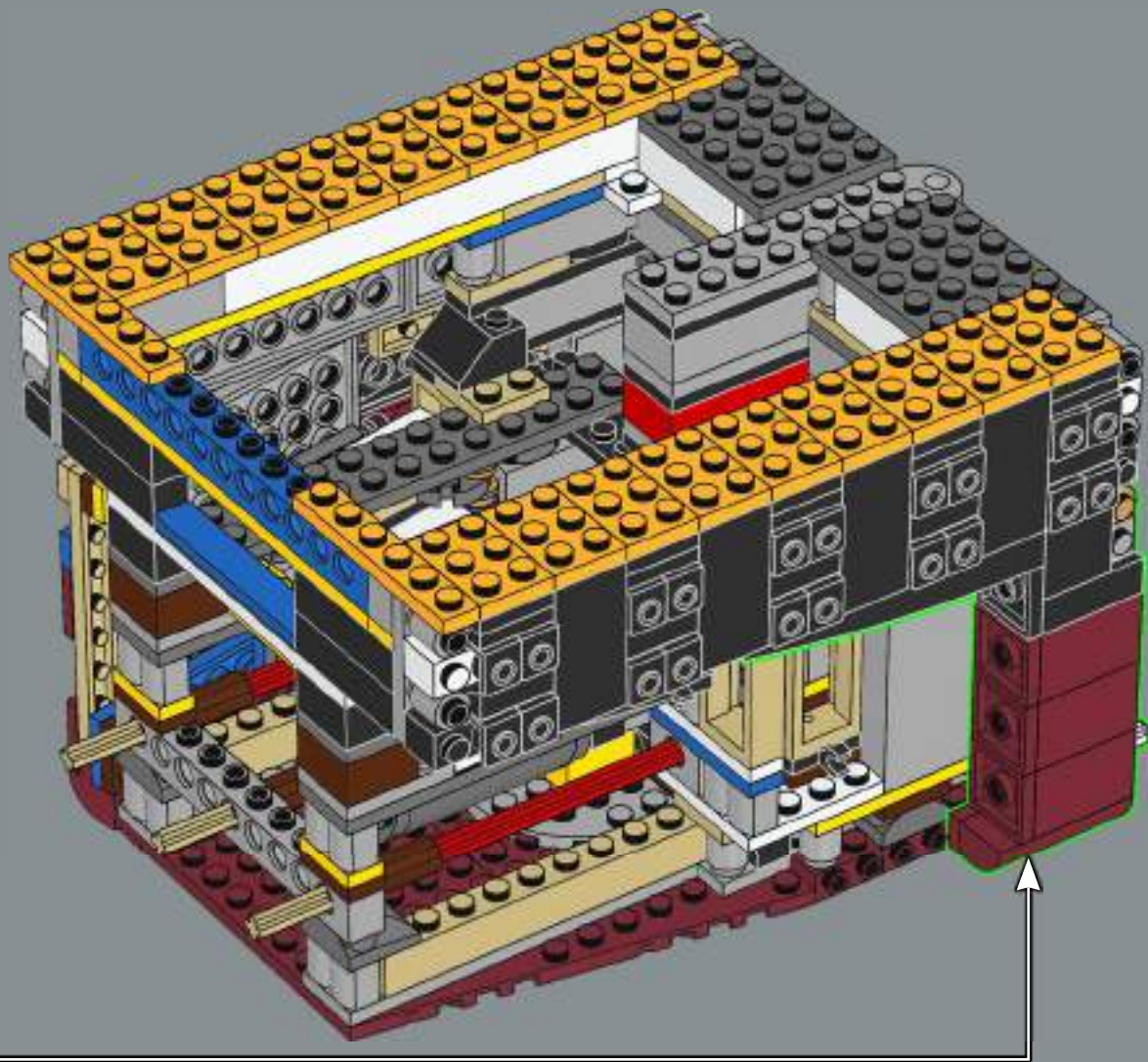

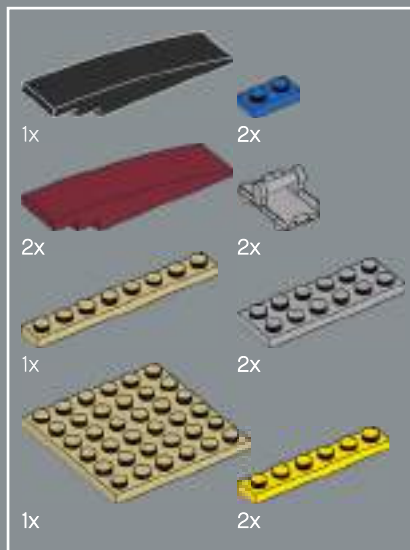

78

1

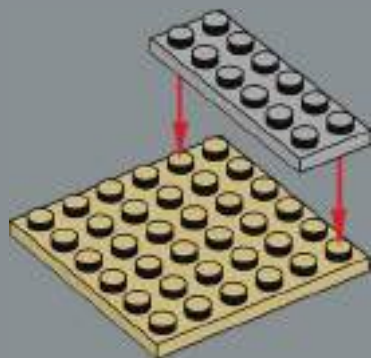

2

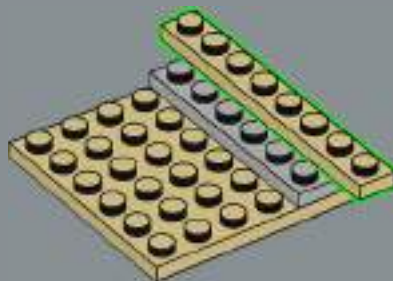

3

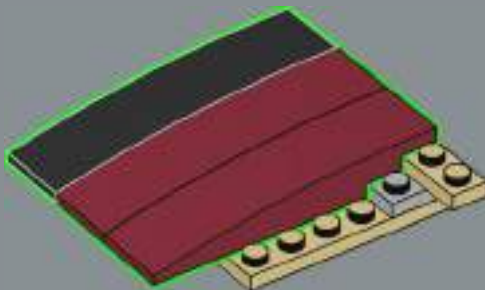

4

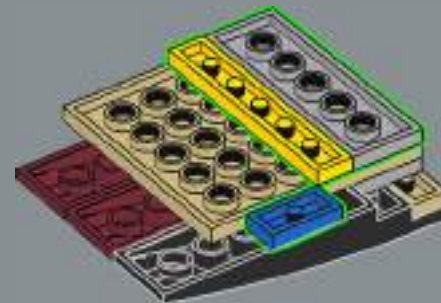

5

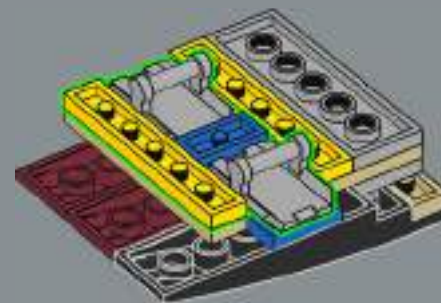

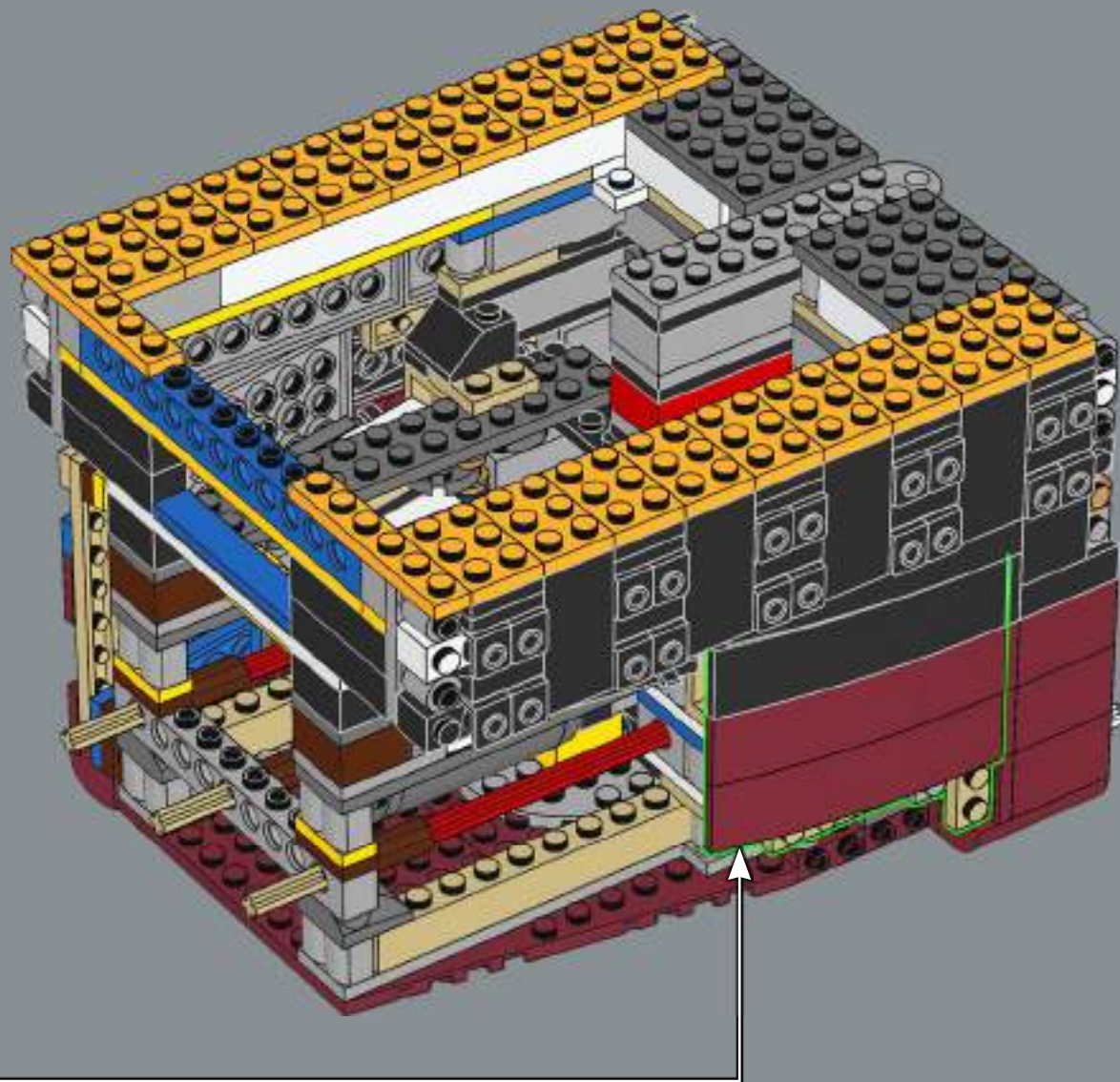

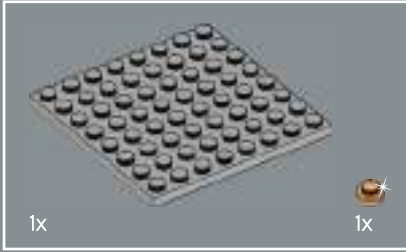

79

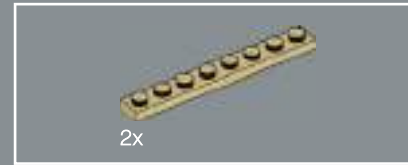
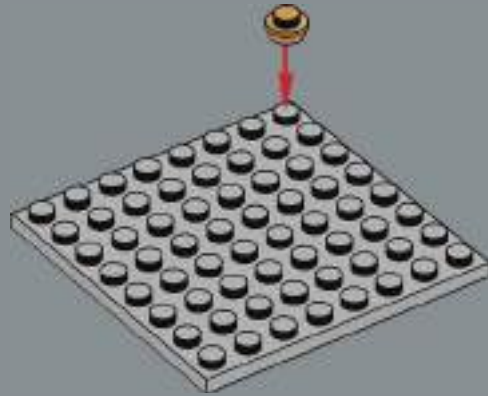

80

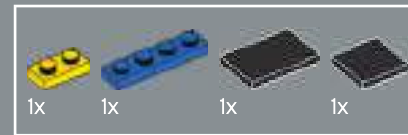
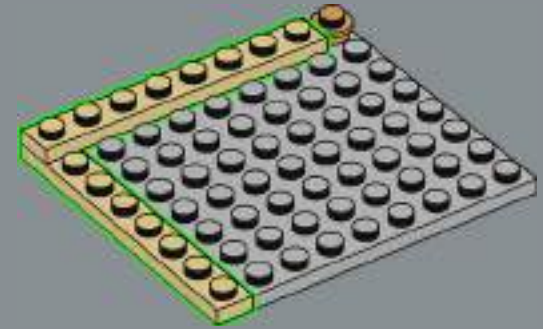

81

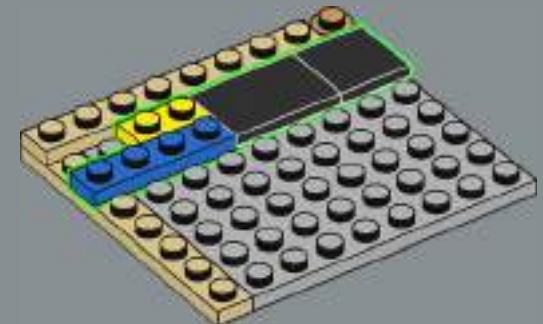



82

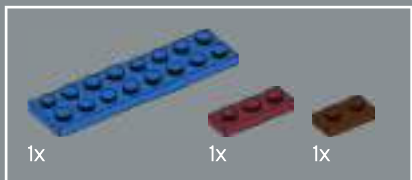
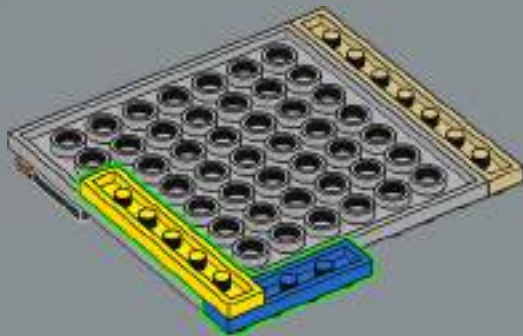

83

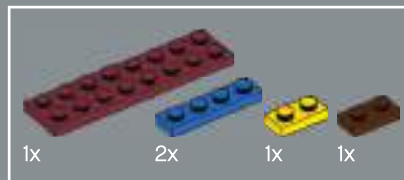
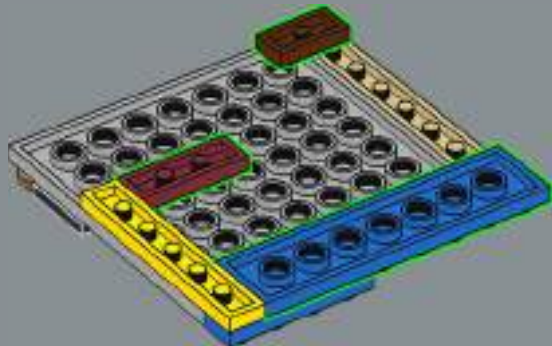

84

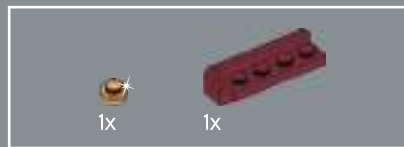
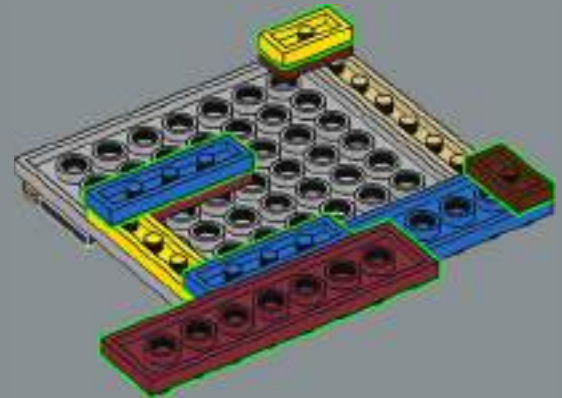

85

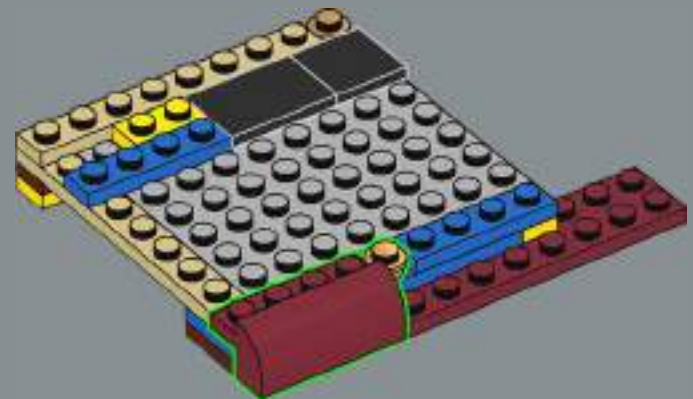

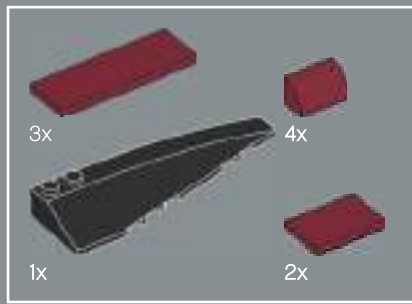

86

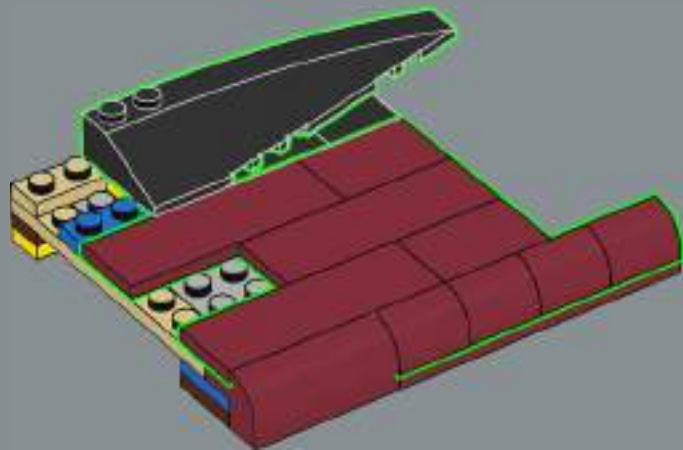

87

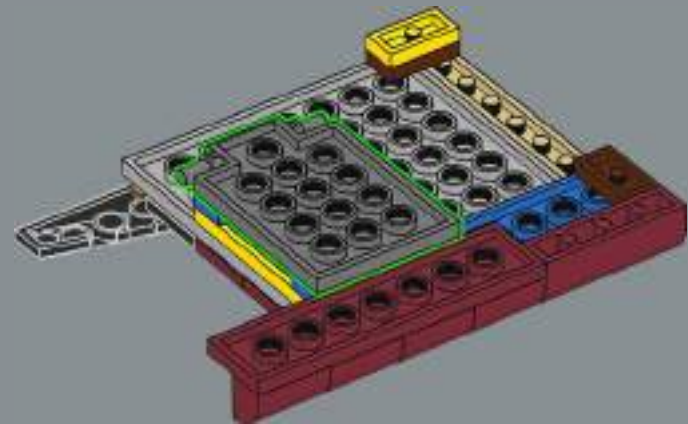

The *Titanic* was 640 km (400 miles) from land when she struck the iceberg.

88

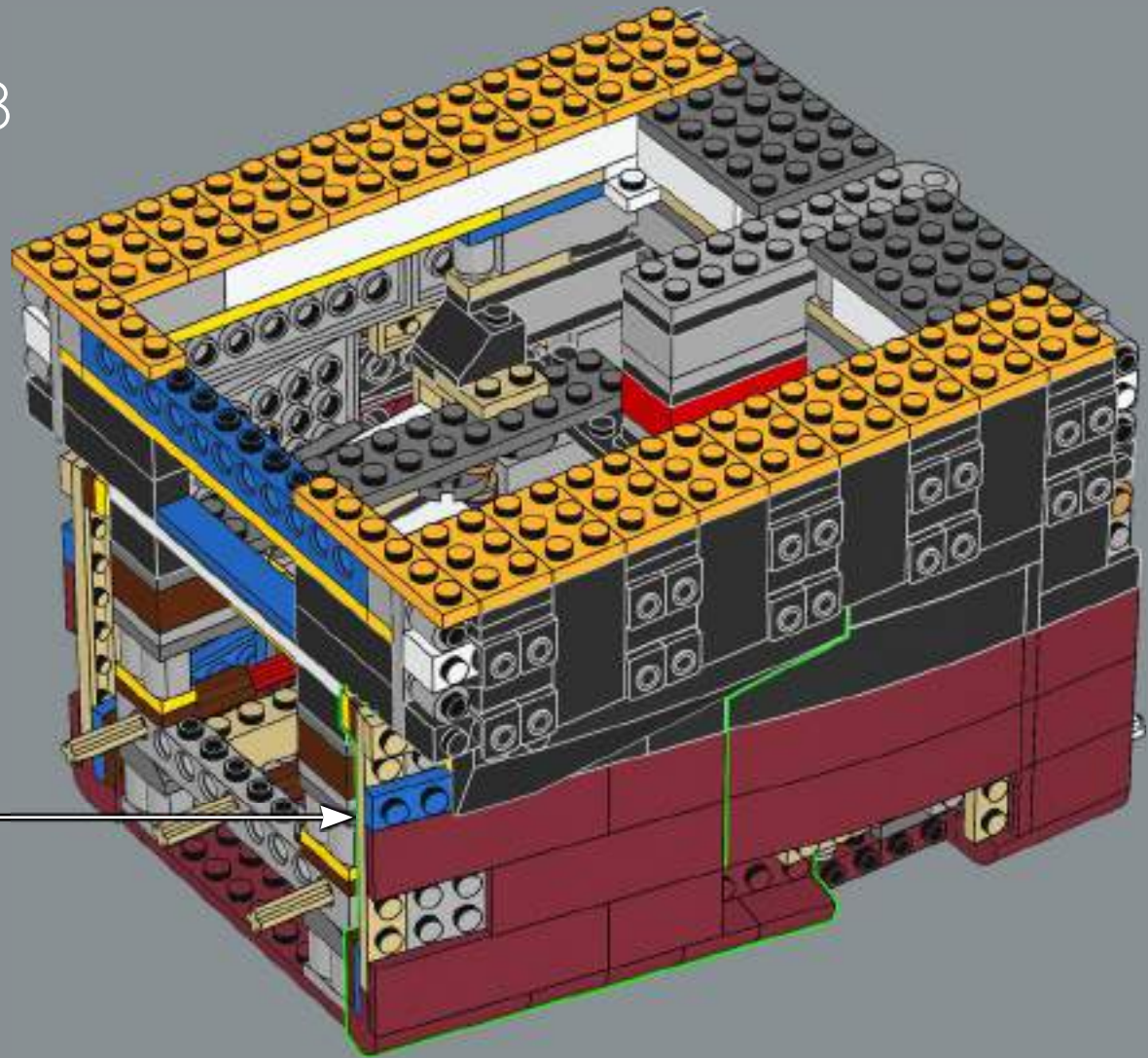

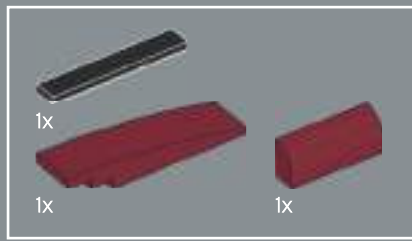

89

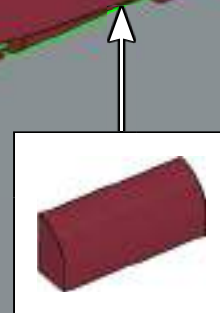

32

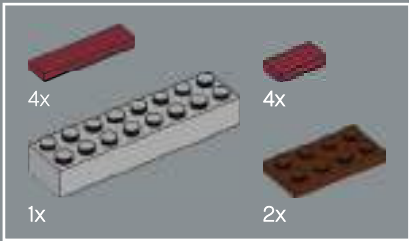
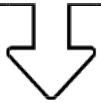

90



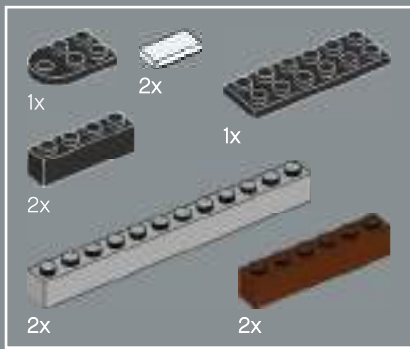

91

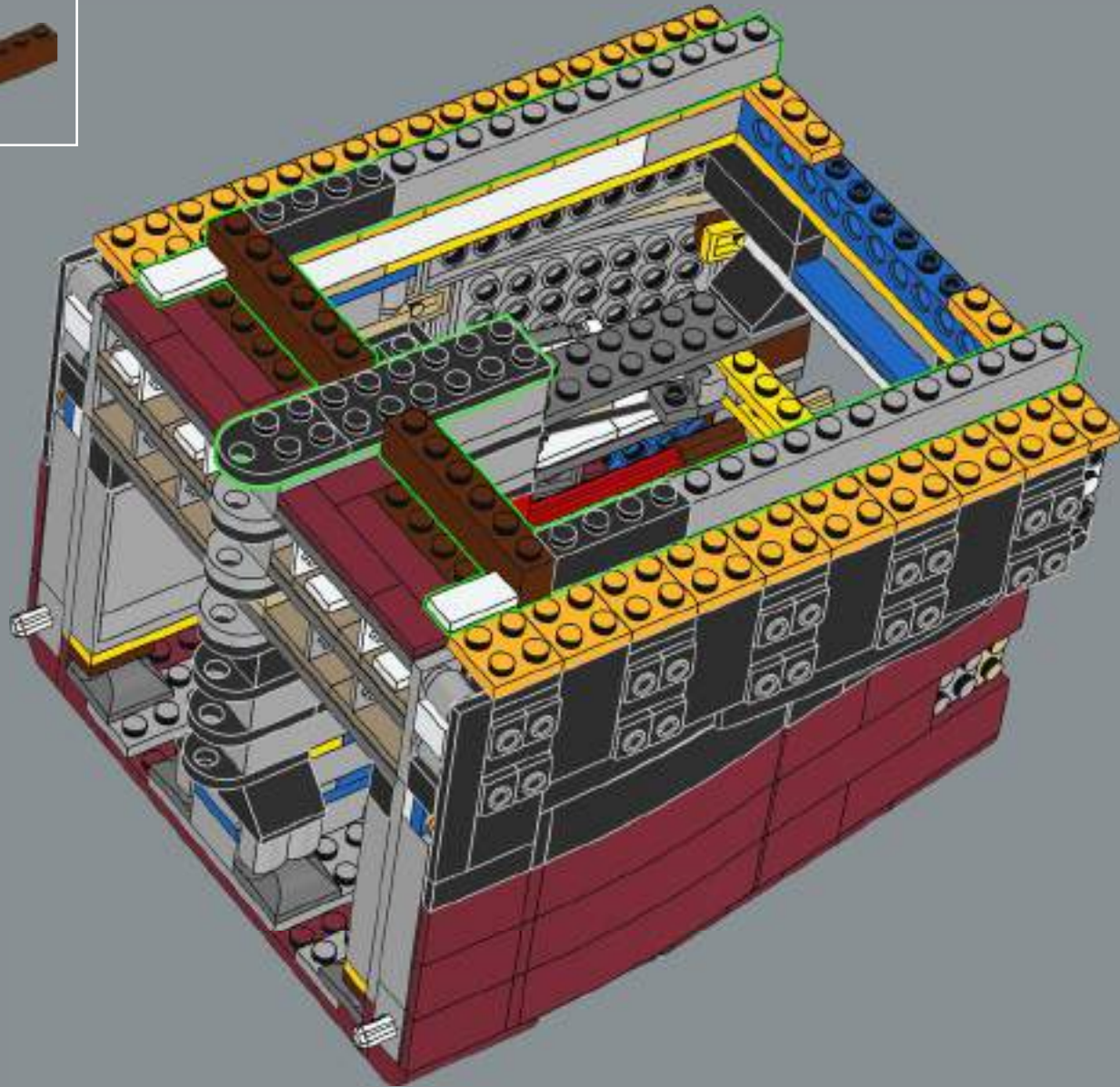



92





18x

93

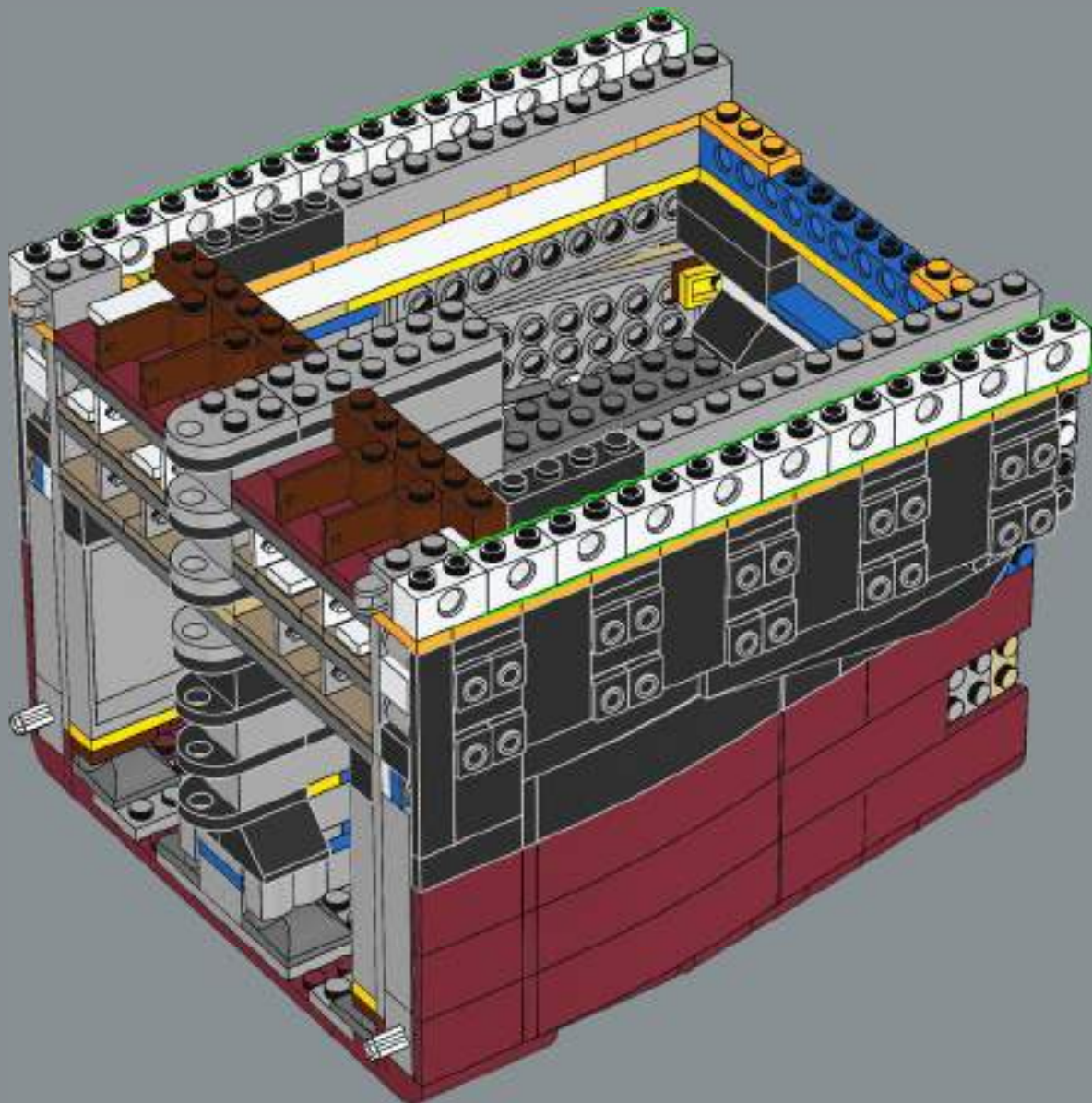

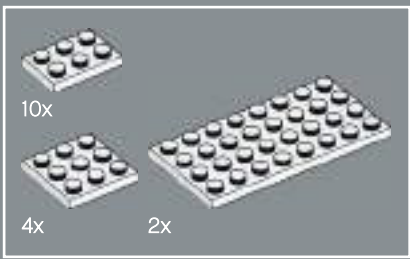

94

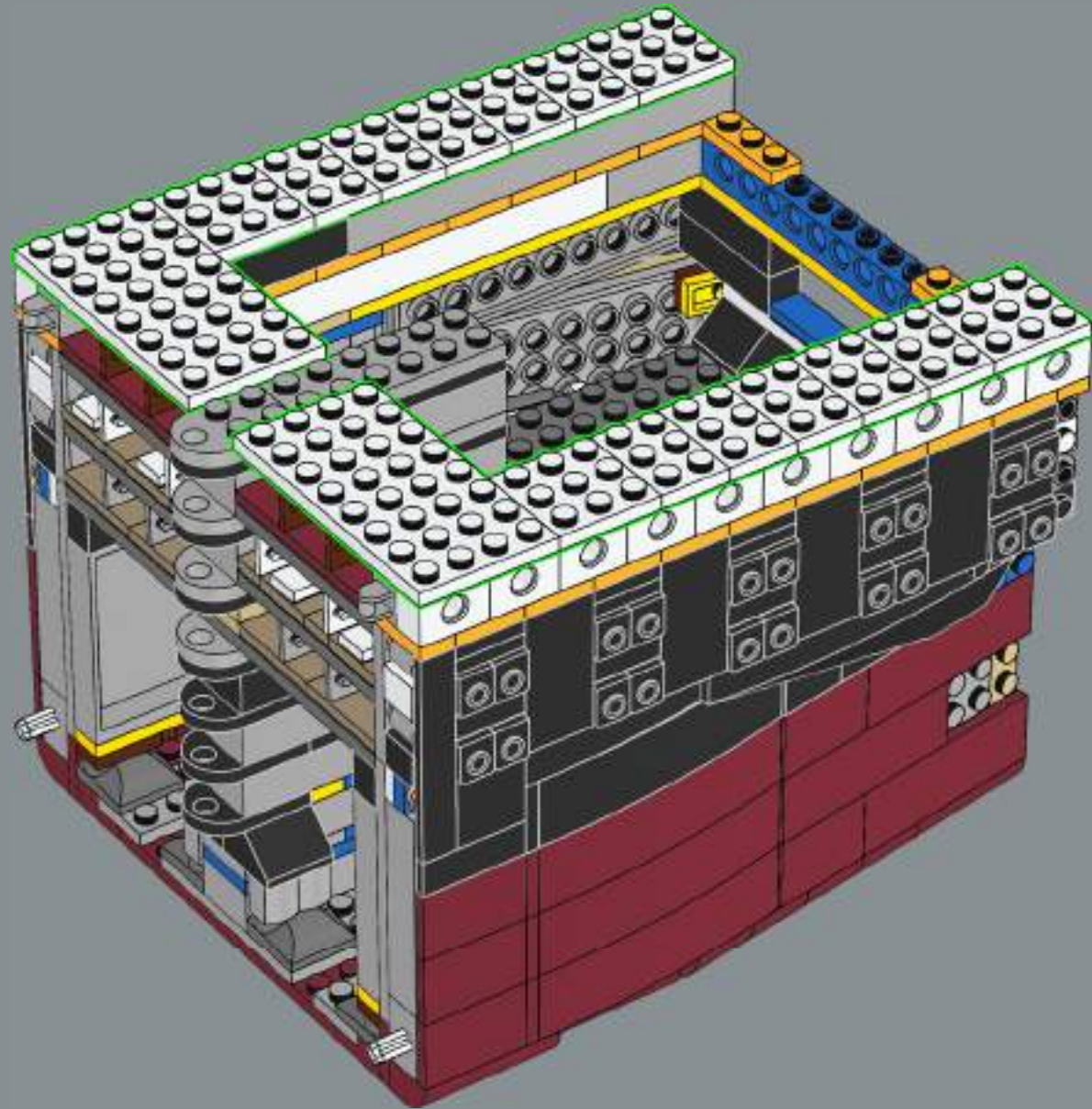



95

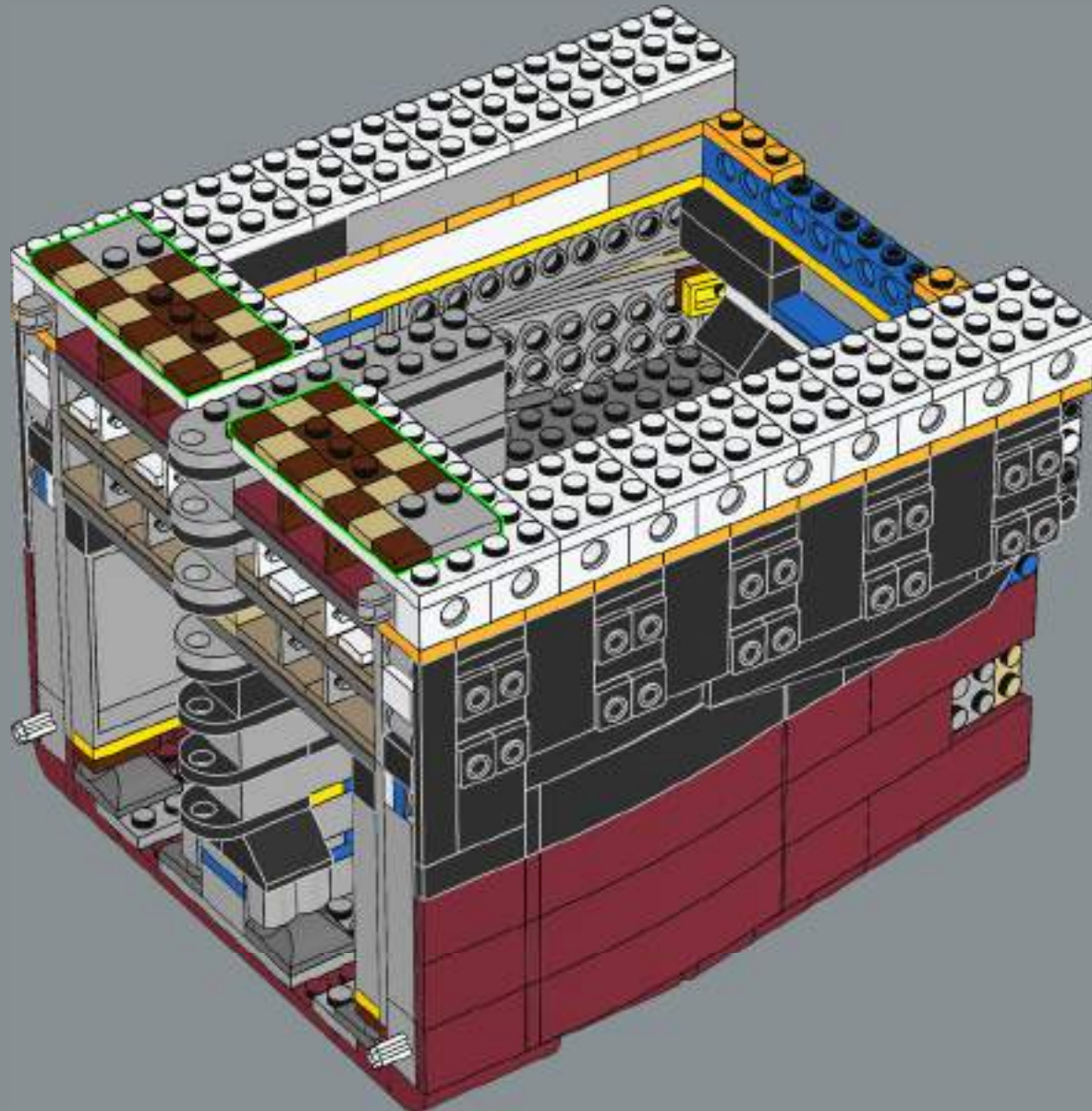

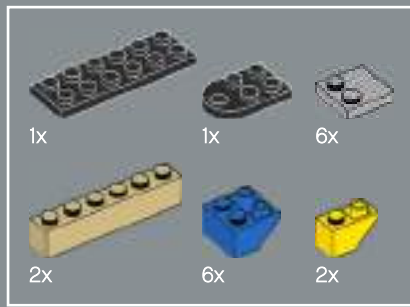

97



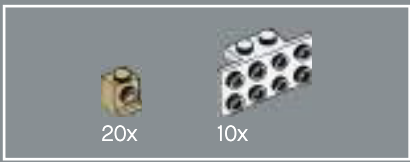

98

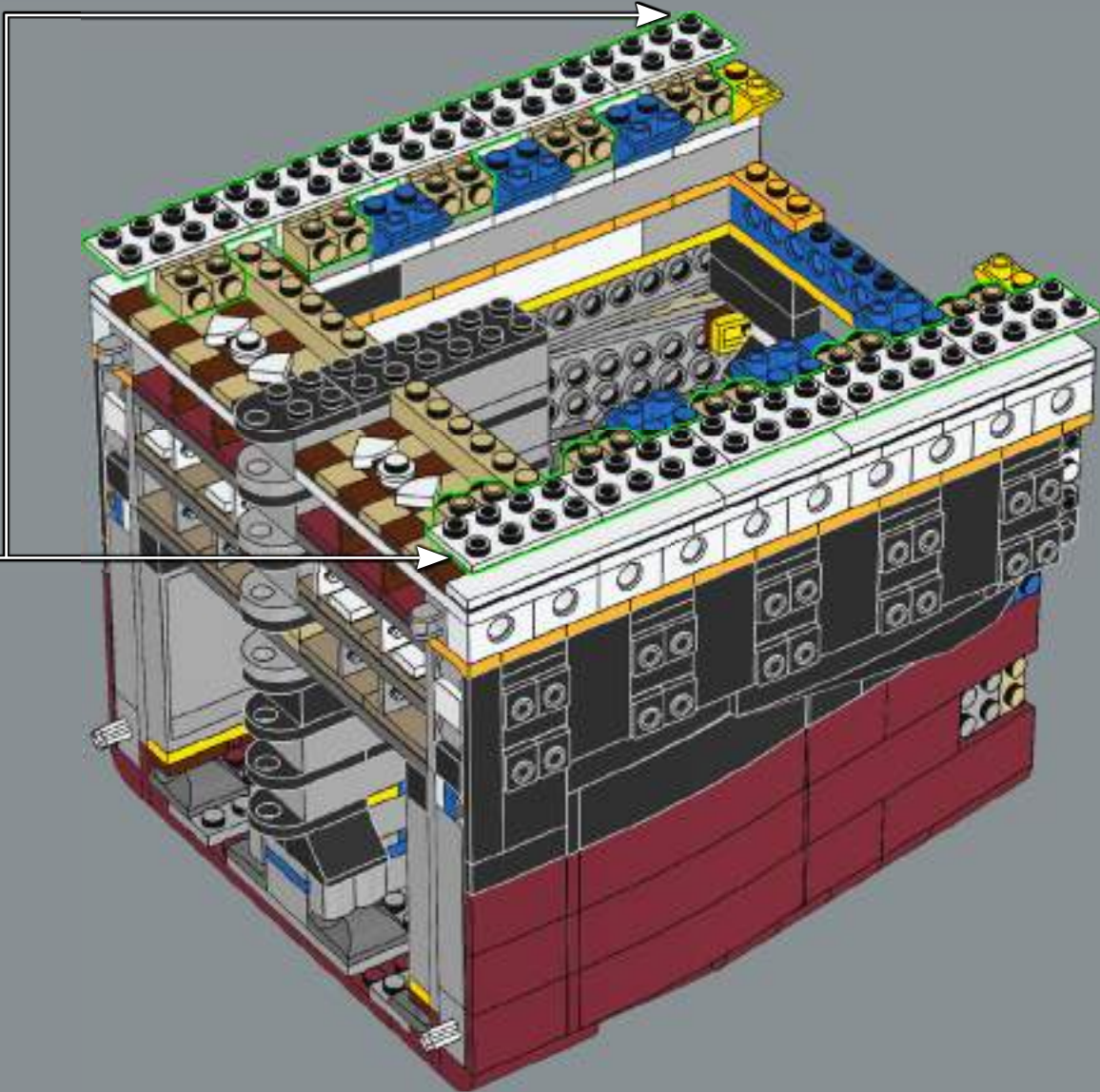
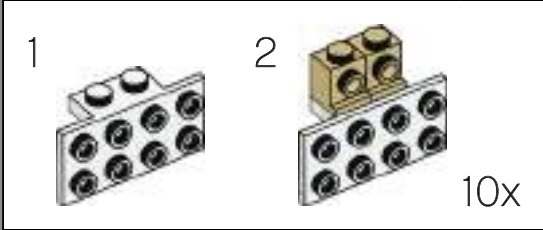



99

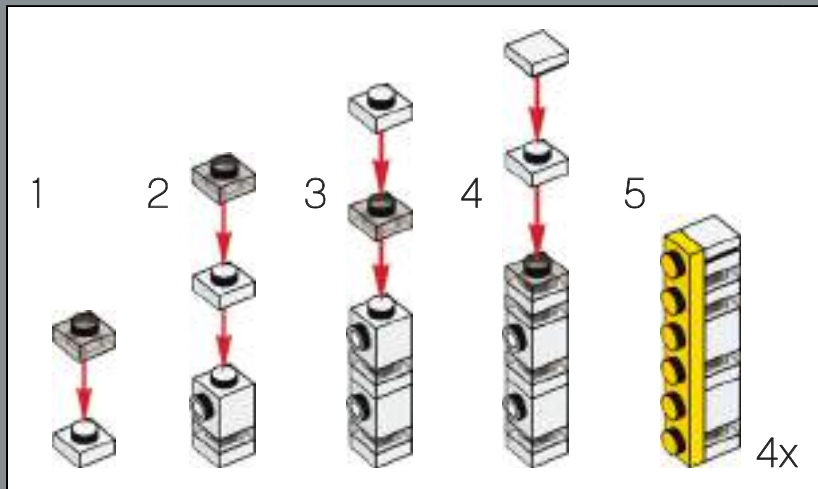
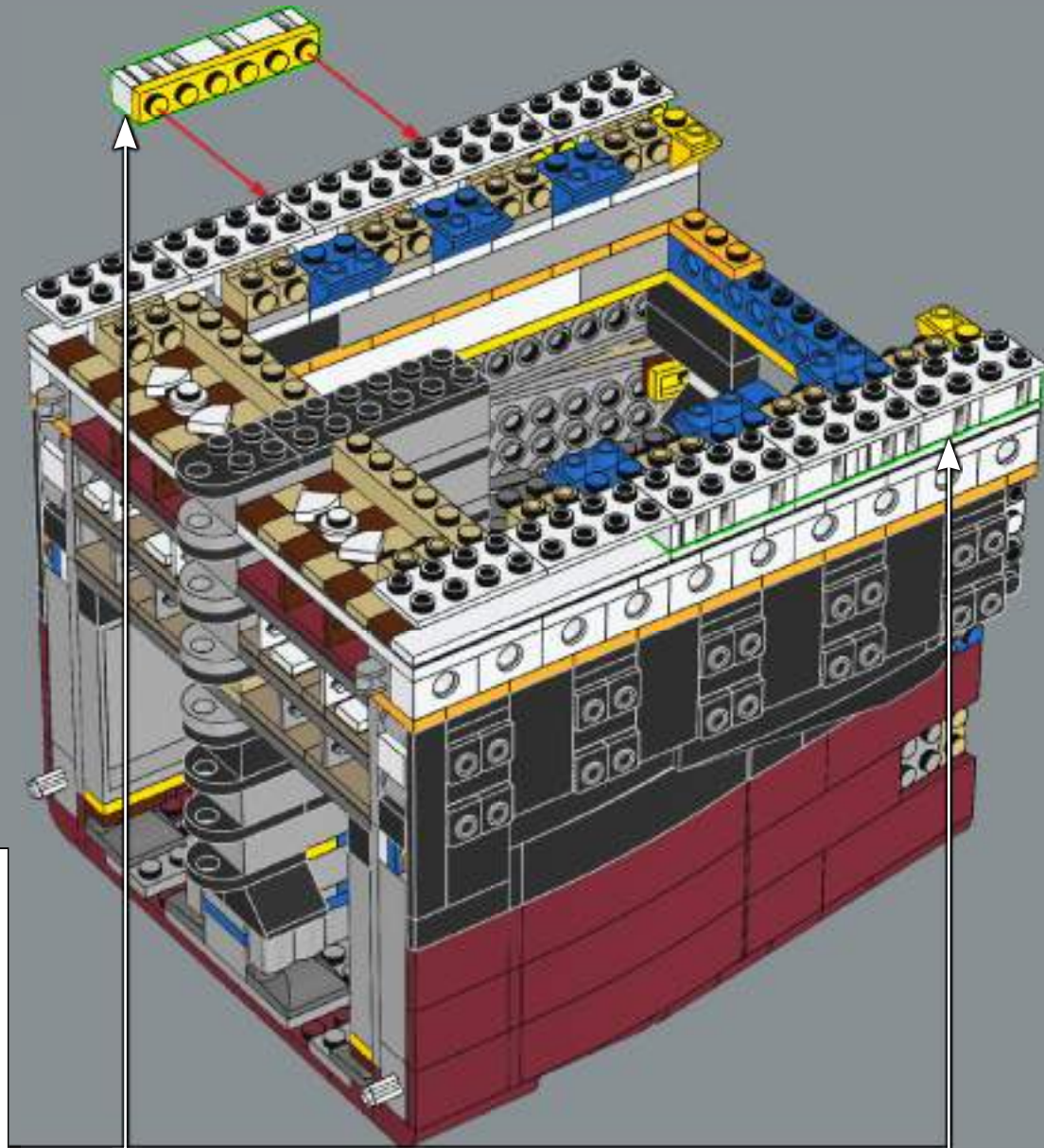

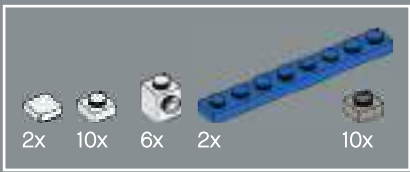

100

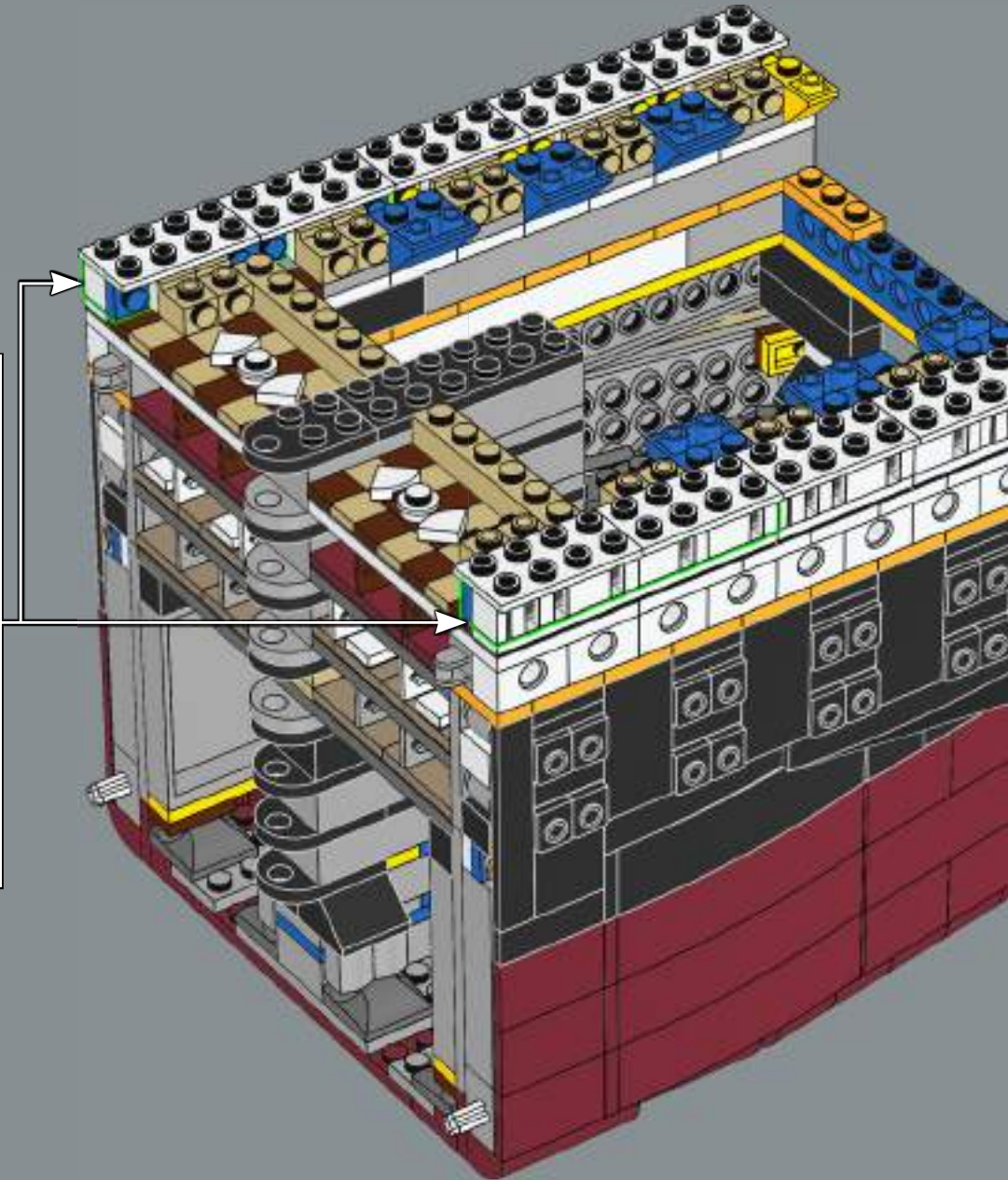
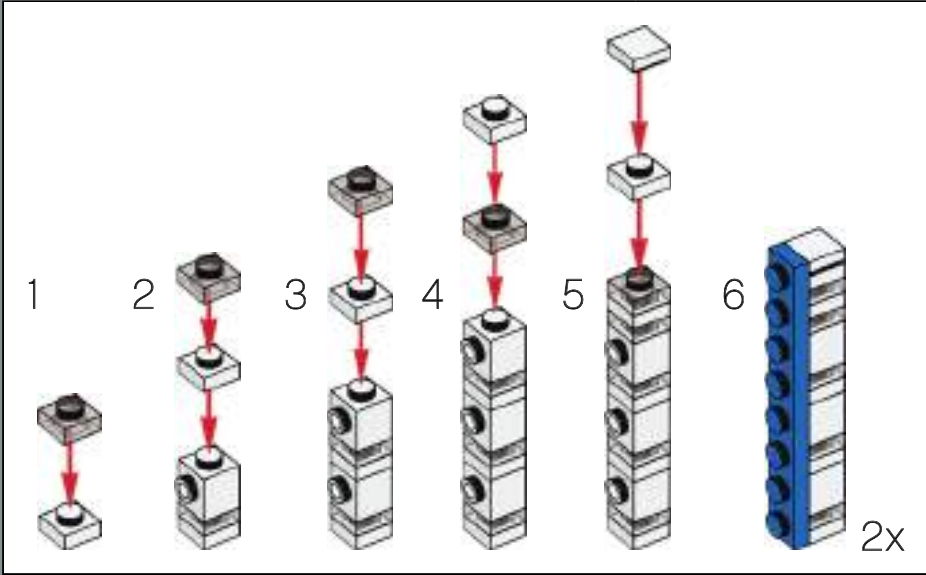

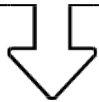

101

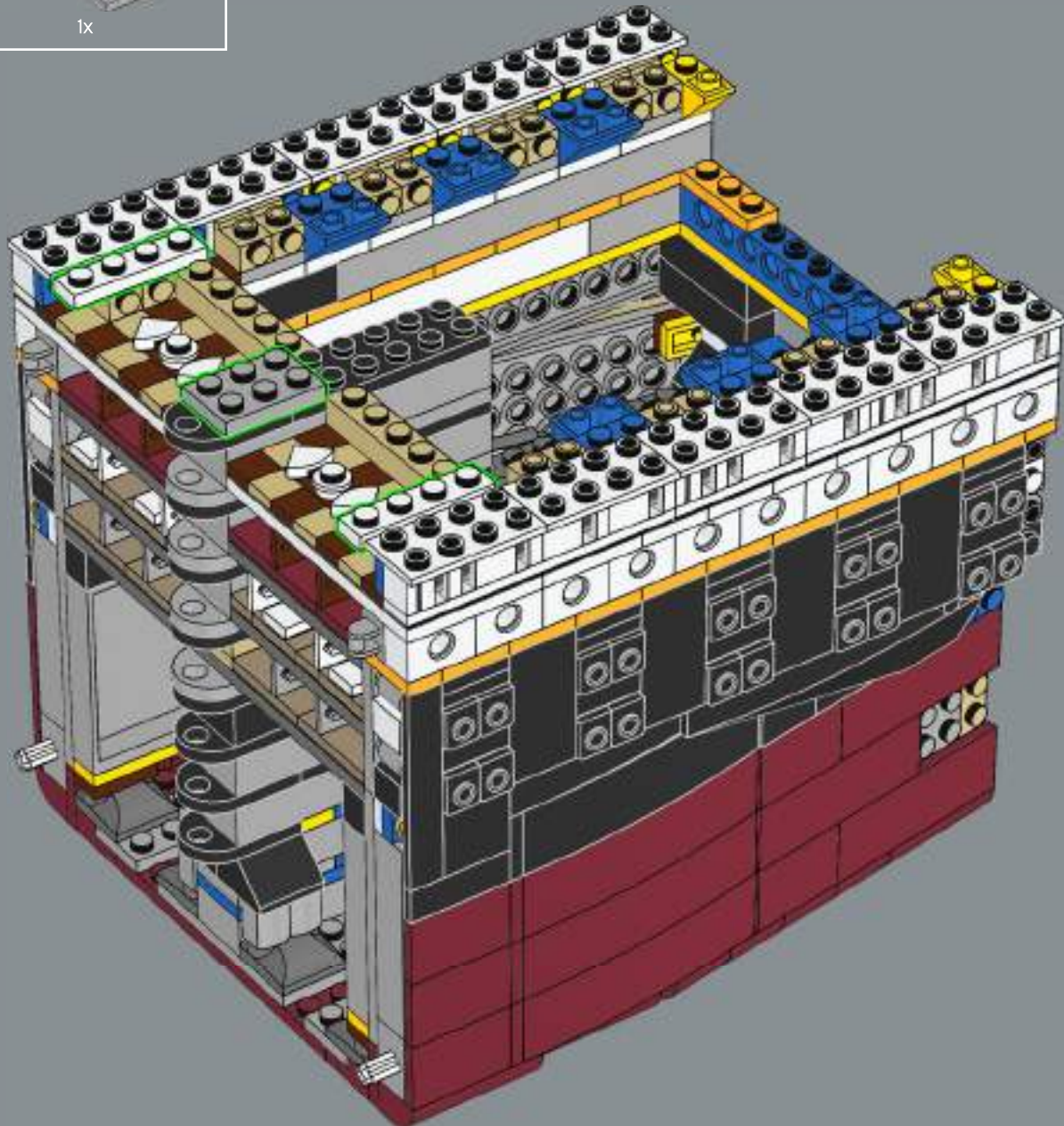

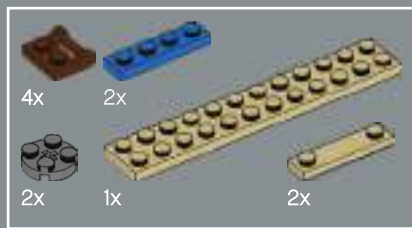

102

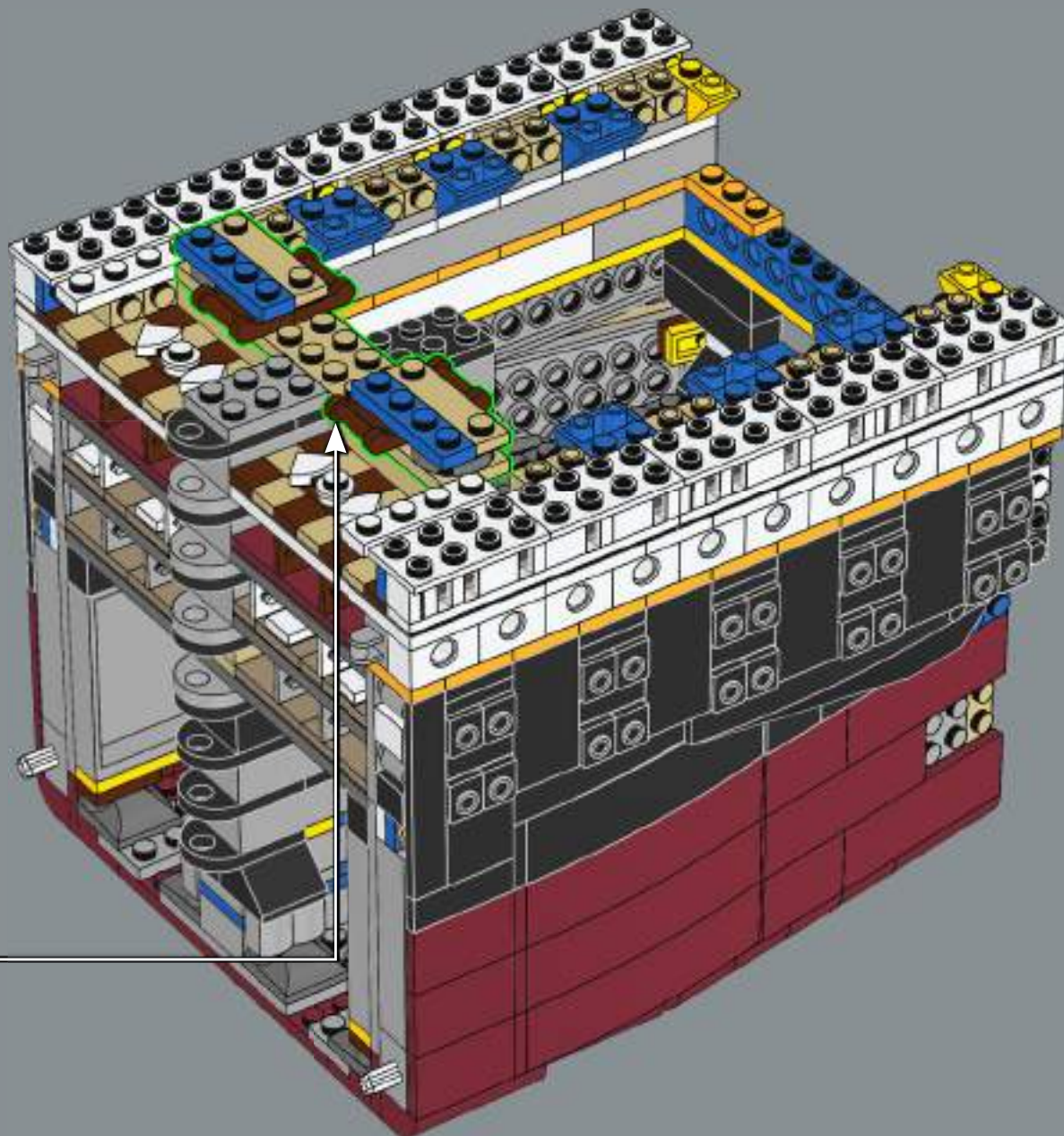
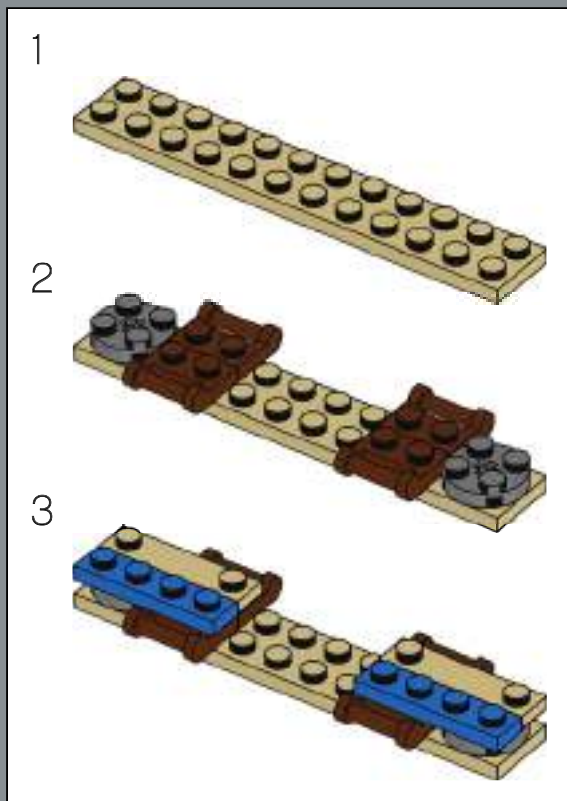

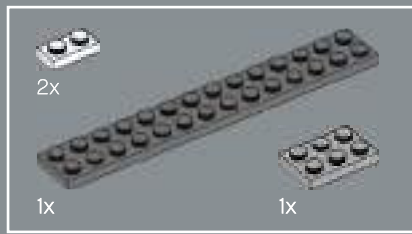

103

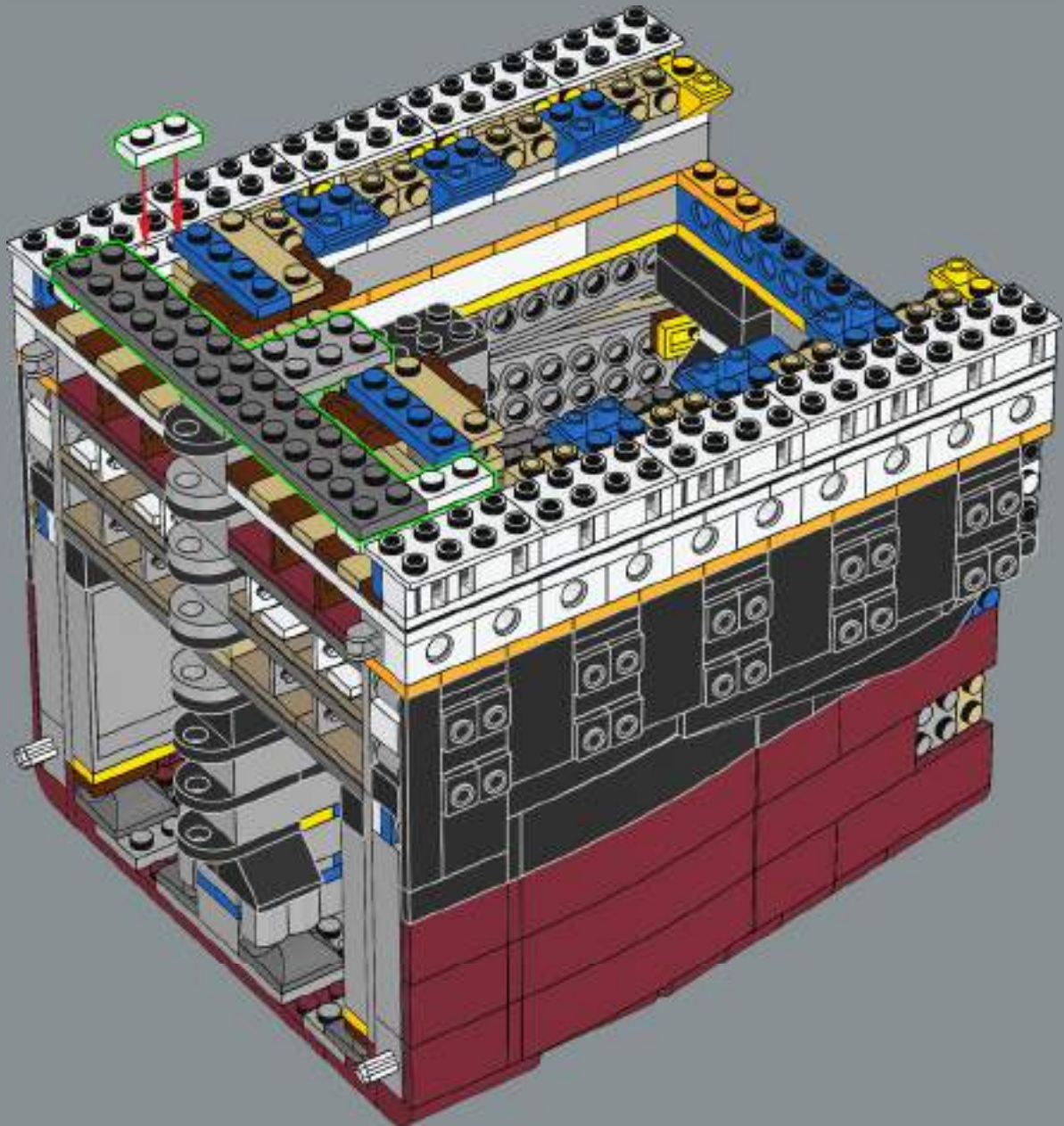



104

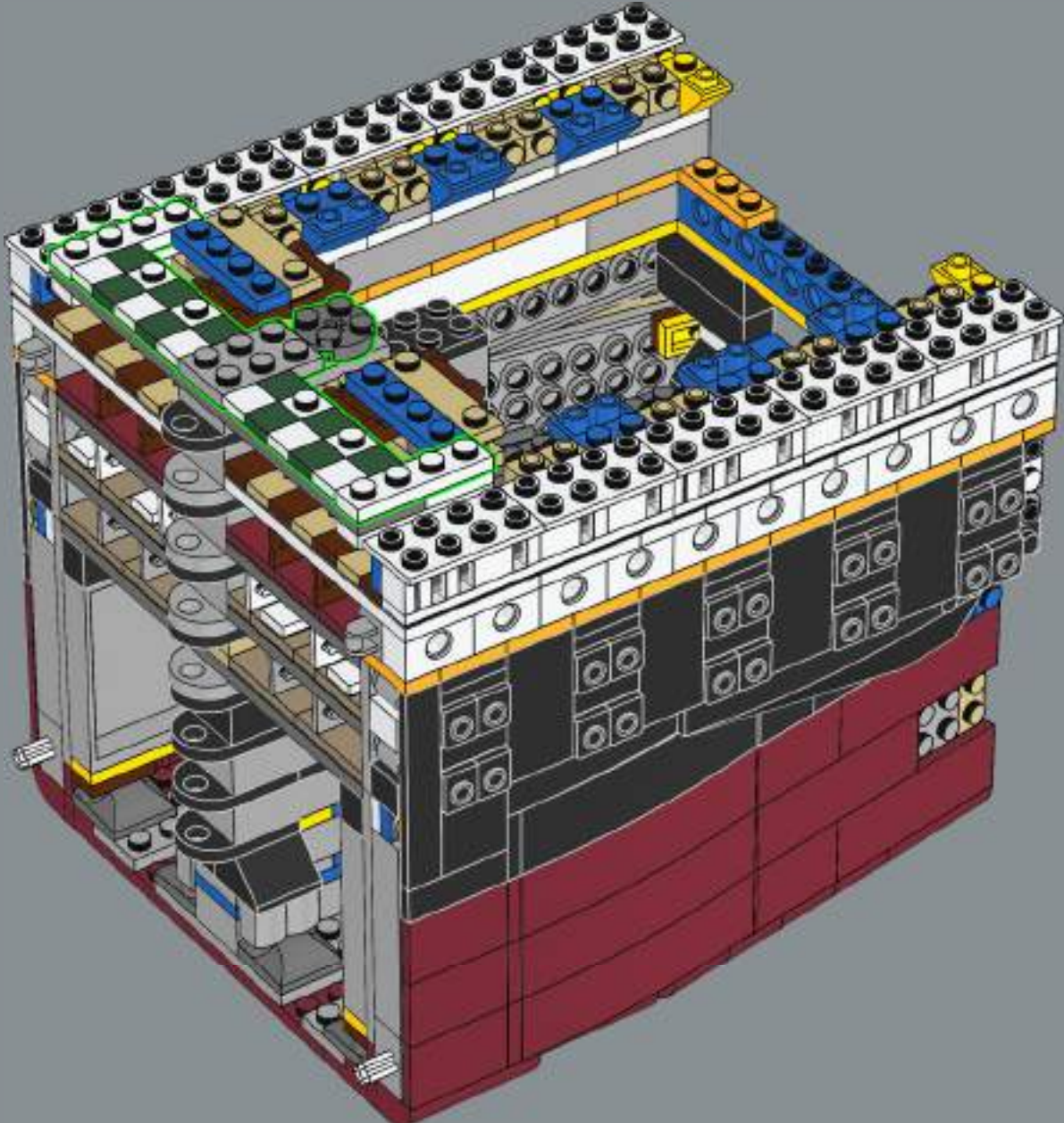

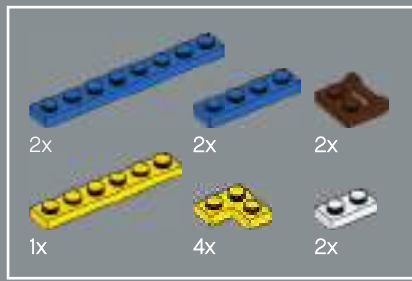

105

1

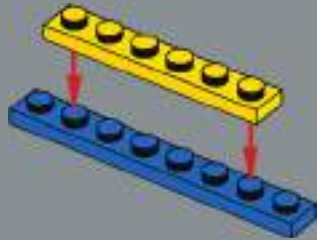

2

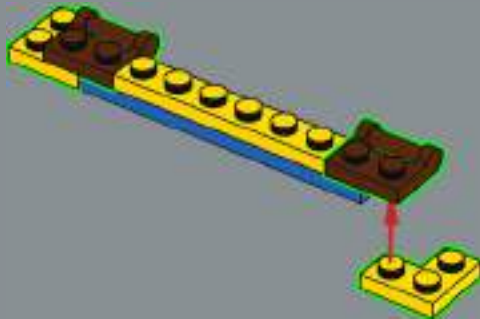

3

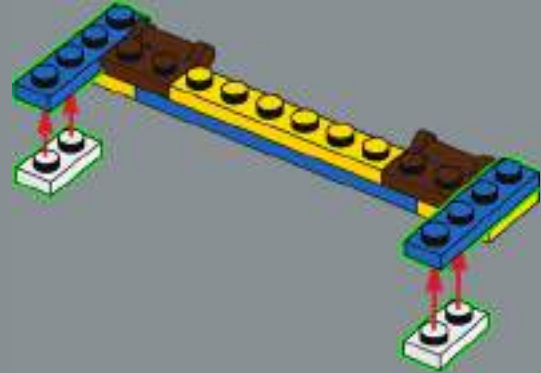

4

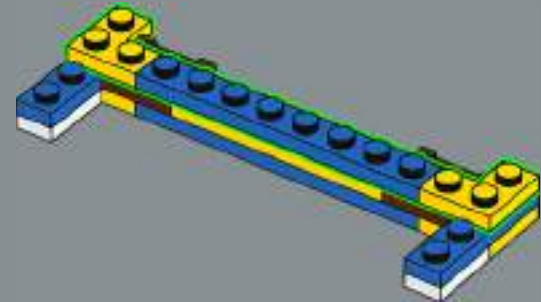

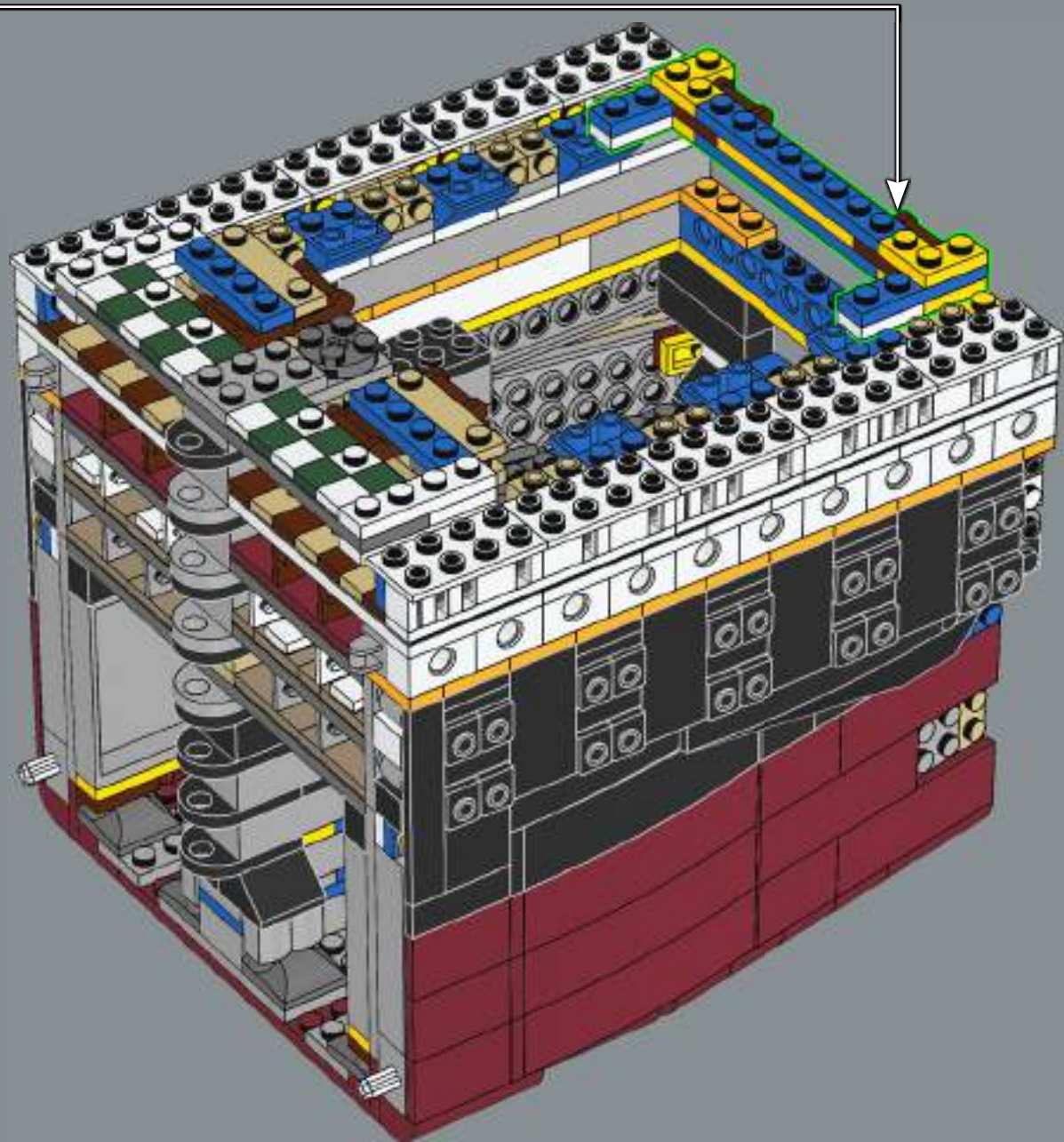

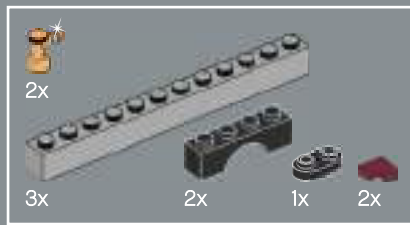

106

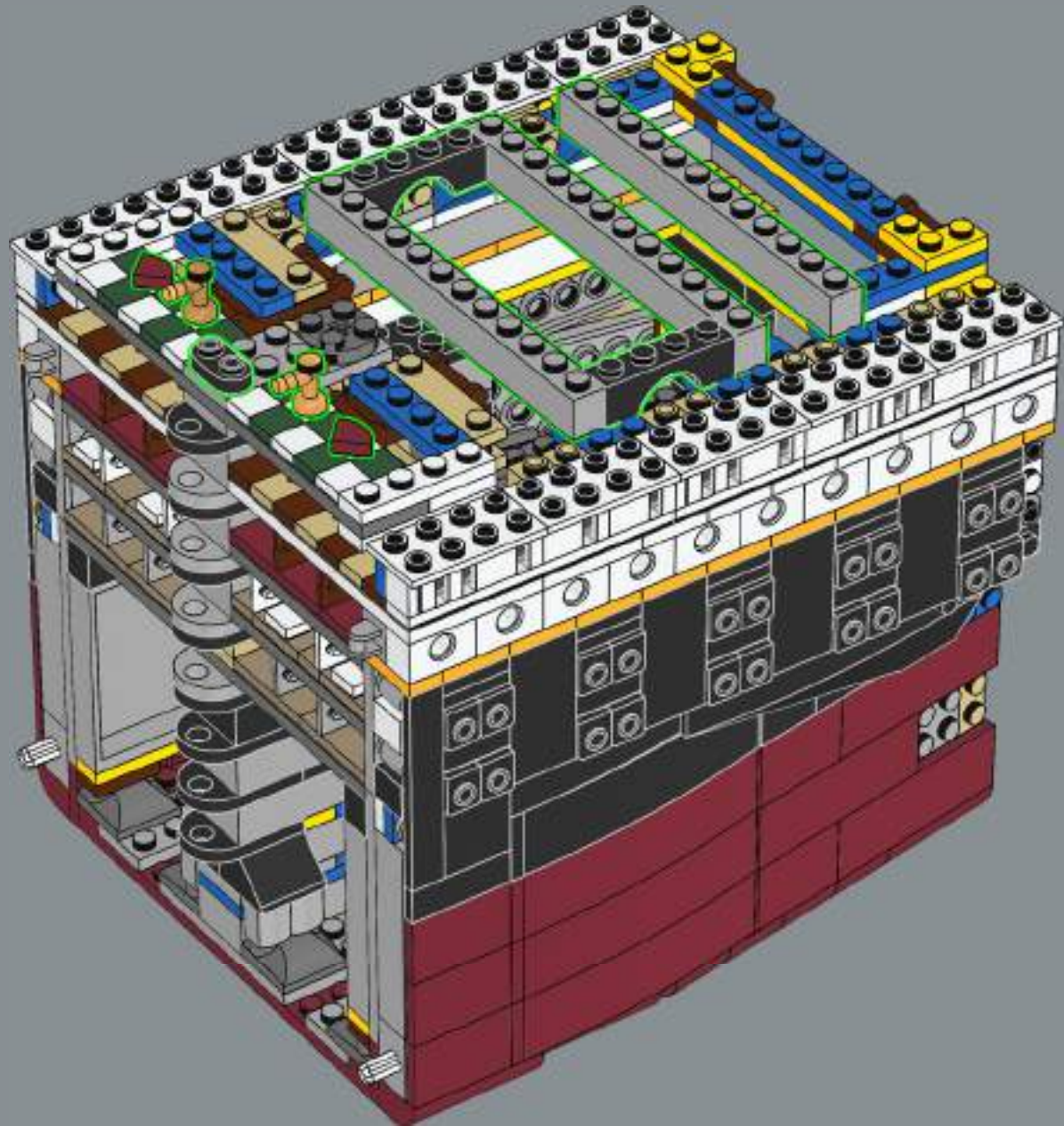

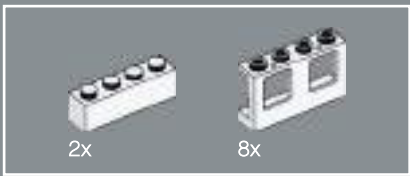

107

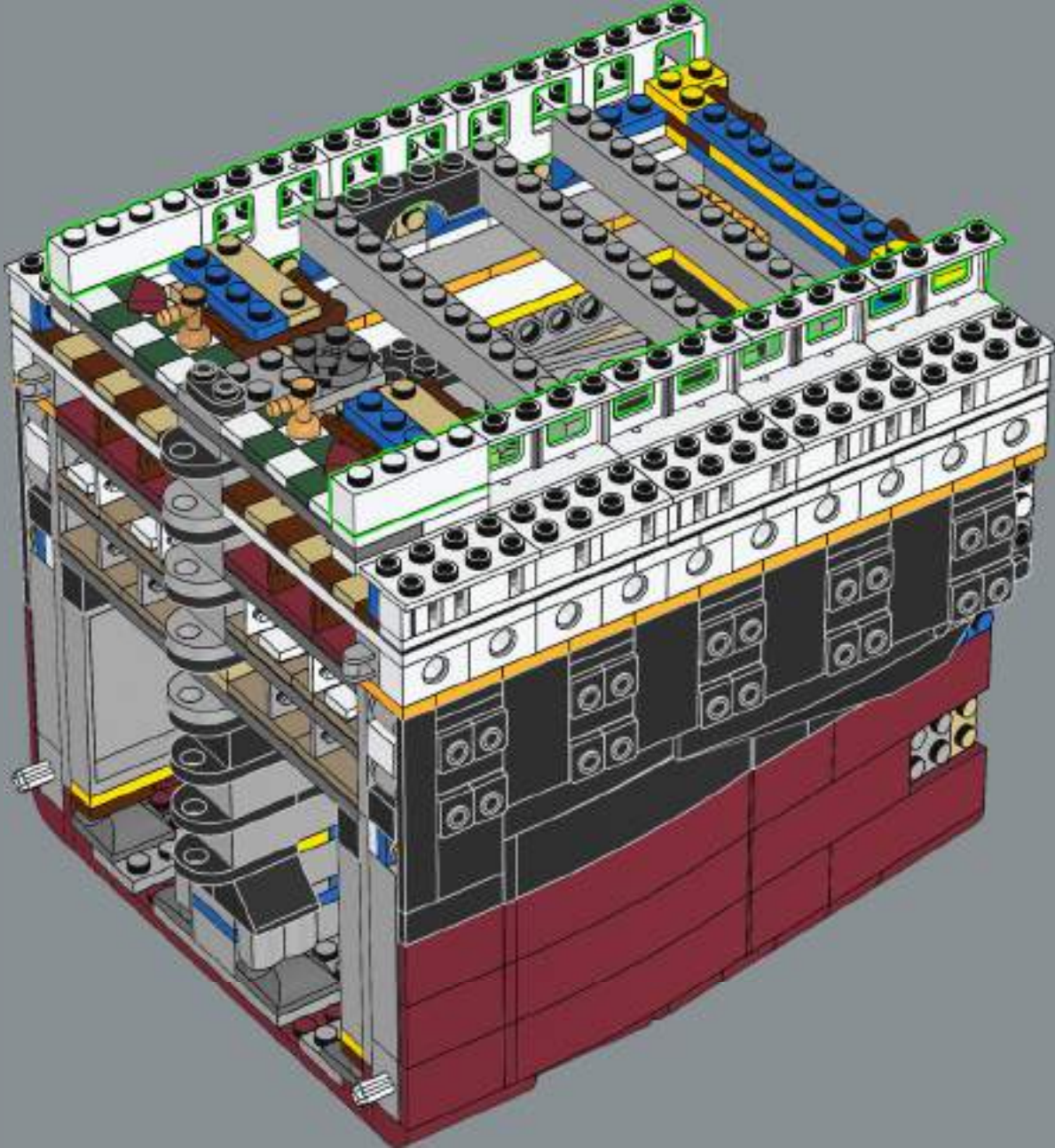

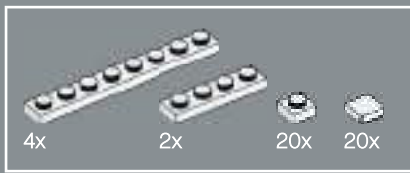

108

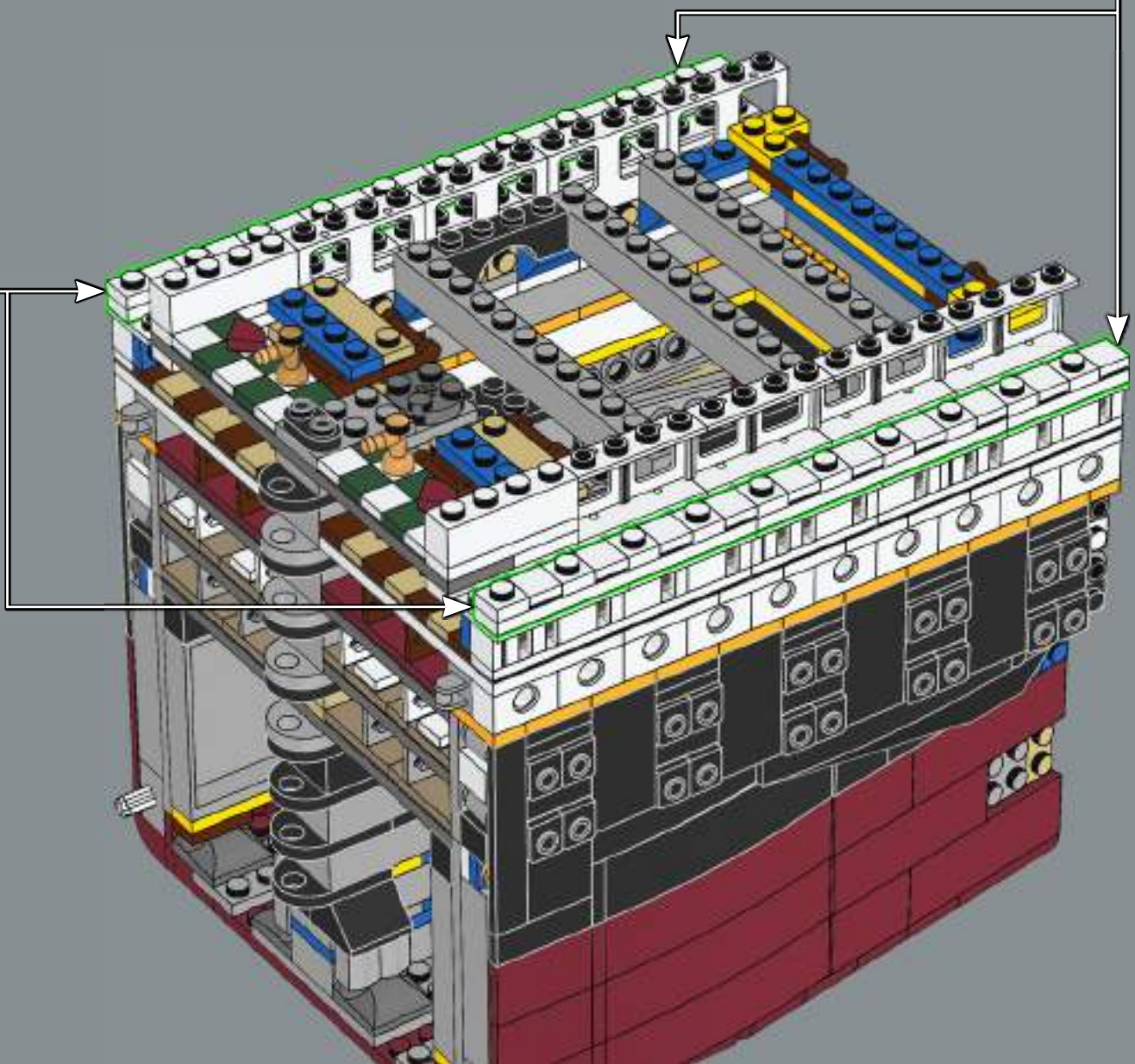
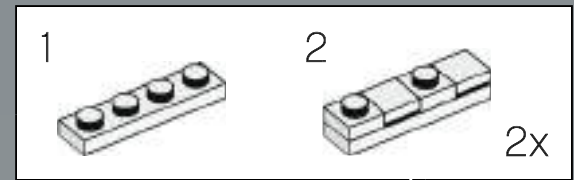
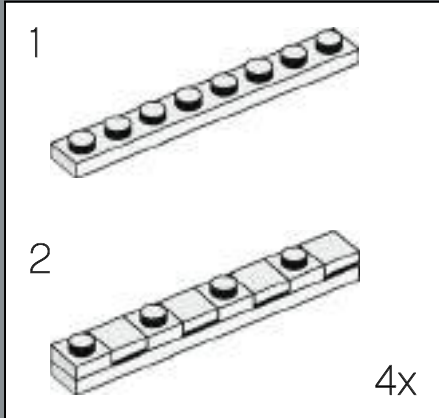



20x

109

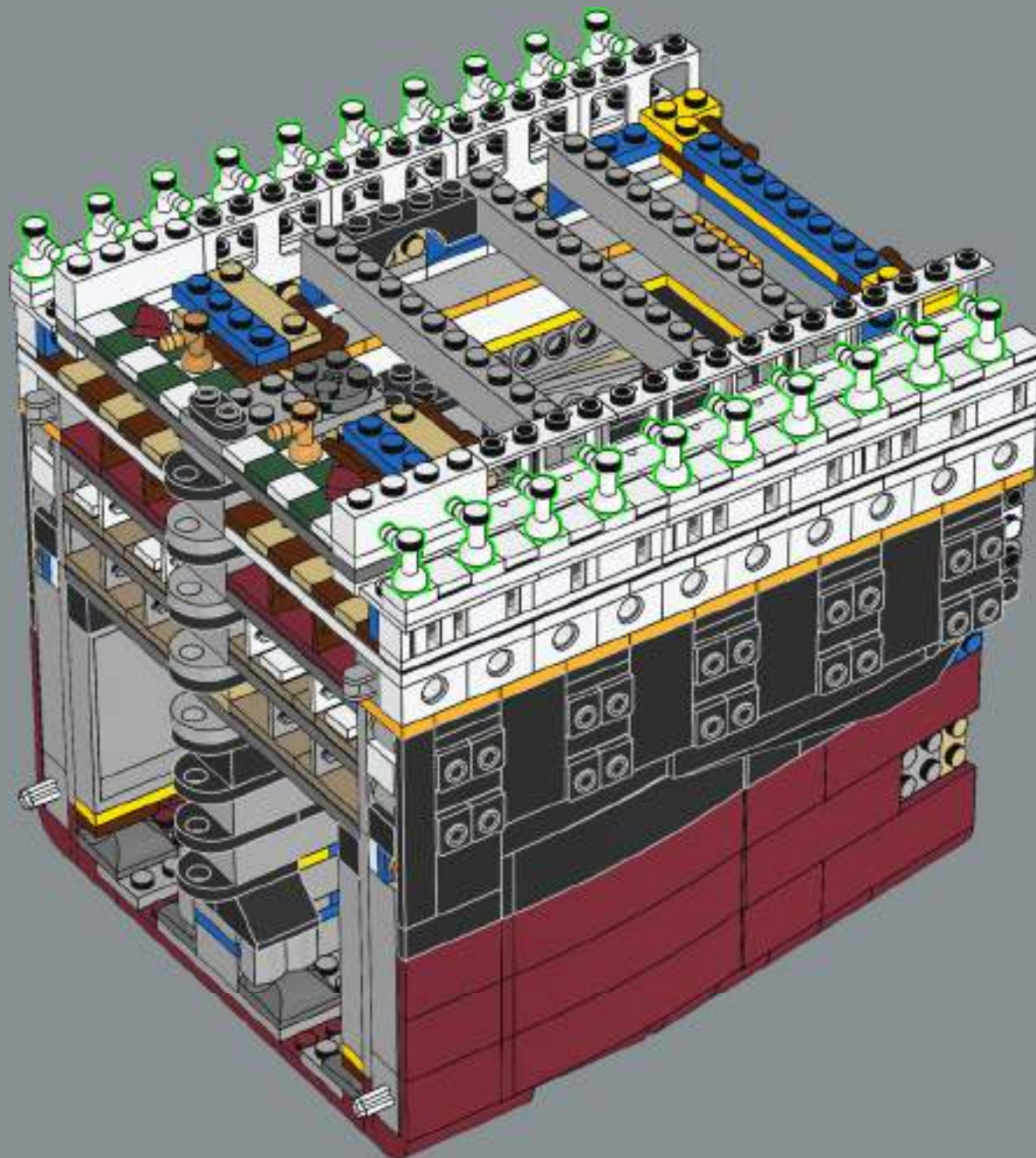

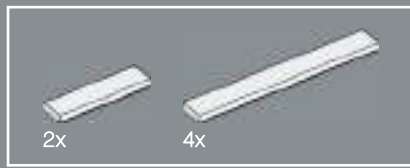

110

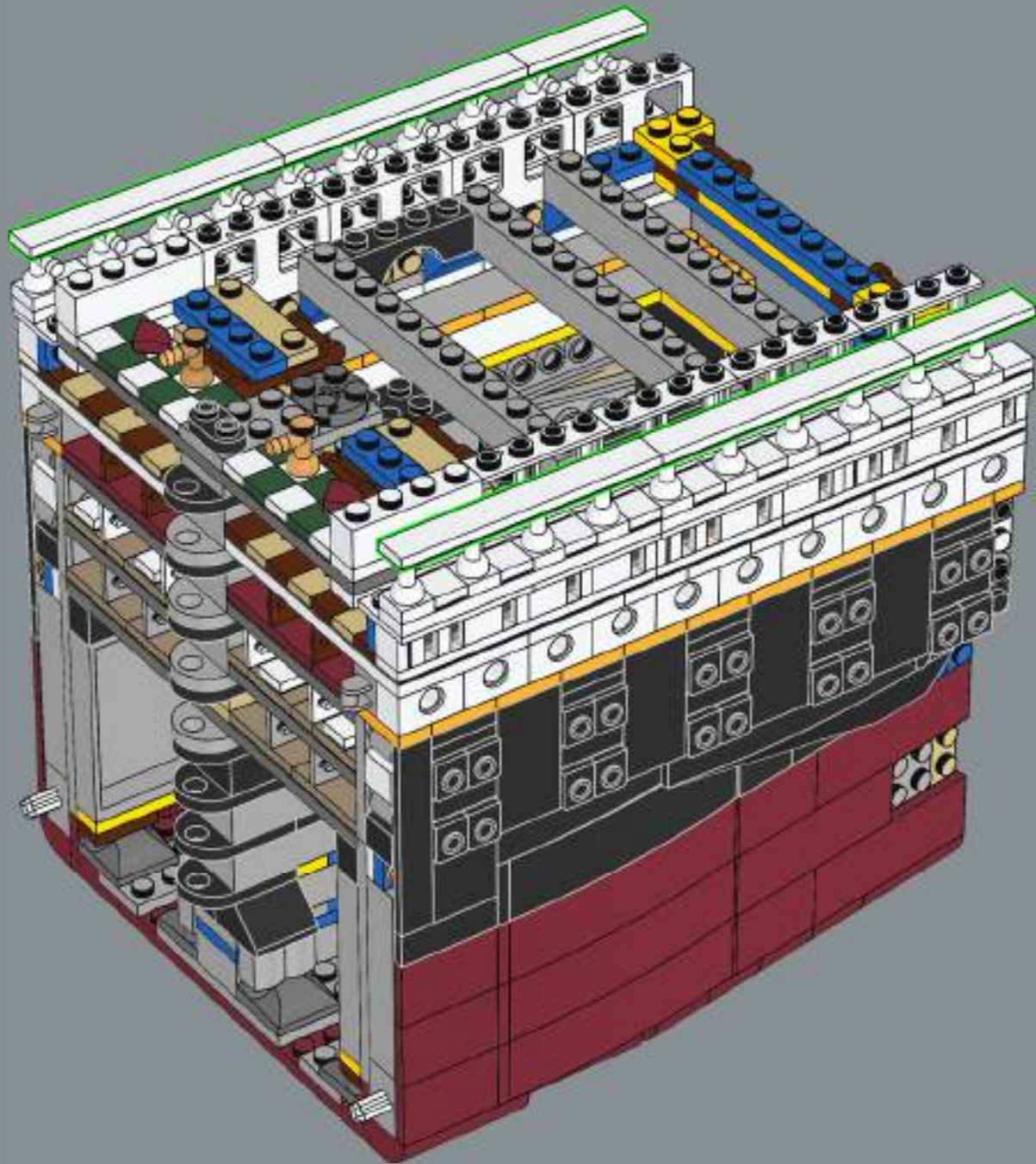

34

2x

4x

2x

111

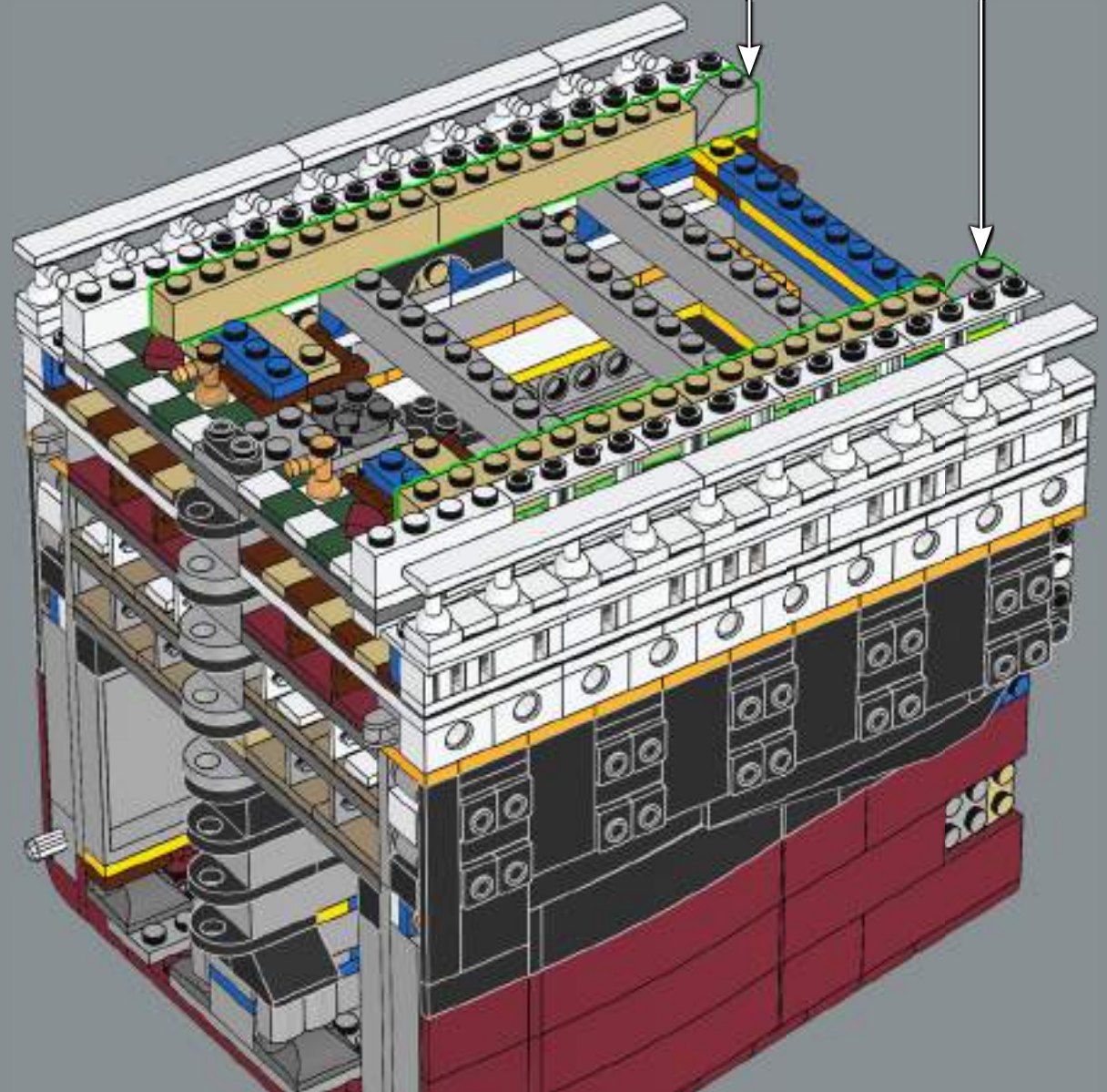

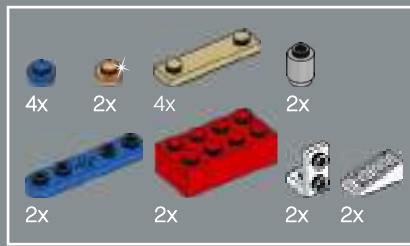

112

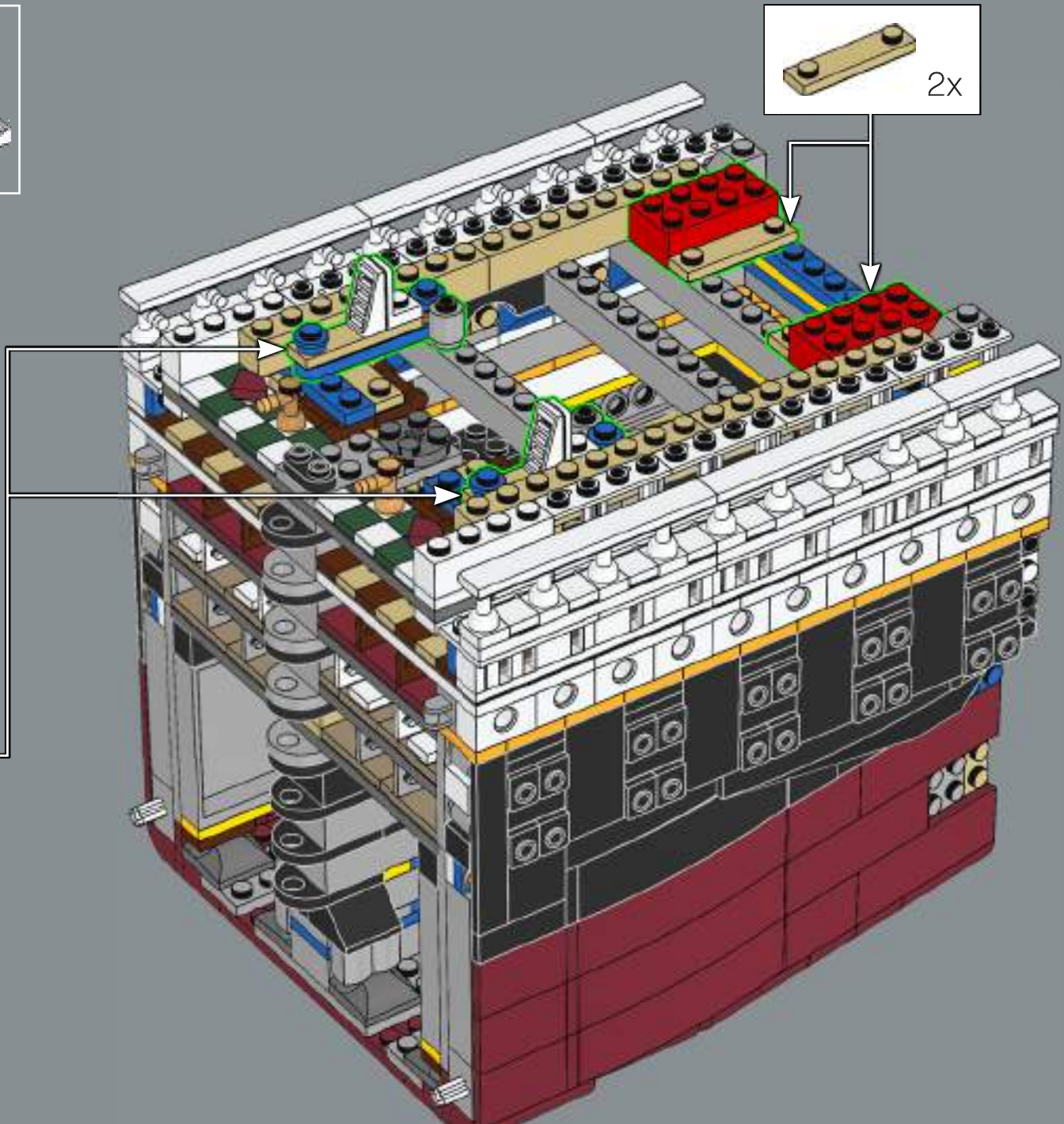
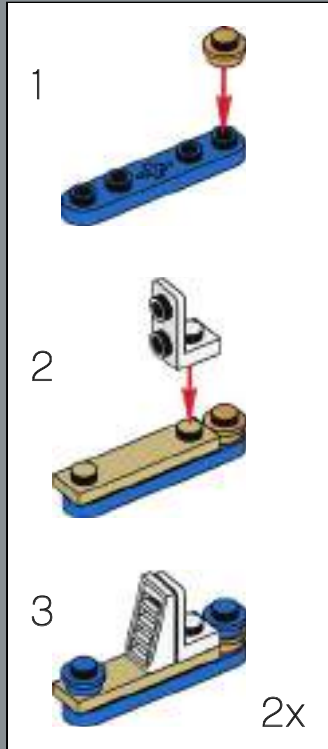

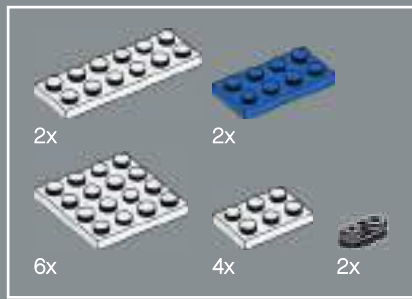

113

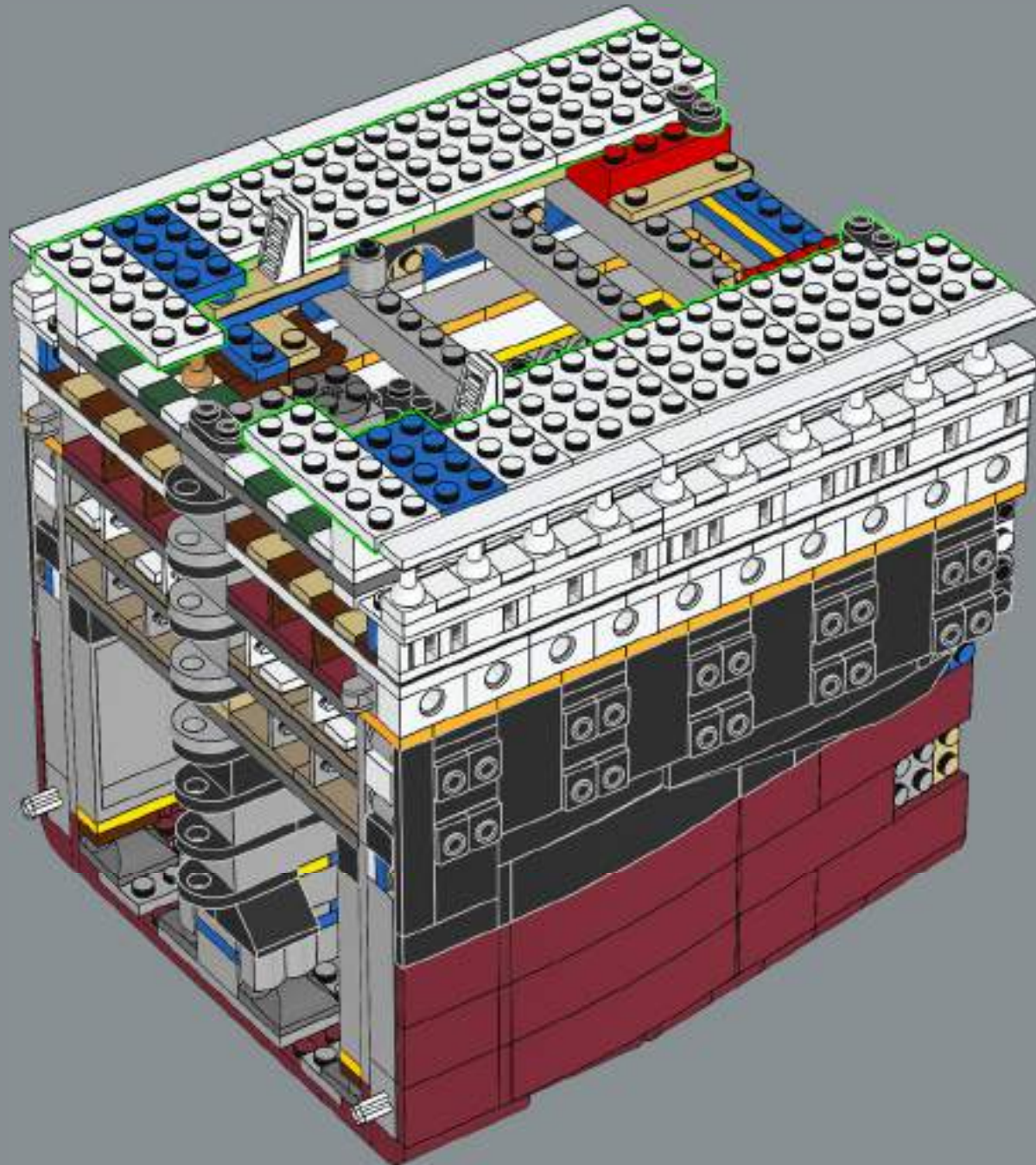

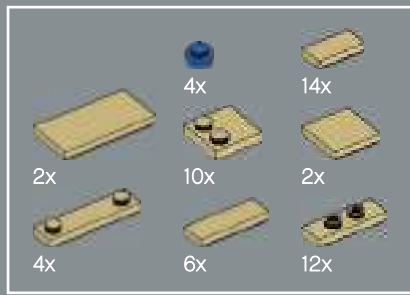

114

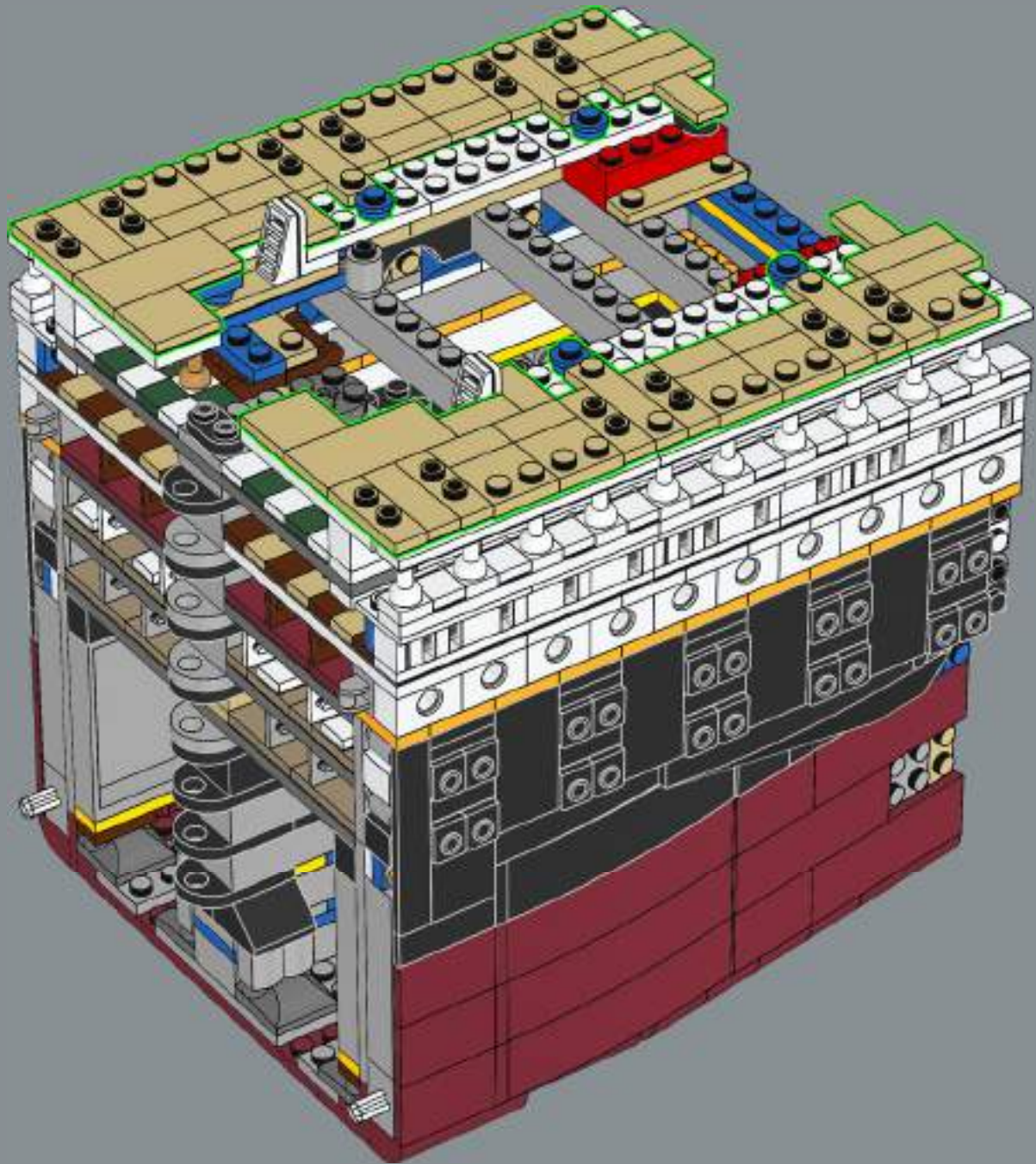

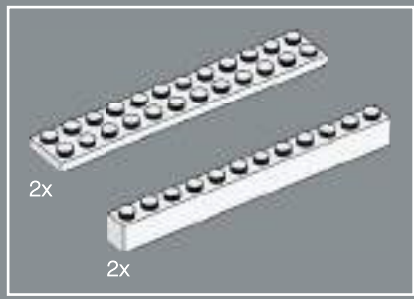

115

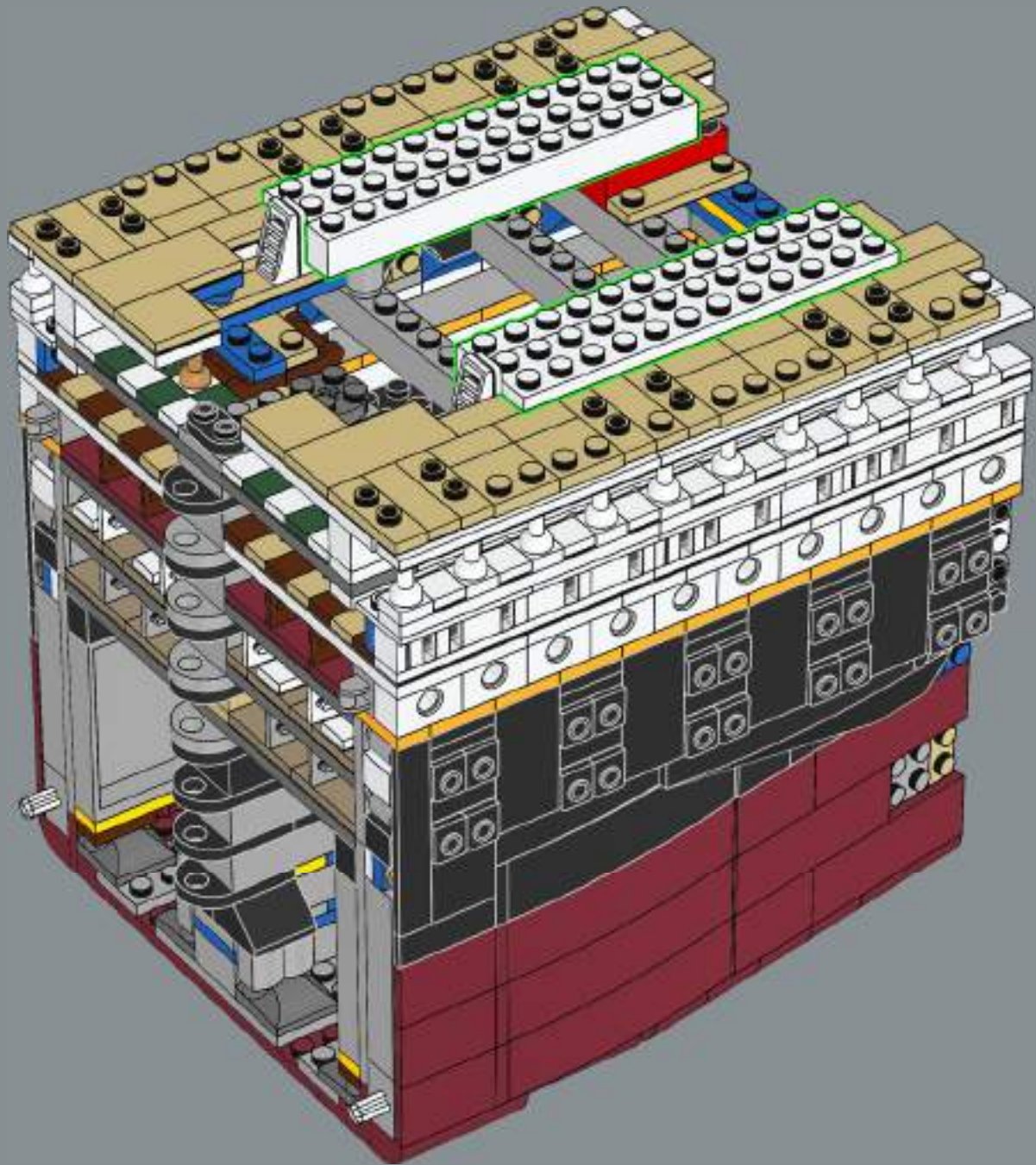

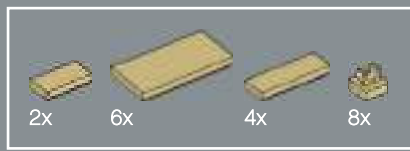

116

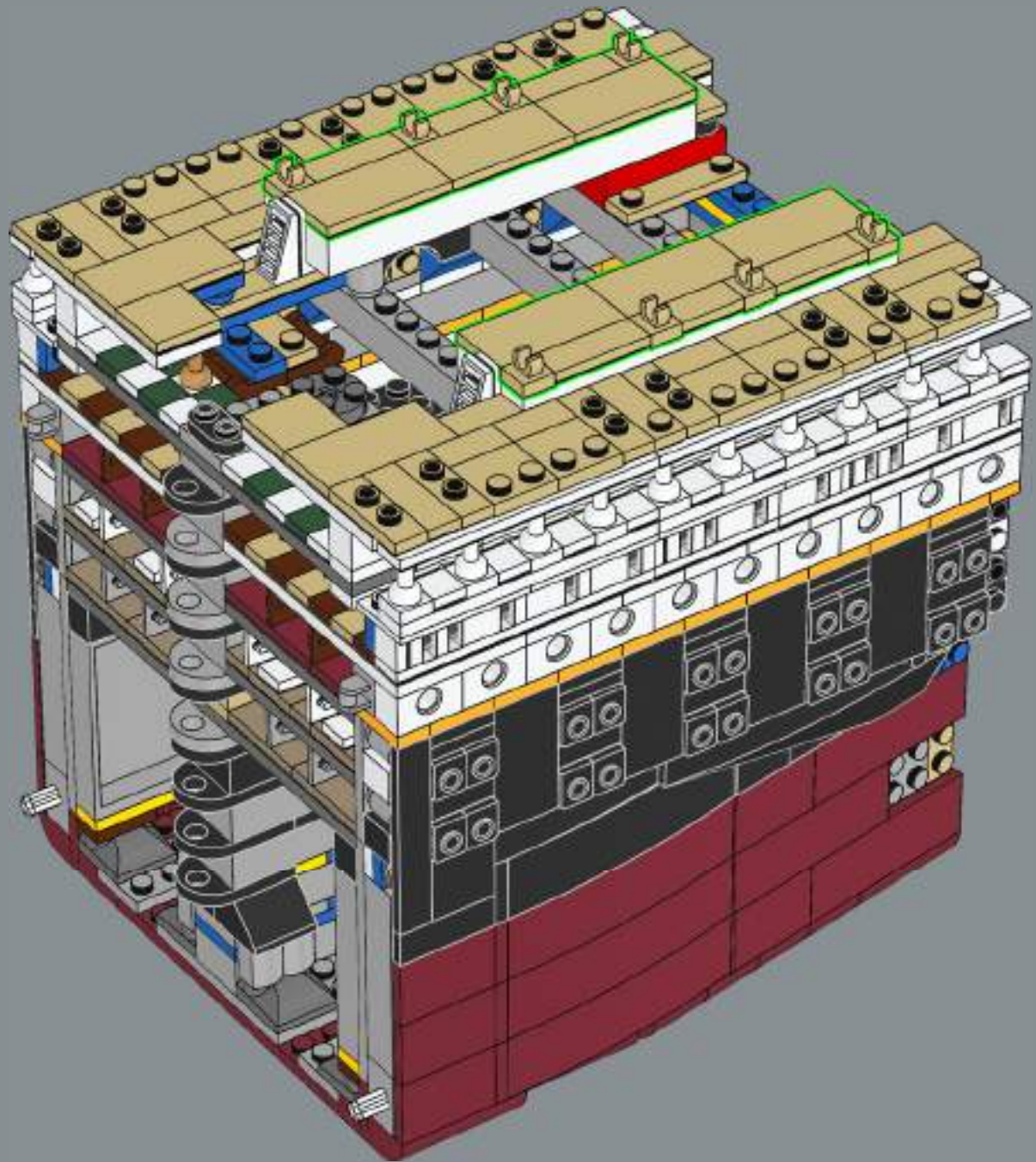

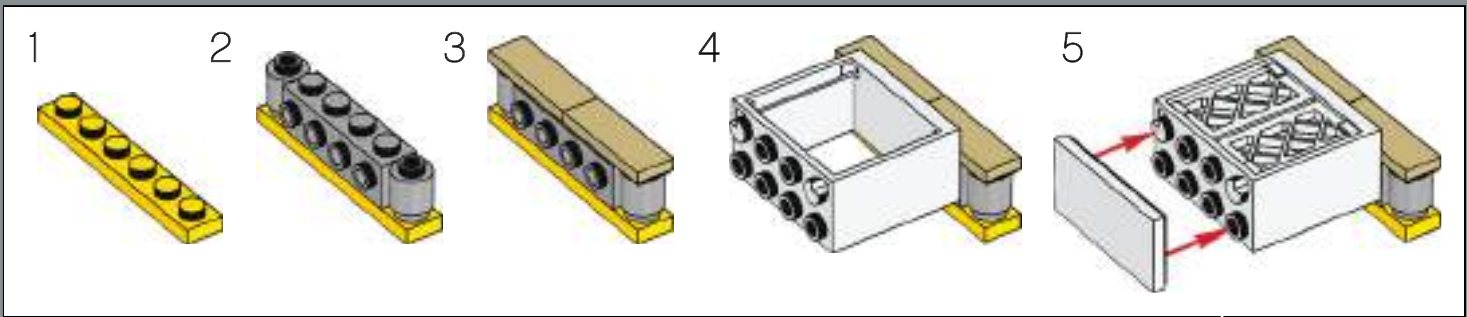
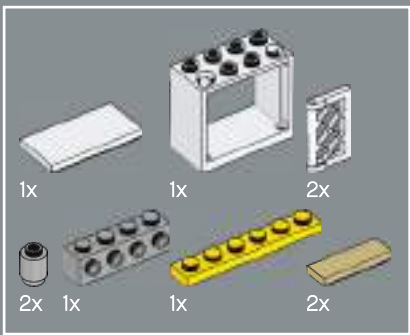

117

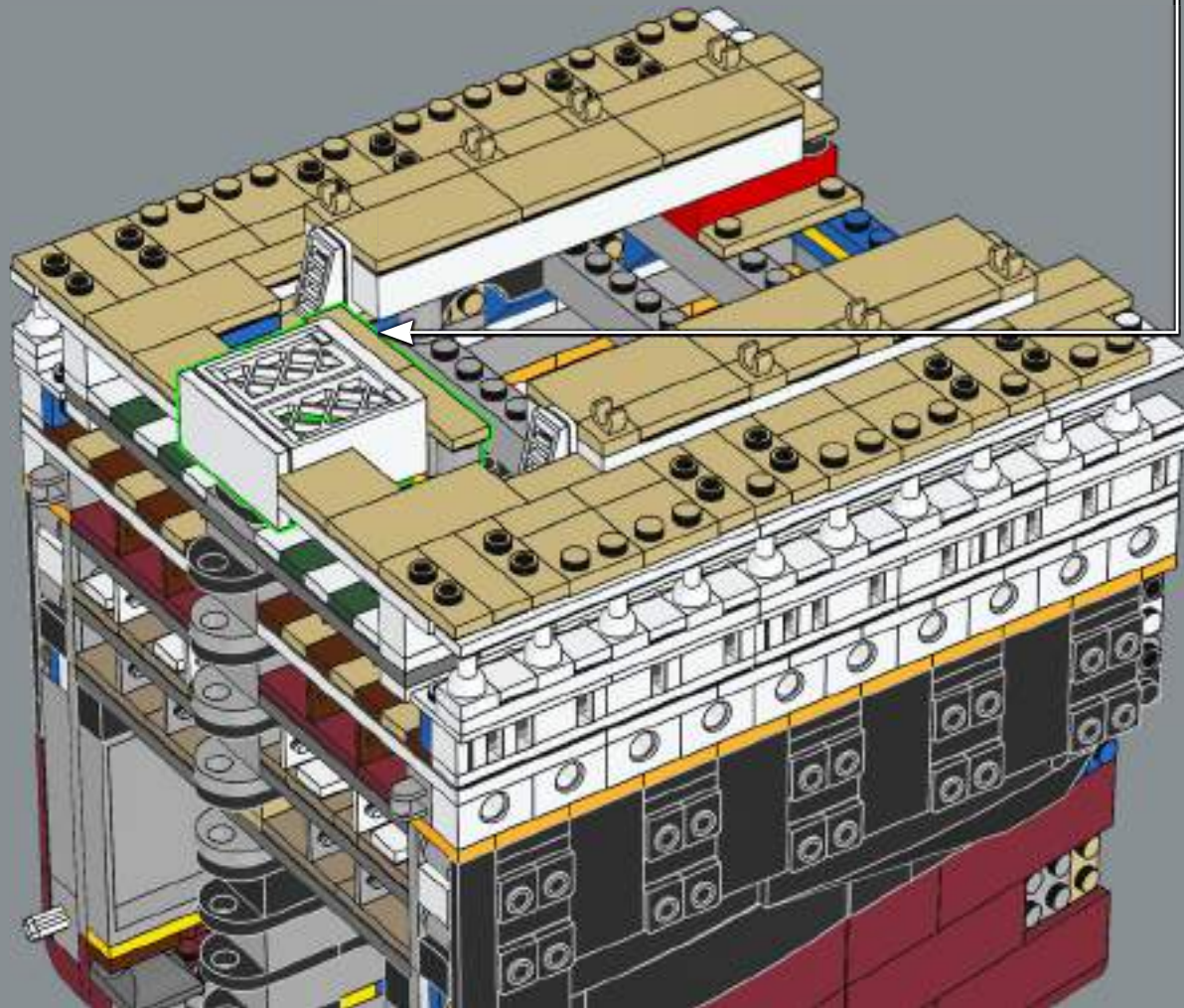



118

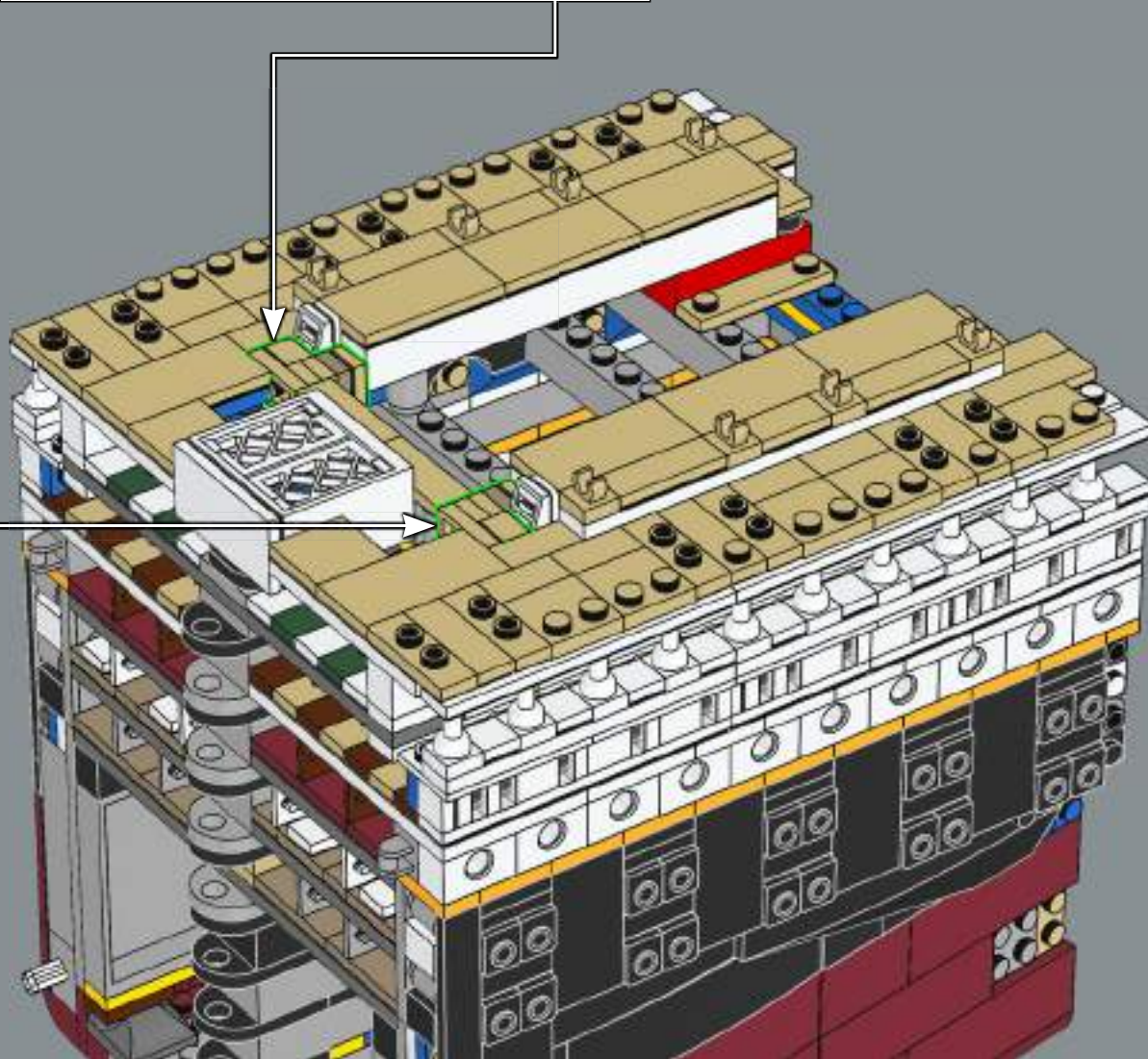
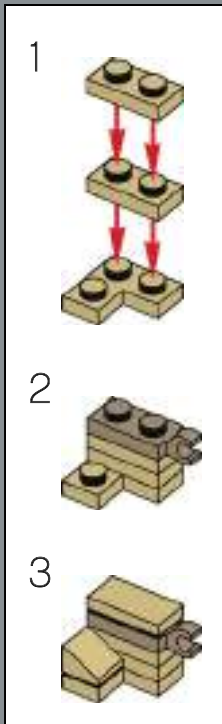
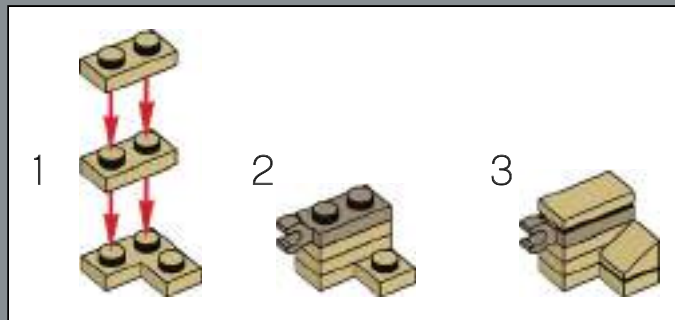



119

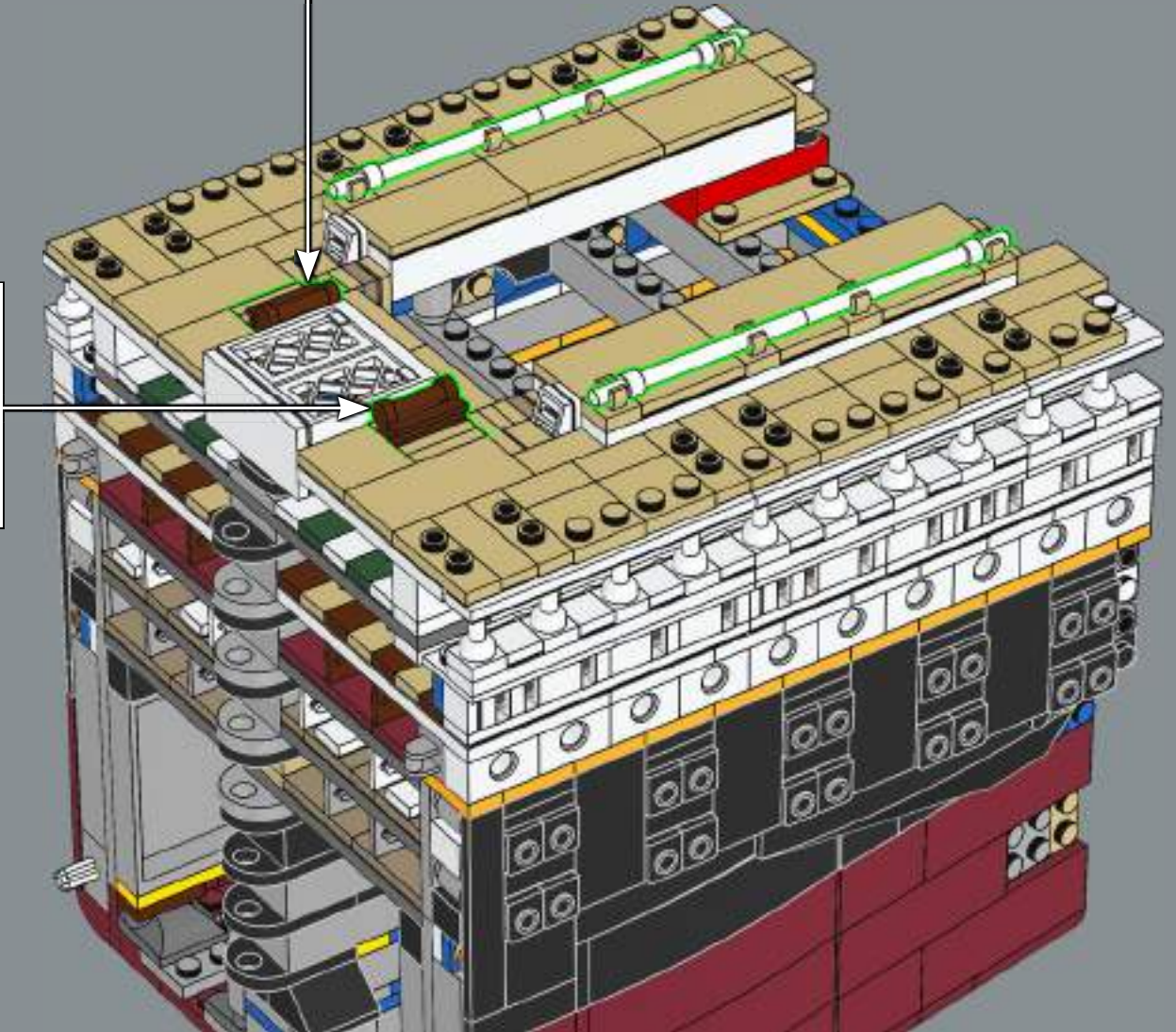
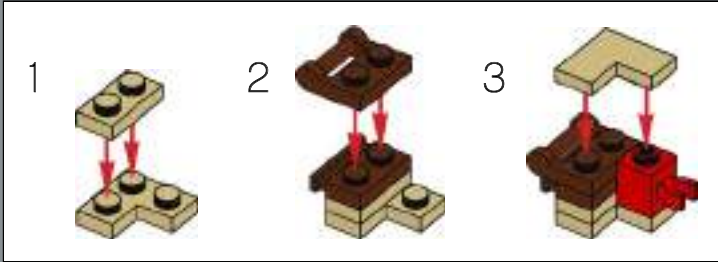
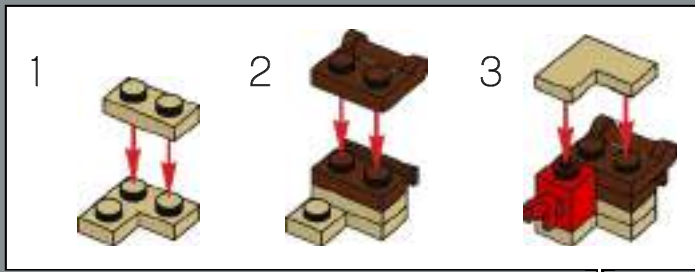

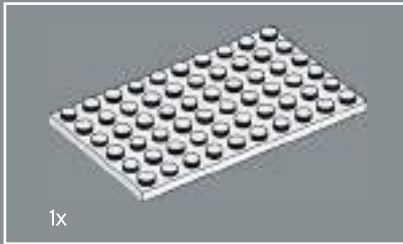
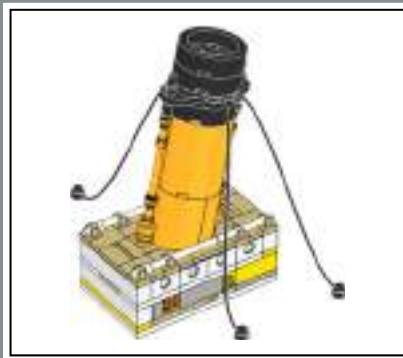
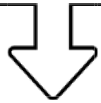

120



121

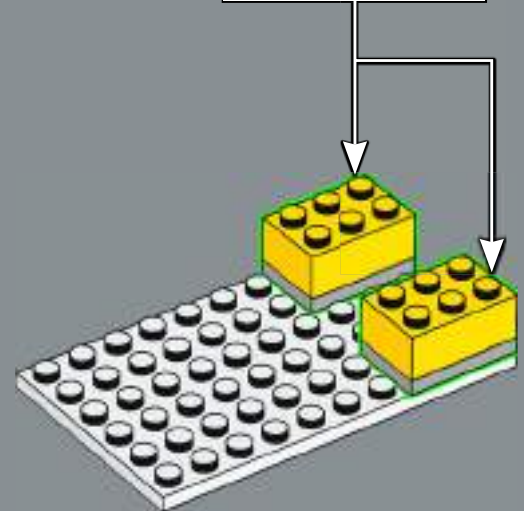
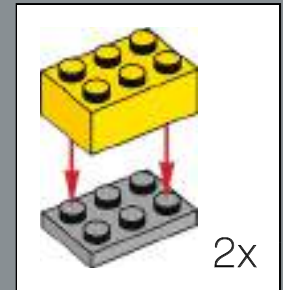

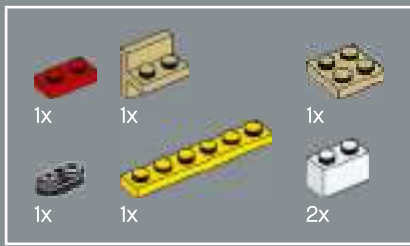

122

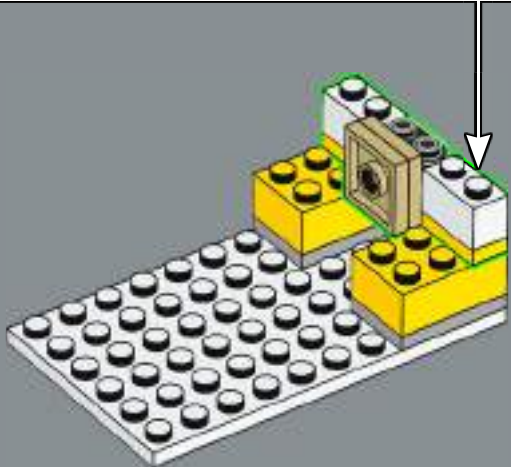
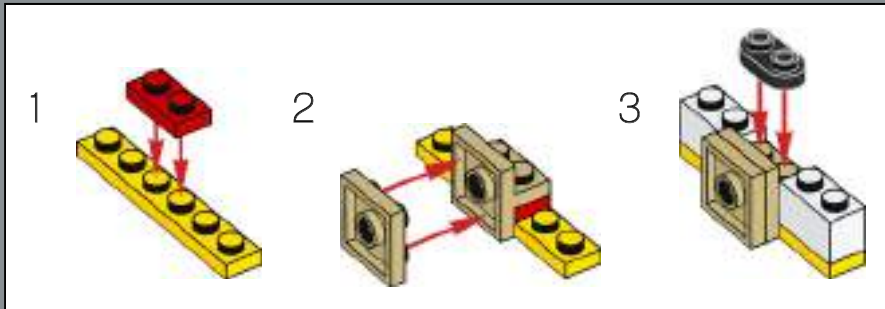

123

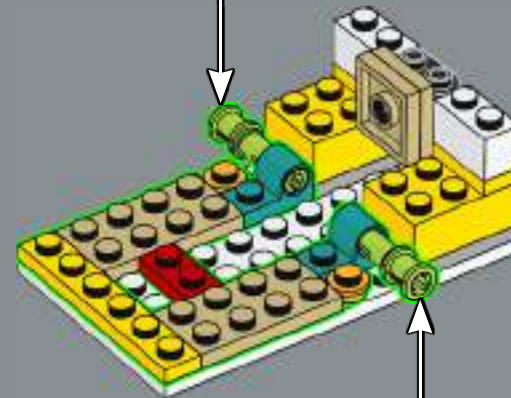

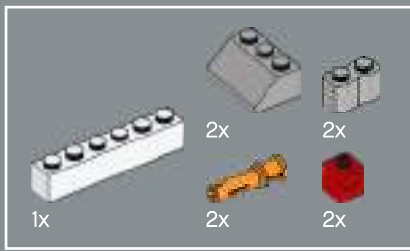

124

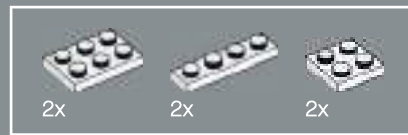
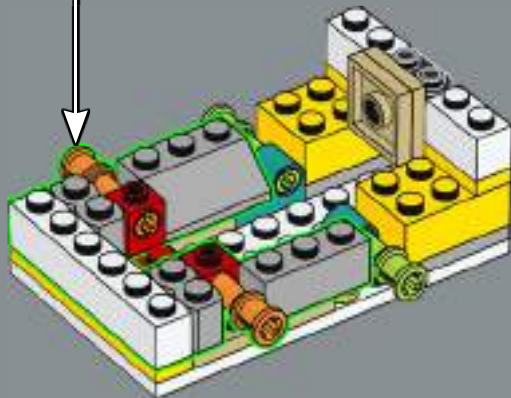

125

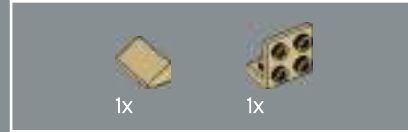
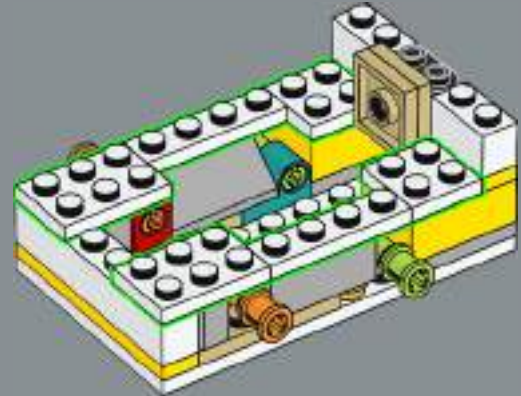

126

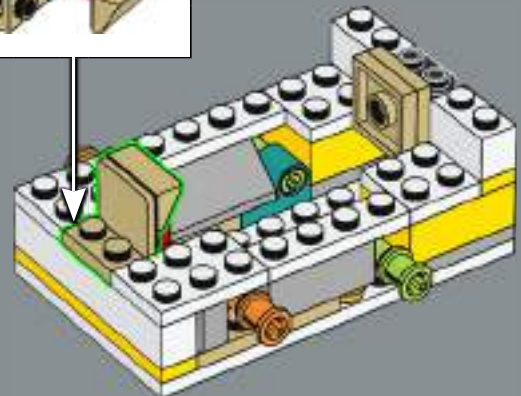
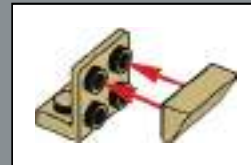

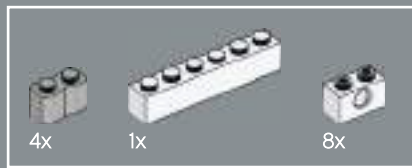

127

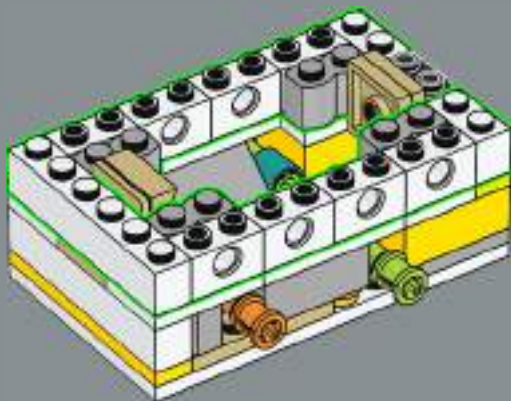

128

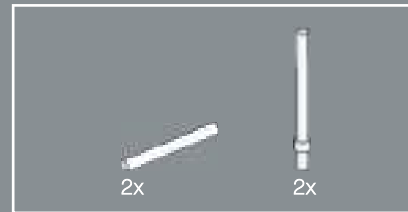
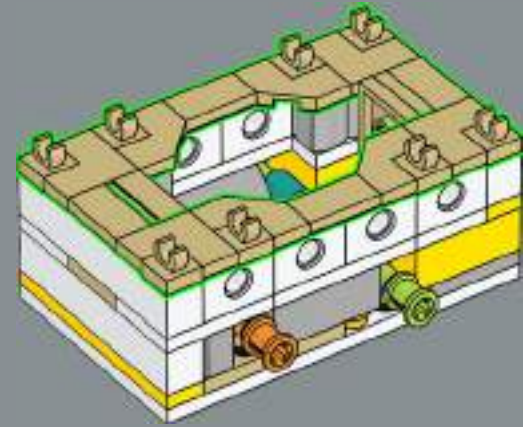

129

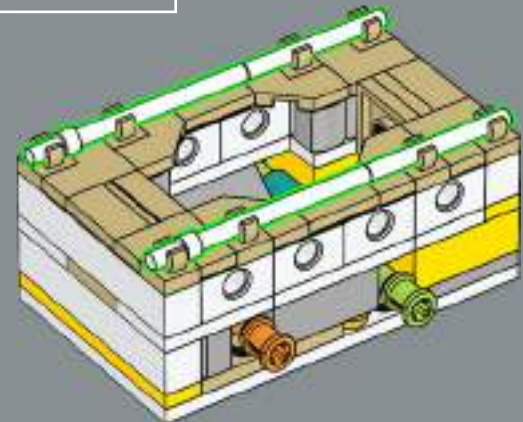

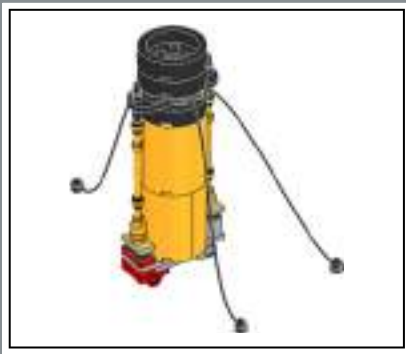

130

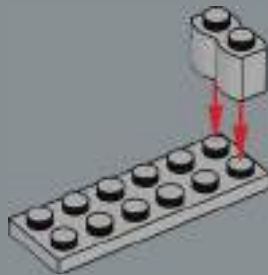

131

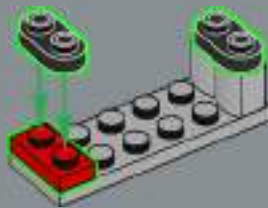

132

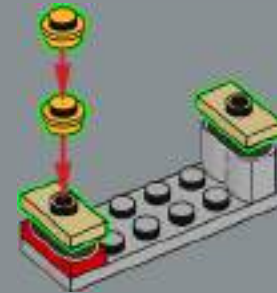

133



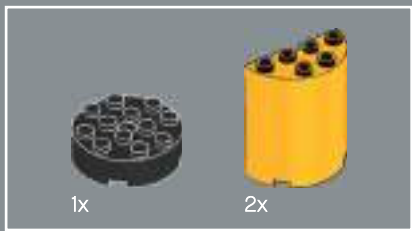

134



135

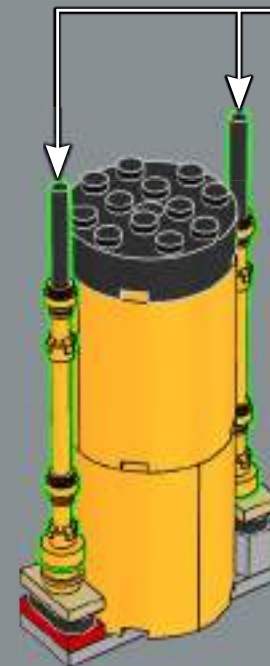
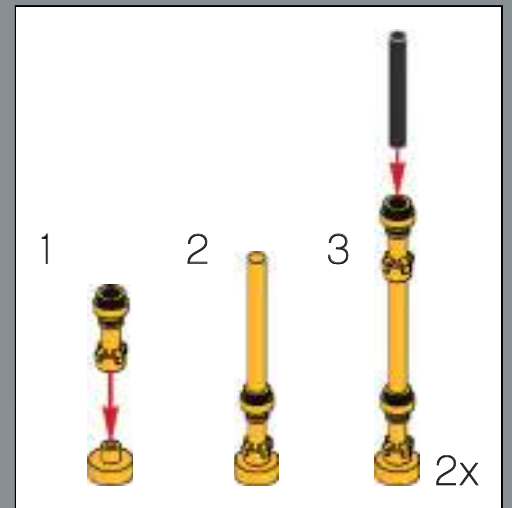



136

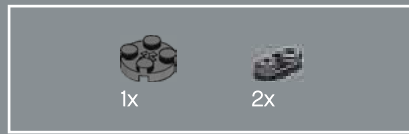
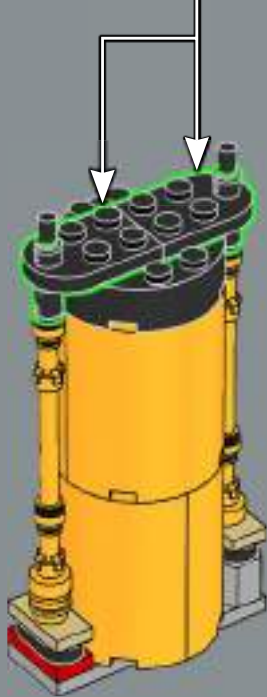

137

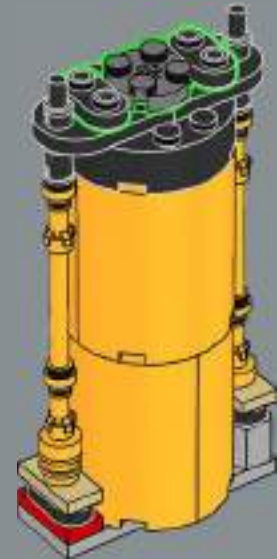



138

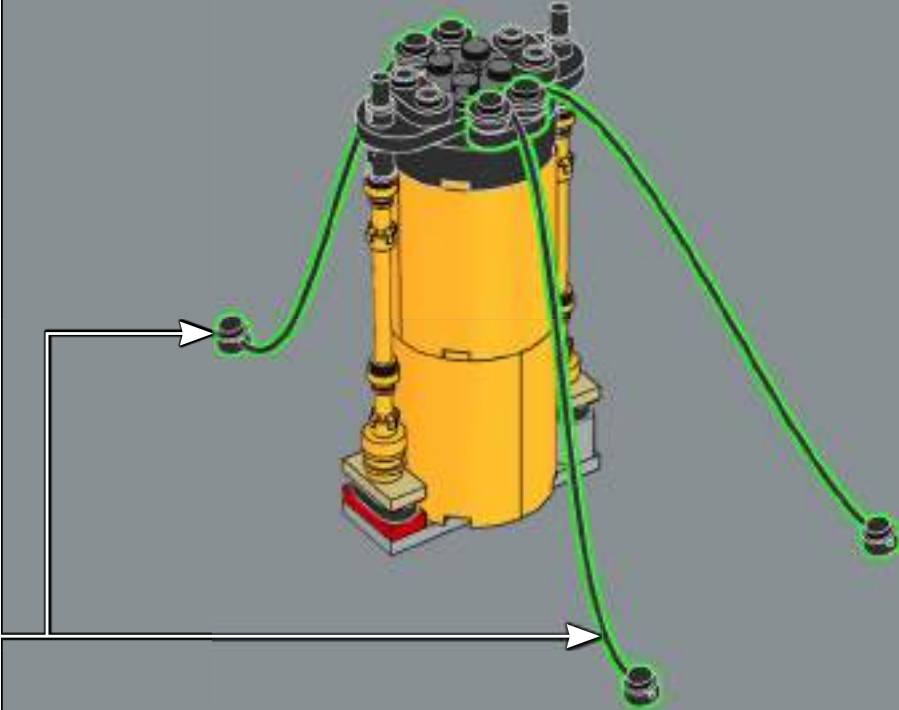
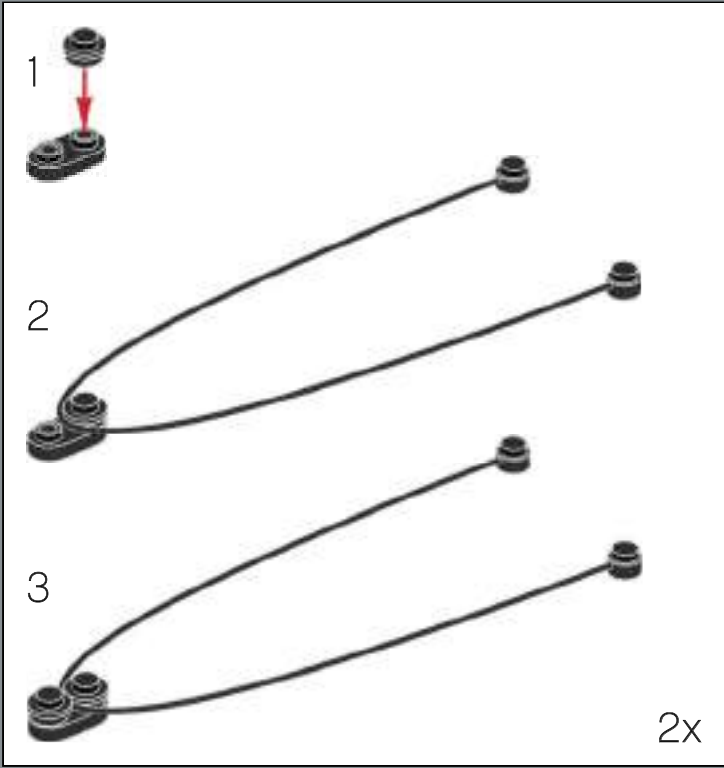

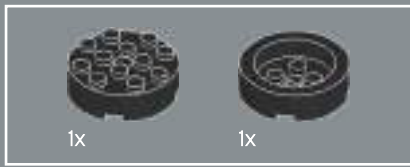

139

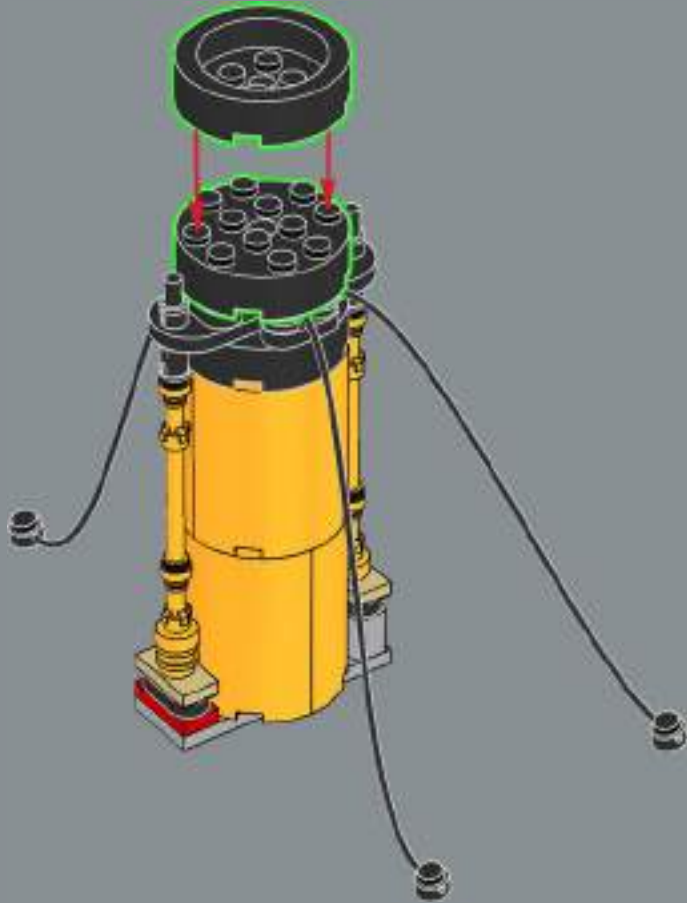

140

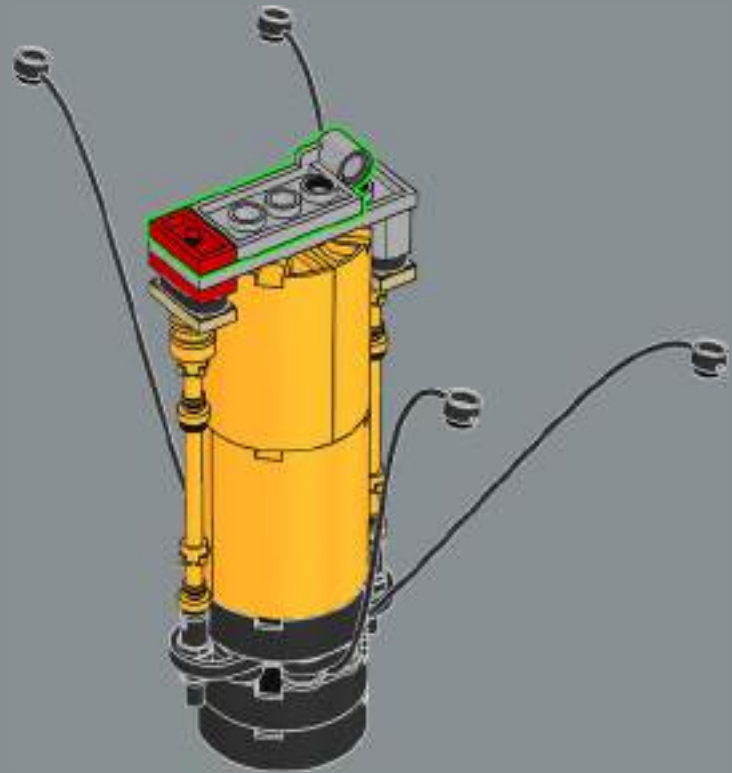



141

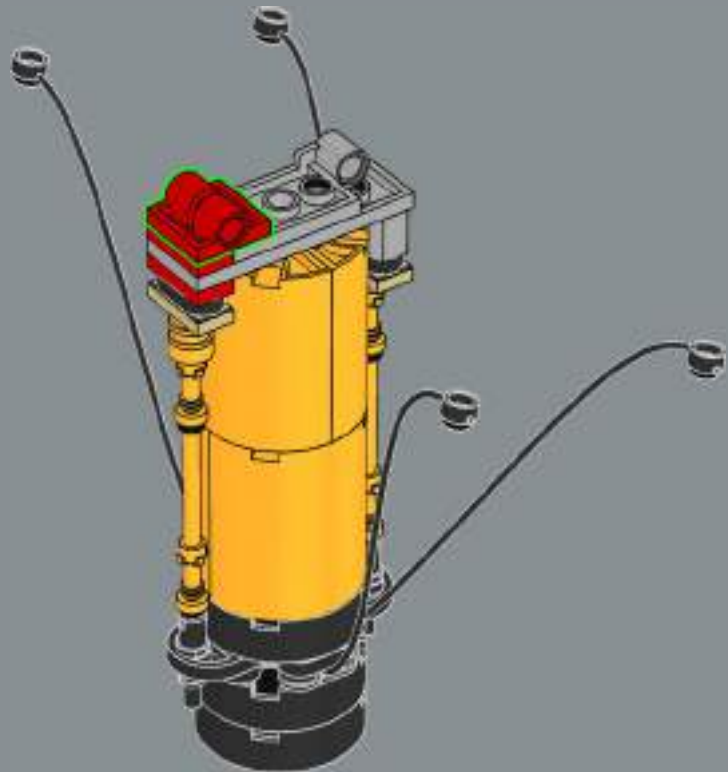

142

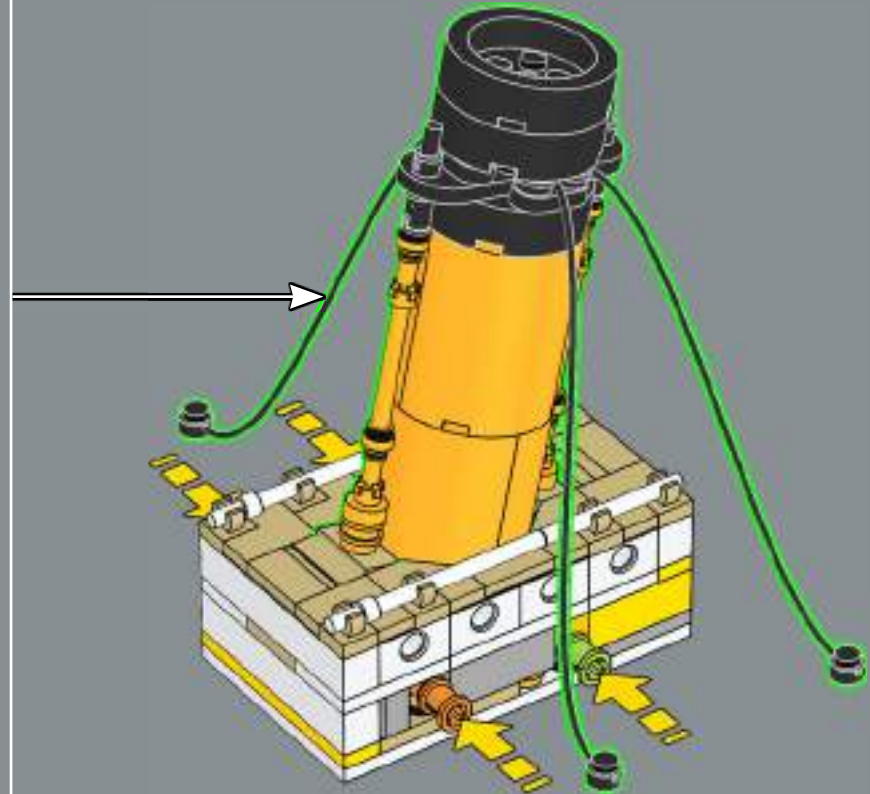

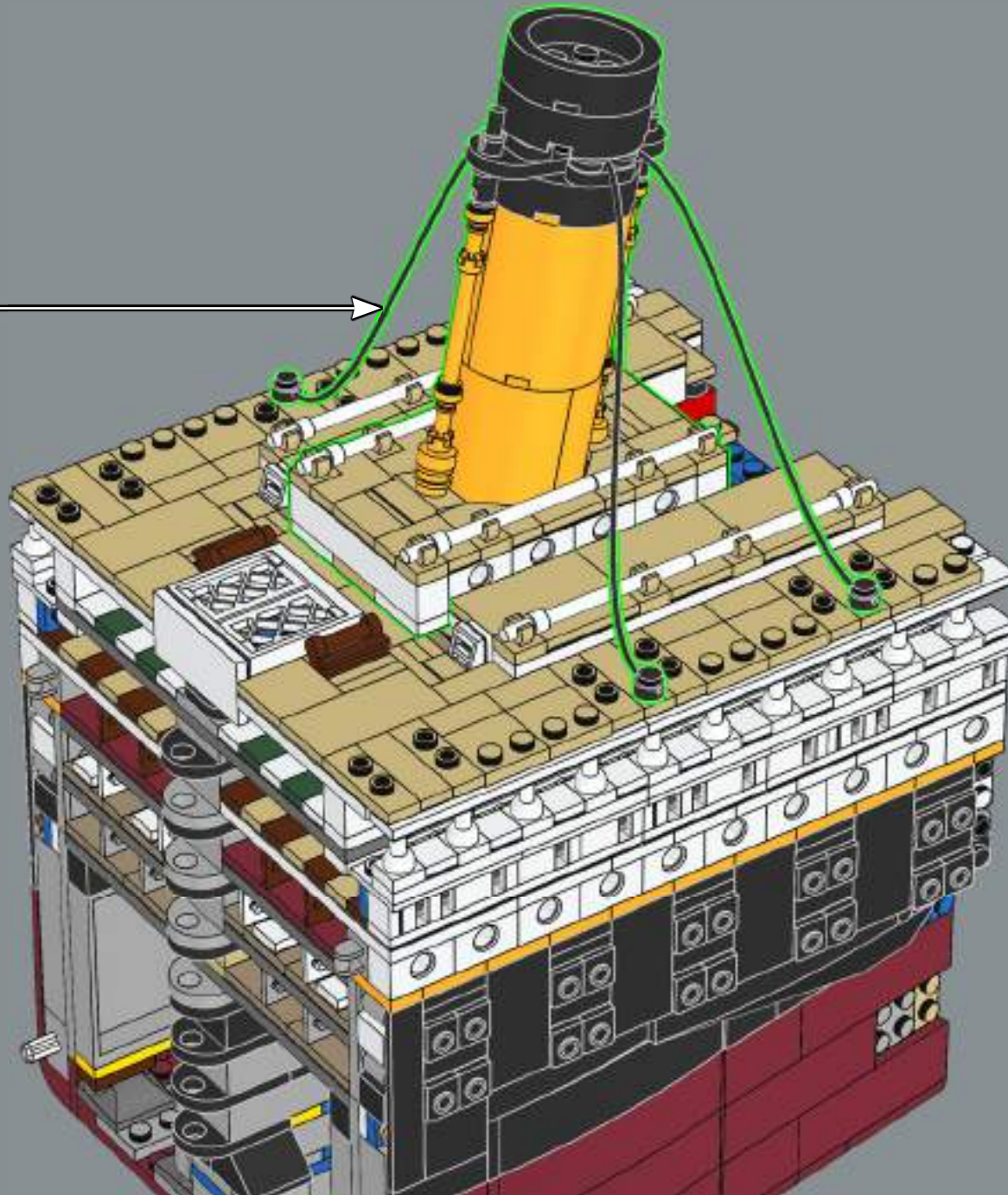

The *Titanic* had four funnels, though only three were functional—the last one was a dummy, installed for aesthetic purposes.



144

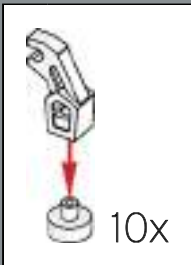
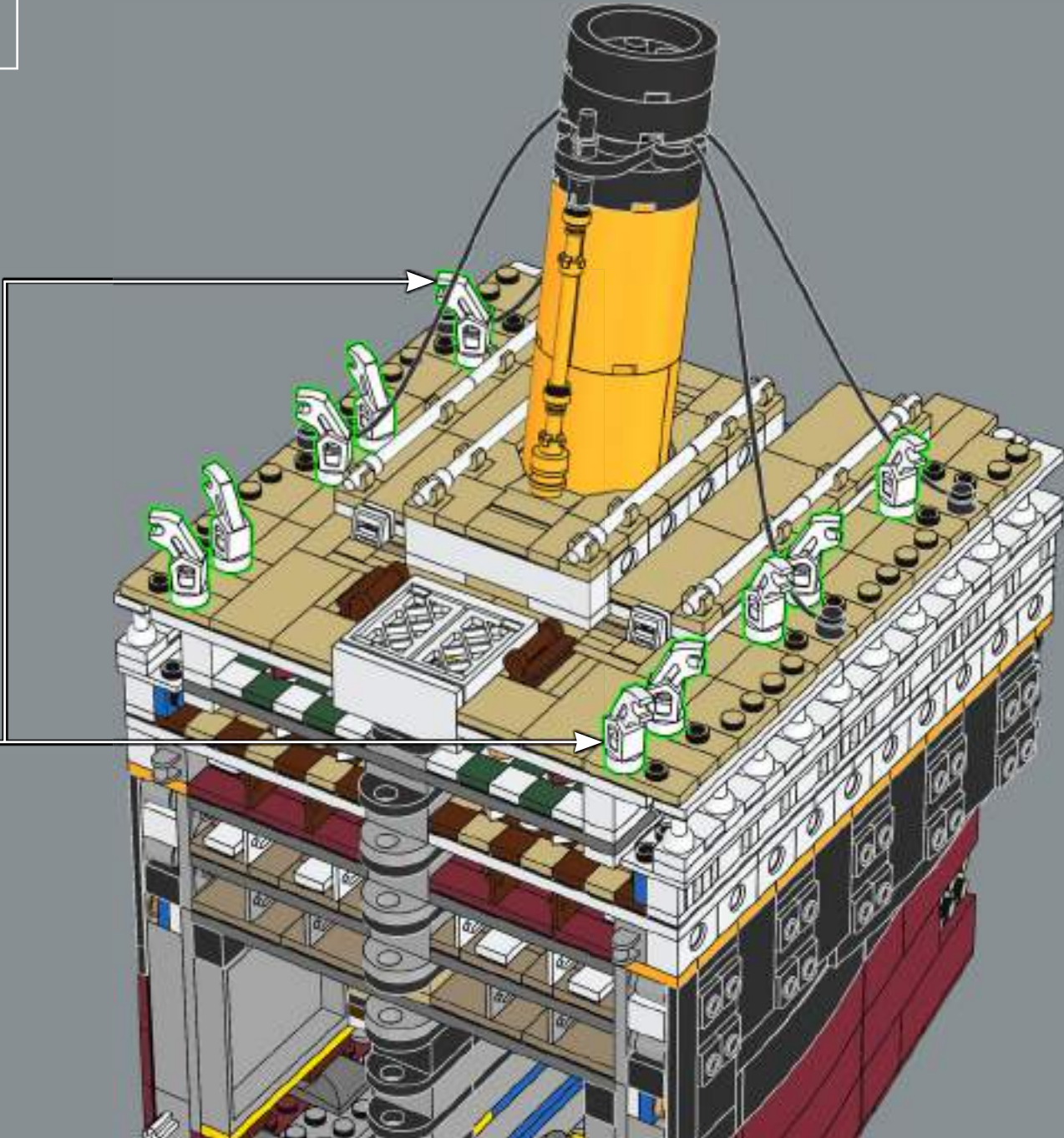

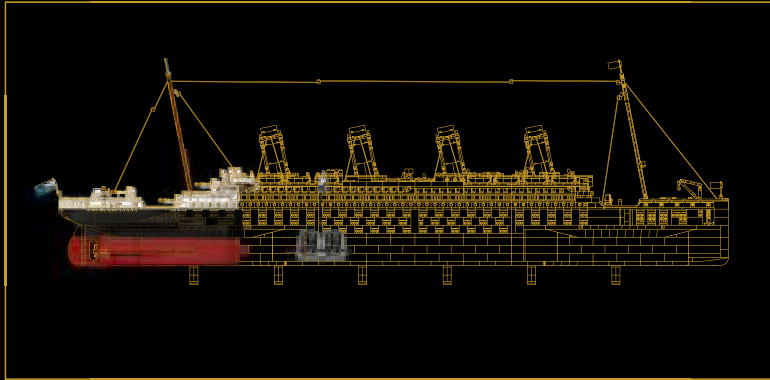

SECTION 6:

STERN & WELL DECK

This final section is the most complicated section of the hull and includes the rudder and three main driveshafts that connect the propellers to the engines. You will build the two main piston engines that are linked directly to the port and starboard screws. Turning the screws moves the engine crankshafts and pistons inside the model.

↓ The exterior details of this section include the stern bridge and benches for the 3rd class passengers.



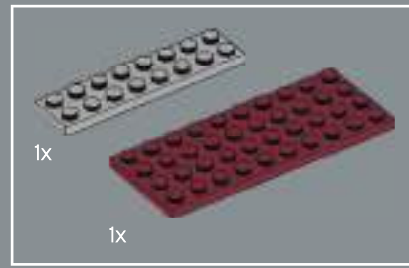
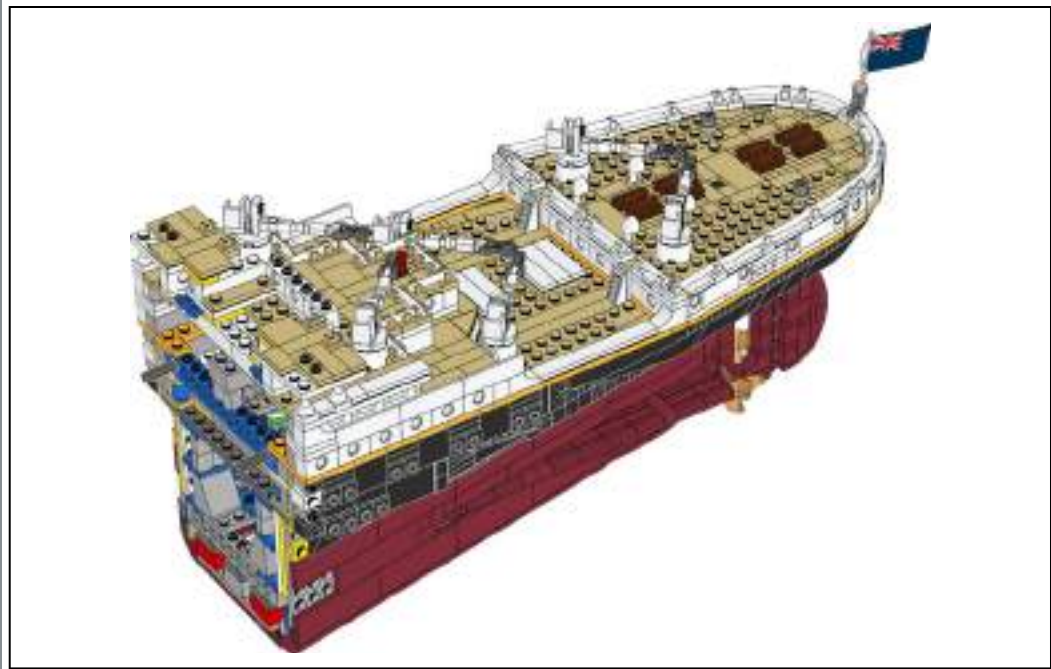
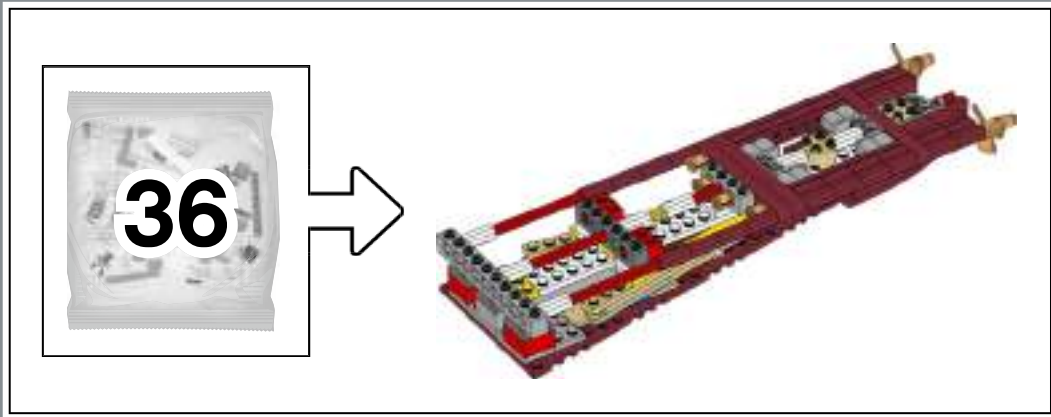

146

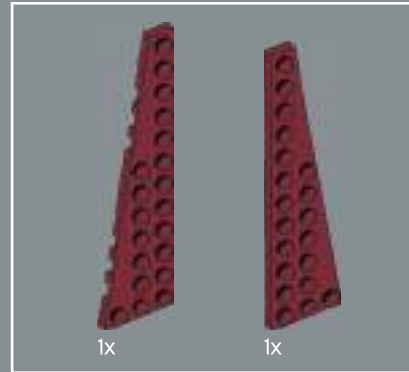
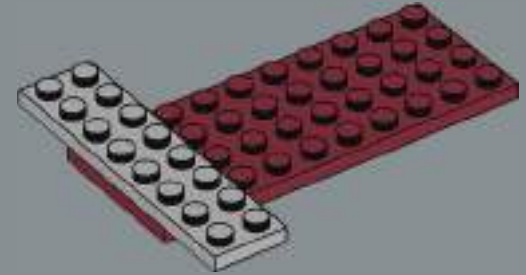

147

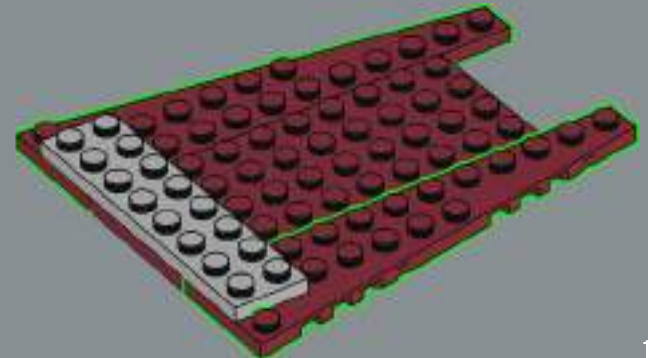

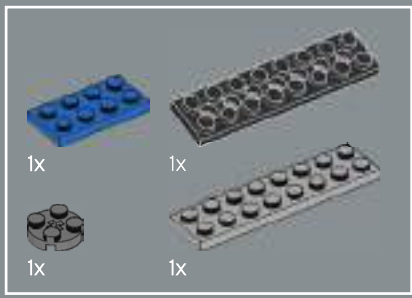

148

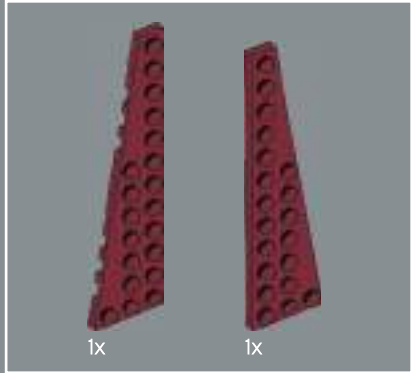
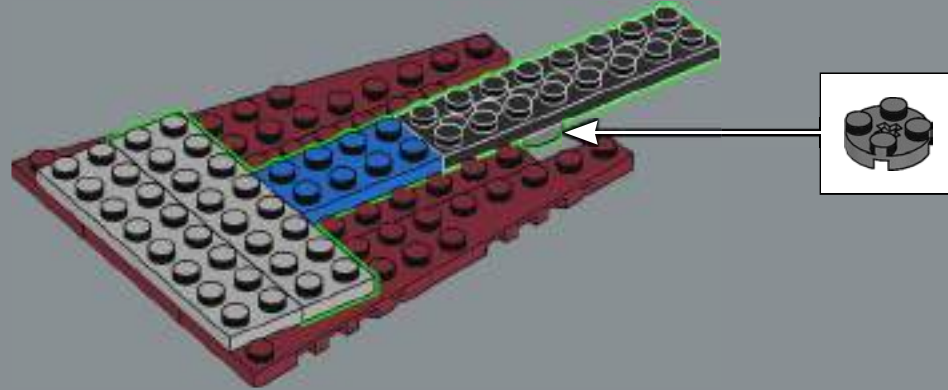

149

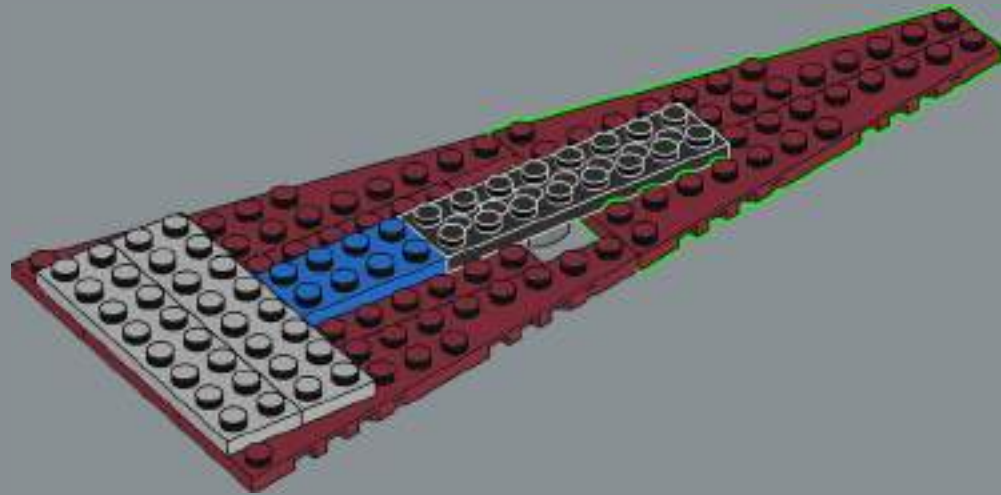

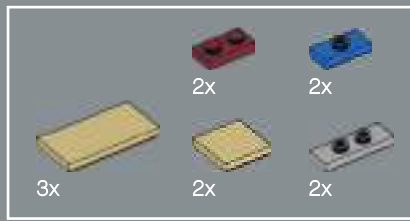

150

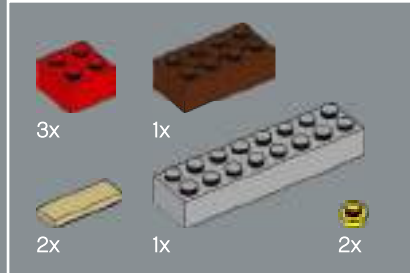
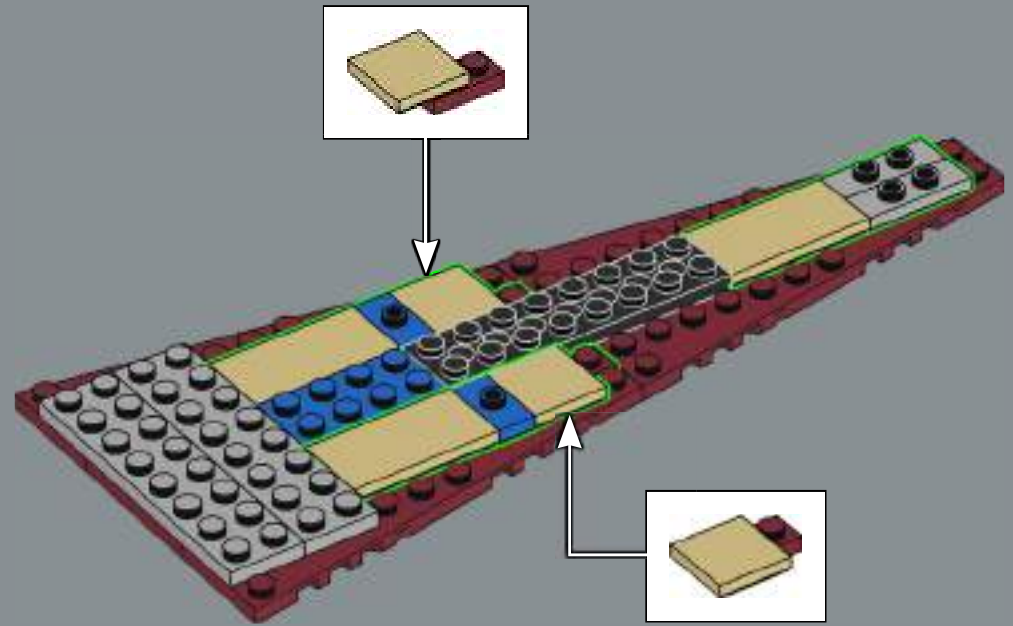

151

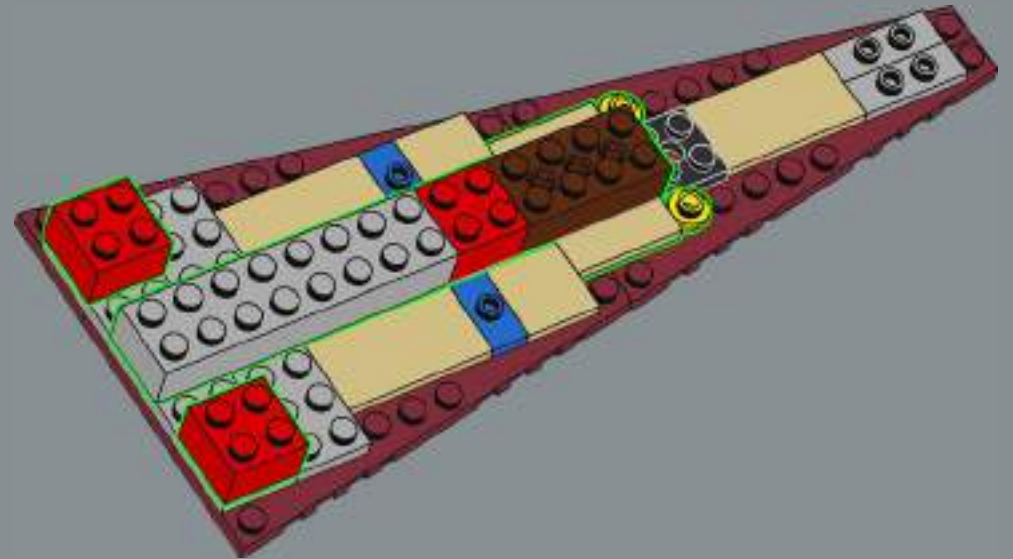

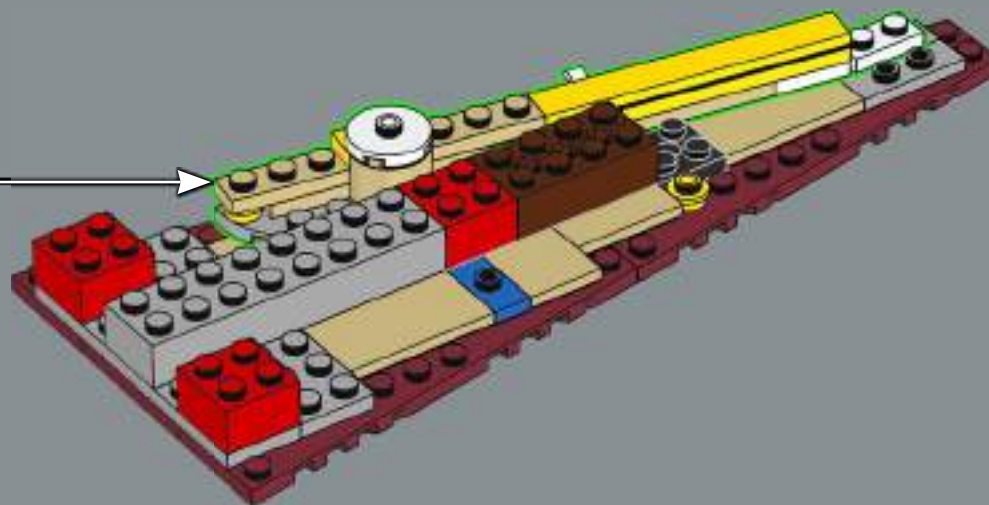

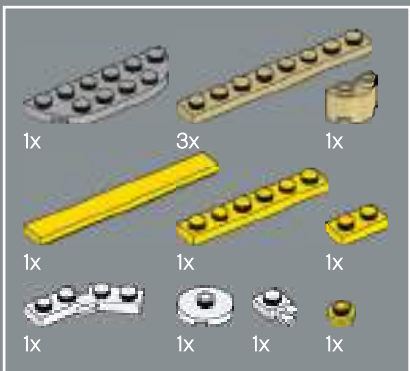

153

1



2

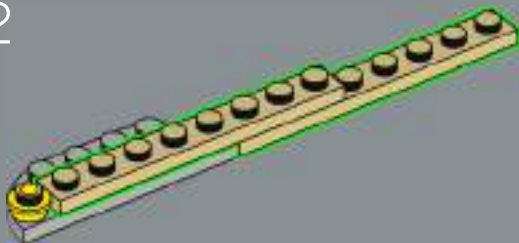

3

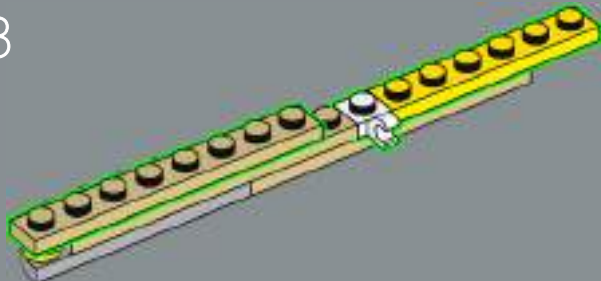

4

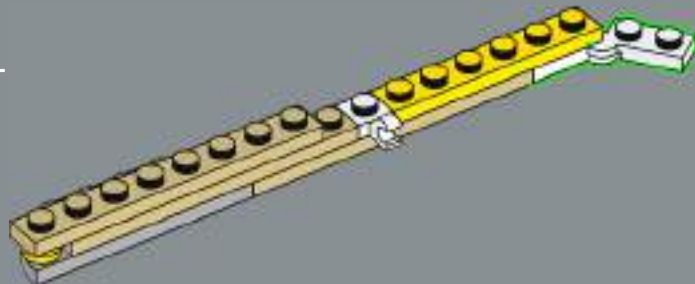

5

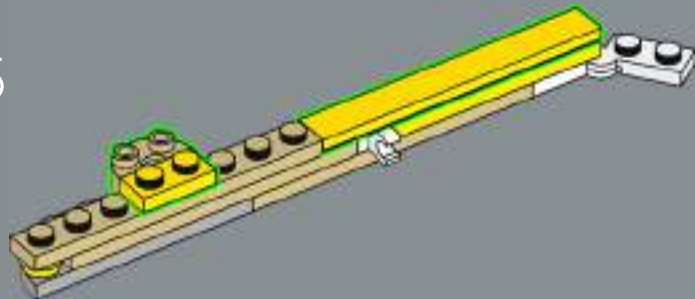

6

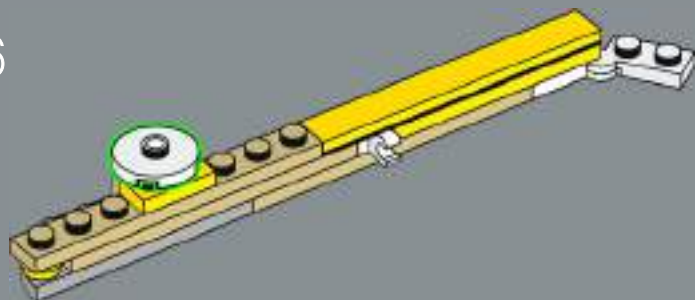

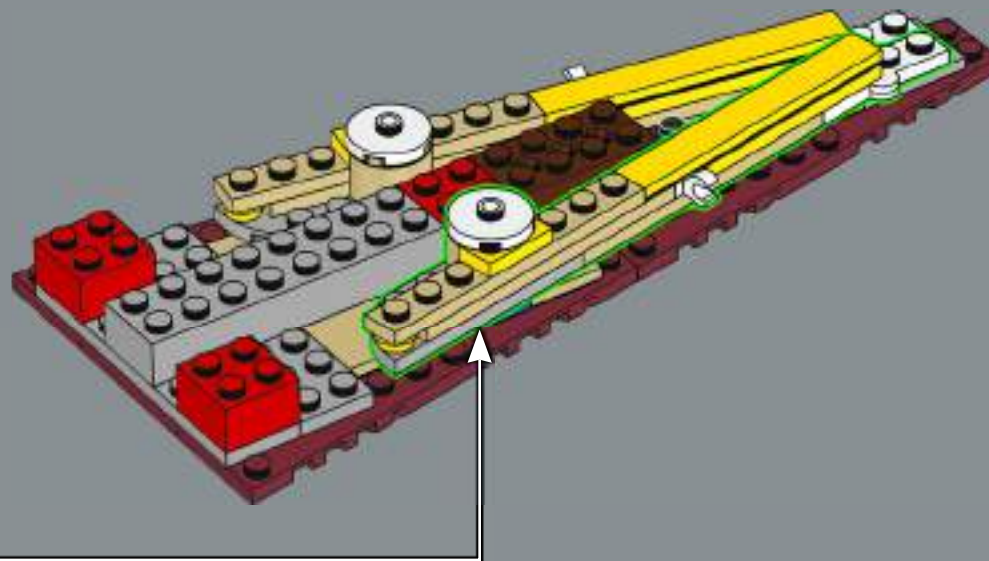

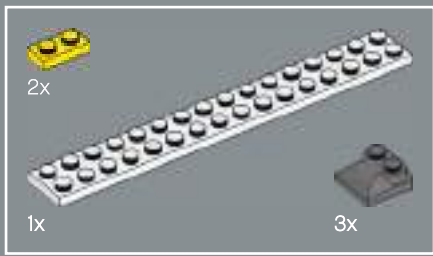

155

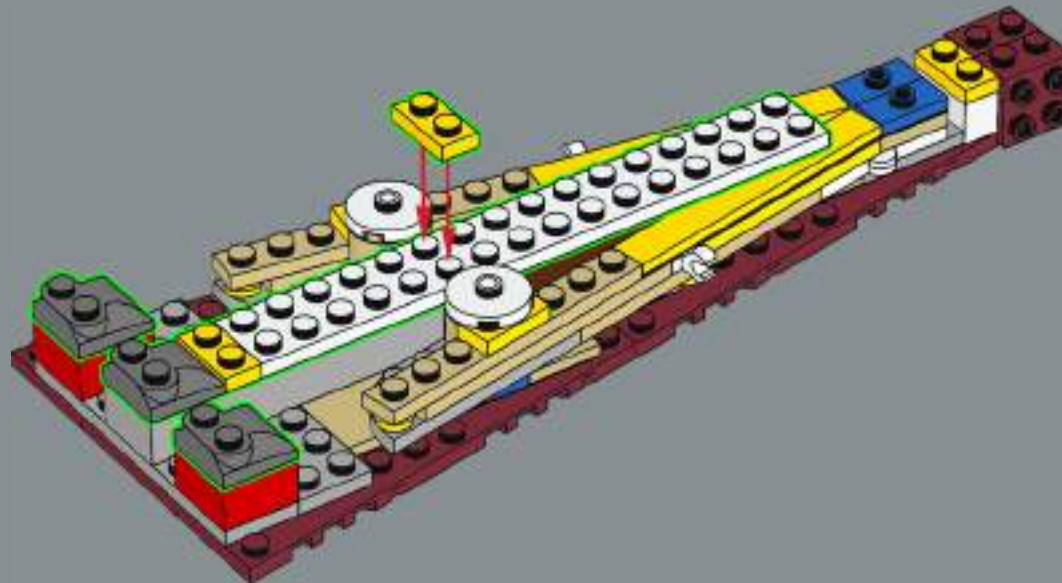

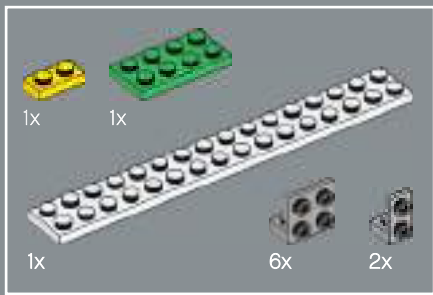

156

1

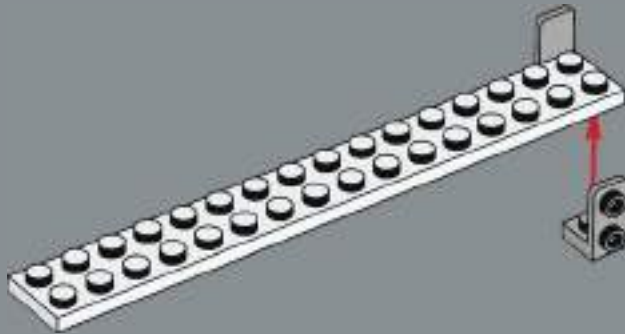

2

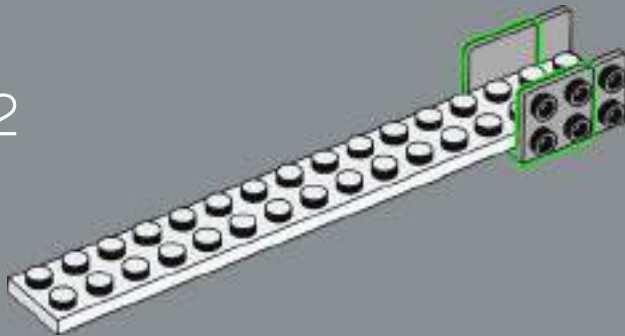

3

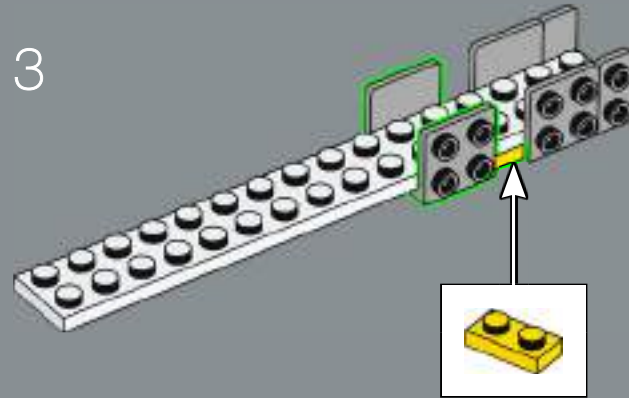

4

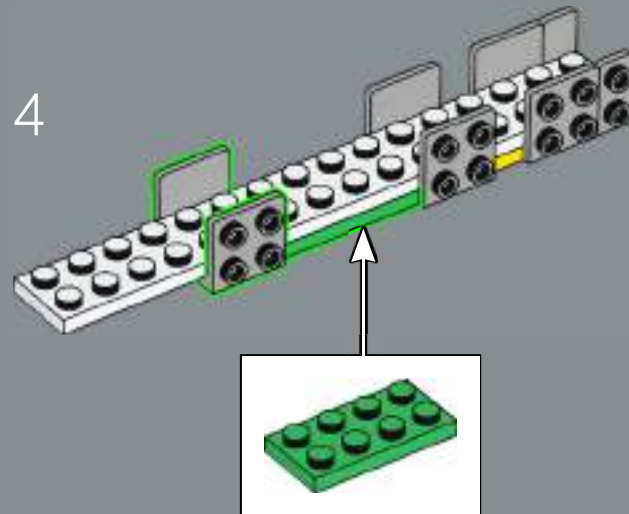

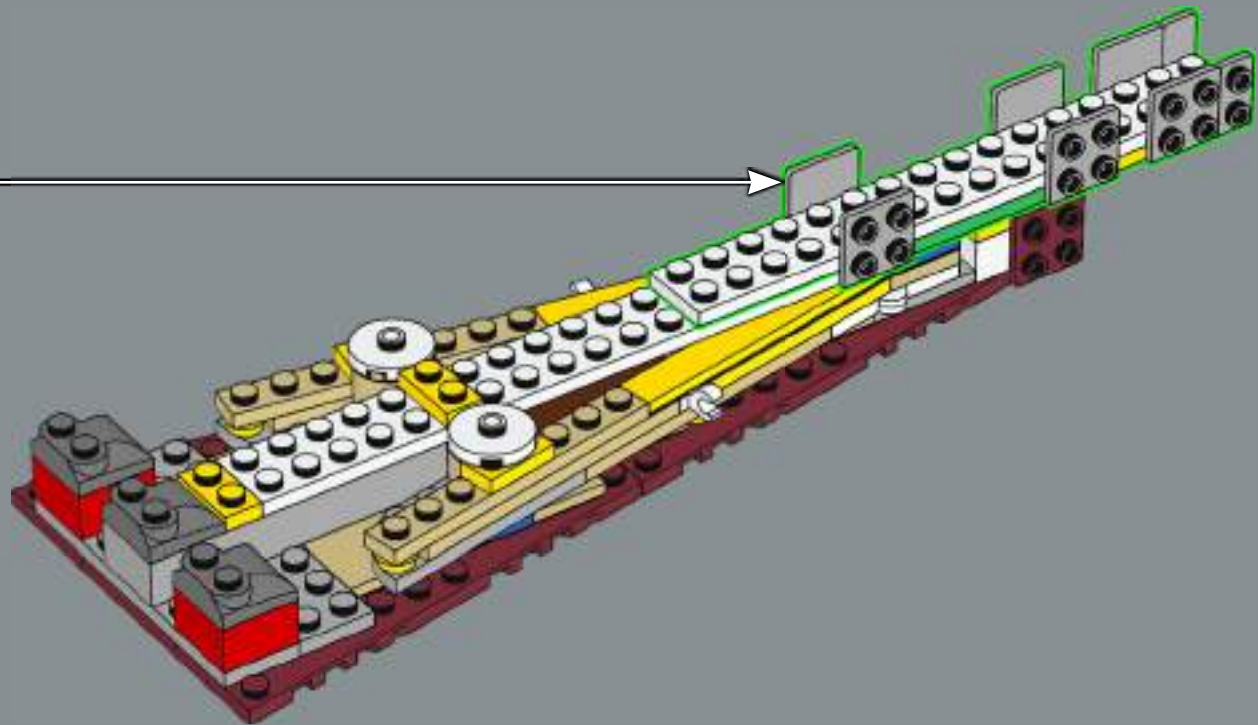



157

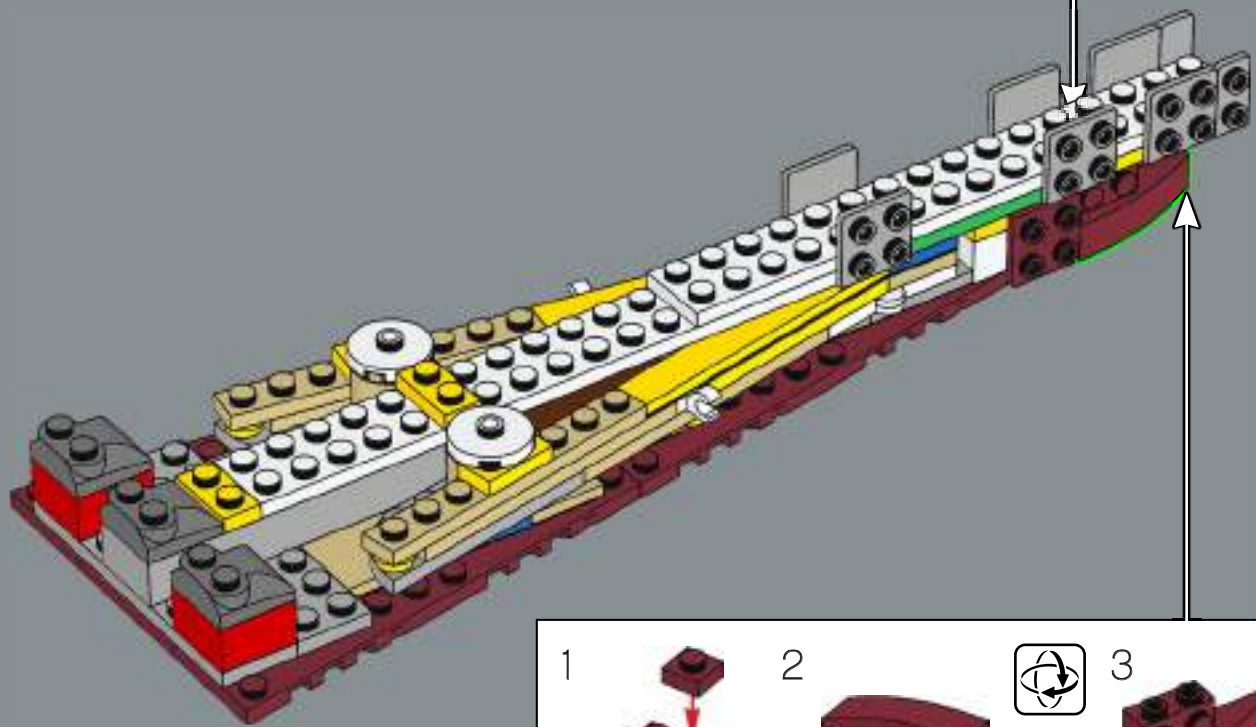
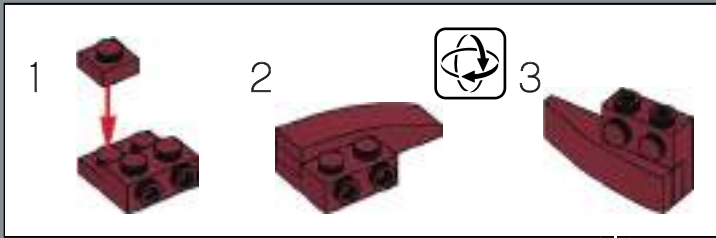

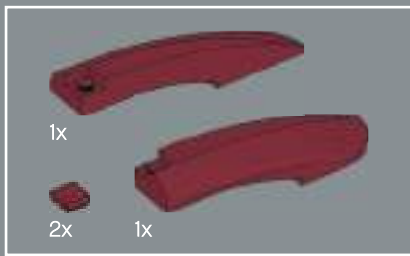

158

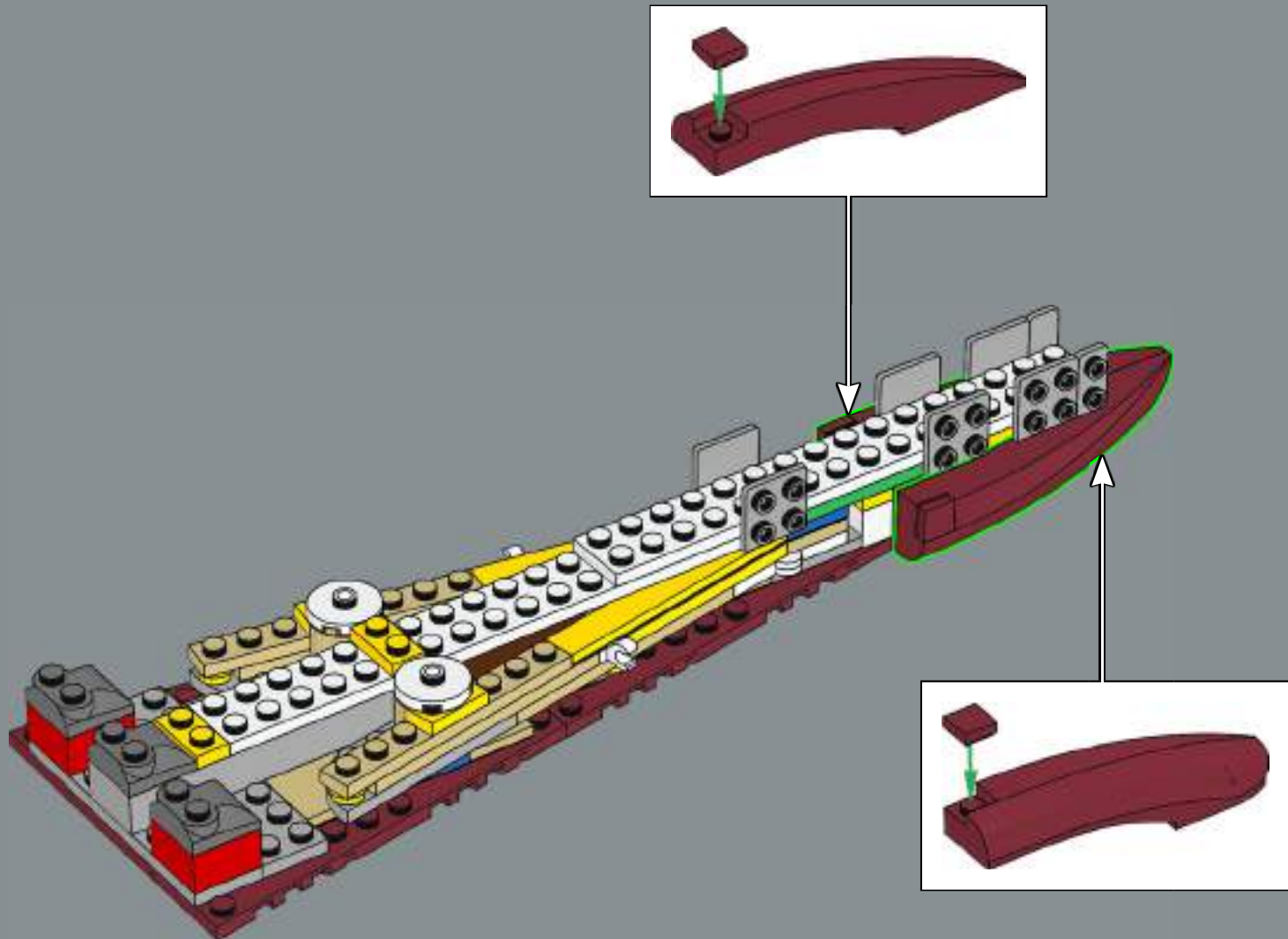

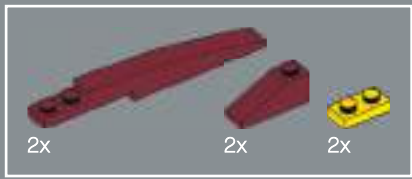

159

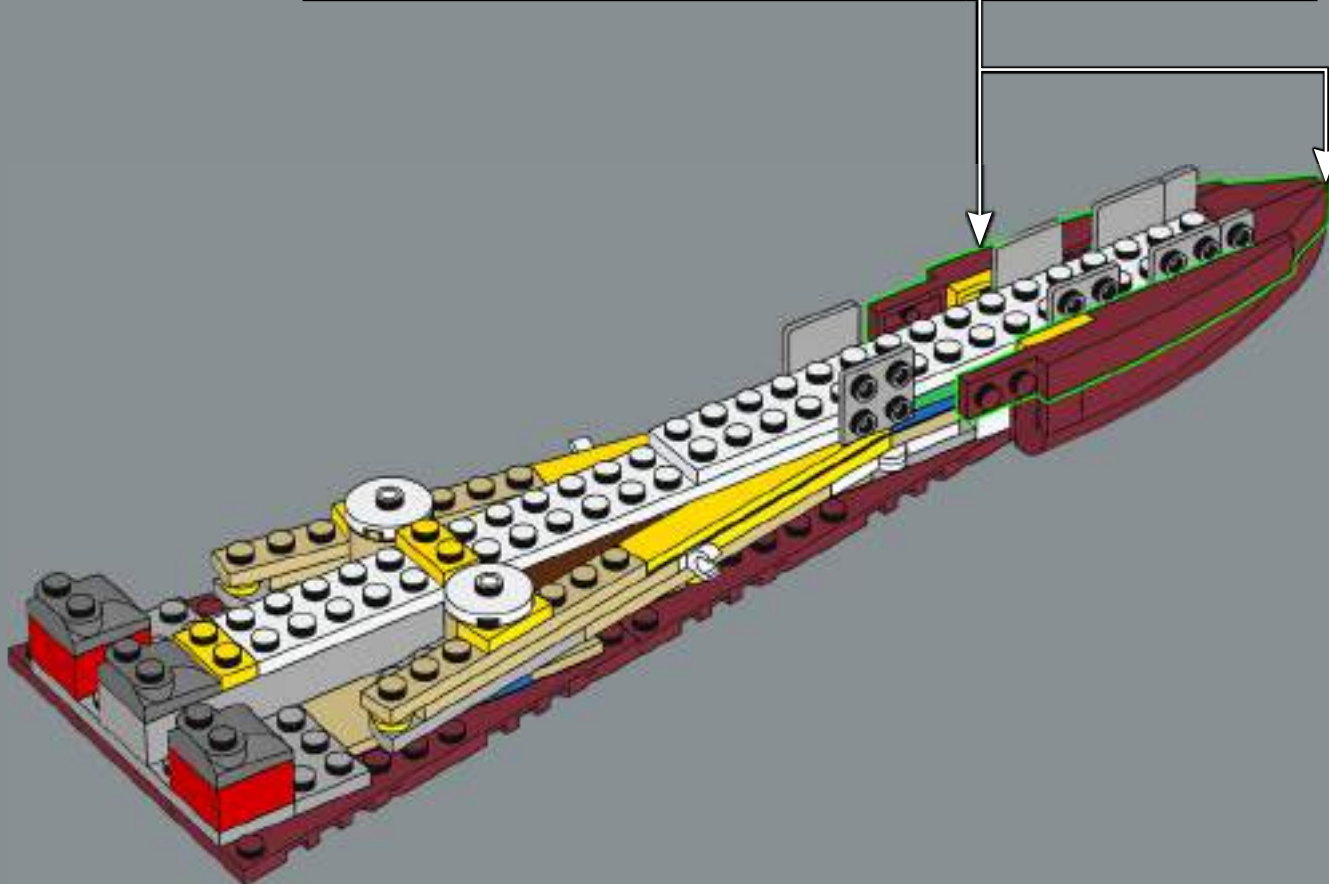
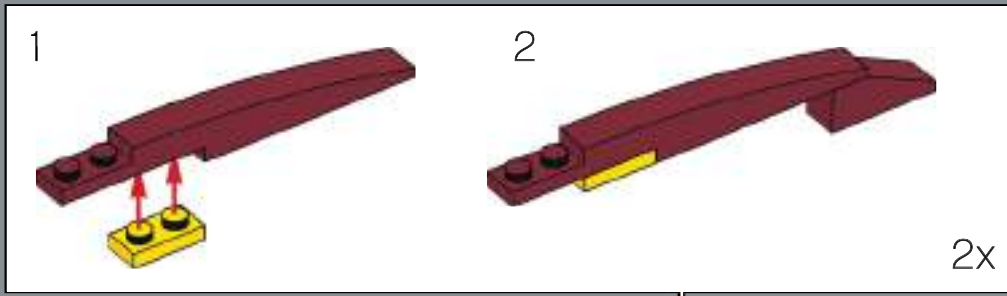

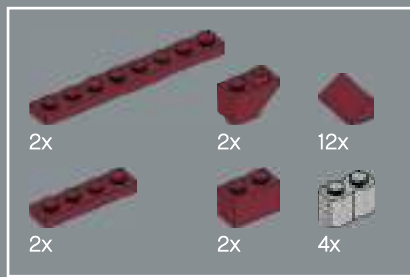

160

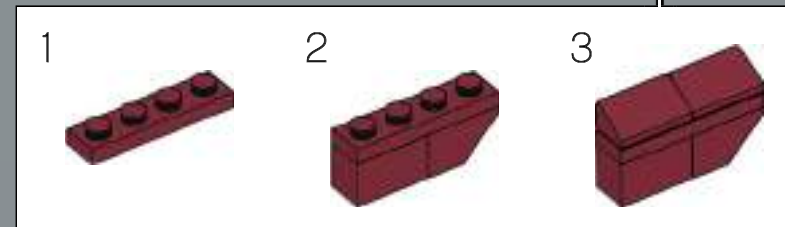
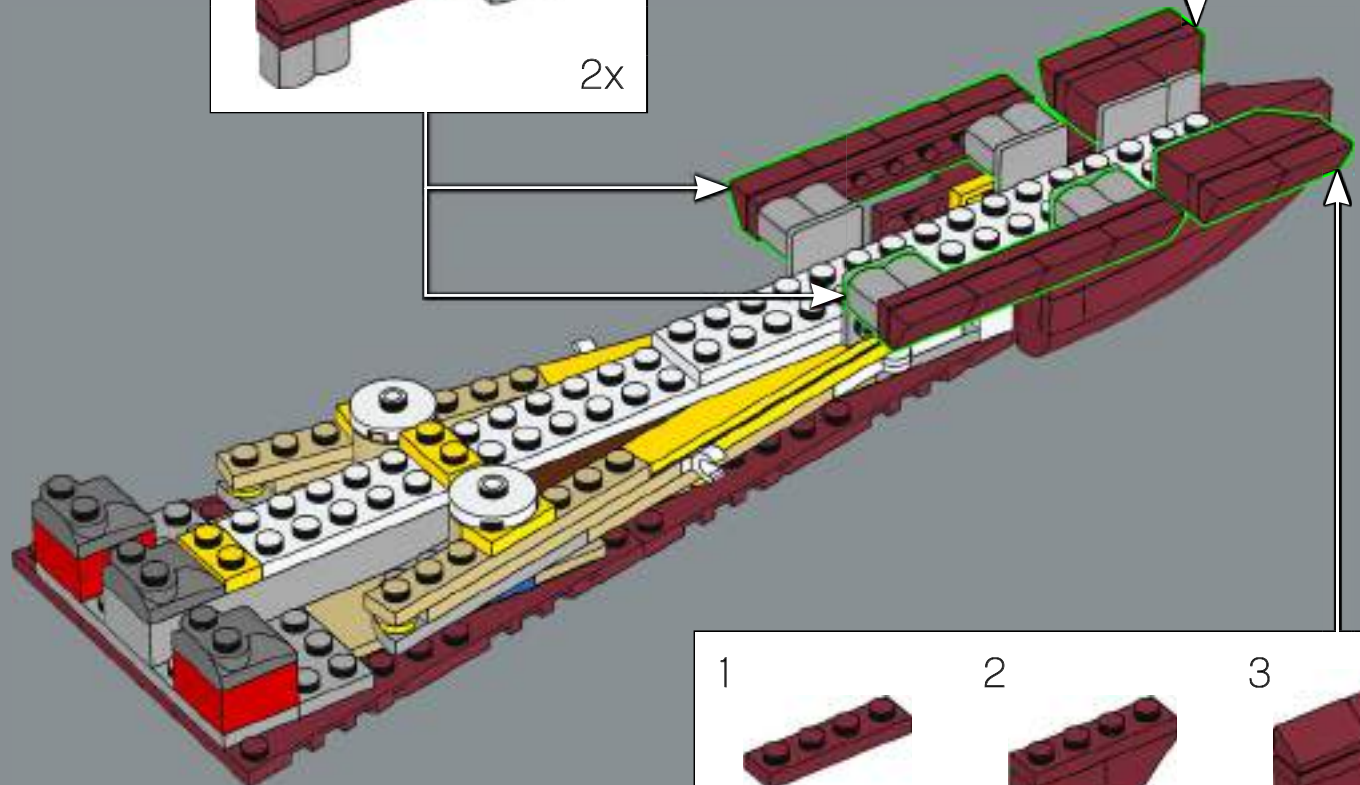
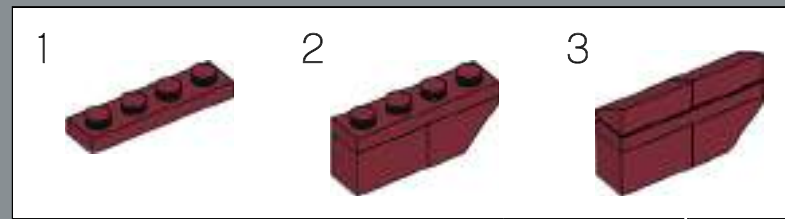
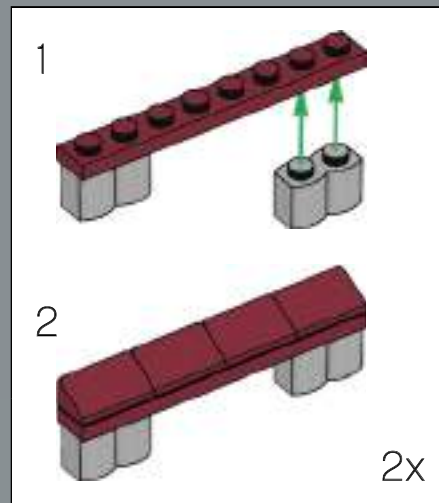



161

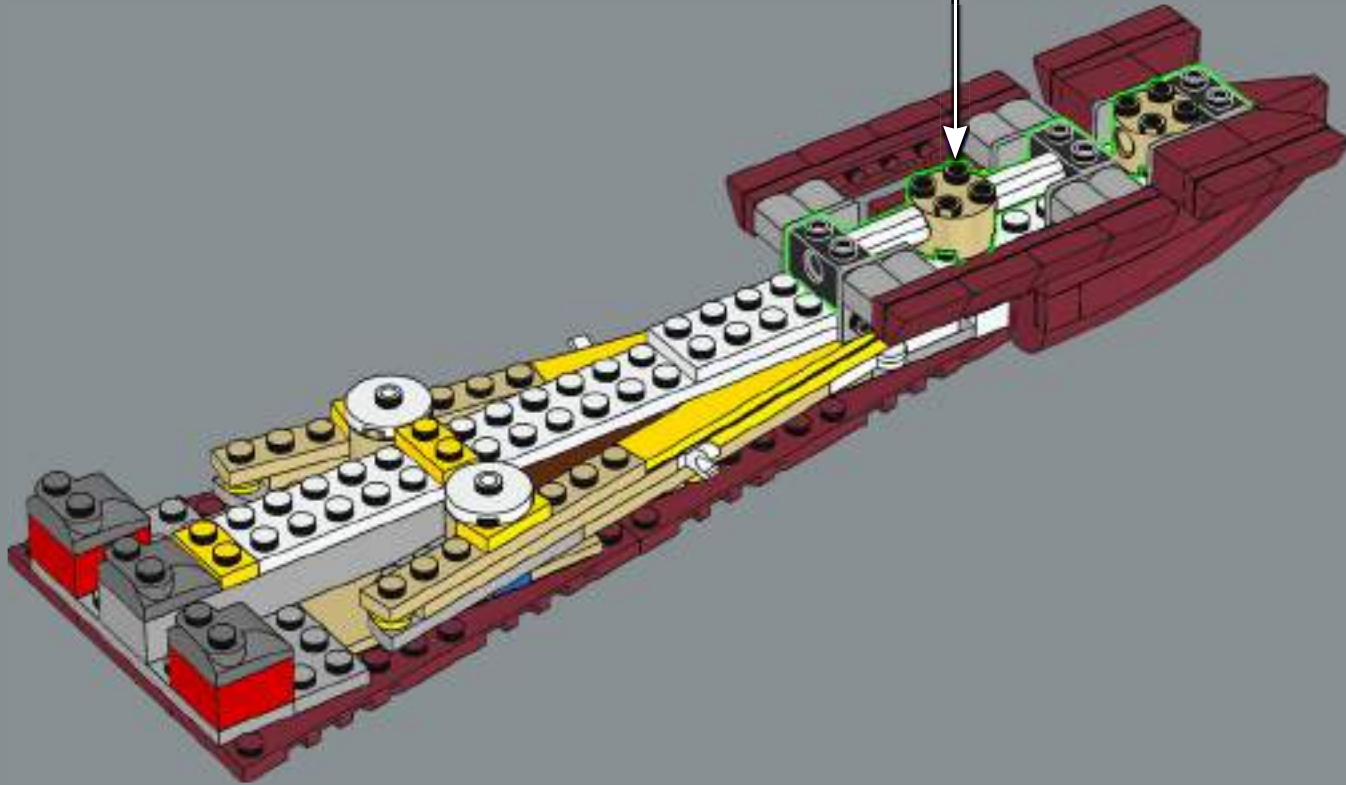
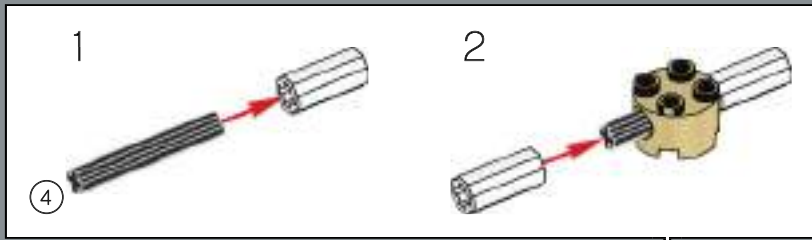

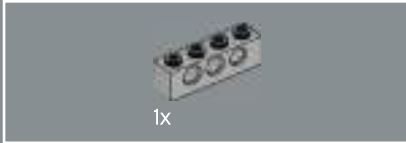

1x

162

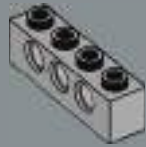

2x

163

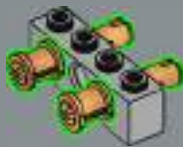

1x

9

164



9

1:1

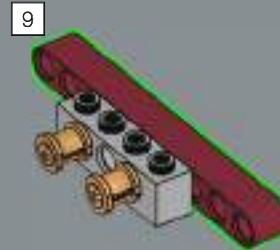

9

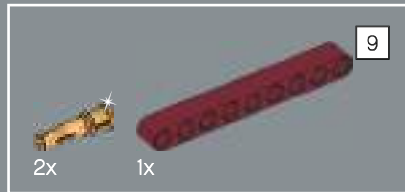

2x

1x

9

165

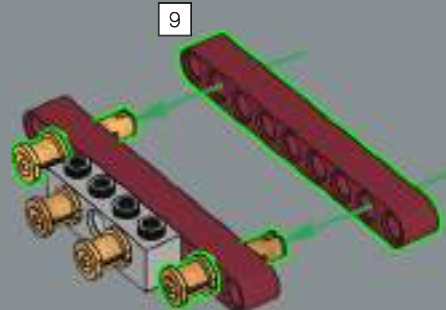

9



166

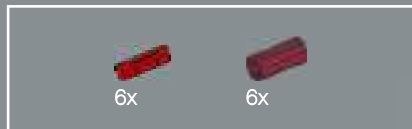
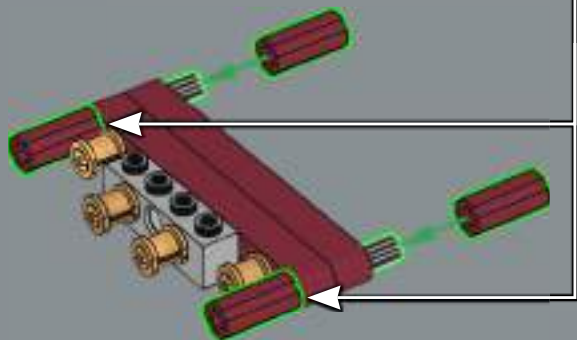
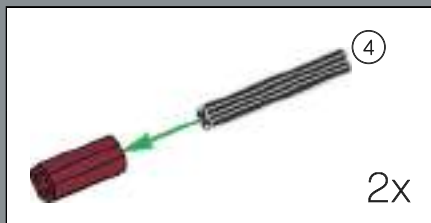

167

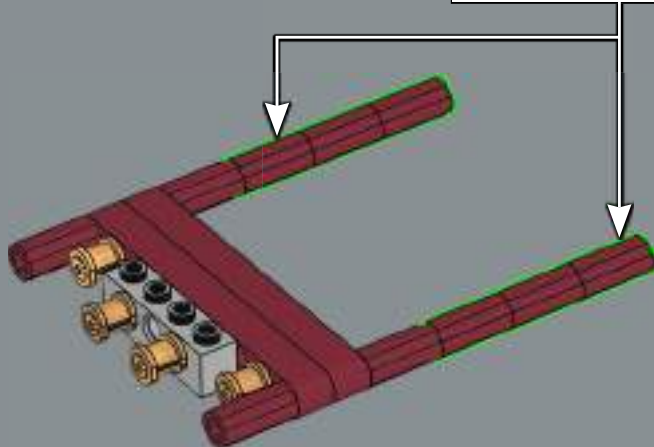
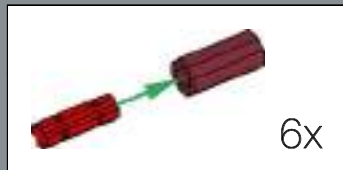

168

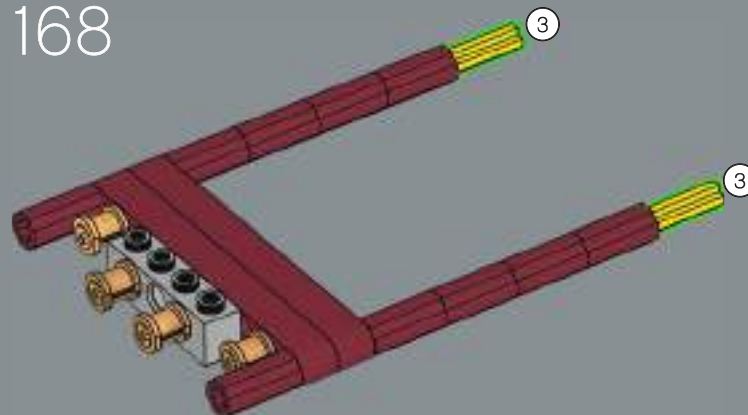

169

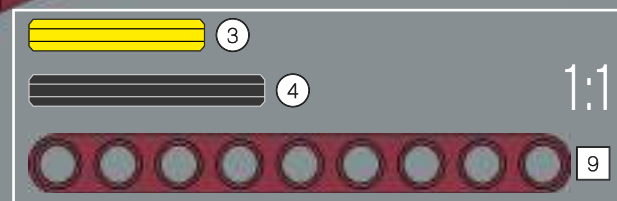
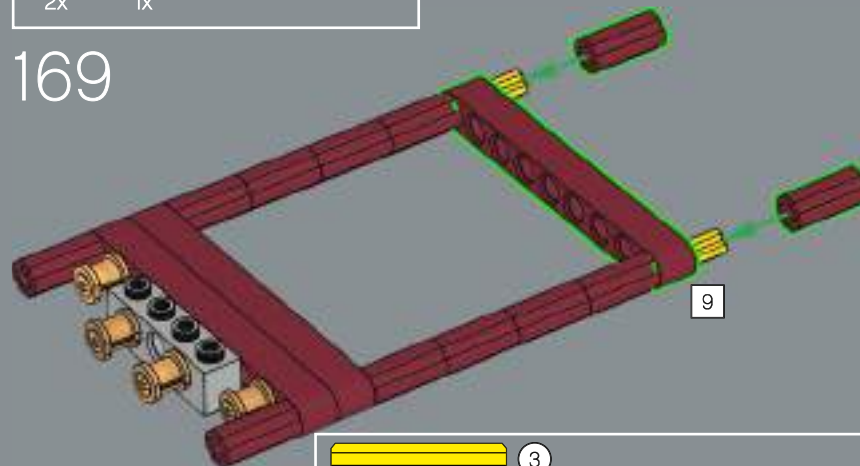

1:1

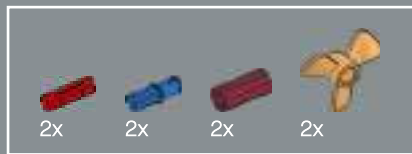

170

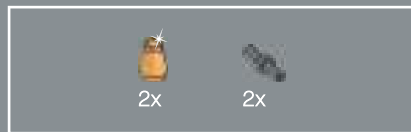
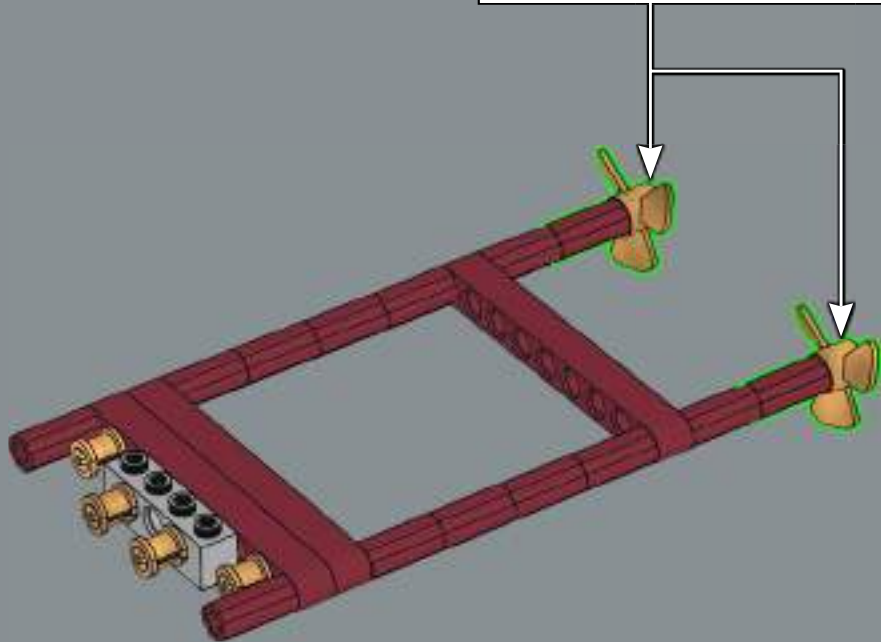
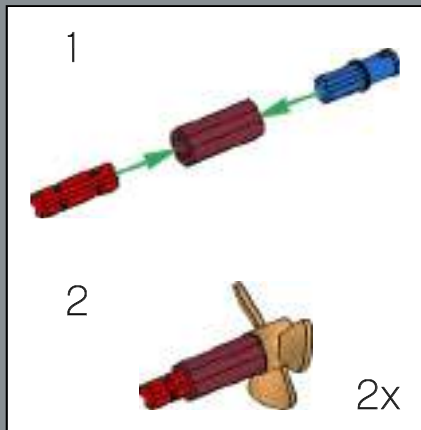

171

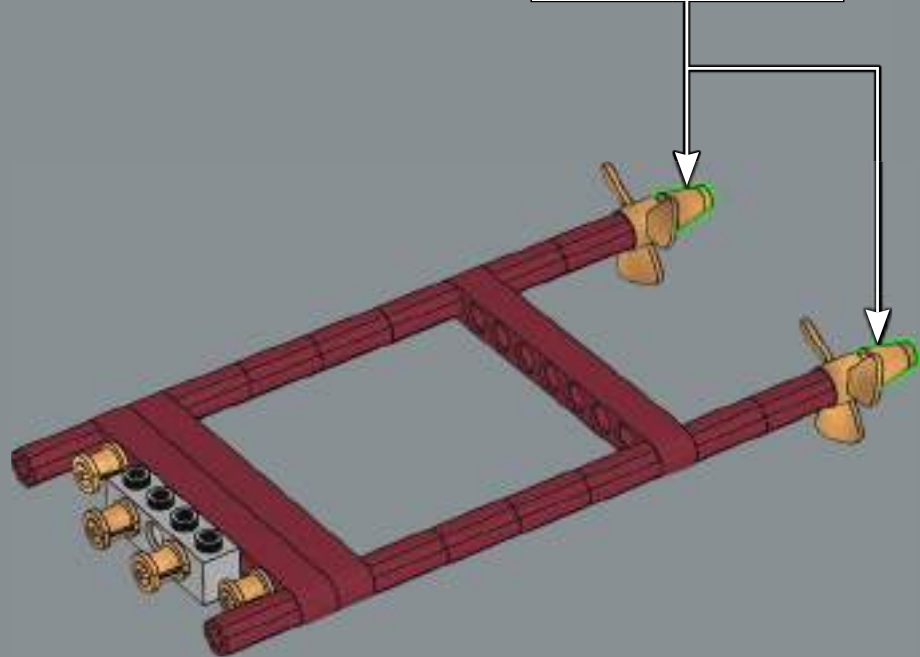
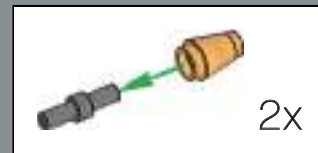

172

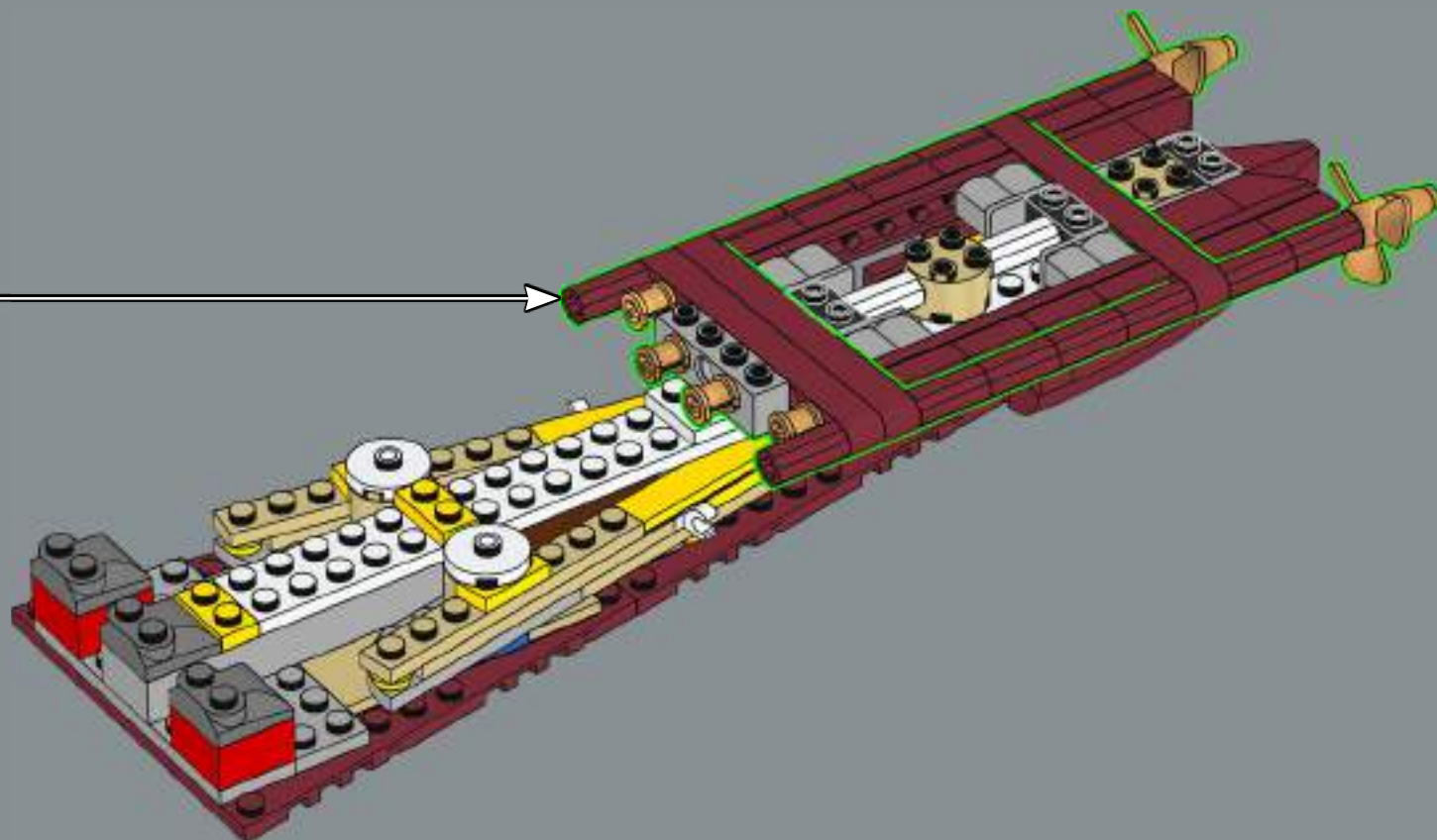

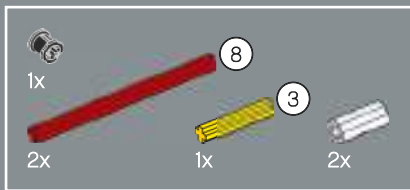

173

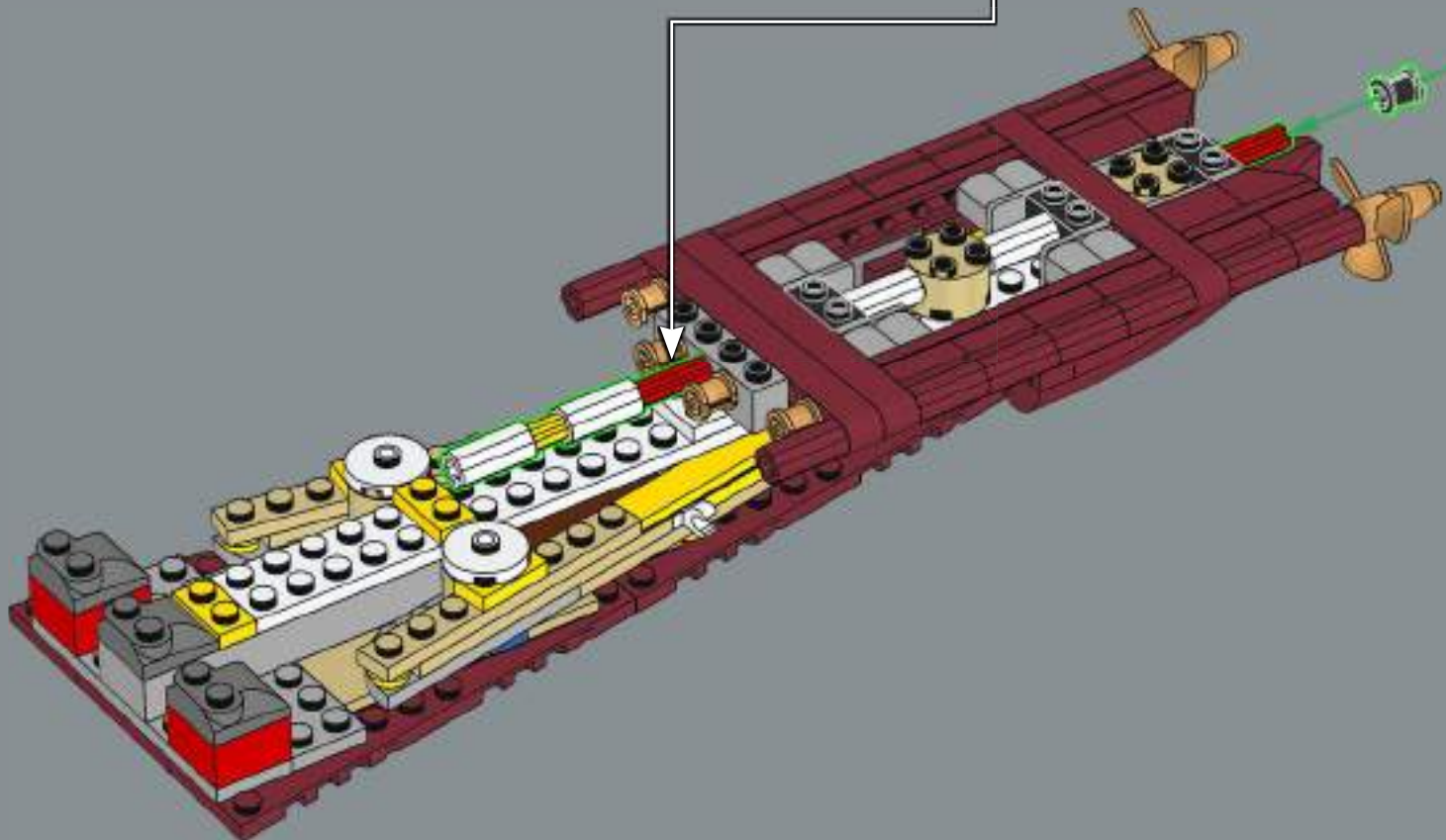
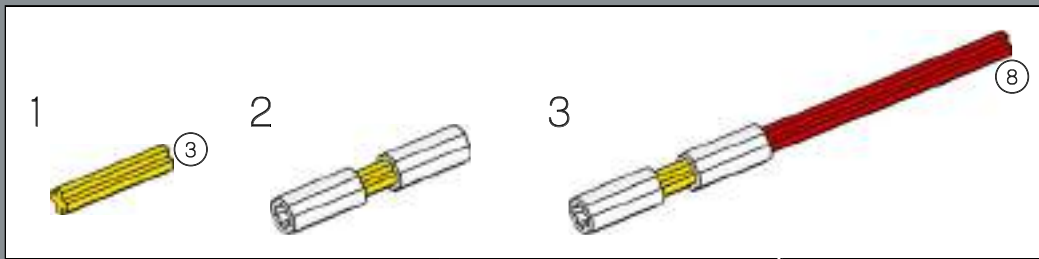

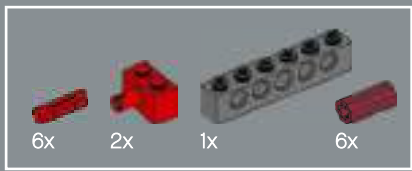

174

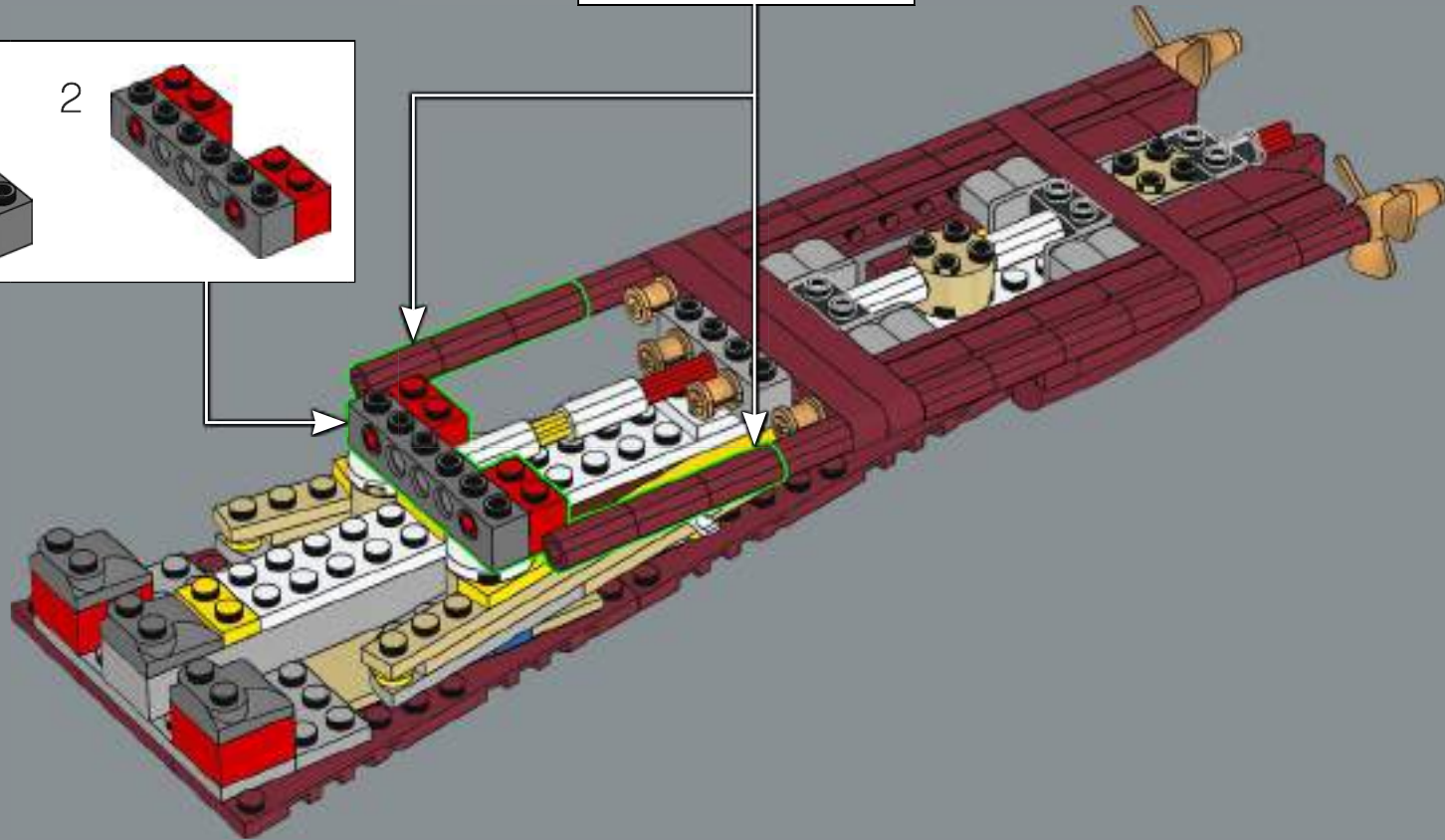
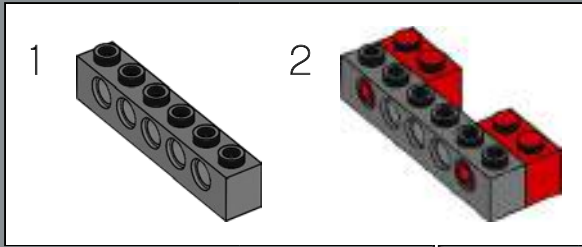
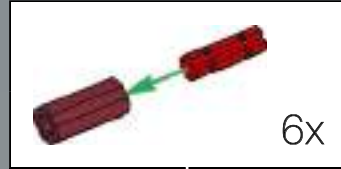

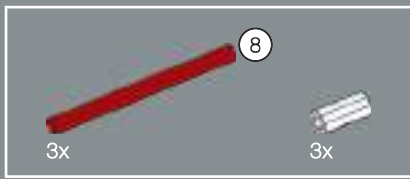

175

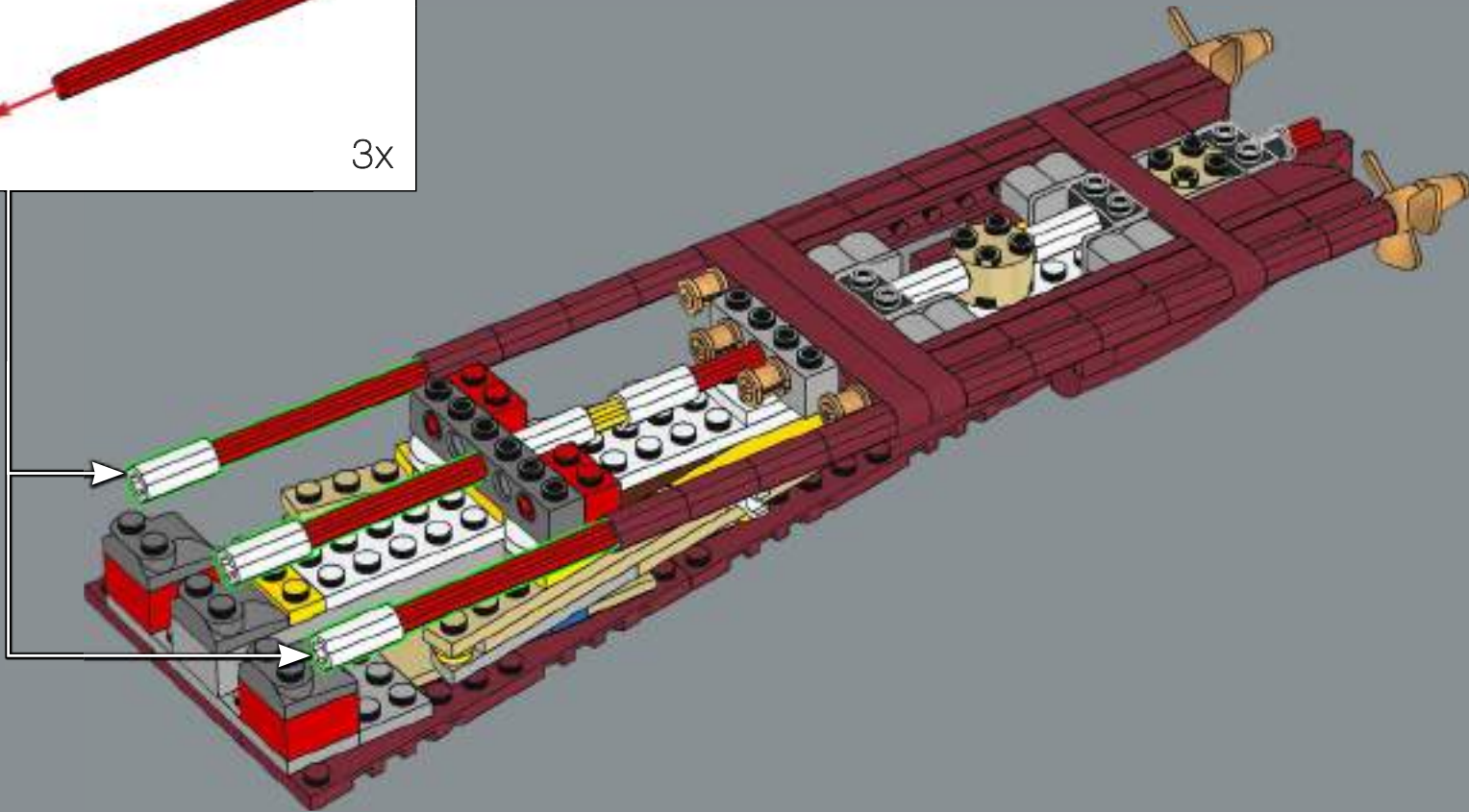
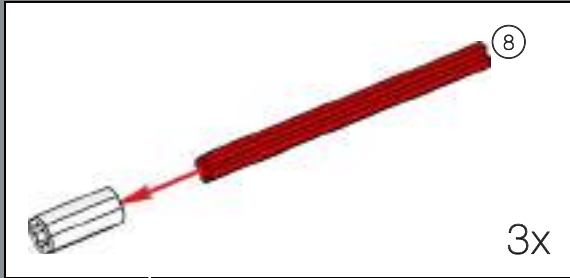



176

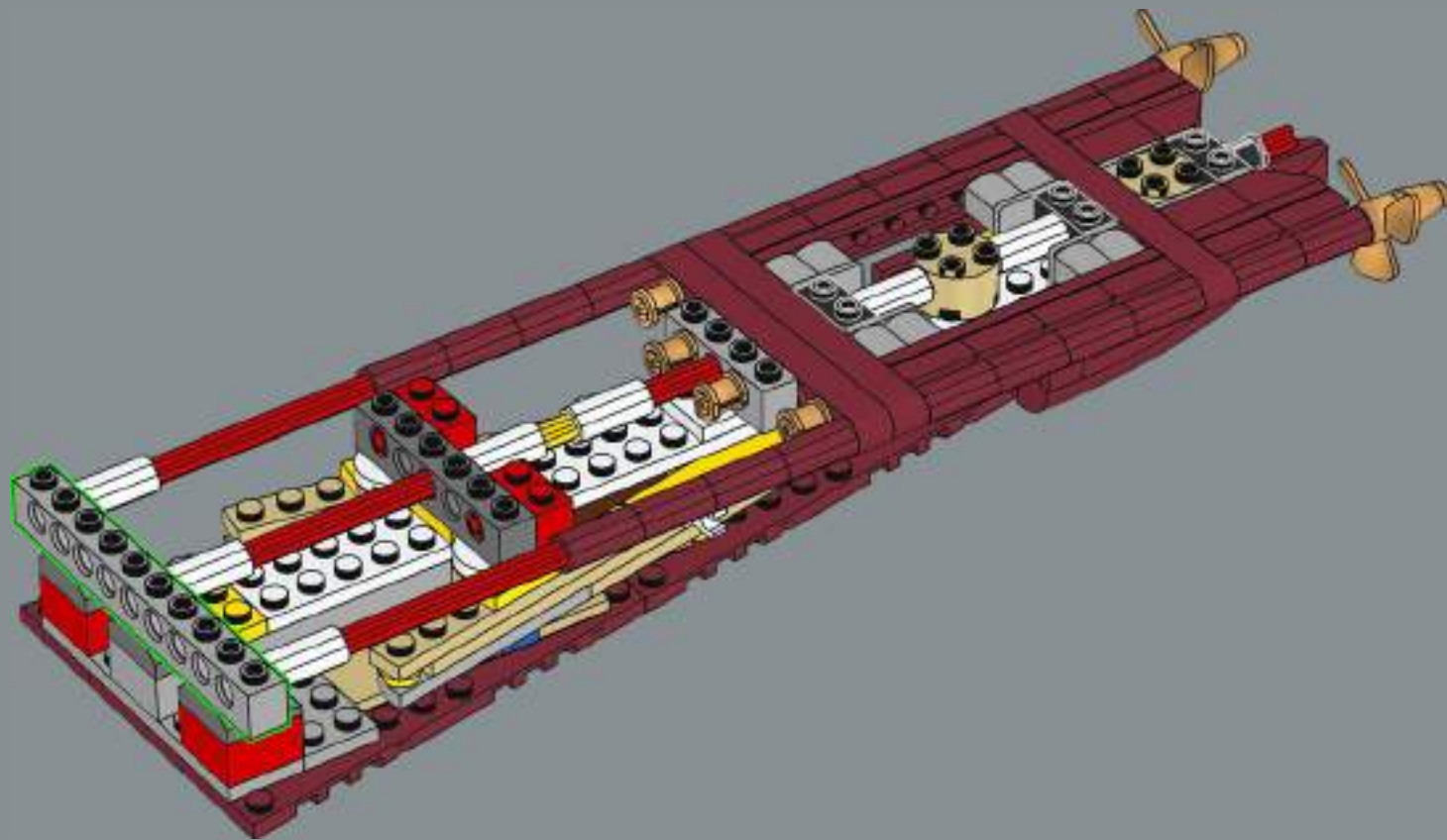

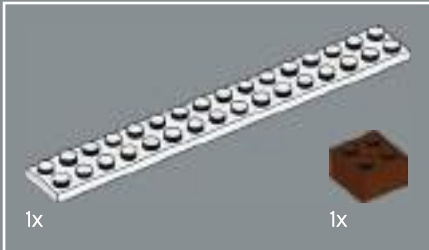
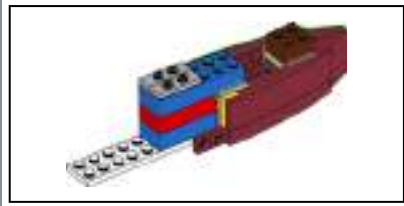
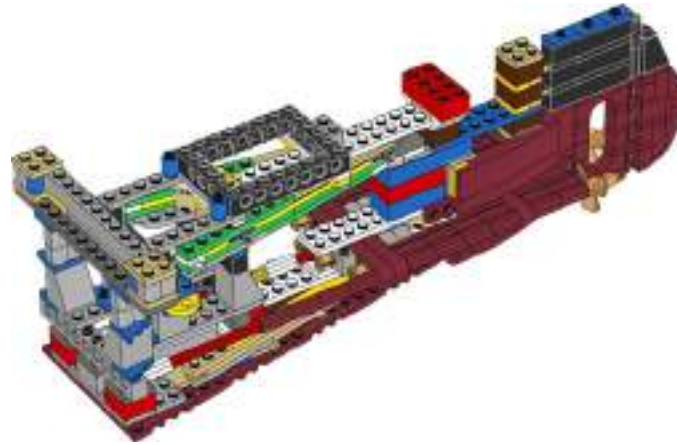
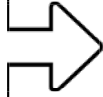

177

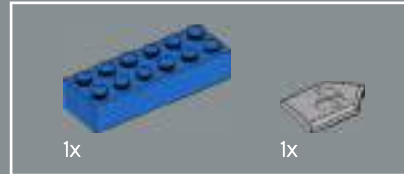
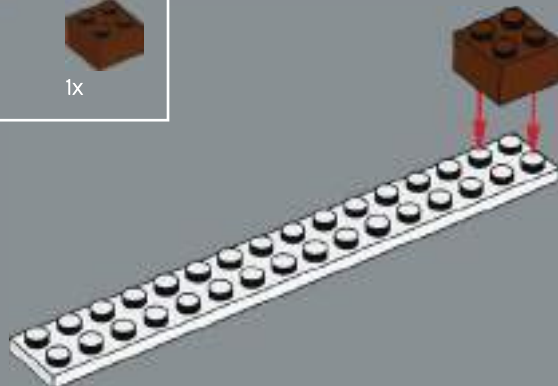

178

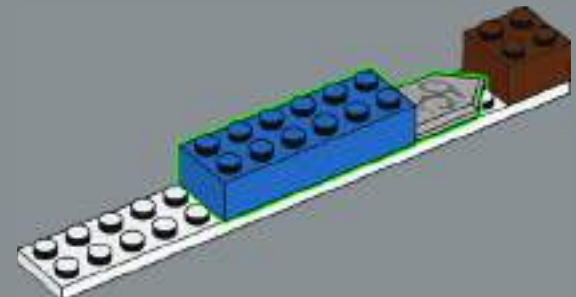



4x

179

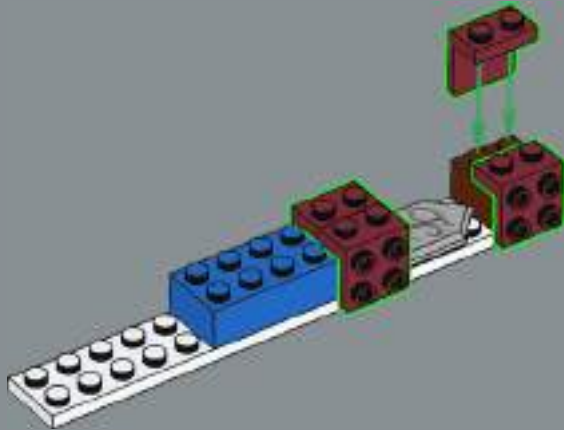

4x

180

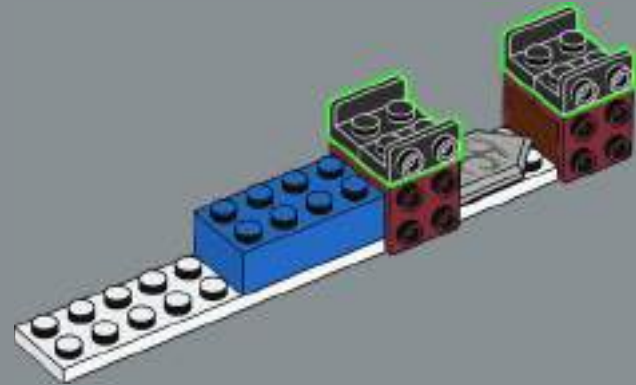



181

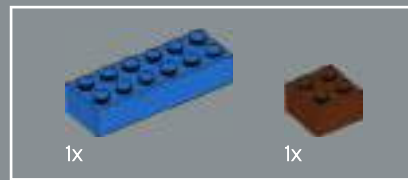
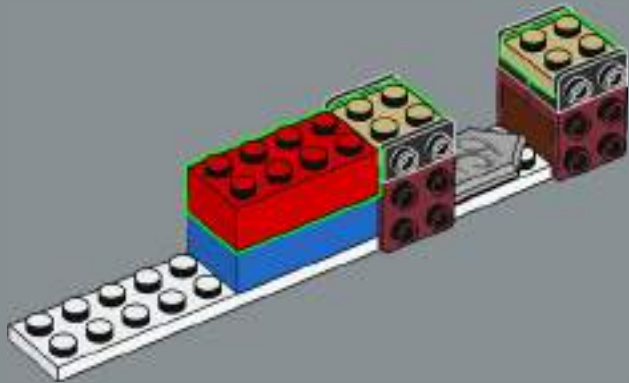

182

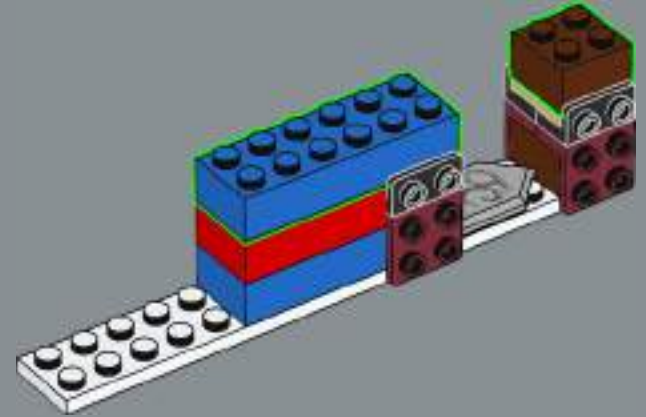

183

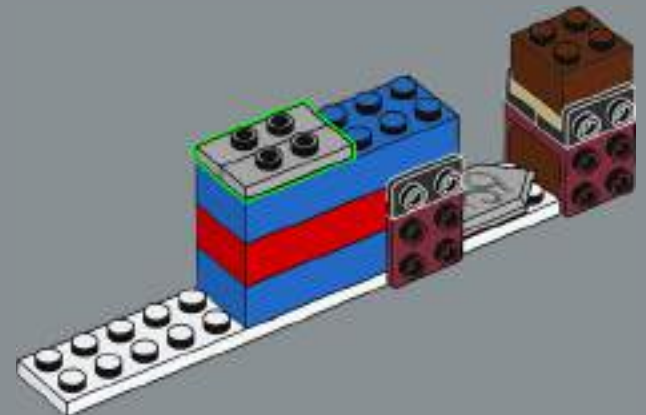

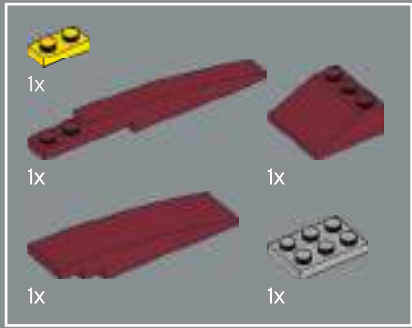

184

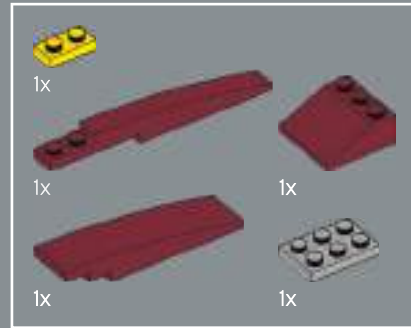
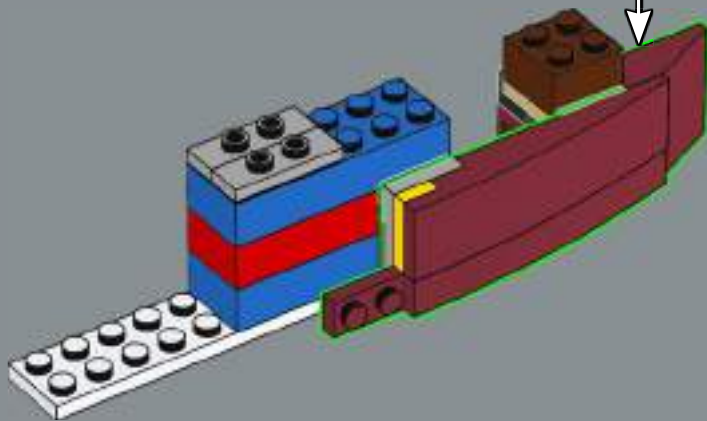
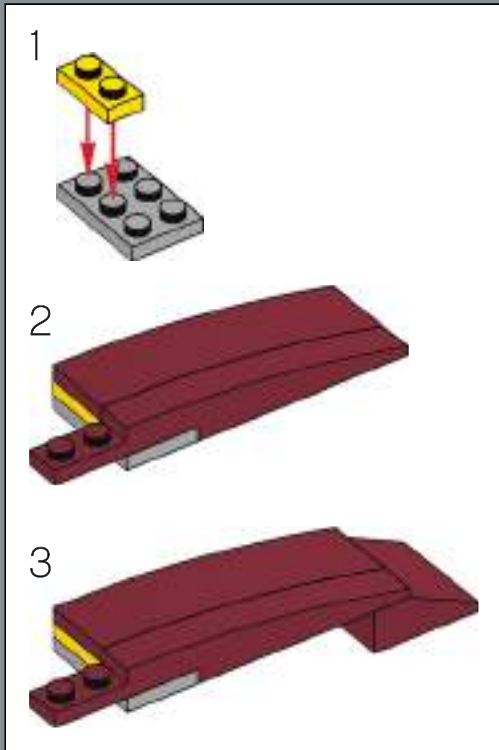

185

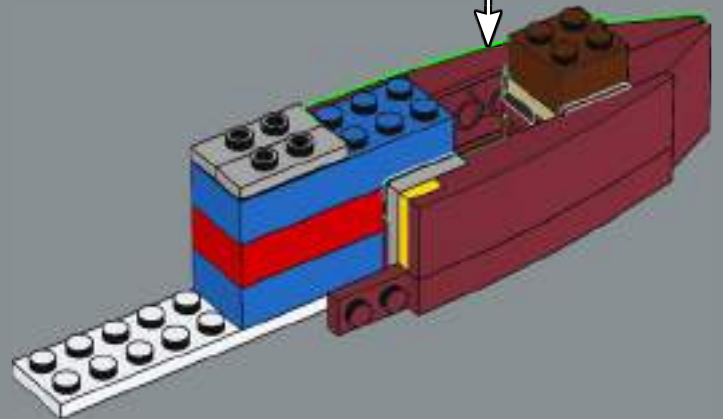
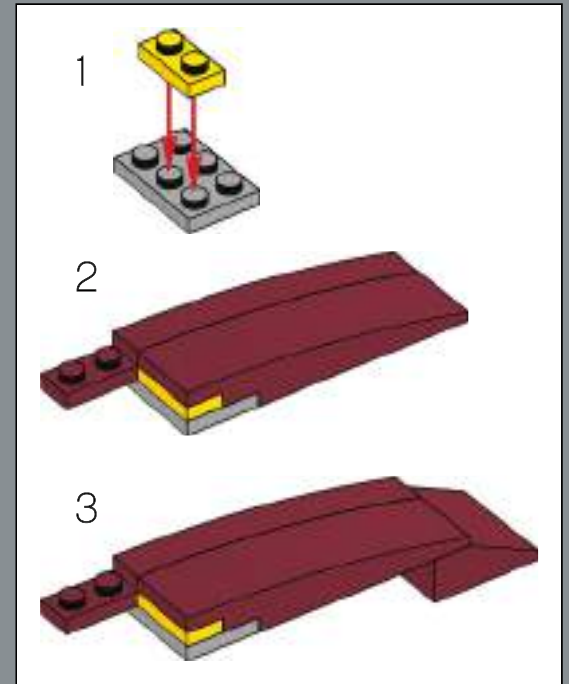

186

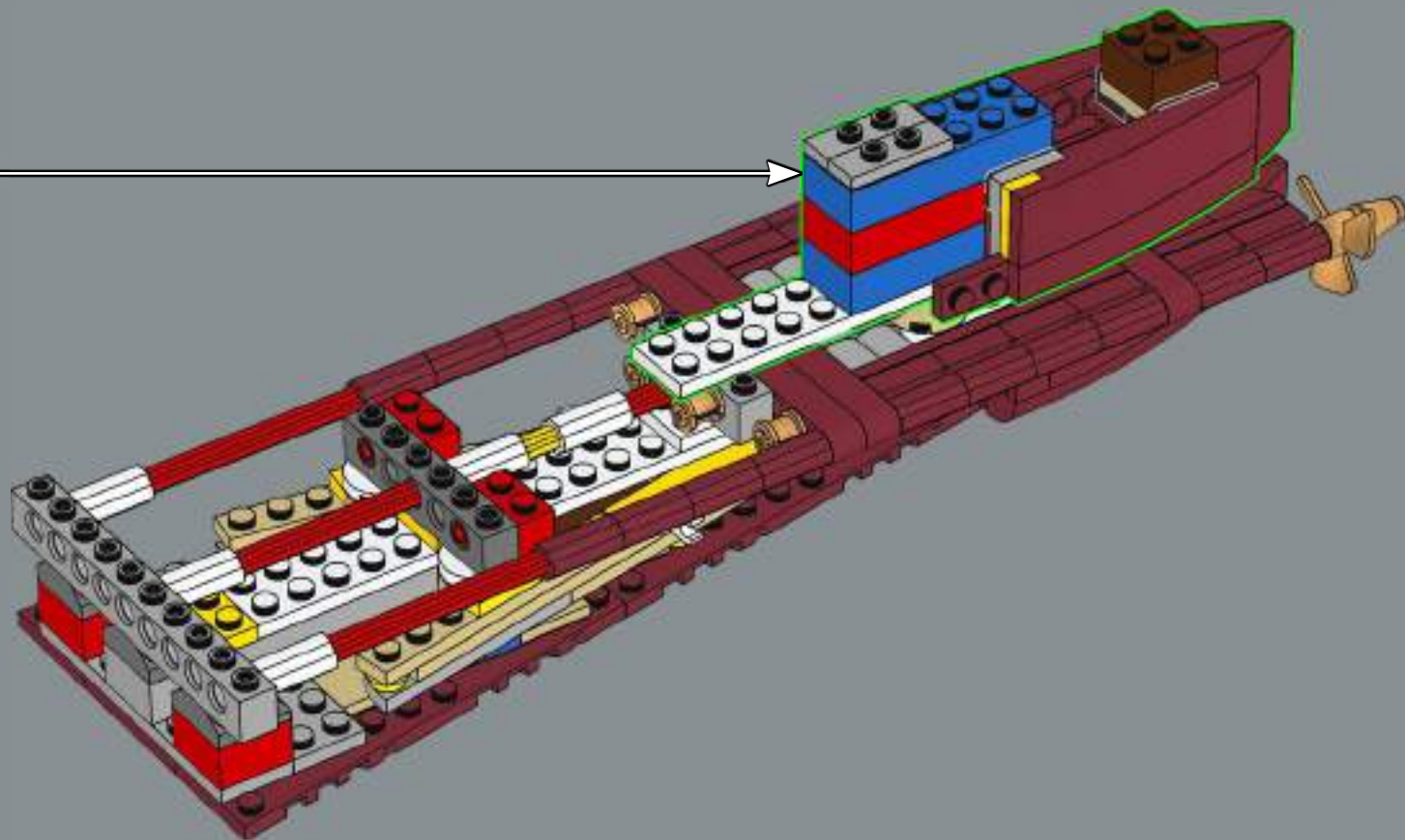

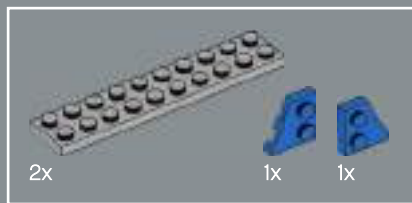

187

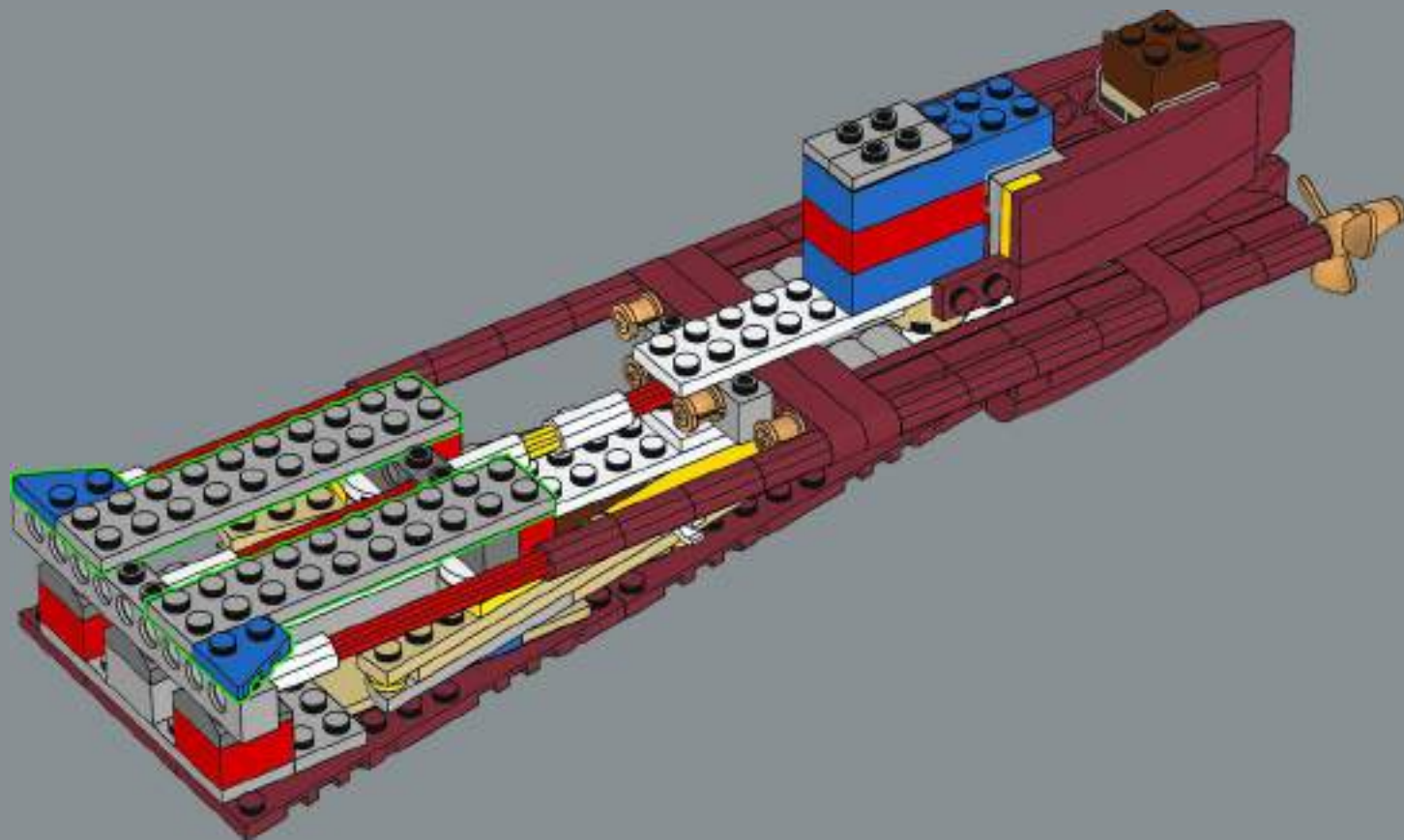

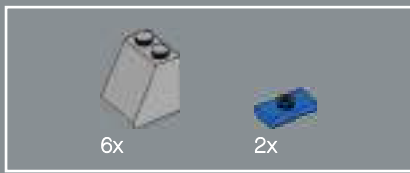

188

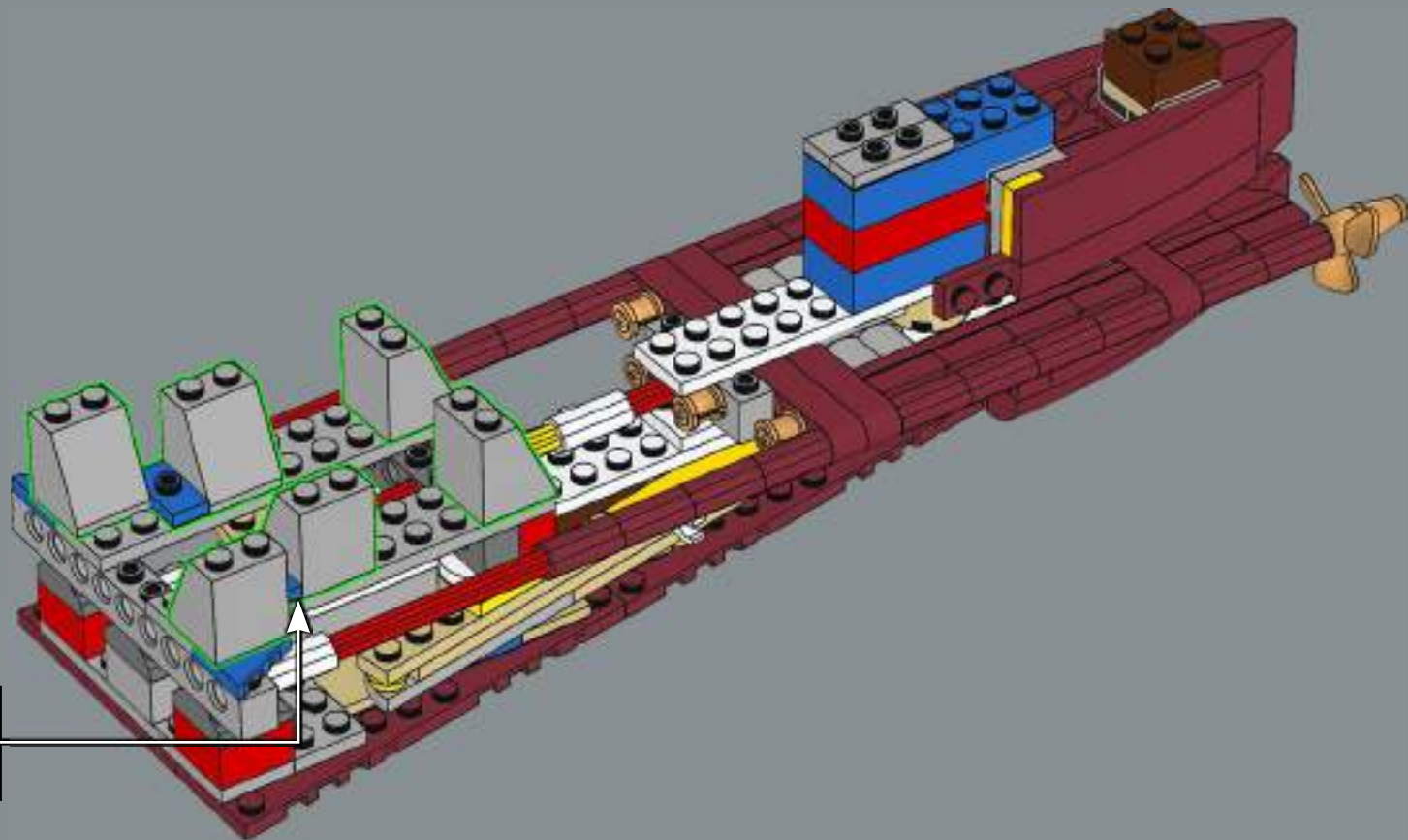

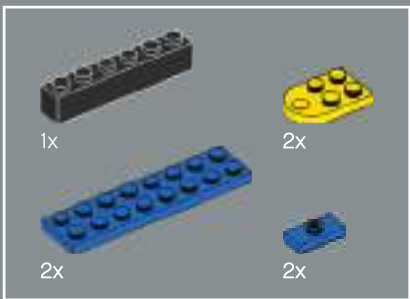

189

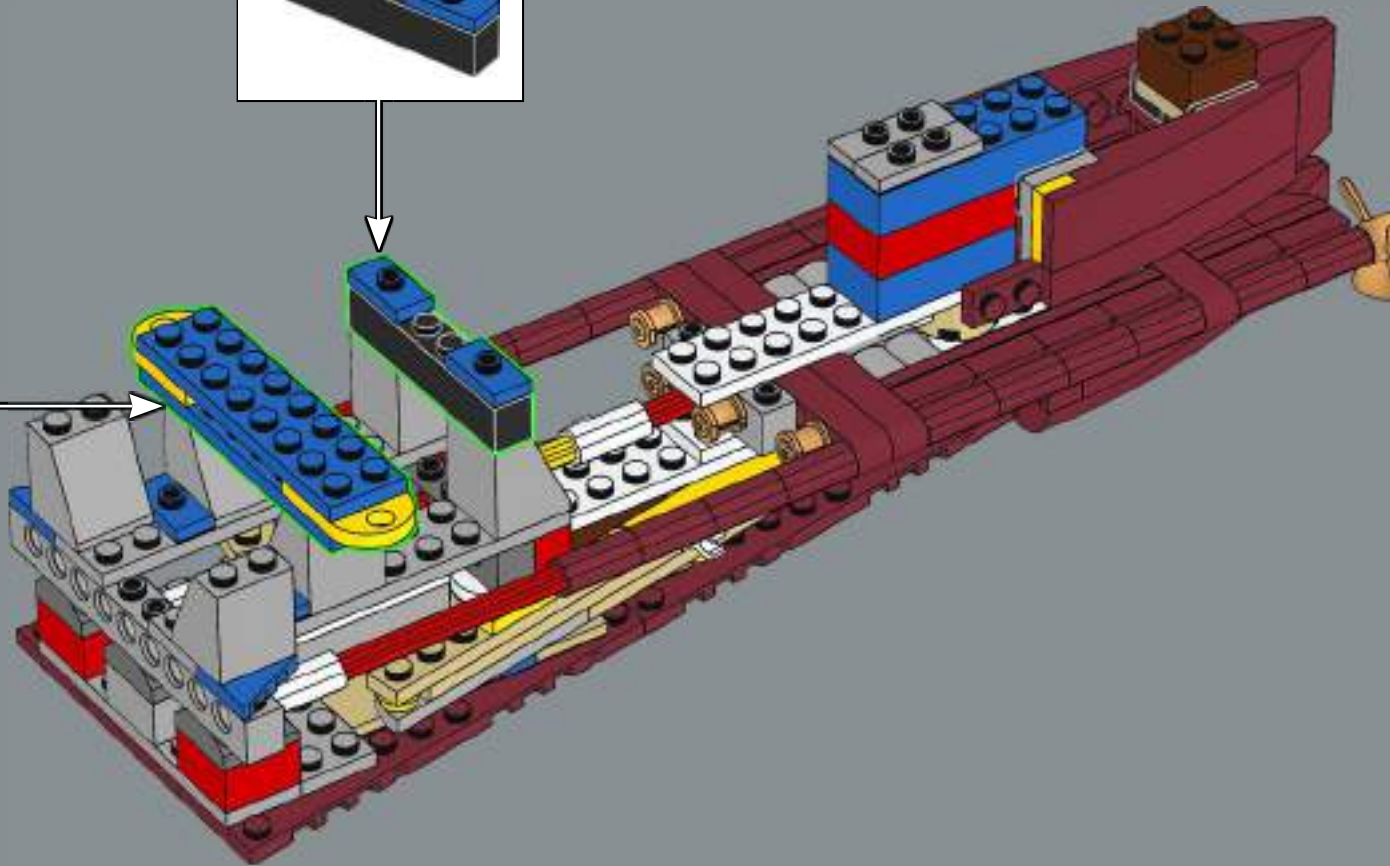
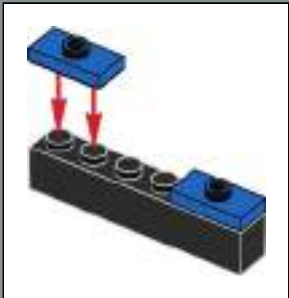
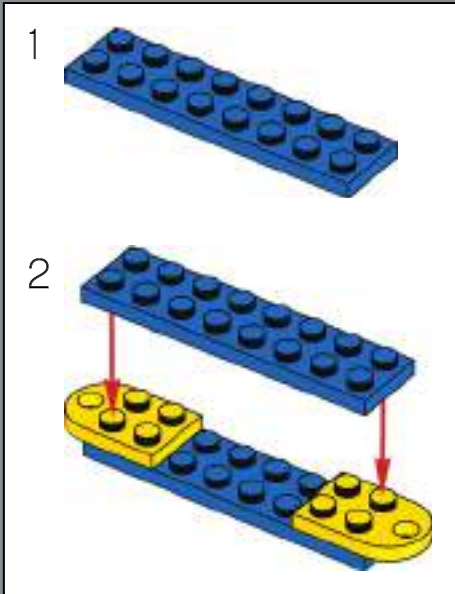

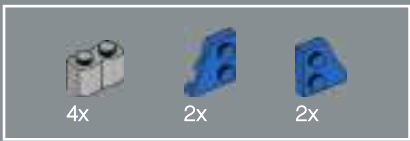

190

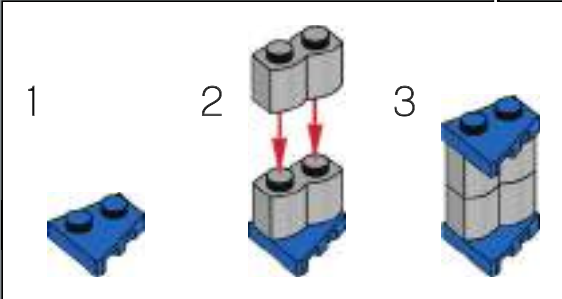
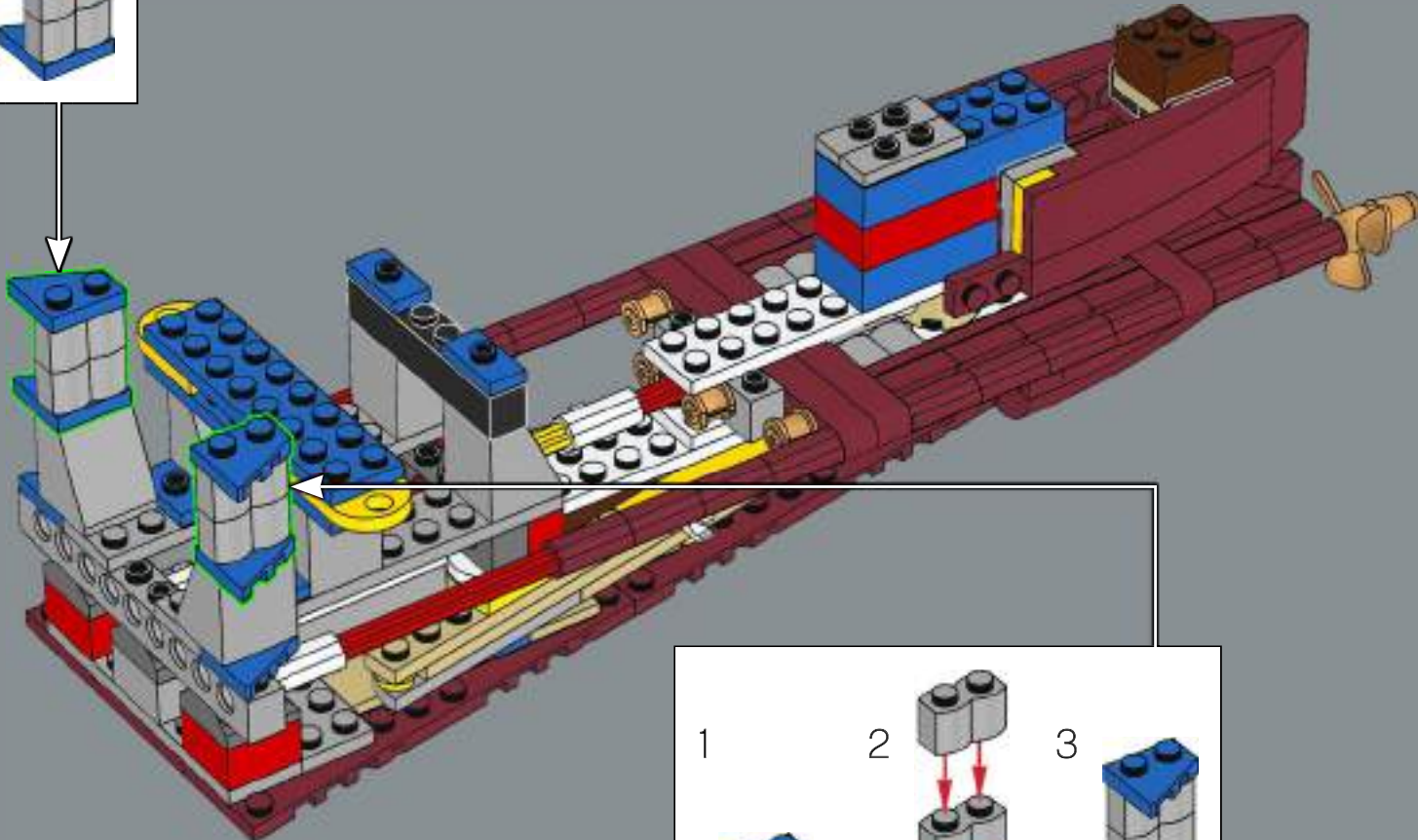
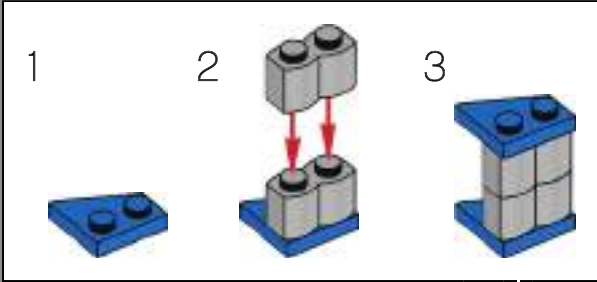

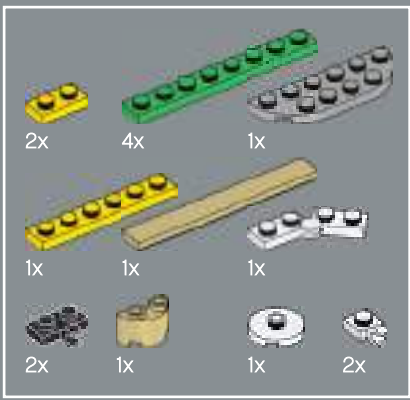

191

1



2

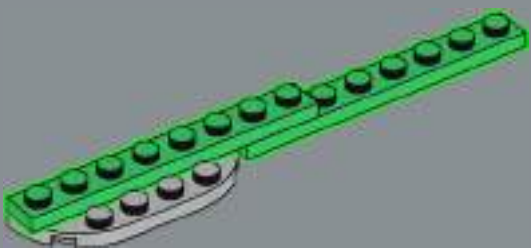

3

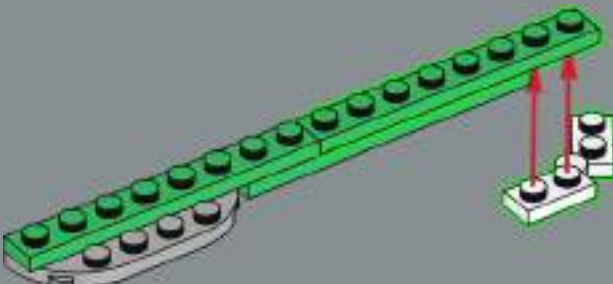

4

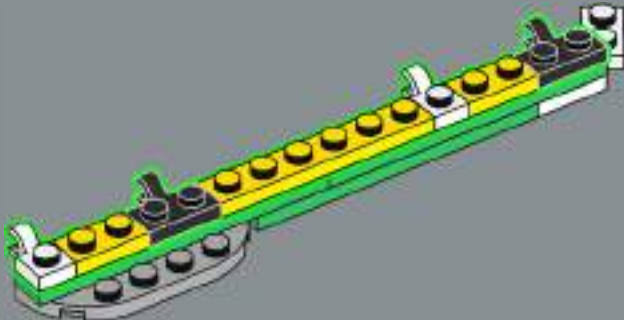

5

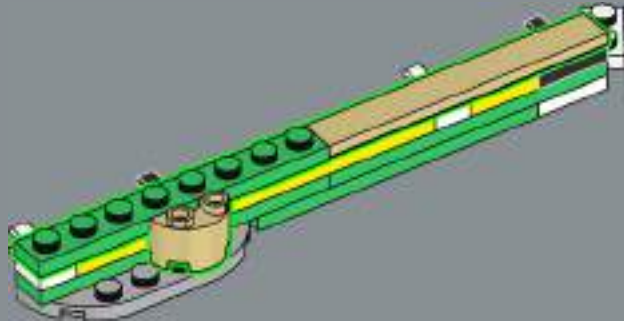

6

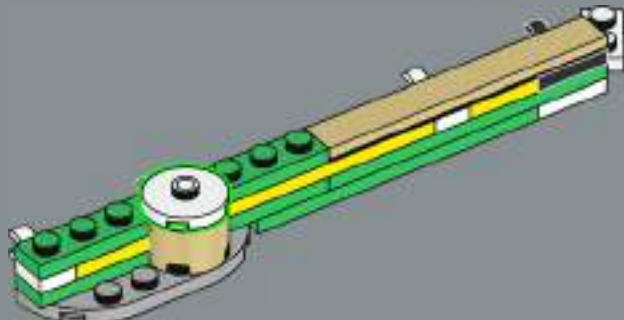

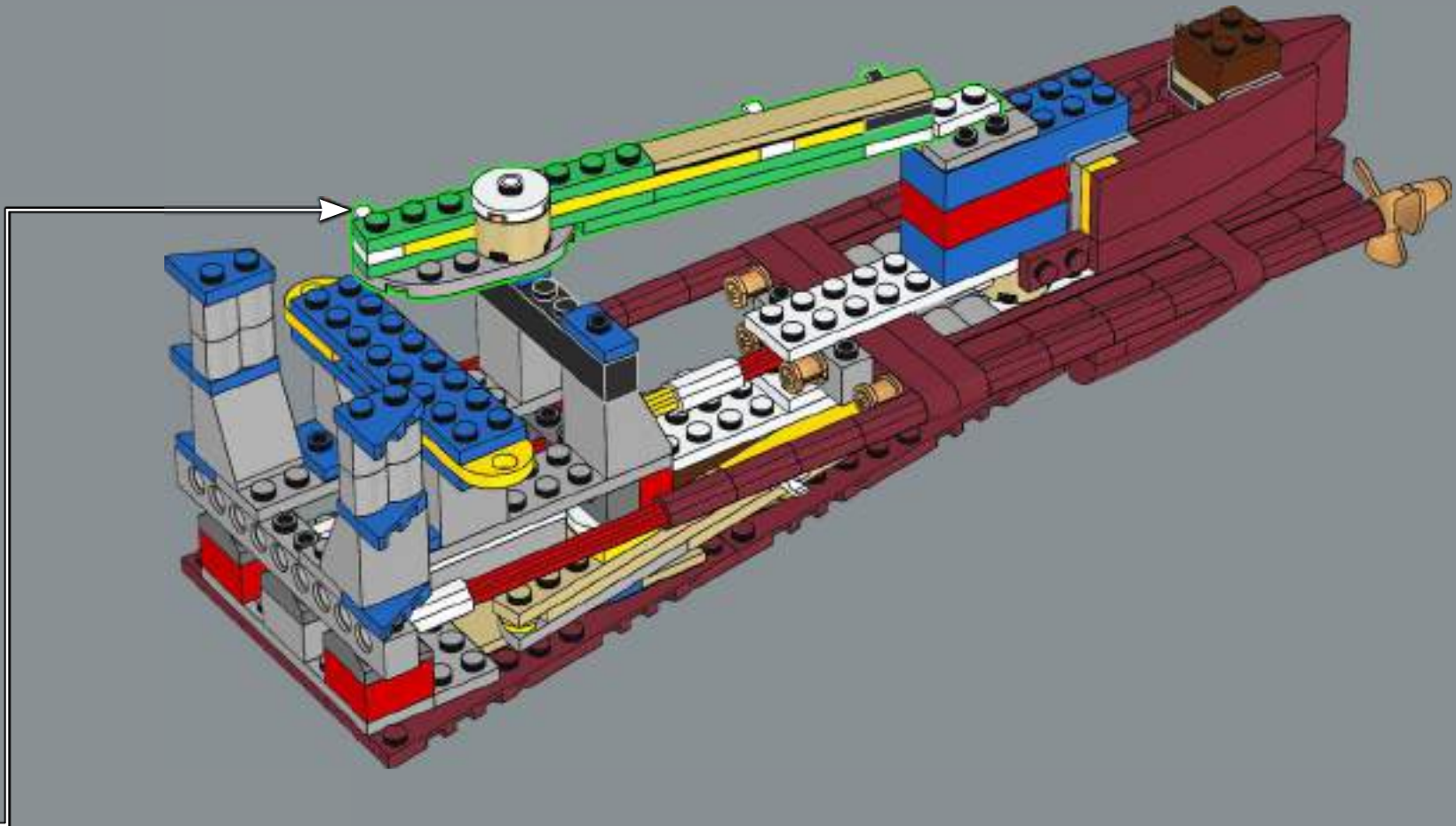

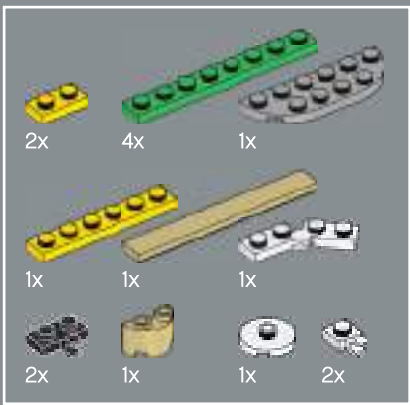

192

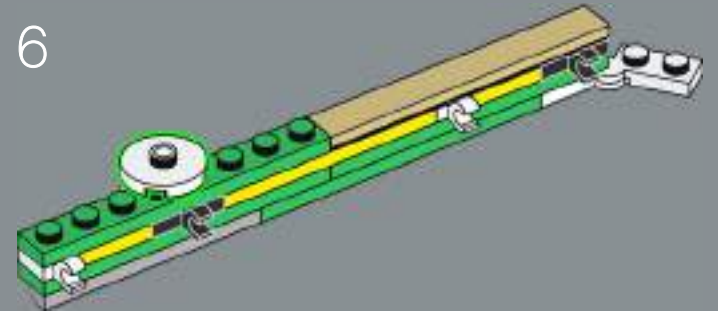
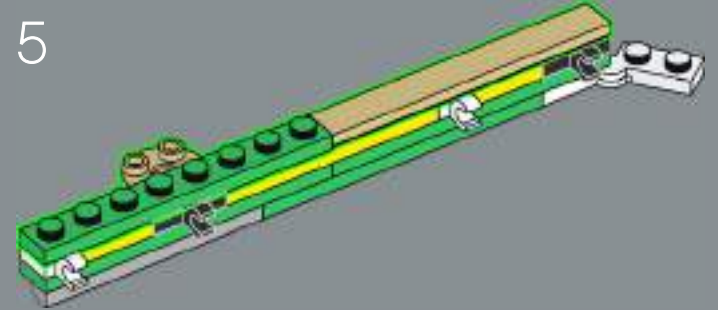
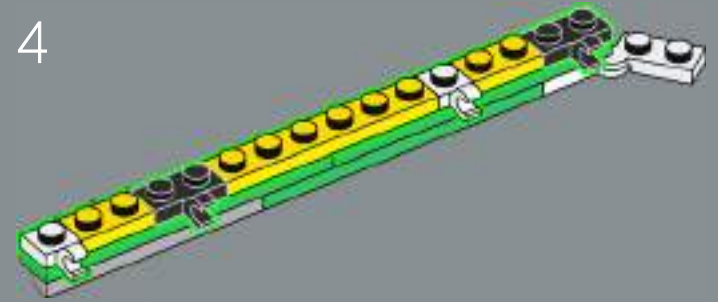
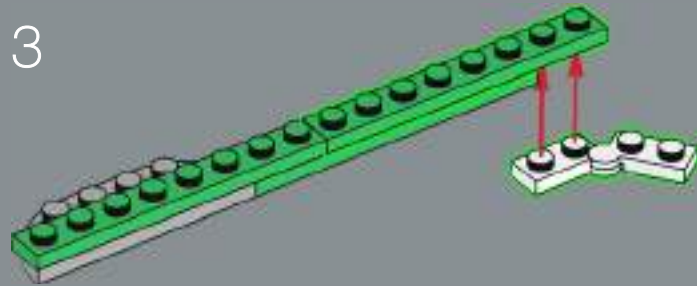
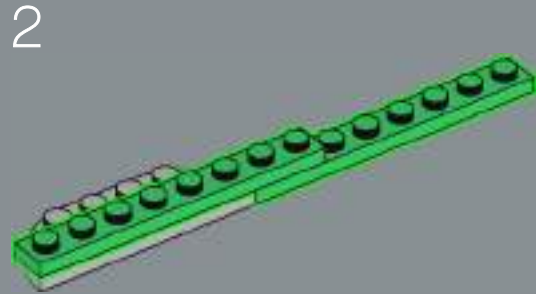

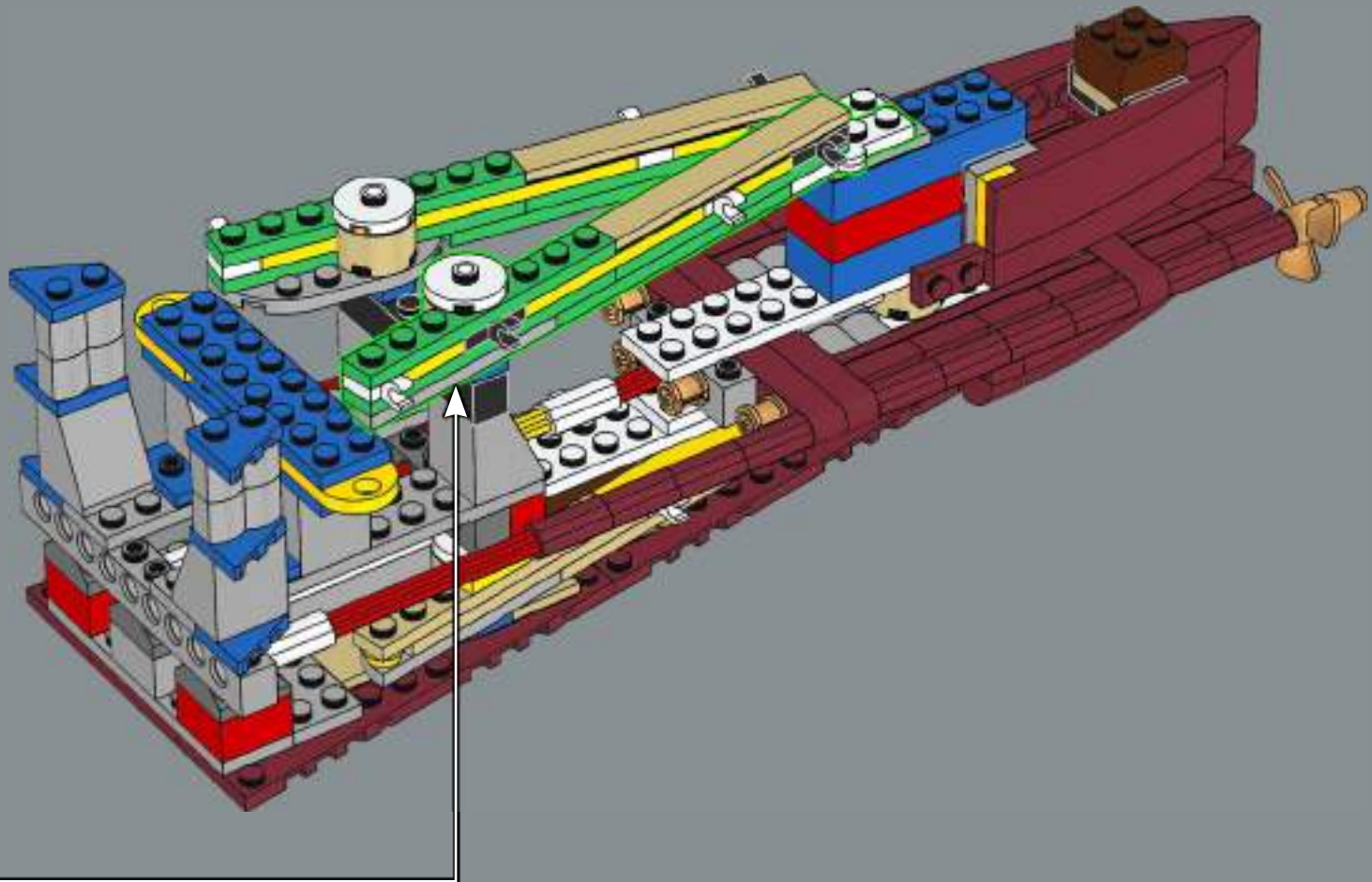

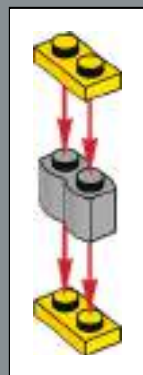
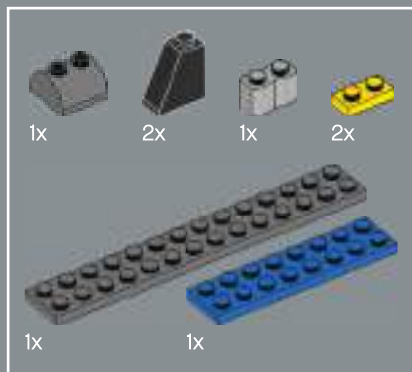

193

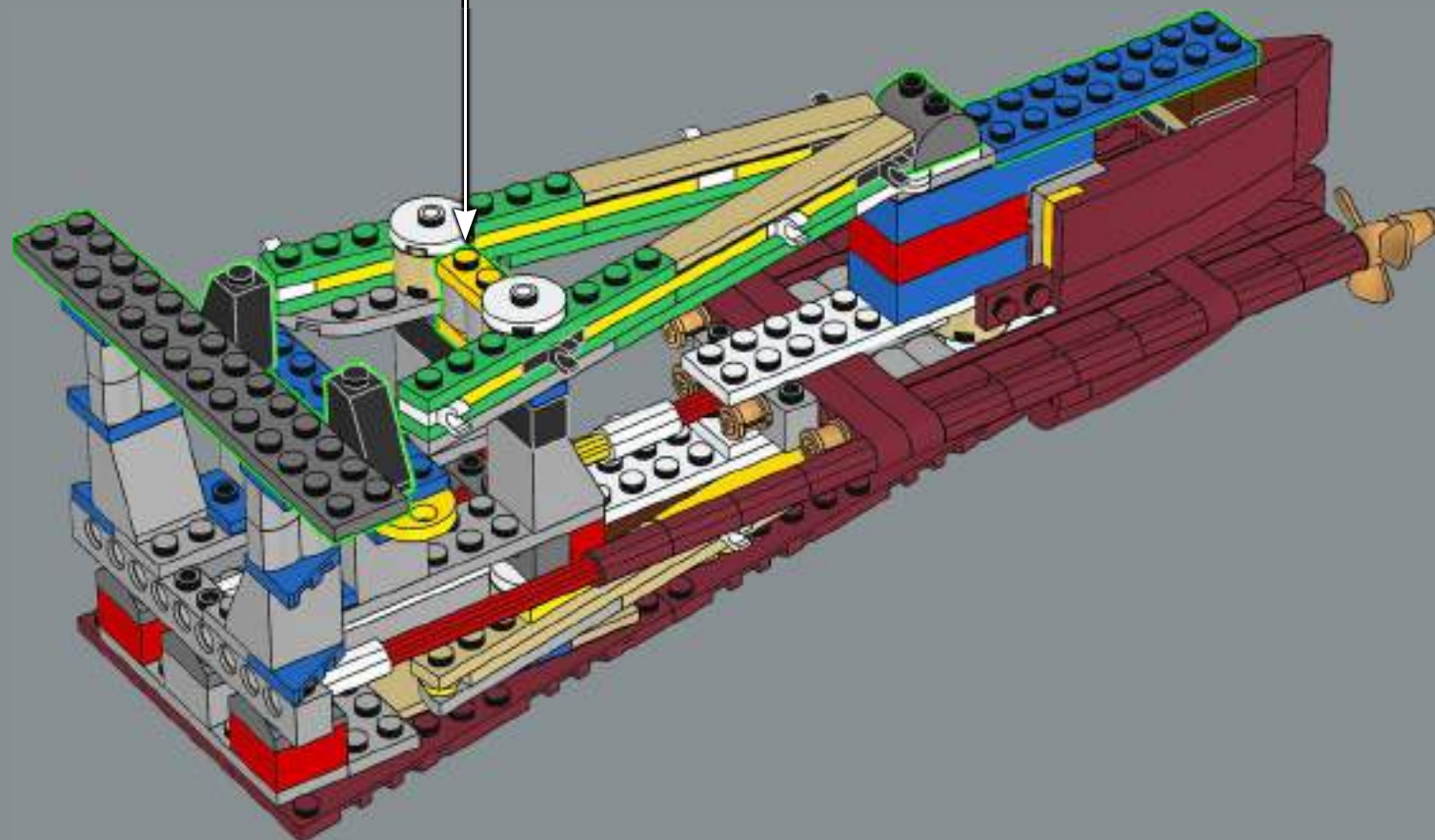

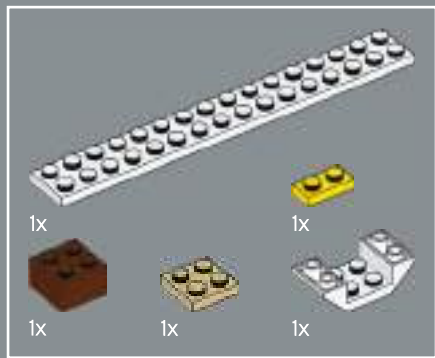

194

1



2



3

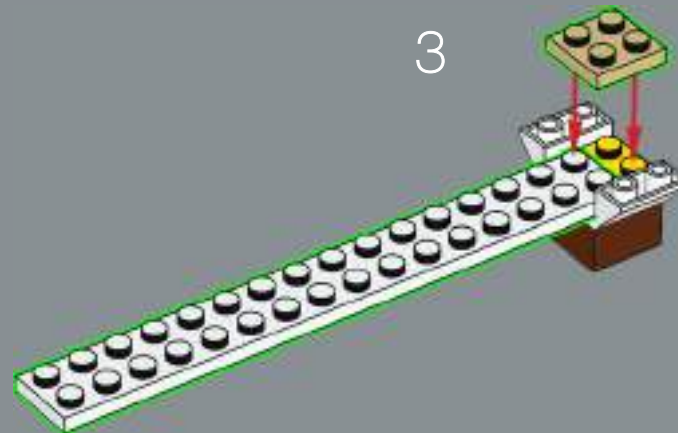

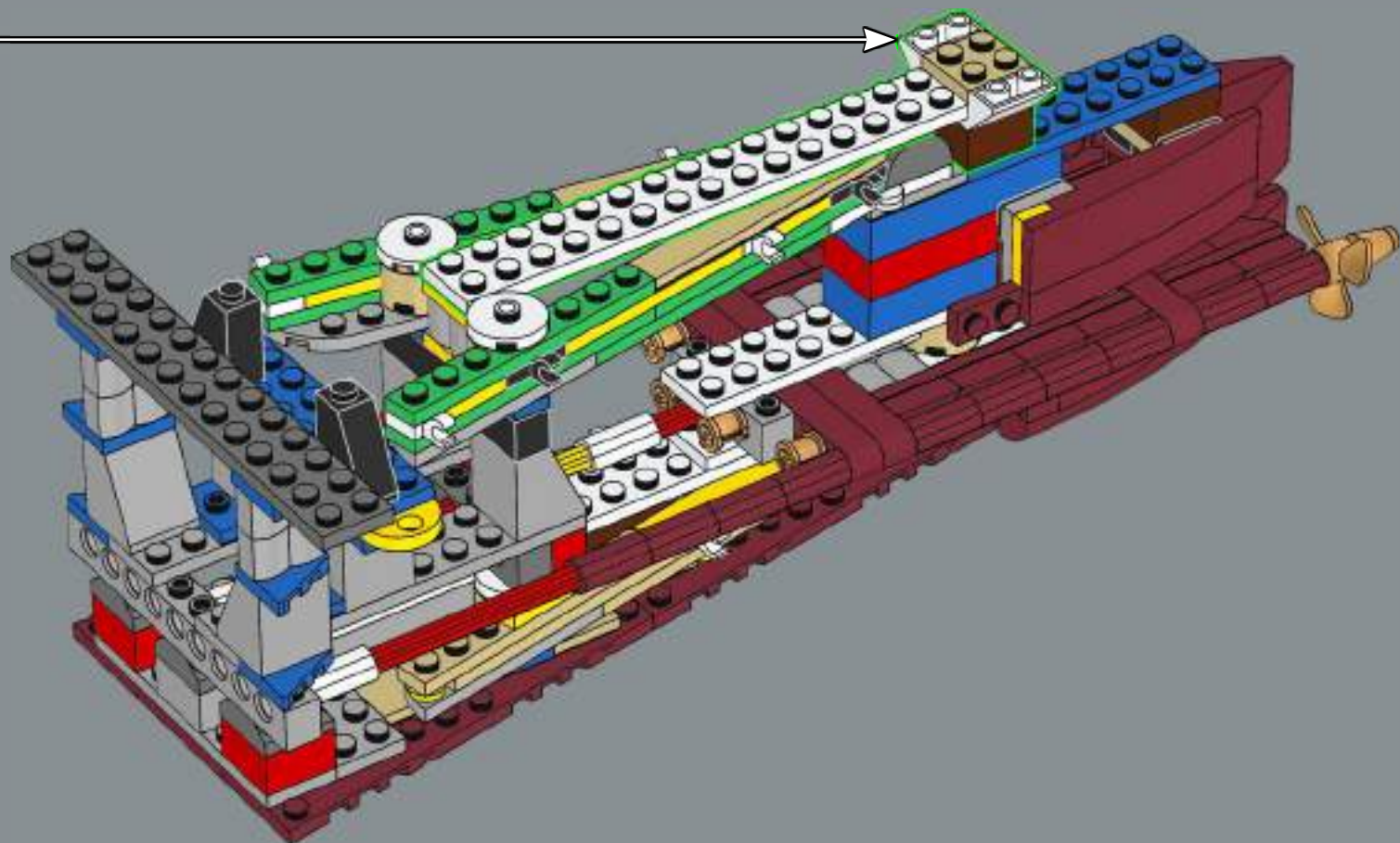

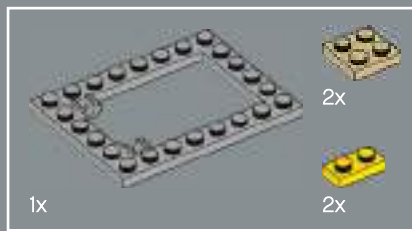

195

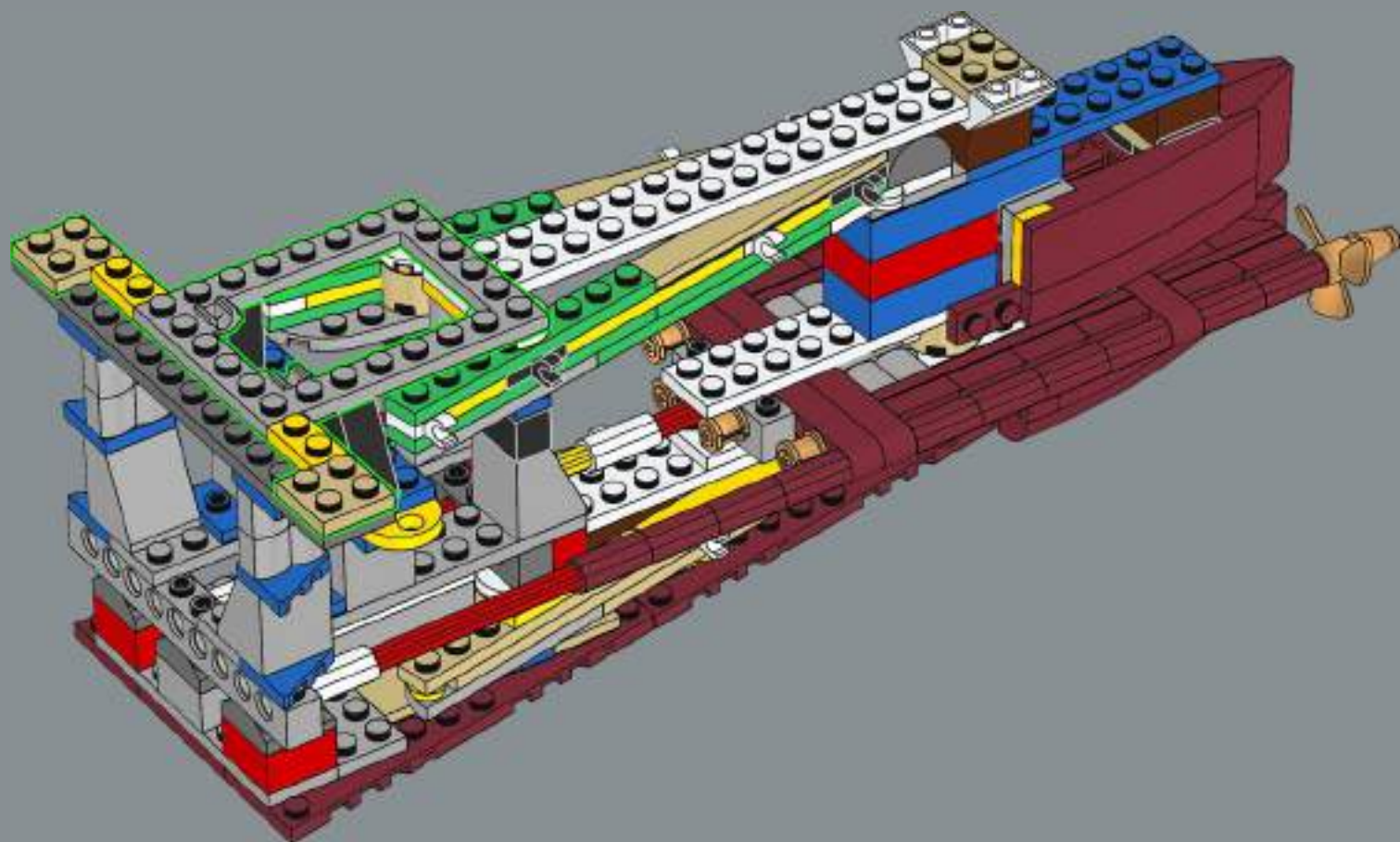

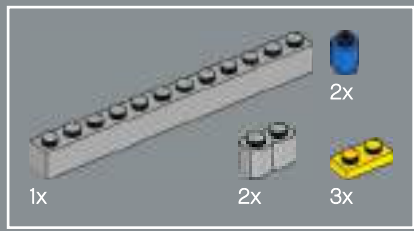

196

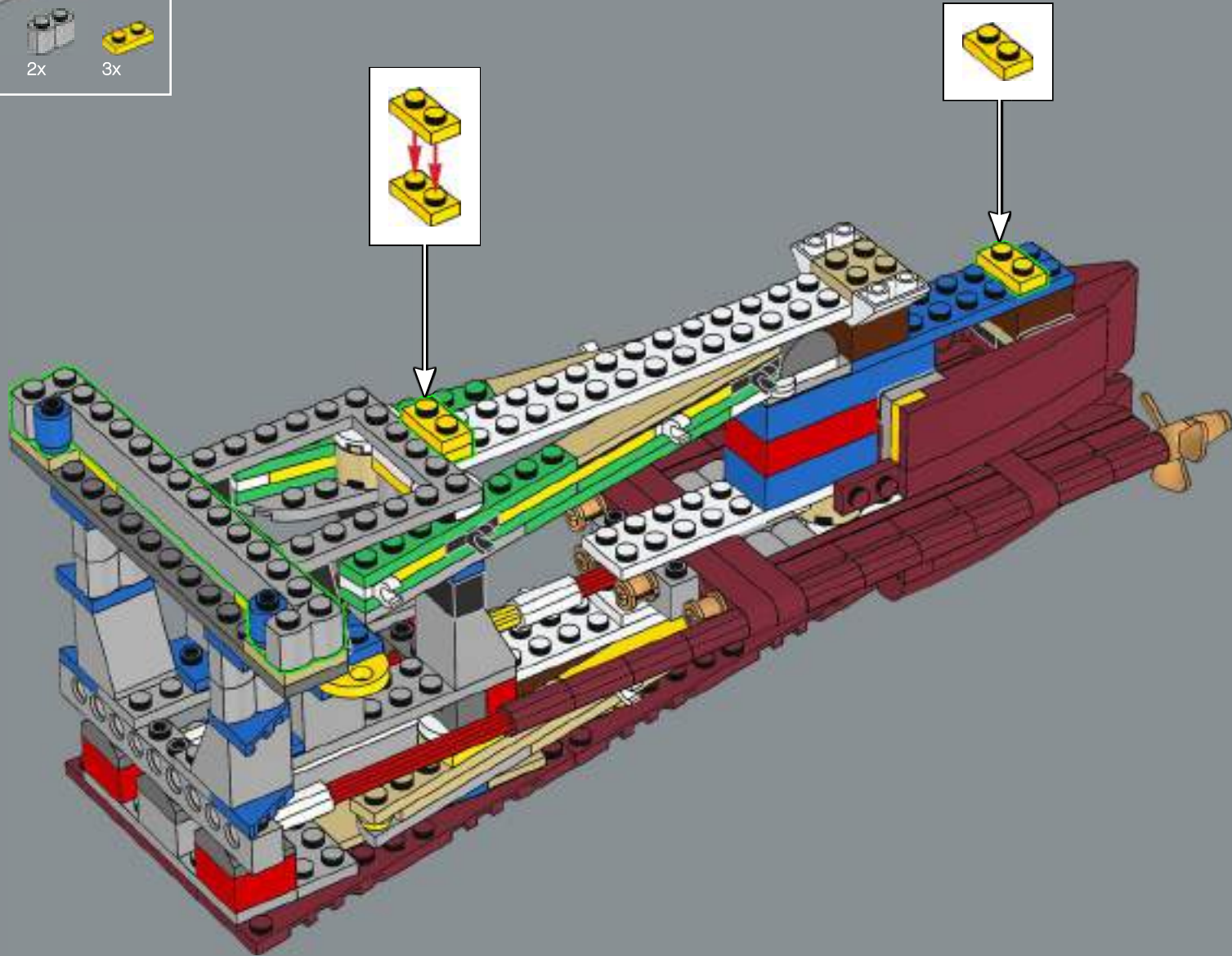



197

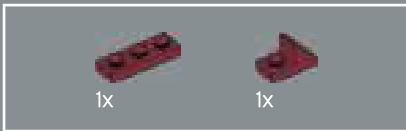
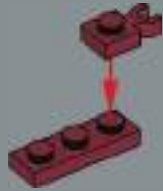

198

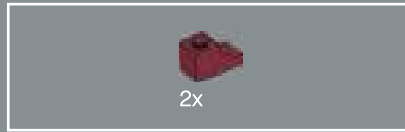
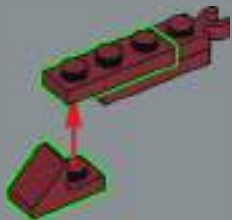

199

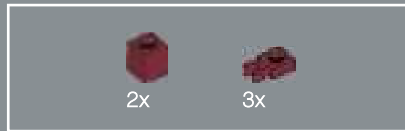
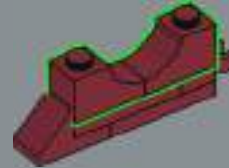

200

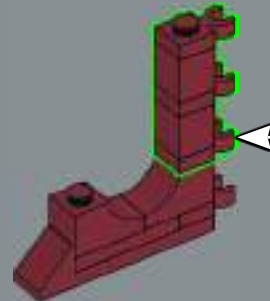
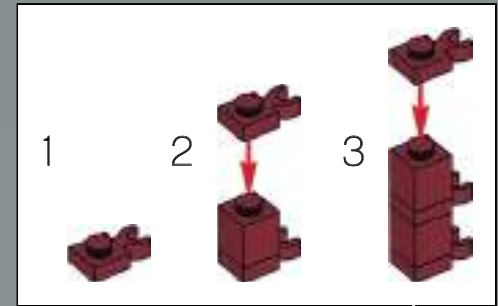



201

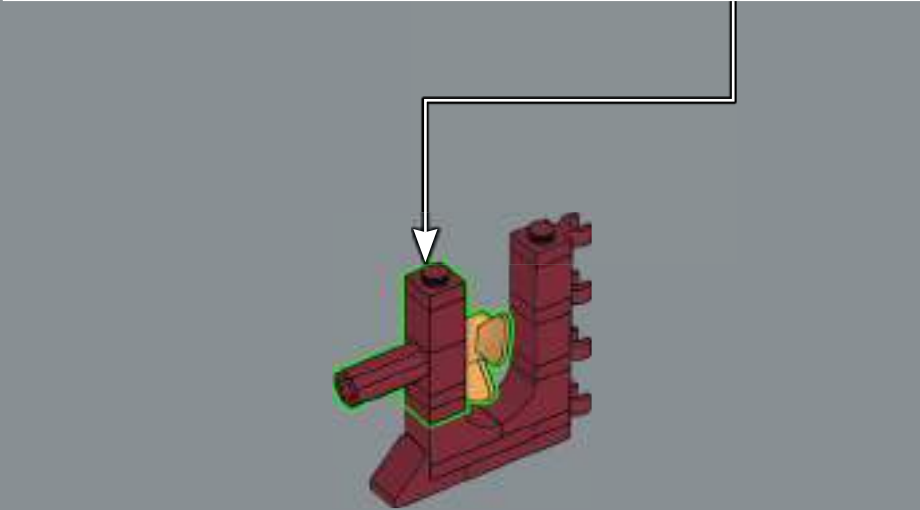
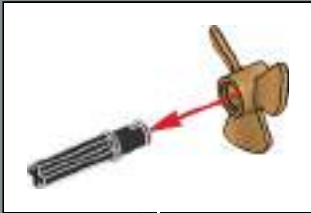
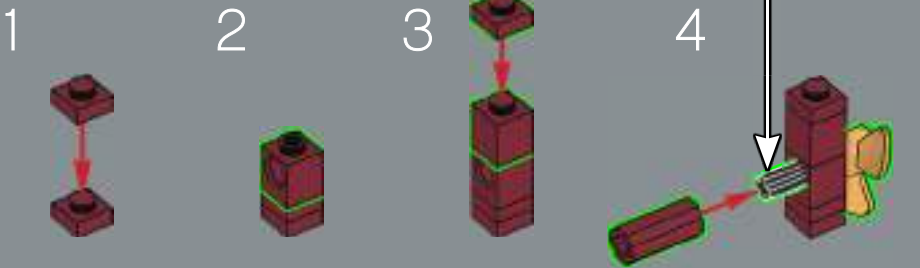

202

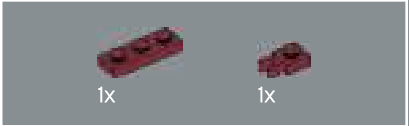
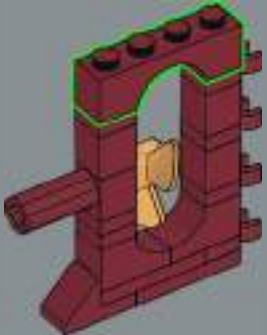

203

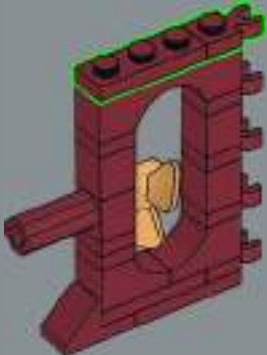

204

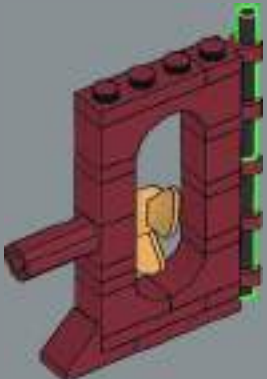

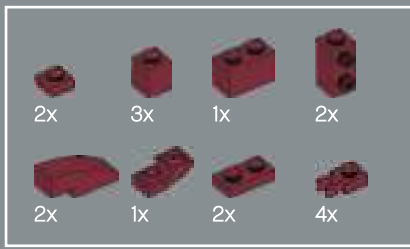

205

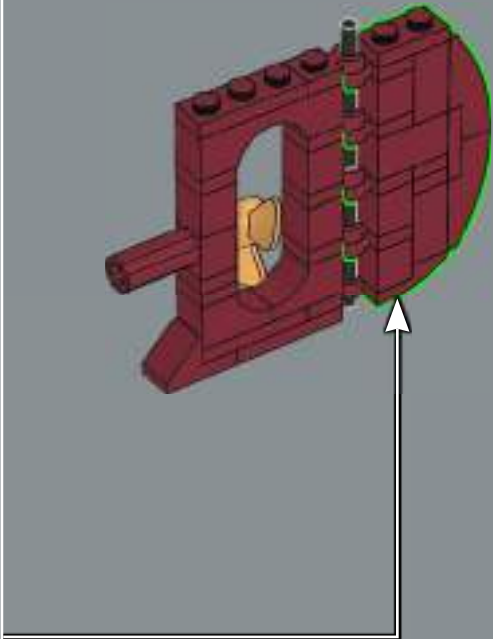
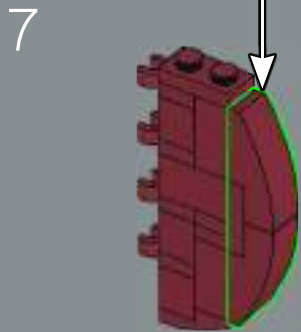
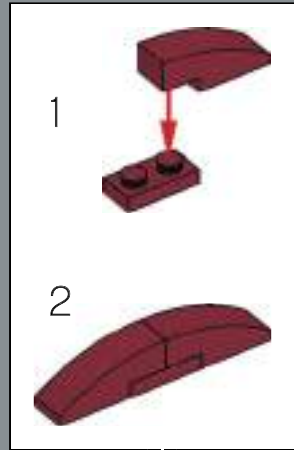
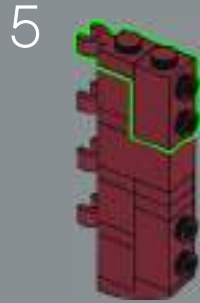
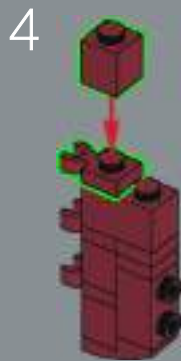
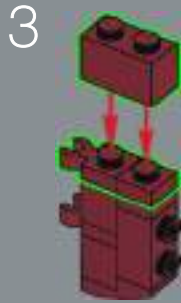
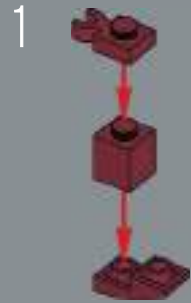



206

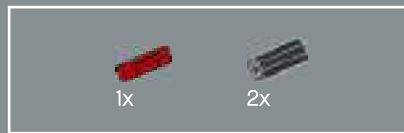
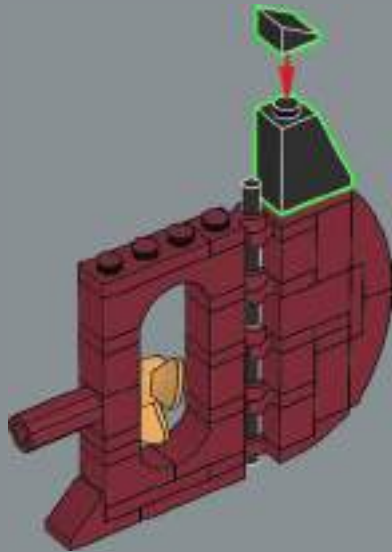

207

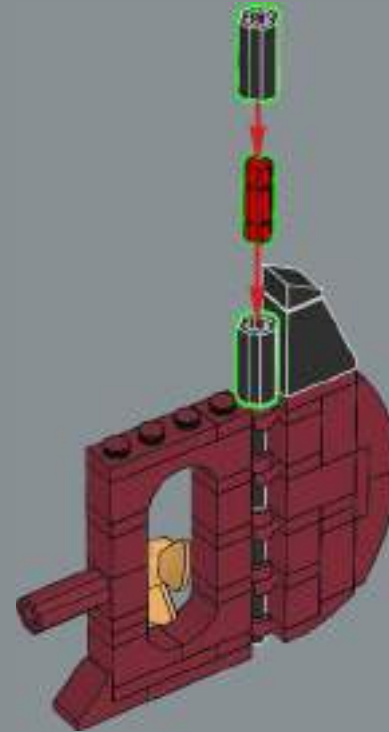

The ship's rudder was so large at 24 meters (78.8 ft.) high, 4.65 meters (15.3 ft.) long, and weighing over 100 tonnes (110.2 US tons), it required steering engines to move it.

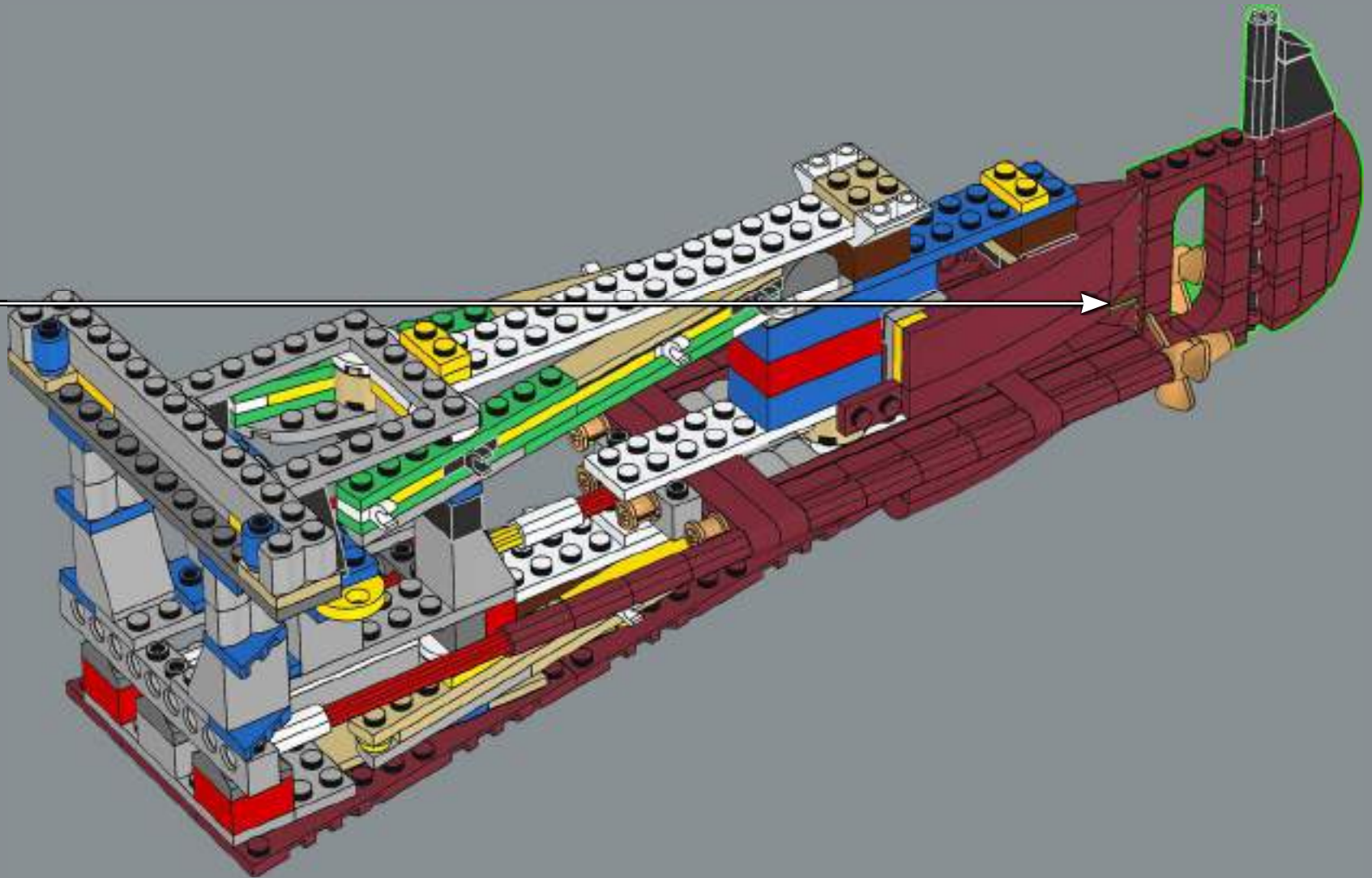

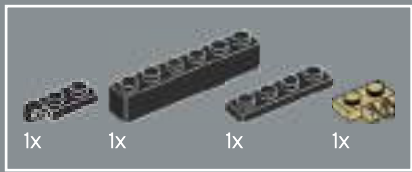

209

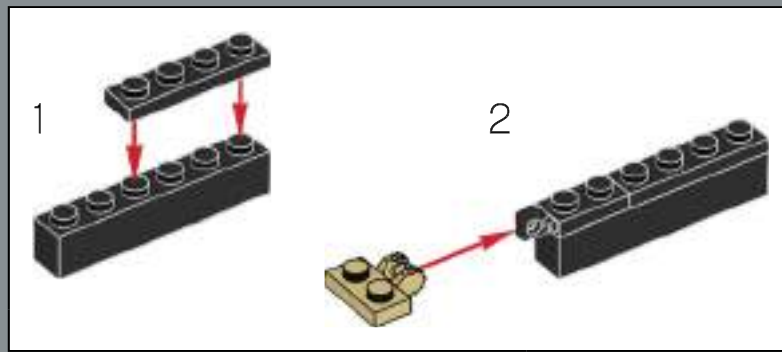



210

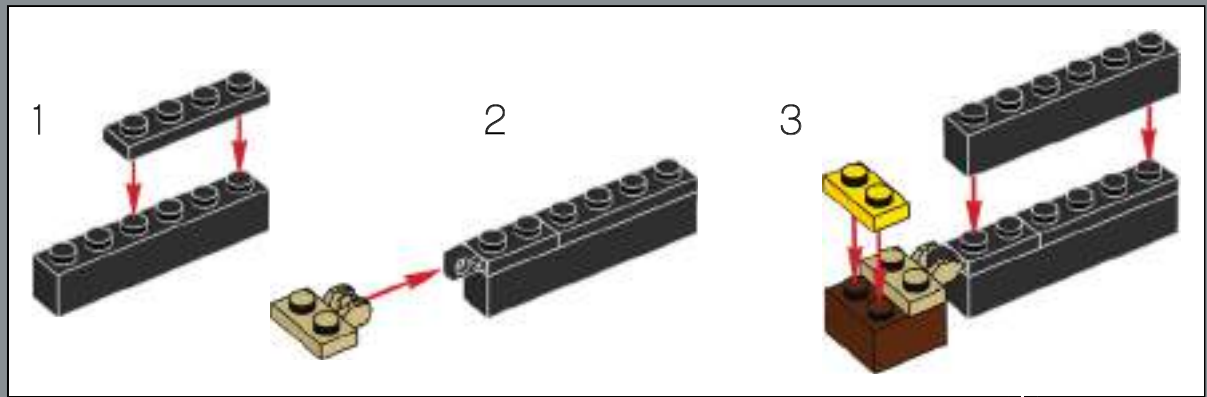

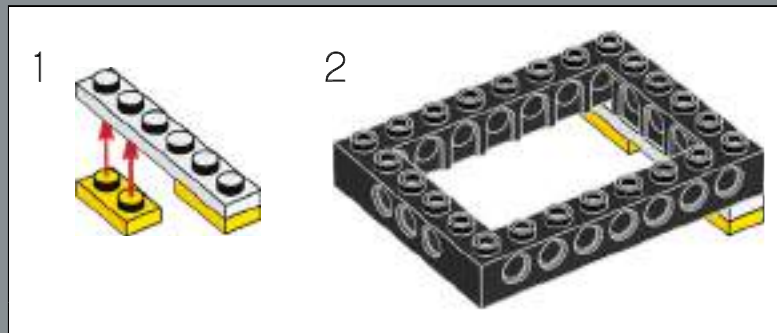
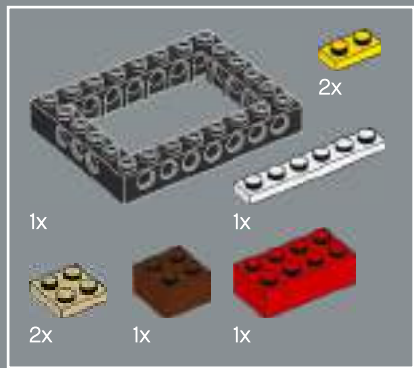

211



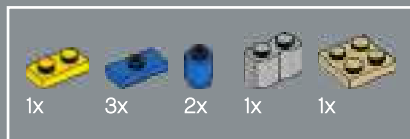

212

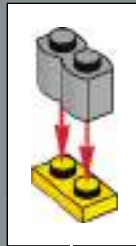

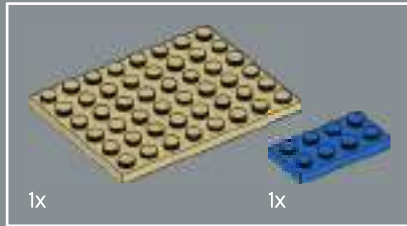
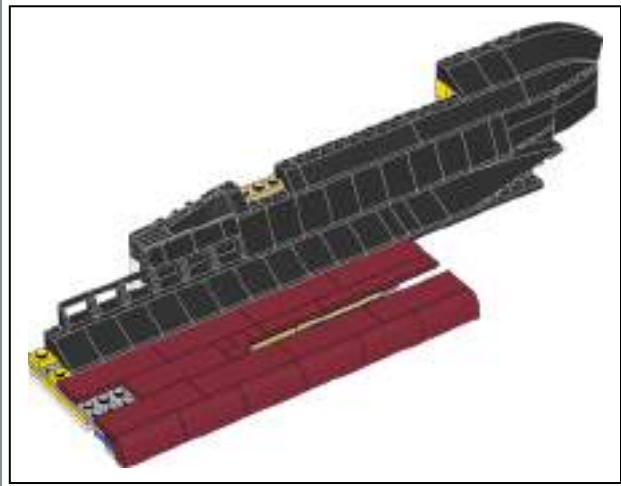
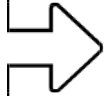

213

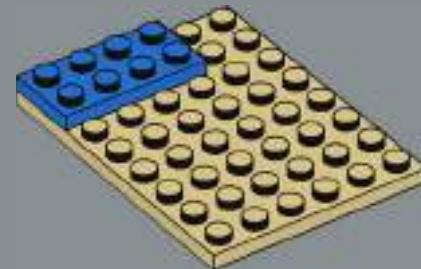

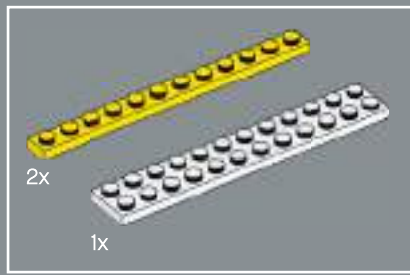

214

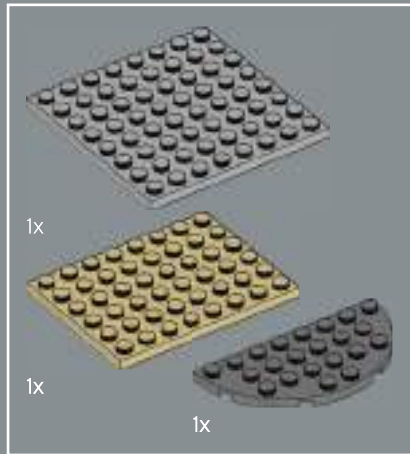
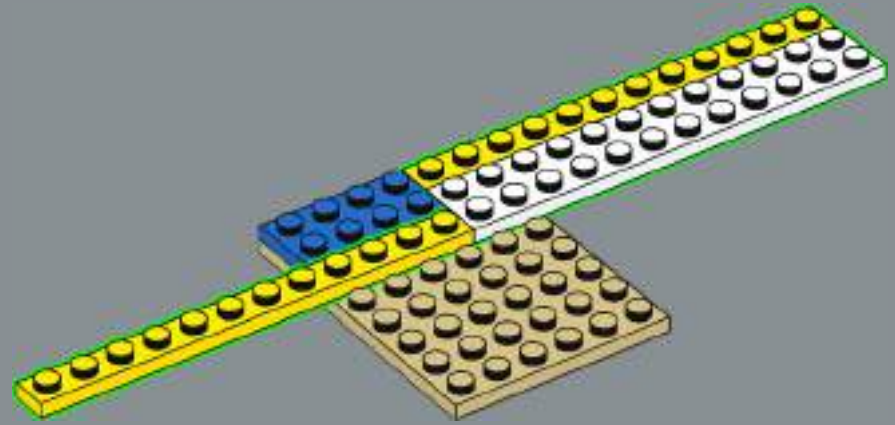

215

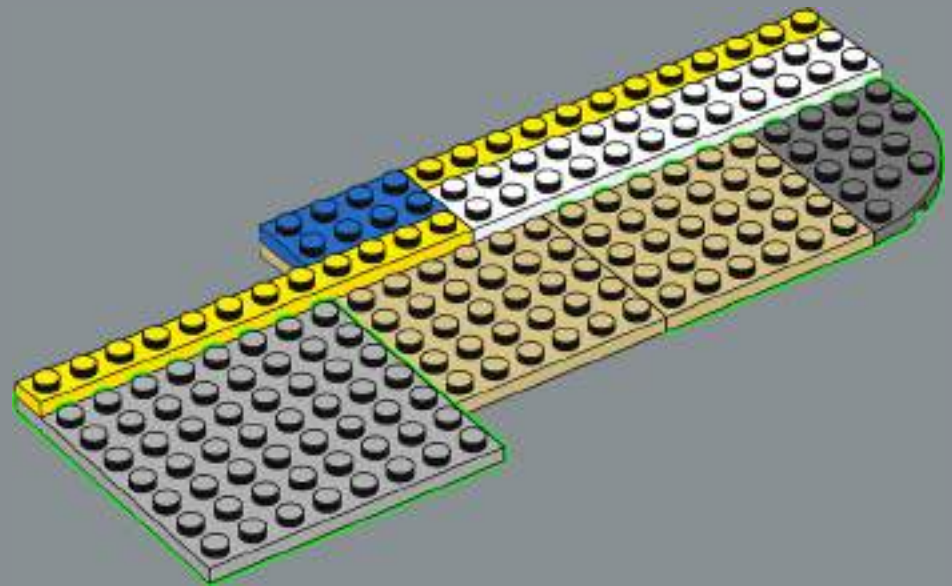

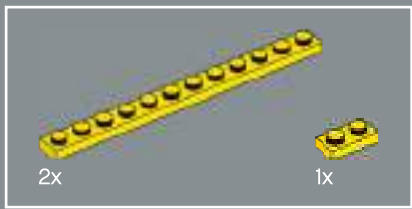

216

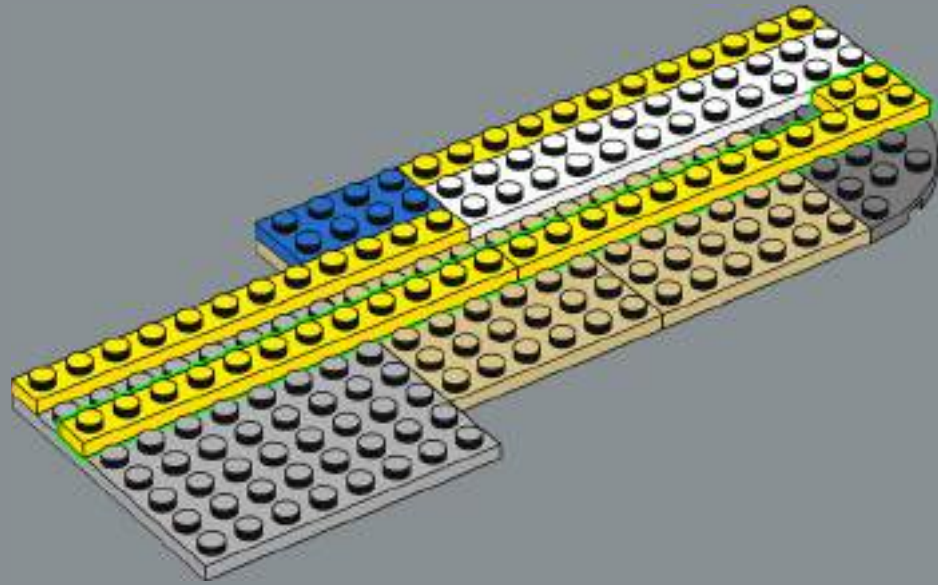

217

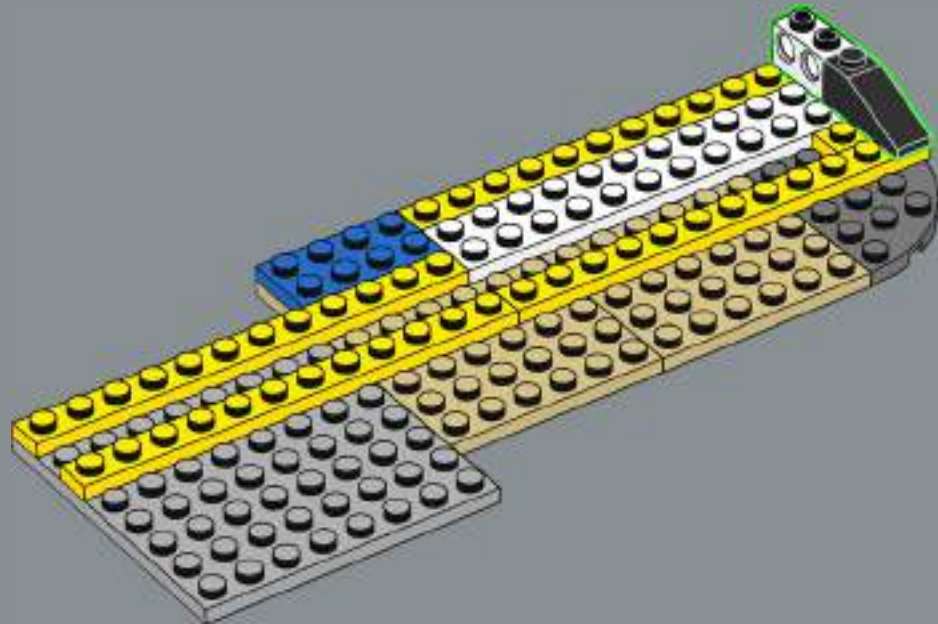



218

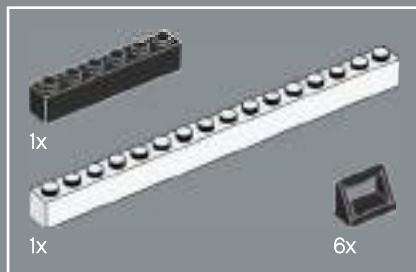
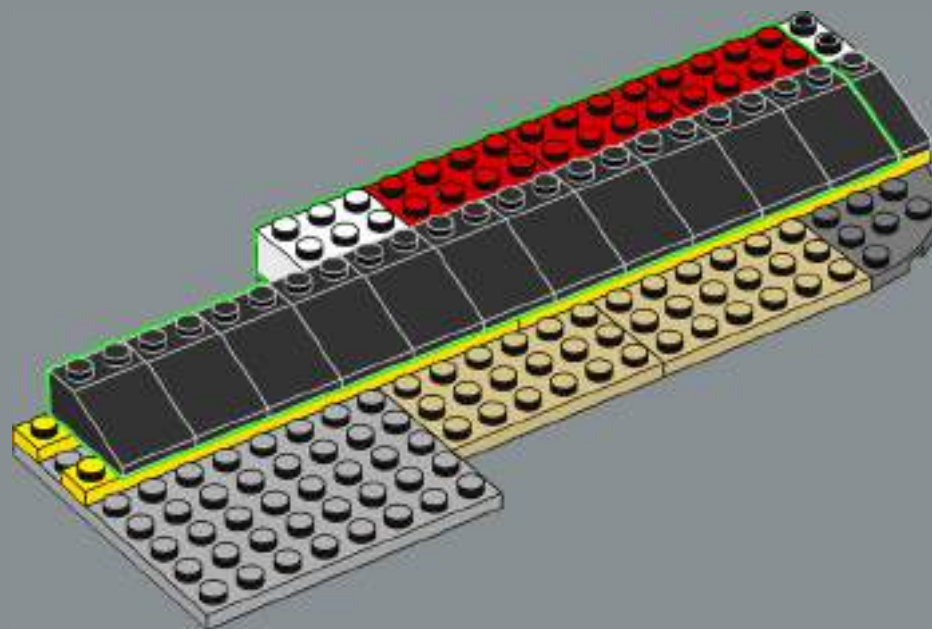

219

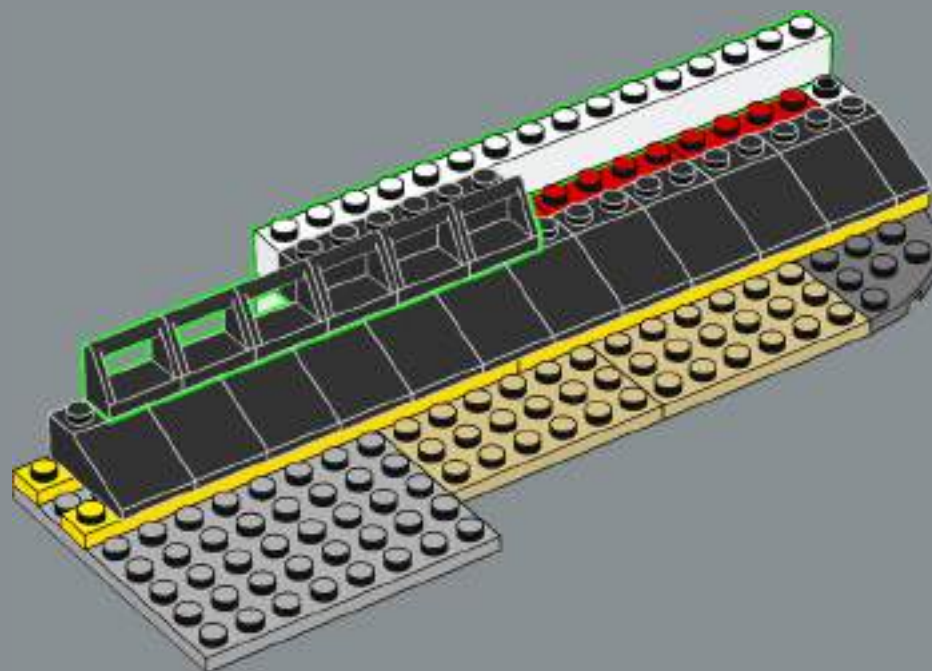

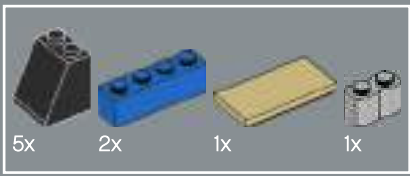

220

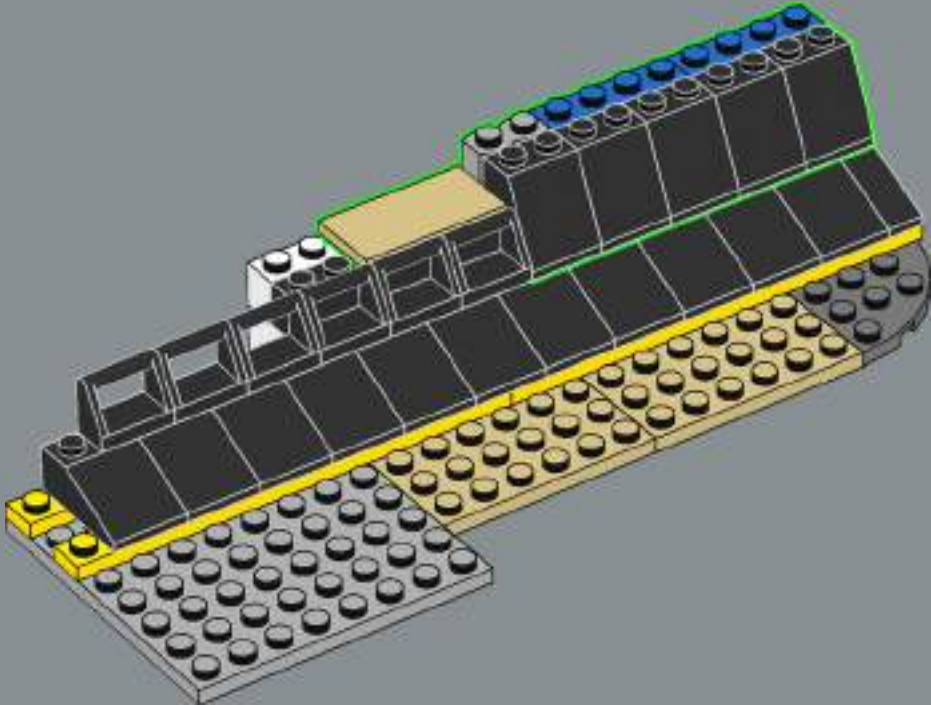

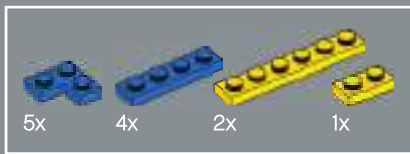

221

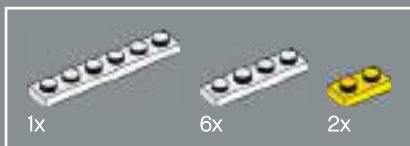
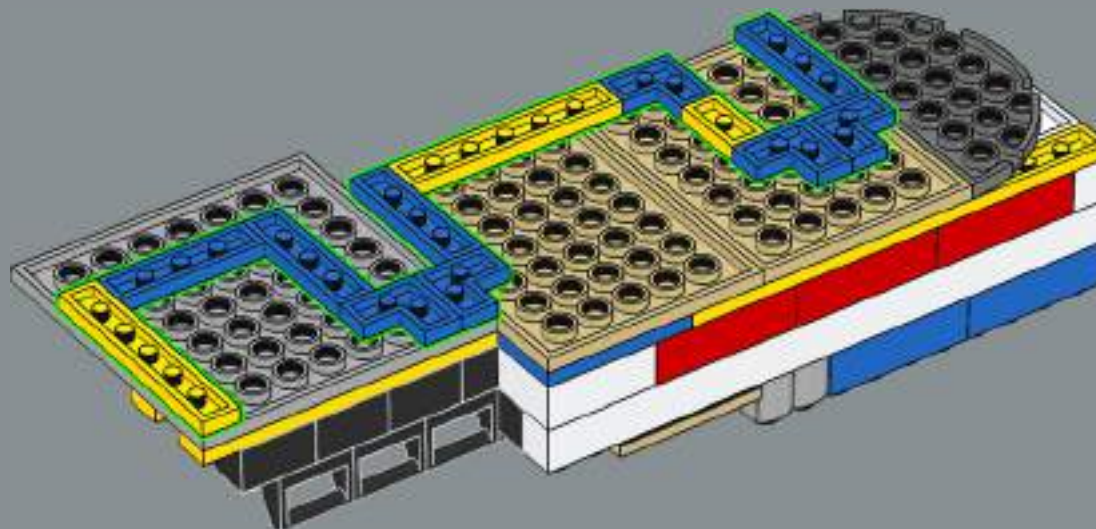

222

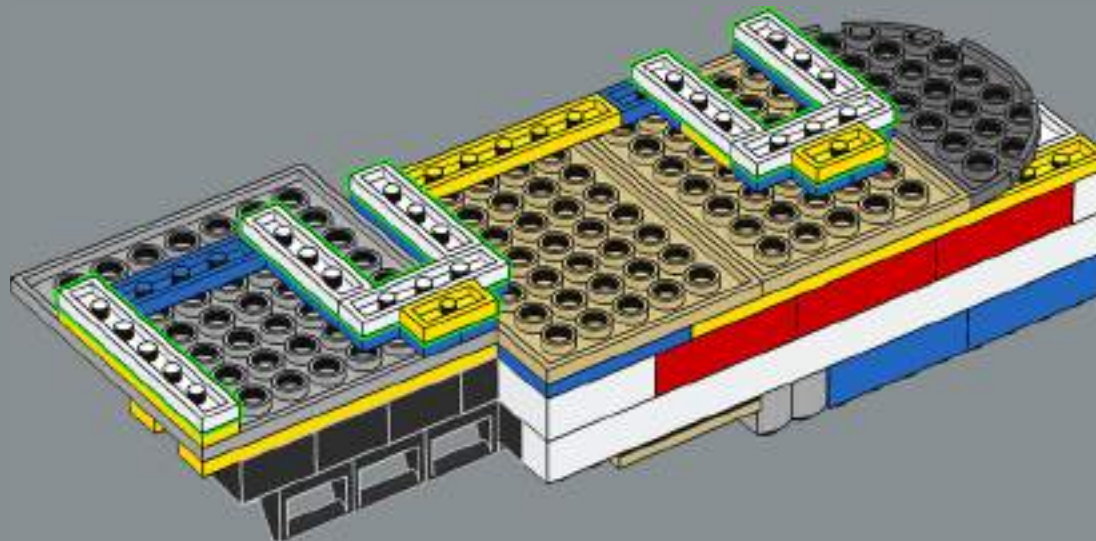

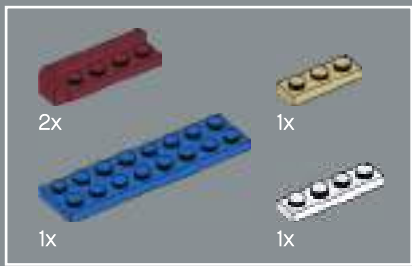

223

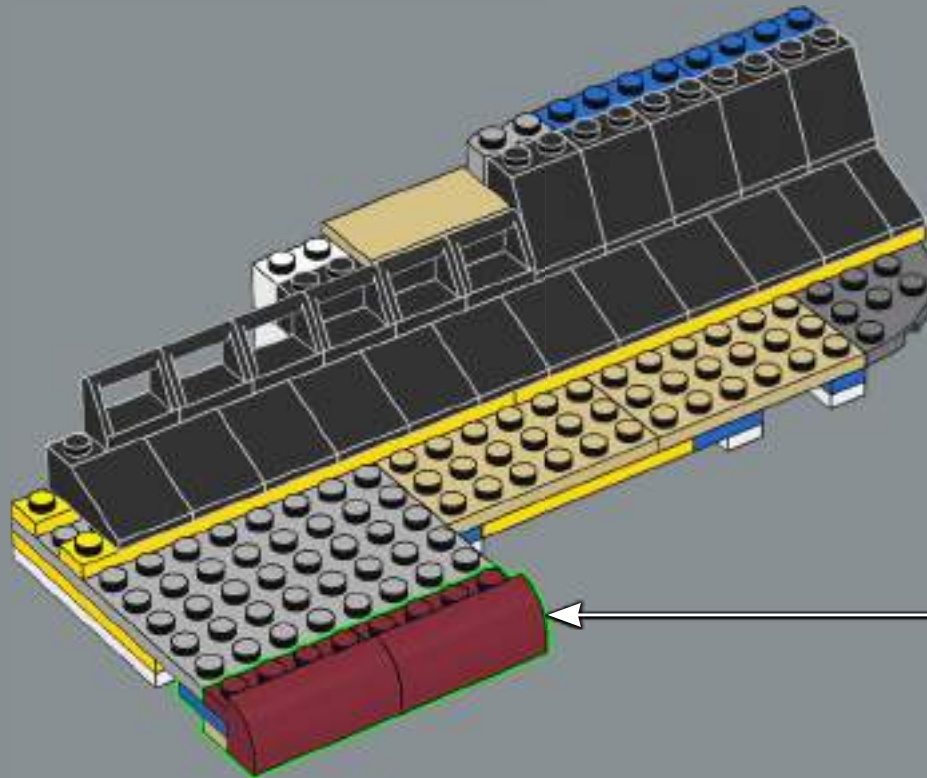
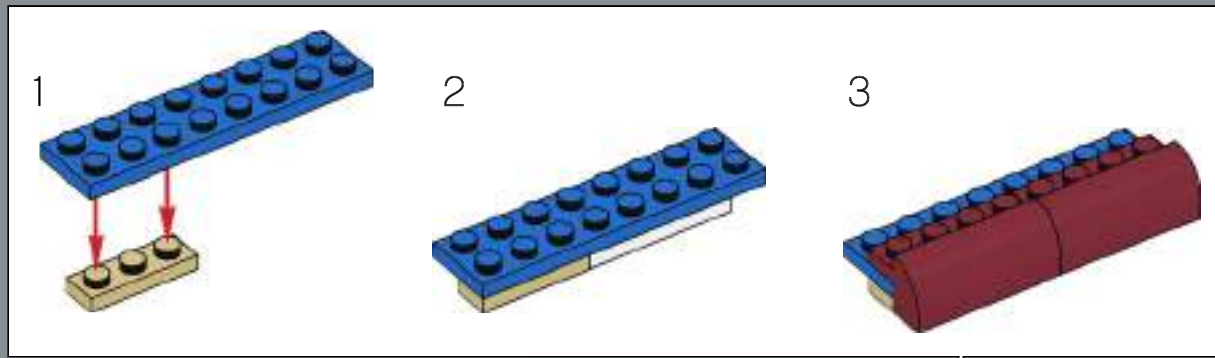

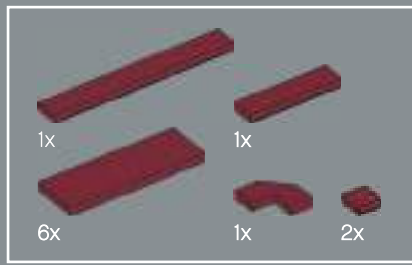

224

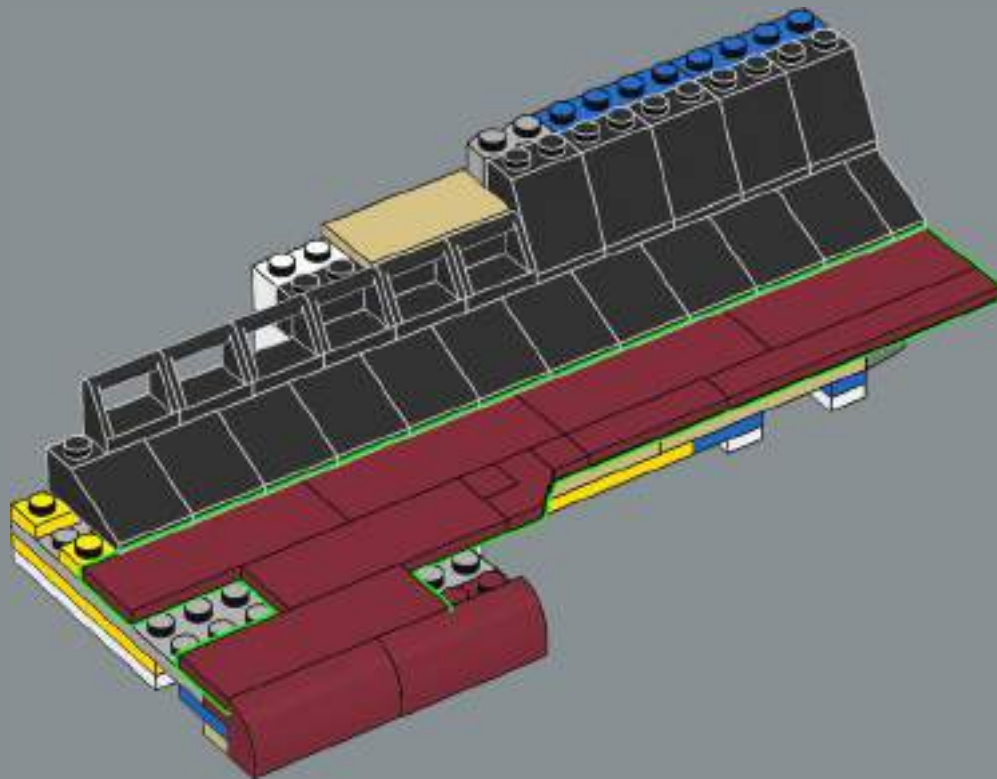

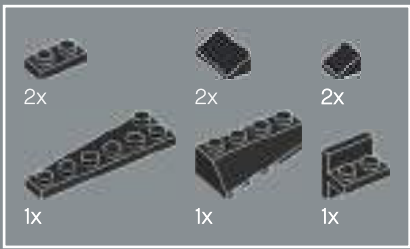

225

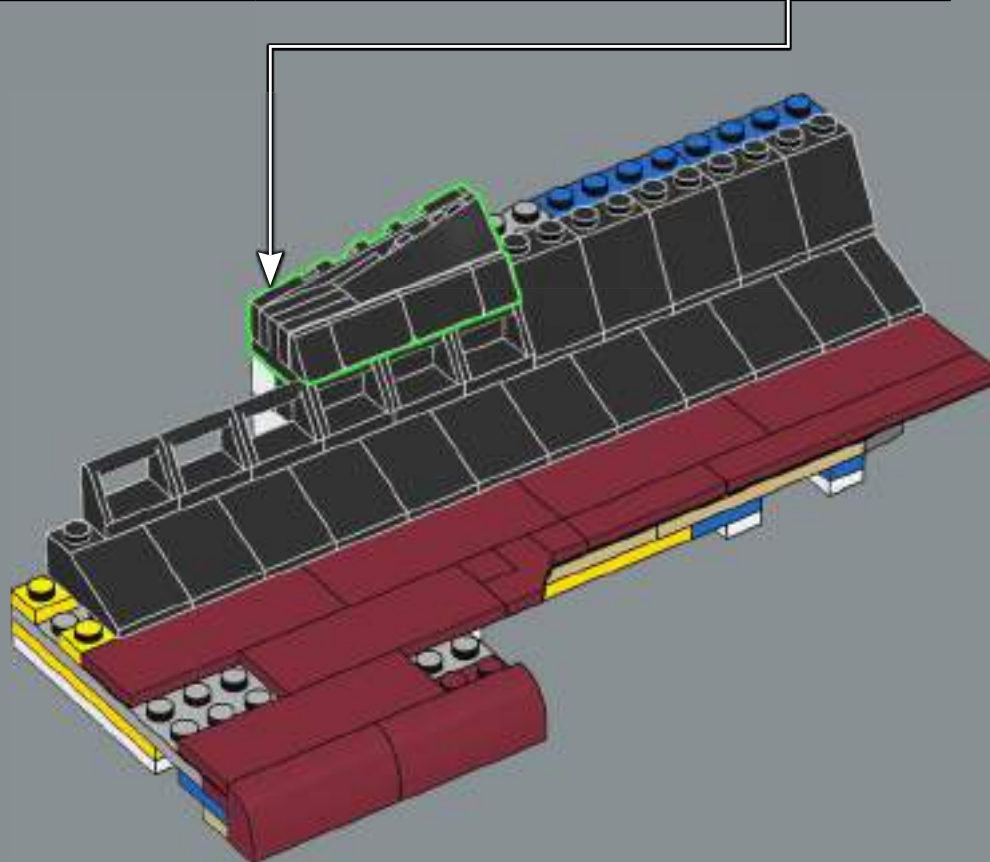
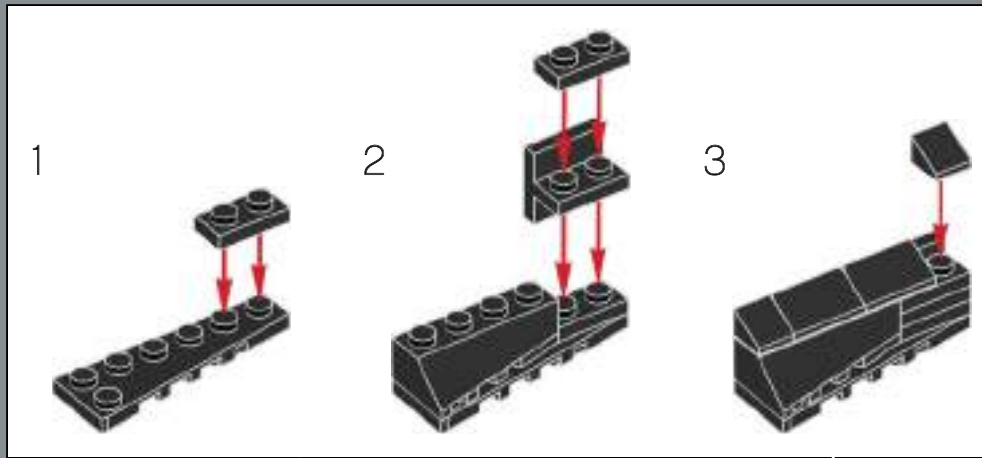

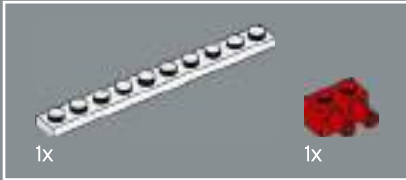
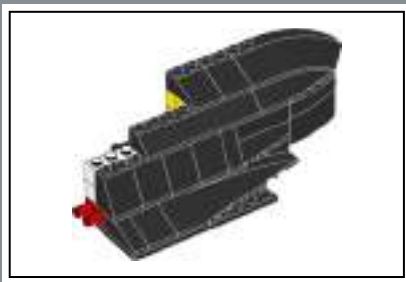

226

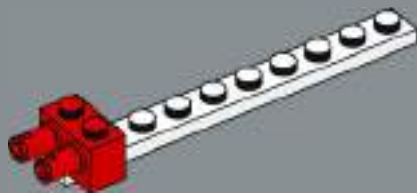

227

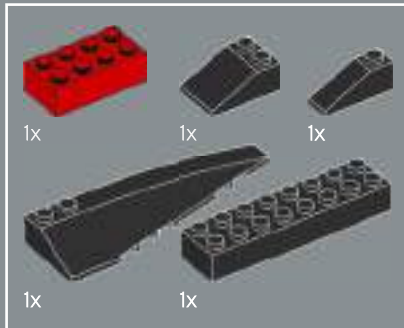
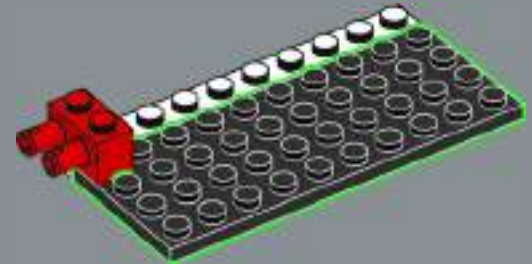

228

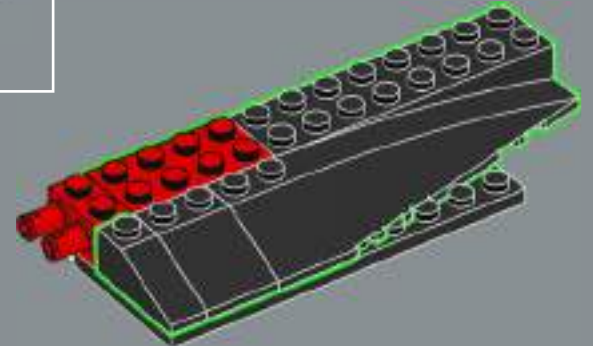



229

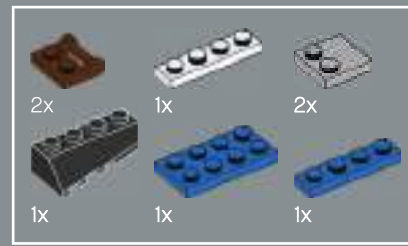
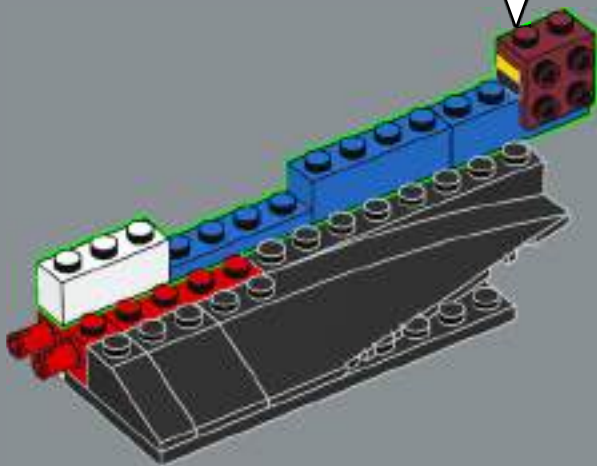
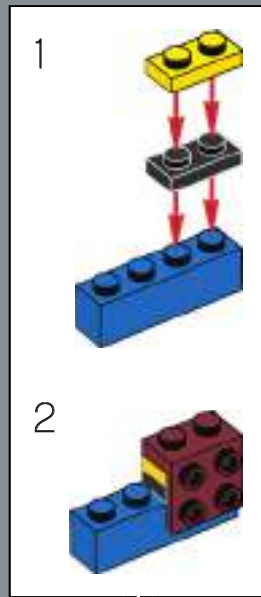

230

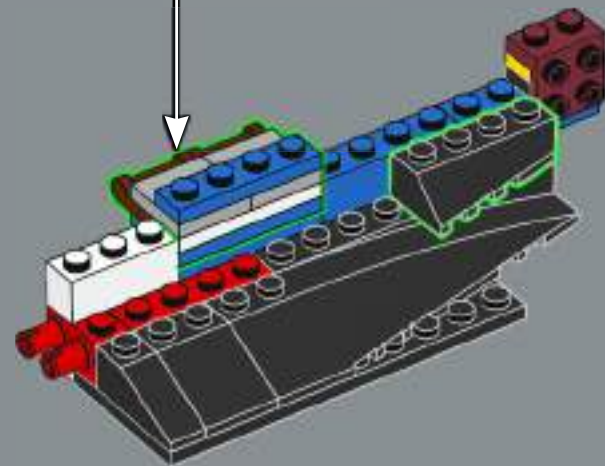
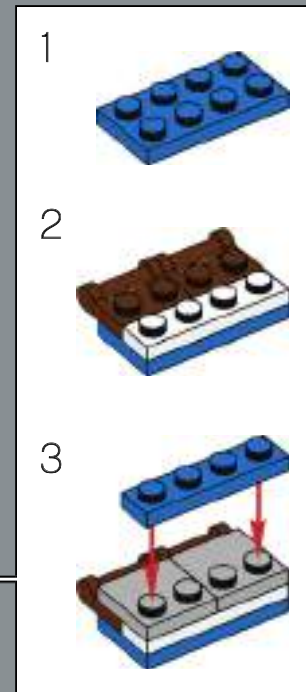

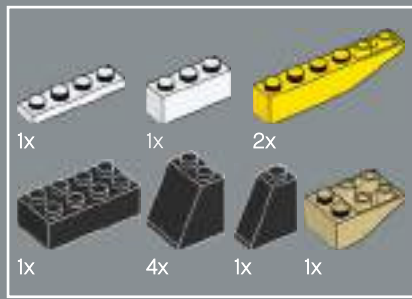

231

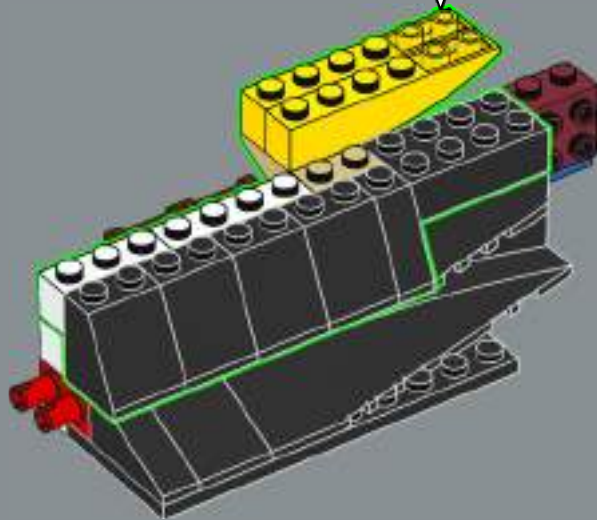
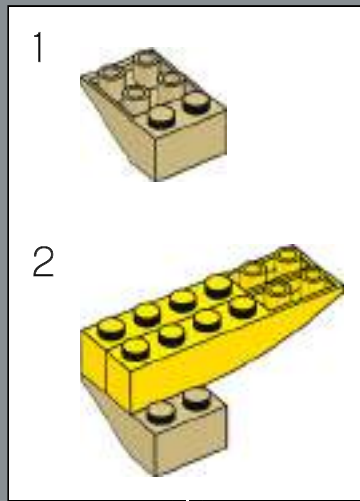

232

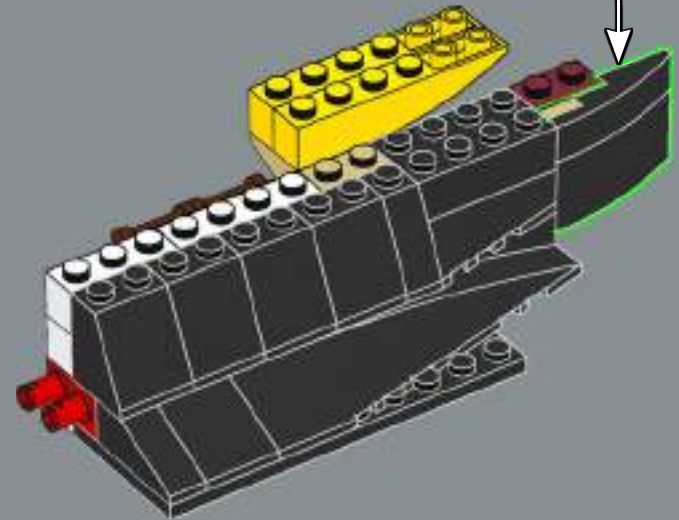

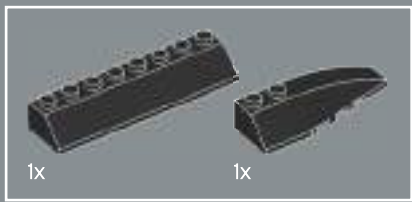

233

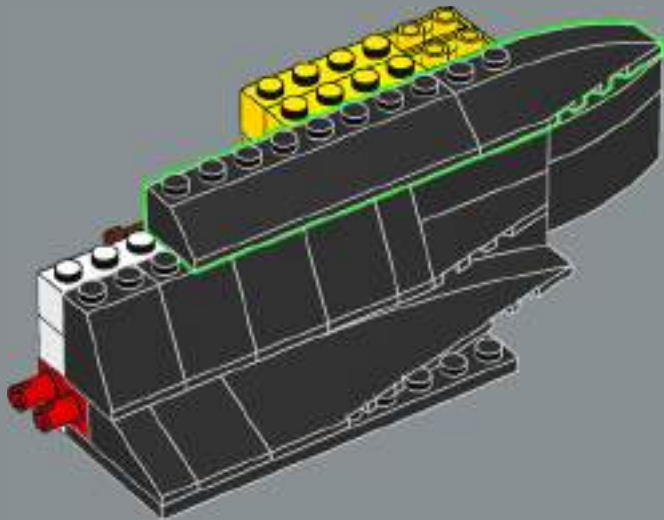

234

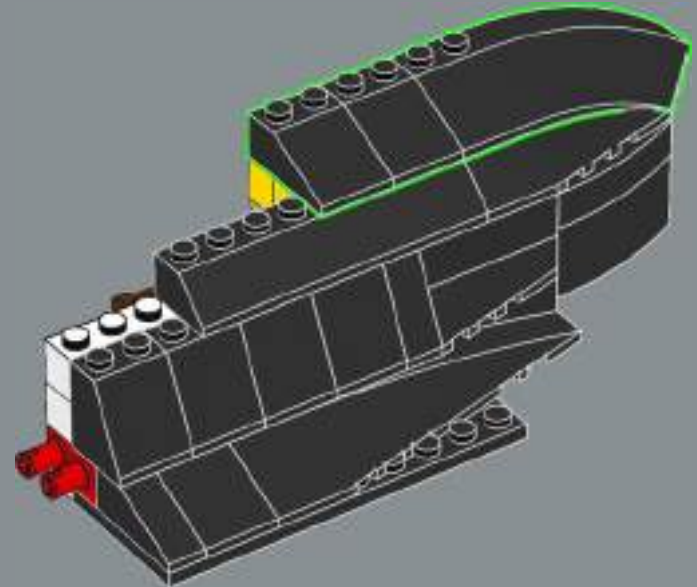

235

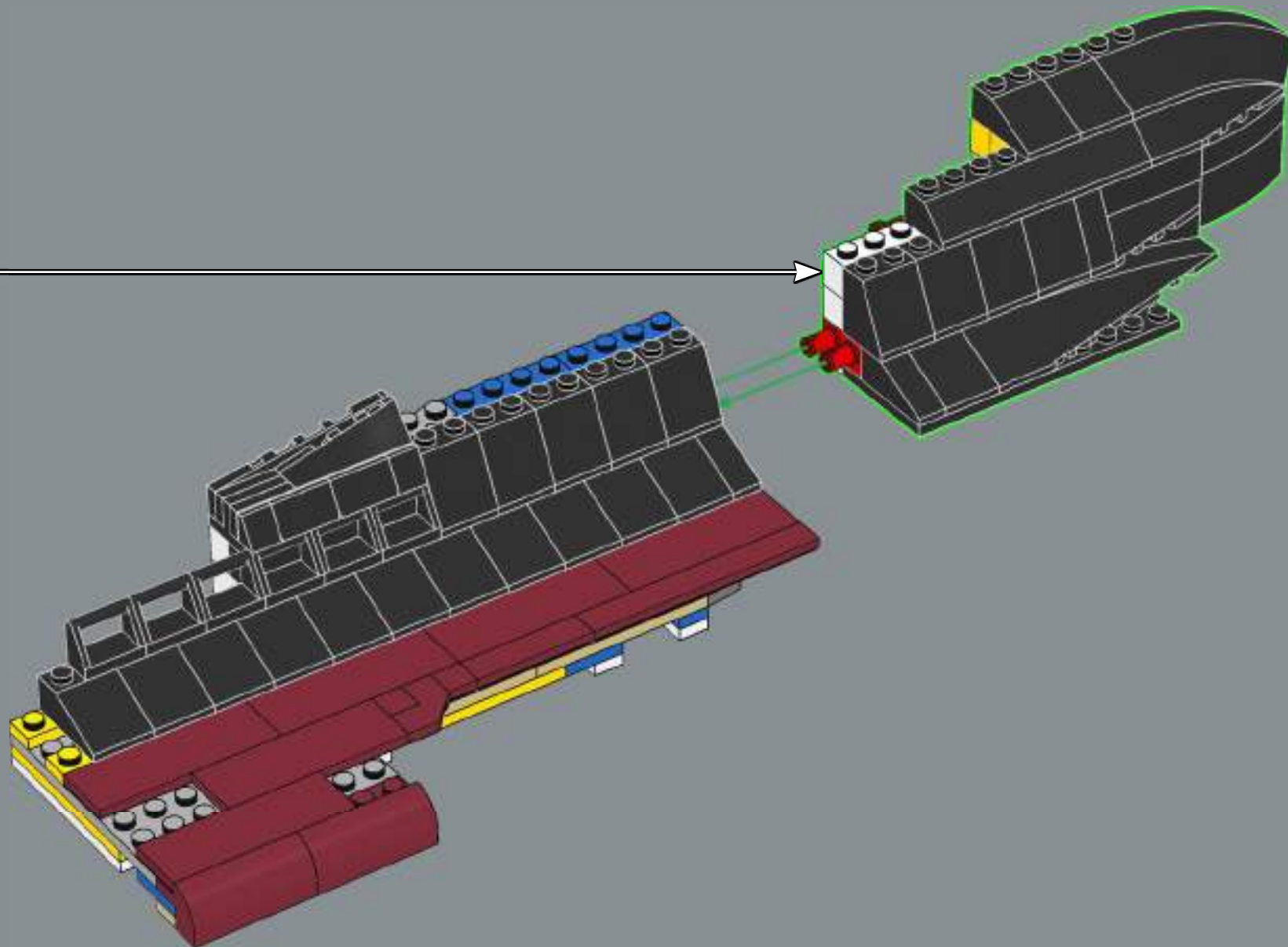

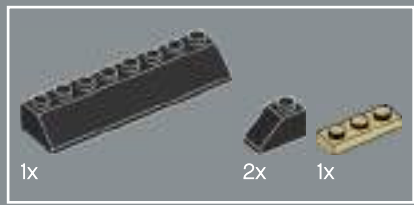

236

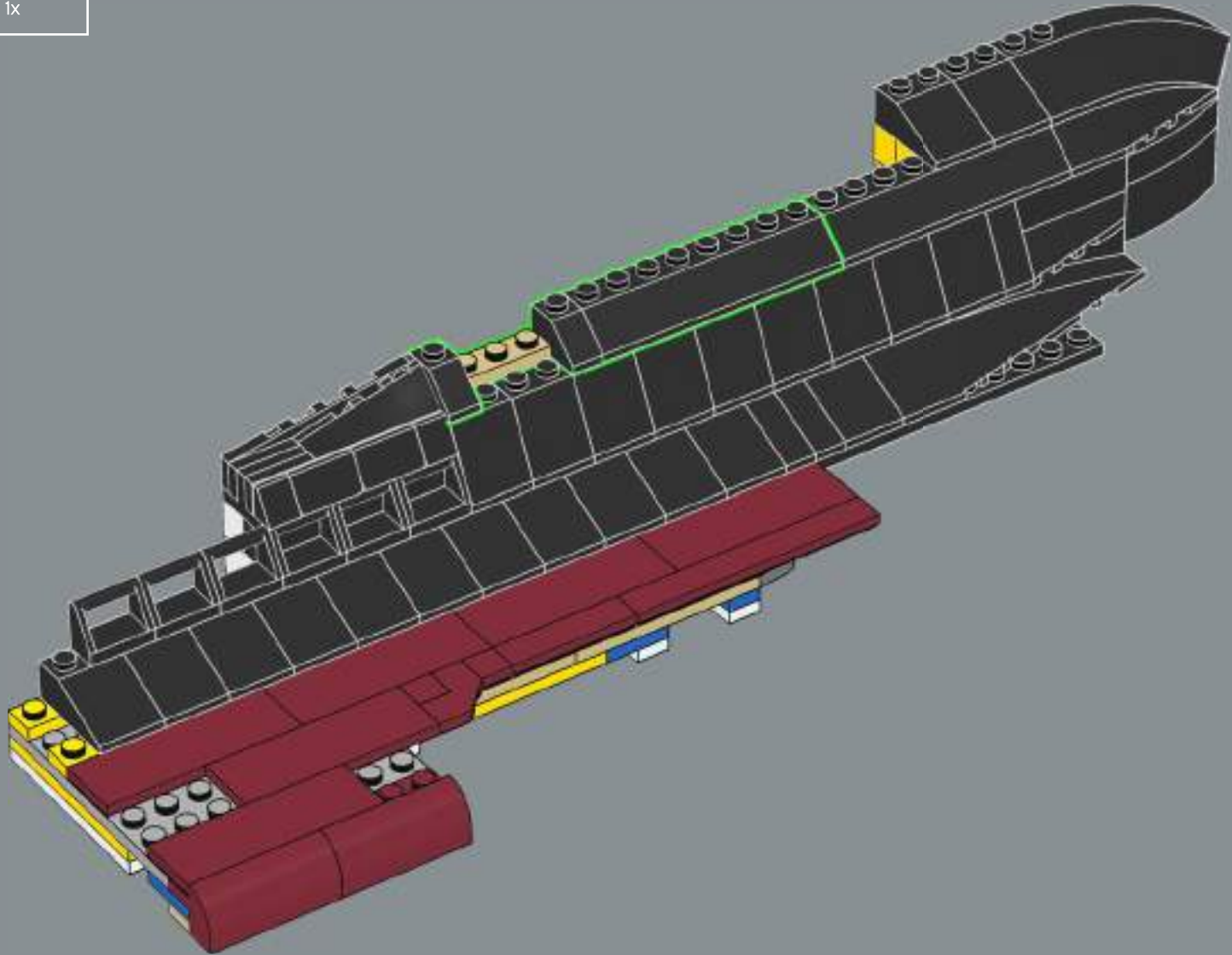

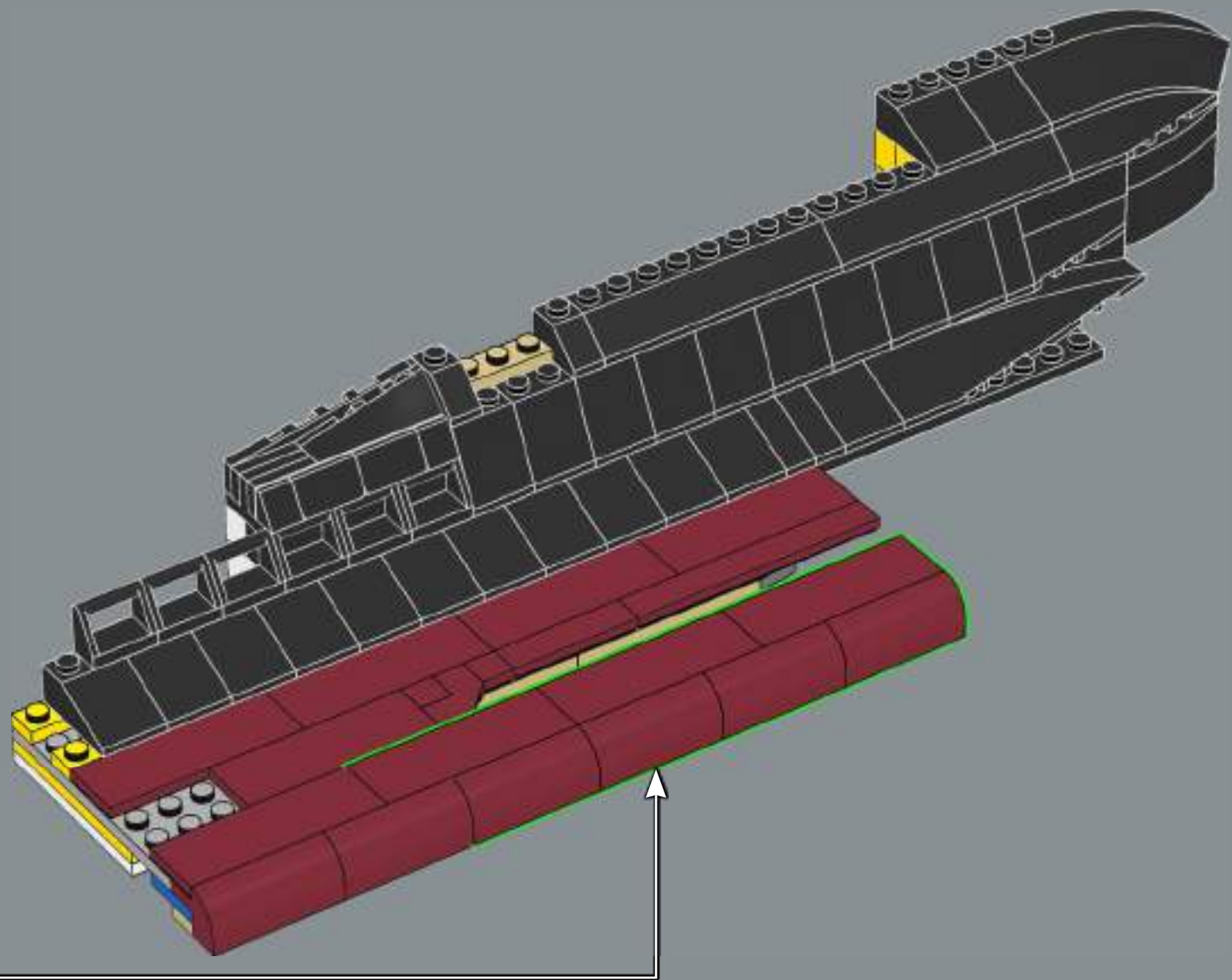



238

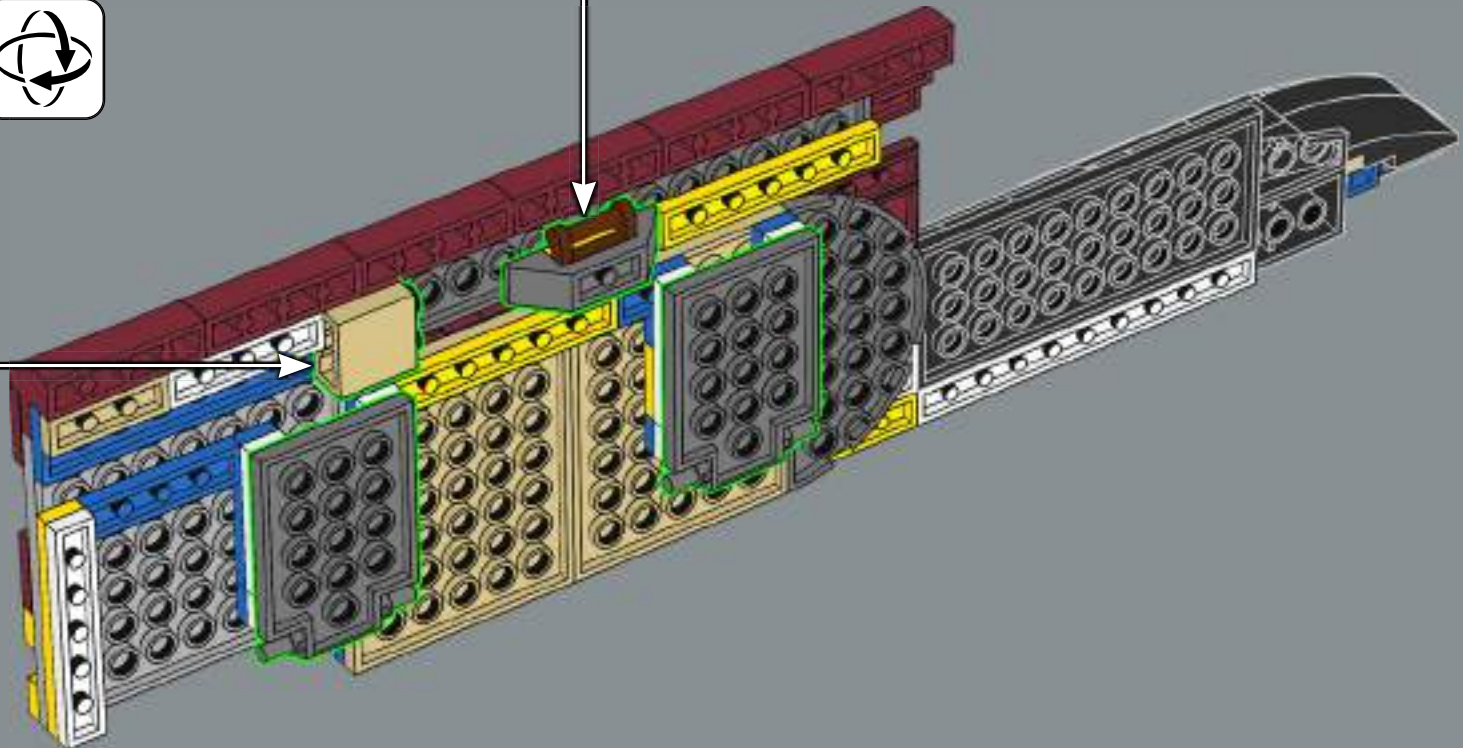
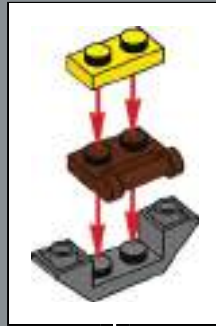

239



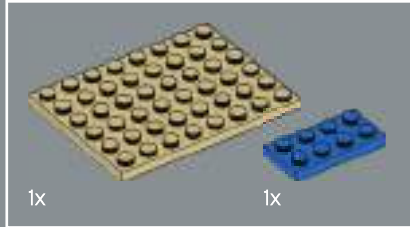
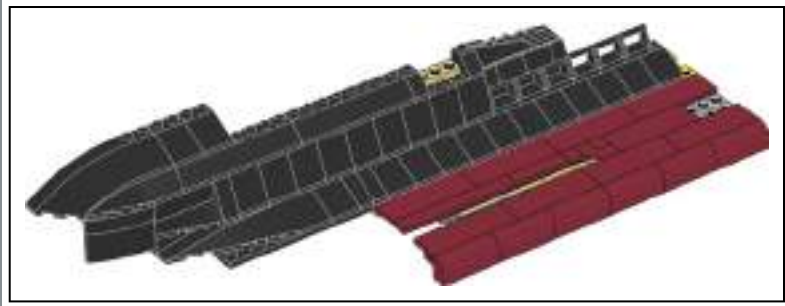
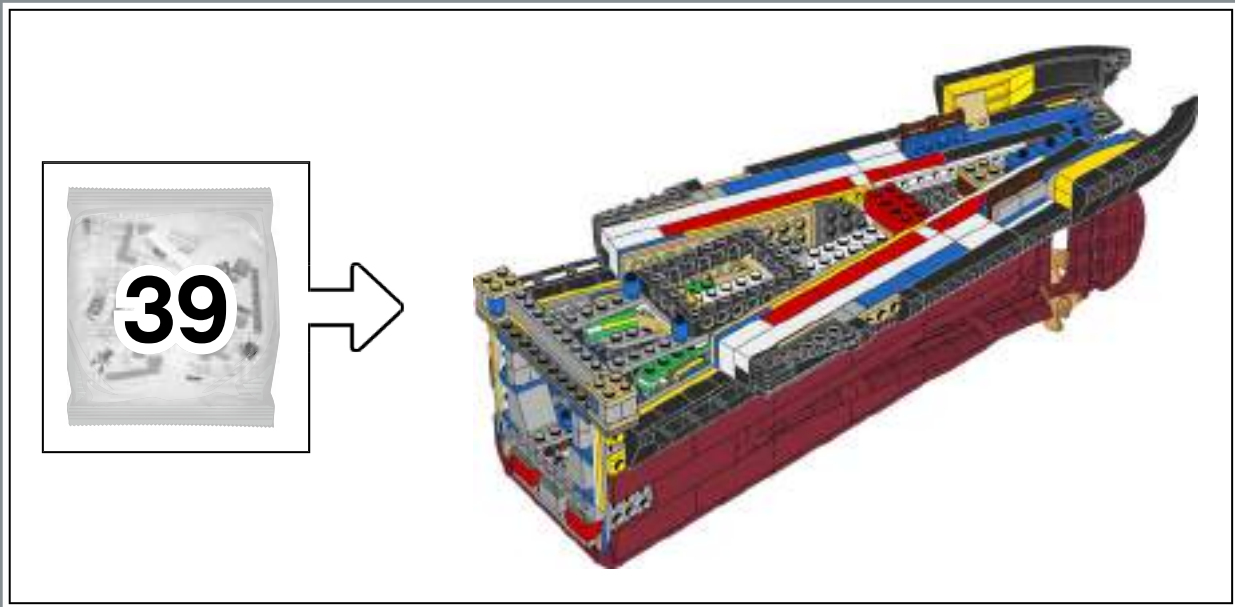

240

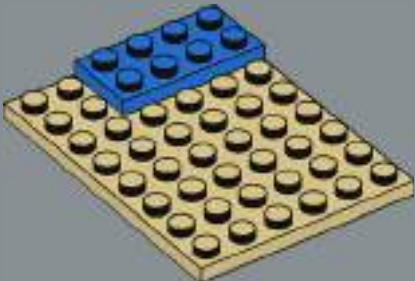

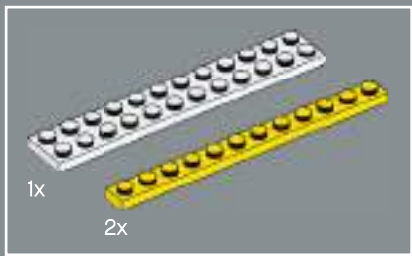

241

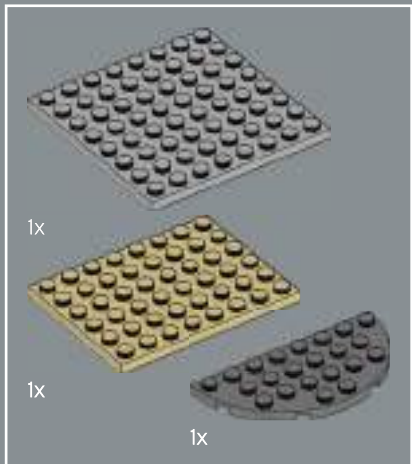
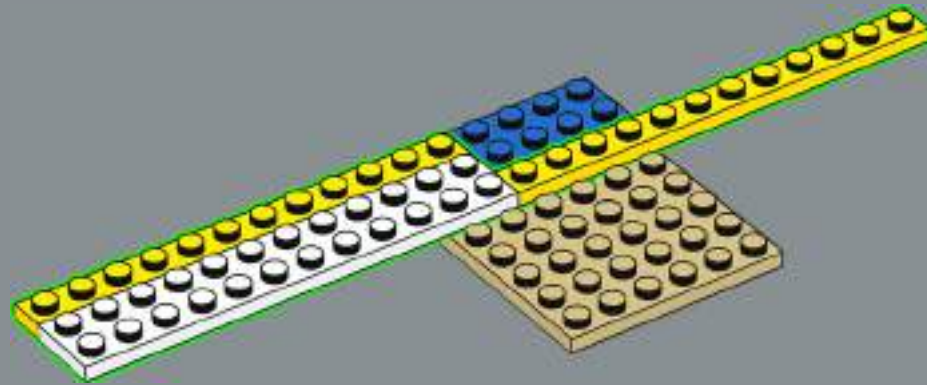

242

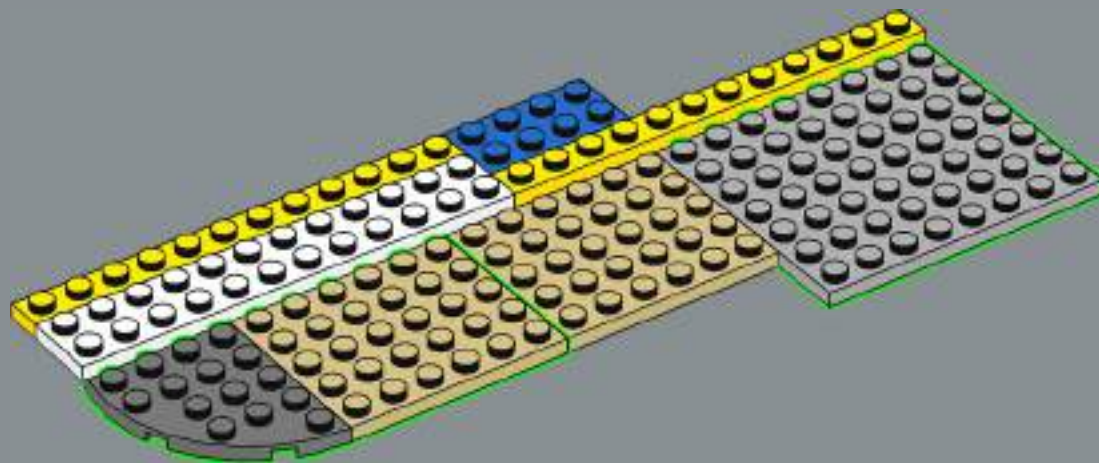

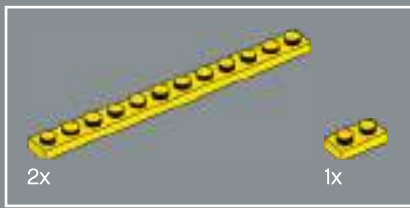

243

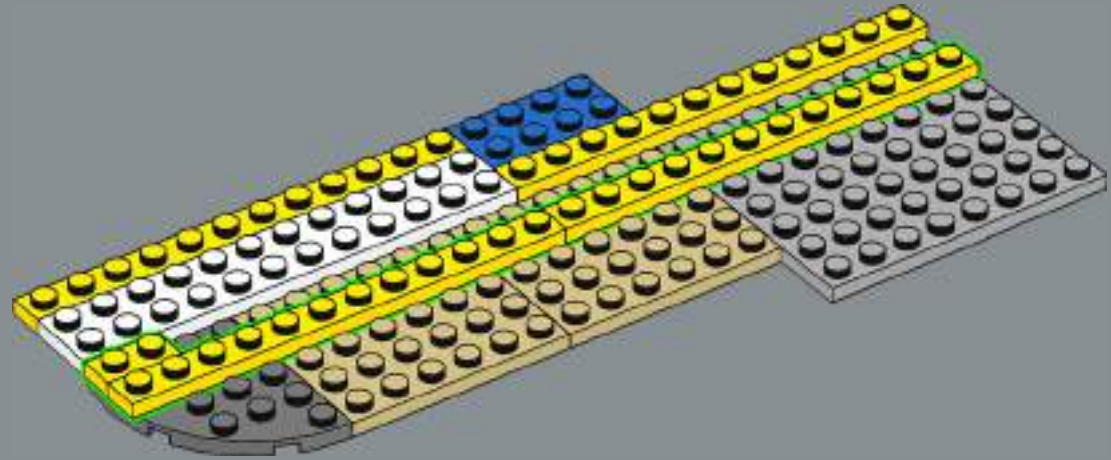

244

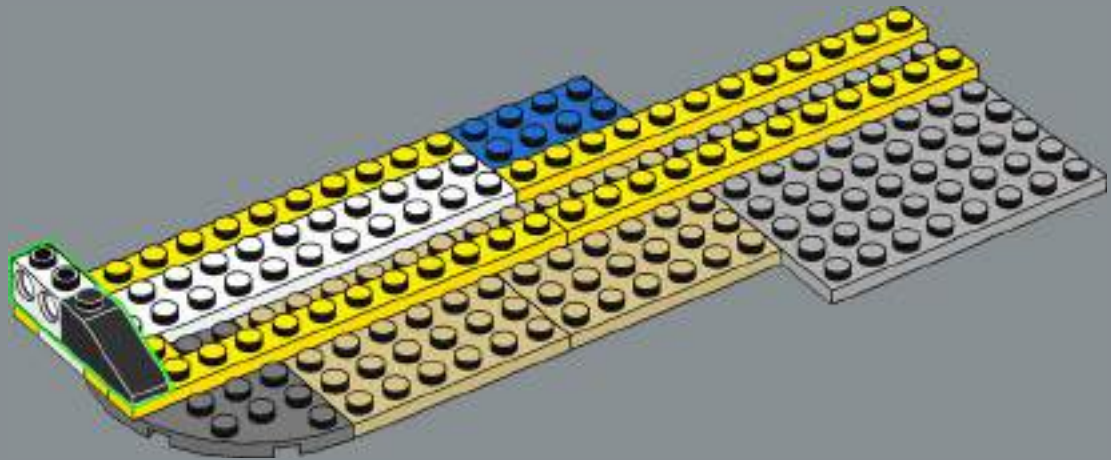

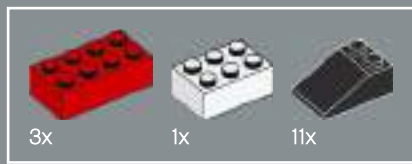

245

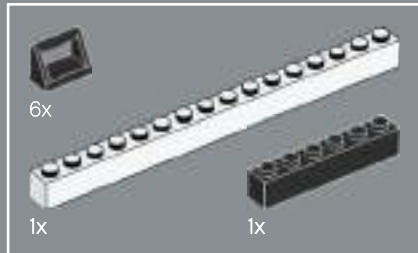
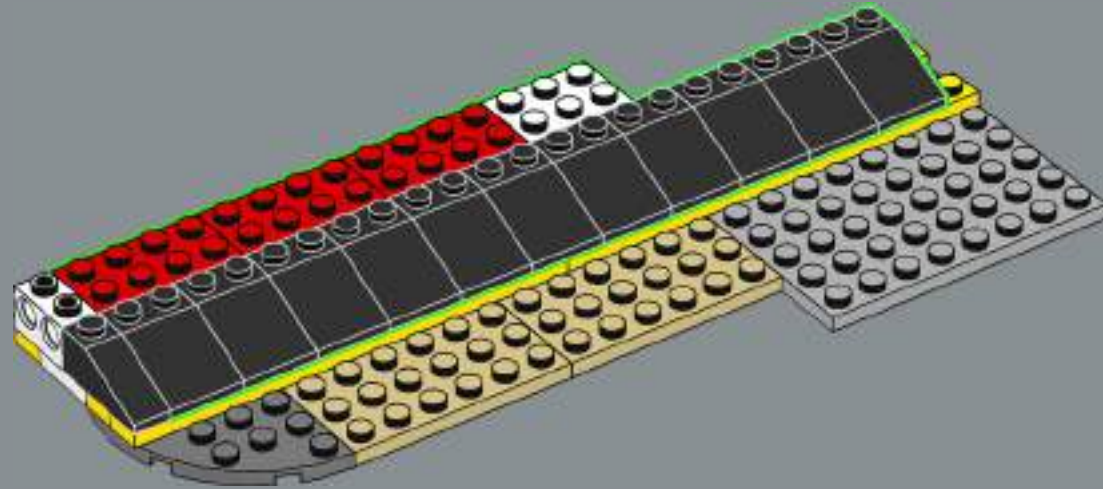

246

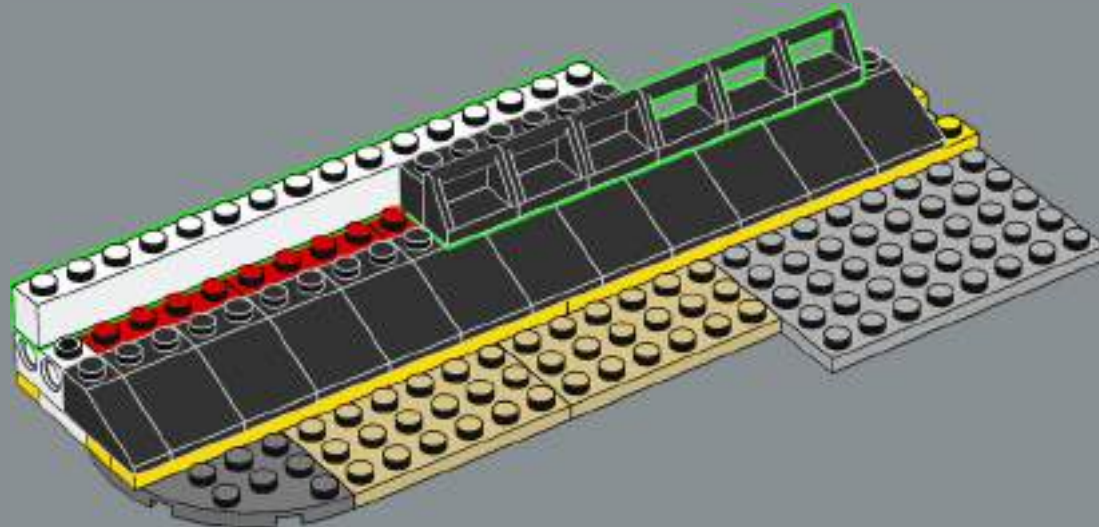

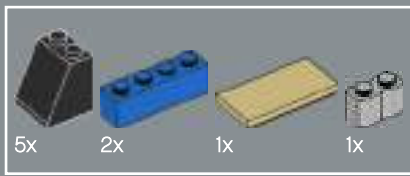

247

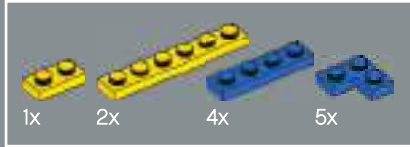
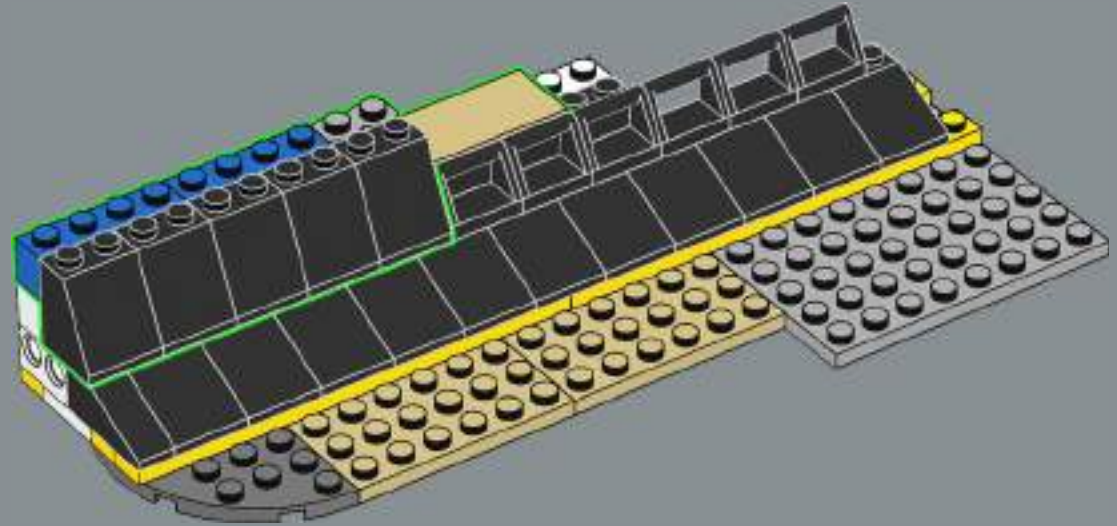

248

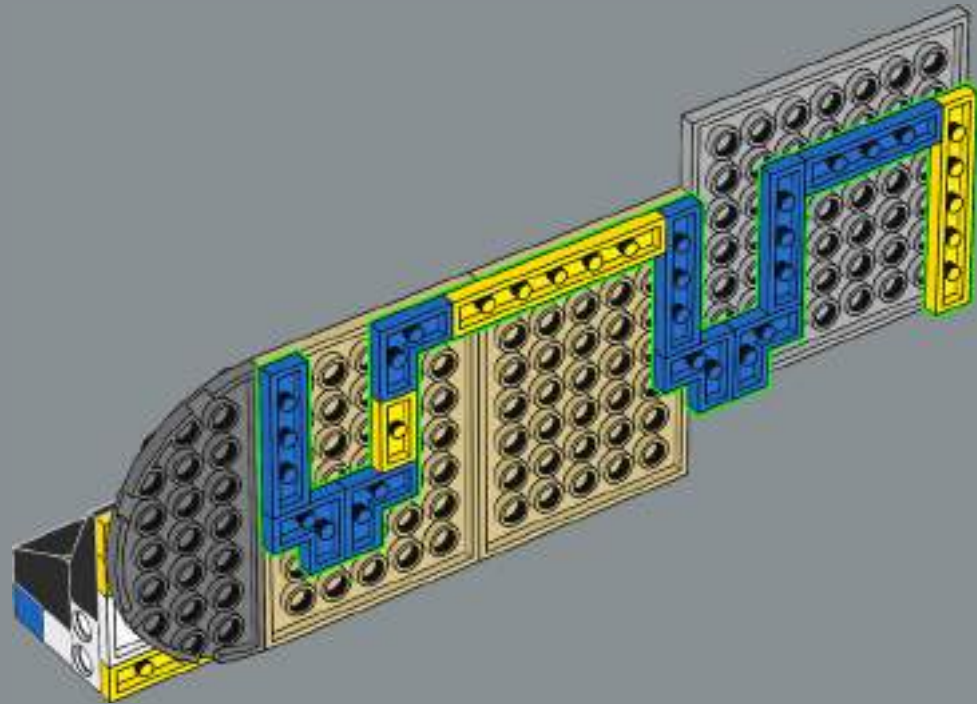

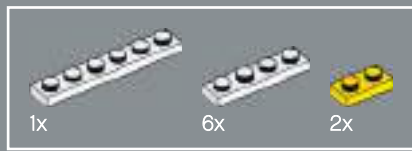

249

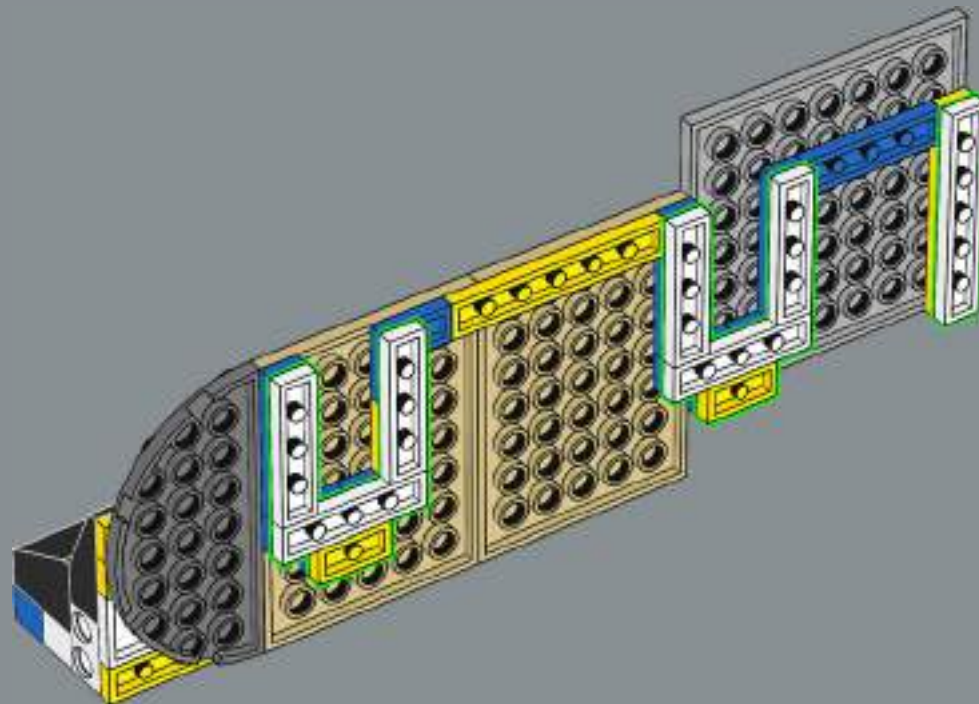

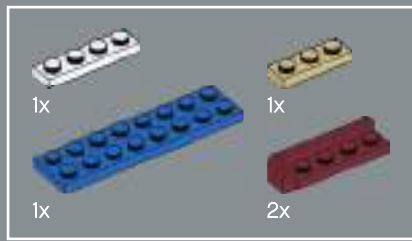

250

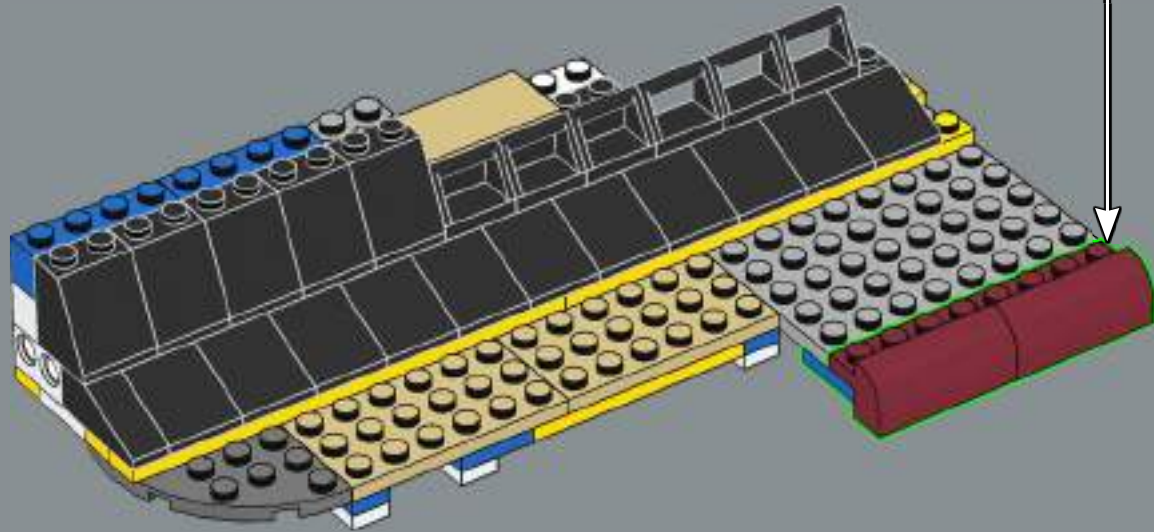
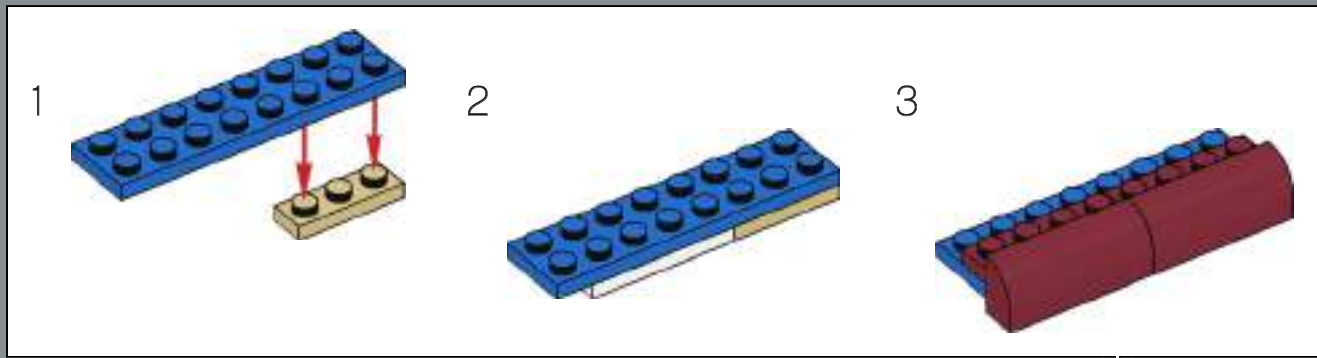

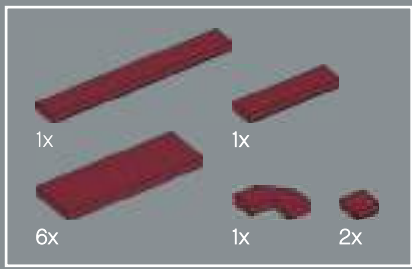

251

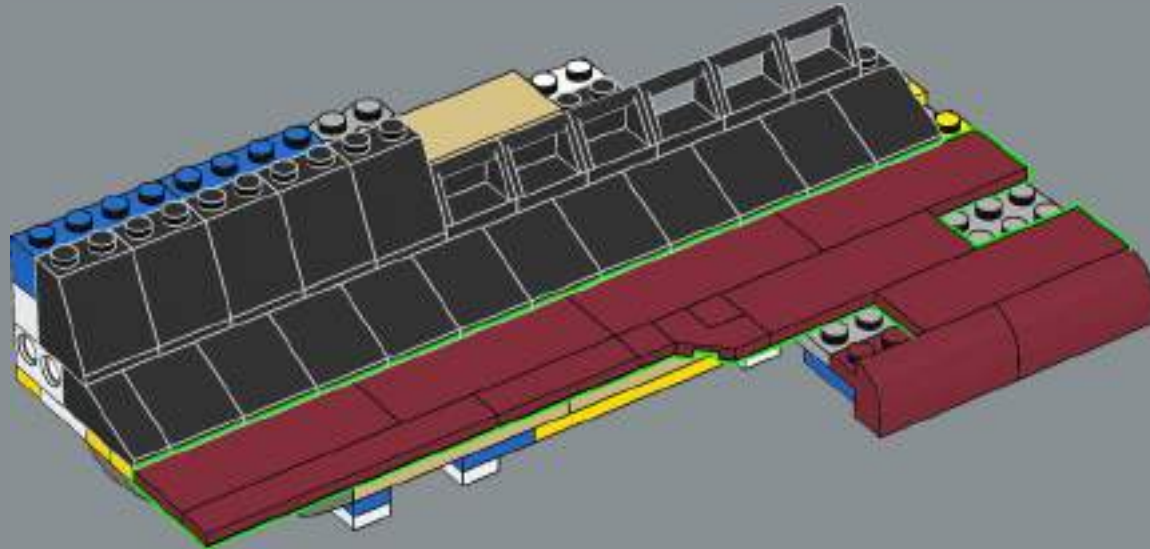

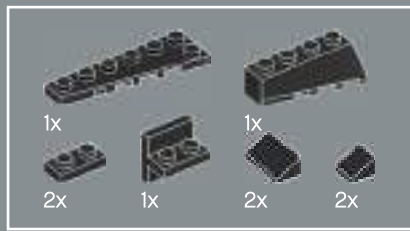

252

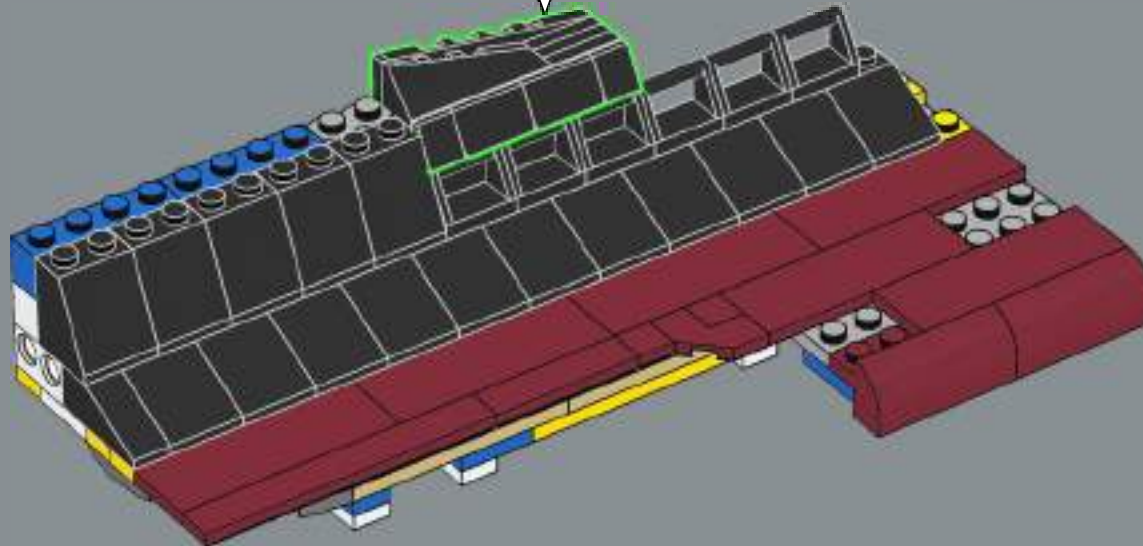
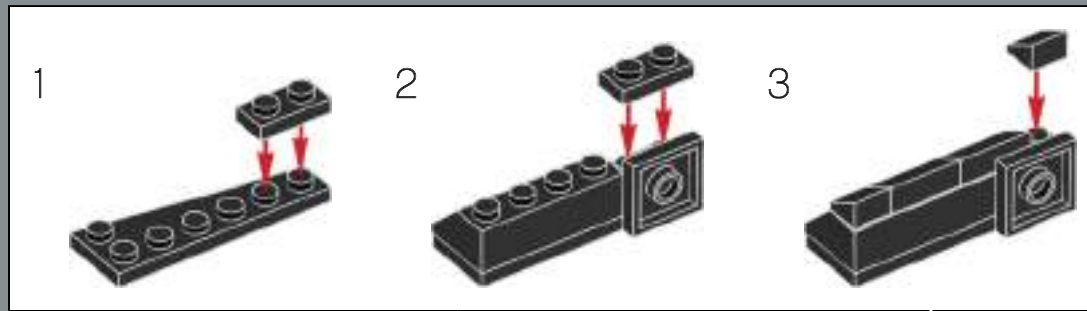

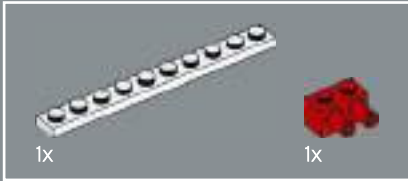
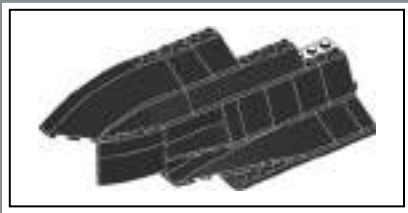

253

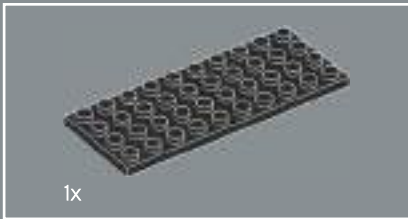
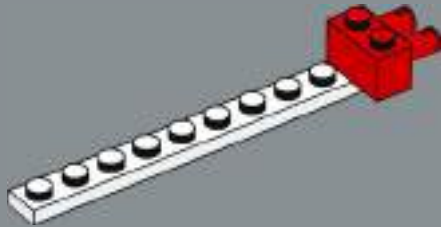

254

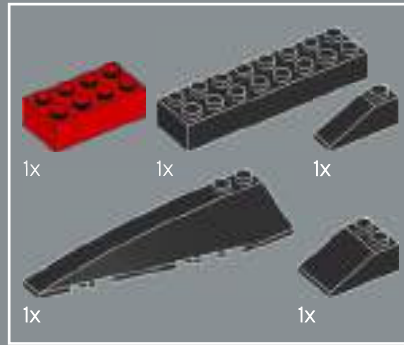
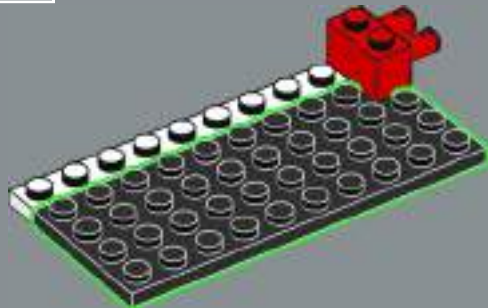

255

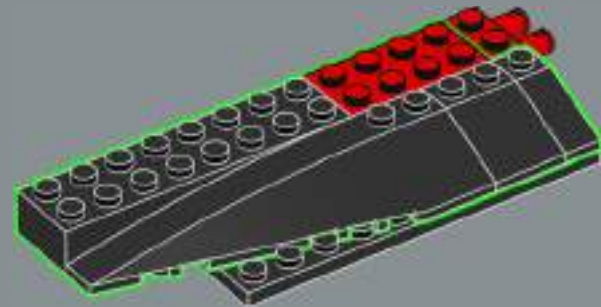



256

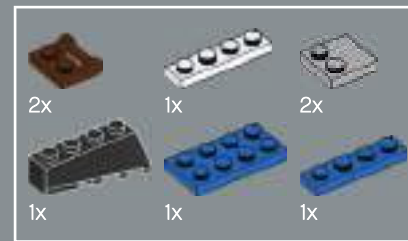
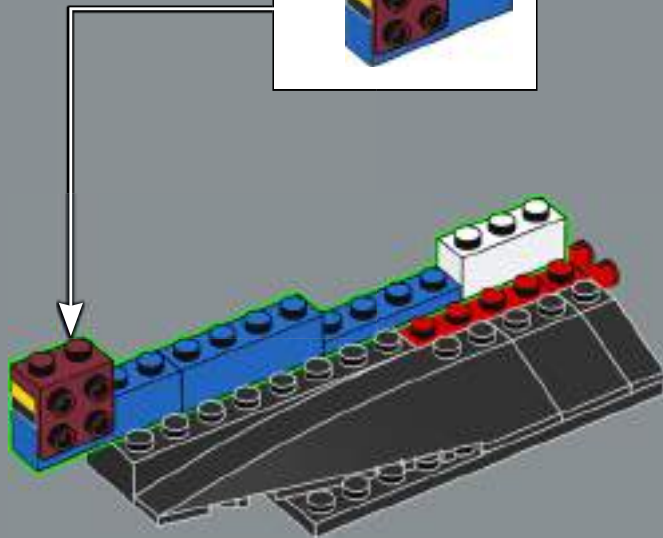
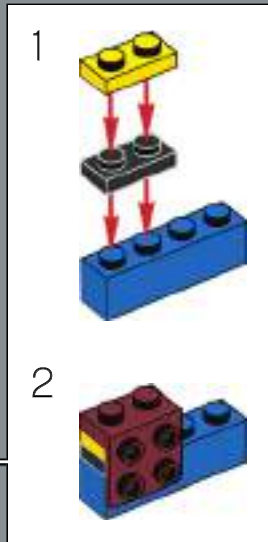

257

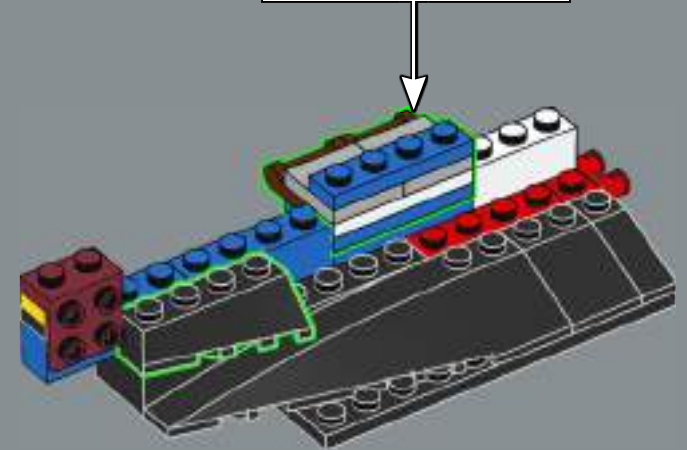
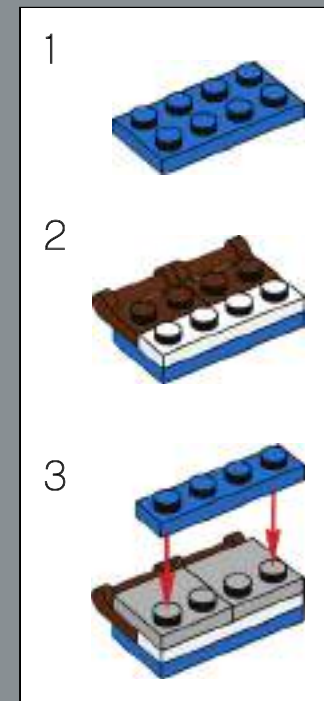

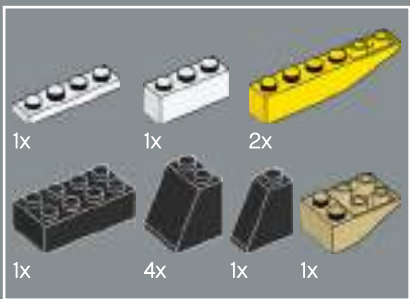

258

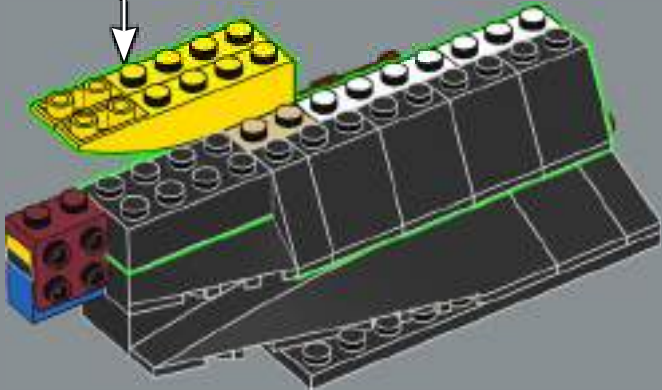
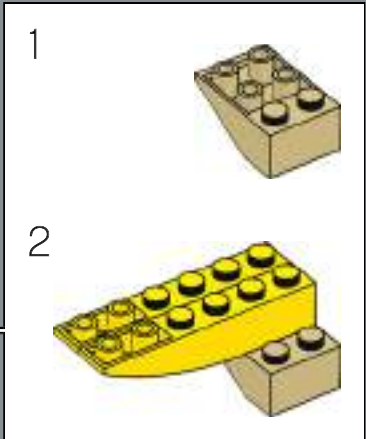

259

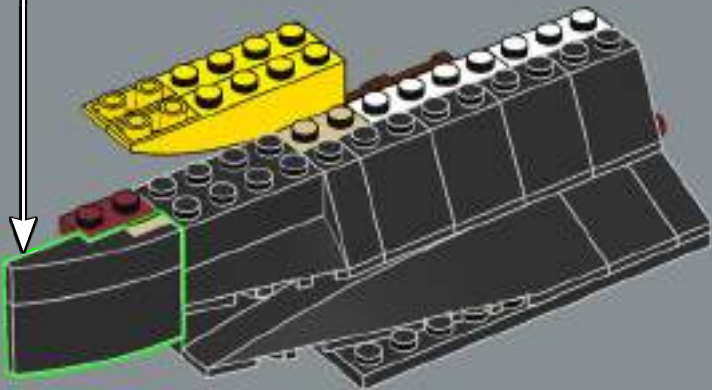
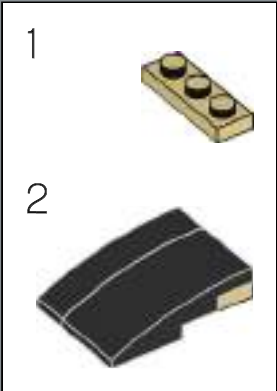

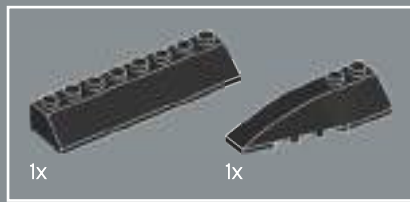

260

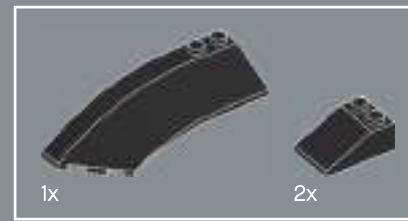
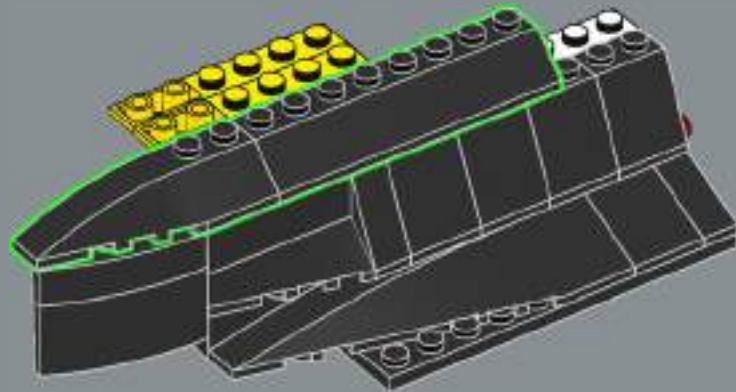

261

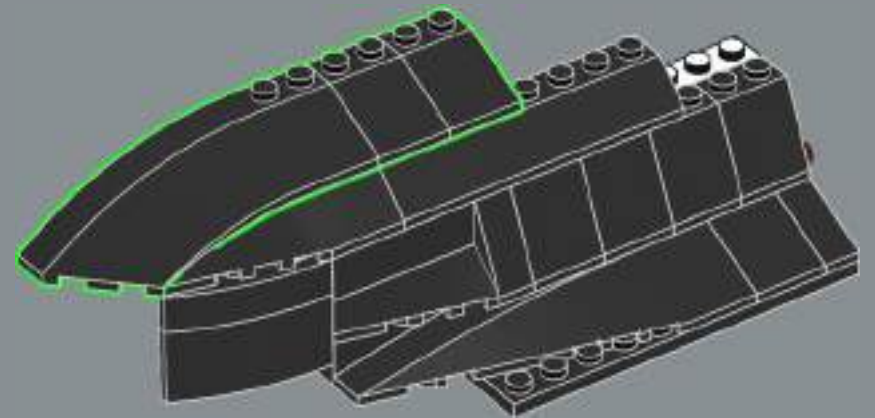

262

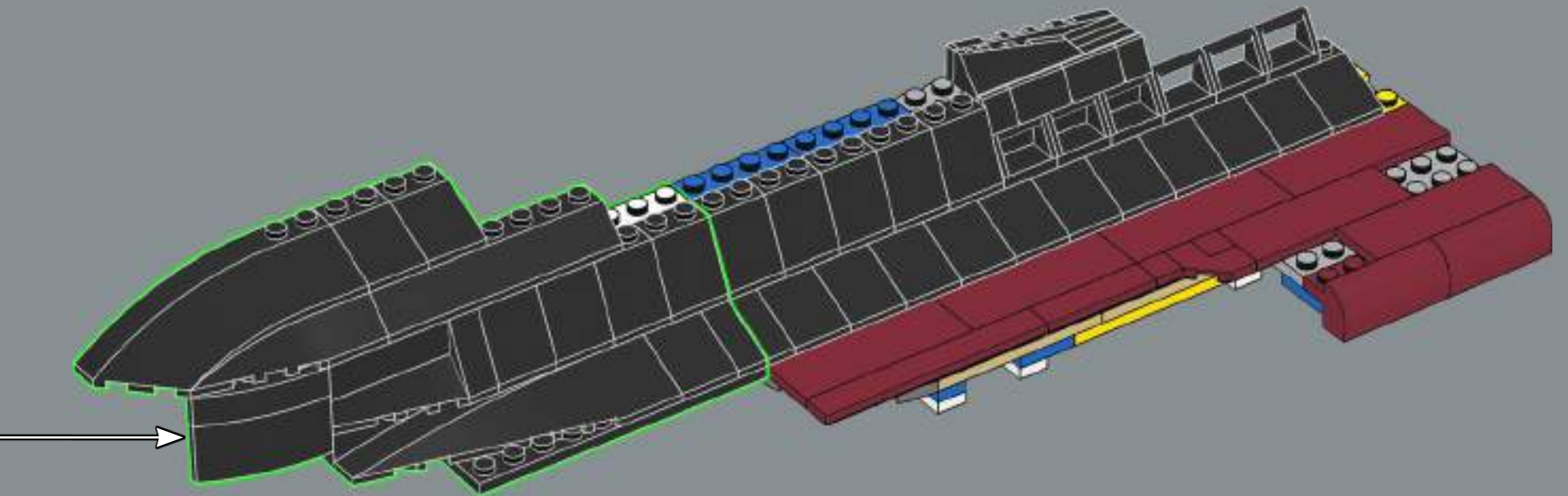

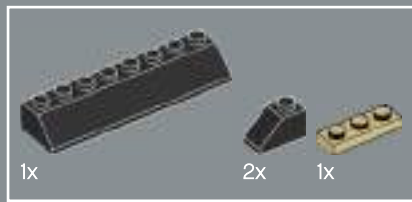

263

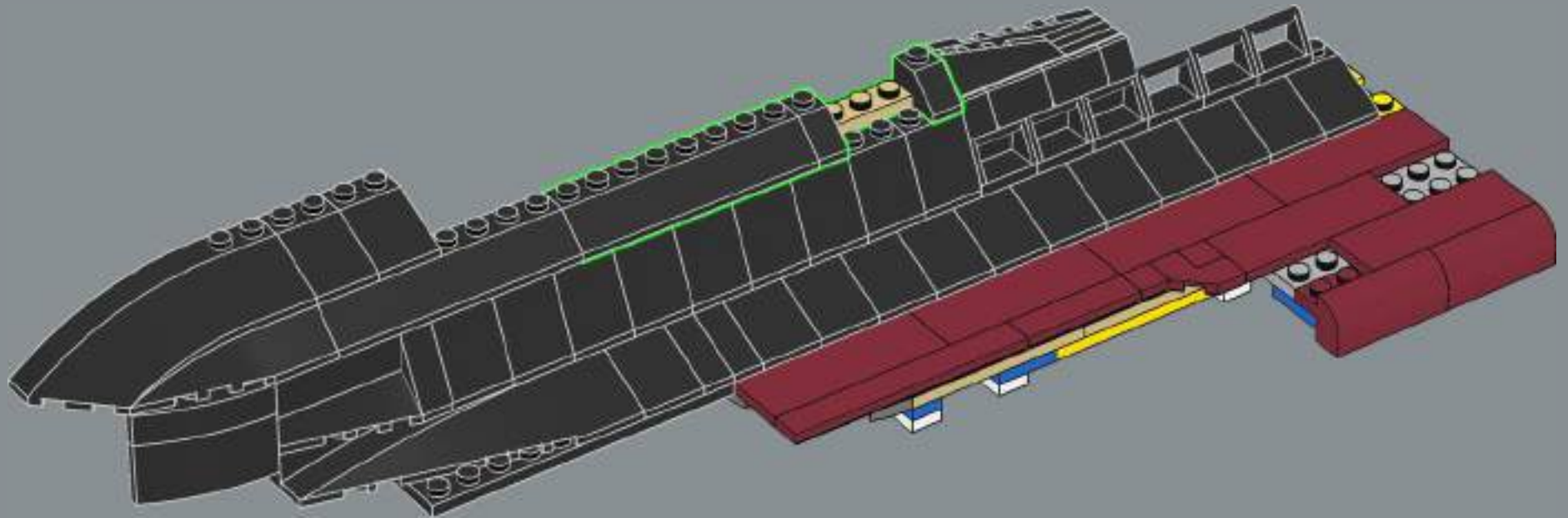

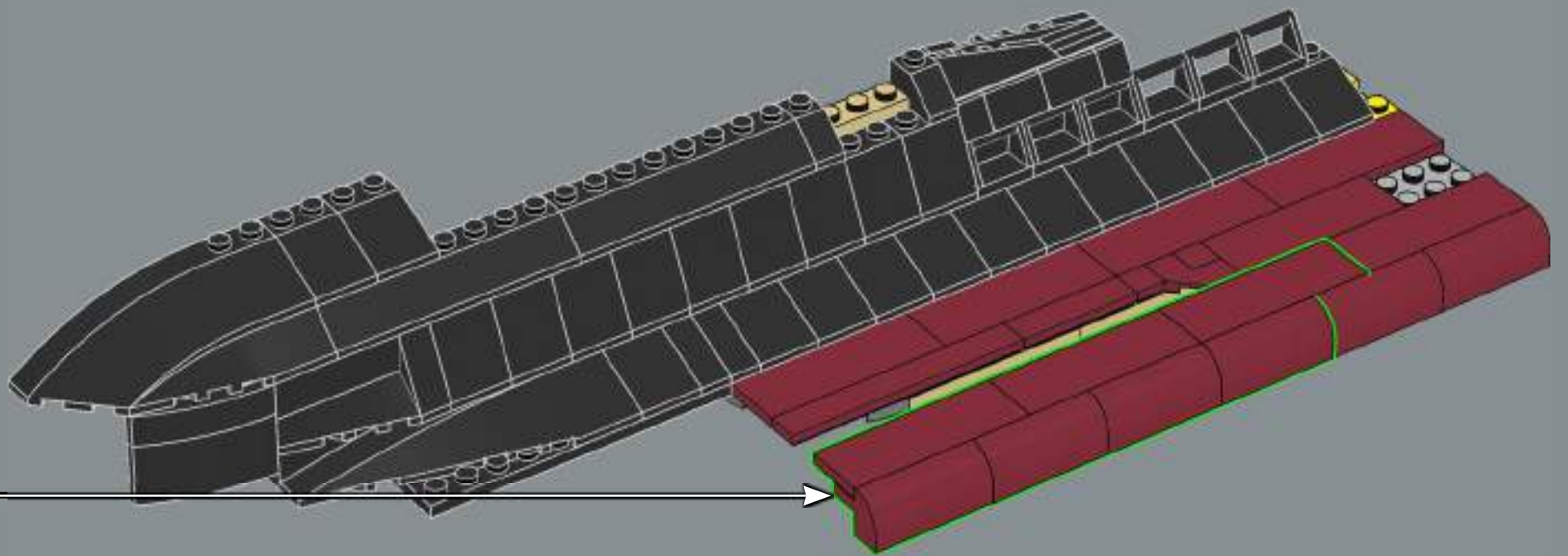



265

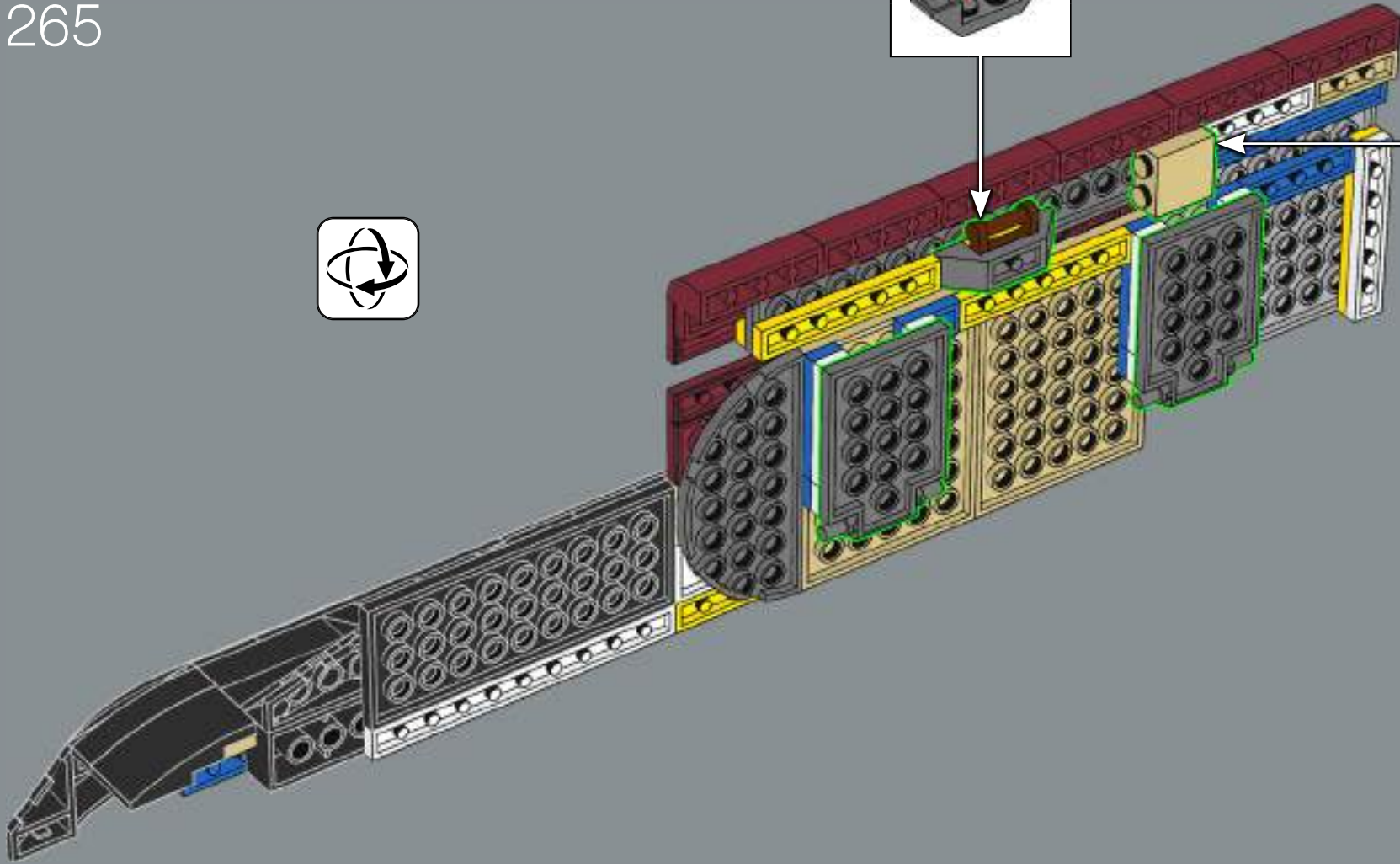
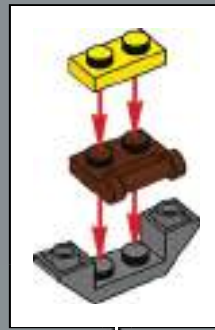

266

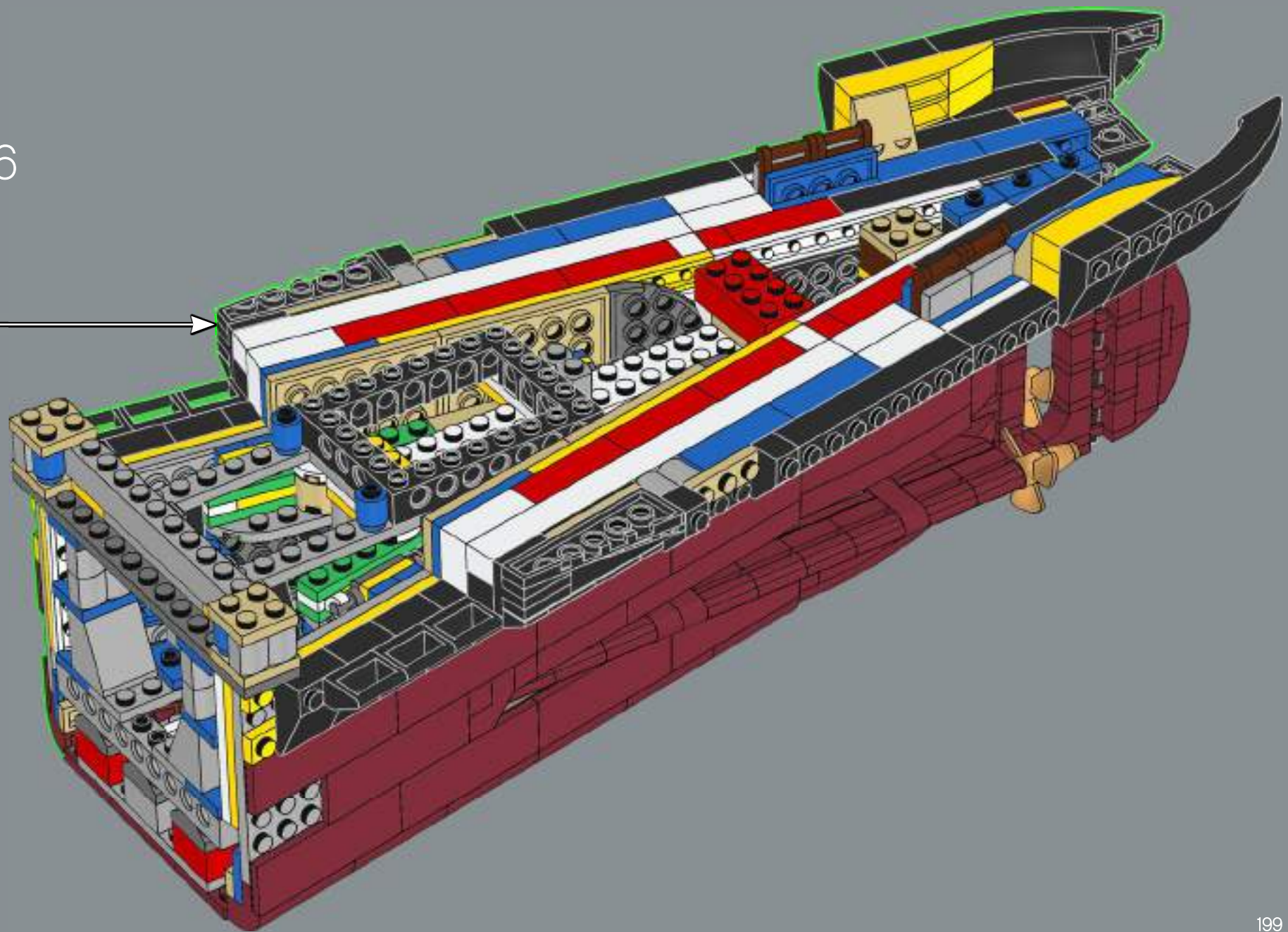

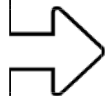

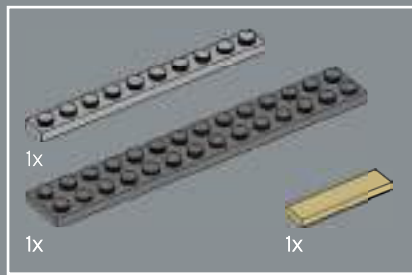

267

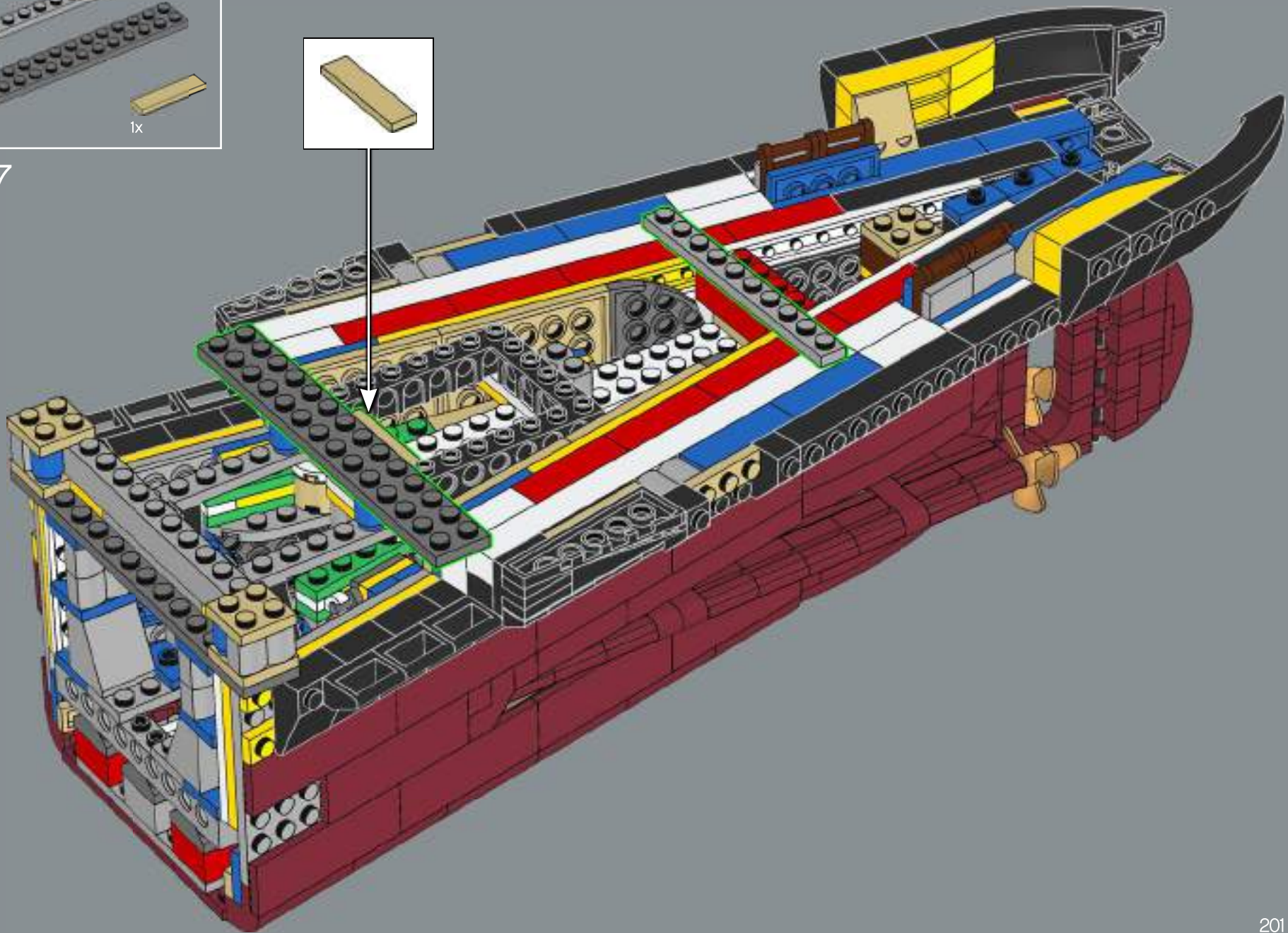
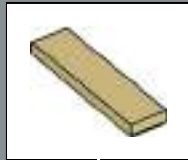

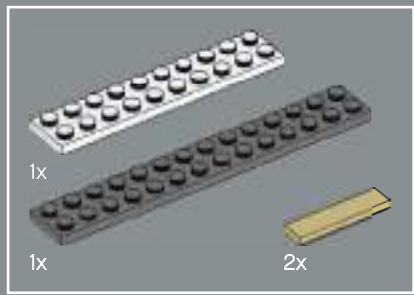

268

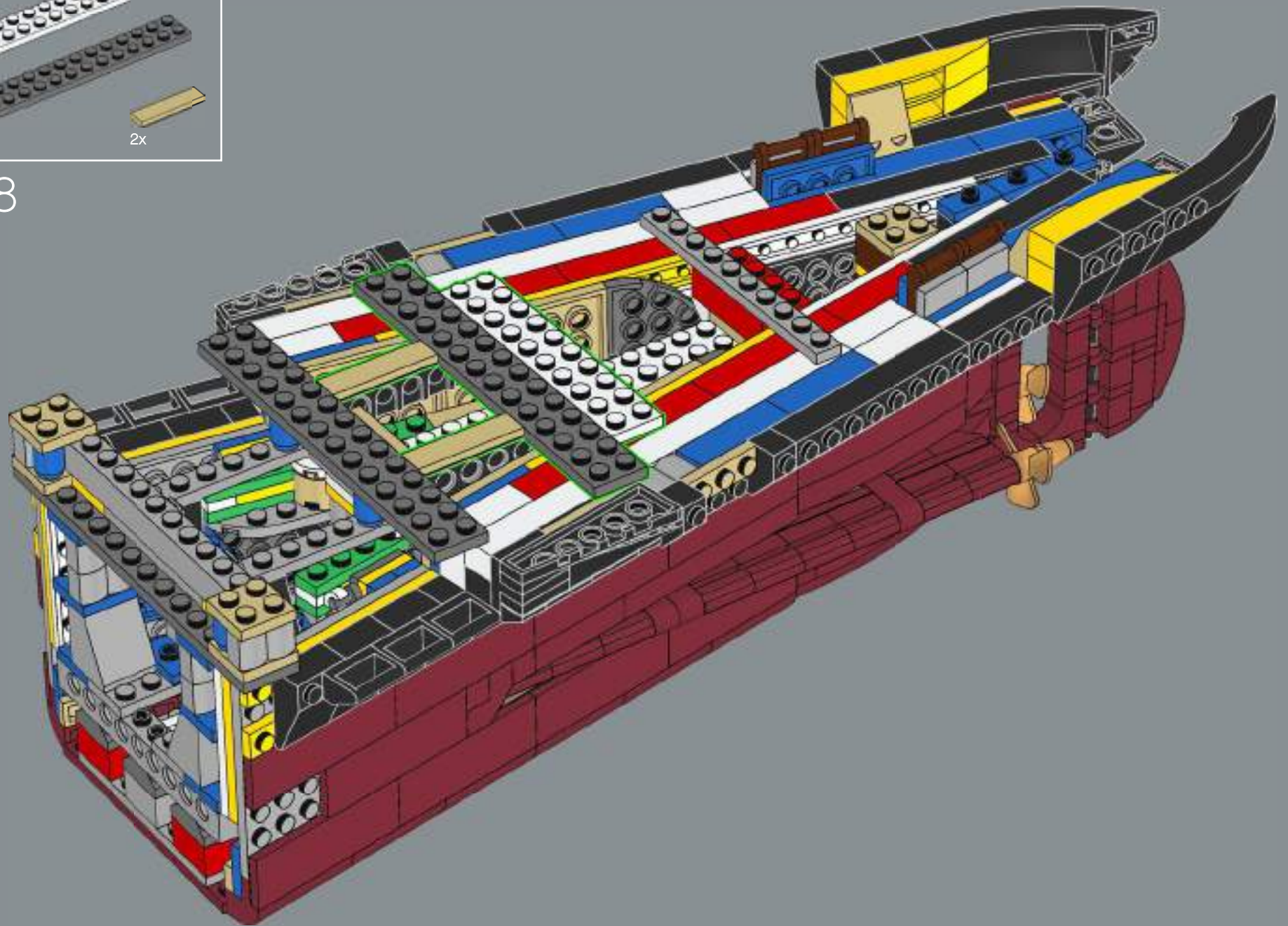

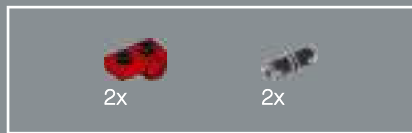

269

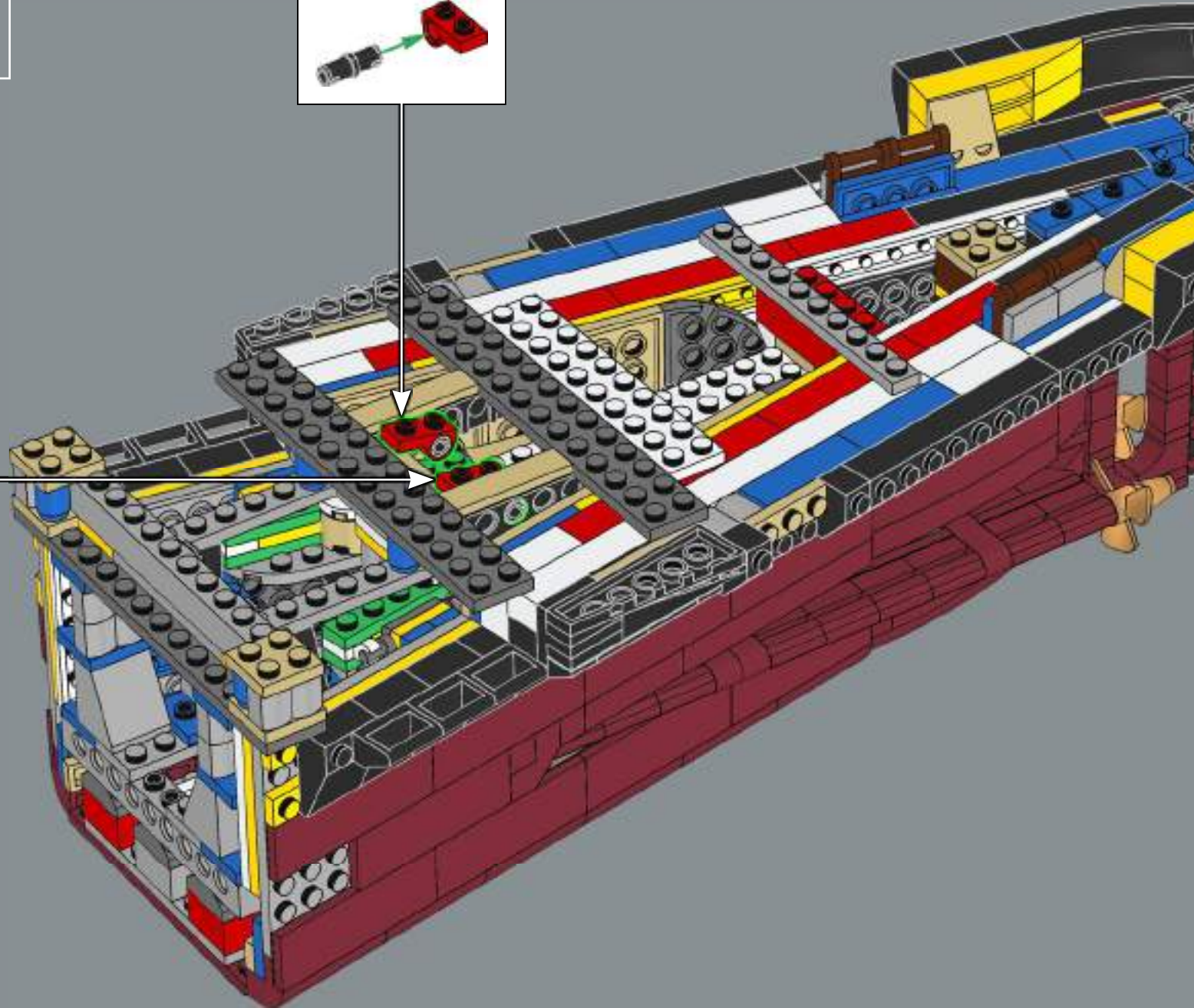
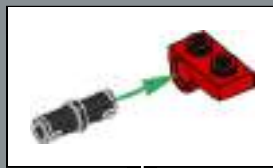

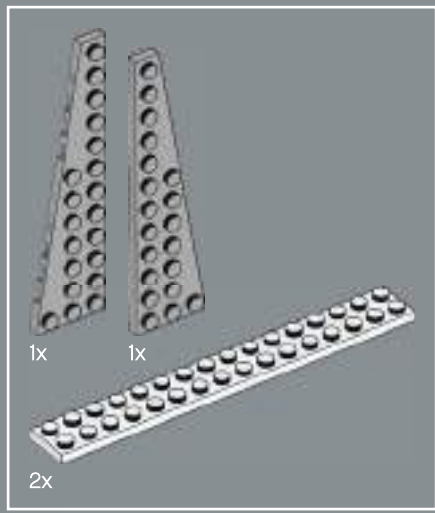

270

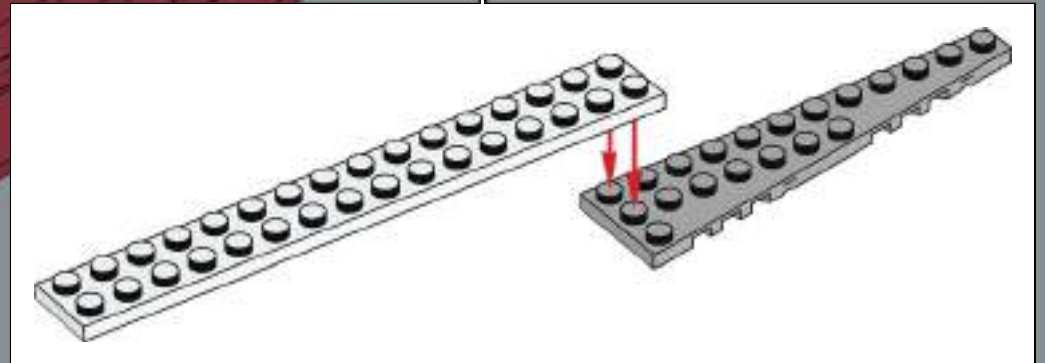
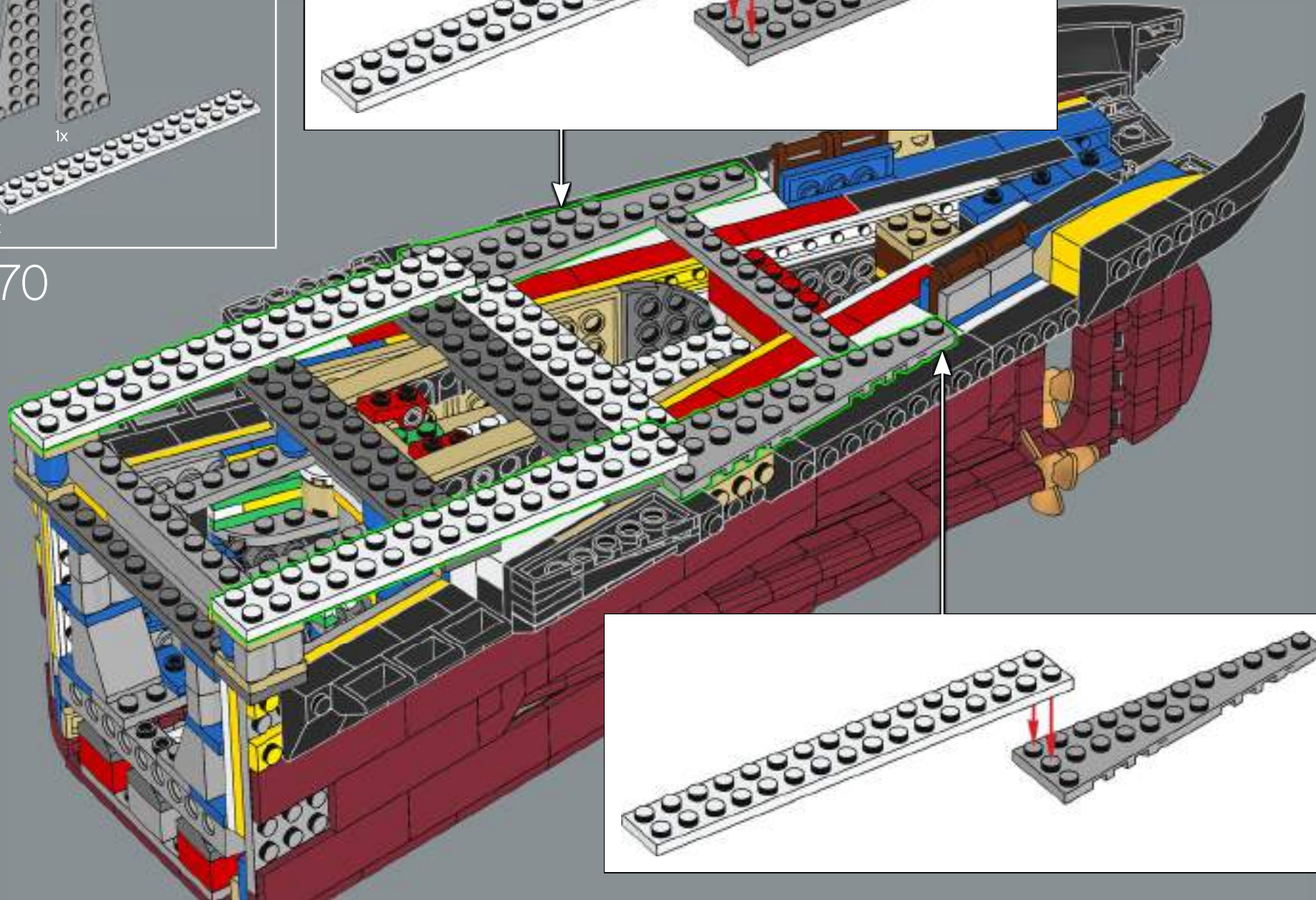
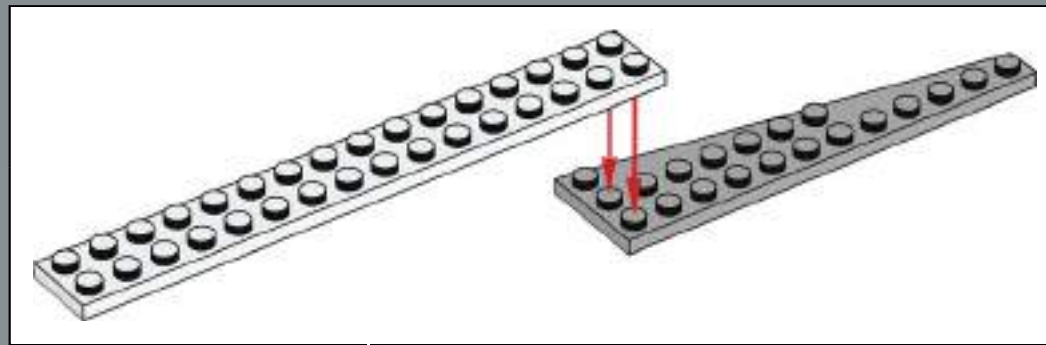

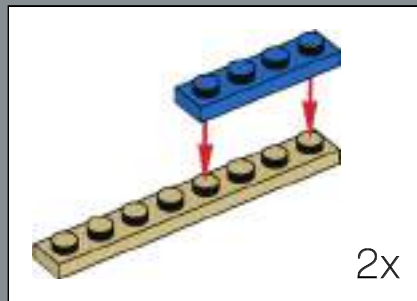
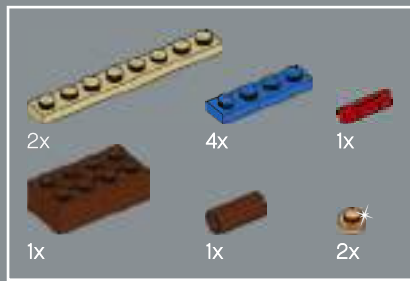

271

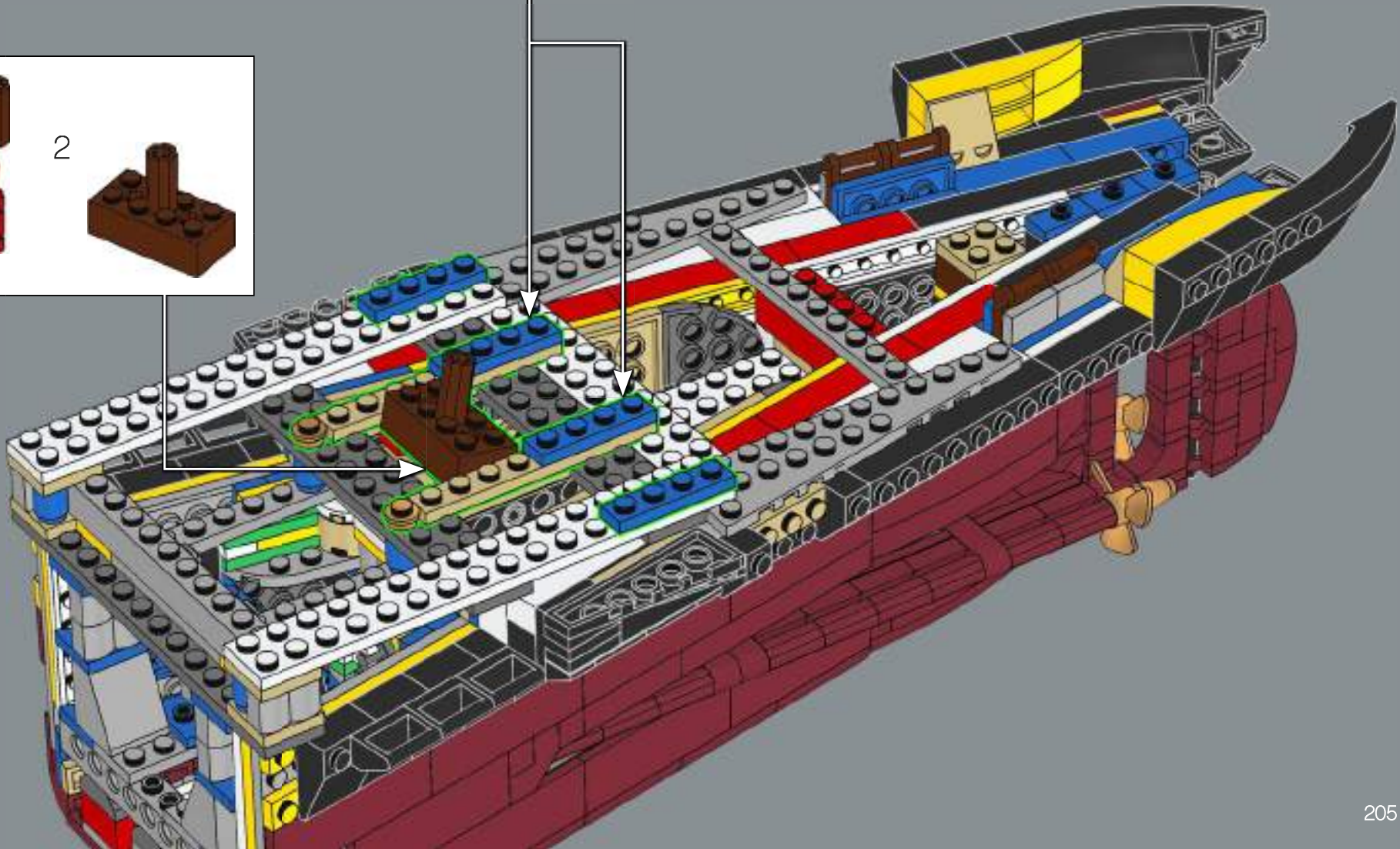
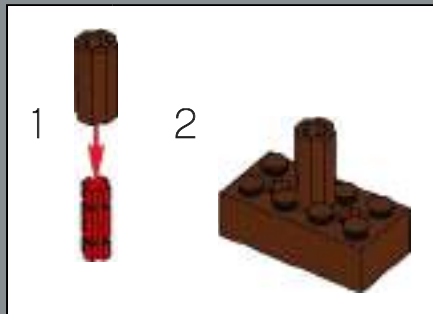

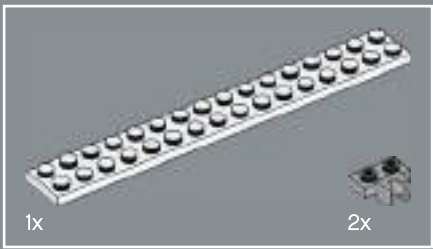

272

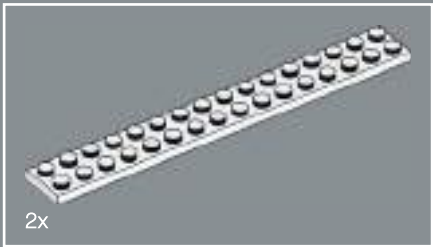
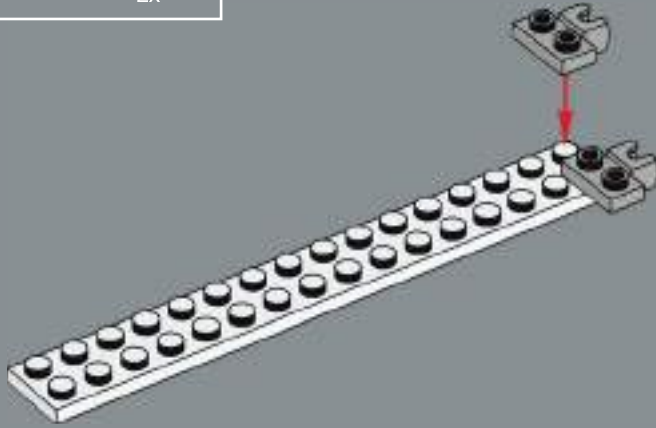

273

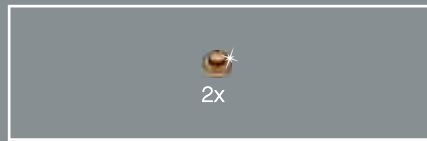
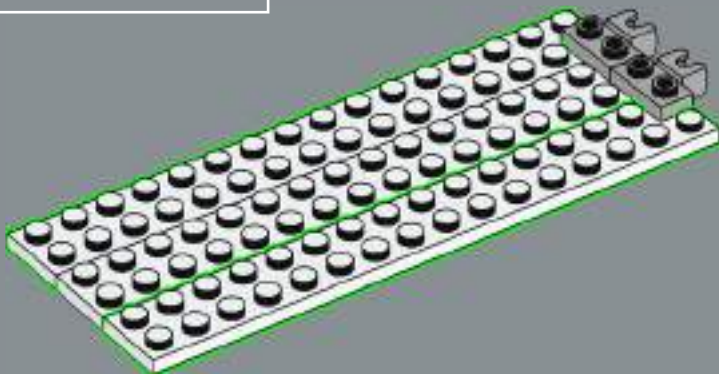

274

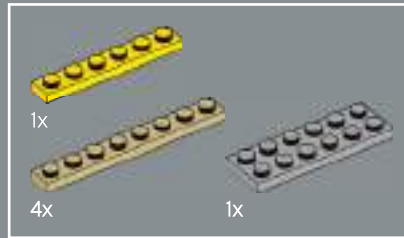
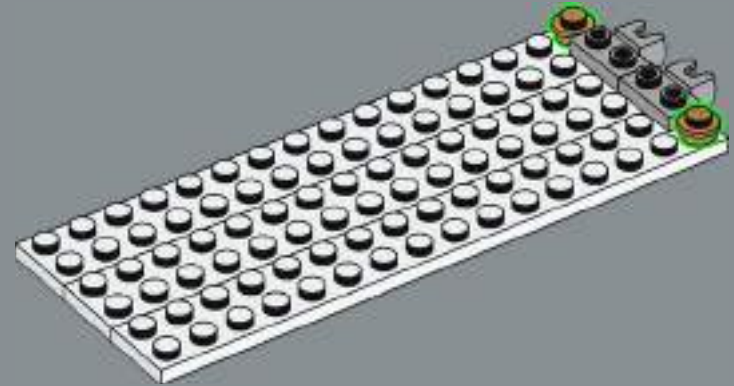

275

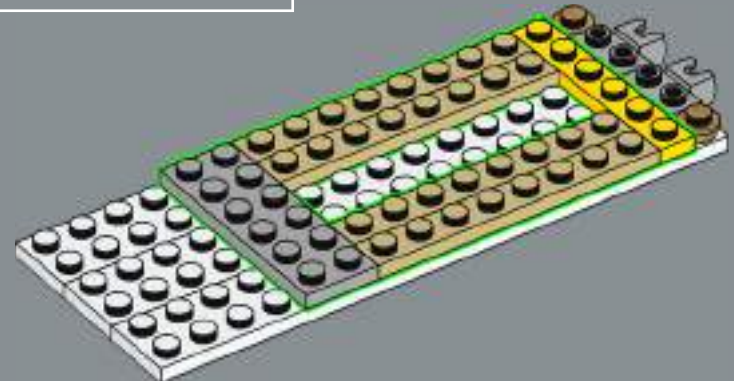



276

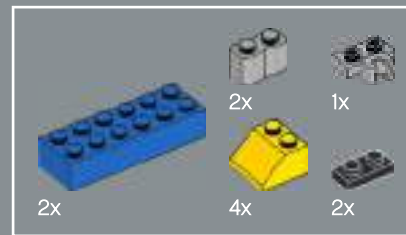
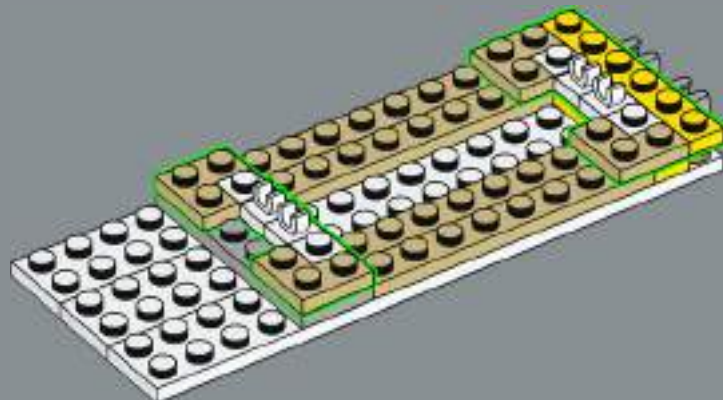

277

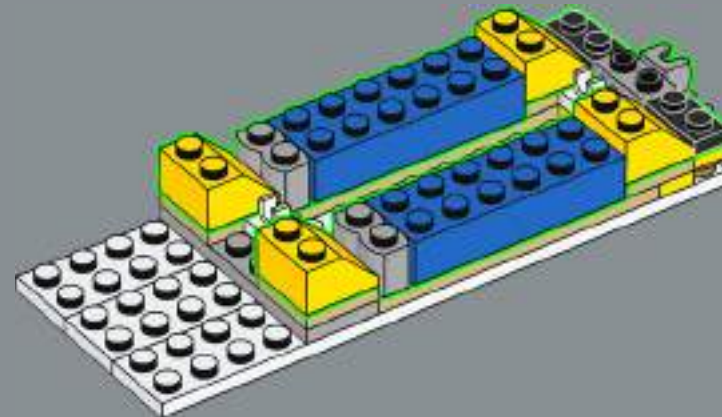

278

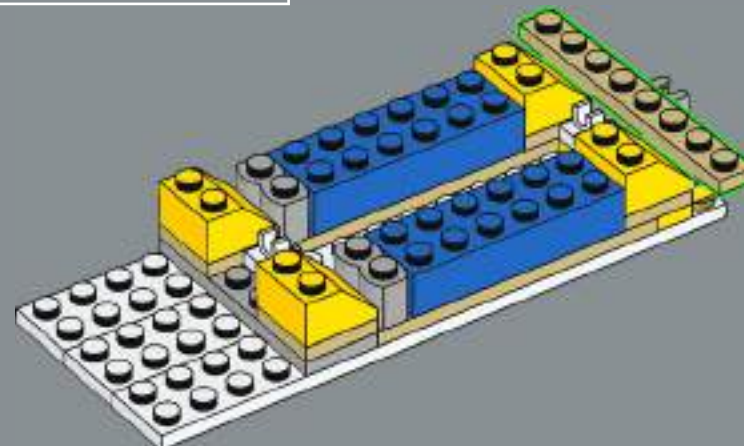

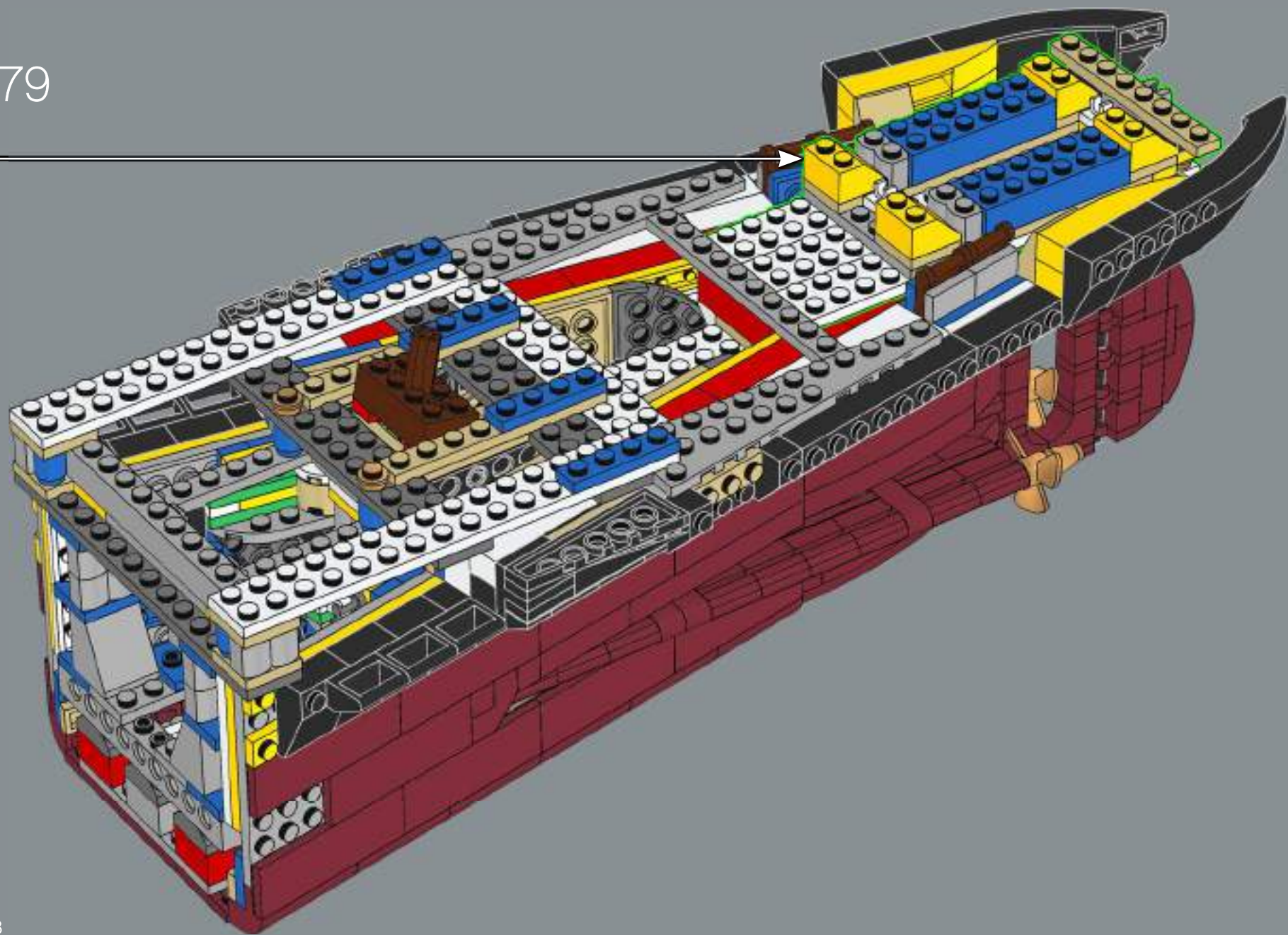



280

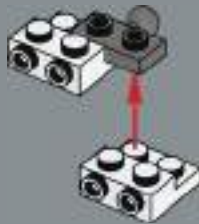

281

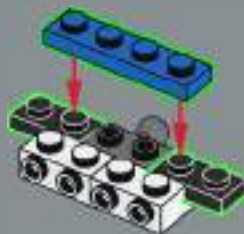

282

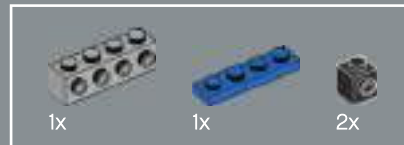
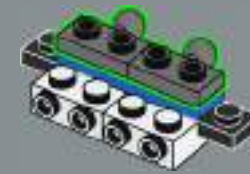

283

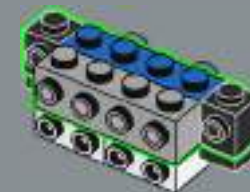

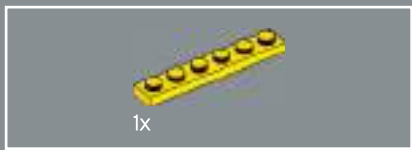

284

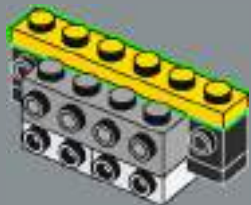

285

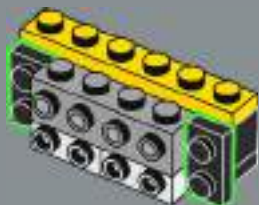

286

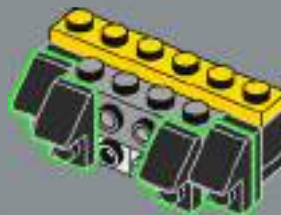

287

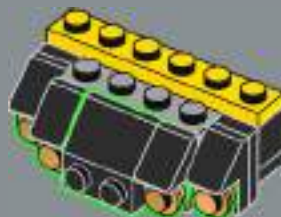

288

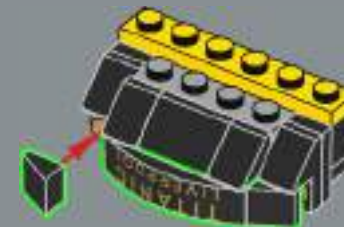

289

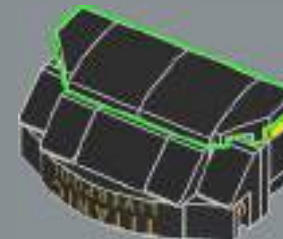

The *Titanic* lacked a searchlight and had no Public Address system.

290

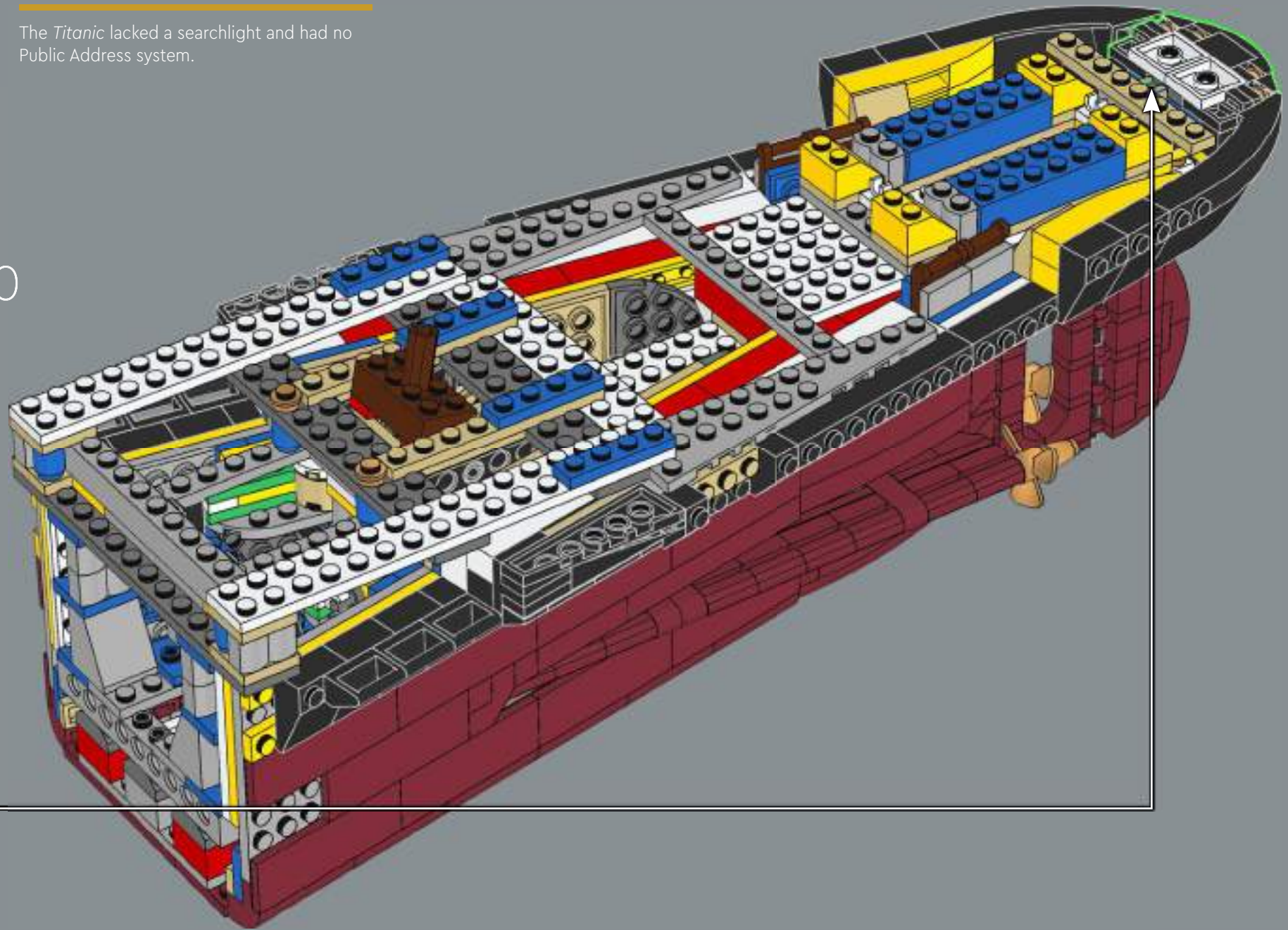

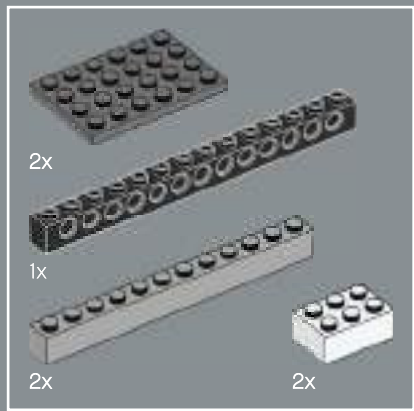

291

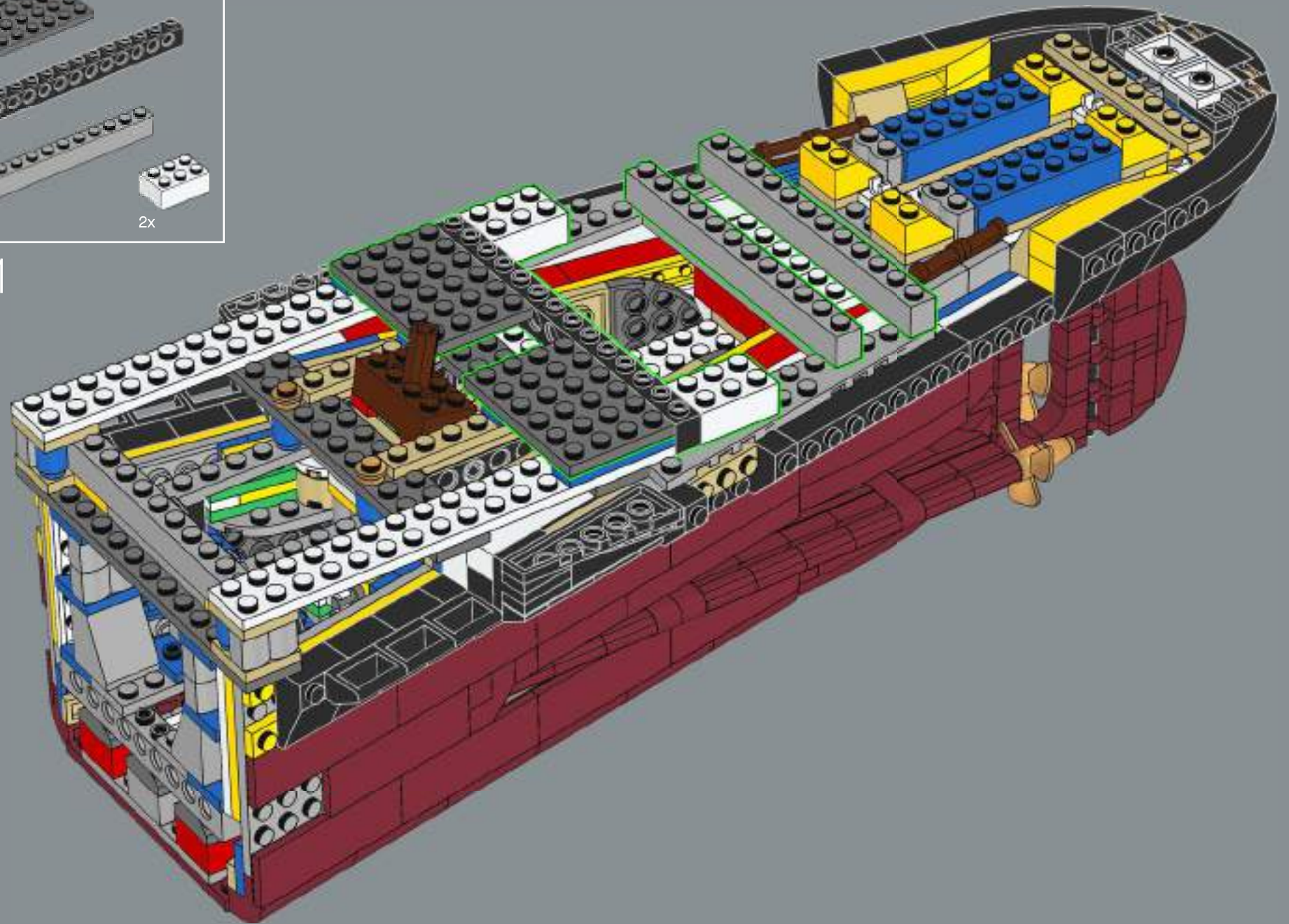

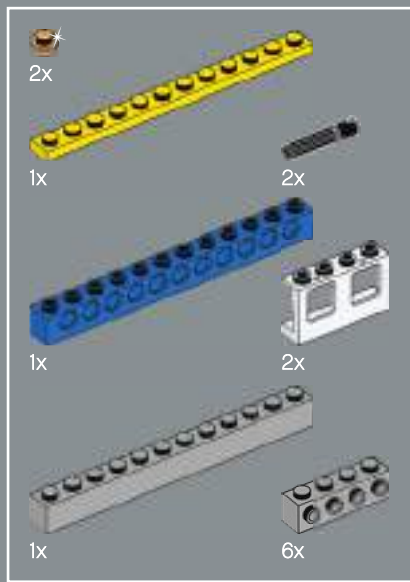

292

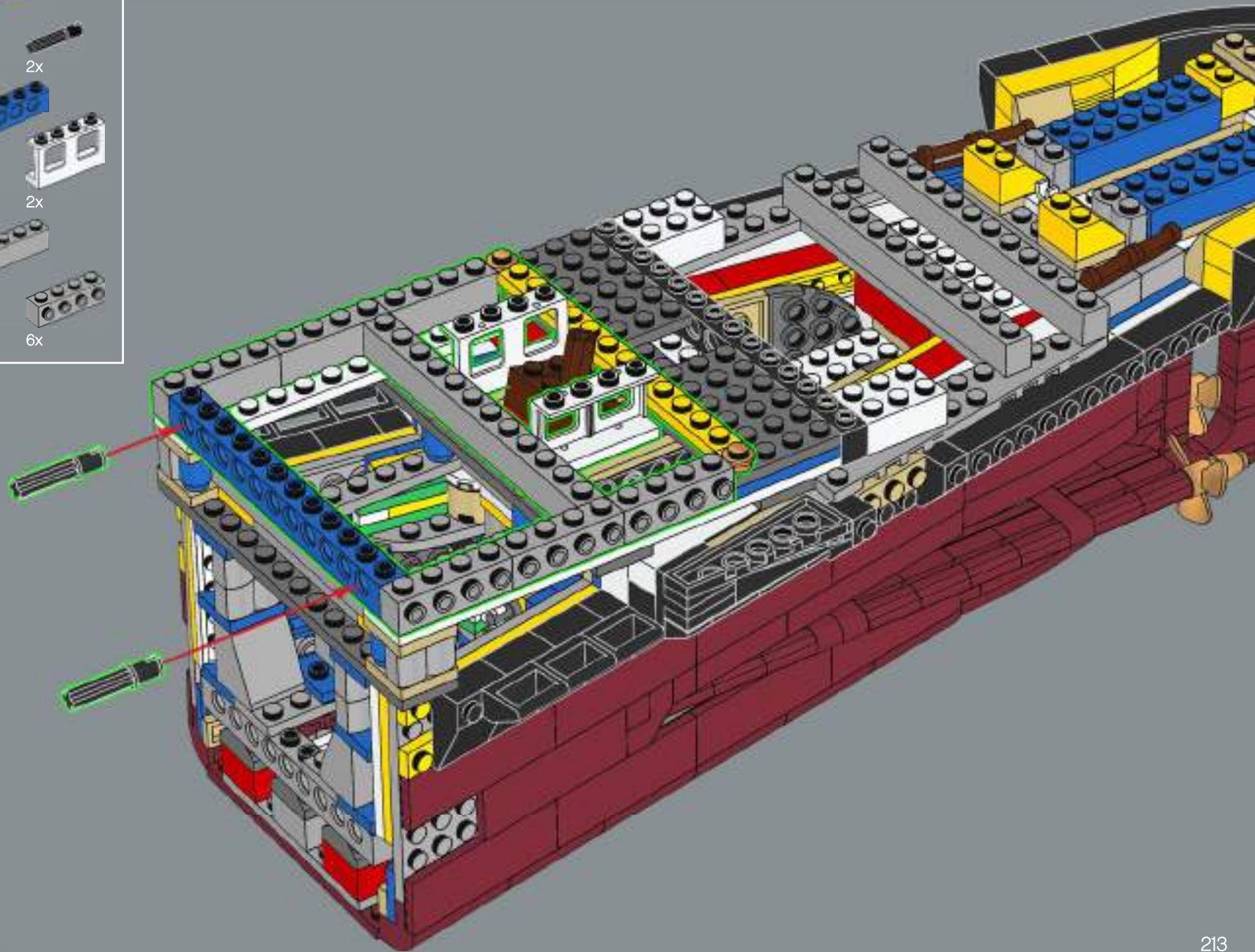

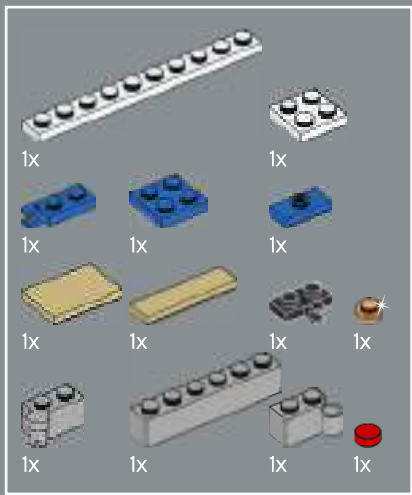

293

1

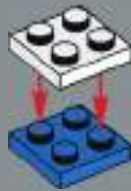

2

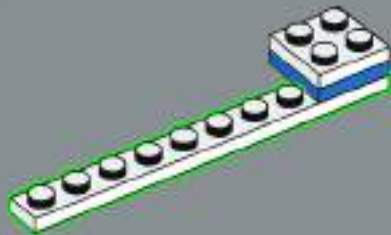

3

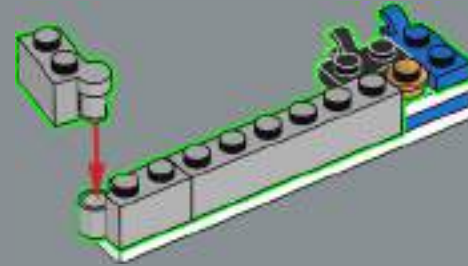

4

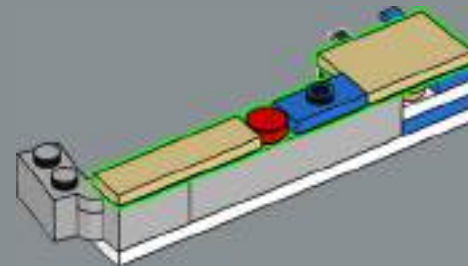

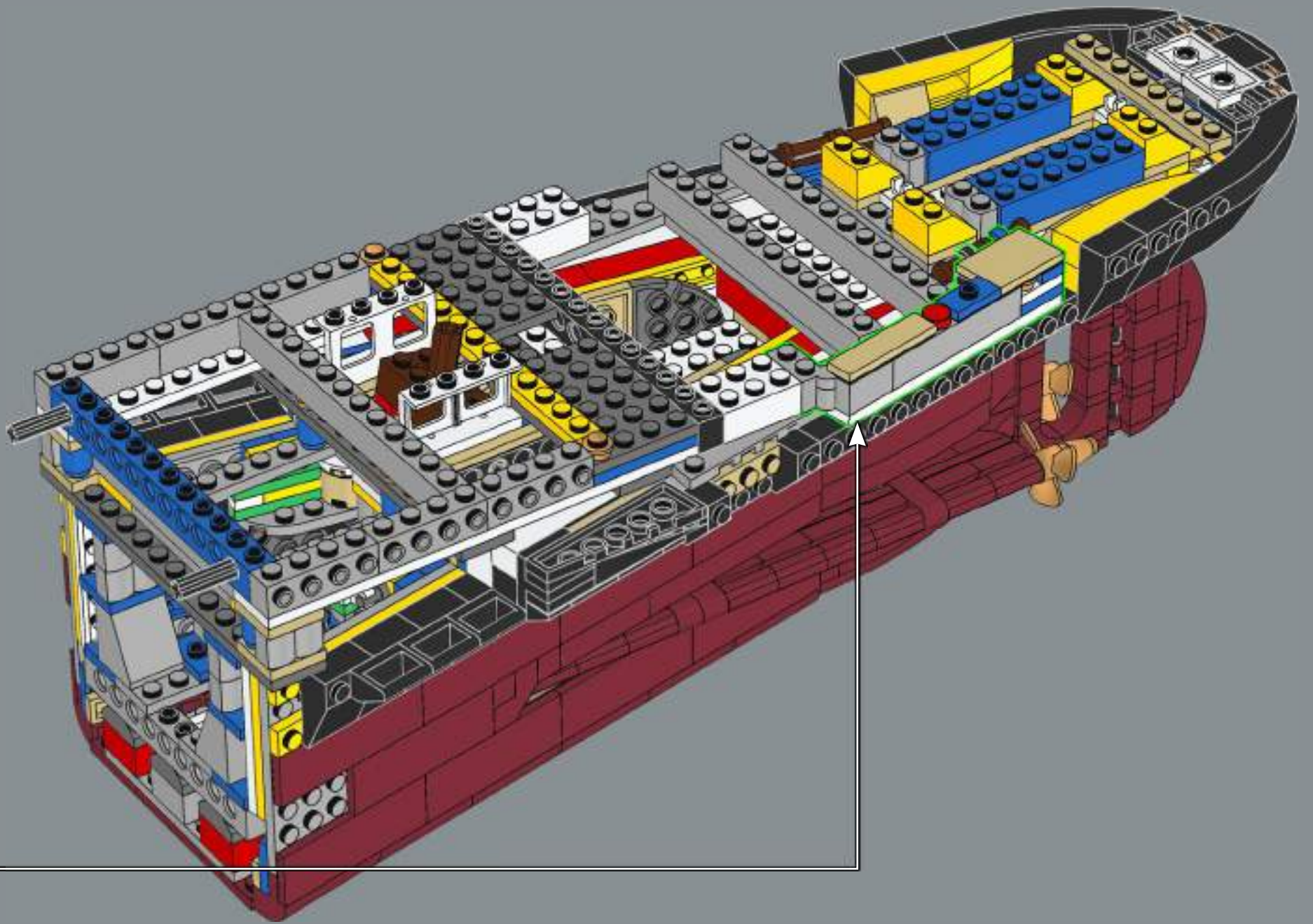



294

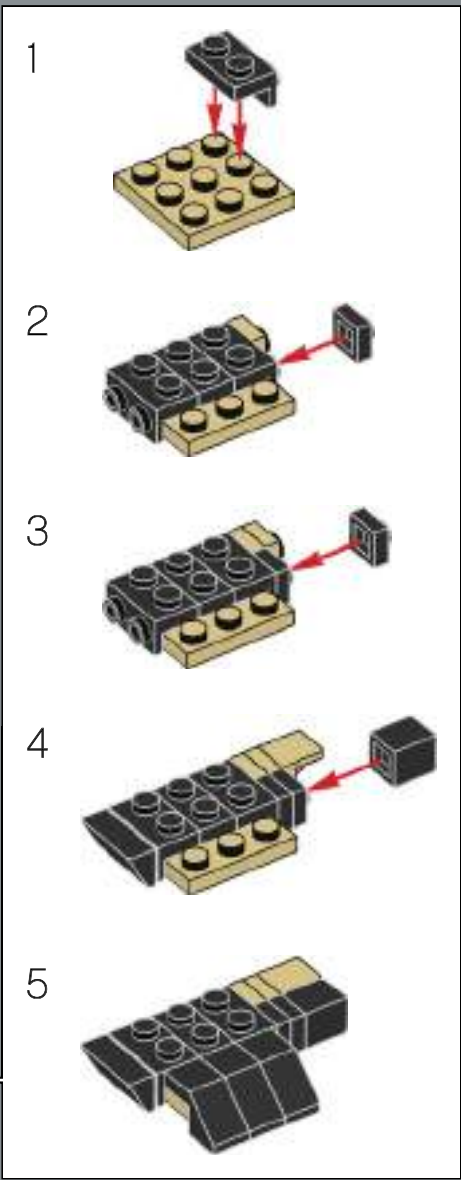
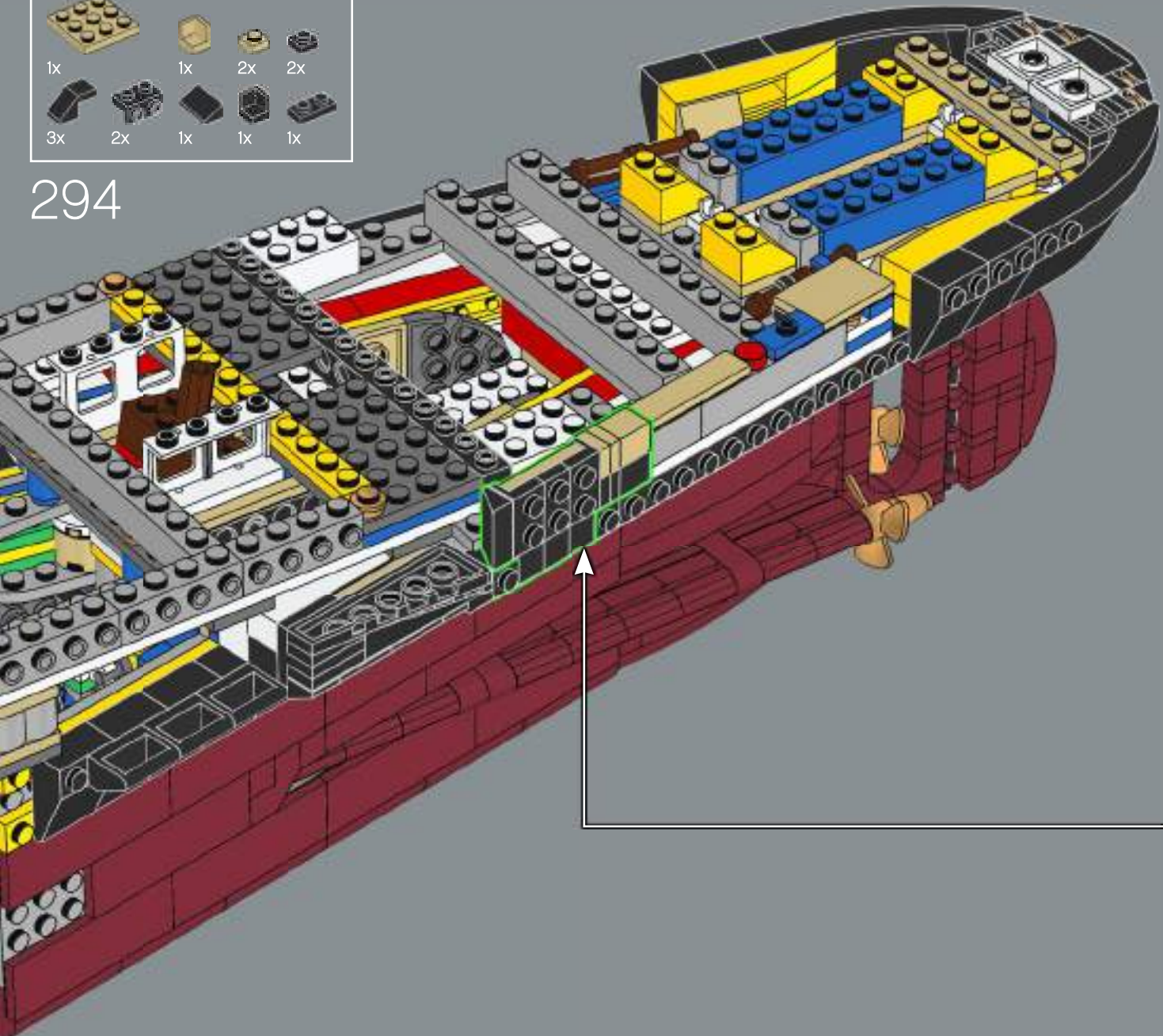

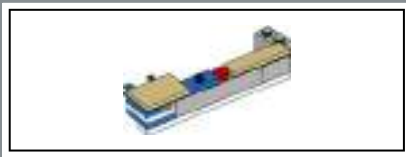

295

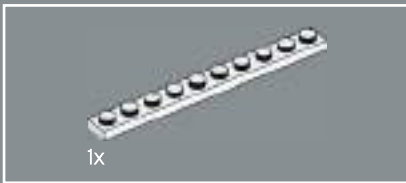
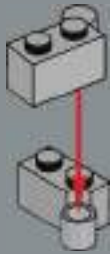

296

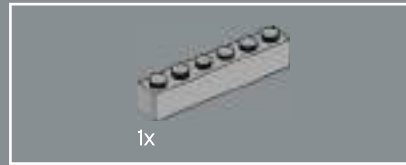
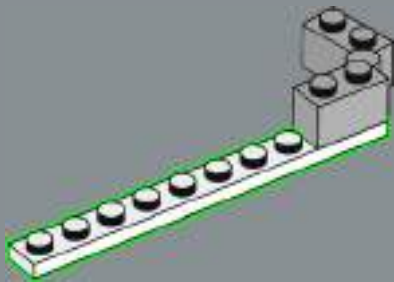

297

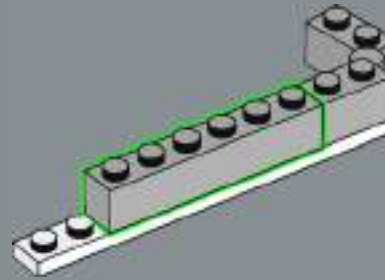

298

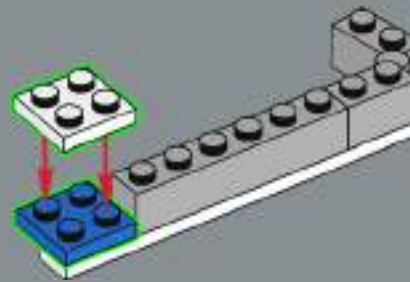

299

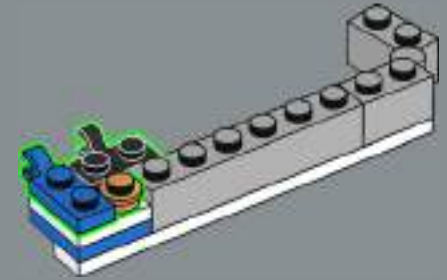

300

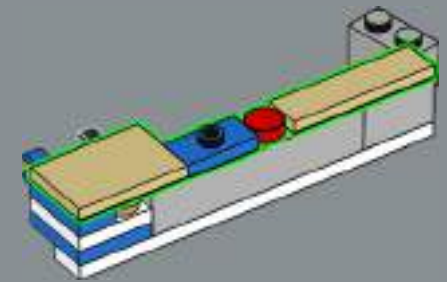

301

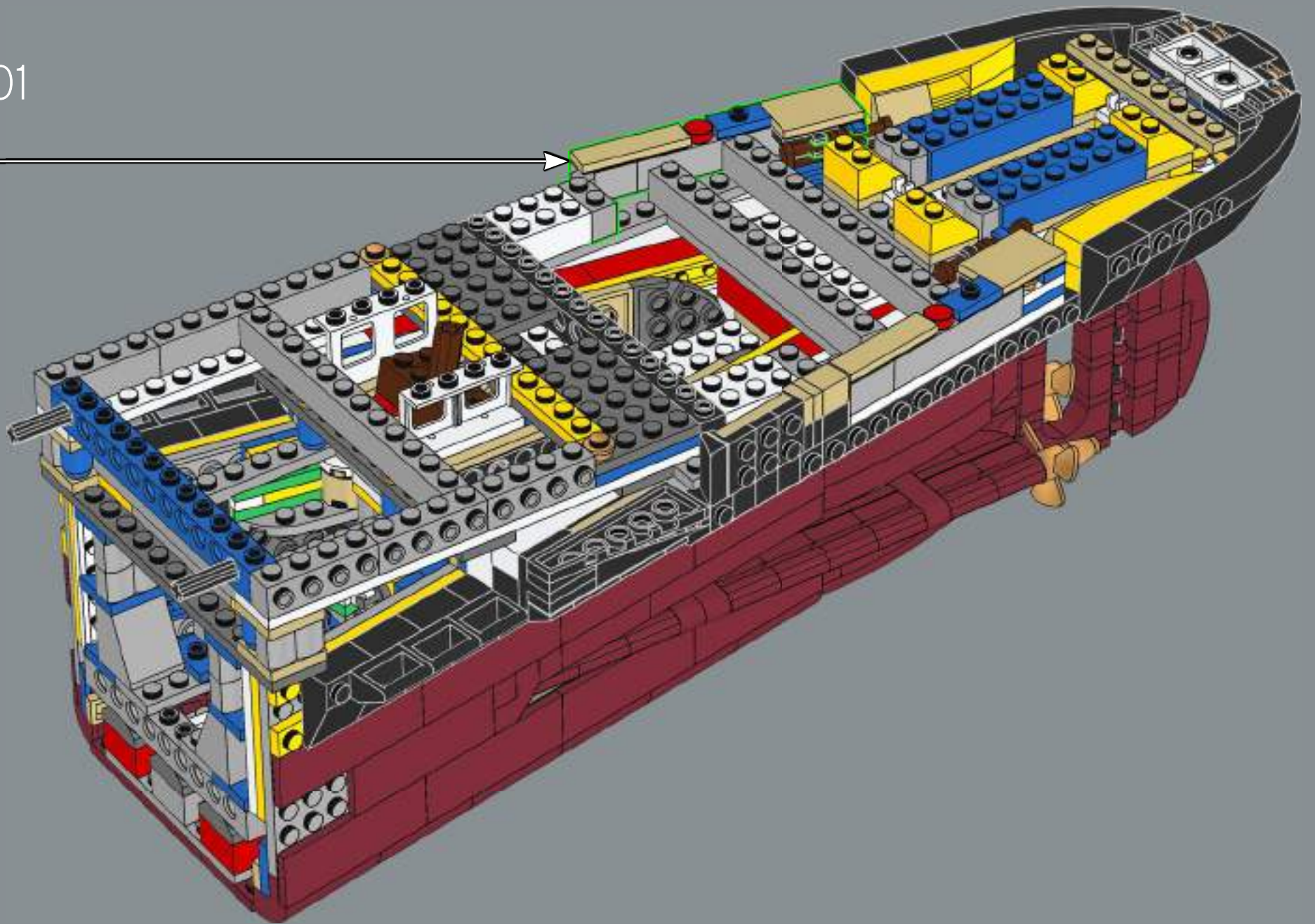



302

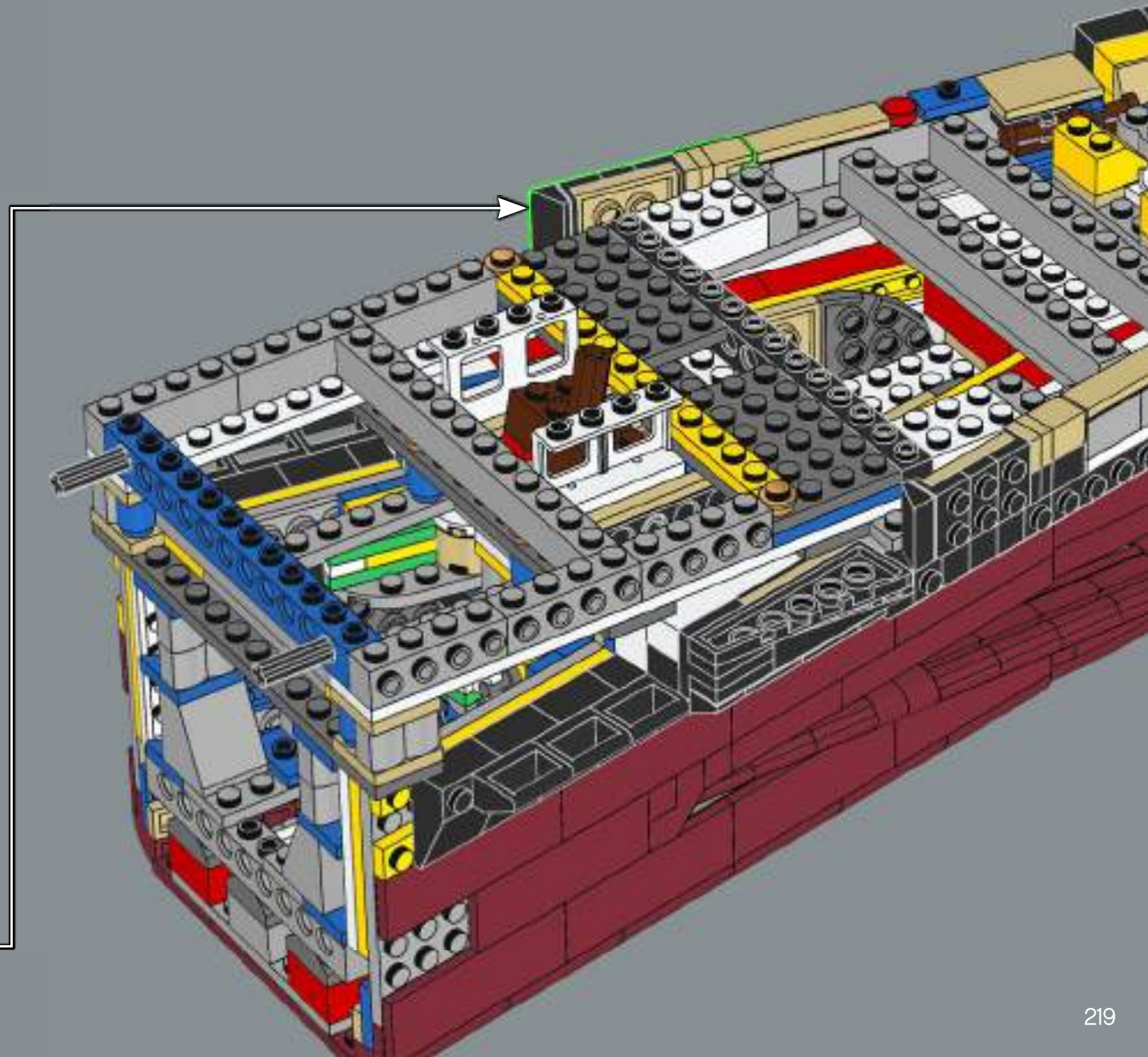
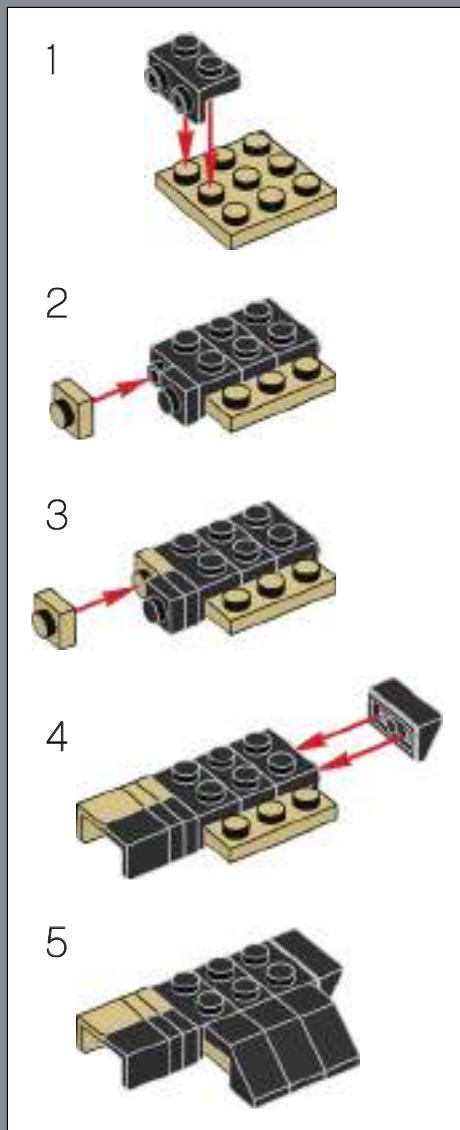

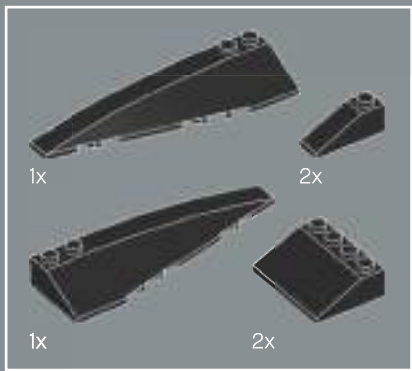

303



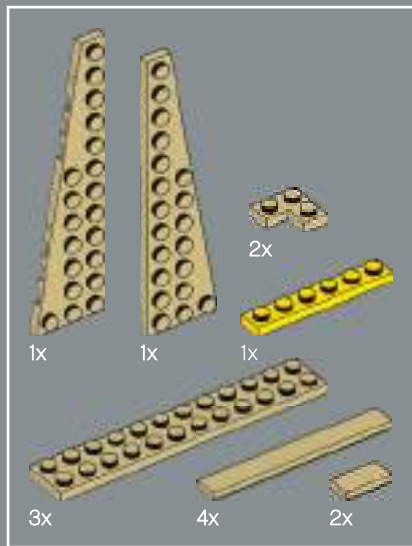

304

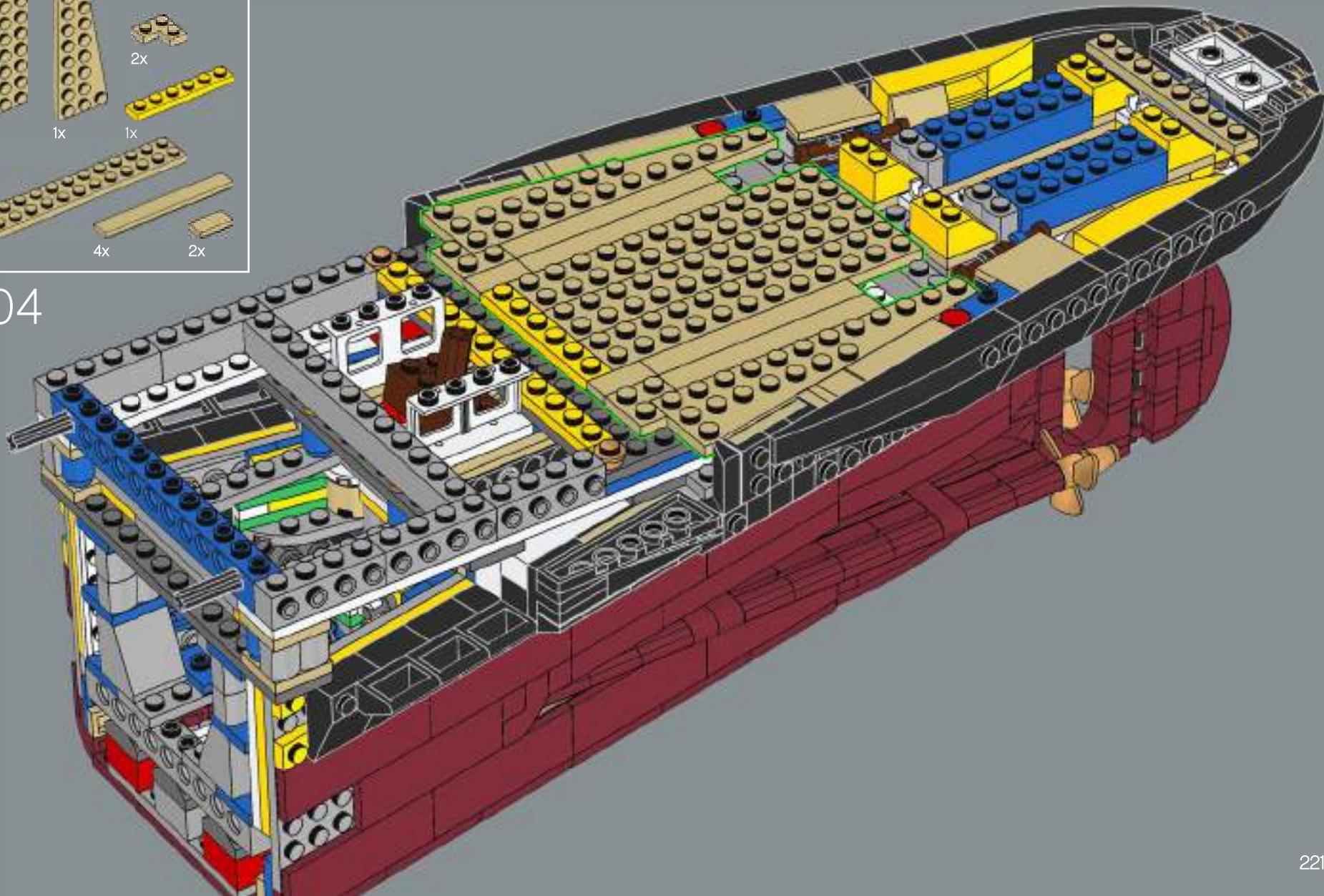

41

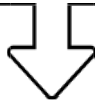



305



306

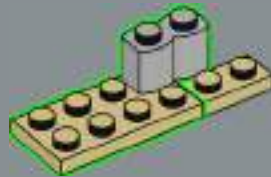

307

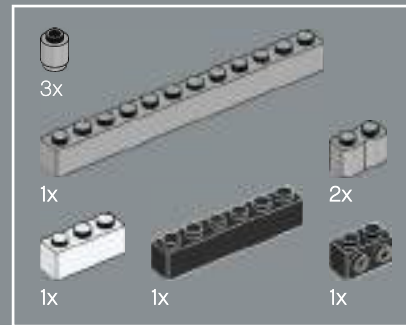
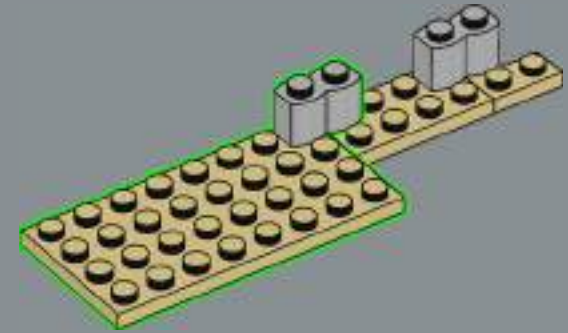

308

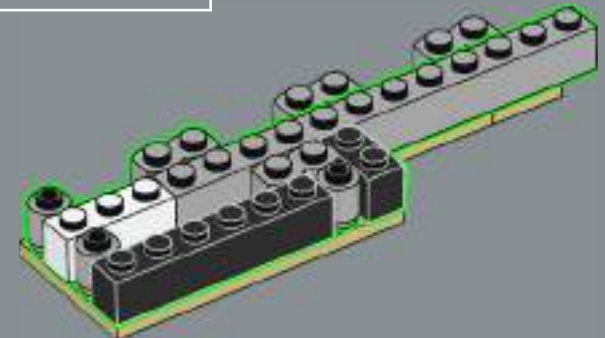



309

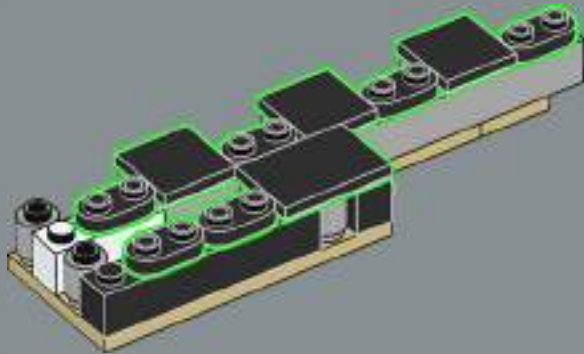

310

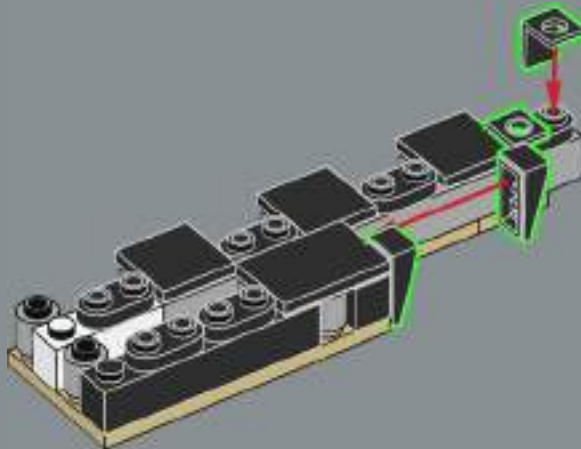

311

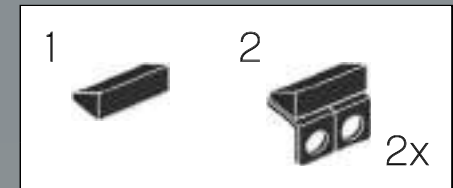
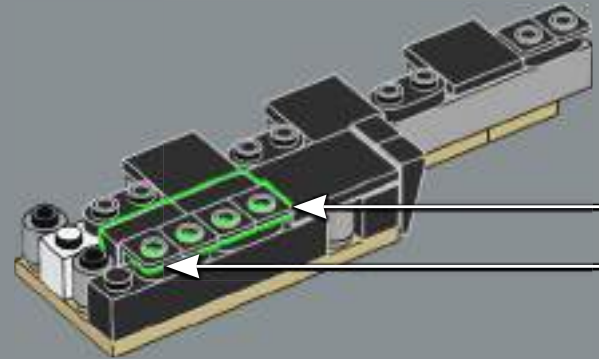

312

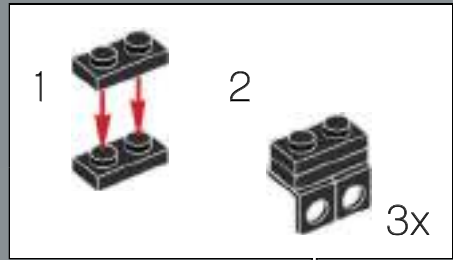
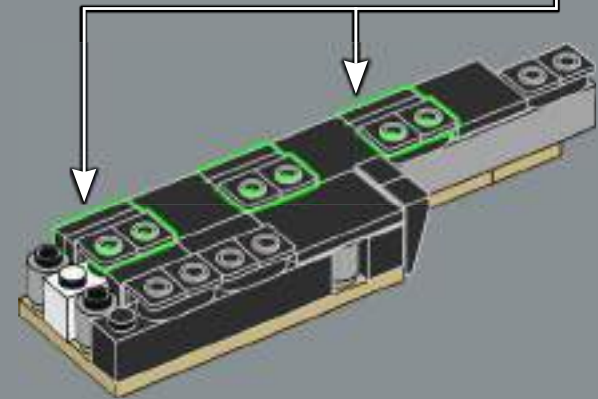

313

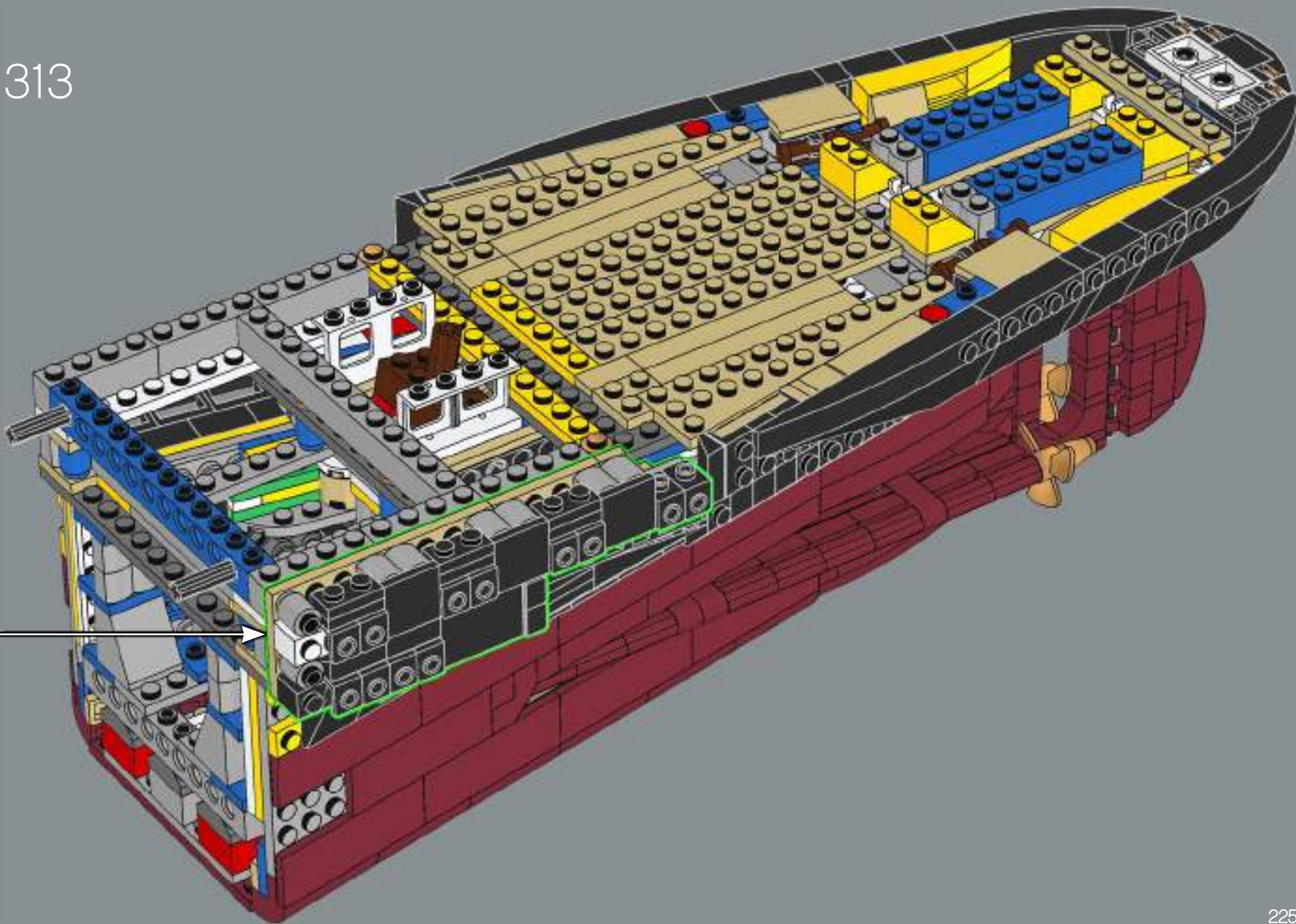

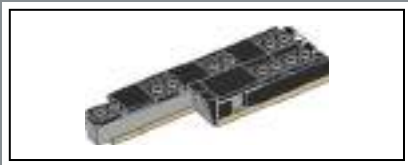

314



315

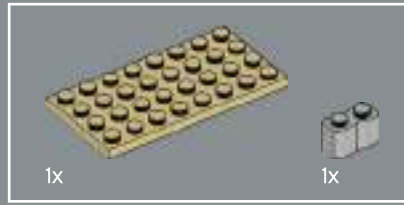
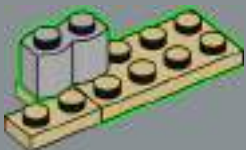

316

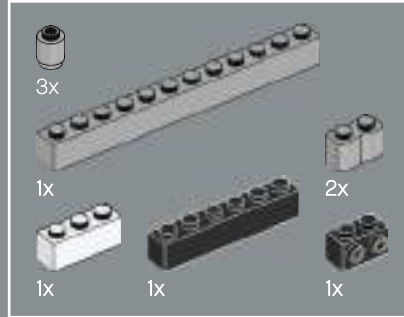
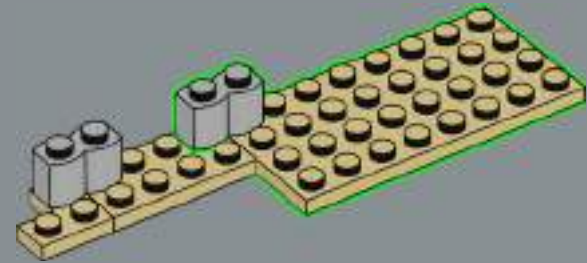

317

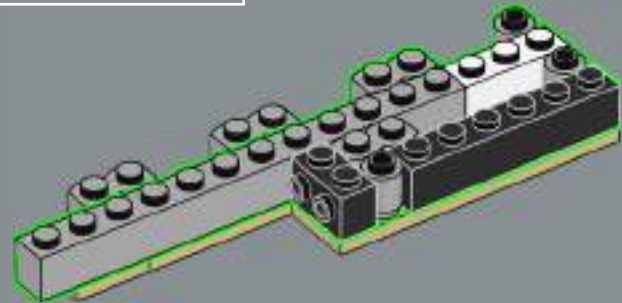

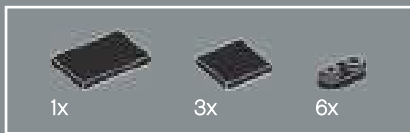

318

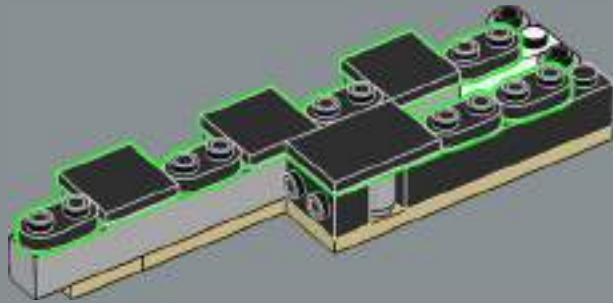

319

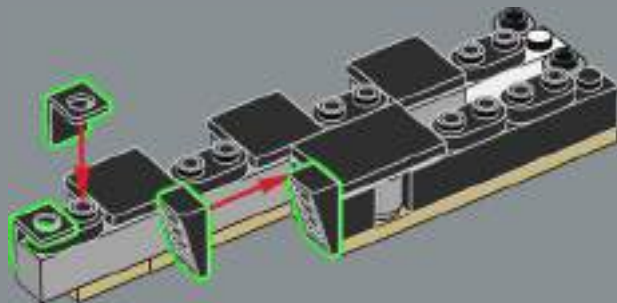

320

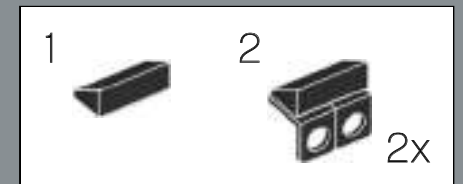
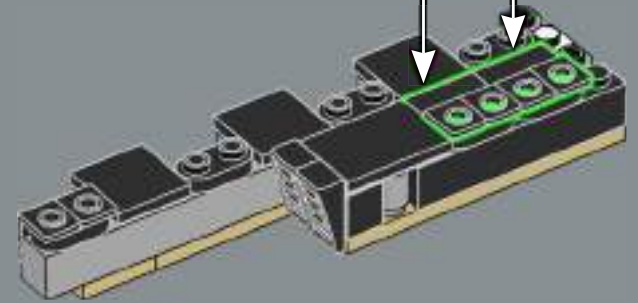

321

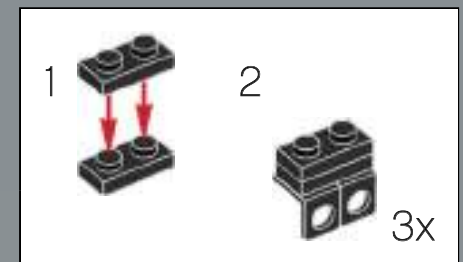
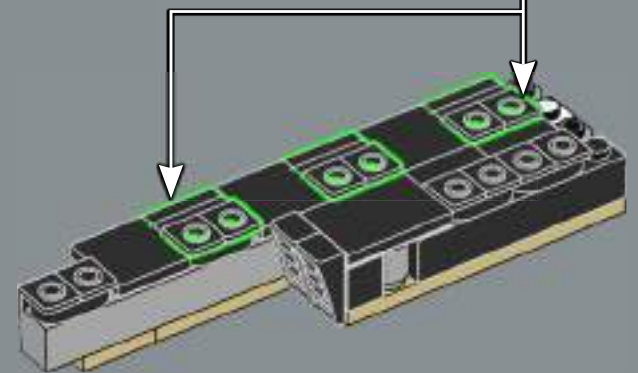

322

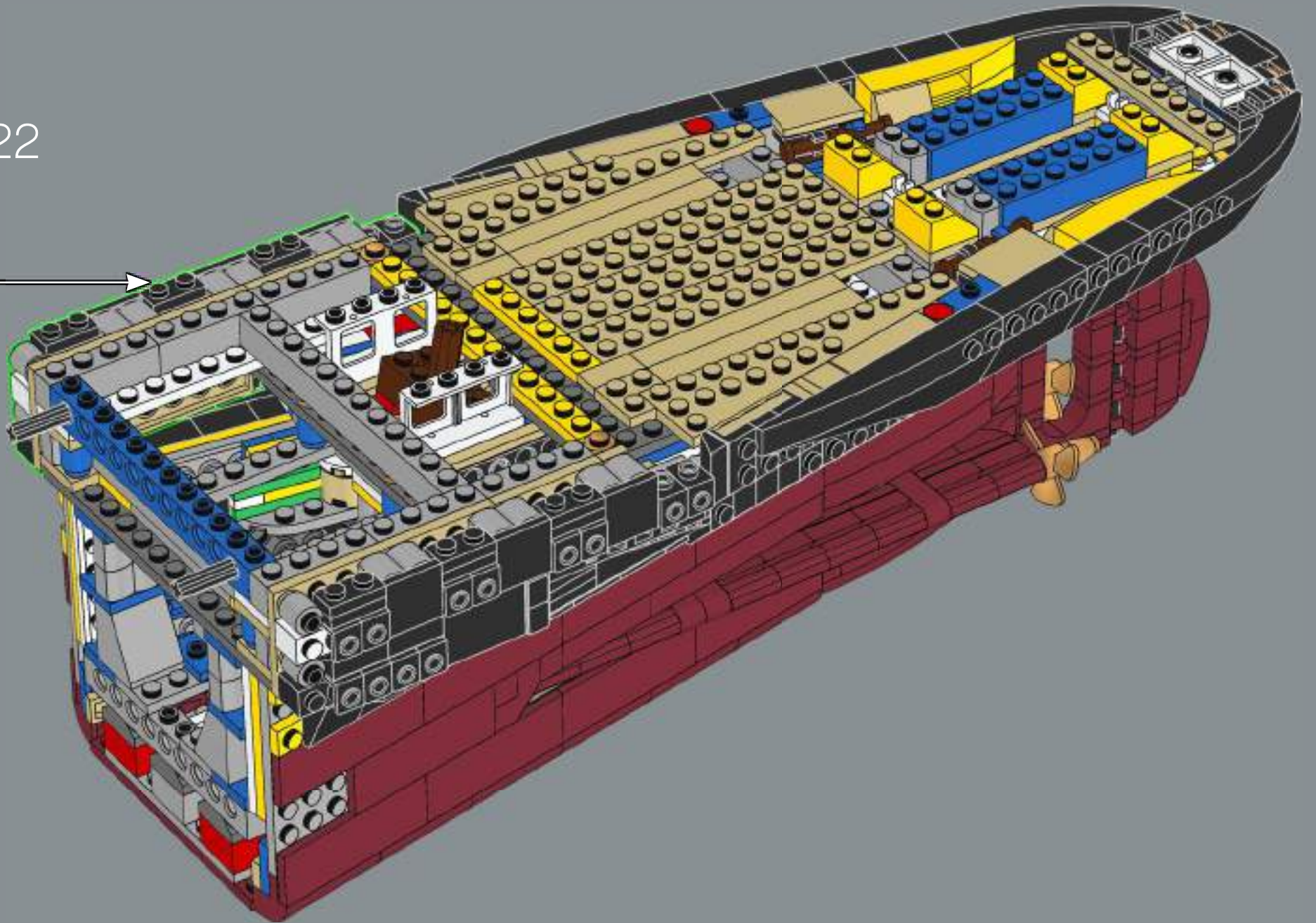



323

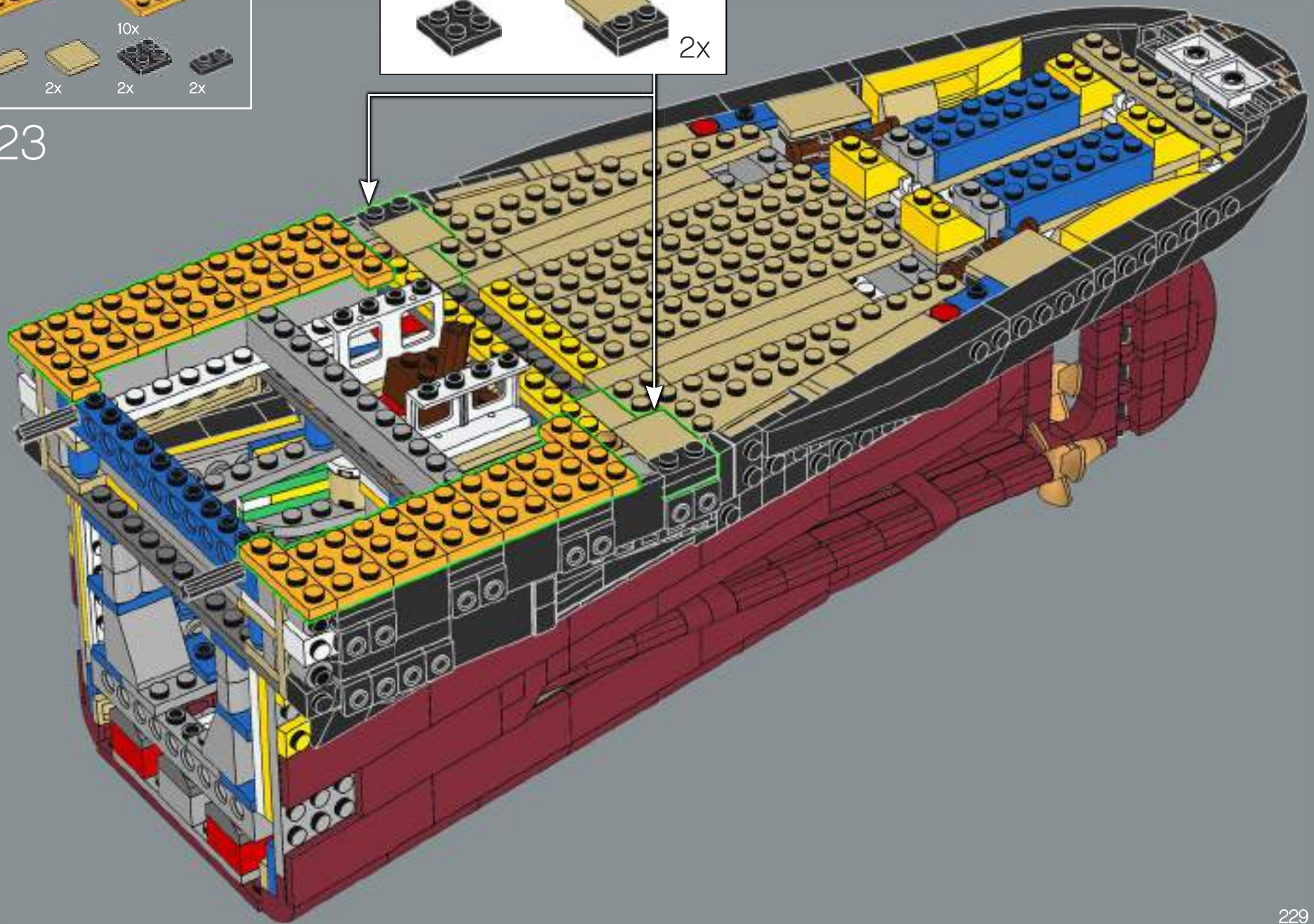

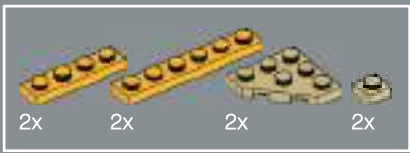

324

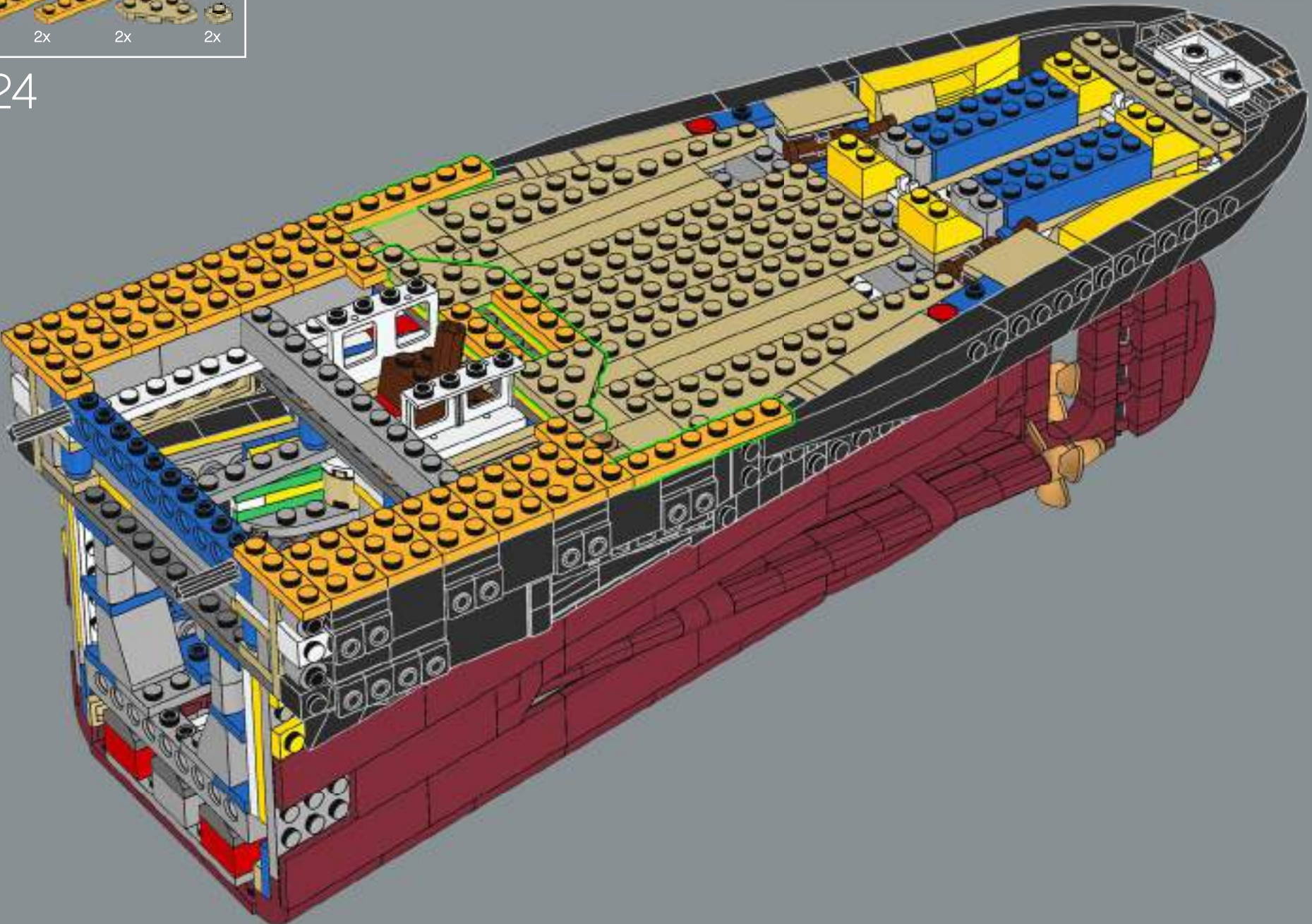

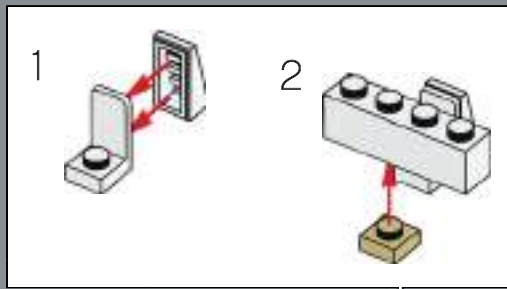
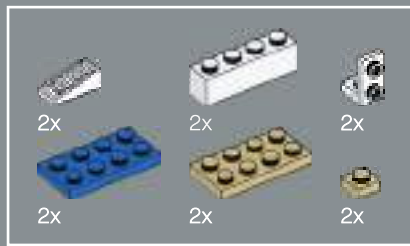

325

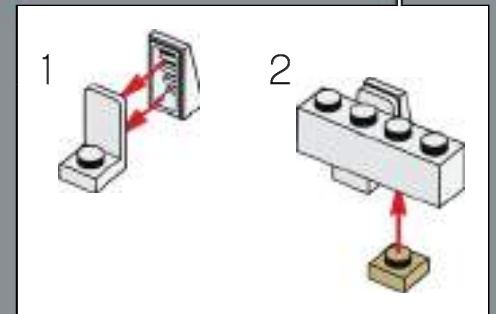
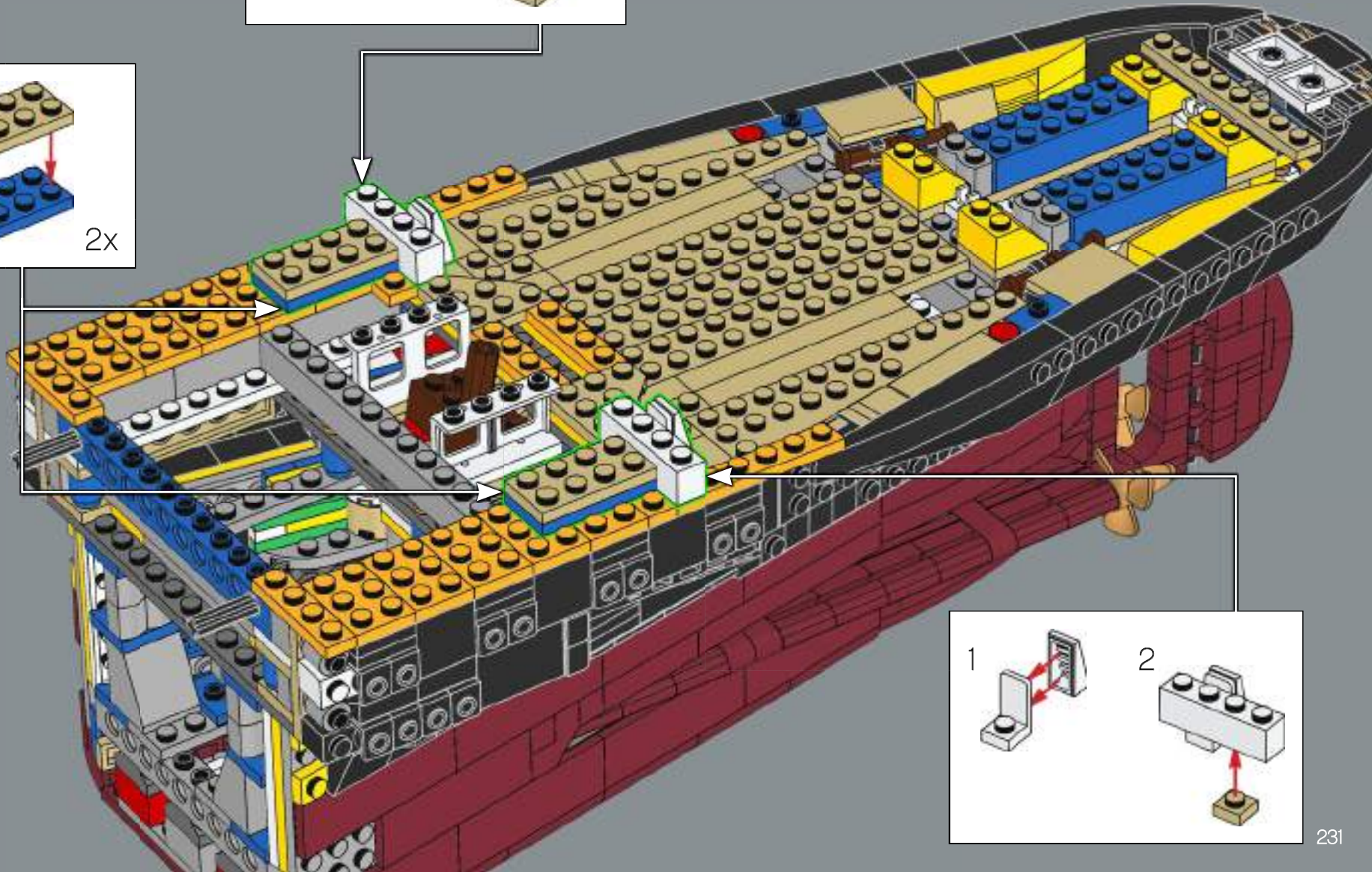
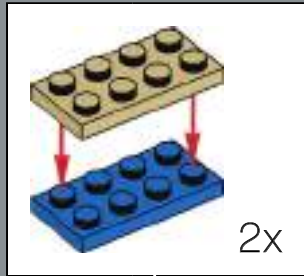

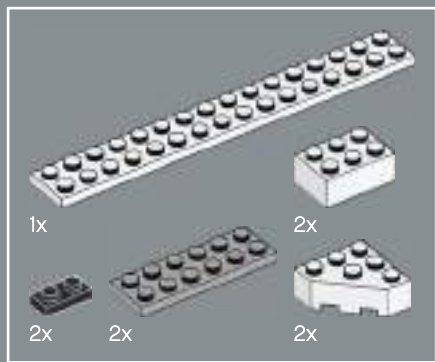

326

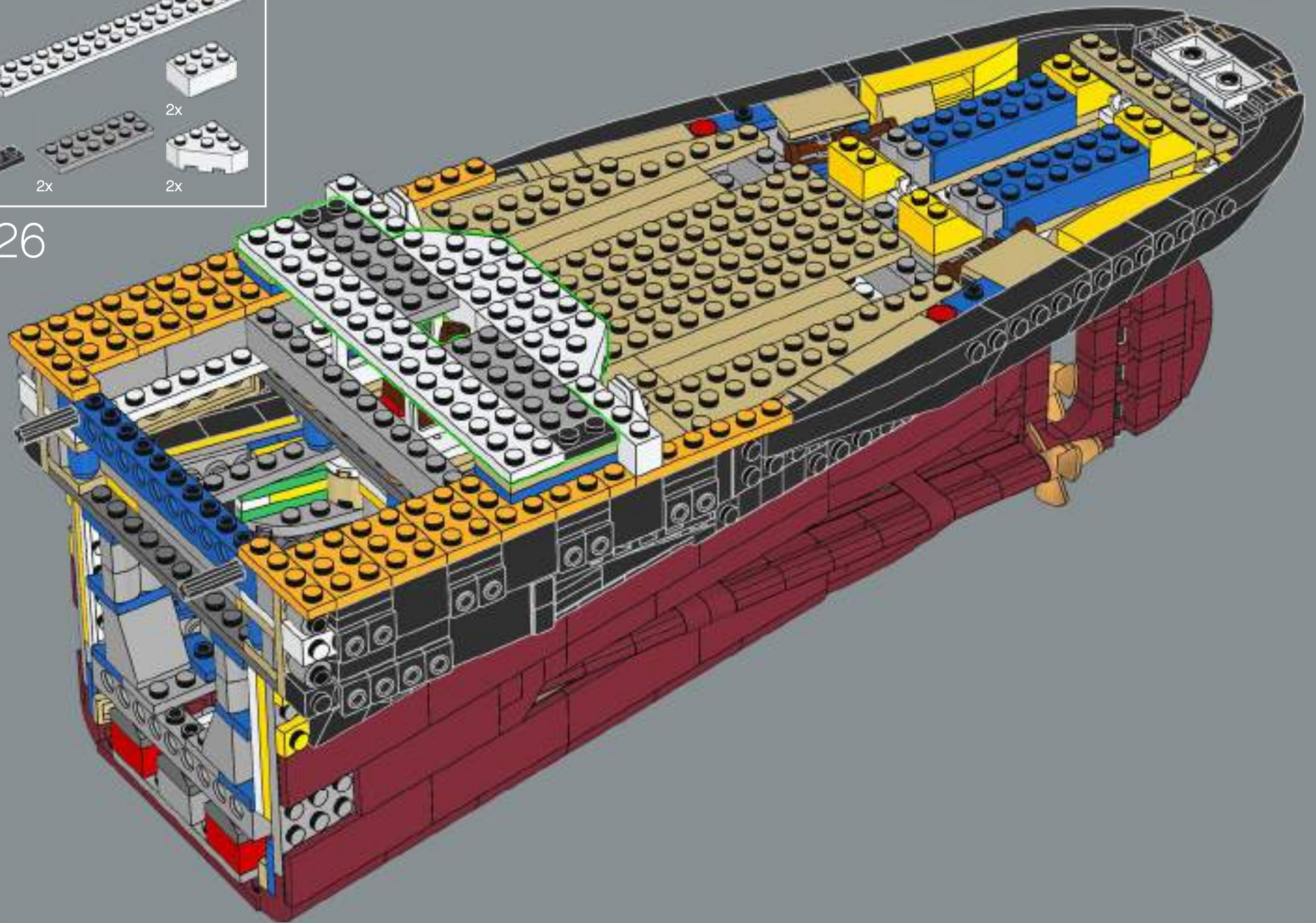

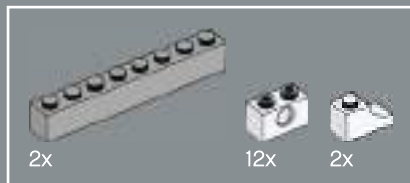

327

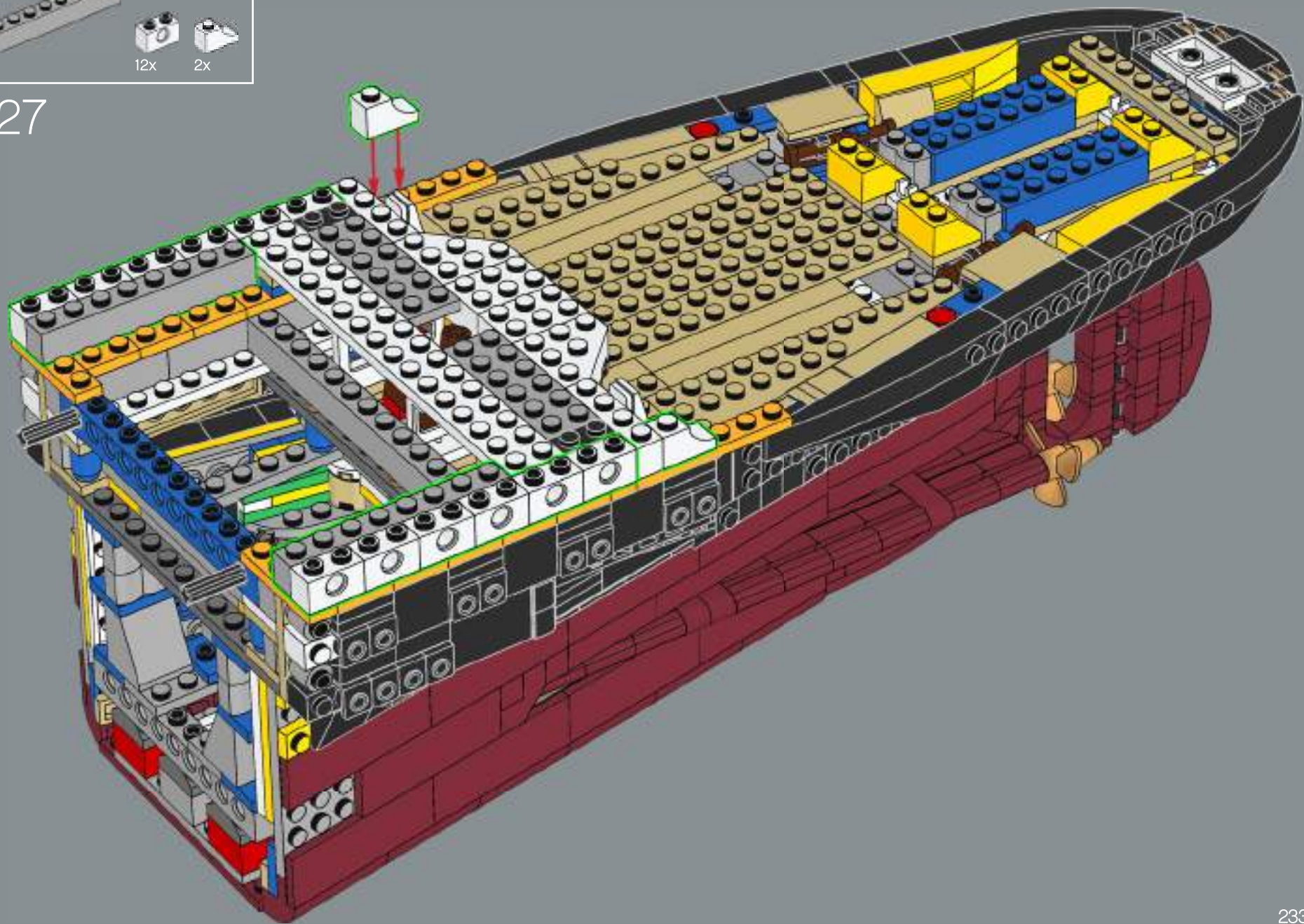

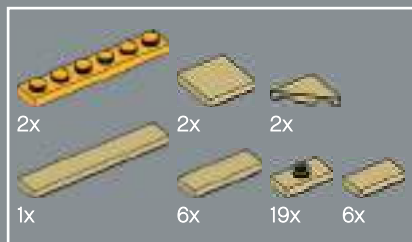

328

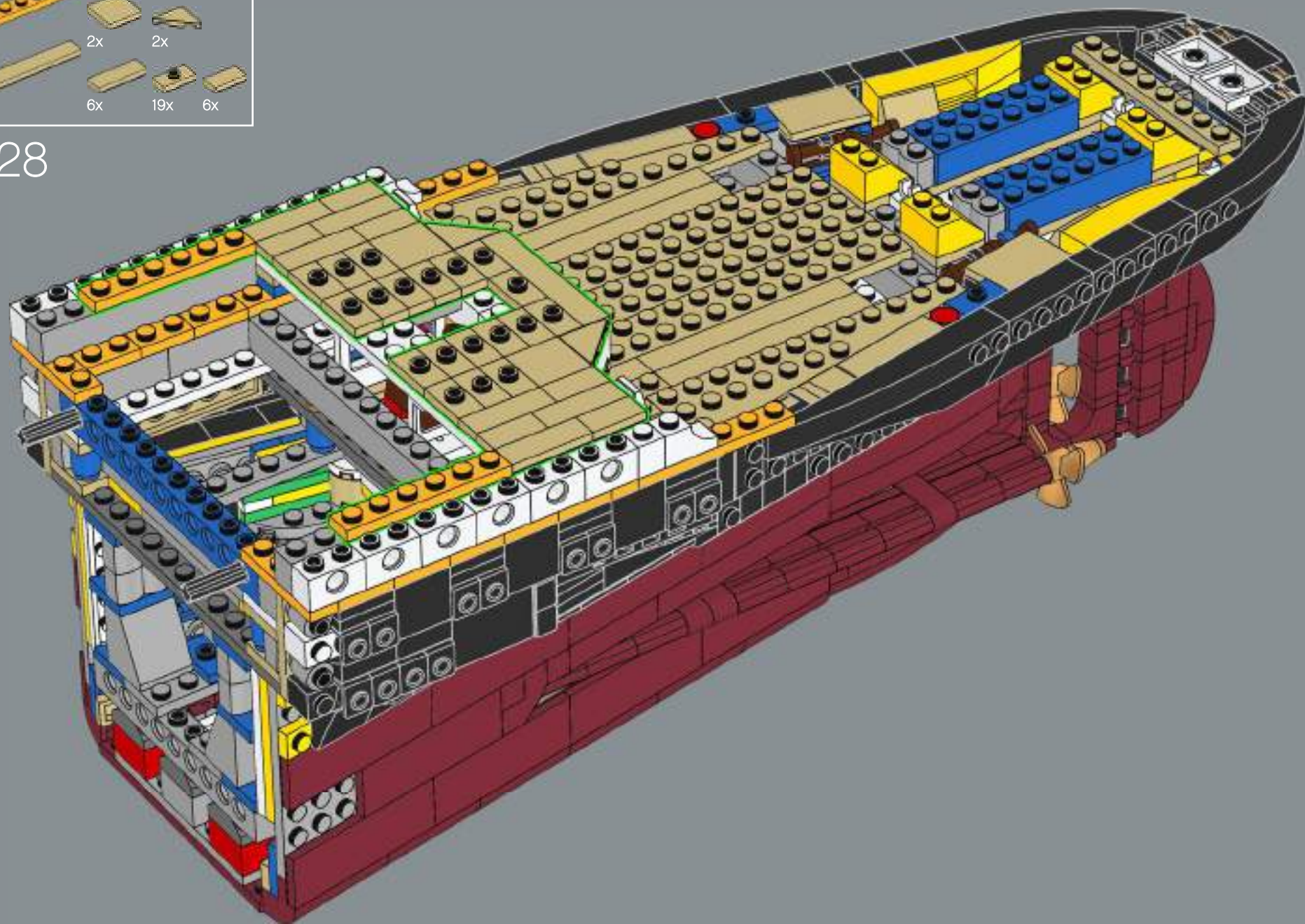

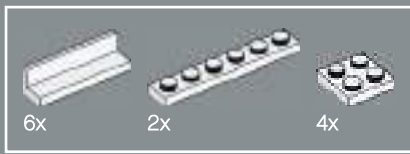

329

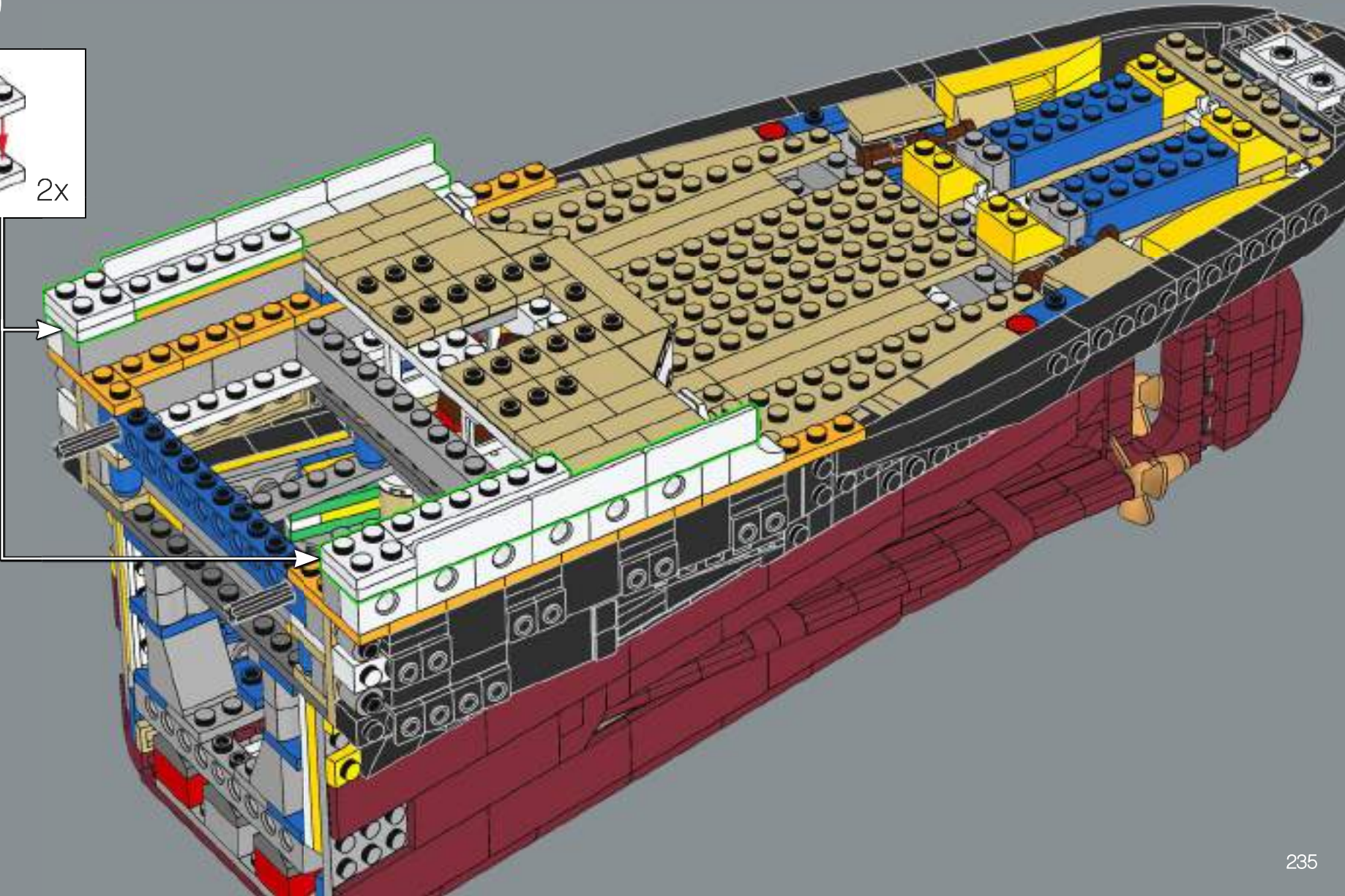
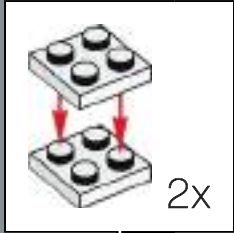

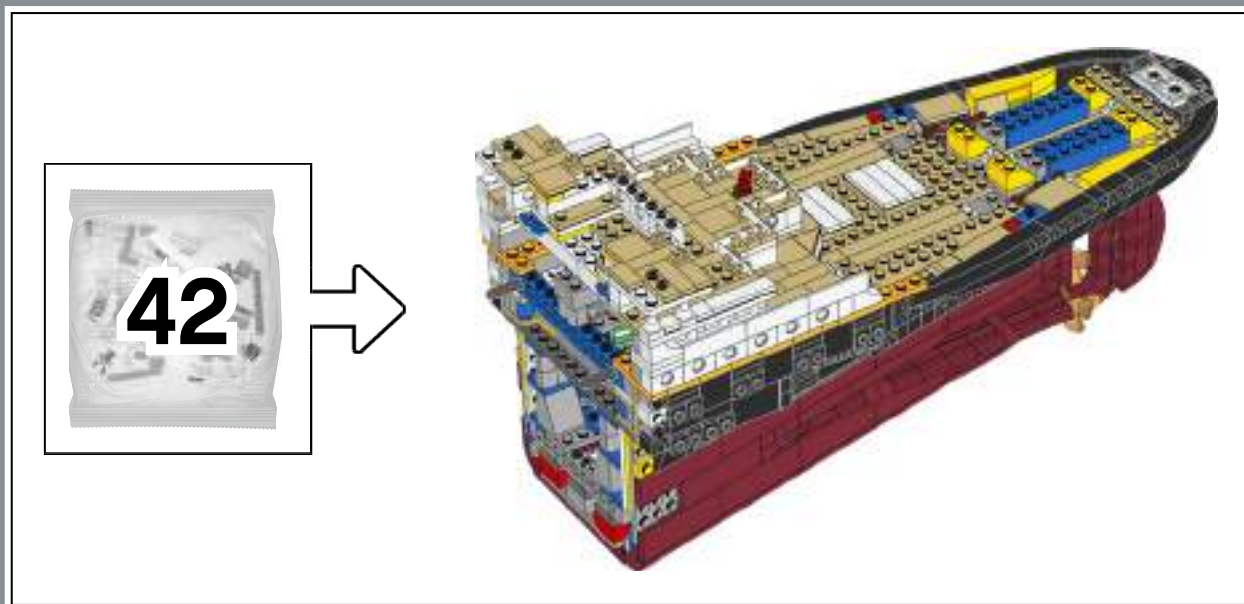



330

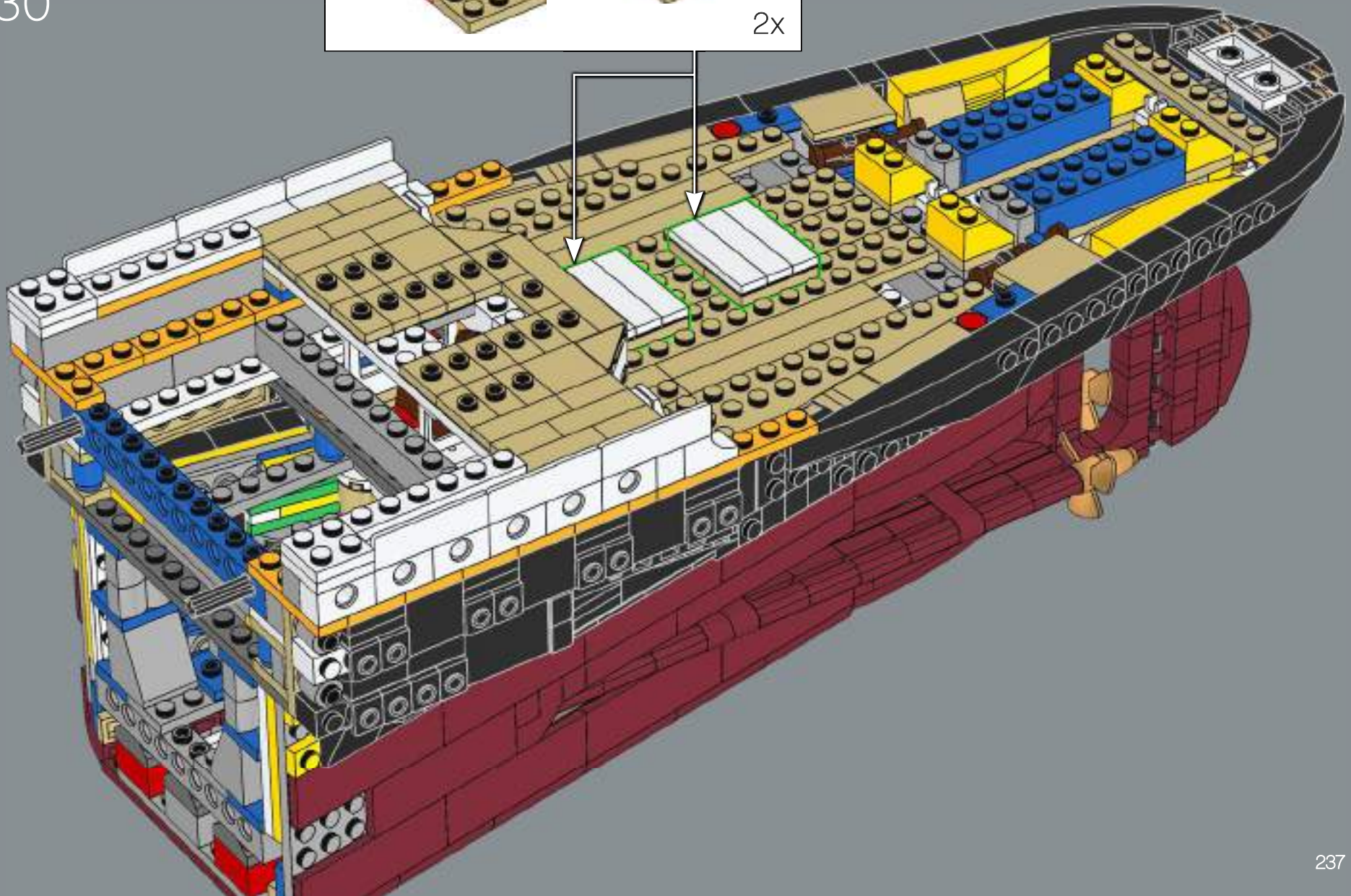
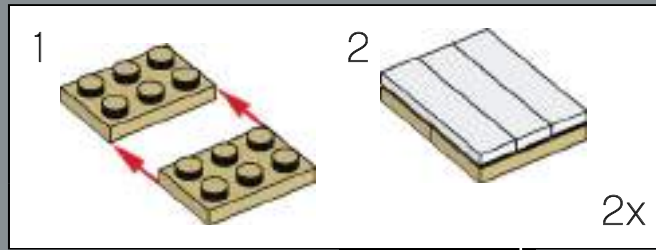

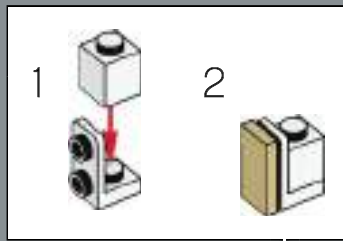

331

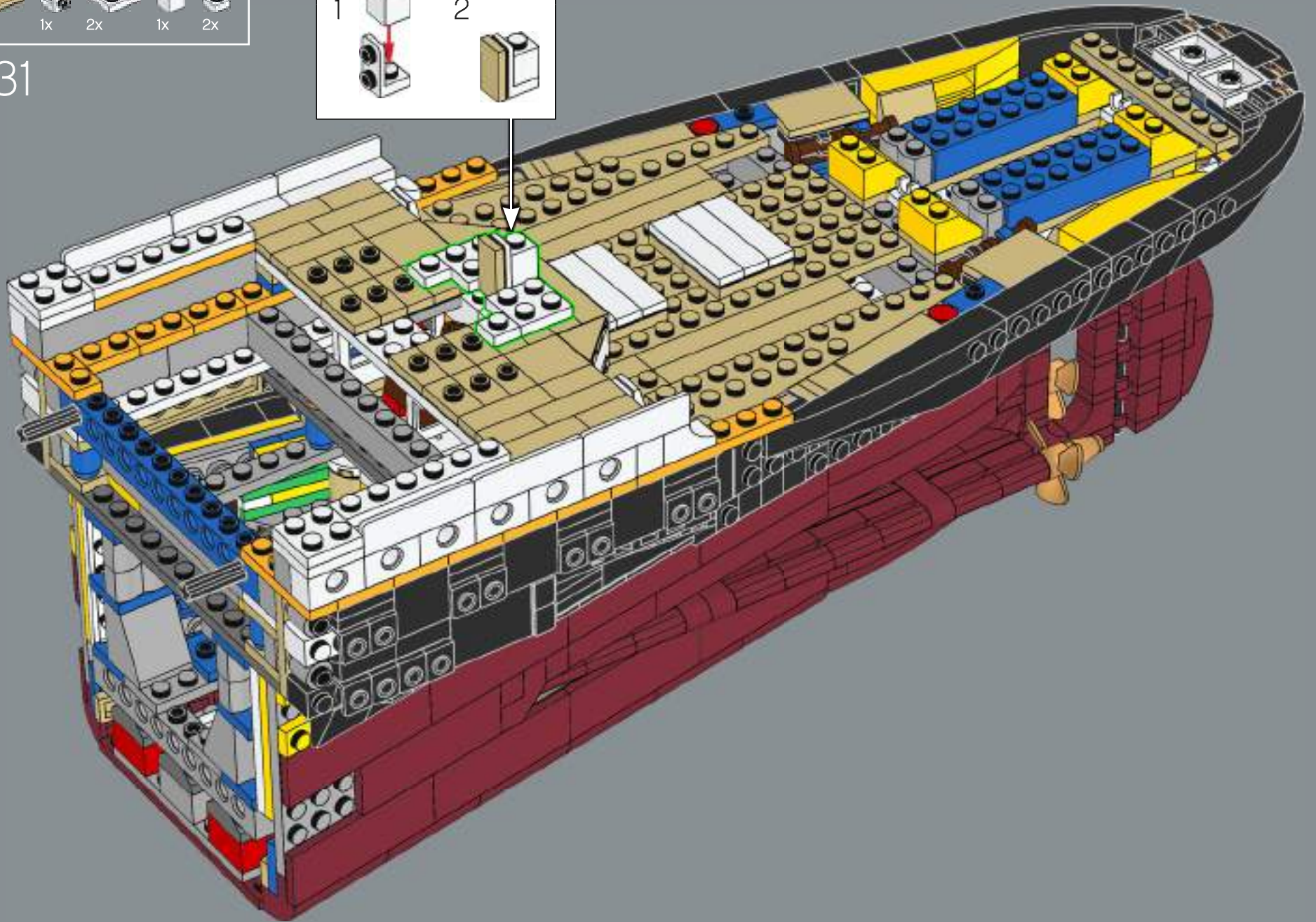



332

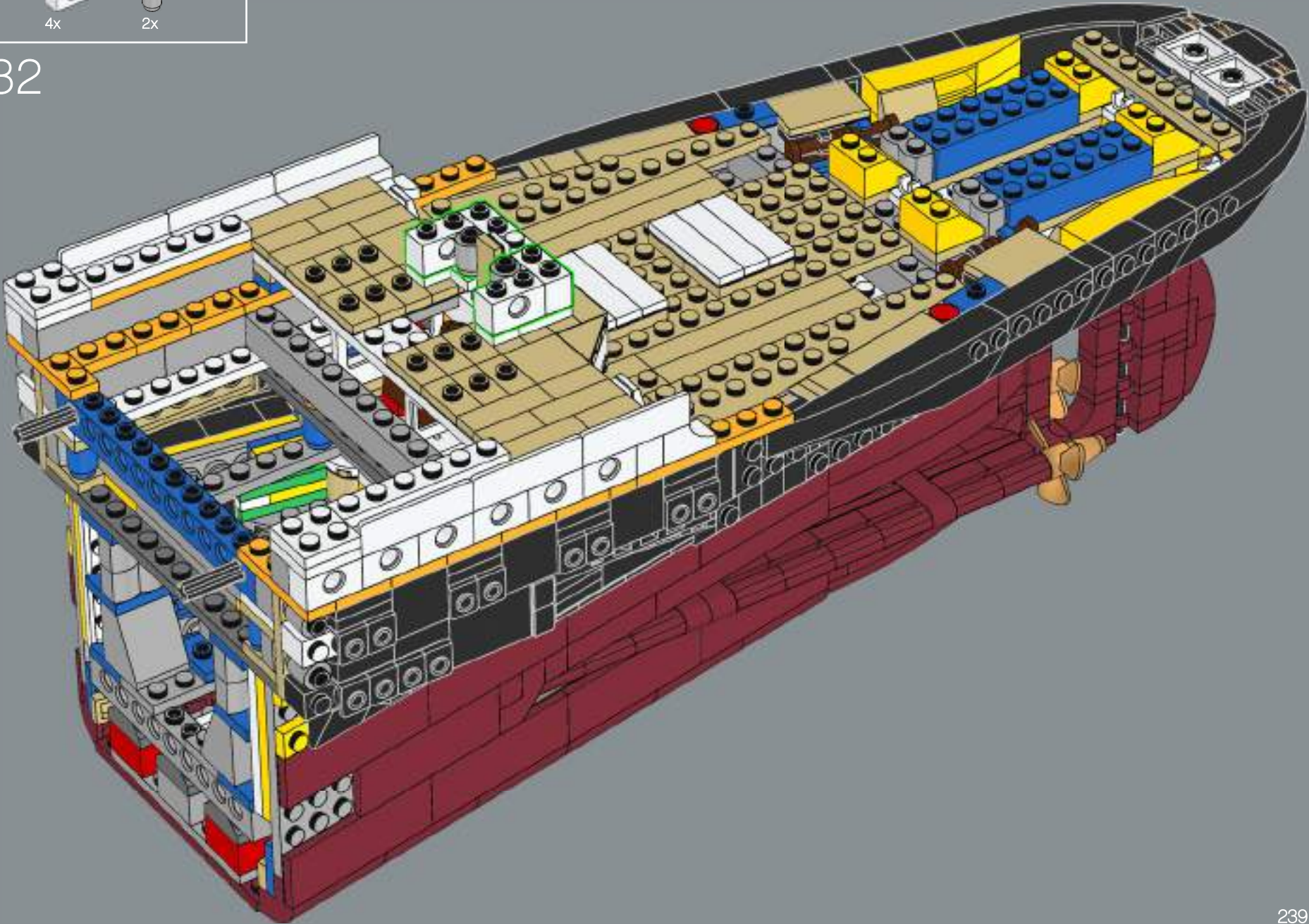



333

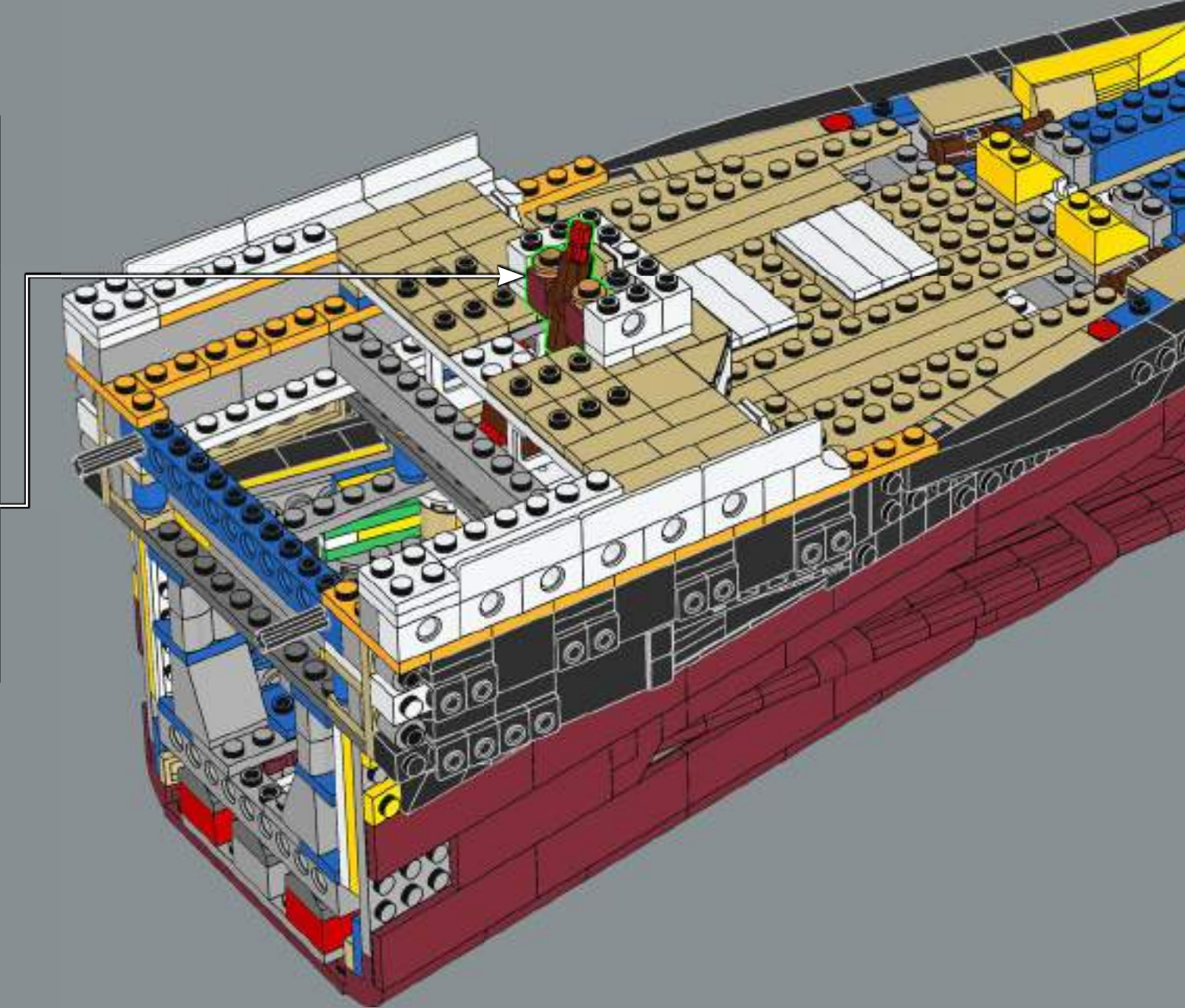
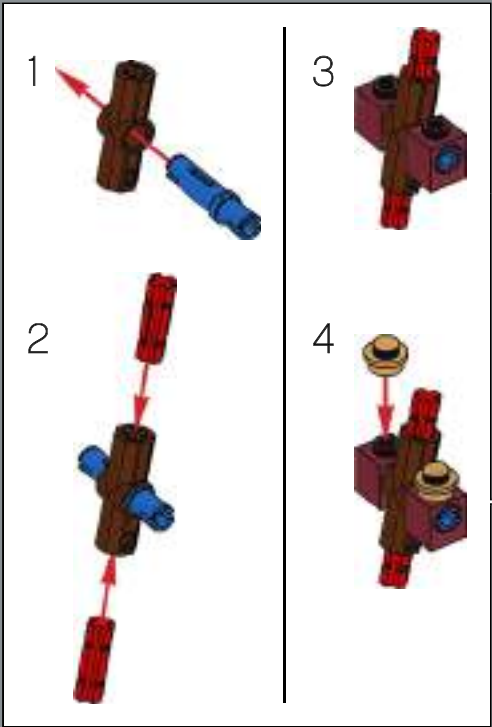

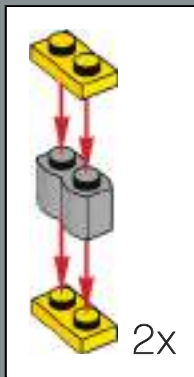
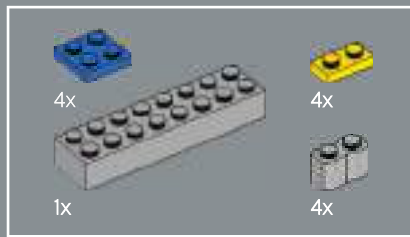

334

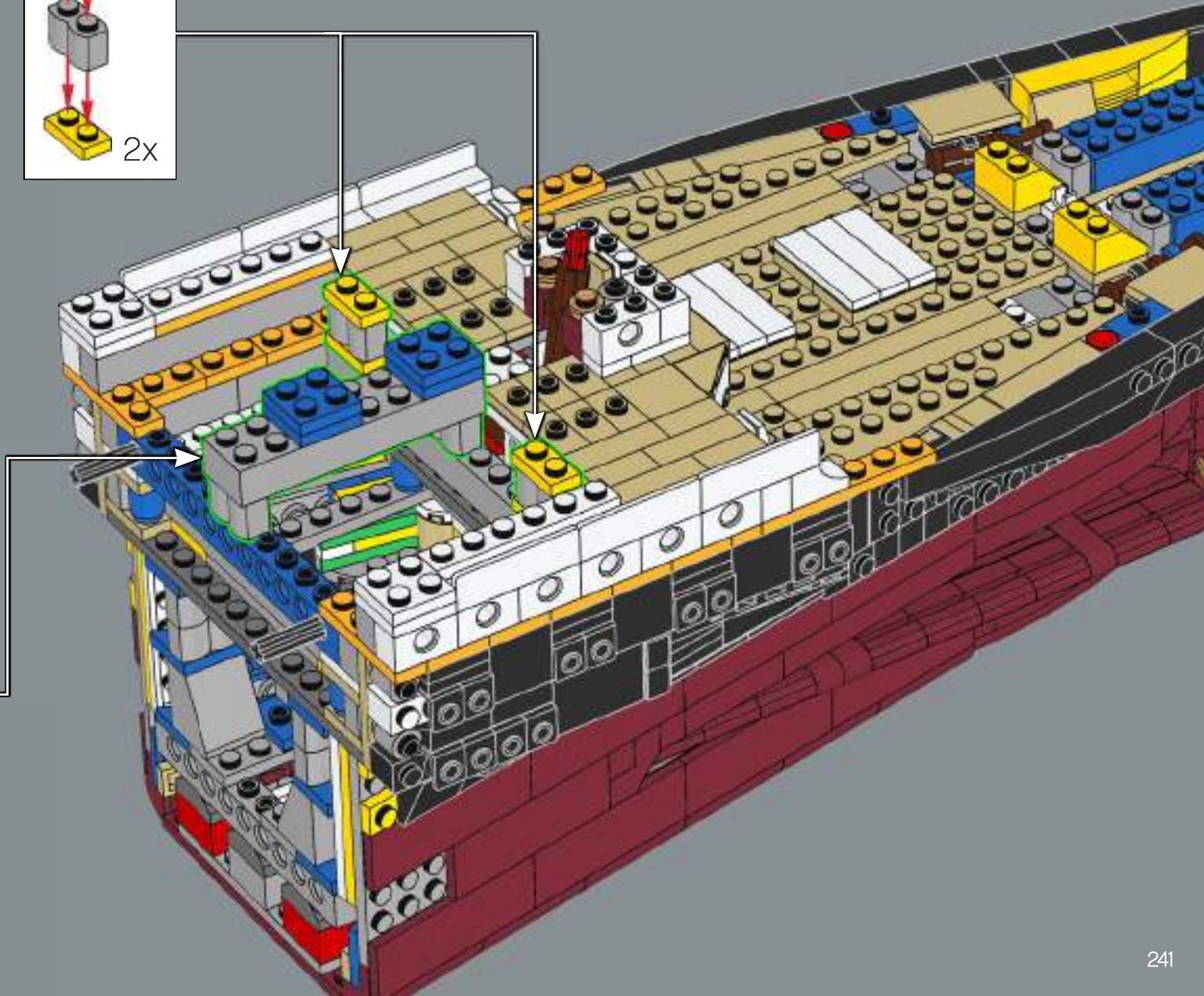
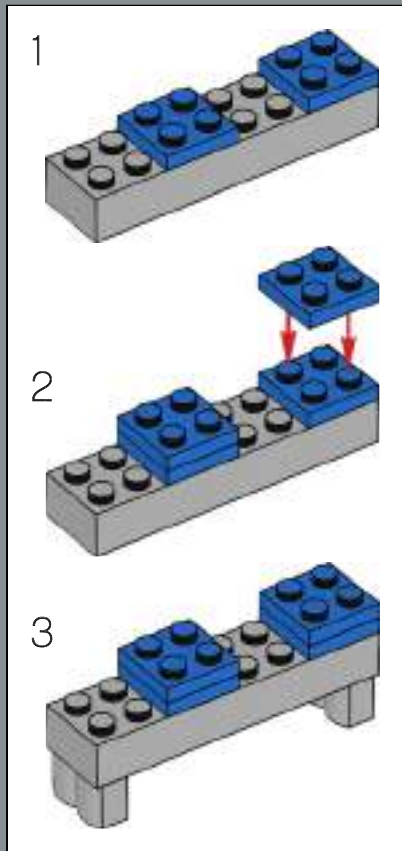

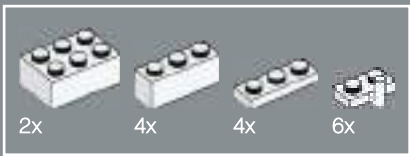

335

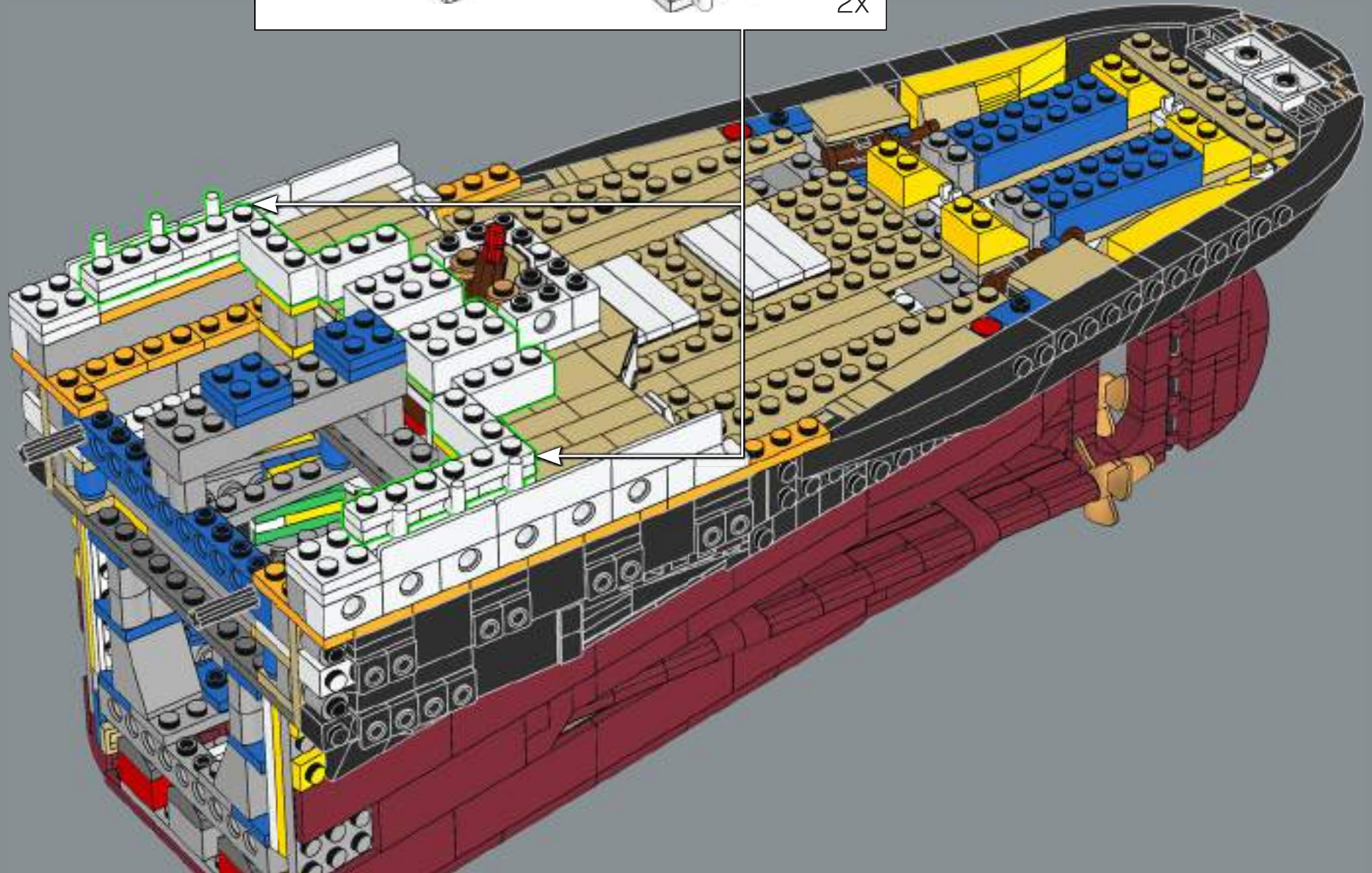
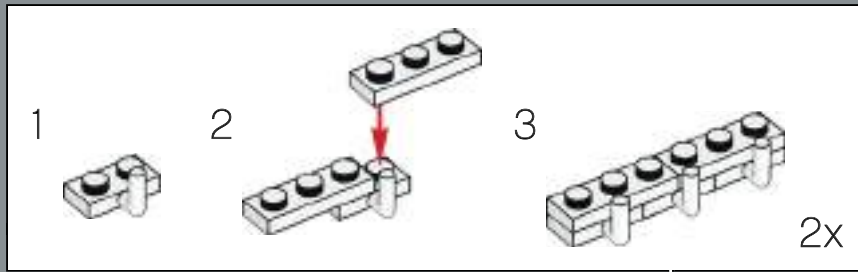

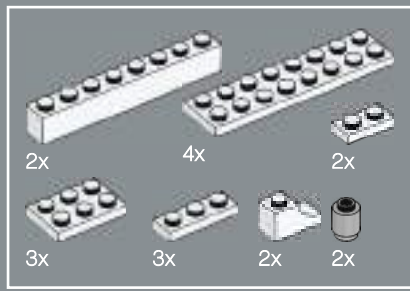

336

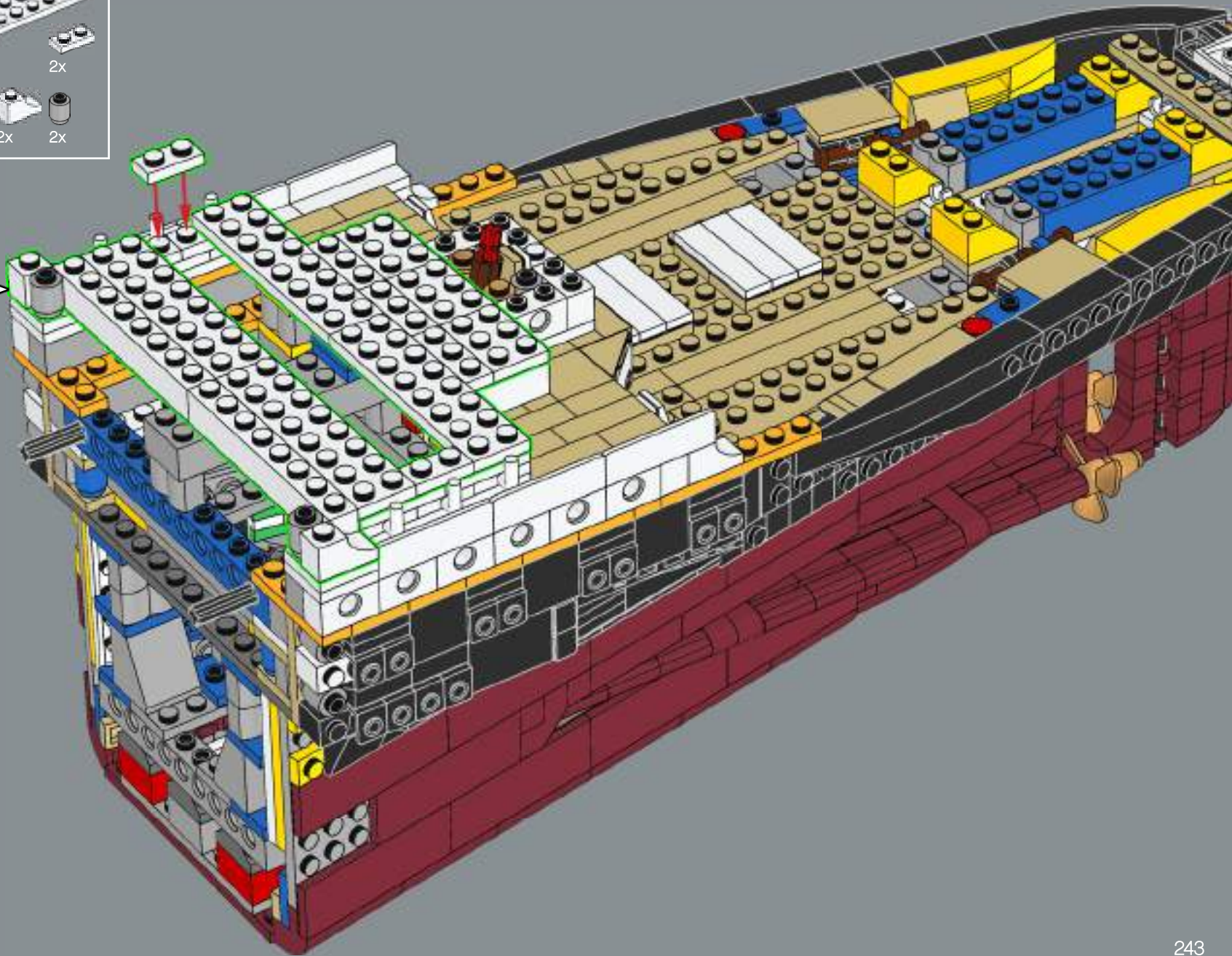

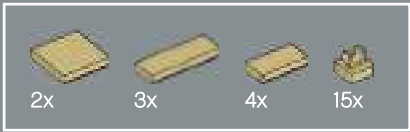

337

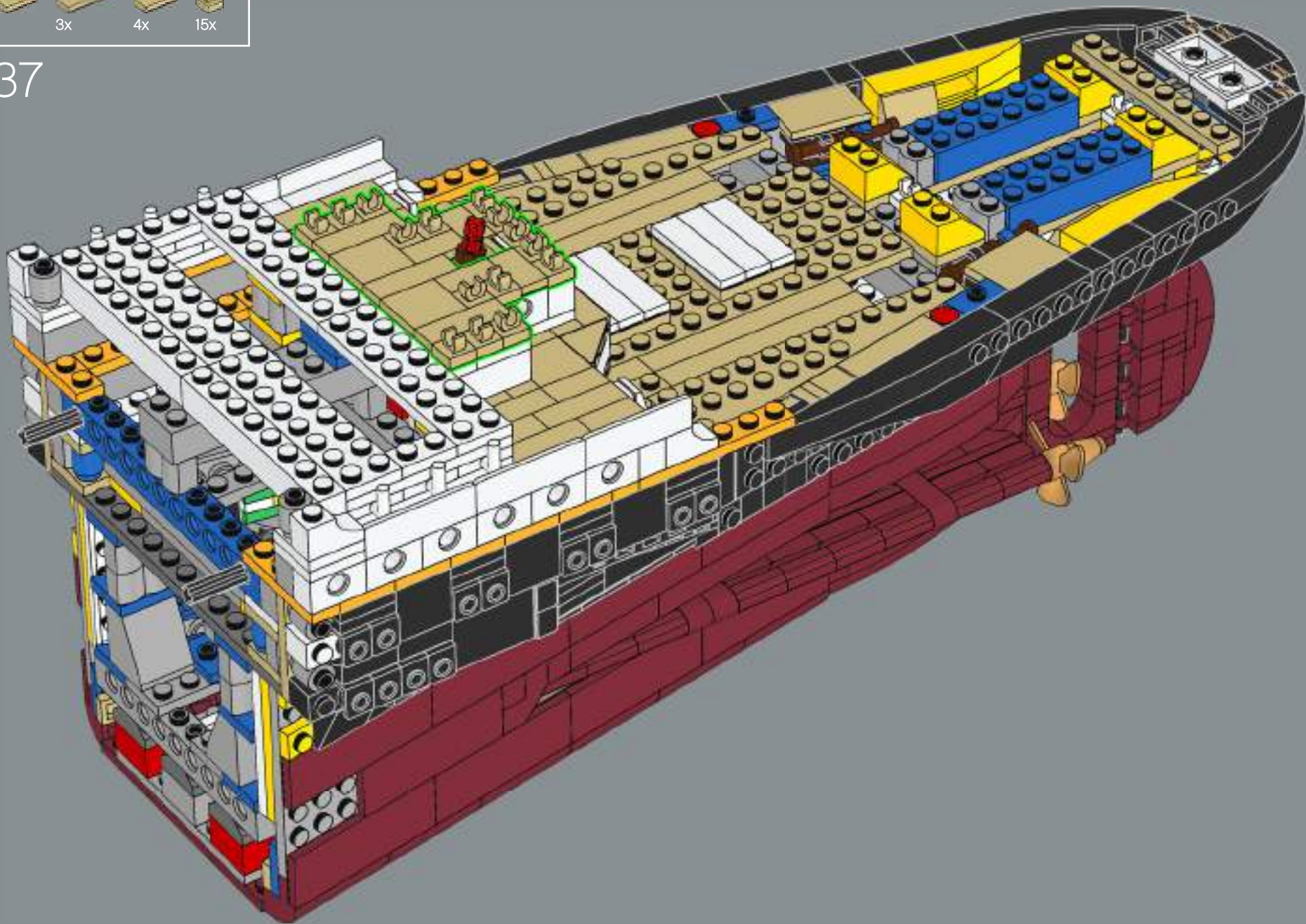

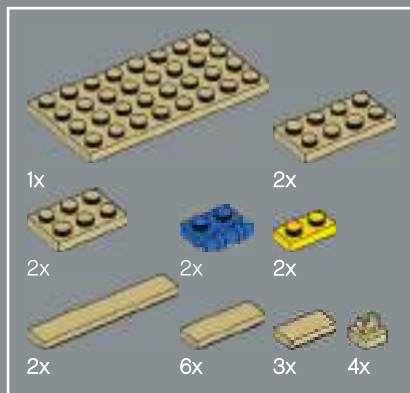

338

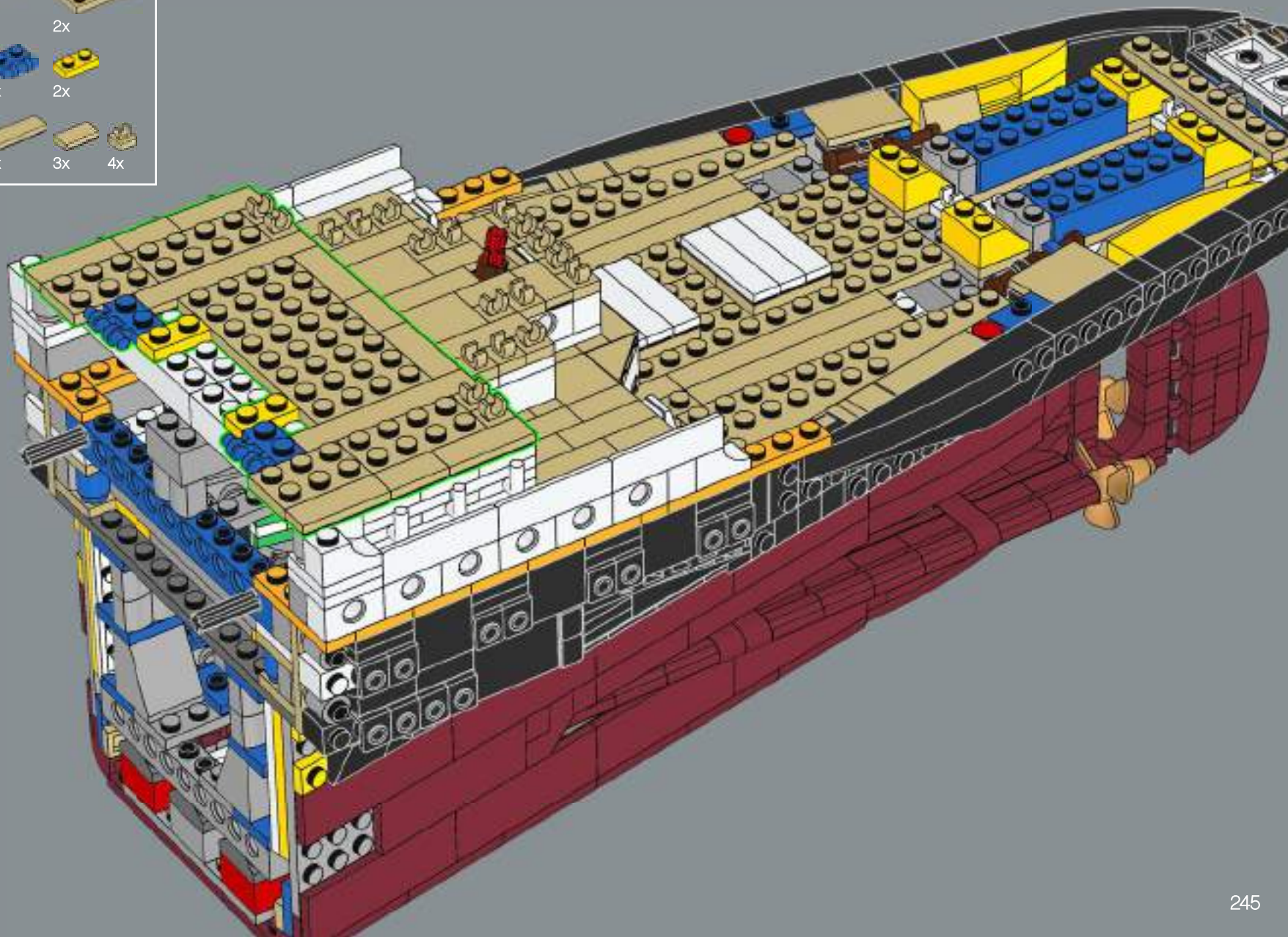

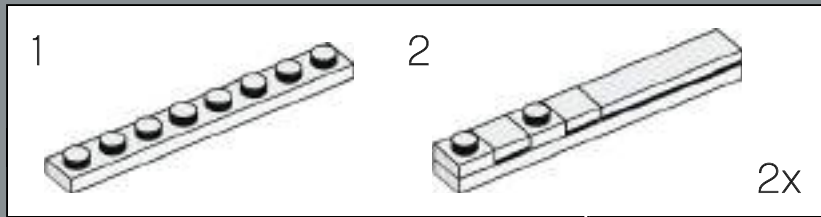
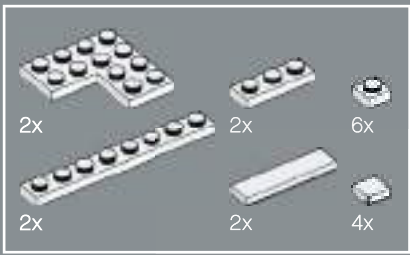

339

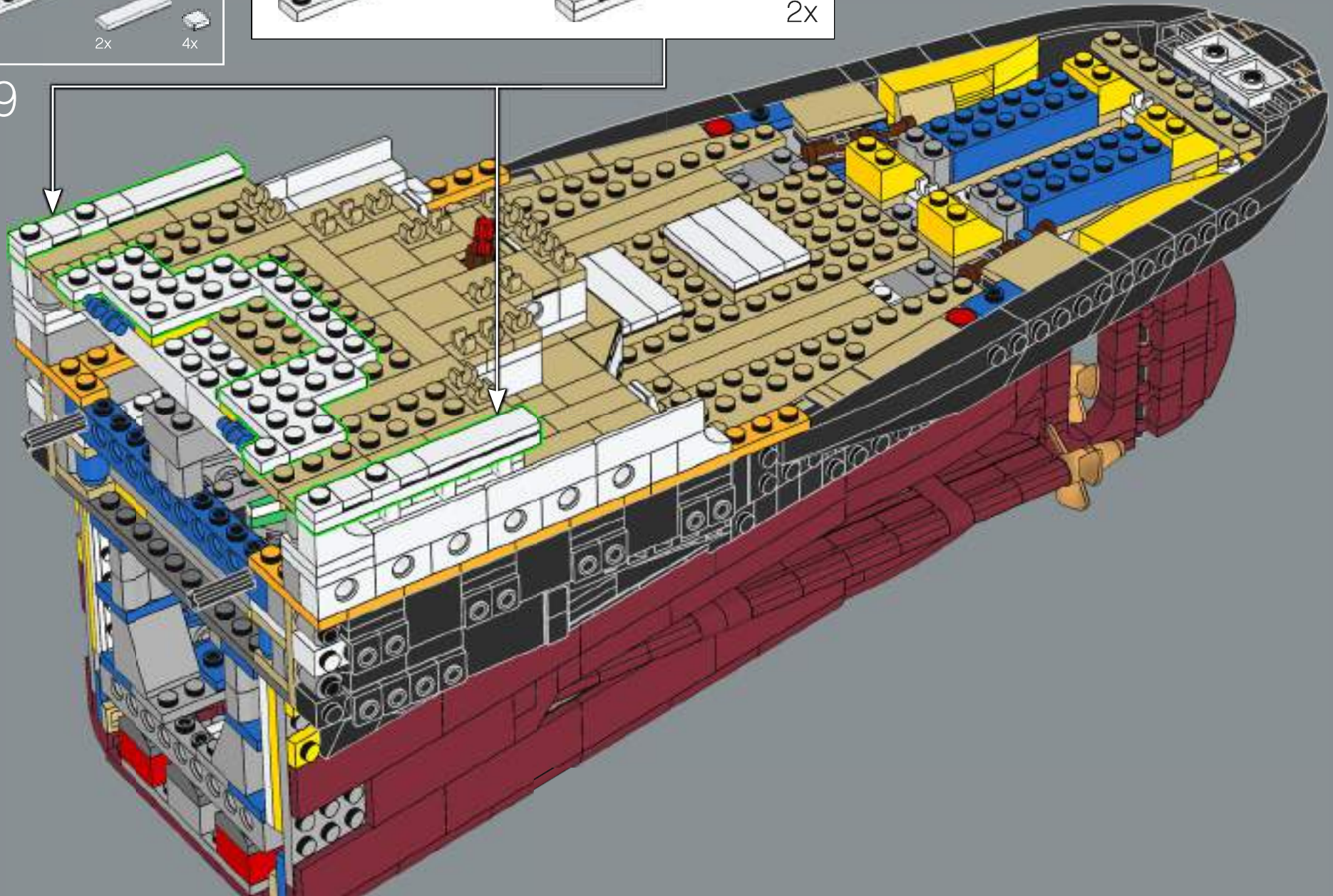

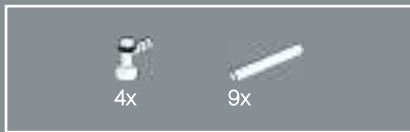

340

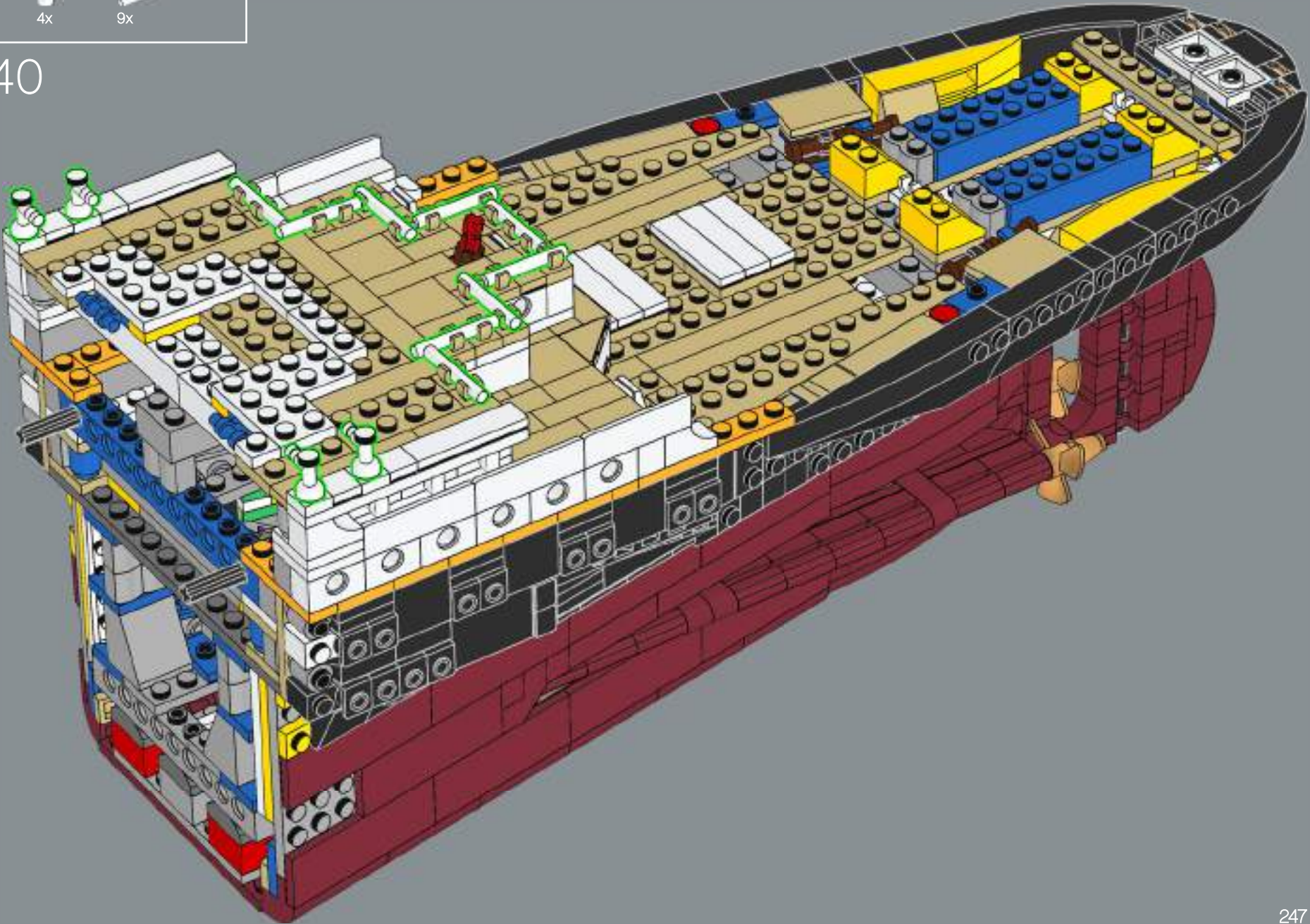

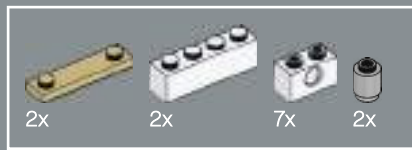

341

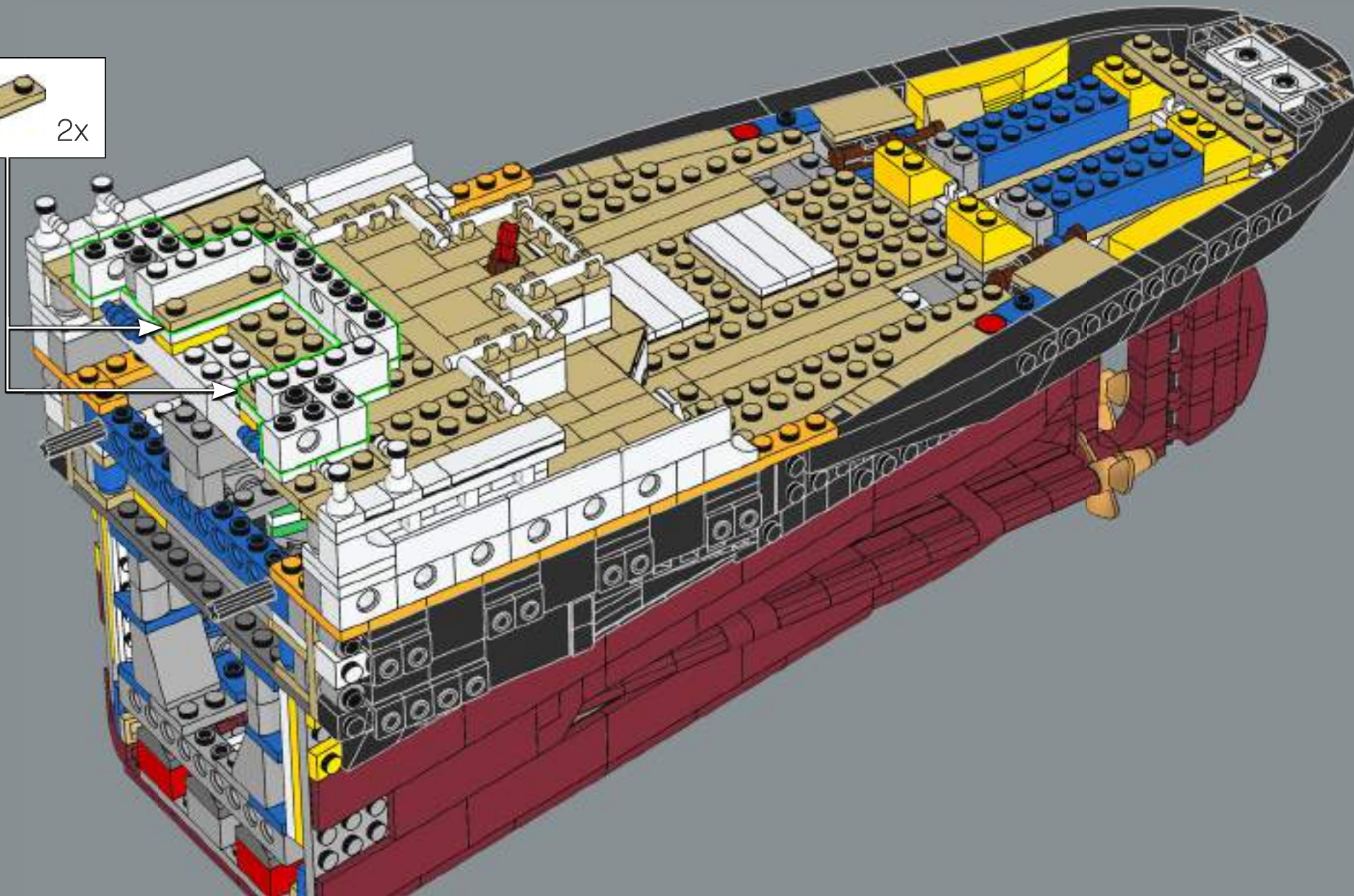

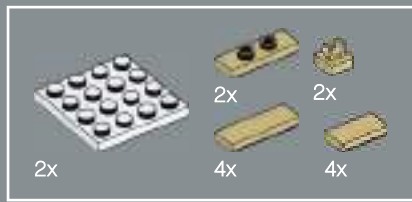

342

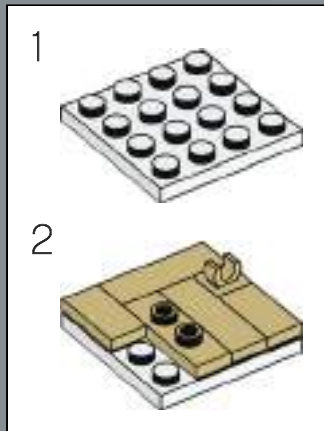
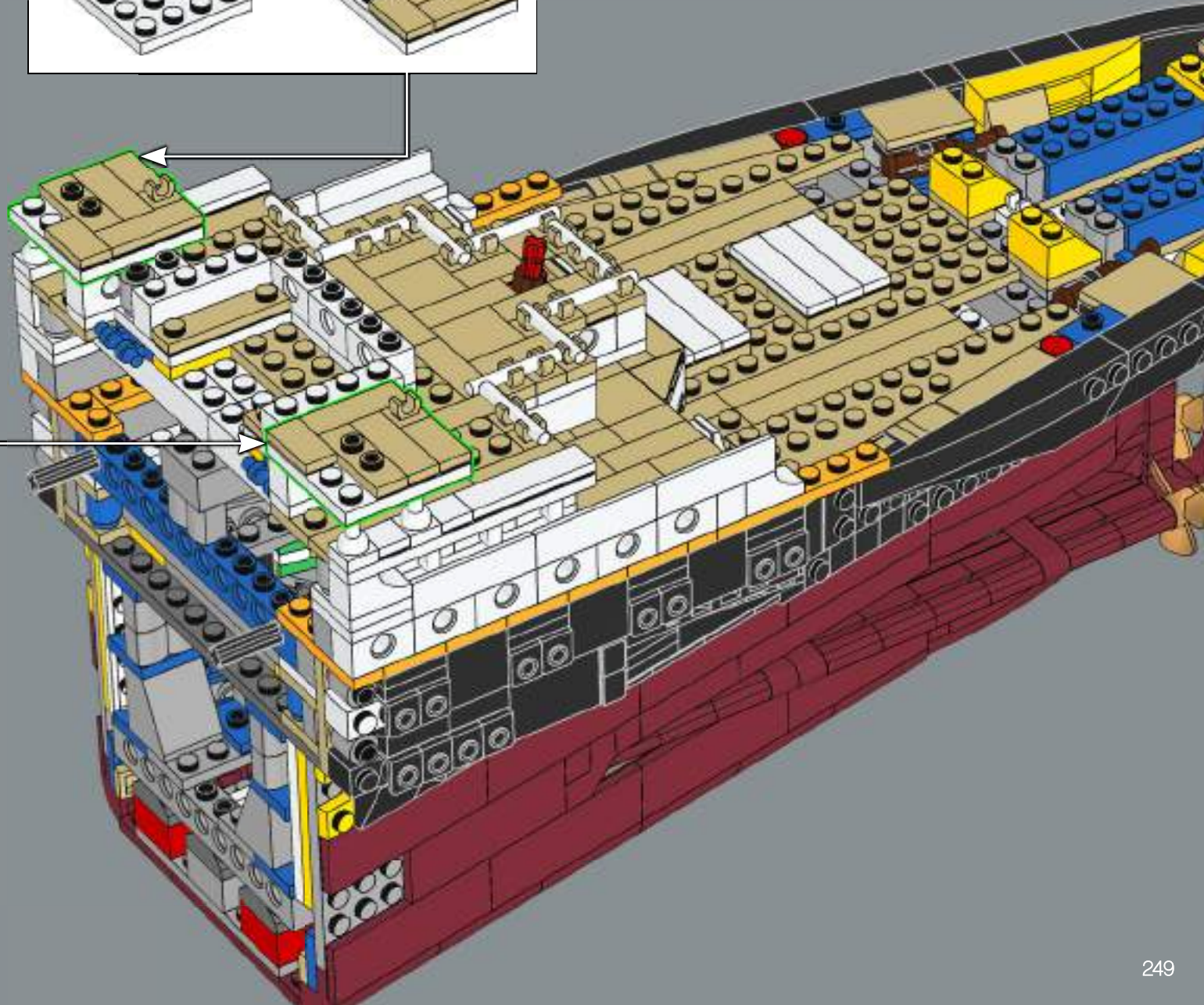
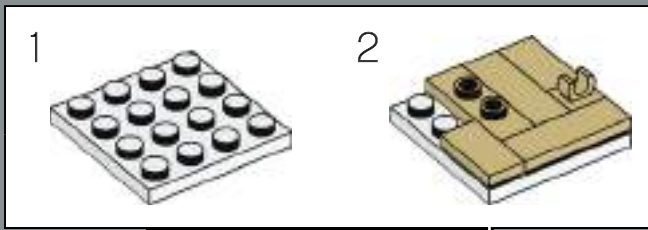



343

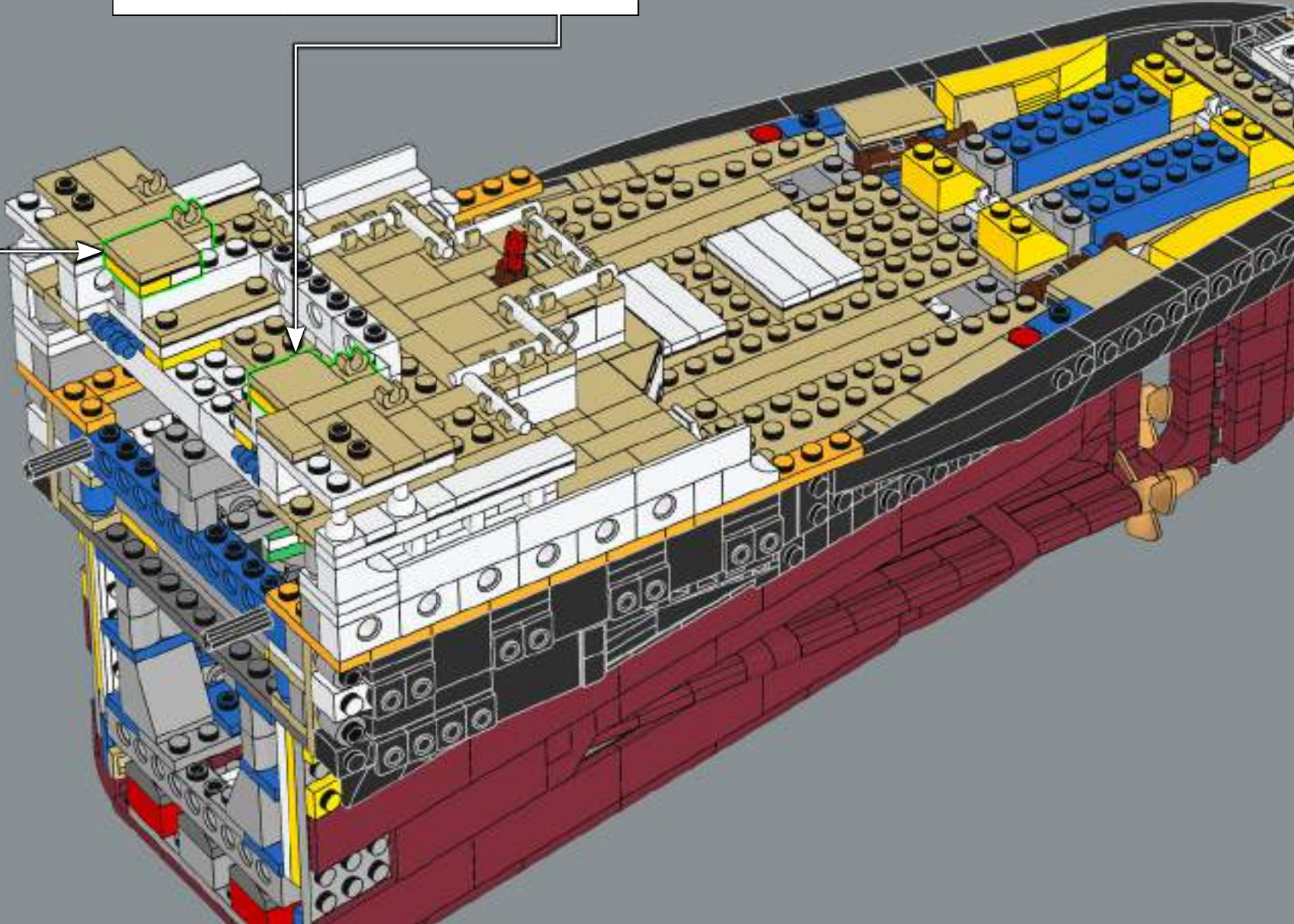
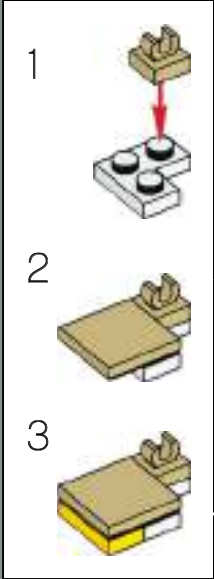
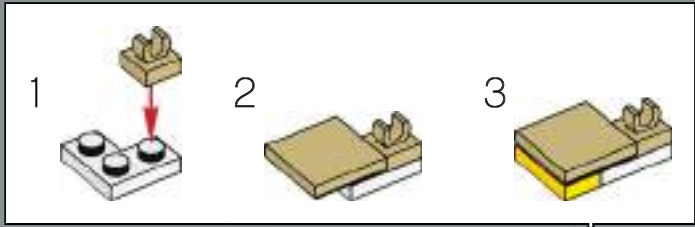

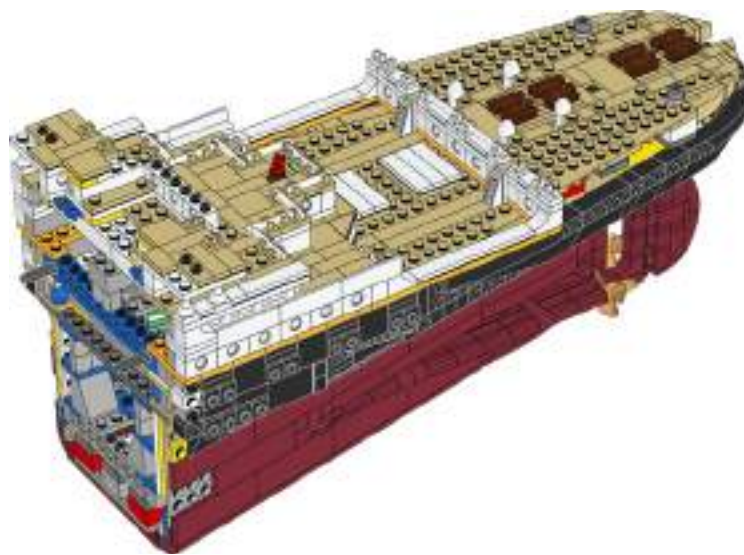

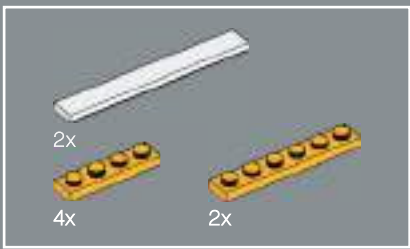

344

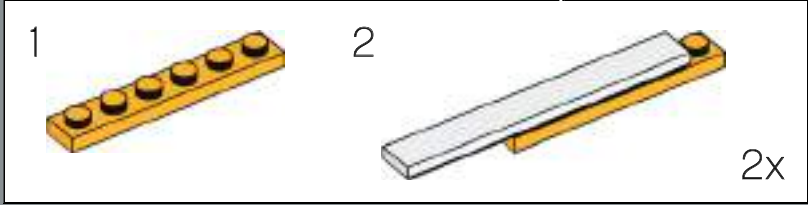
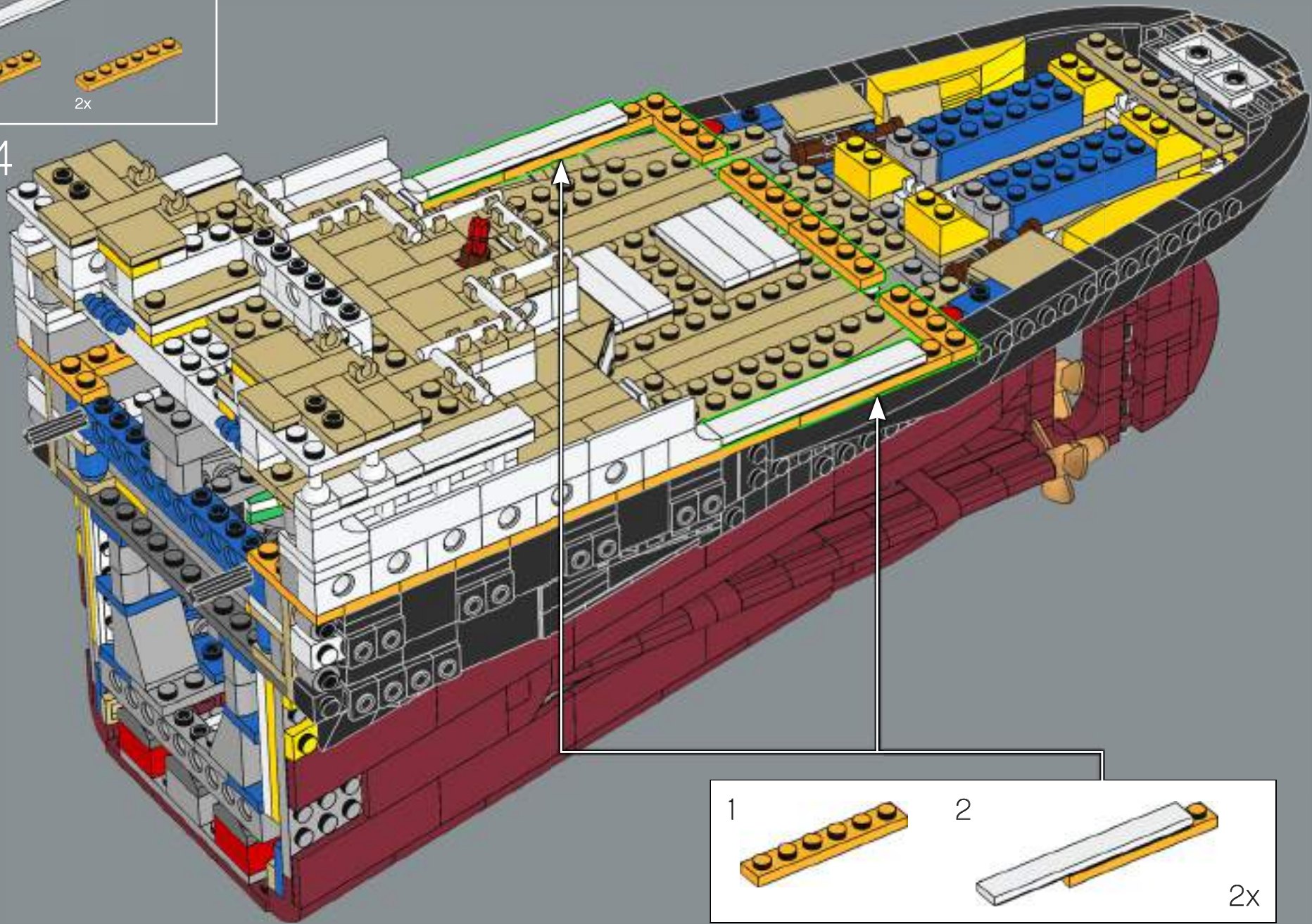

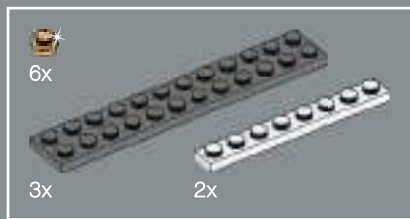

345

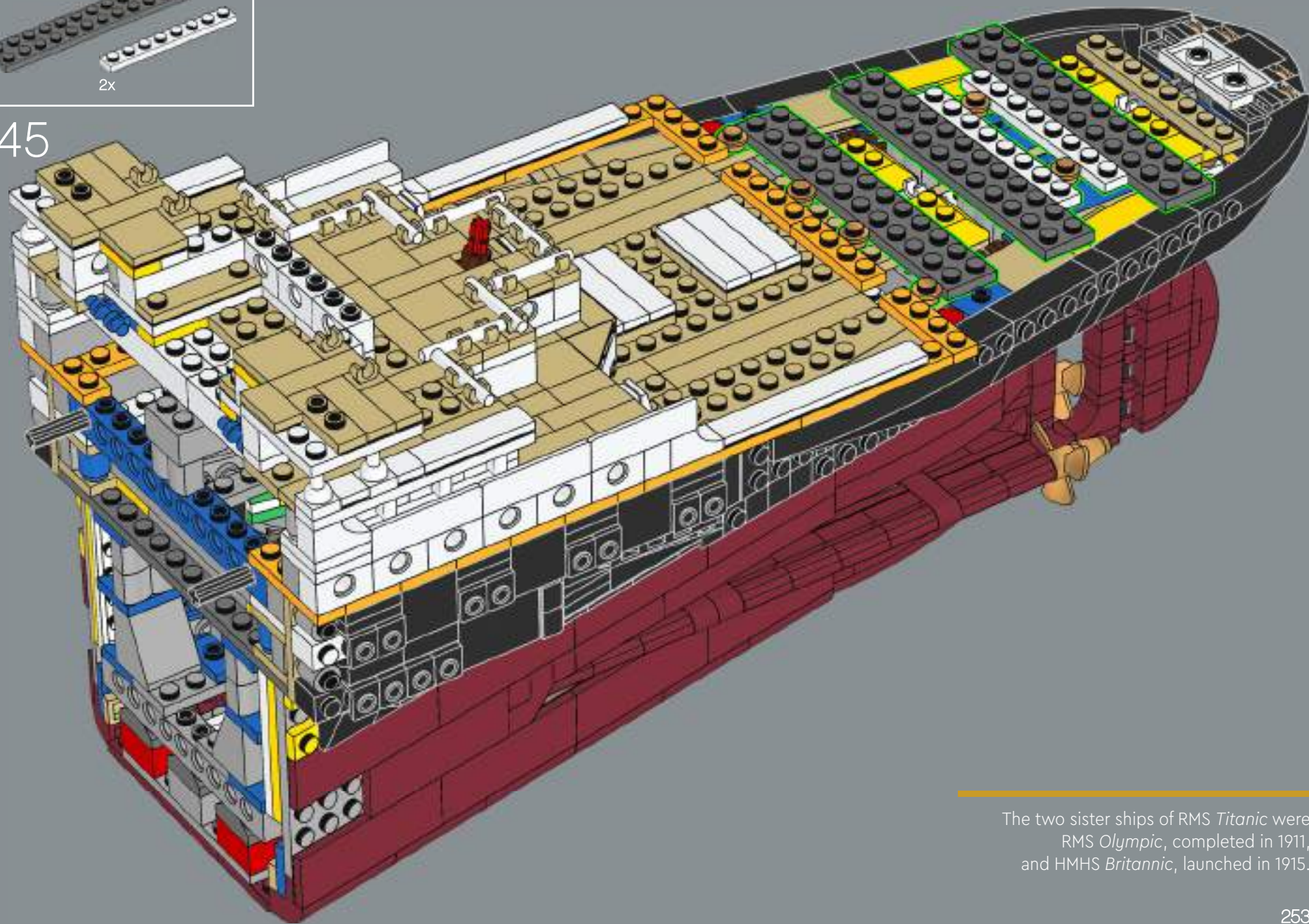

The two sister ships of RMS *Titanic* were RMS *Olympic*, completed in 1911, and HMHS *Britannic*, launched in 1915.



346

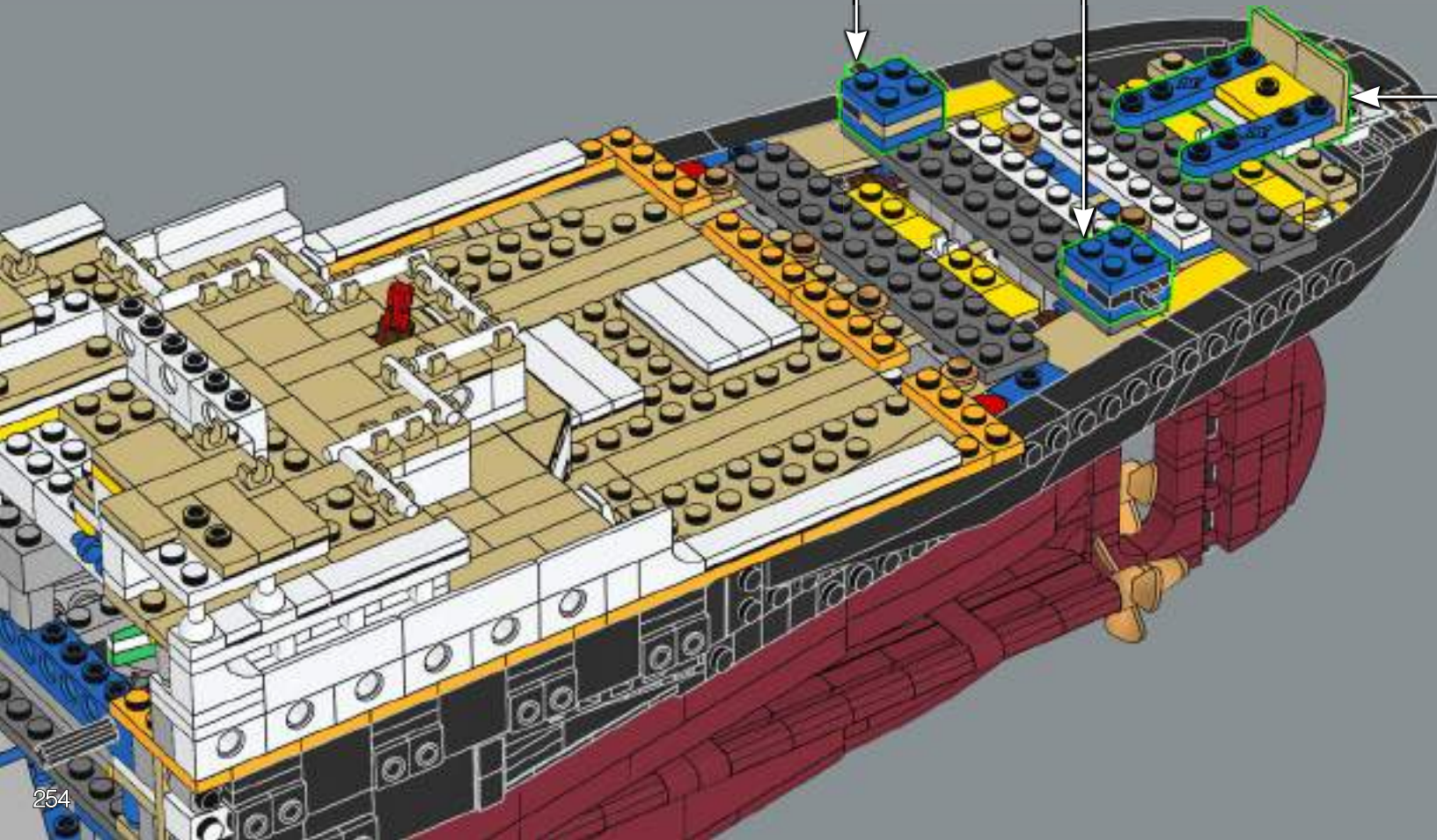
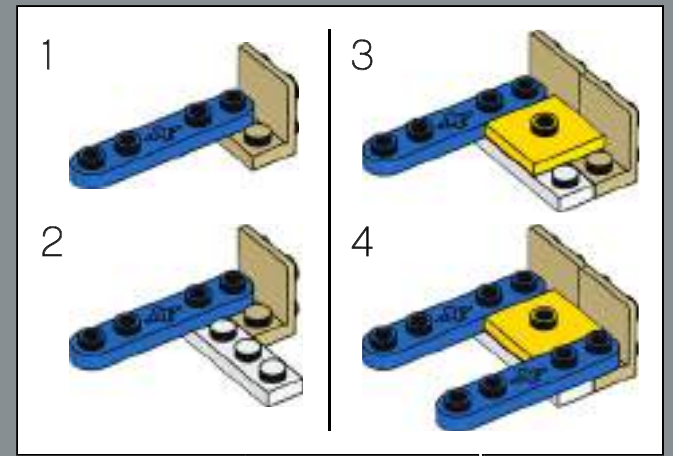
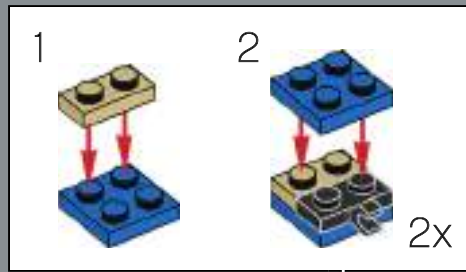

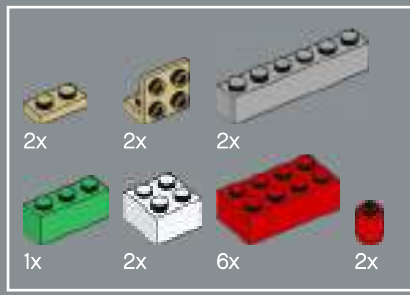

347

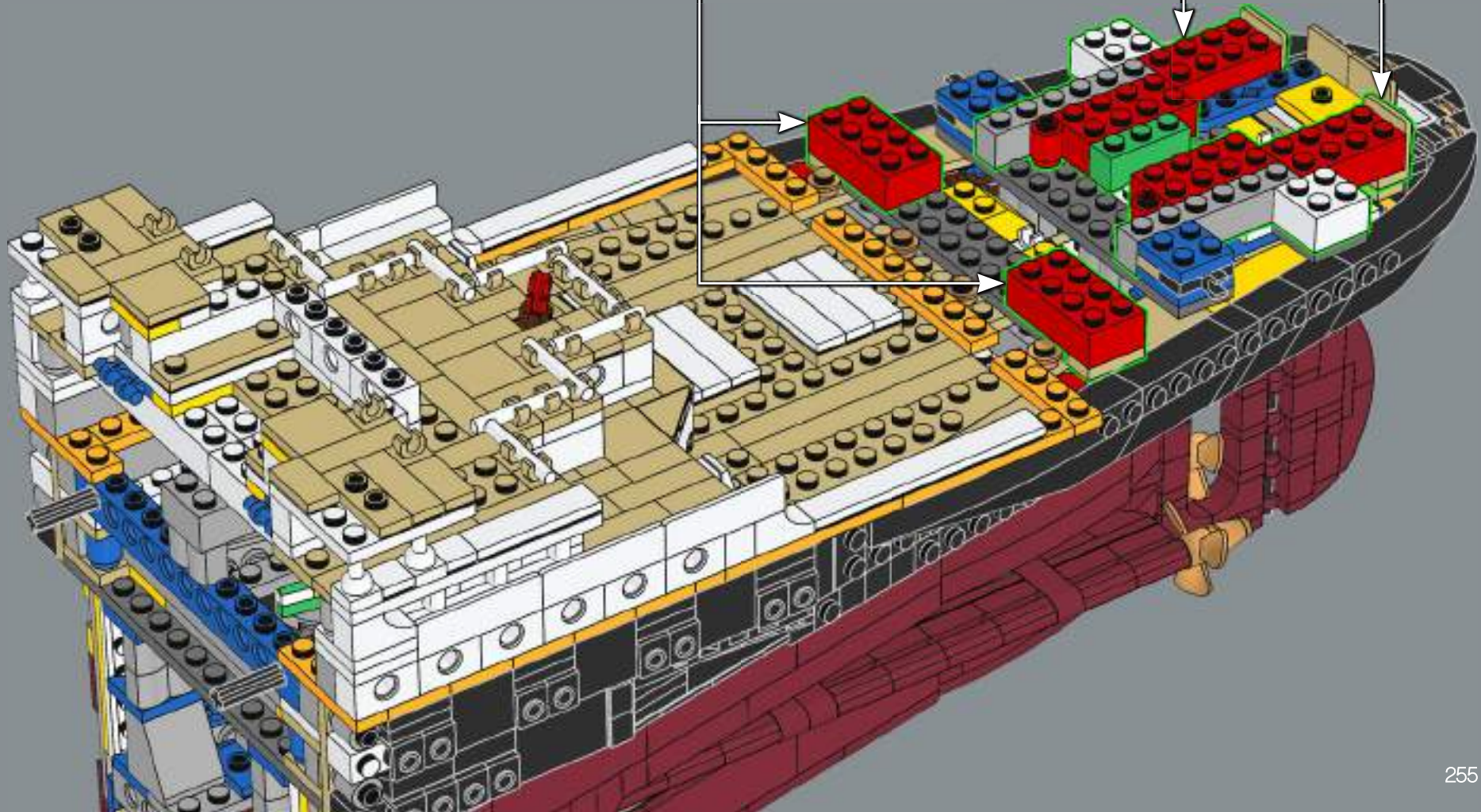
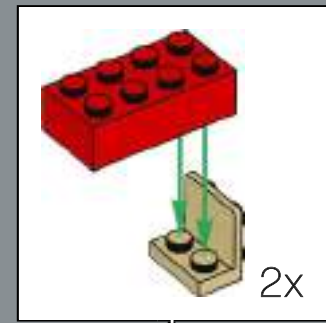
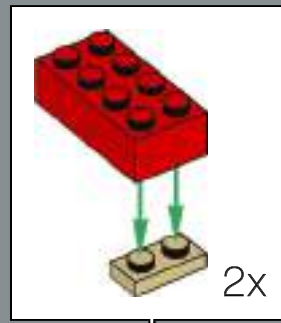



348

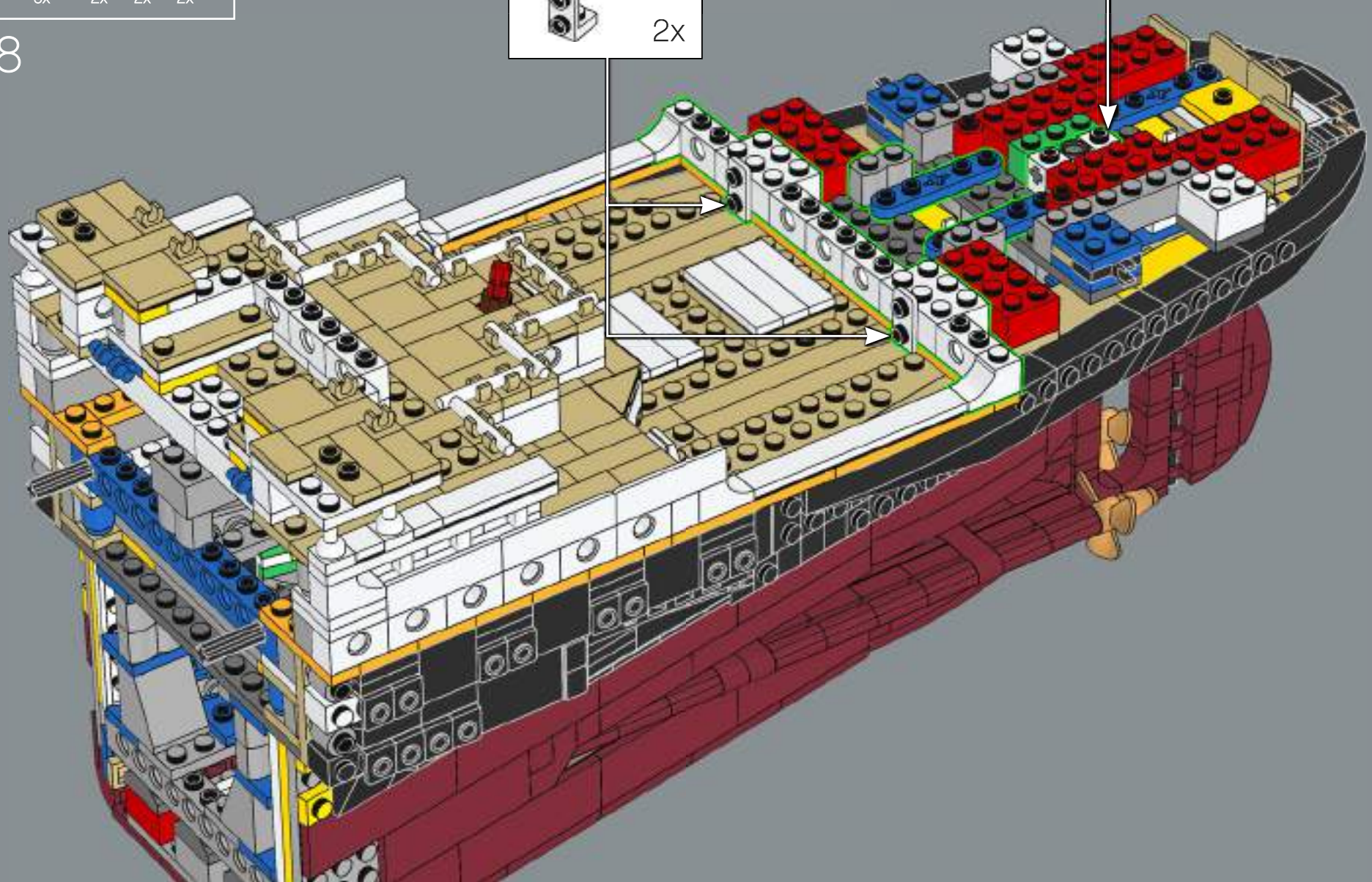
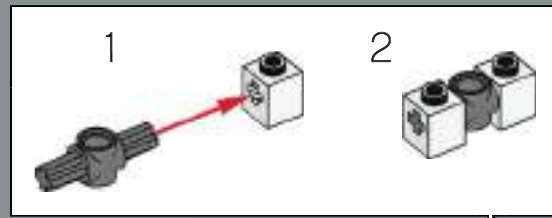
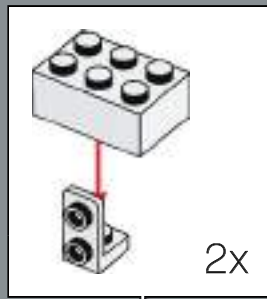



350

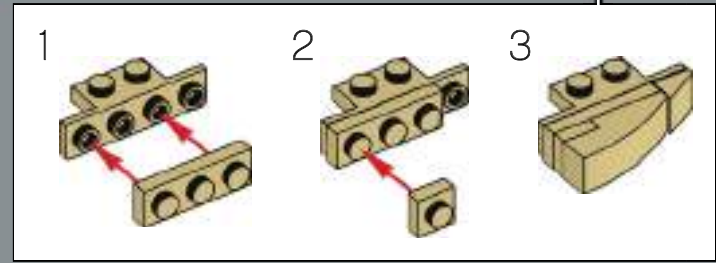
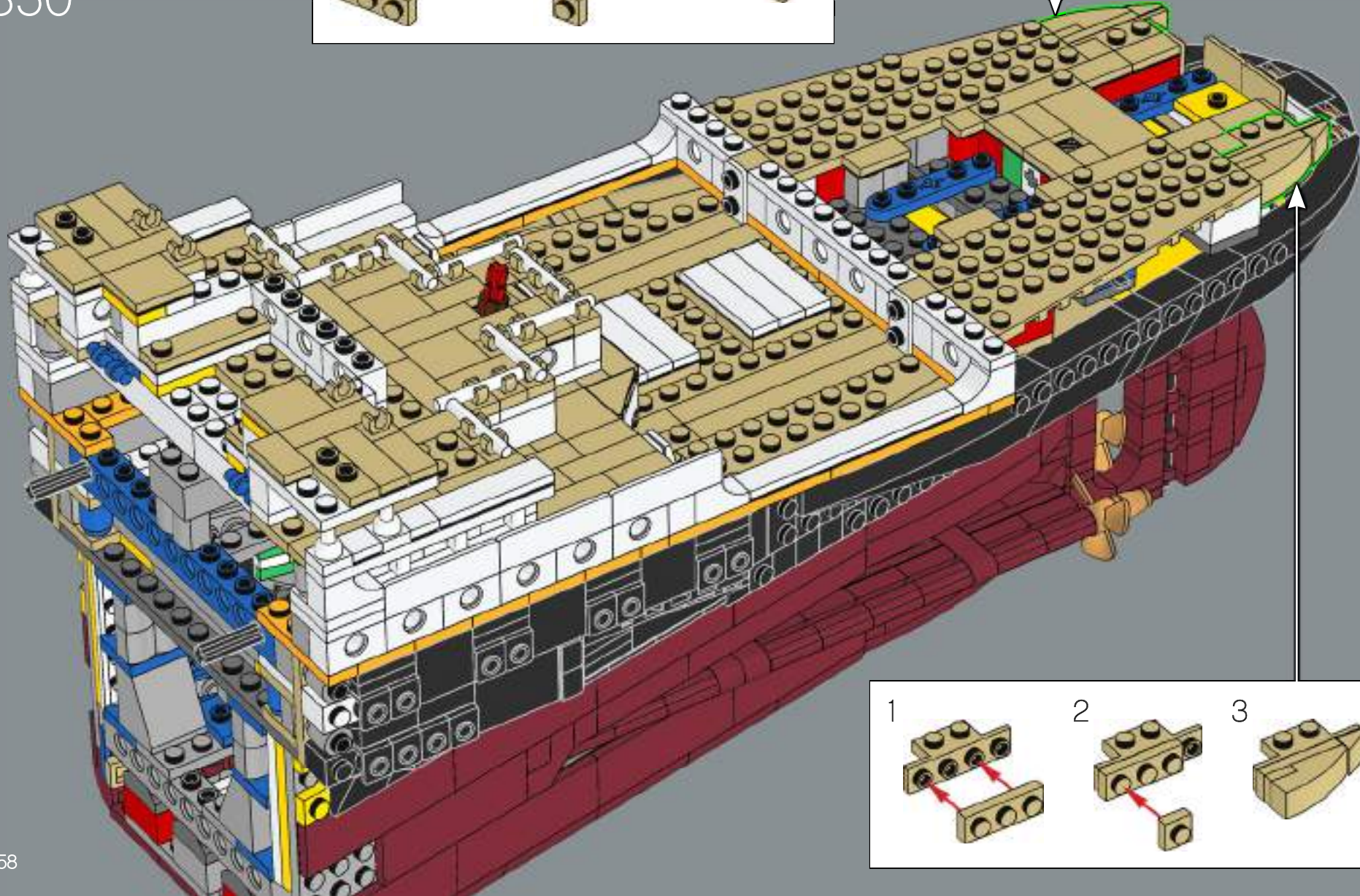
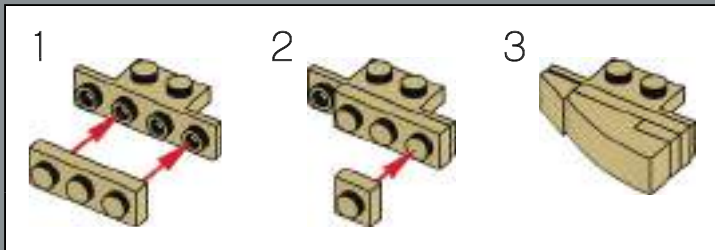



351

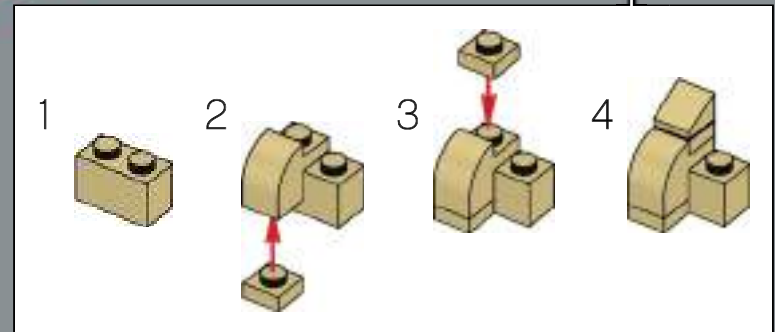
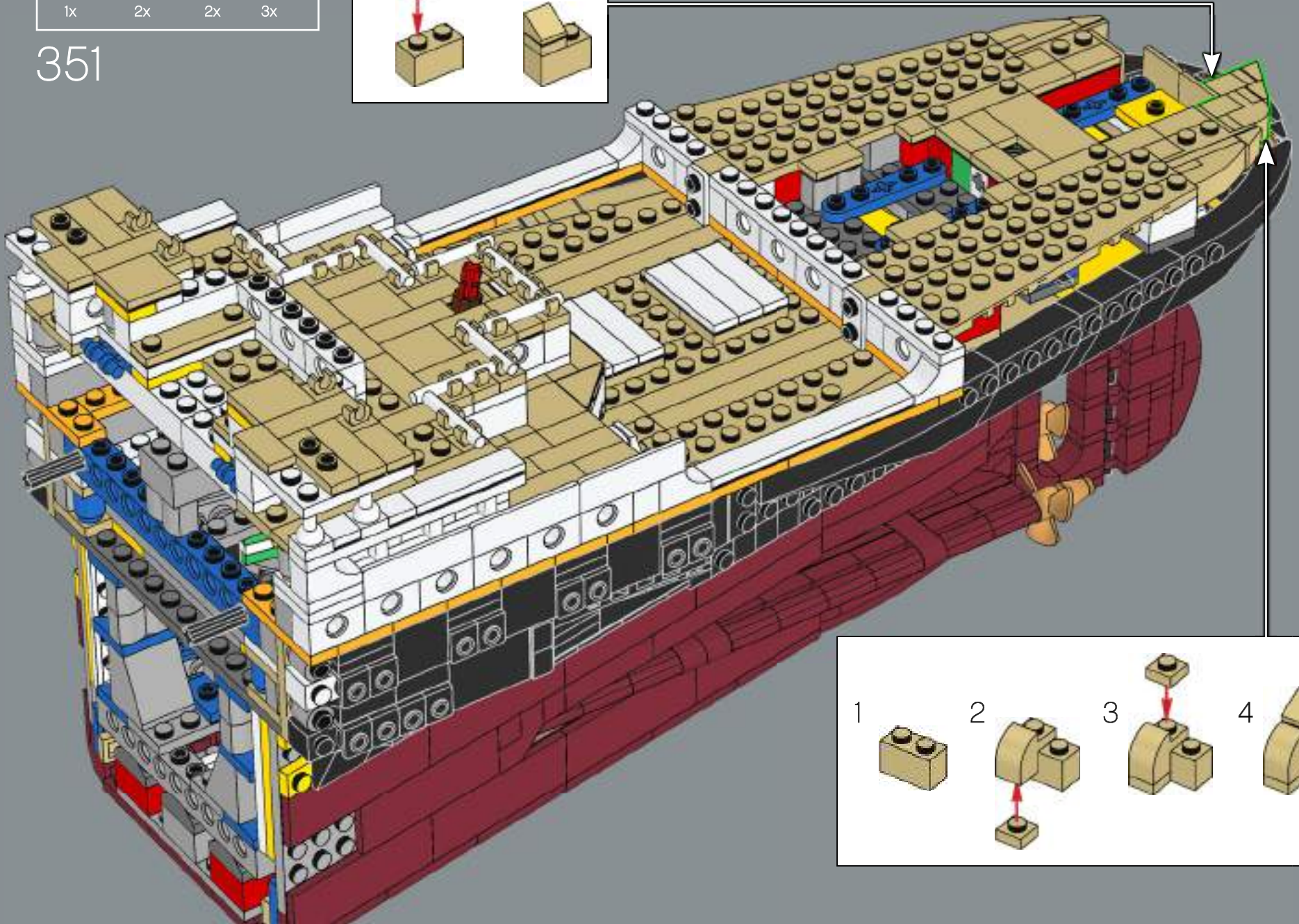
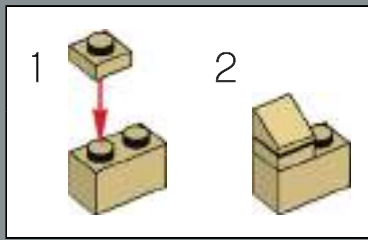



352

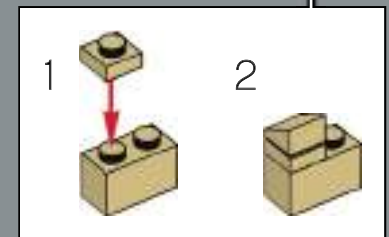
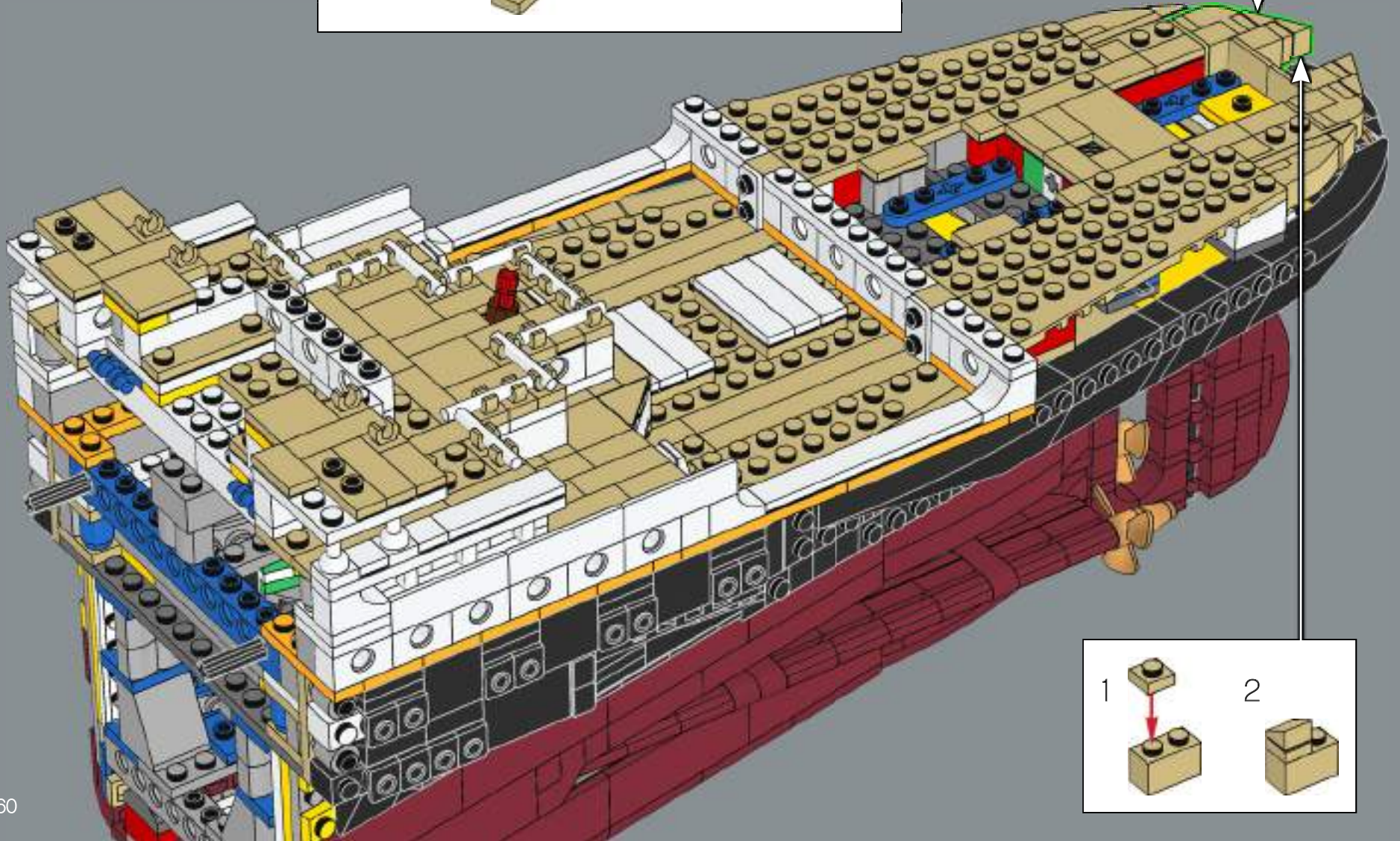
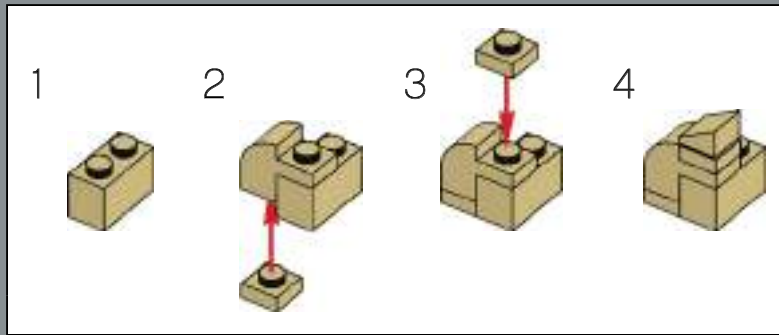



353

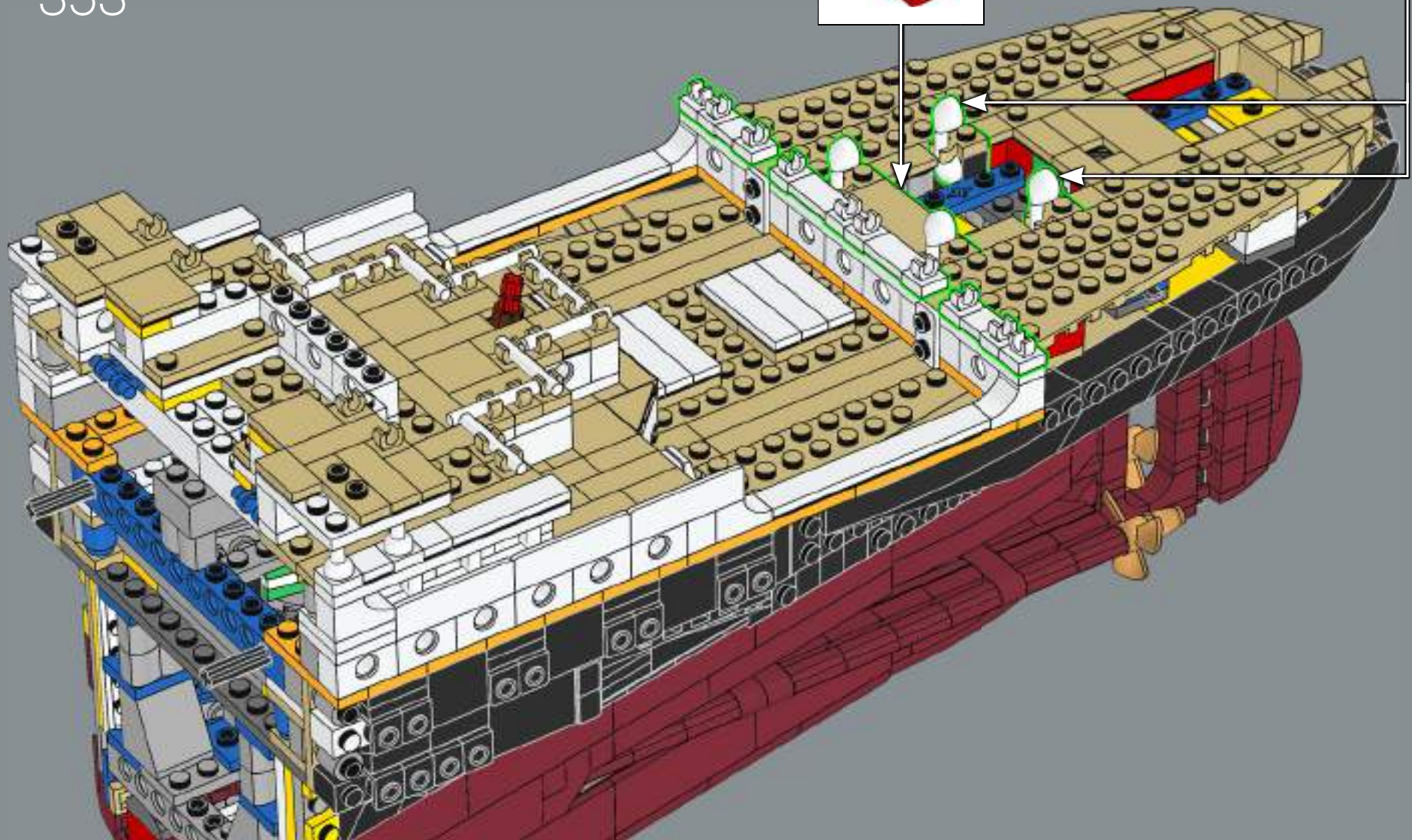
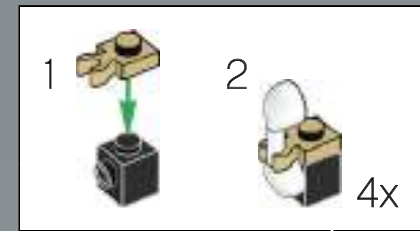
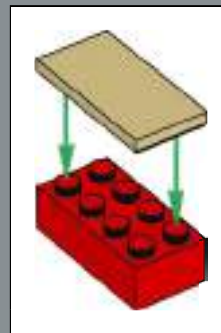



354

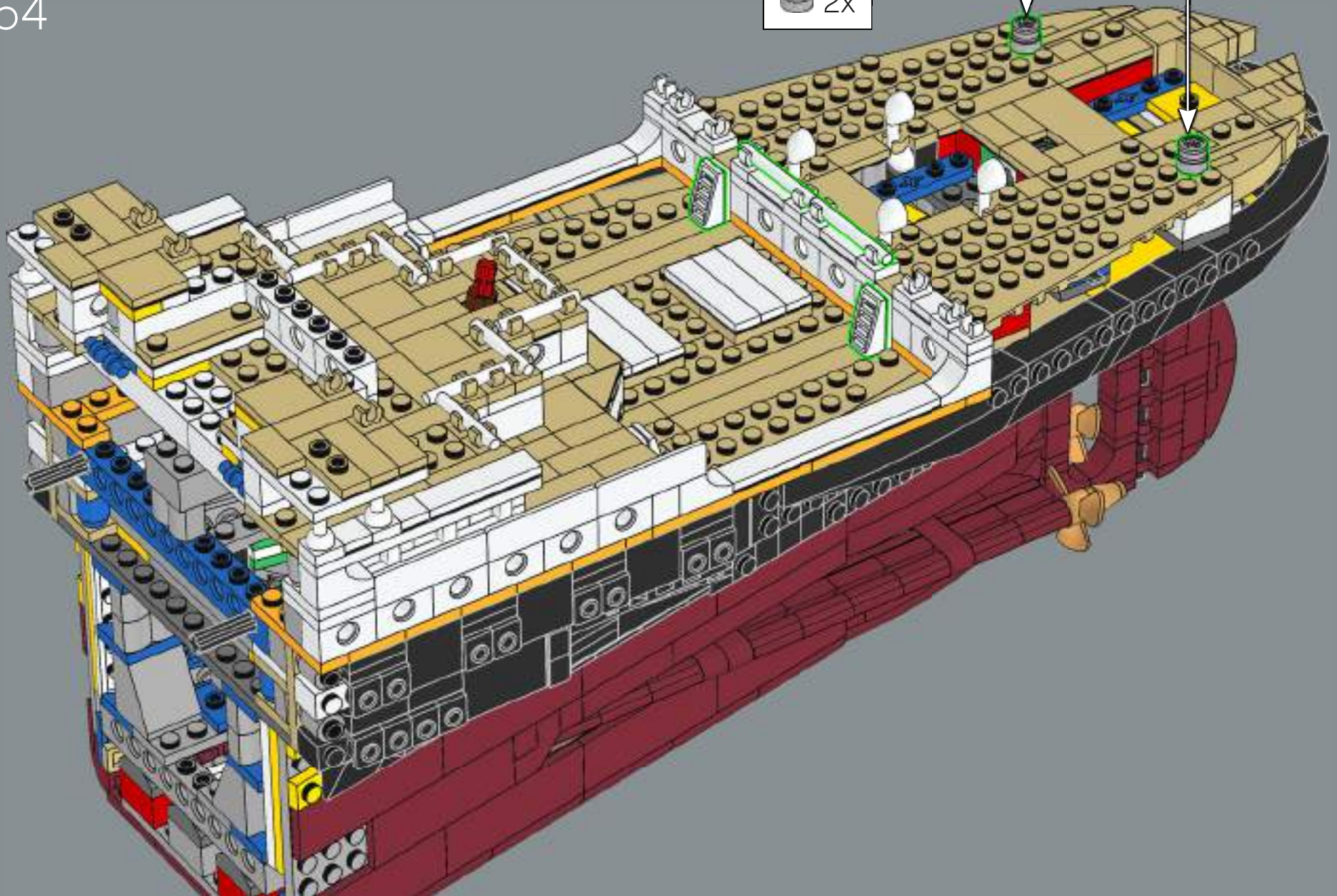
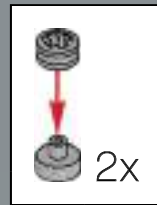



355

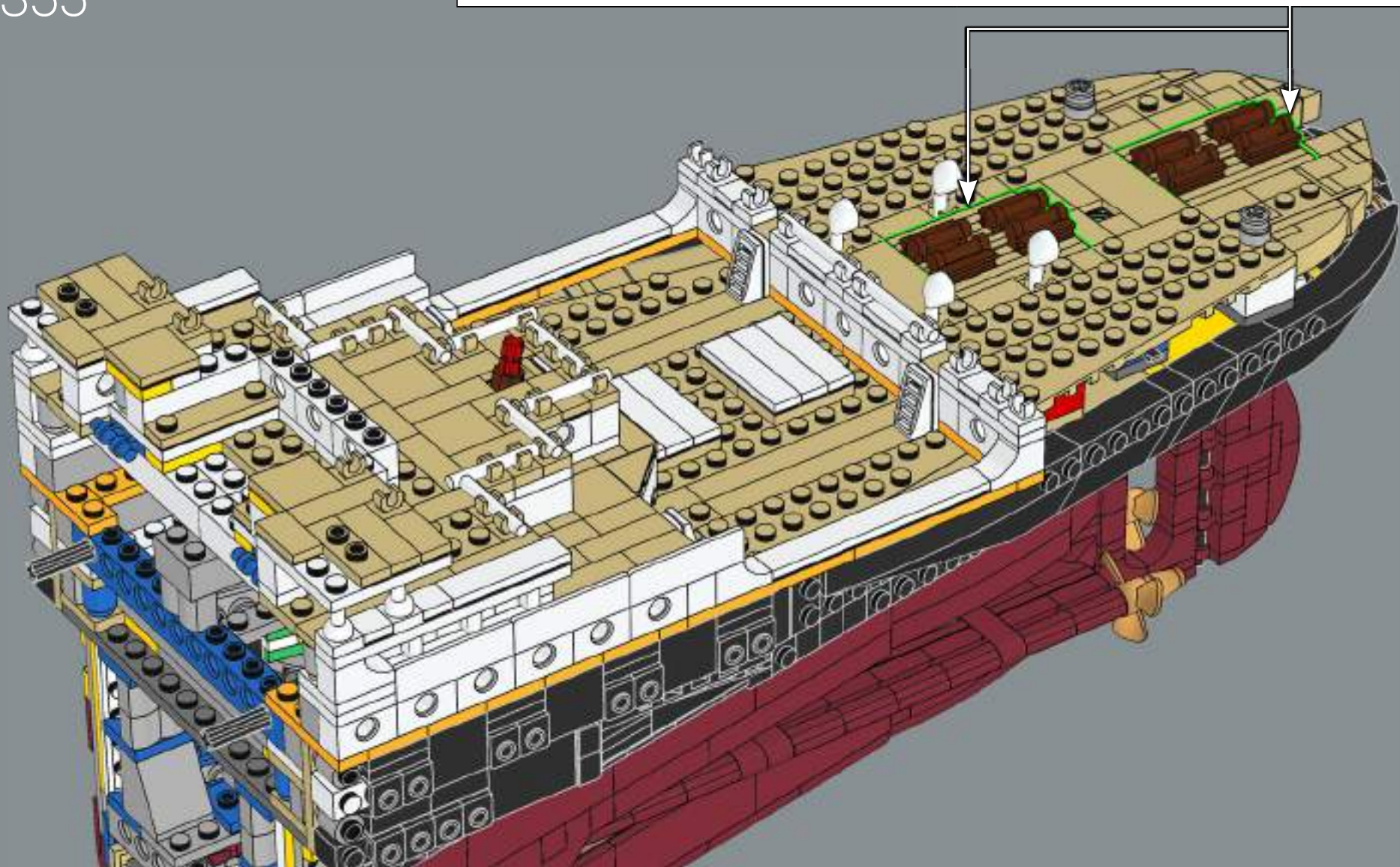
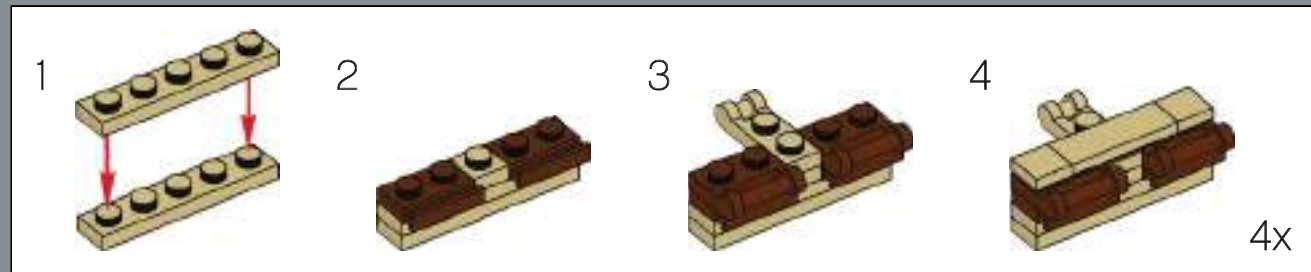

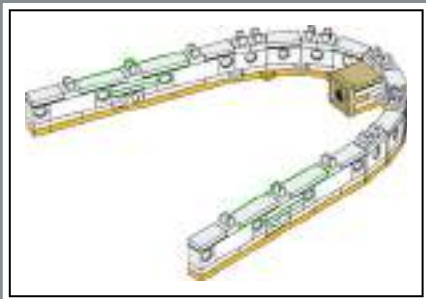
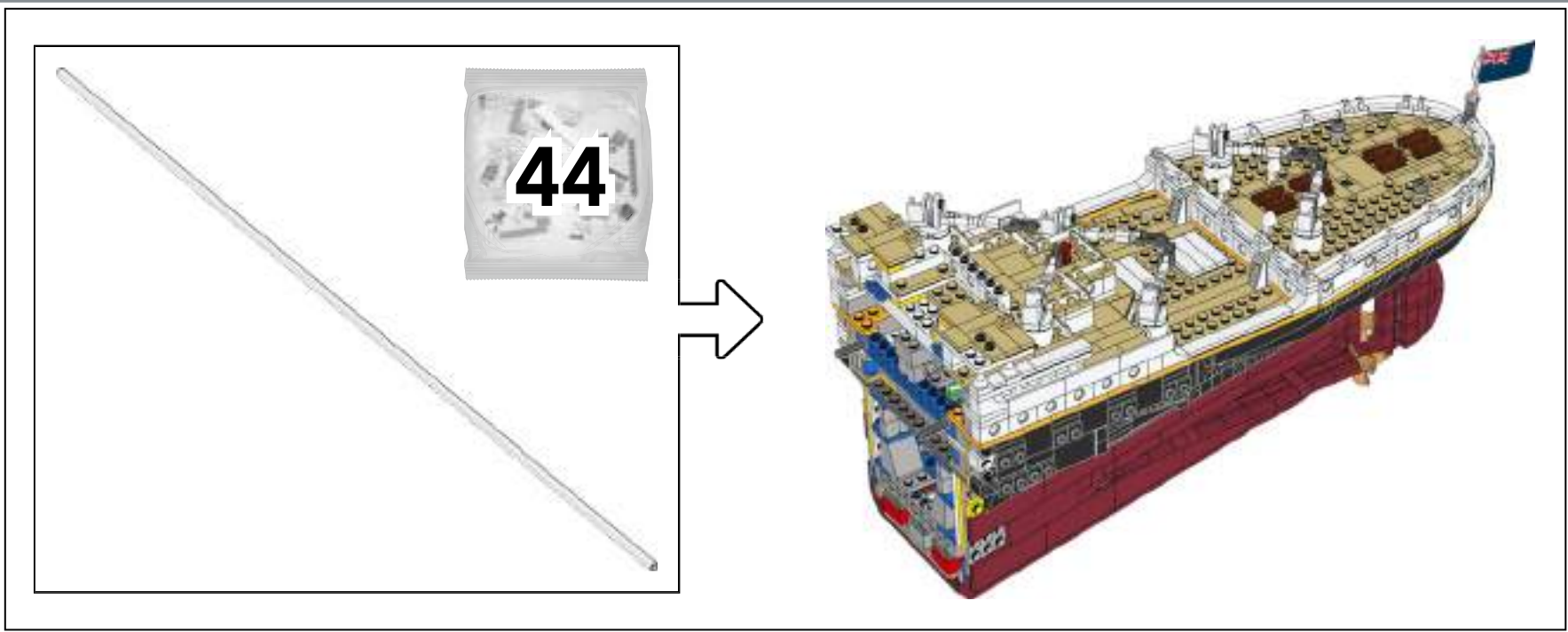

356



357





2x

362

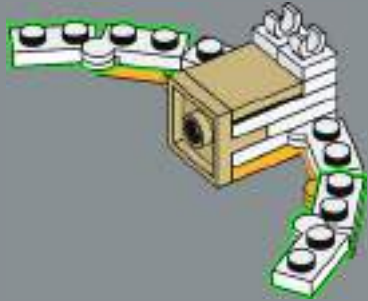

2x

363

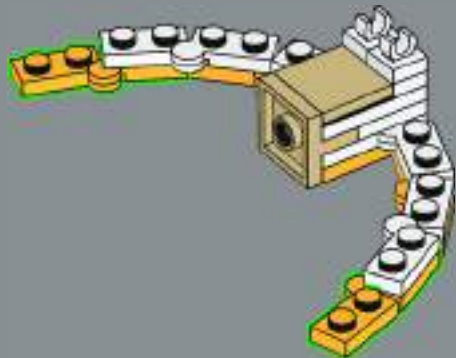

6x

364

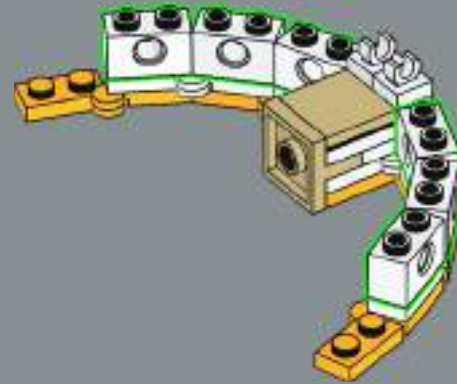

4x

4x

365

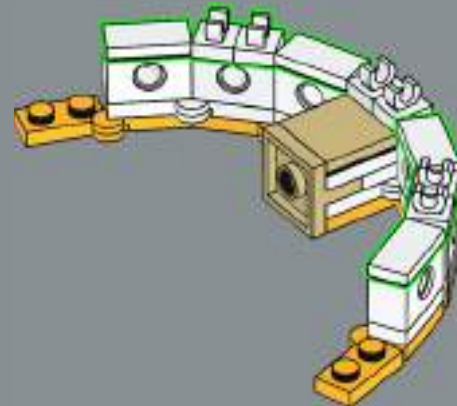



366

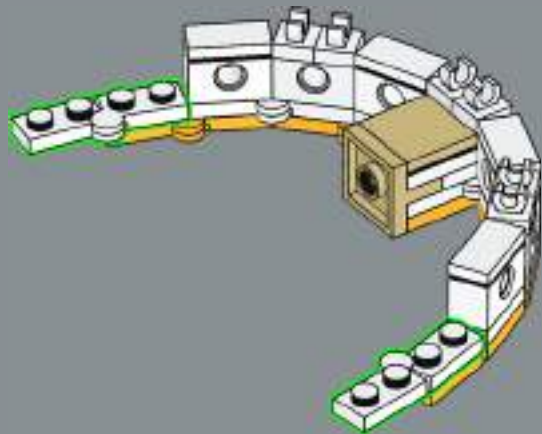

367

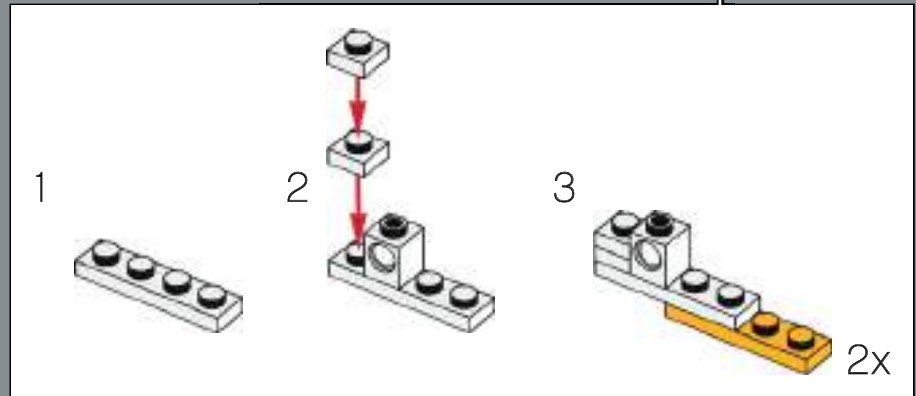
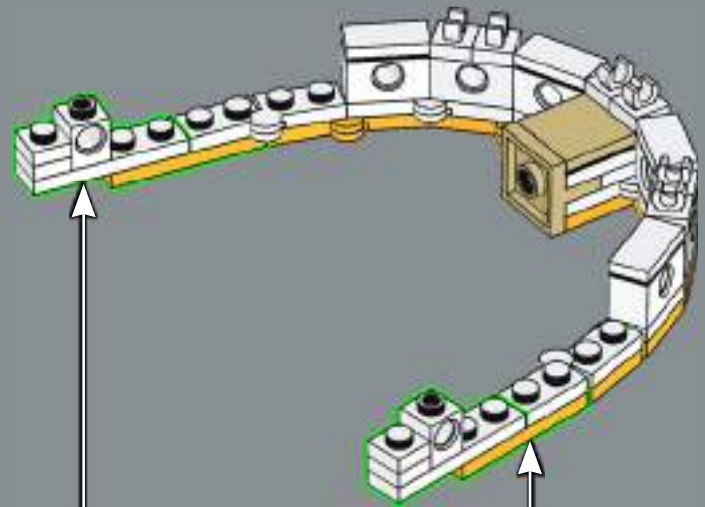



368

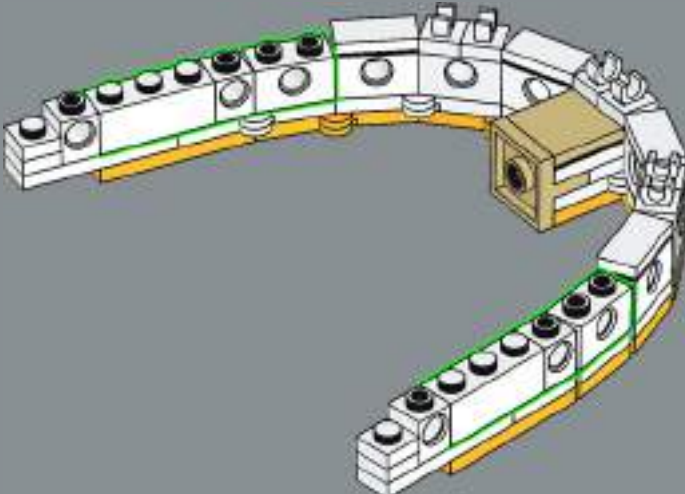

369

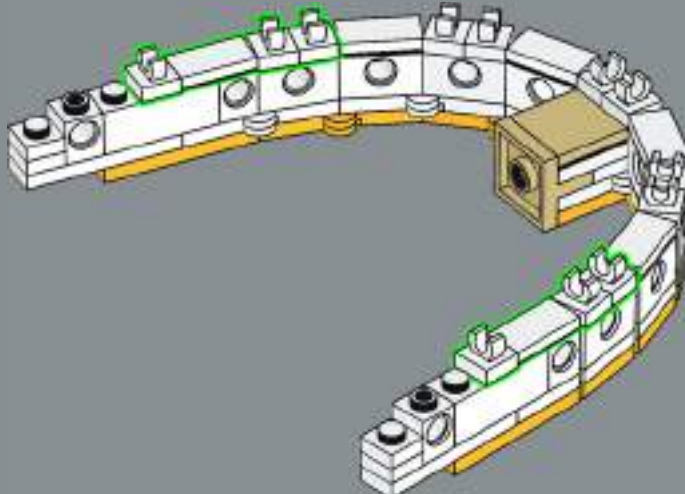



2x

371

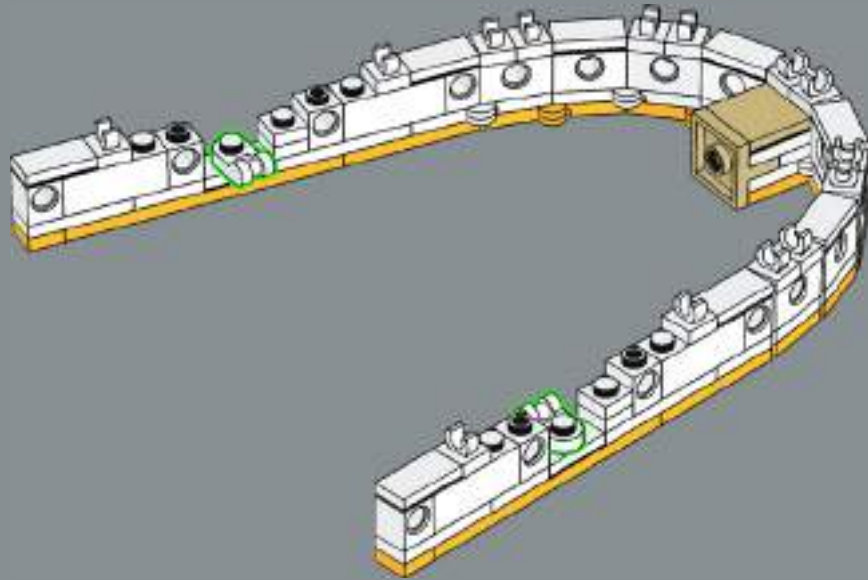

2x

372

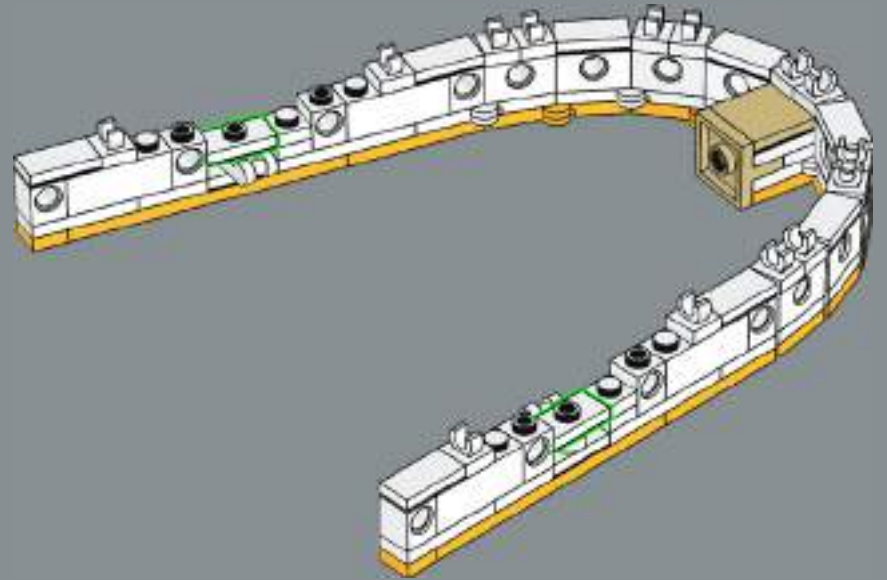

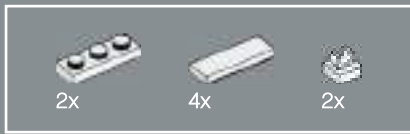

373

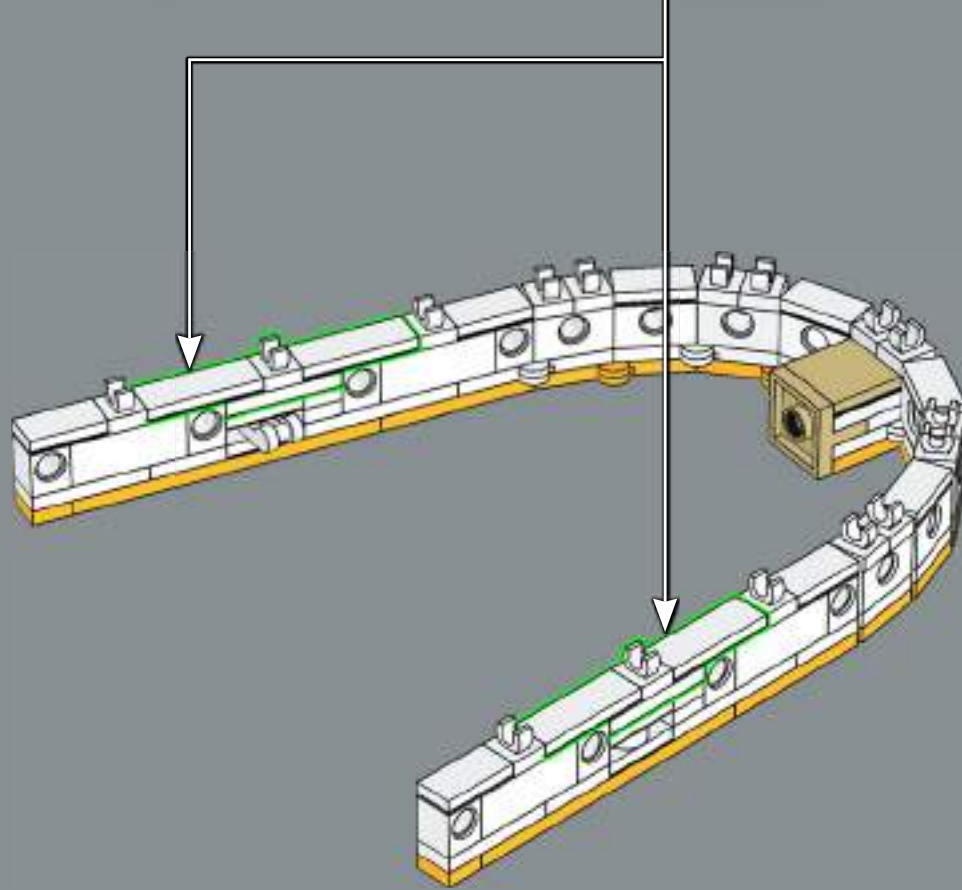
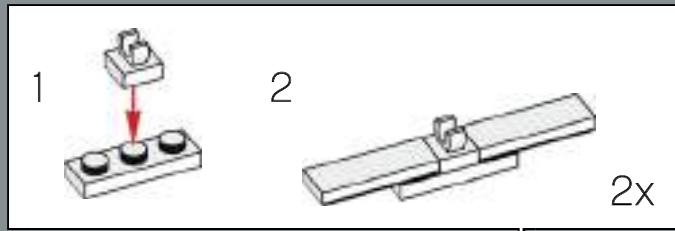

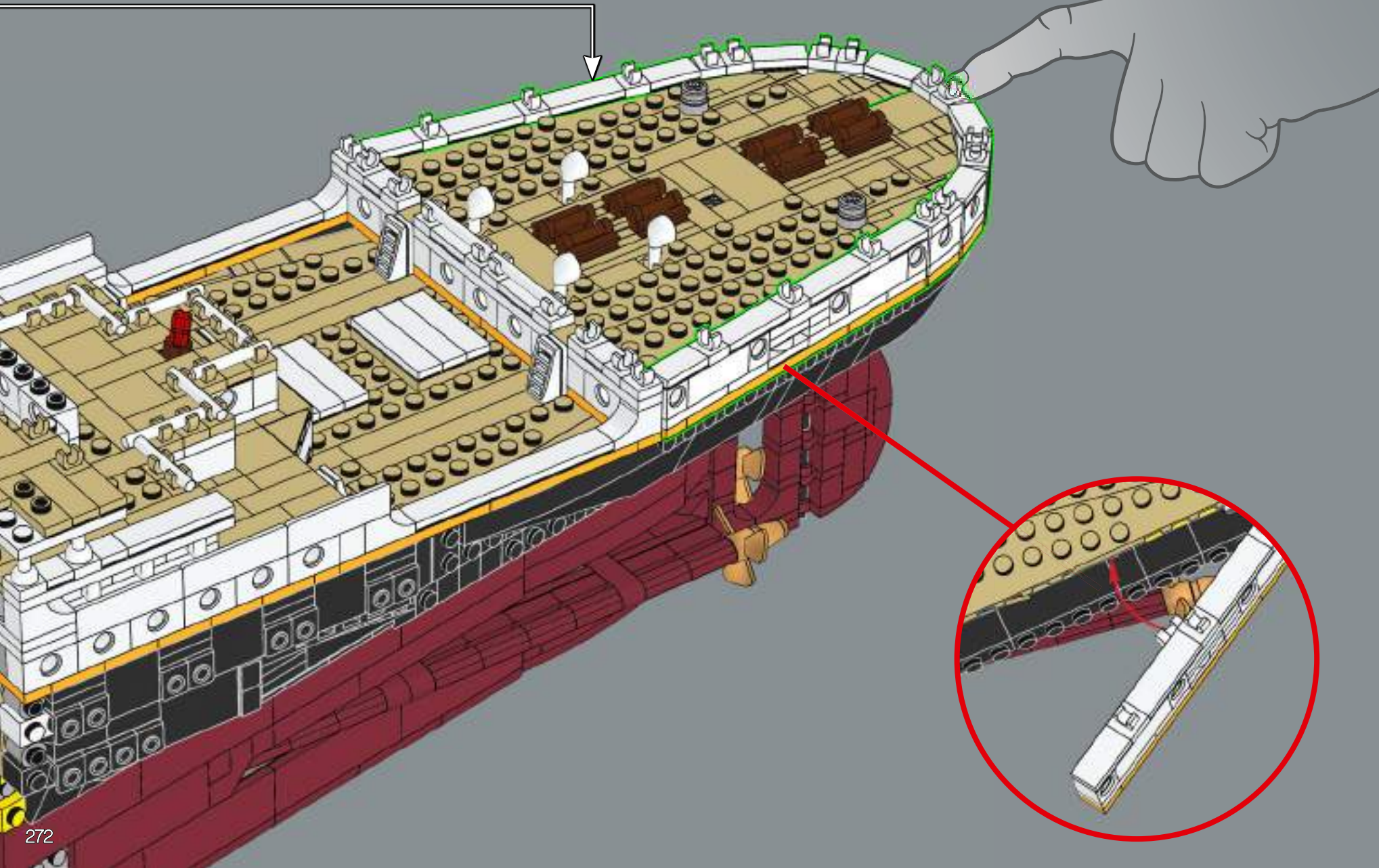

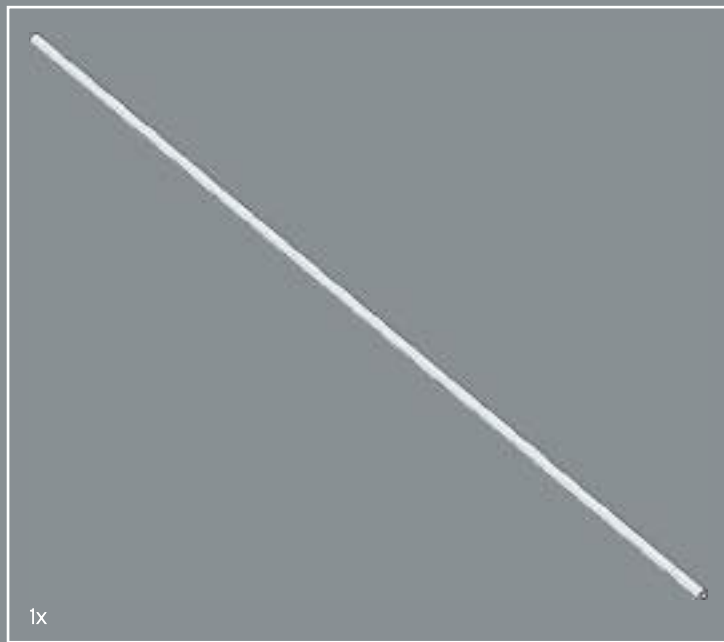

1x

375

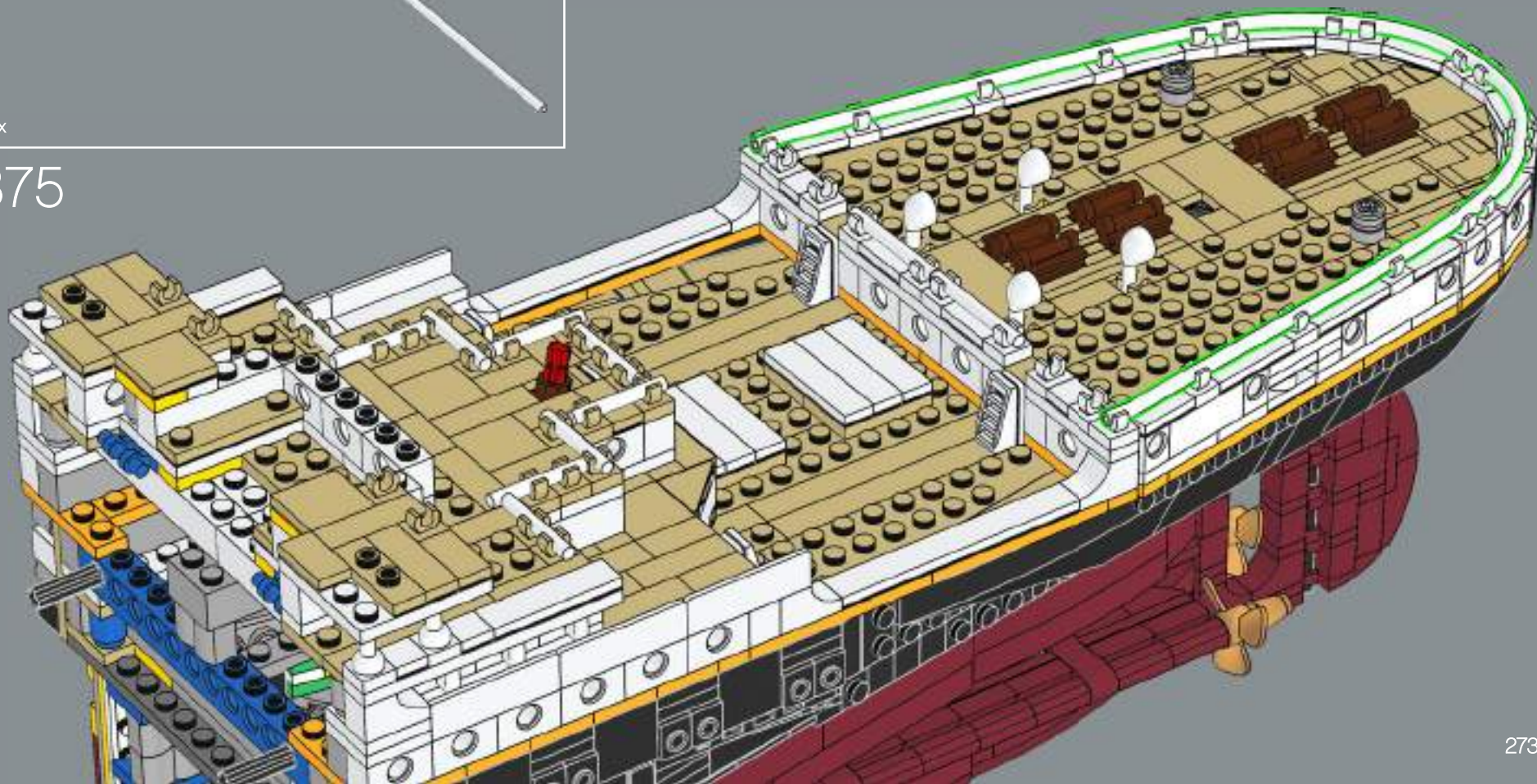



376

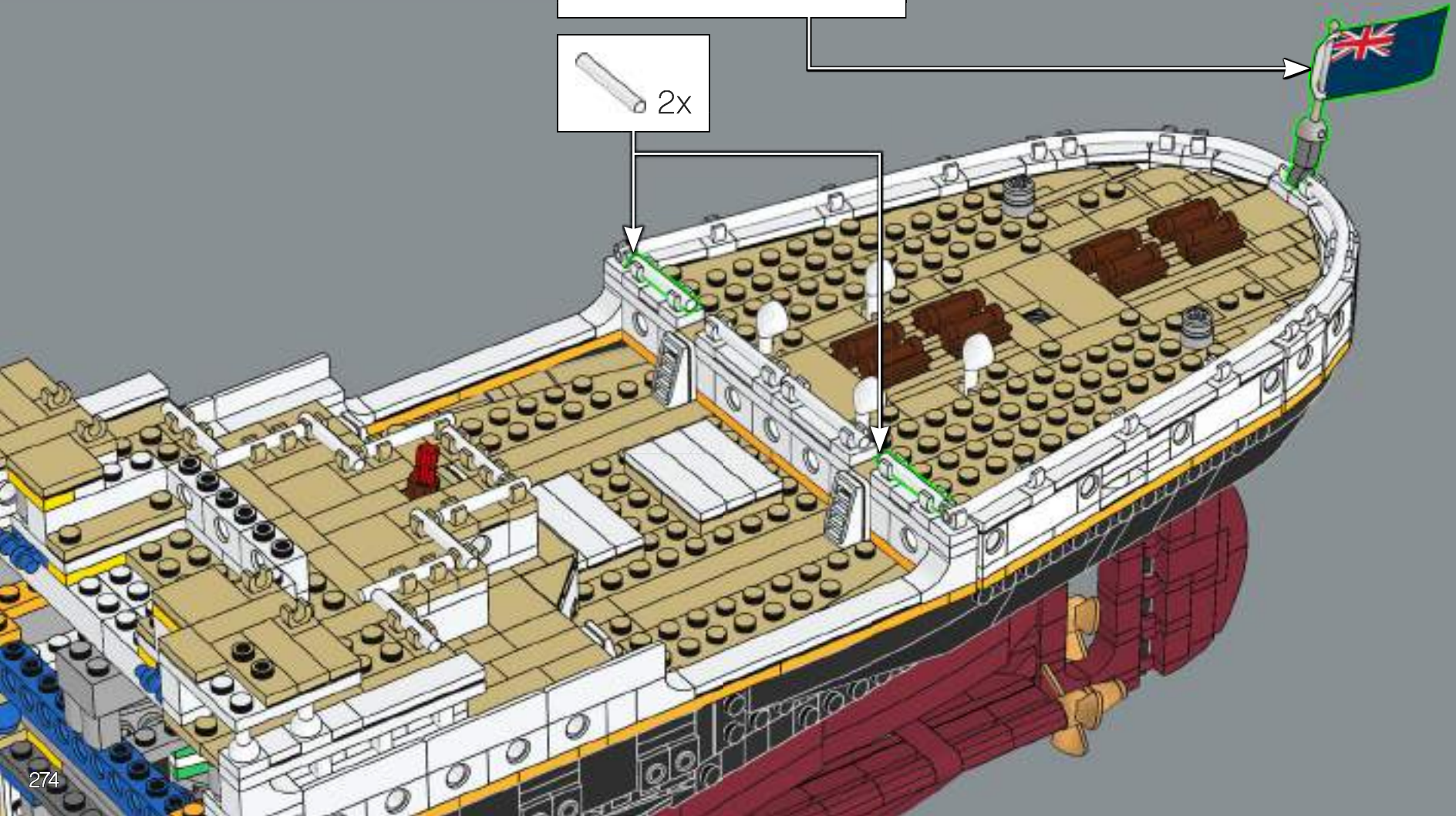
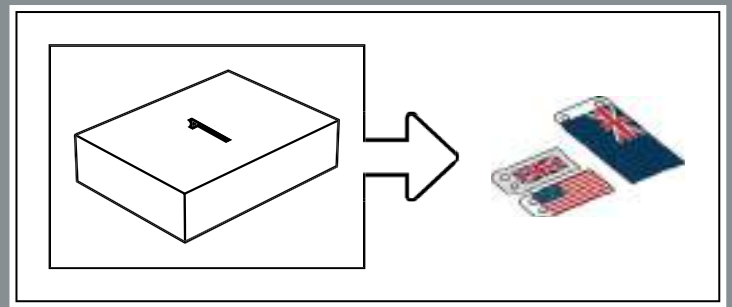
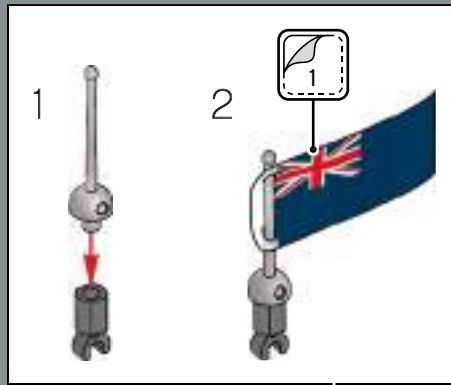



377

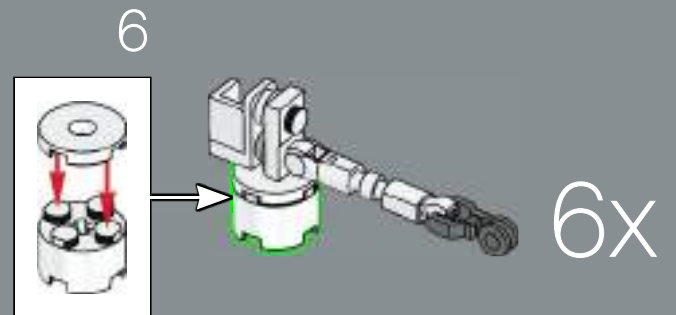
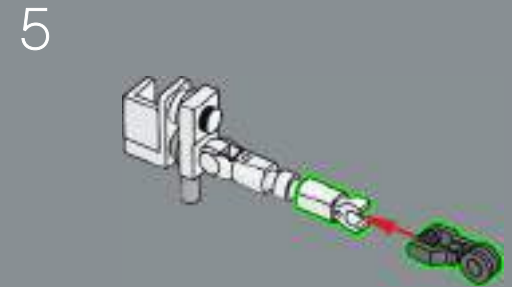
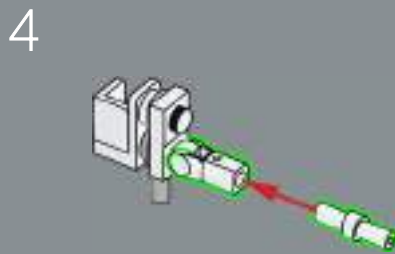
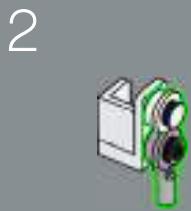
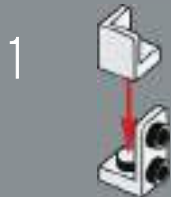

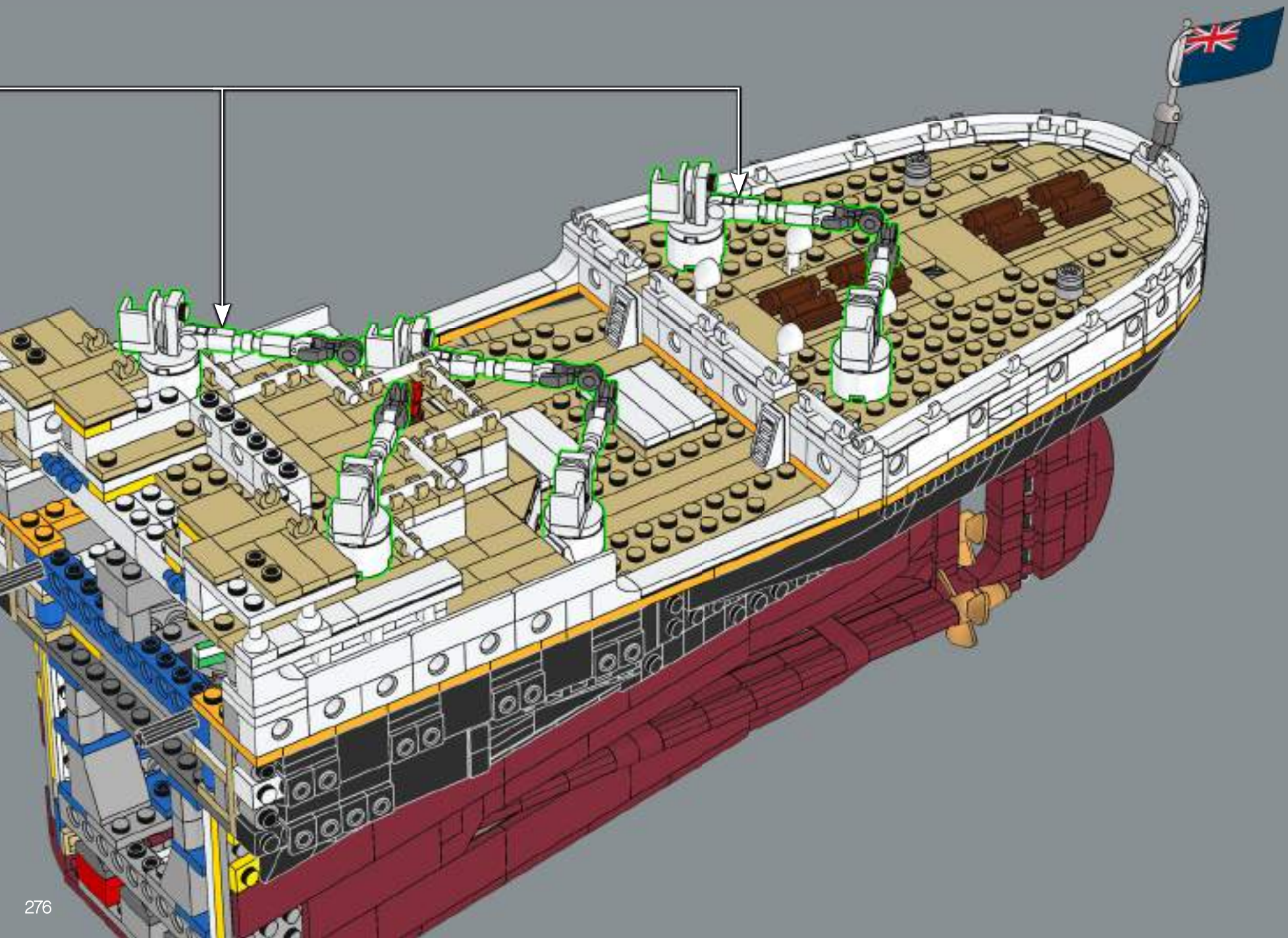

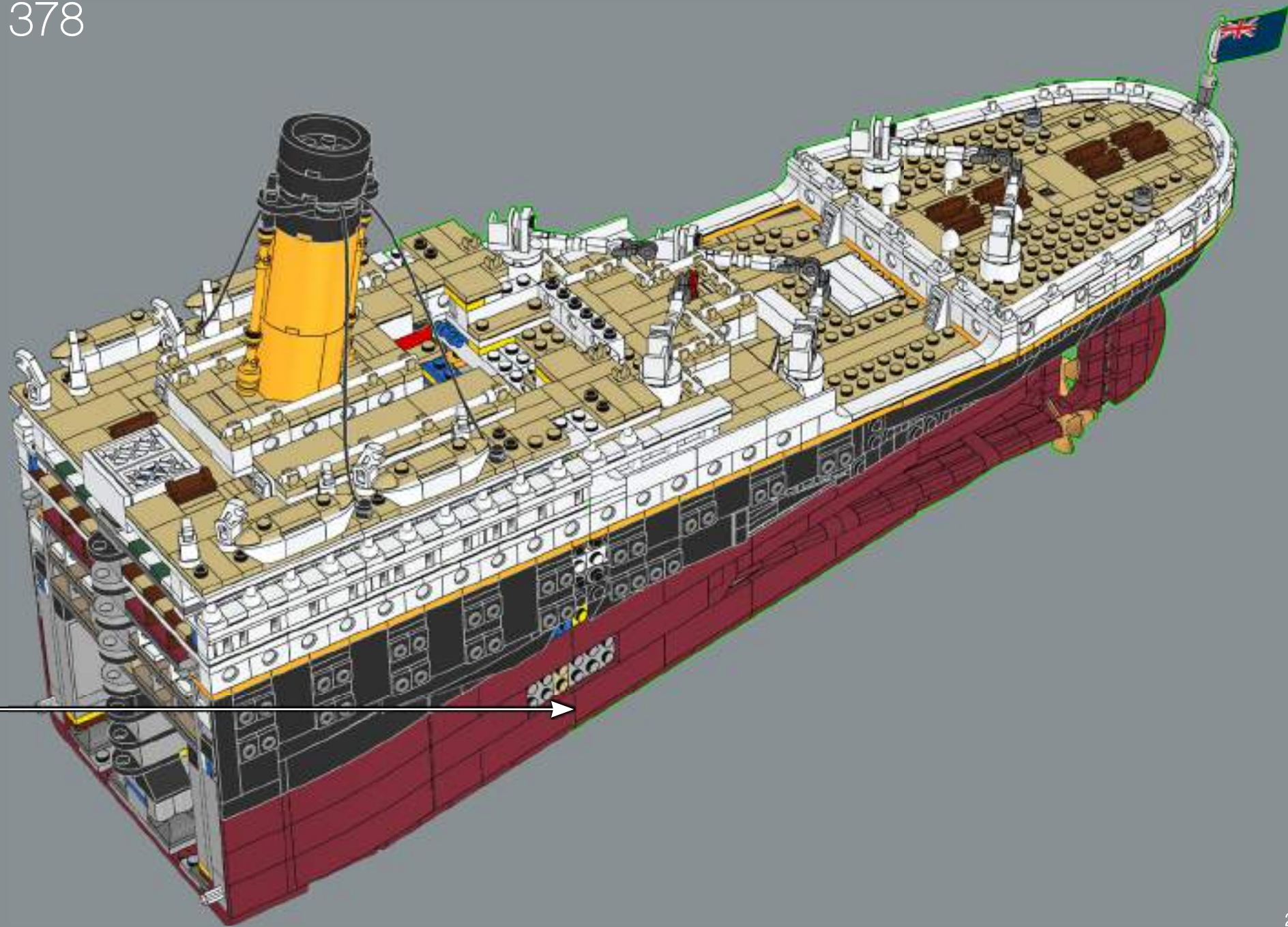

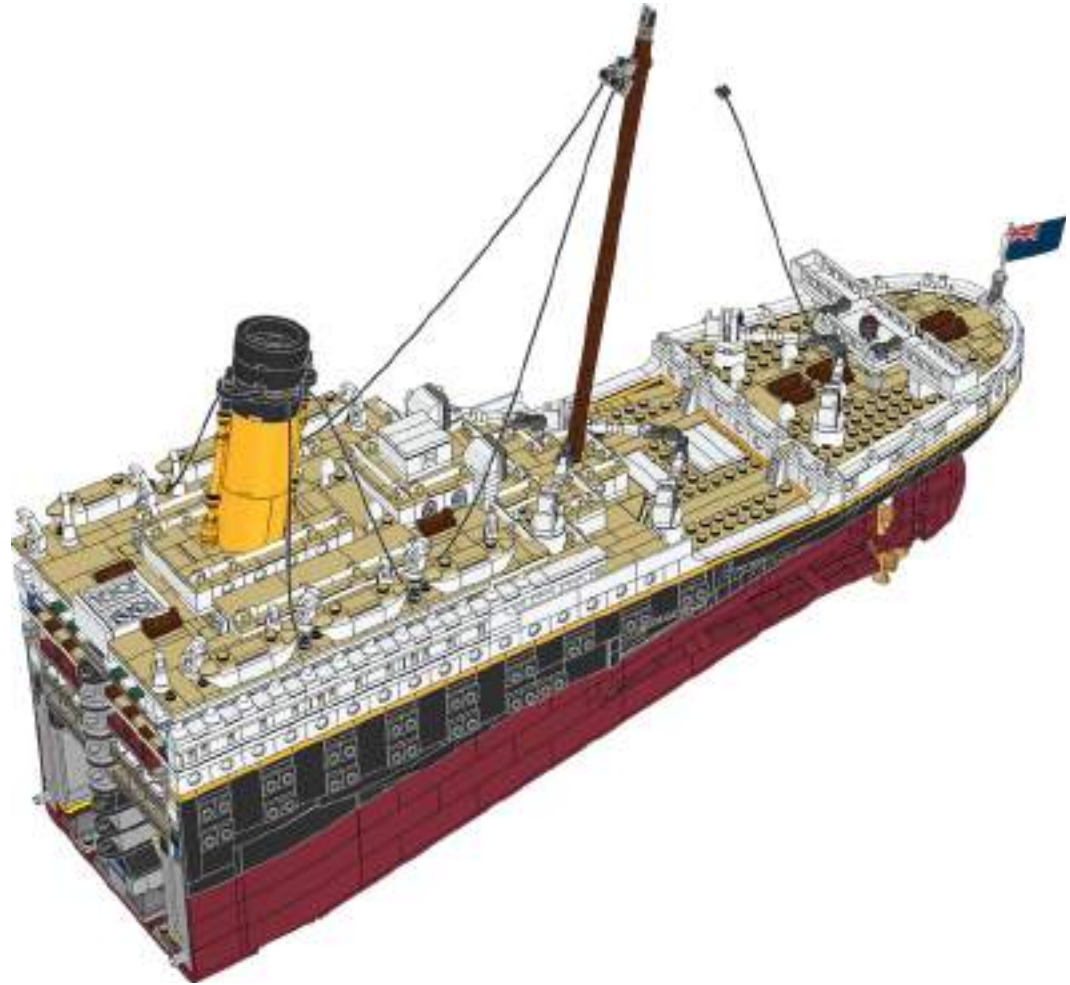
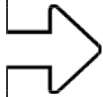

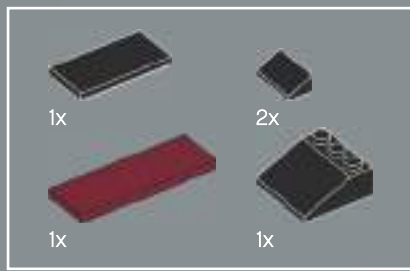

379

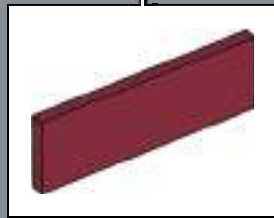
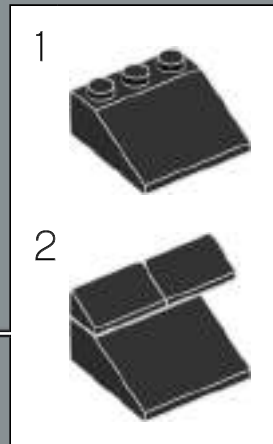
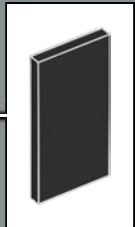
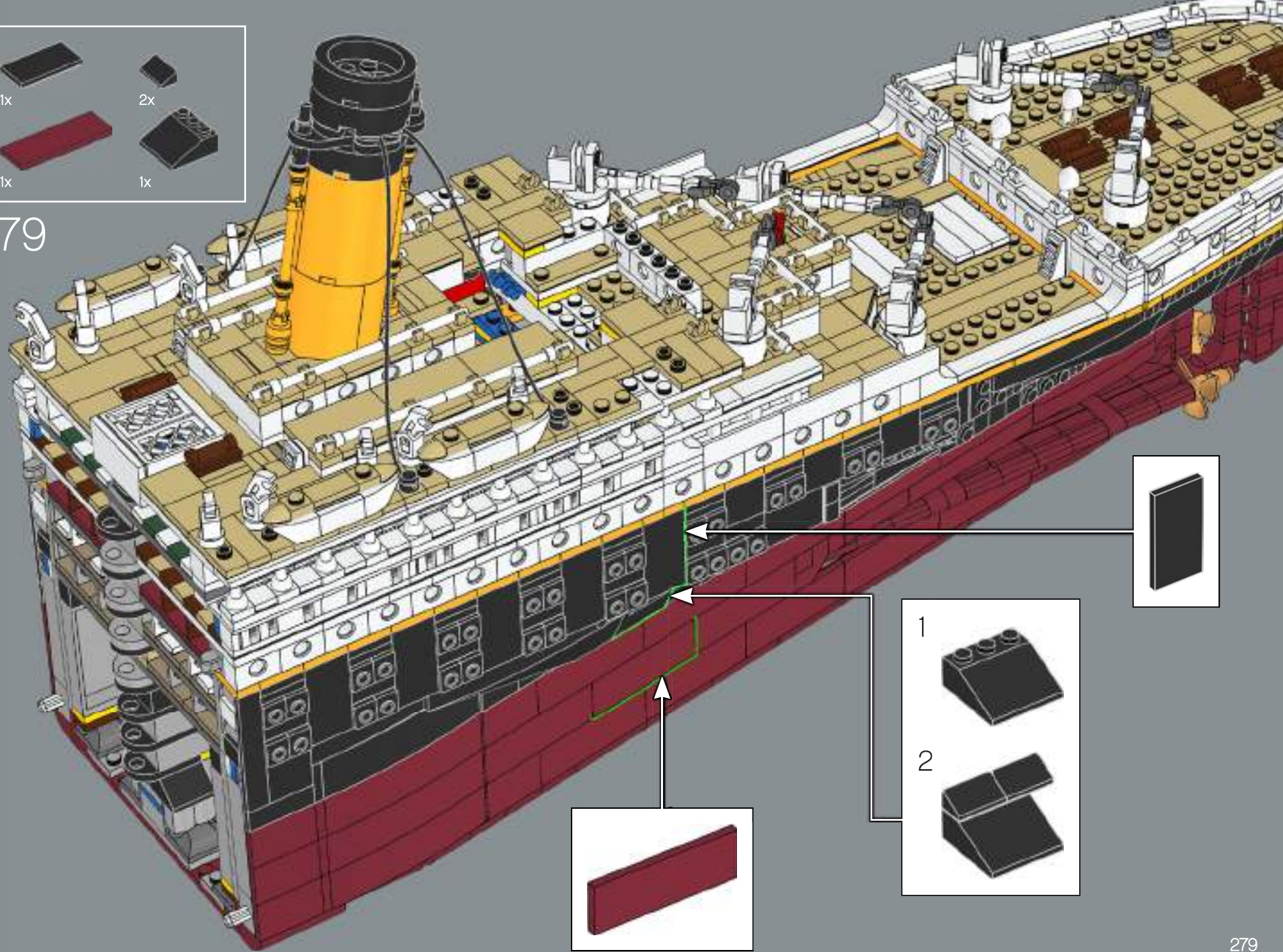

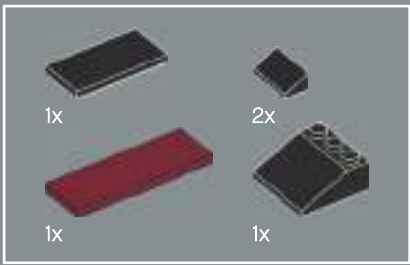

380

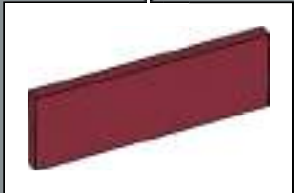
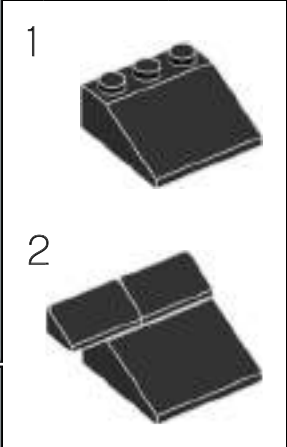
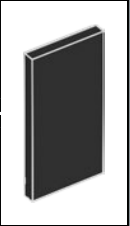
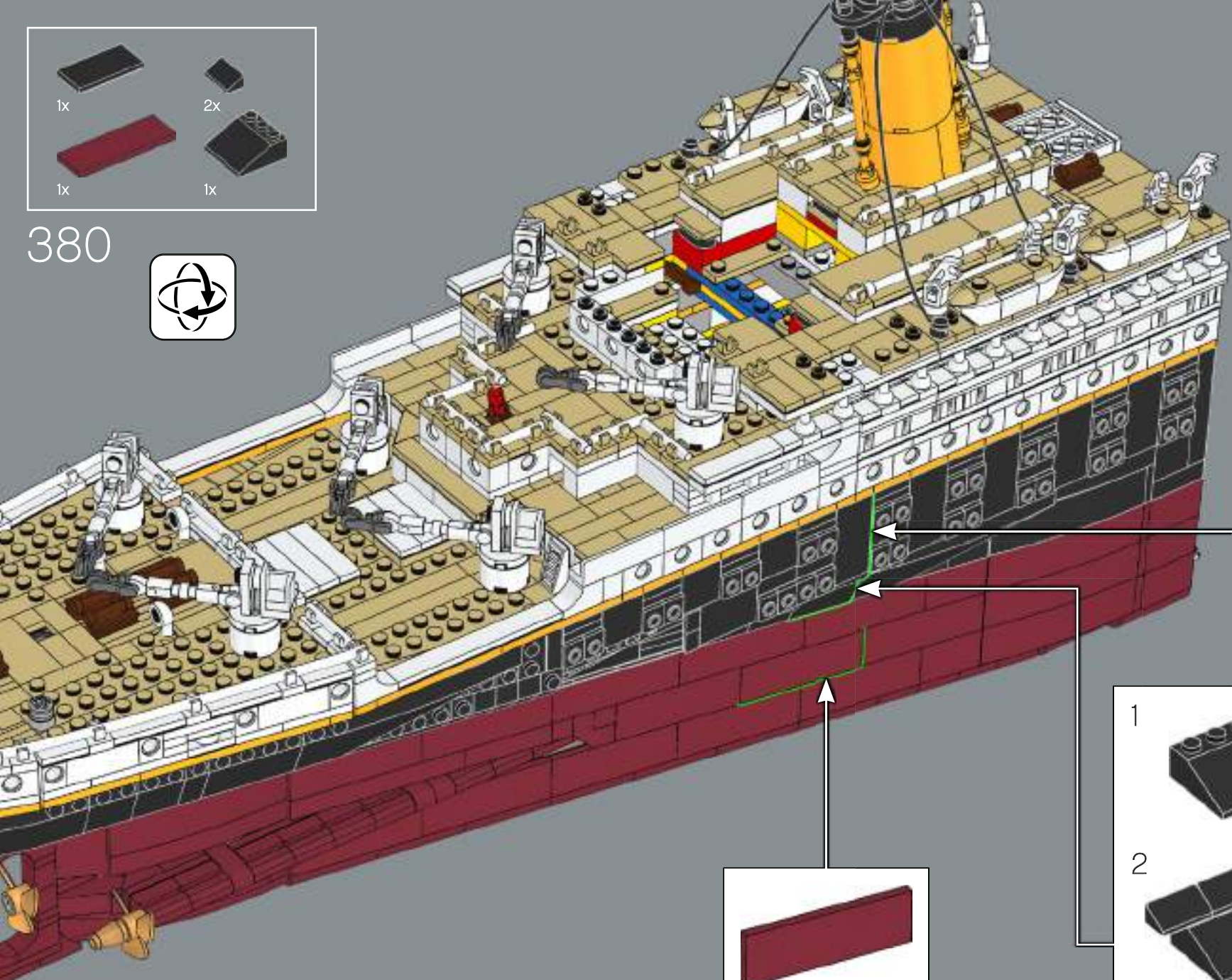

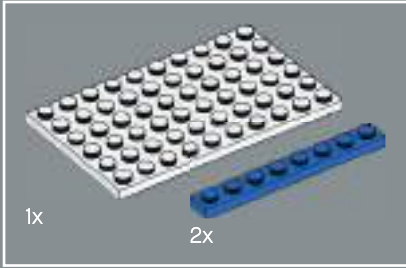

381

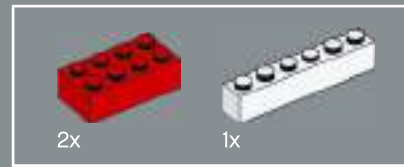
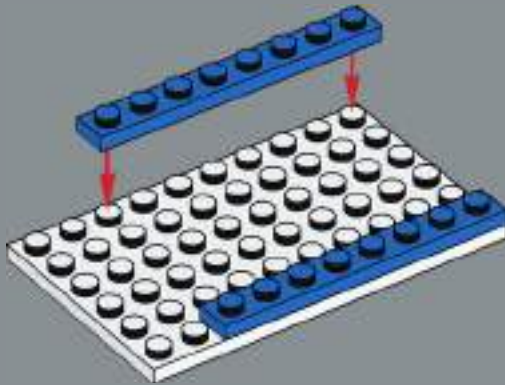

382

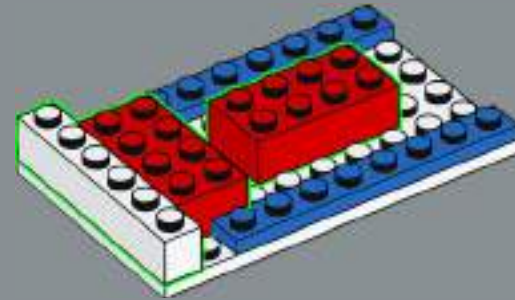

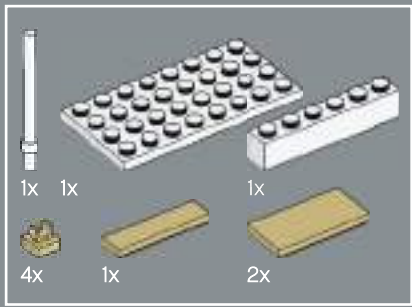

383

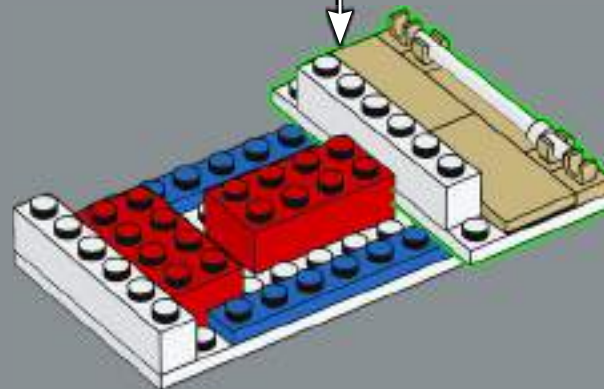
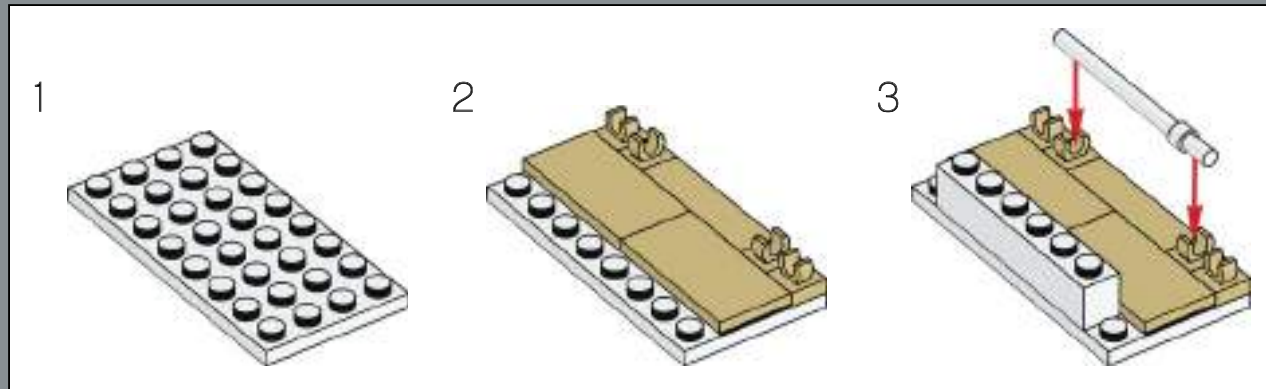



384

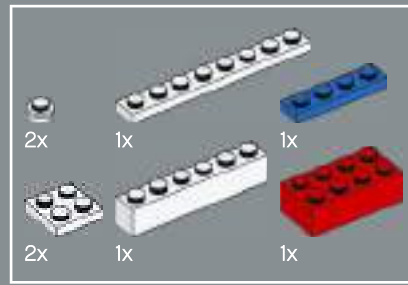
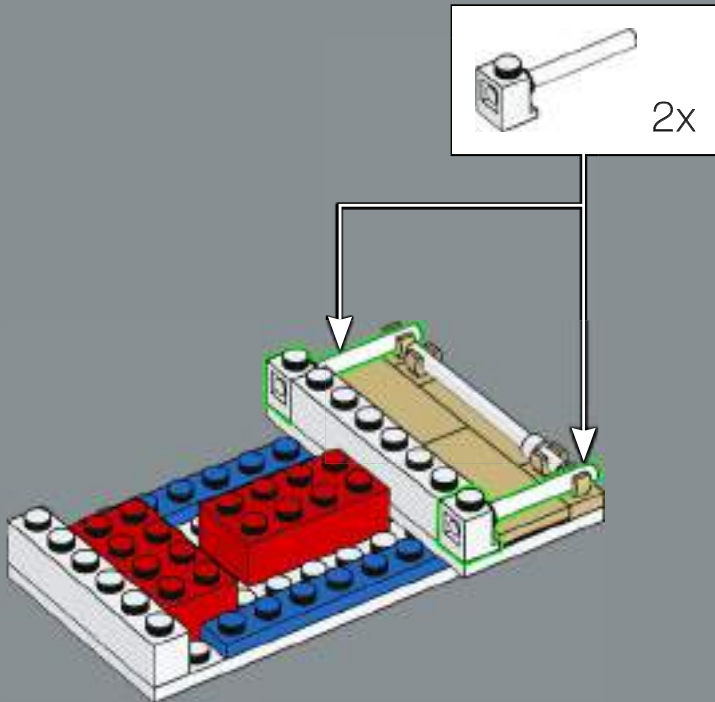

385

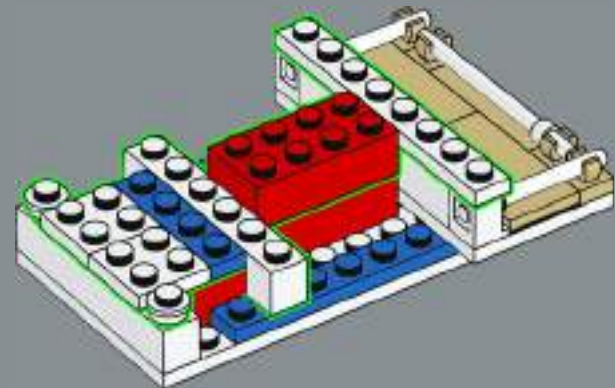

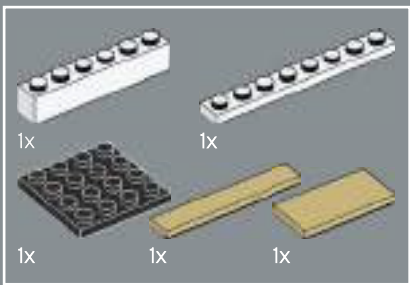

386

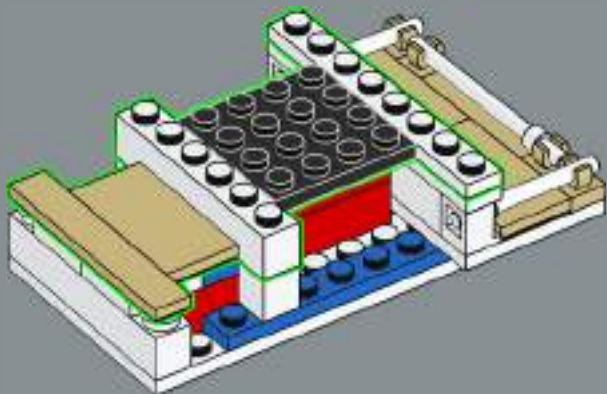

387

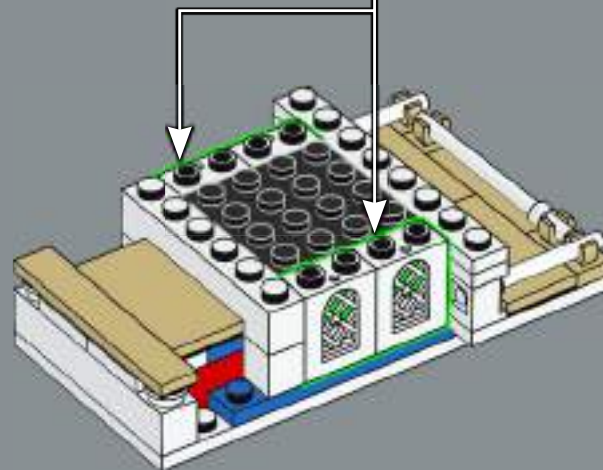
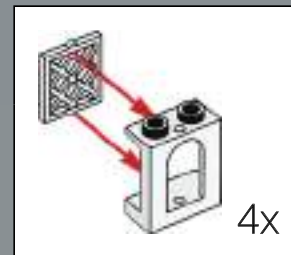

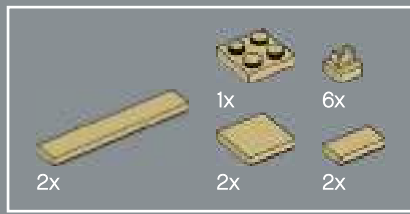

388



389

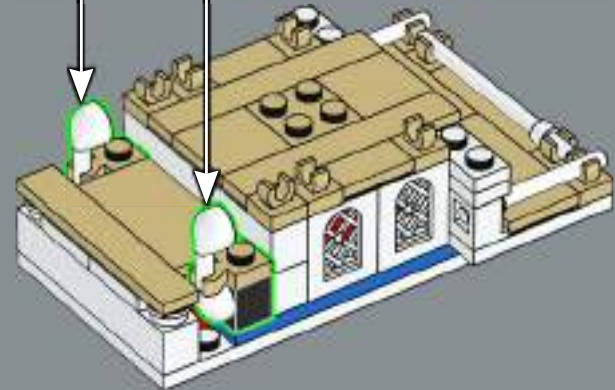
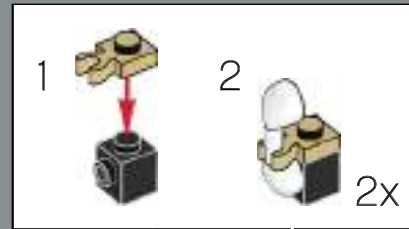

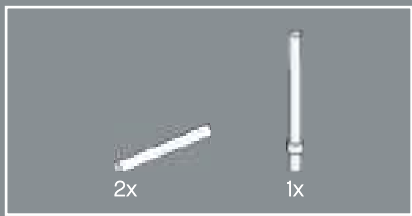

390

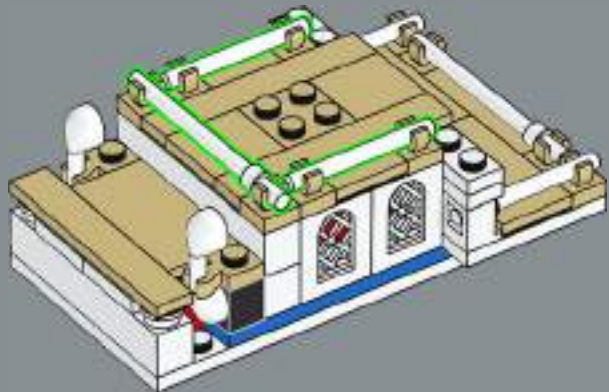

391

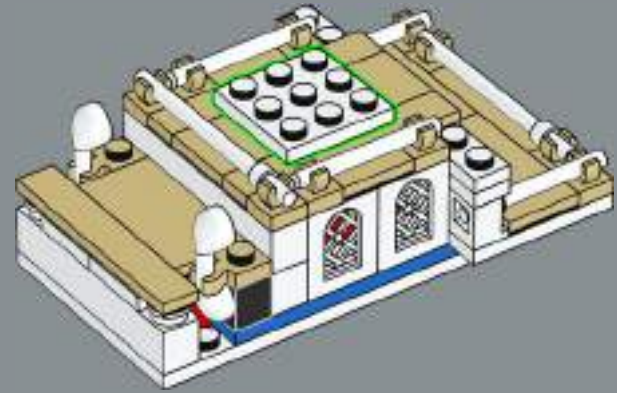

392

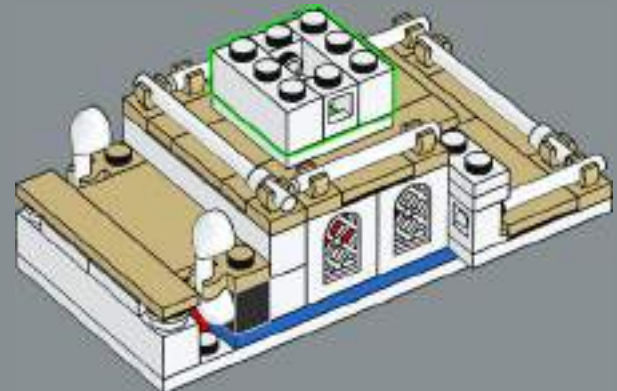



393

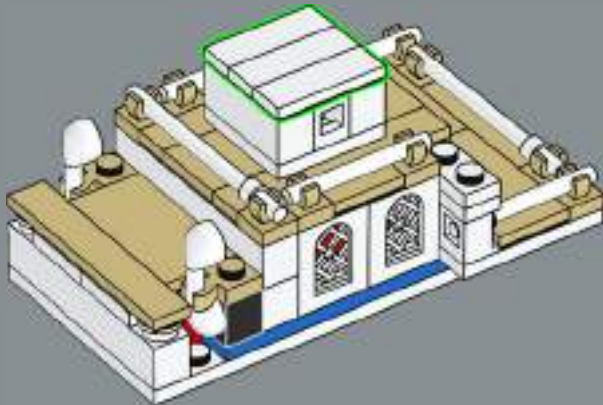

394

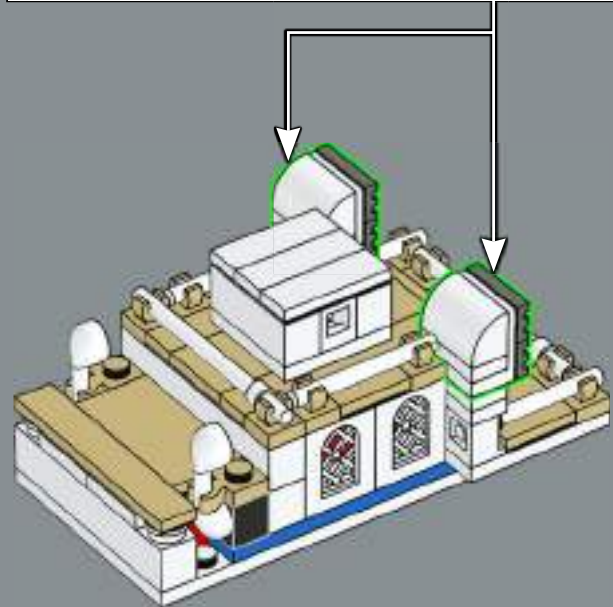
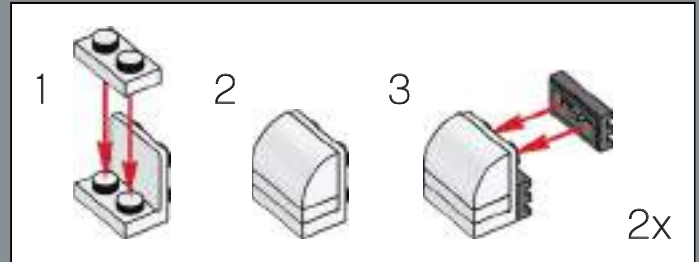





396

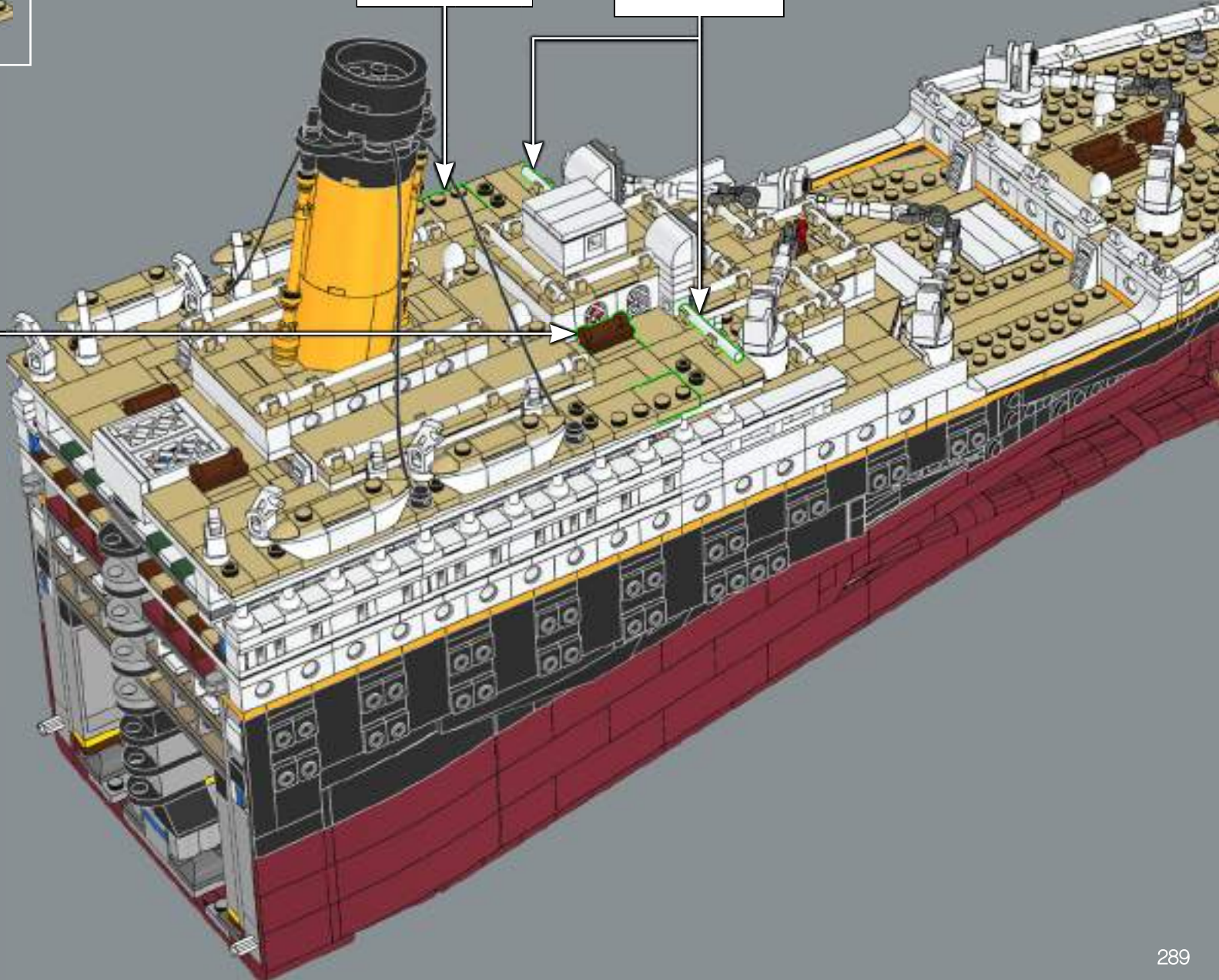



397

1

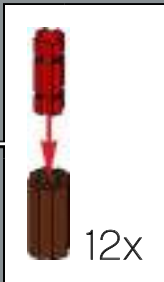

2



3



4



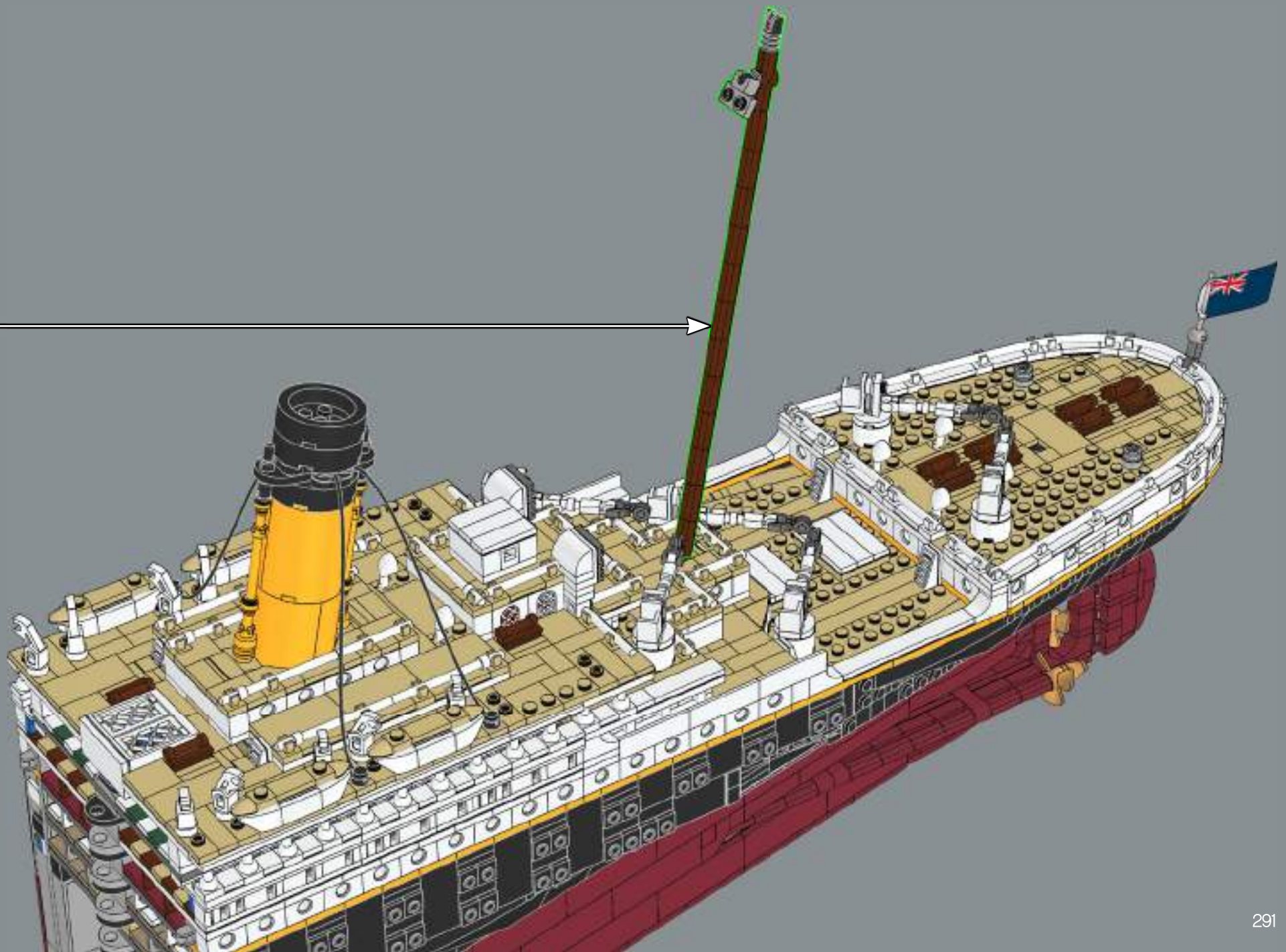

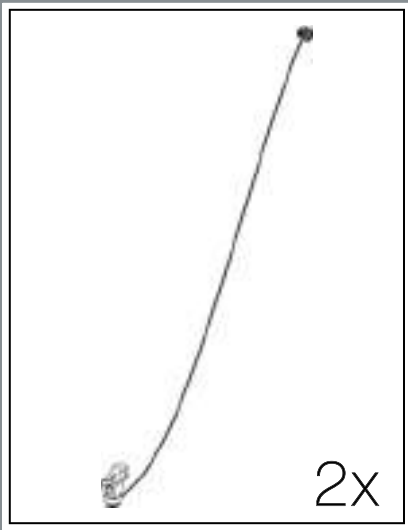

398

1



2



2x



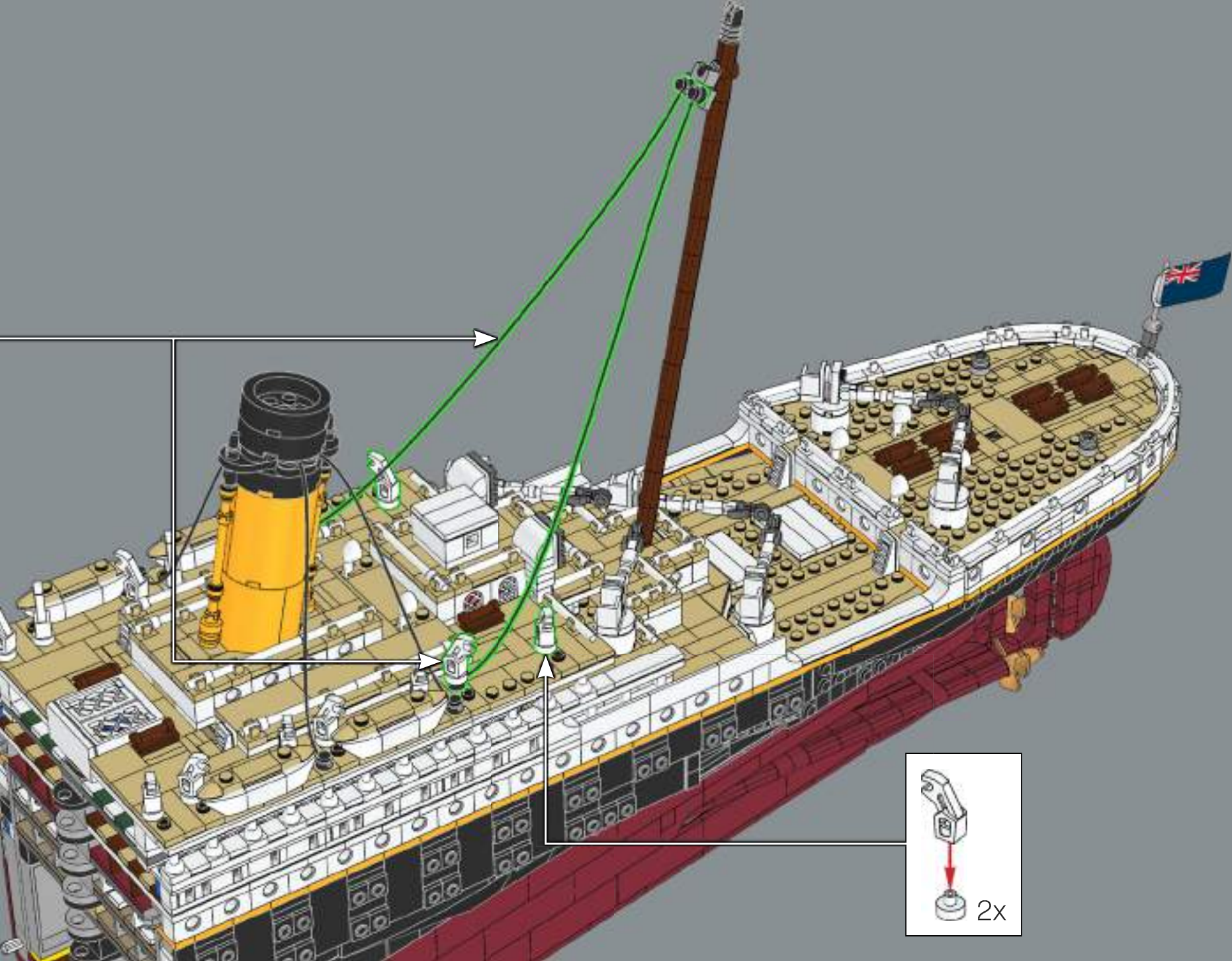



399

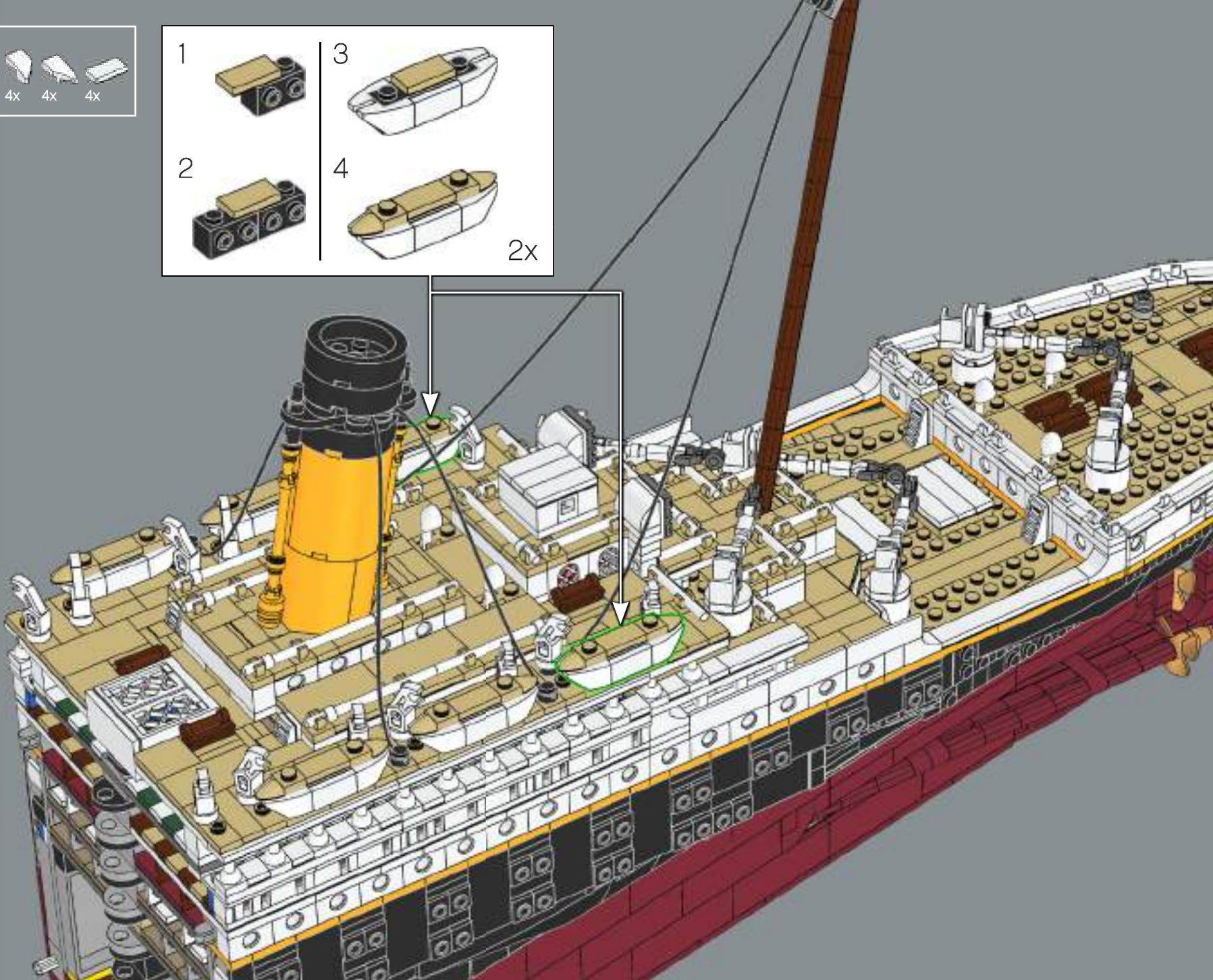
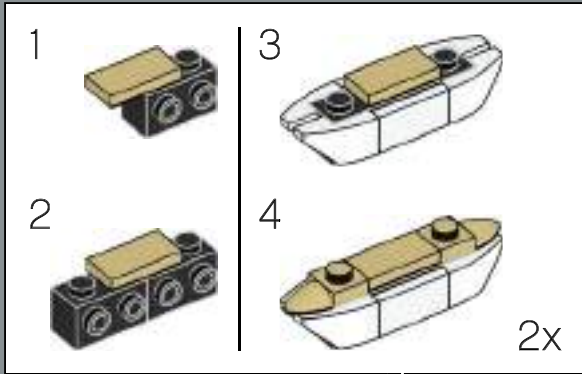



400

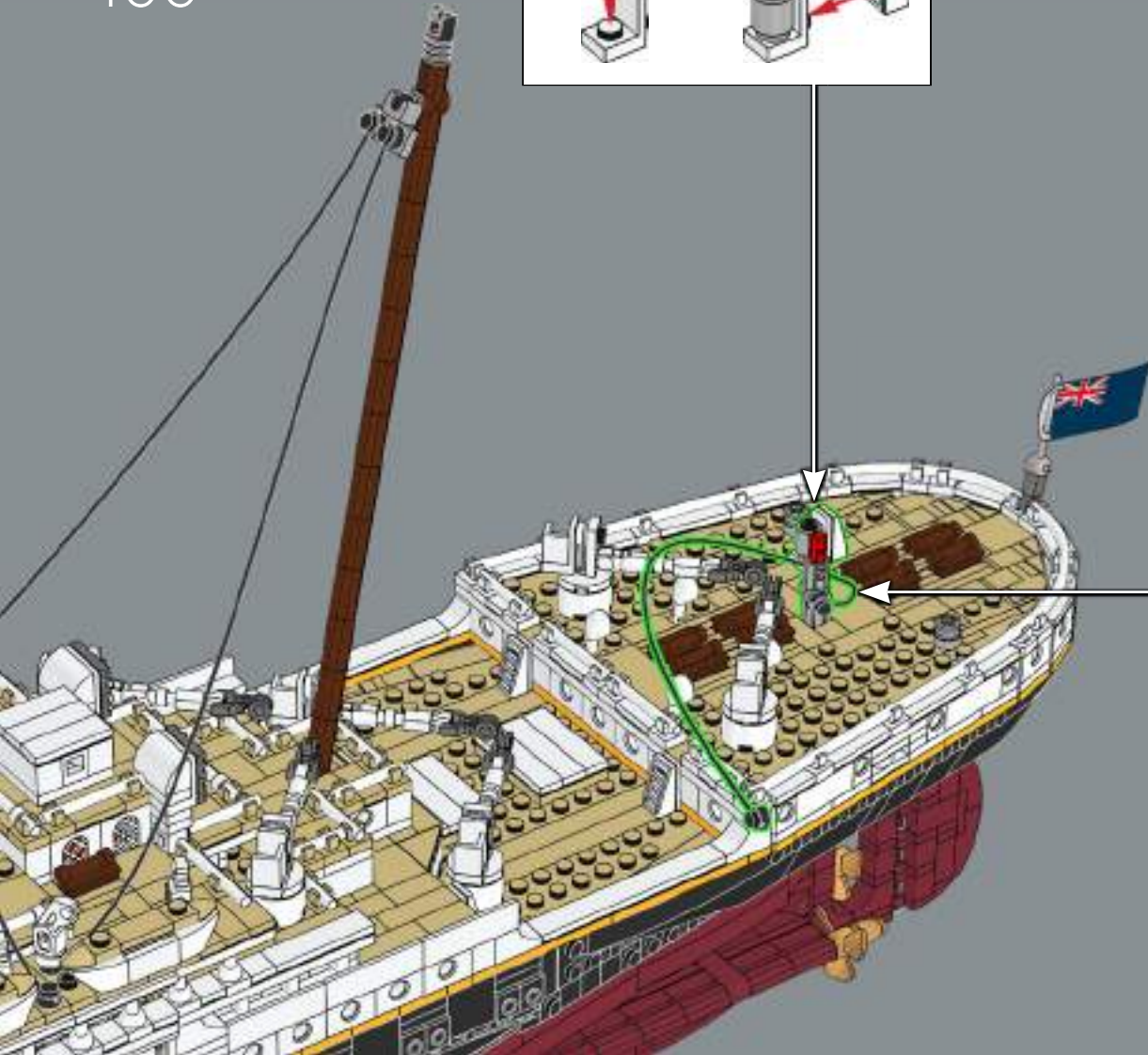
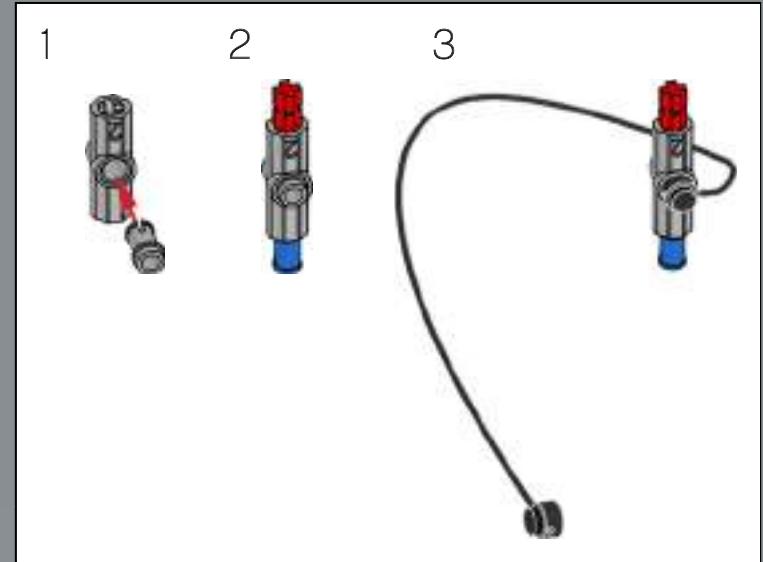
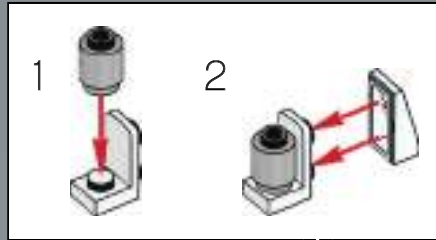

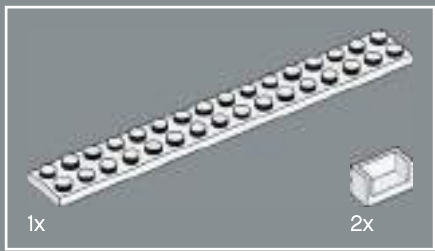

401

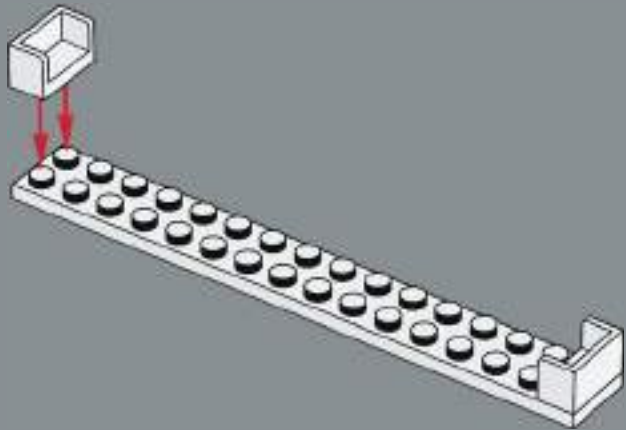

402

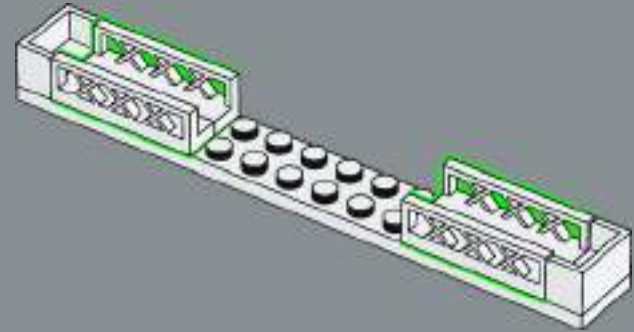

403

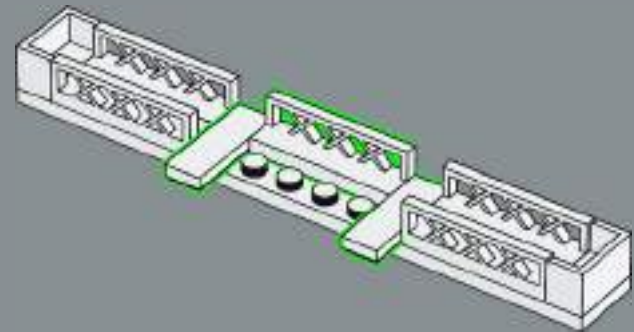



404

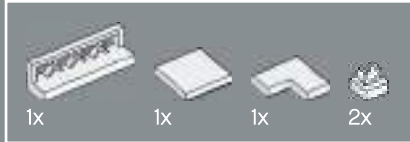
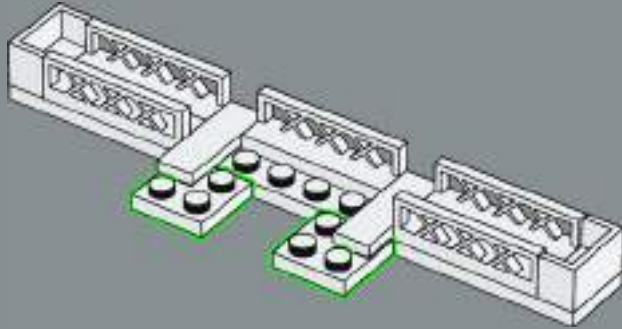

405

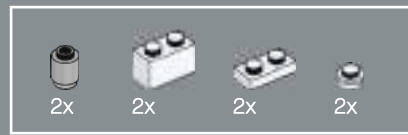
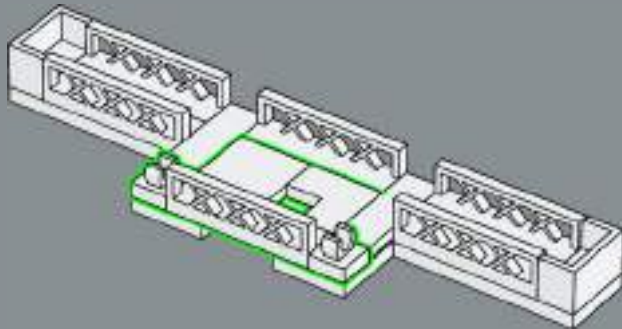

406

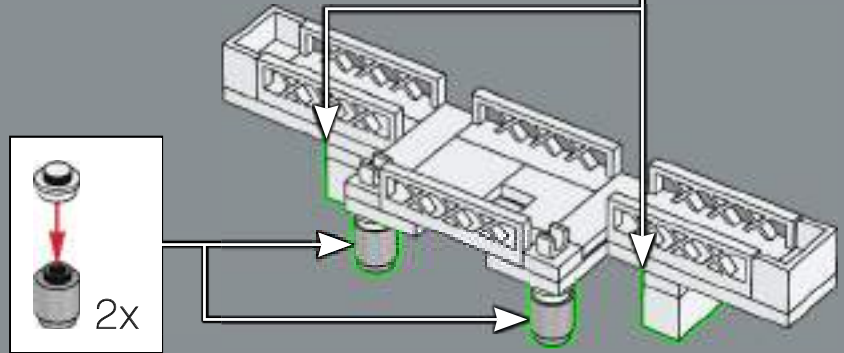

407

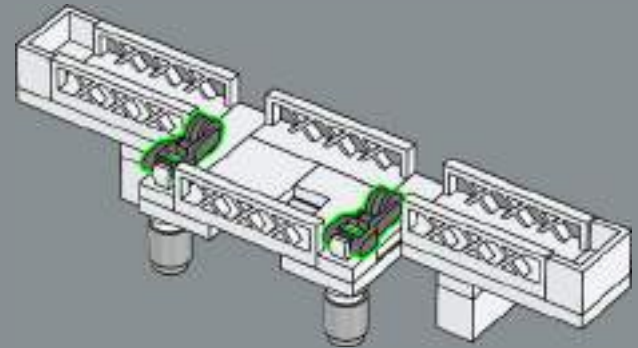



1x

408

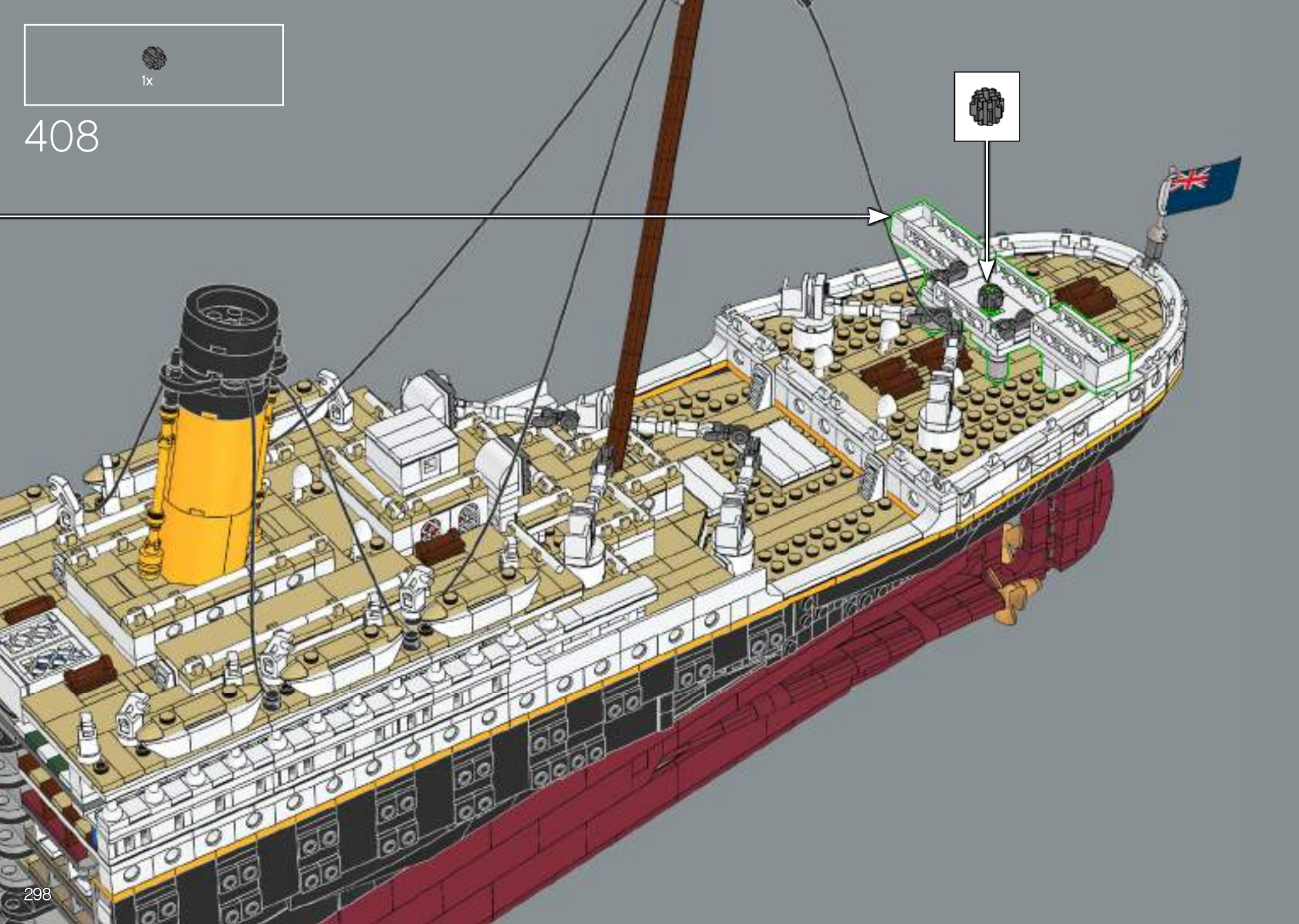



46

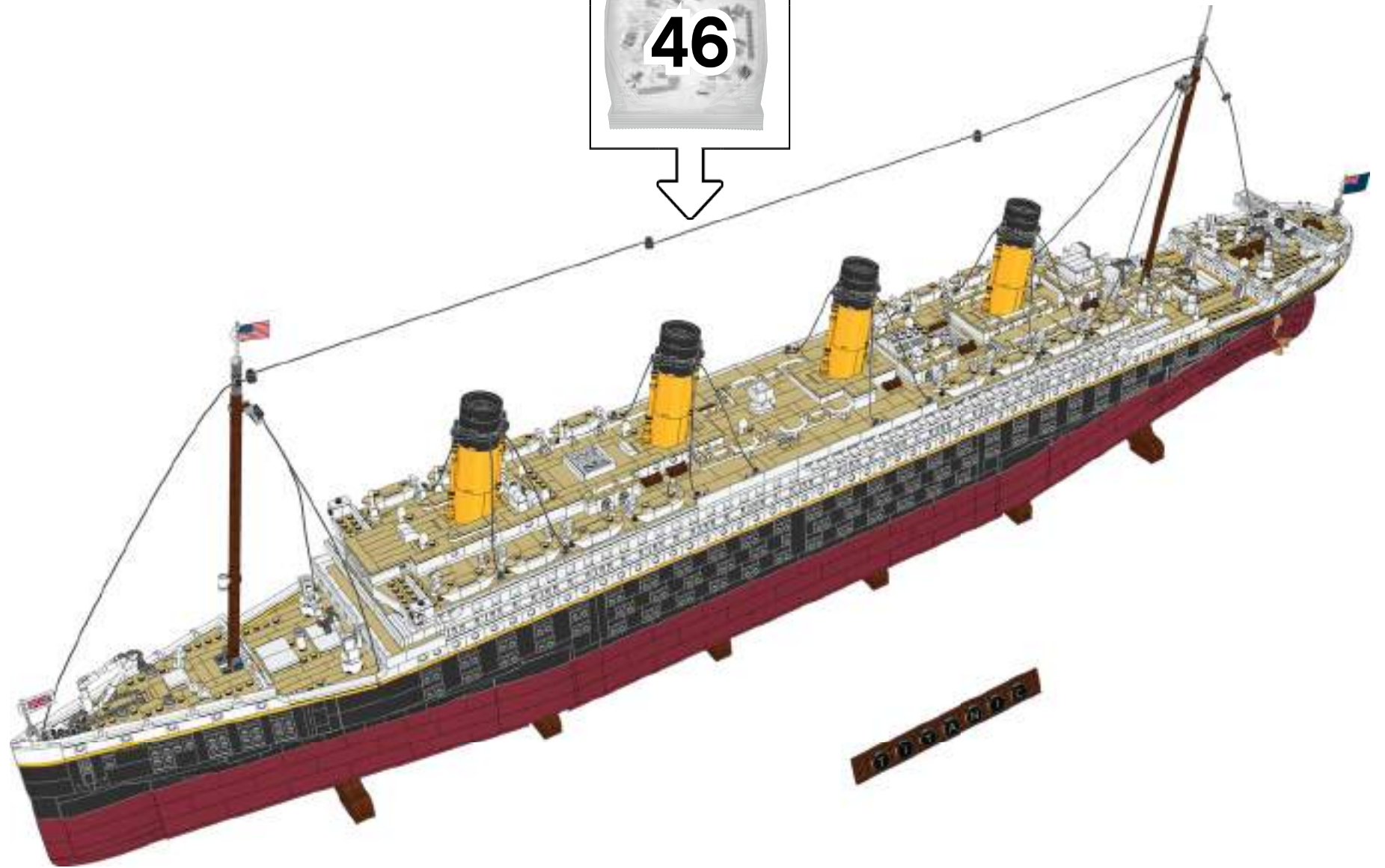



409



410

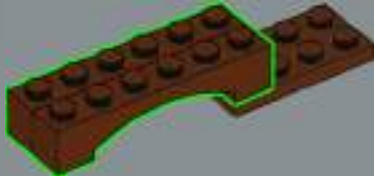

411



412

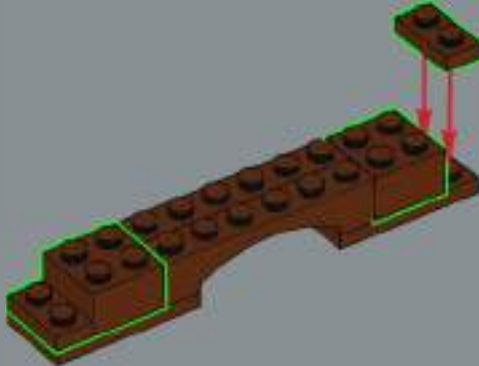



413

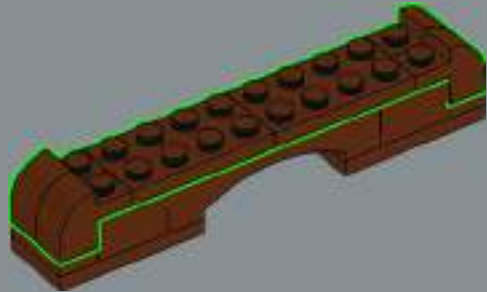

414

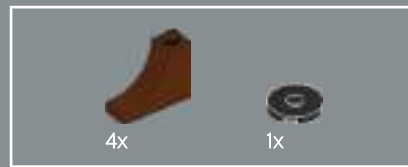
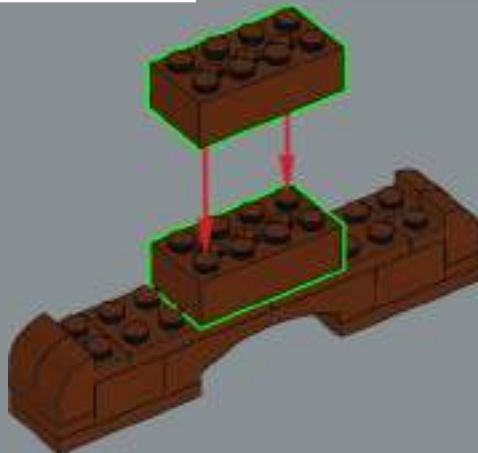

415

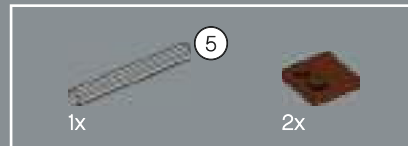
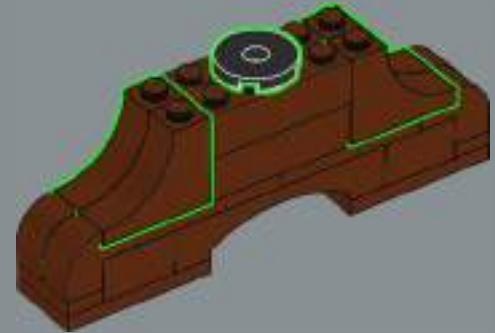

416

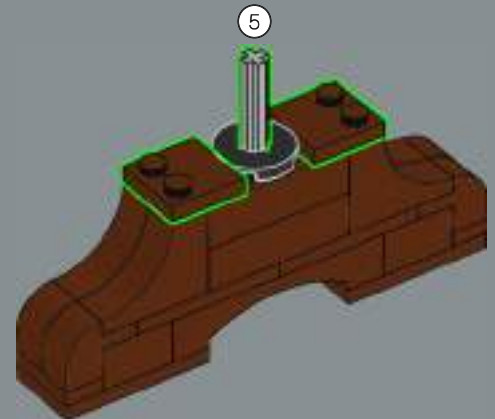

2x



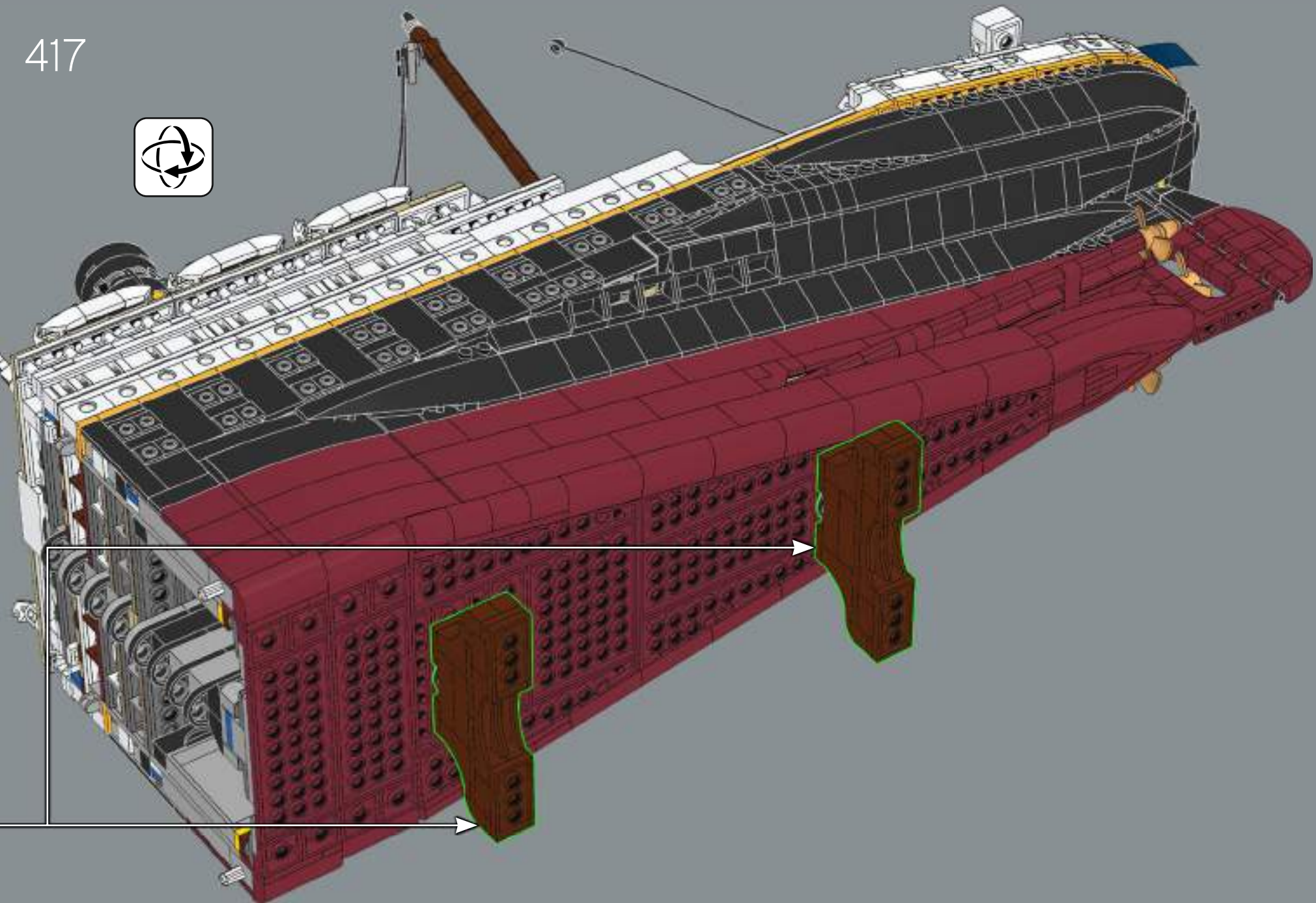

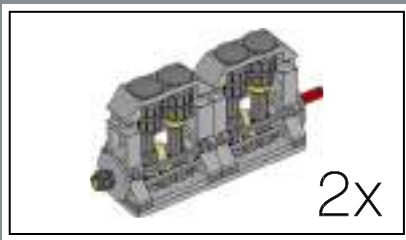

418



419

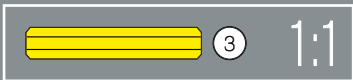
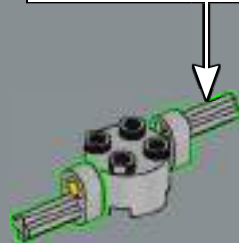
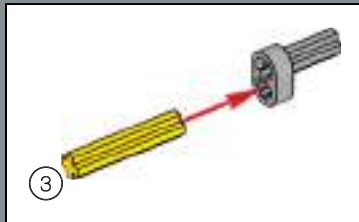

420

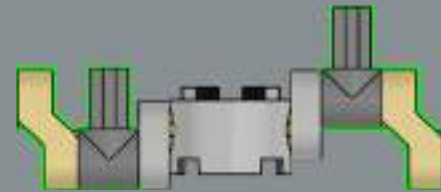

1:1



421

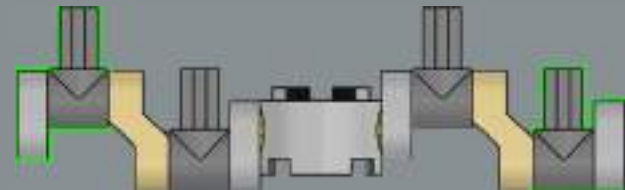

1:1

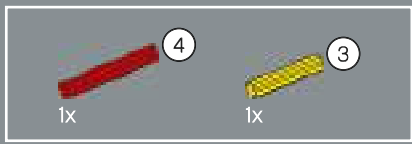

422

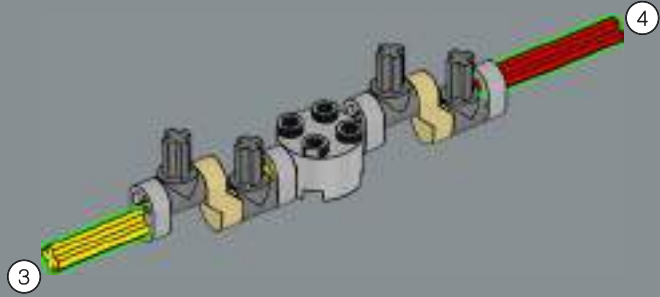

423

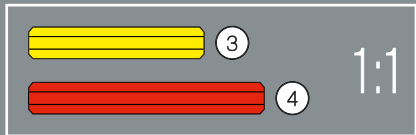
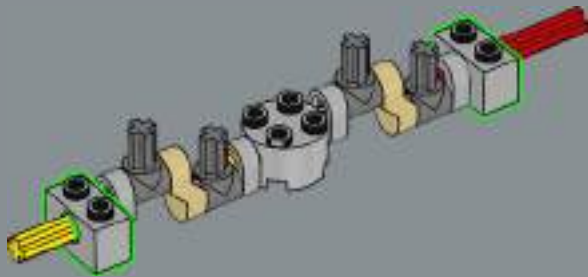

304



424

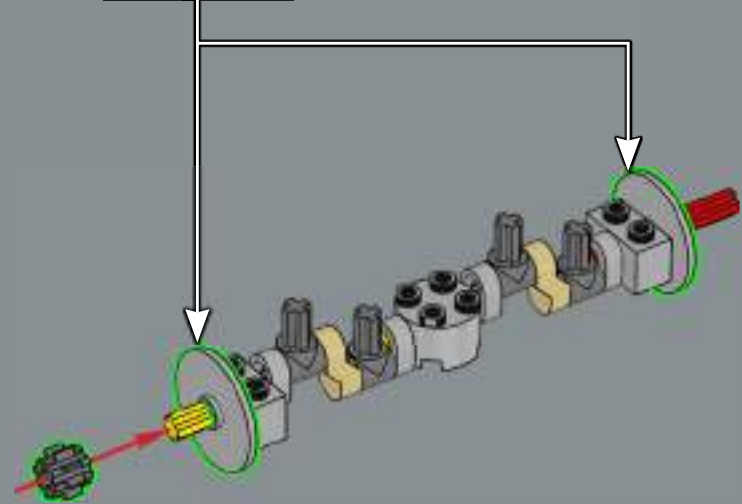
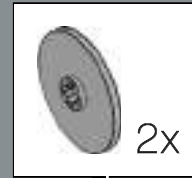



425

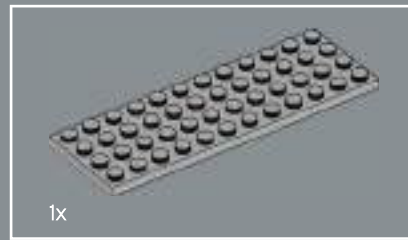
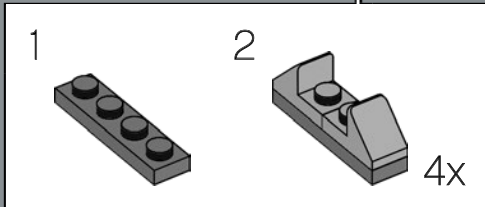
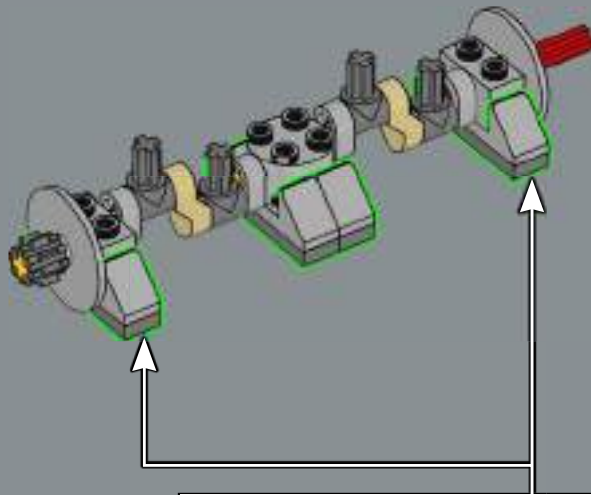

426

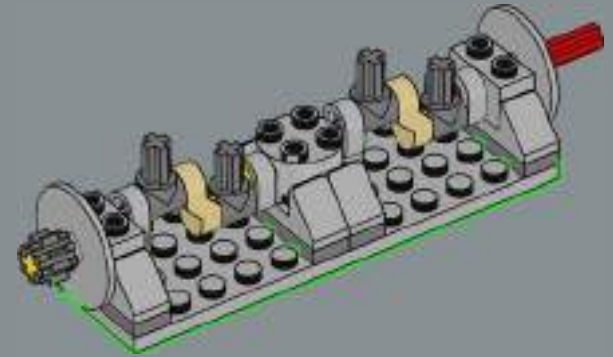

427

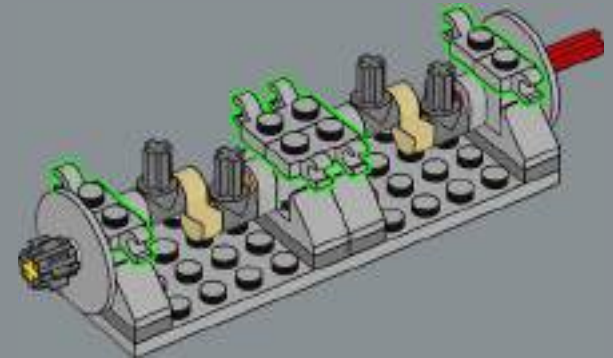



428

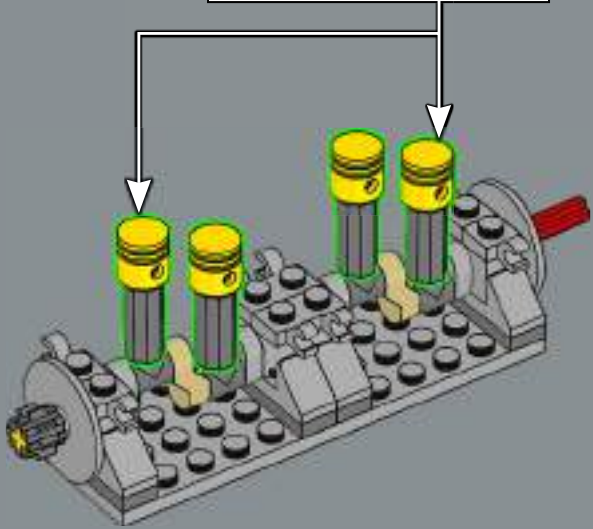

429

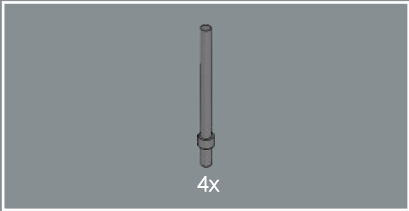
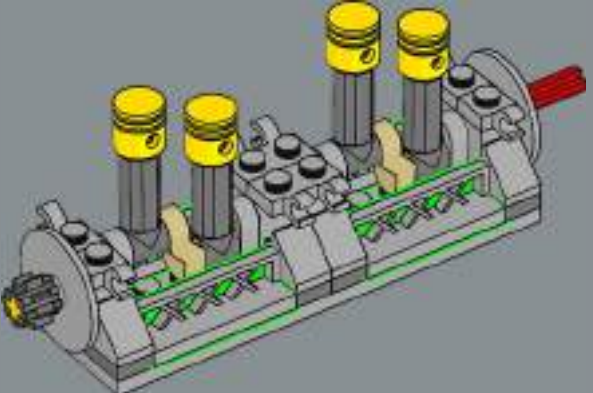

430

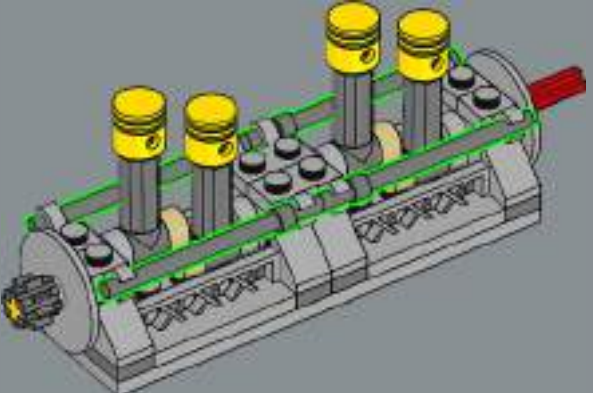

433

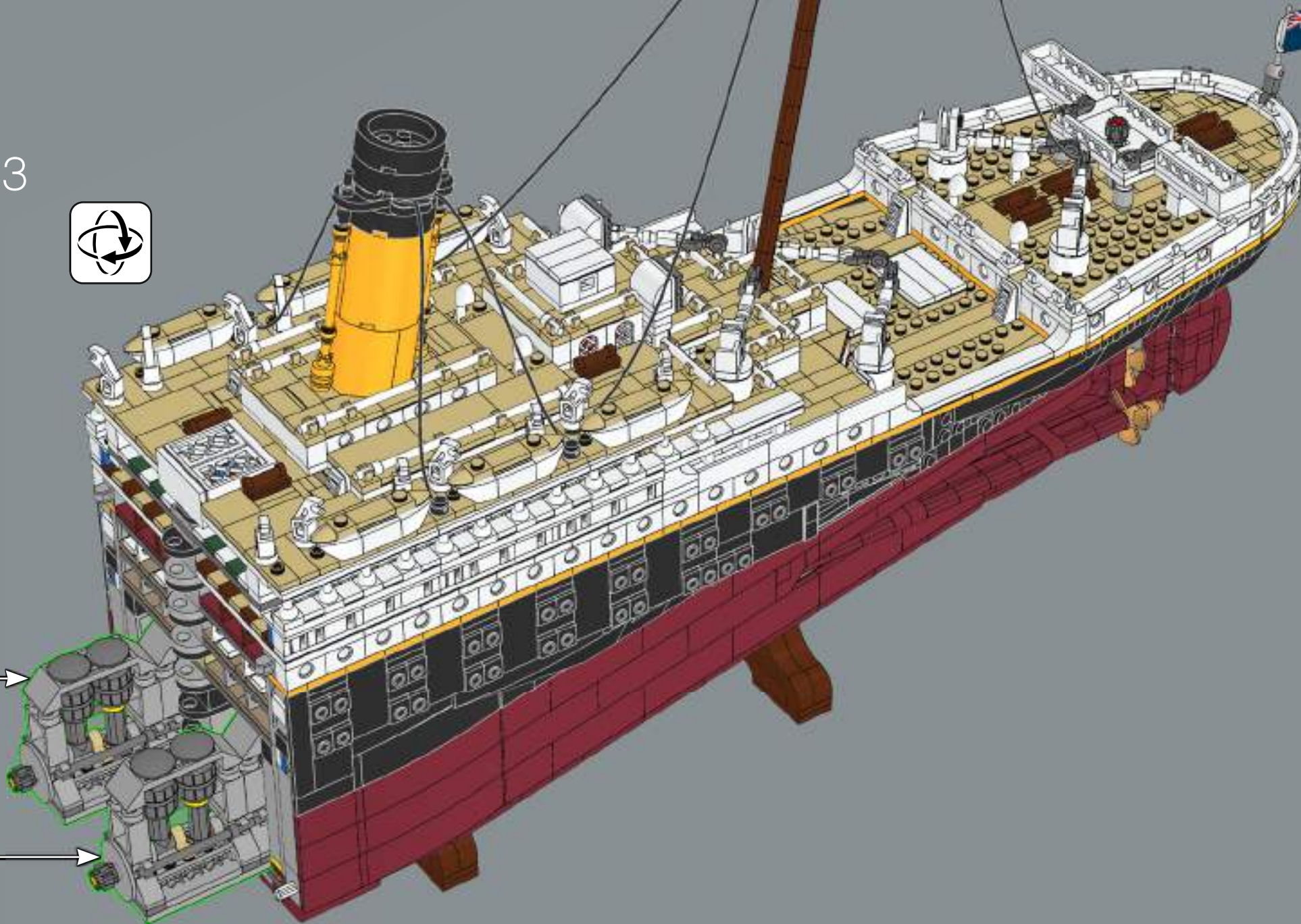



434

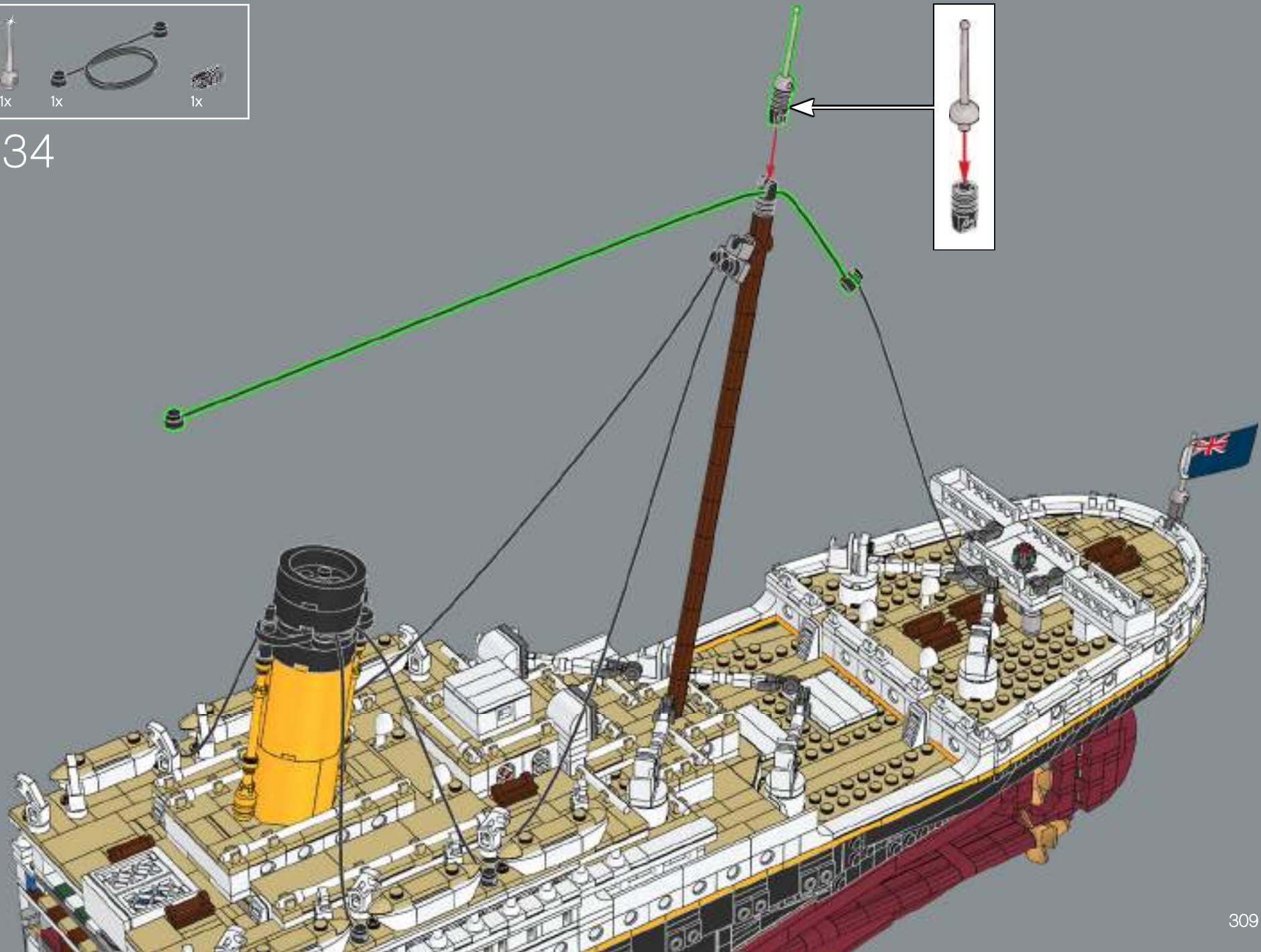

435

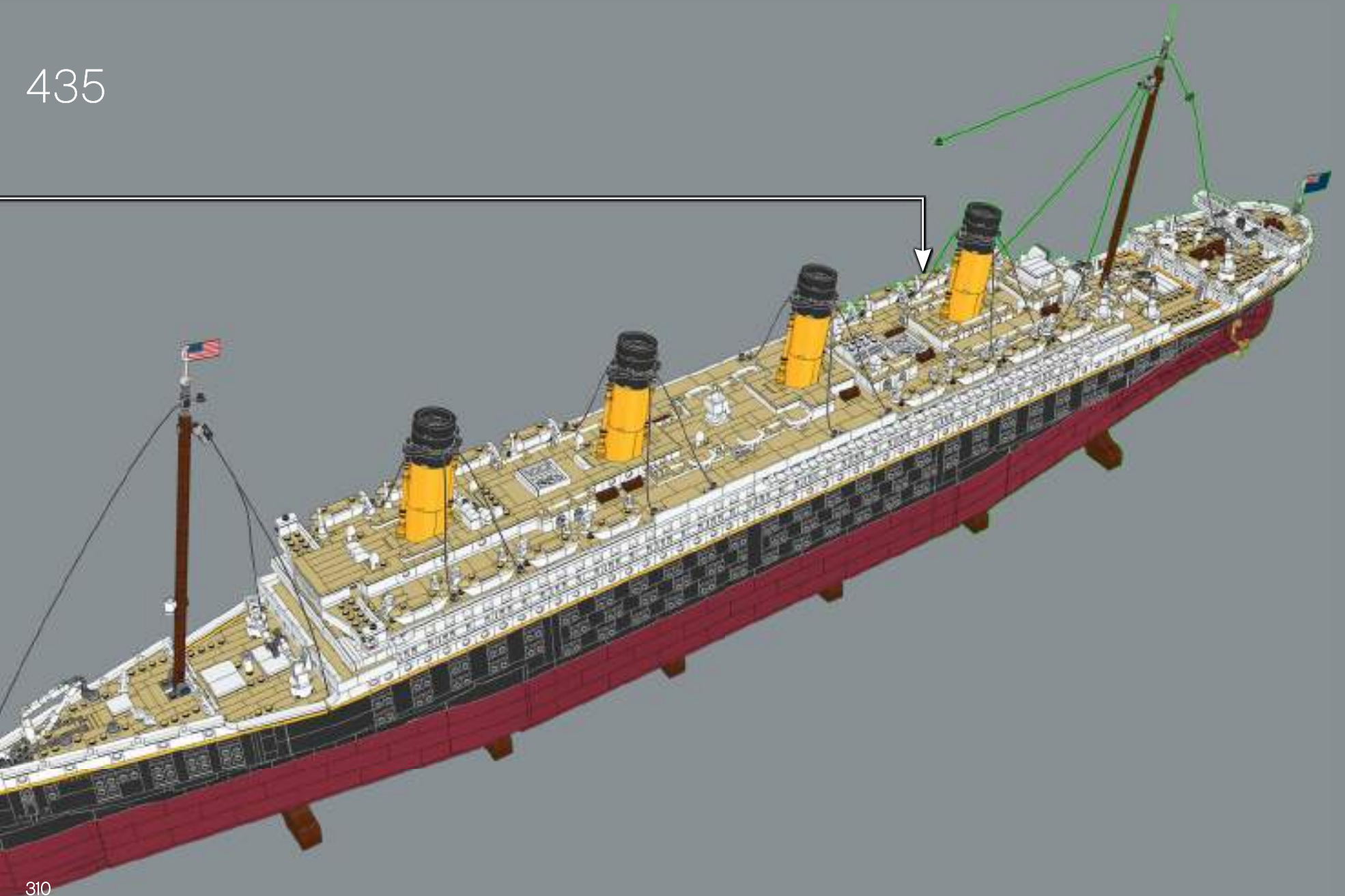

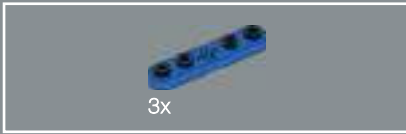

3x

436

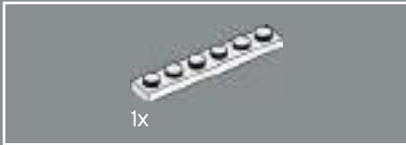
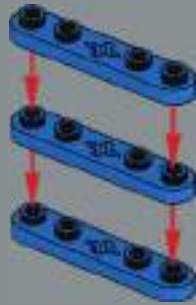

1x

437

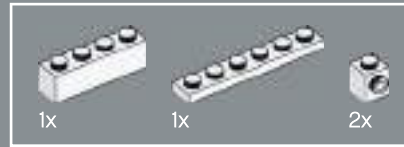
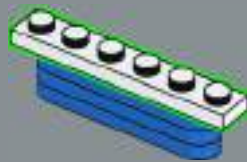

1x

1x

2x

438

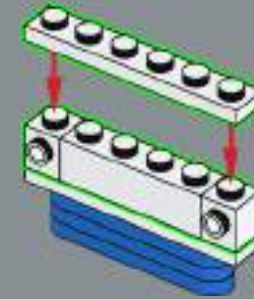

2x

2x

2x

439

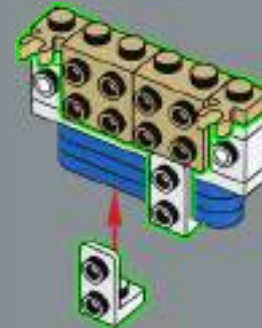



440

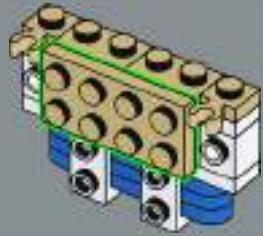

441

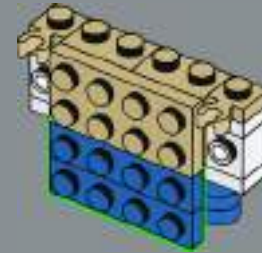



442

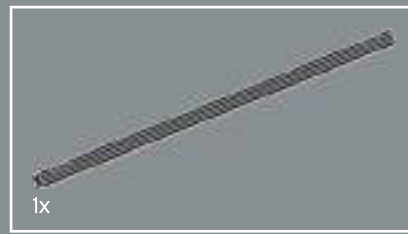
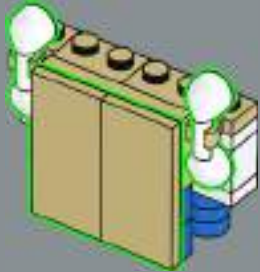

443

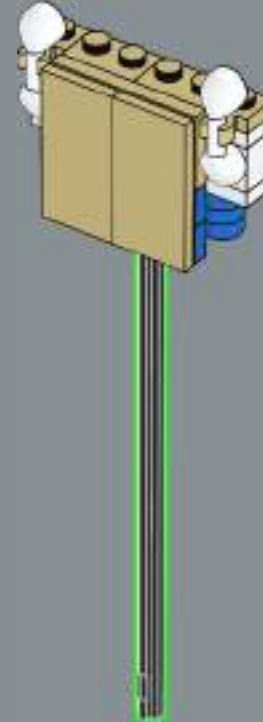

The *Titanic* was launched on the 31st of May
1911 - 110 years ago in 2021.

444

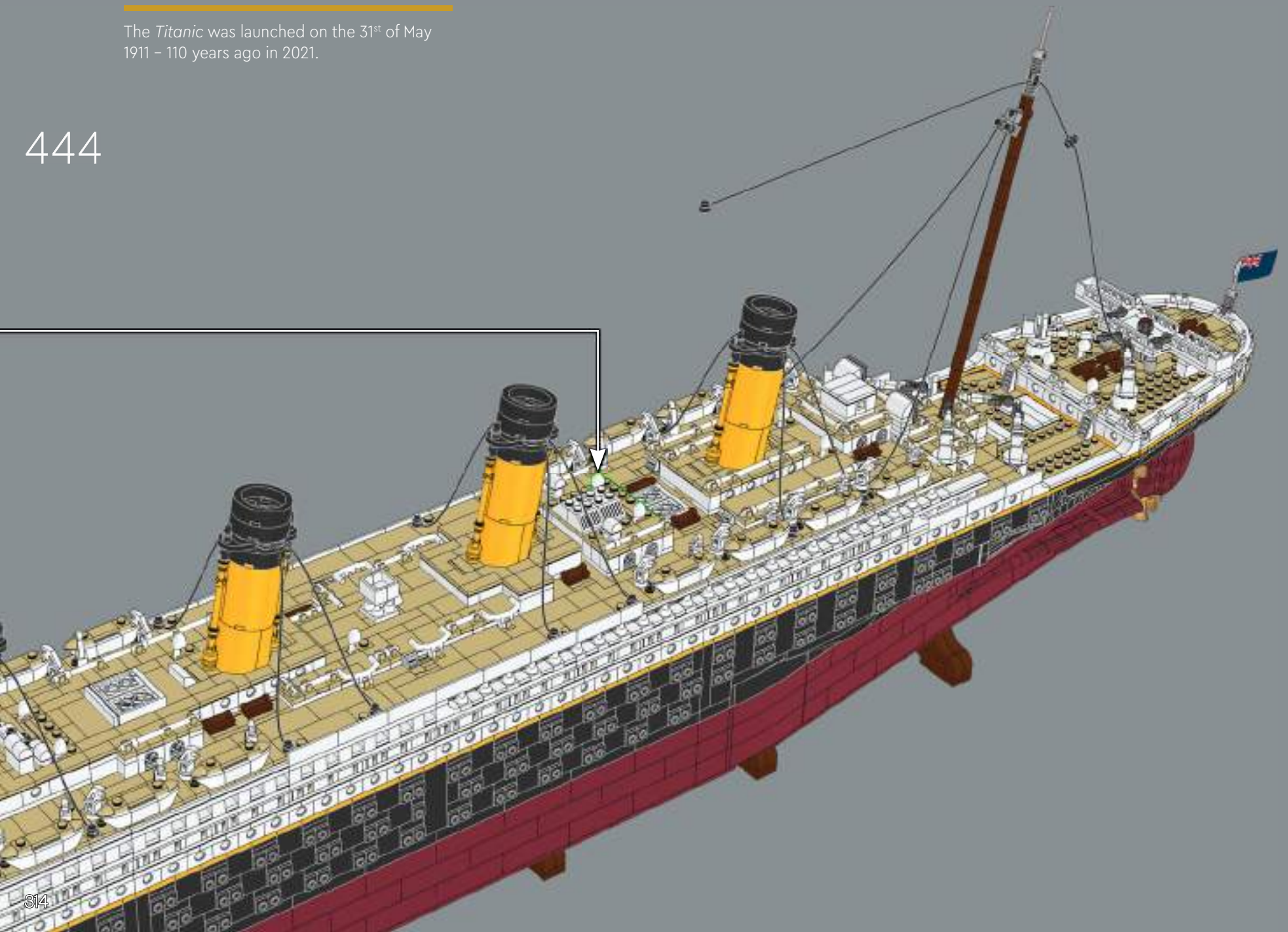

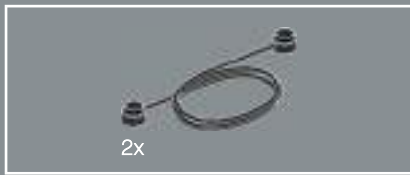

445

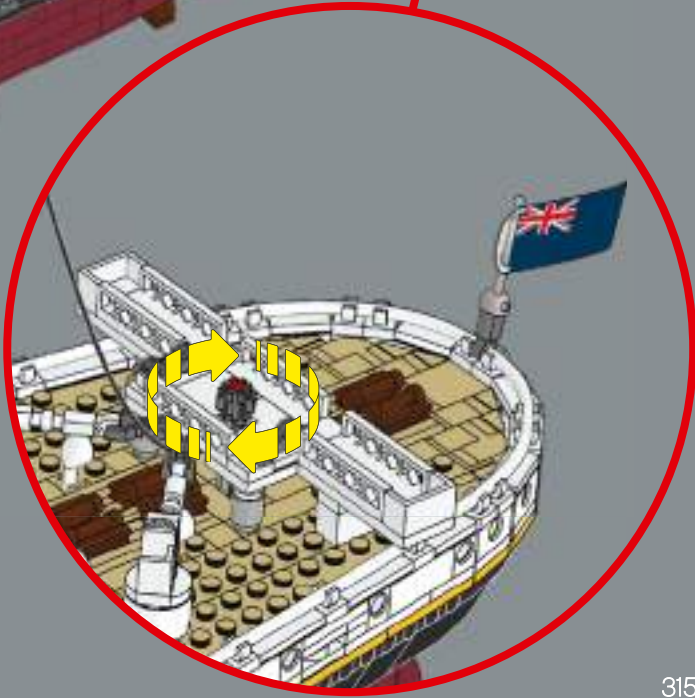
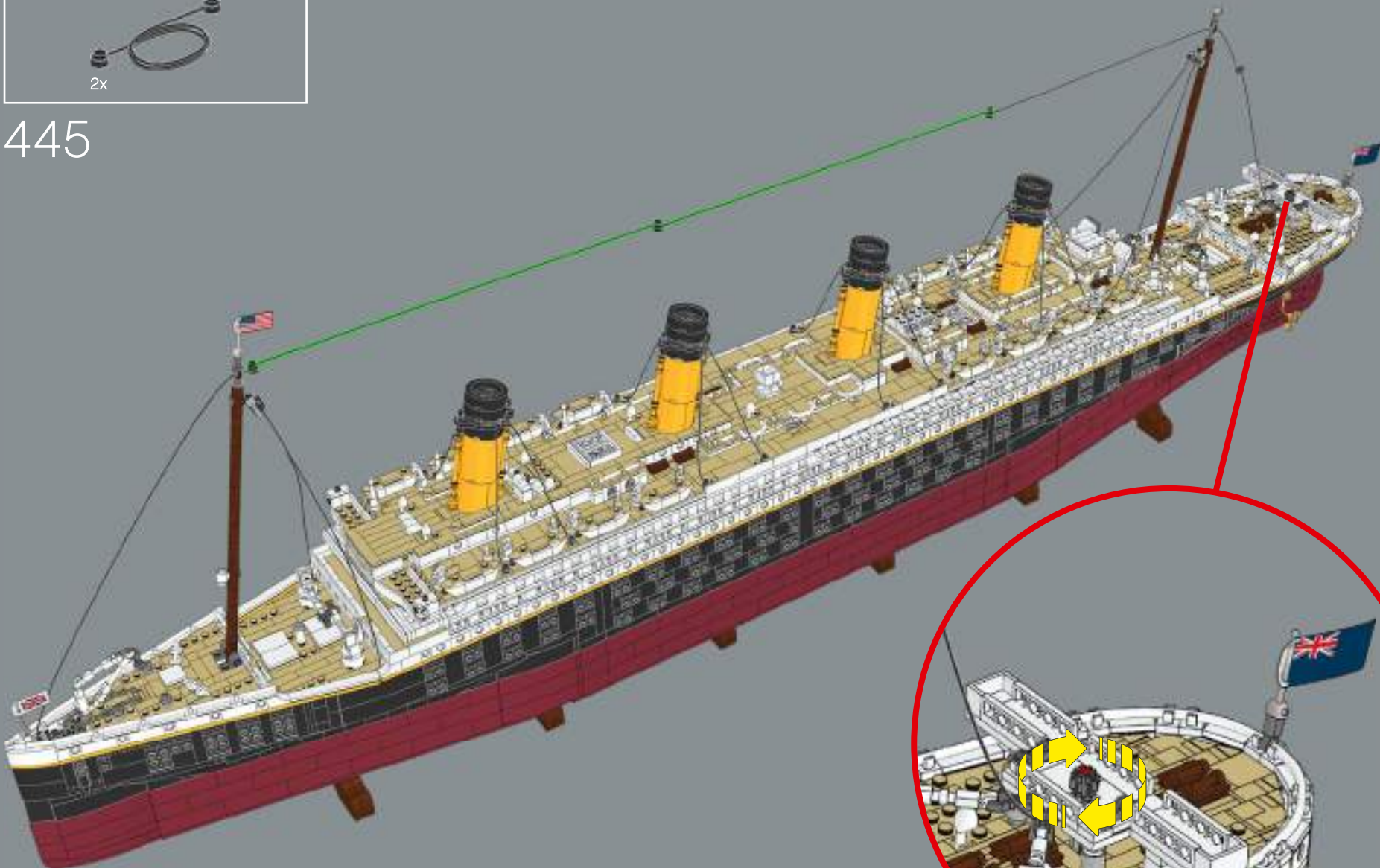

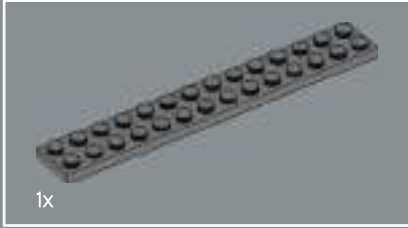

446

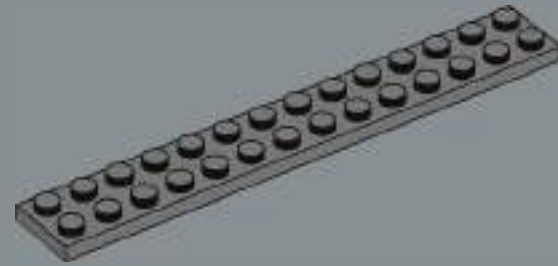

447

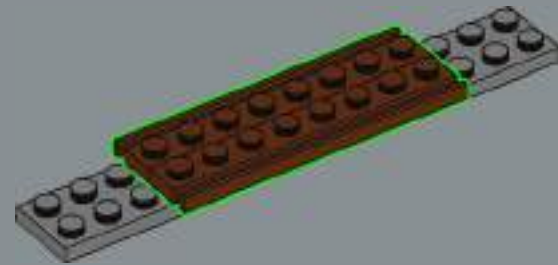



448

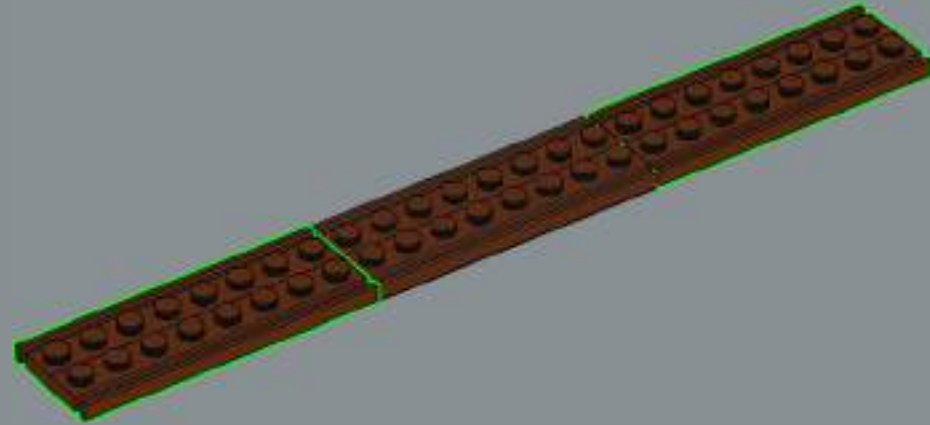

449

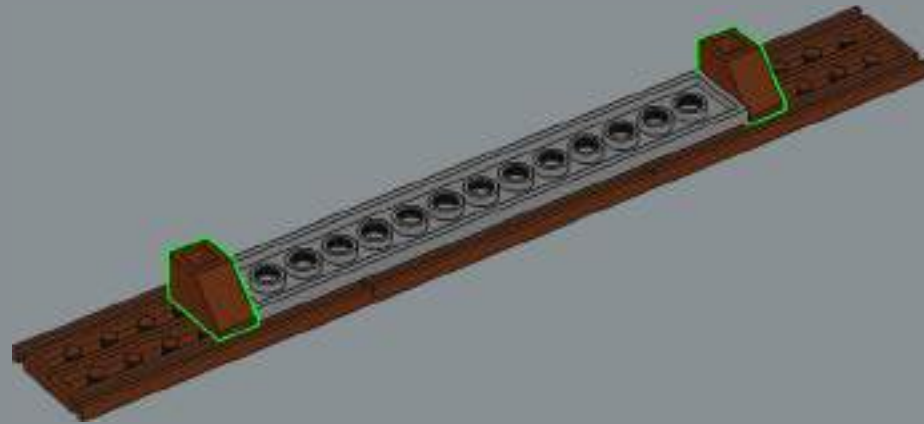



450

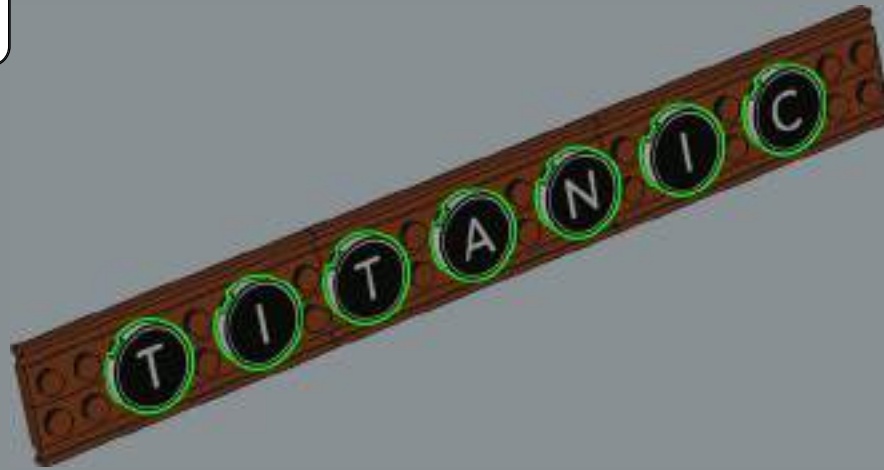

The name *Titanic* derives from the Titans of Greek mythology.

451

