



Welcome to  
**Animal Crossing**

77049



Q LEGO® Builder



LEGO.com/sustainable-packaging



FR  
**DONNEZ**  
OU  
**RECYCLEZ**



OU



OU



ASSOCIATION

MAGASIN

DÉCHÈTERIE

Adresses sur [quefairedemesdechets.fr](http://quefairedemesdechets.fr)



🔍 LEGO® Builder

# BUILDER



Apple and the Apple logo are trademarks of Apple Inc., registered in the U.S. and other countries and regions. App Store is a service mark of Apple Inc. Google Play and the Google Play logo are trademarks of Google LLC. Tencent and the Tencent logo are trademarks of Tencent Inc.

🔍 [LEGO.com/devicecheck](https://LEGO.com/devicecheck)

EN Ask parents' permission before going online | DE Eltern um Erlaubnis bitten, bevor du online gehst | FR Demande l'autorisation d'un parent avant d'aller en ligne | IT Chiedi il permesso ai tuoi genitori prima di andare online | ES Pídeles permiso a tus papás antes de conectarte a Internet | PT Peça autorização aos pais antes de acederes online | ZH 上网前应先征得父母的同意 | PL Poproś rodziców o zgodę, zanim wejdiesz do Internetu | CS Než půjdeš na internet, požádej rodiče o svolení | SK Skôr než pôjdeš na internet, vypýtaj si povolenie od rodičov | HU Kérj szülői engedélyt, mielőtt online csatlakoznál! | RO Cere permisiunea părinților înainte de a te conecta online | BG Поискайте разрешение от родител, преди да влезете онлайн | LV Pirms došanās tiešsaistē palūdz atļauju vecākiem | ET Enne Interneti kasutamist küsi vanematelt luba | LT Prieš prisijungdami prie interneto, atsilkauskite tėvų



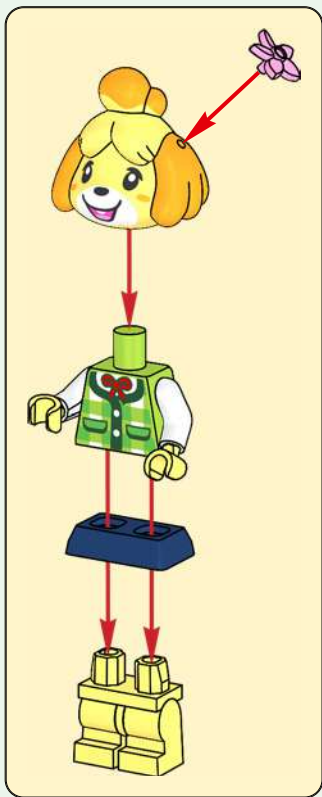

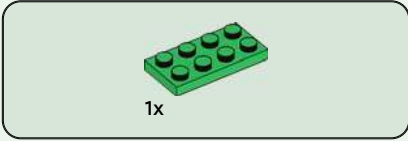

1

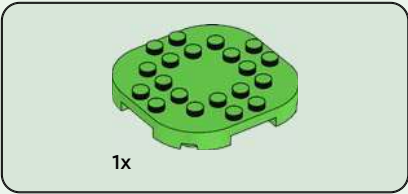
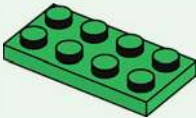

2

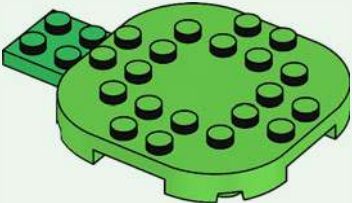

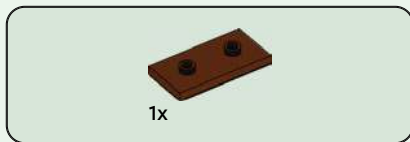

3

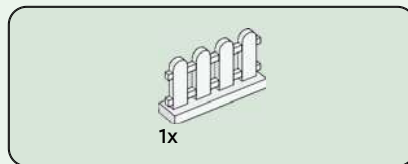
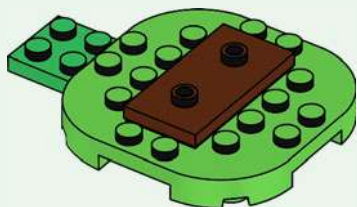

4

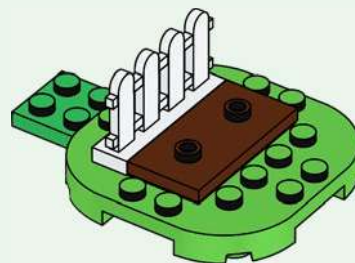

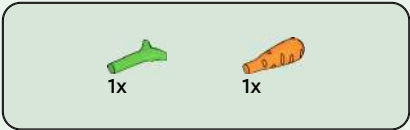

5

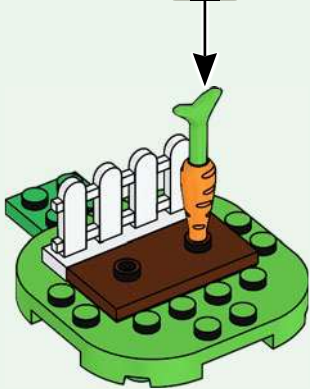
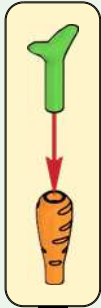





6

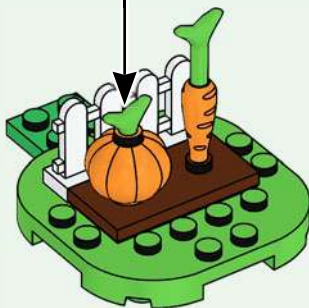
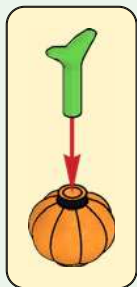

7





1x



1x

1

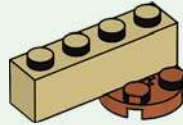



1x

2

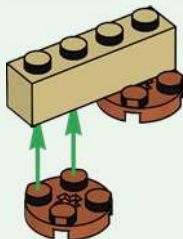

1x

3



1x

4





4x

5

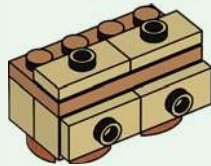

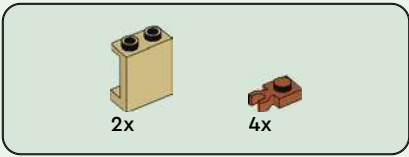

6

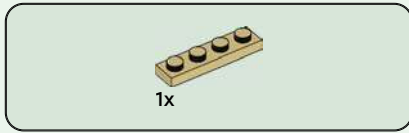
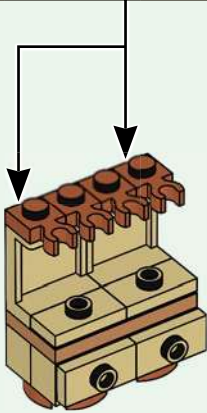
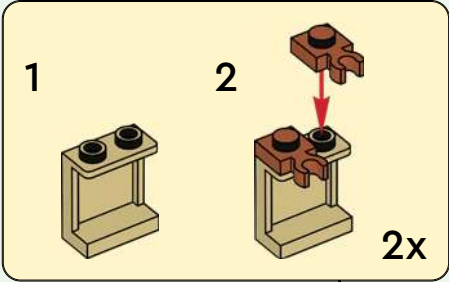

7





8

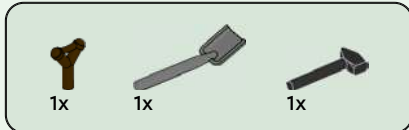
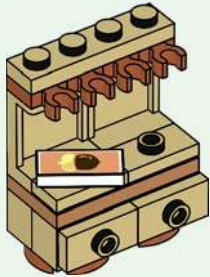

9



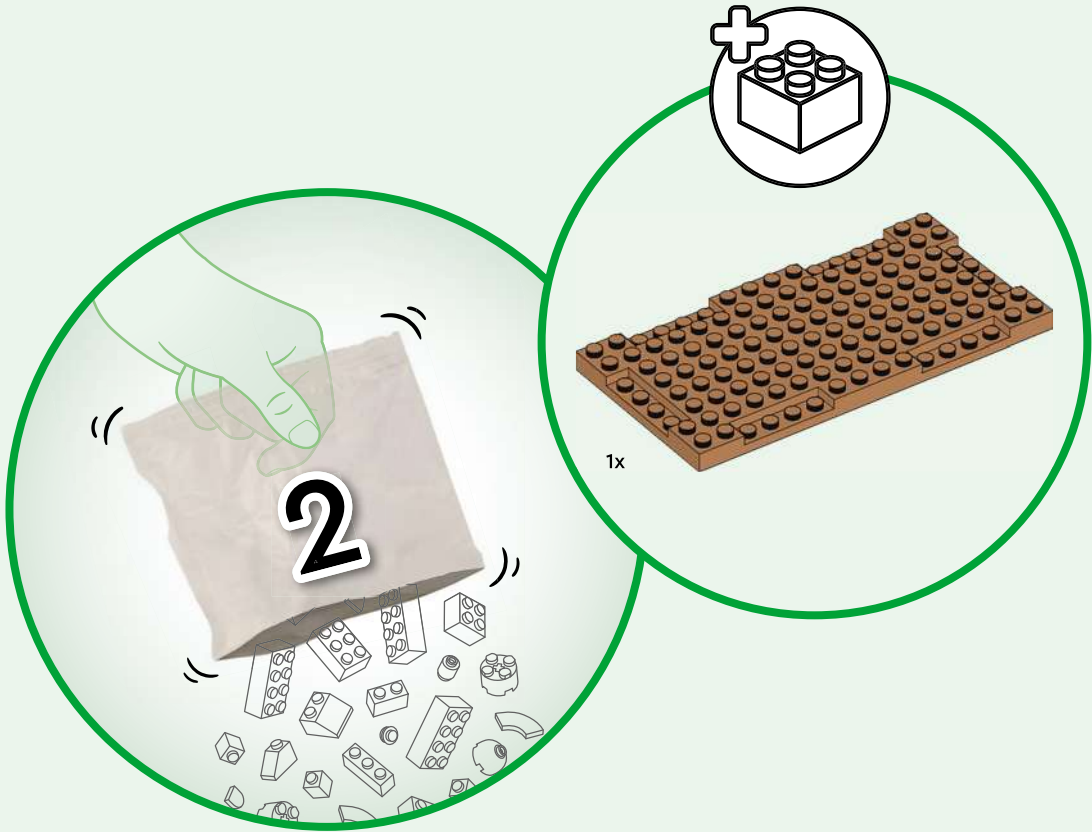





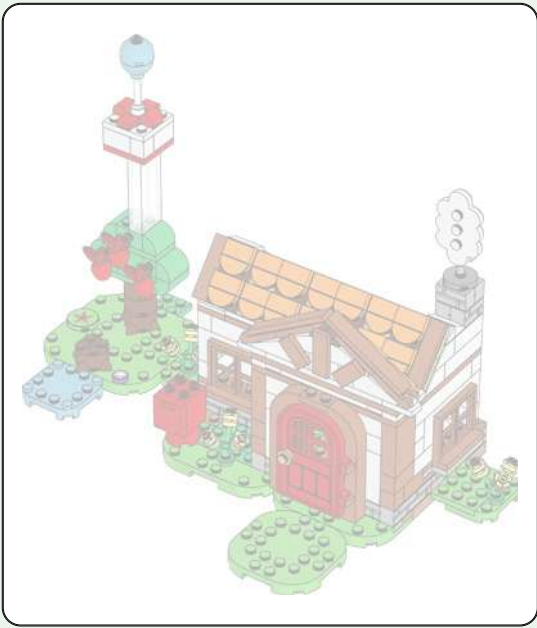

1

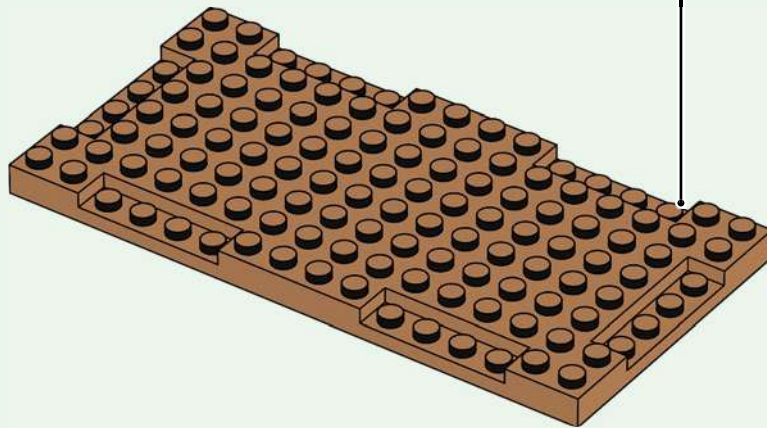
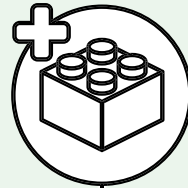

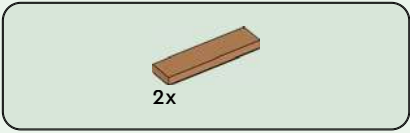

2

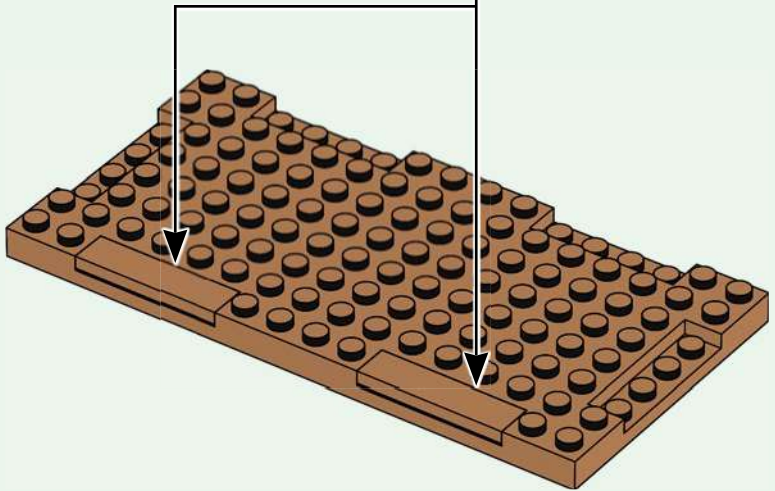
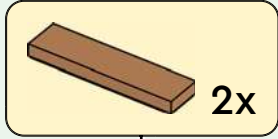

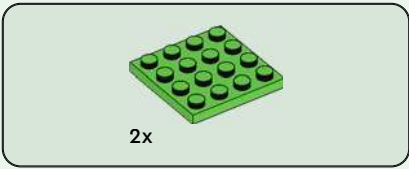

3

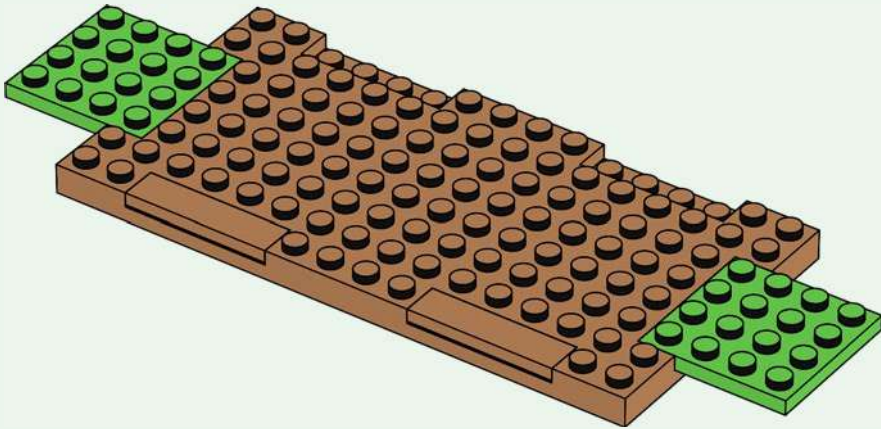

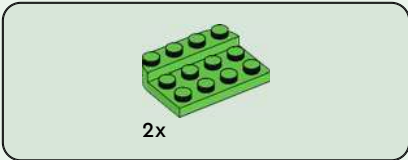

4

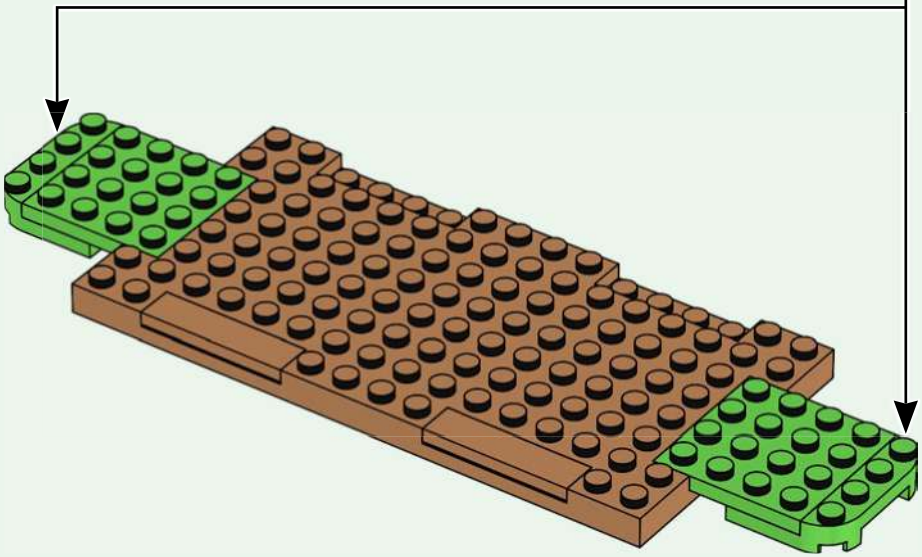
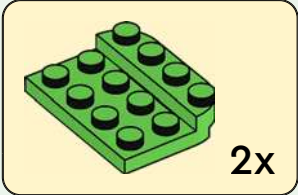

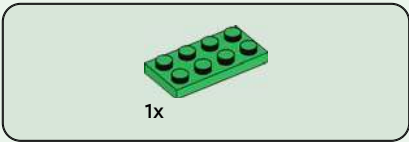

5

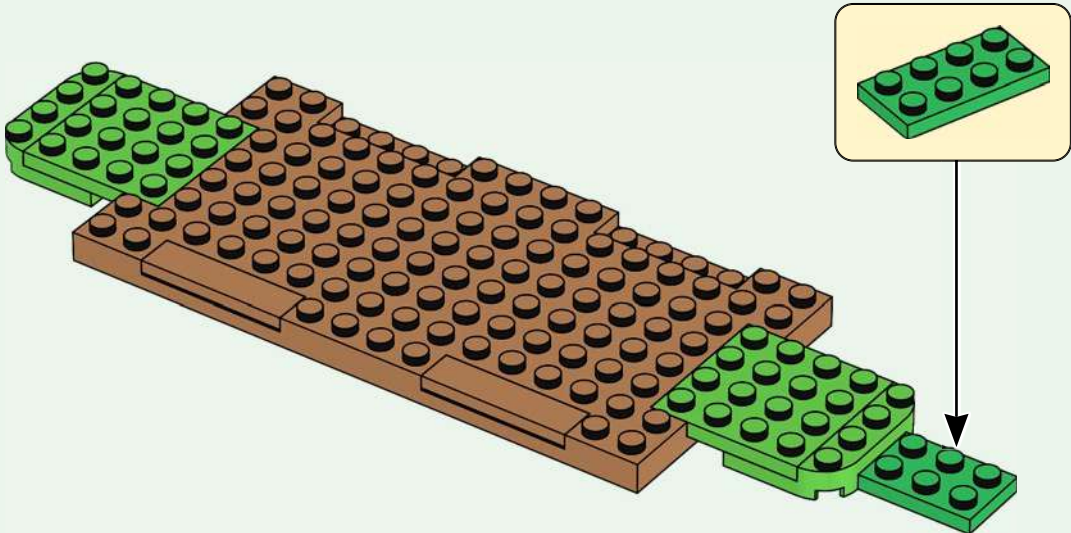

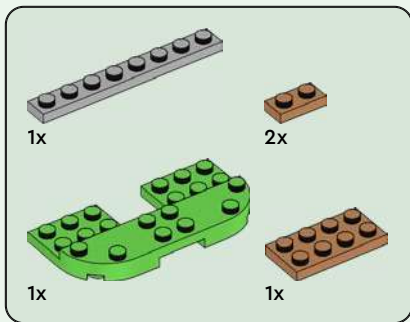

6

1

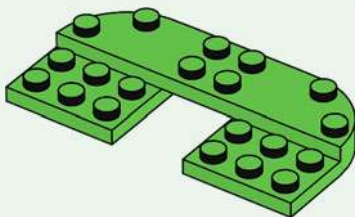

2

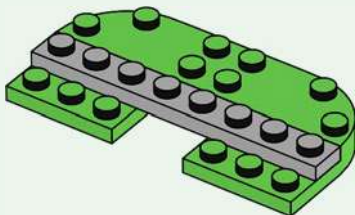

3

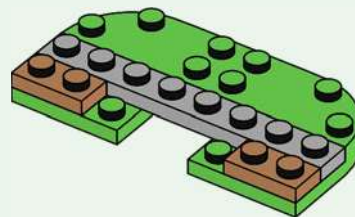

4

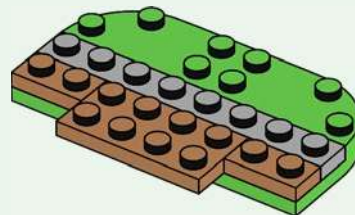

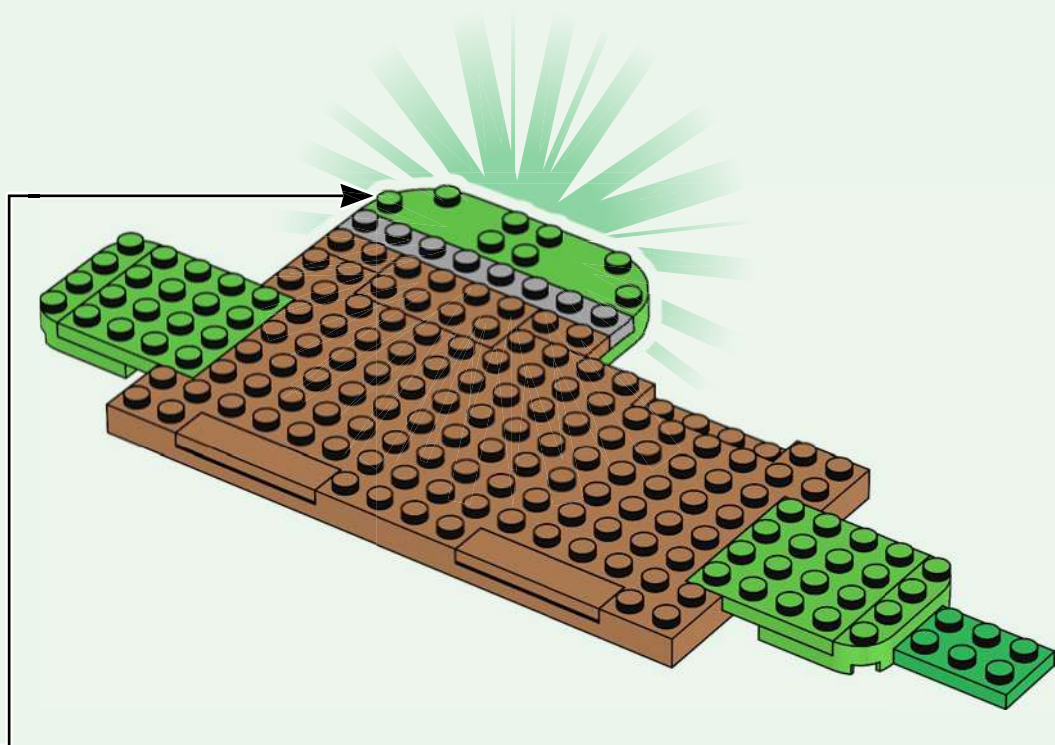

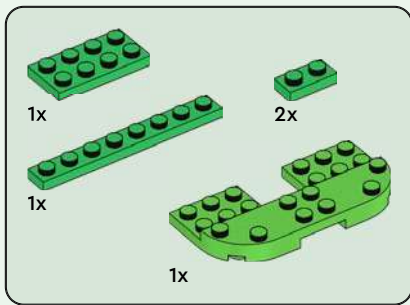

# 7

1

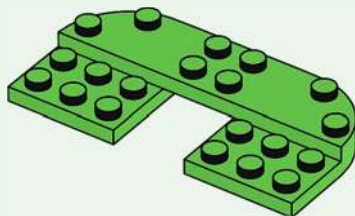

2

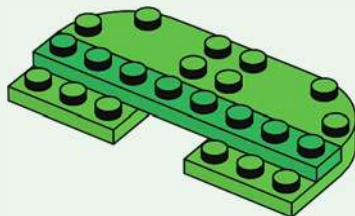

3

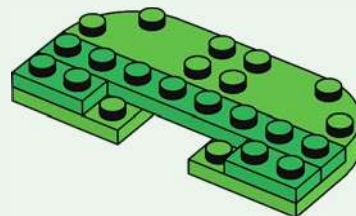

4

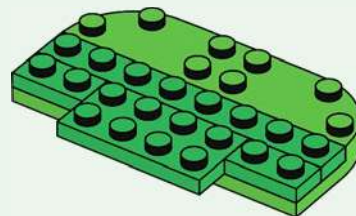



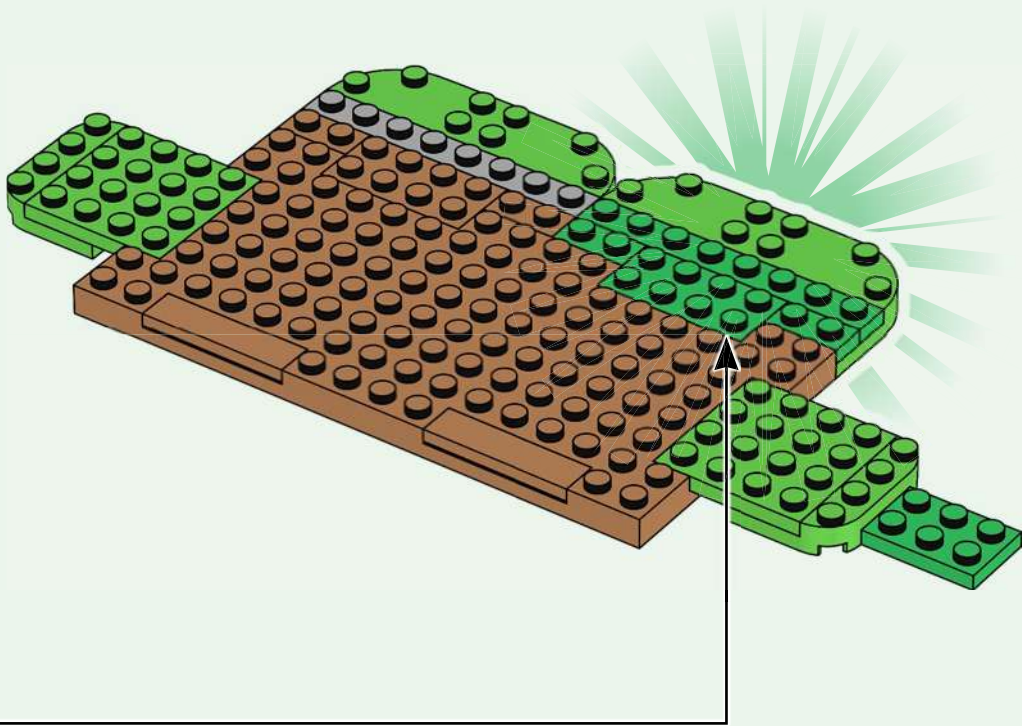

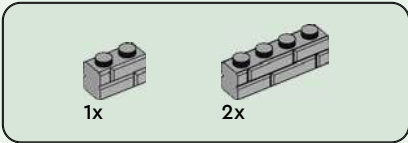

8

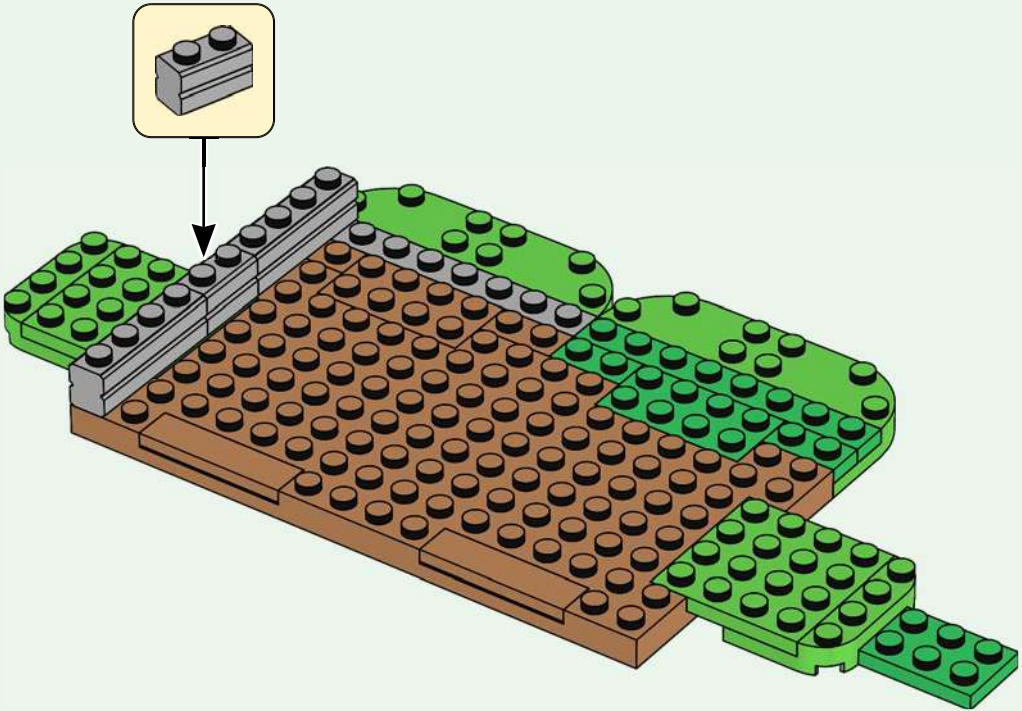



1x

9

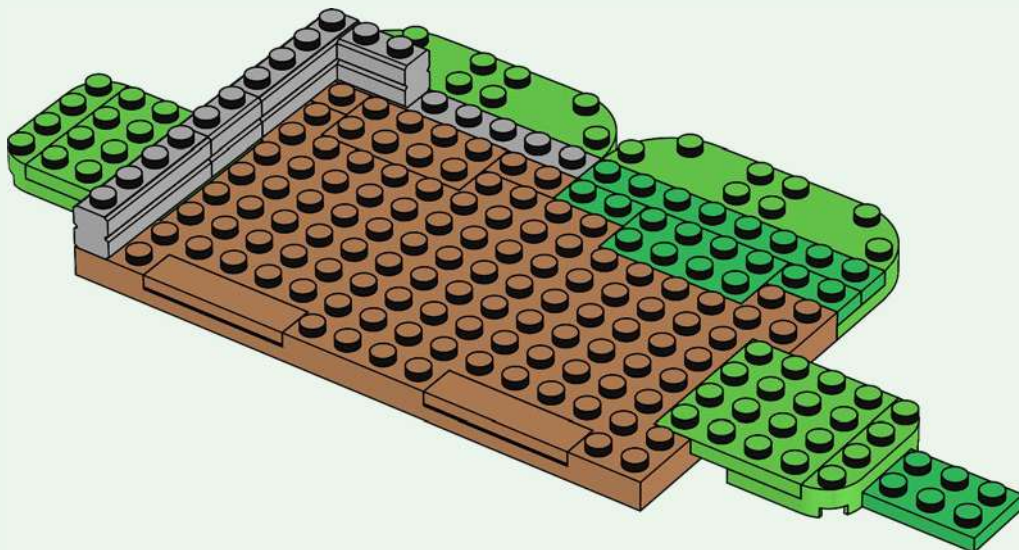

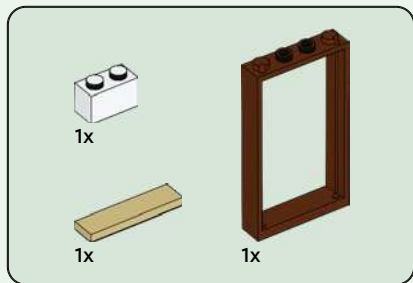

10

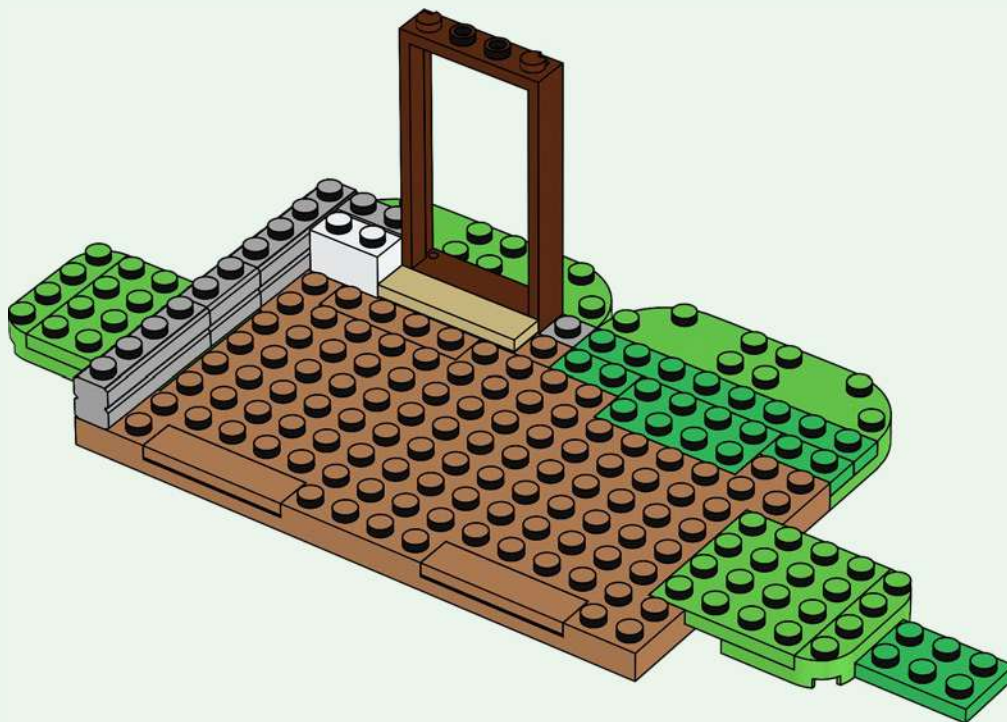



1x



1x

11

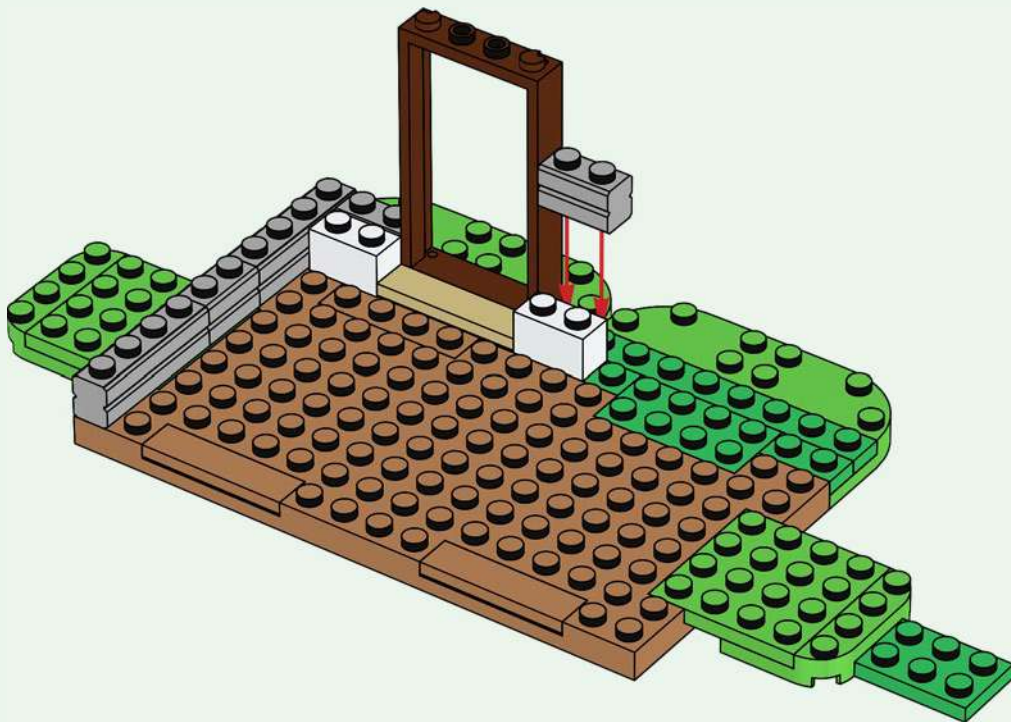

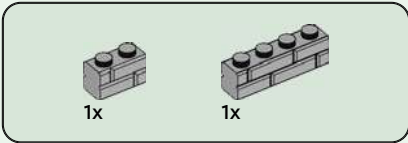

12

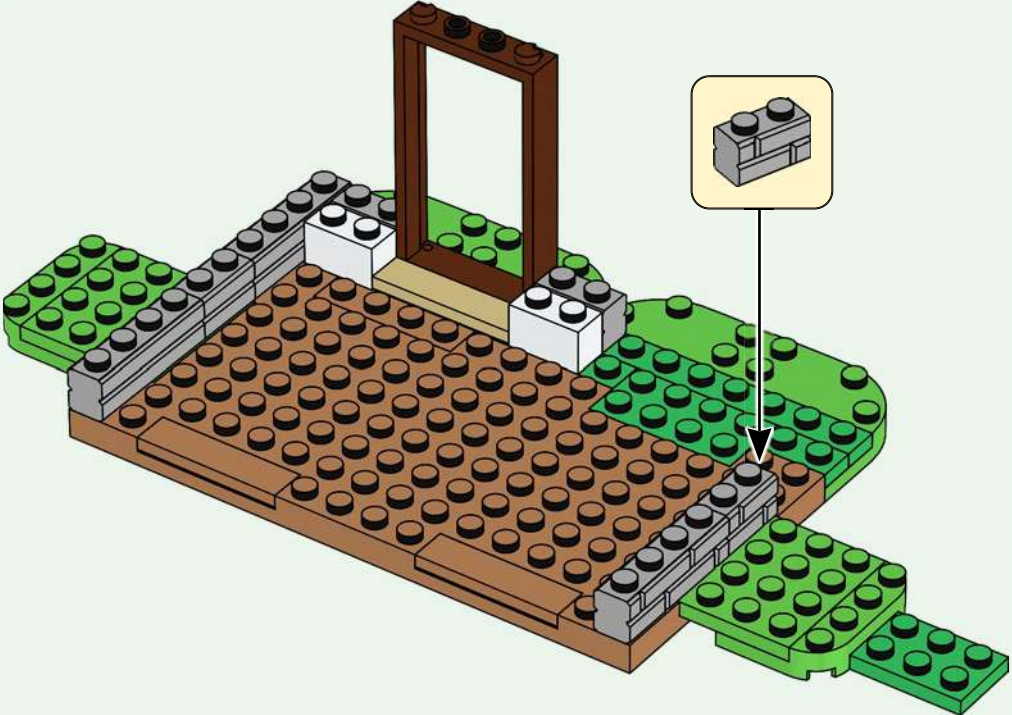



1x



2x

13

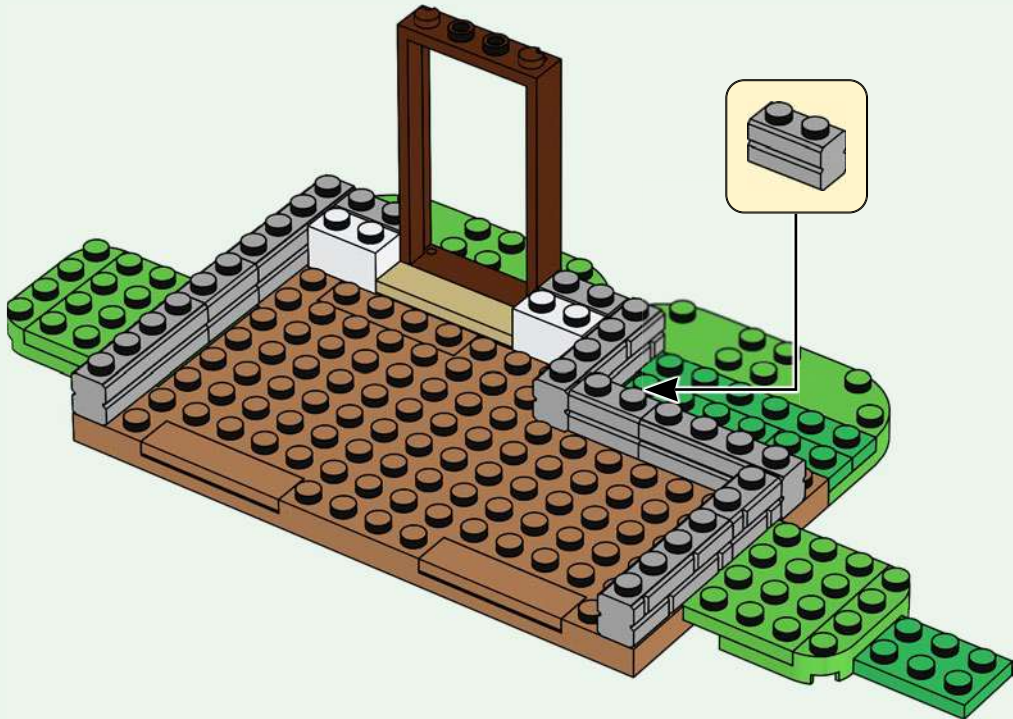



1x



1x

14

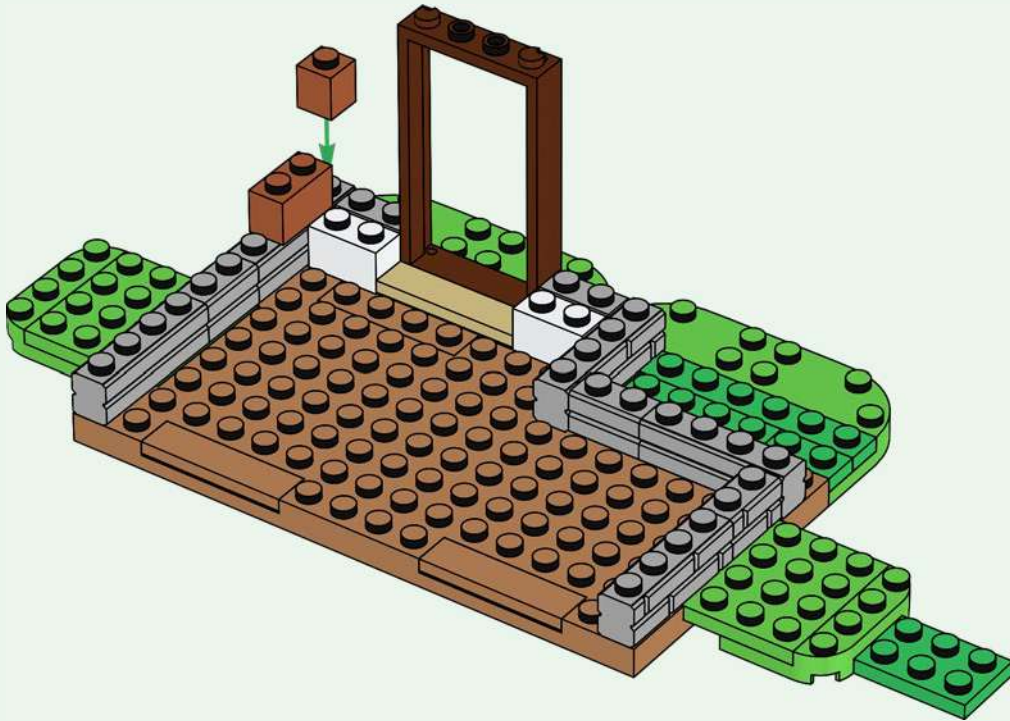





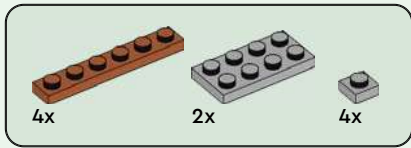

16

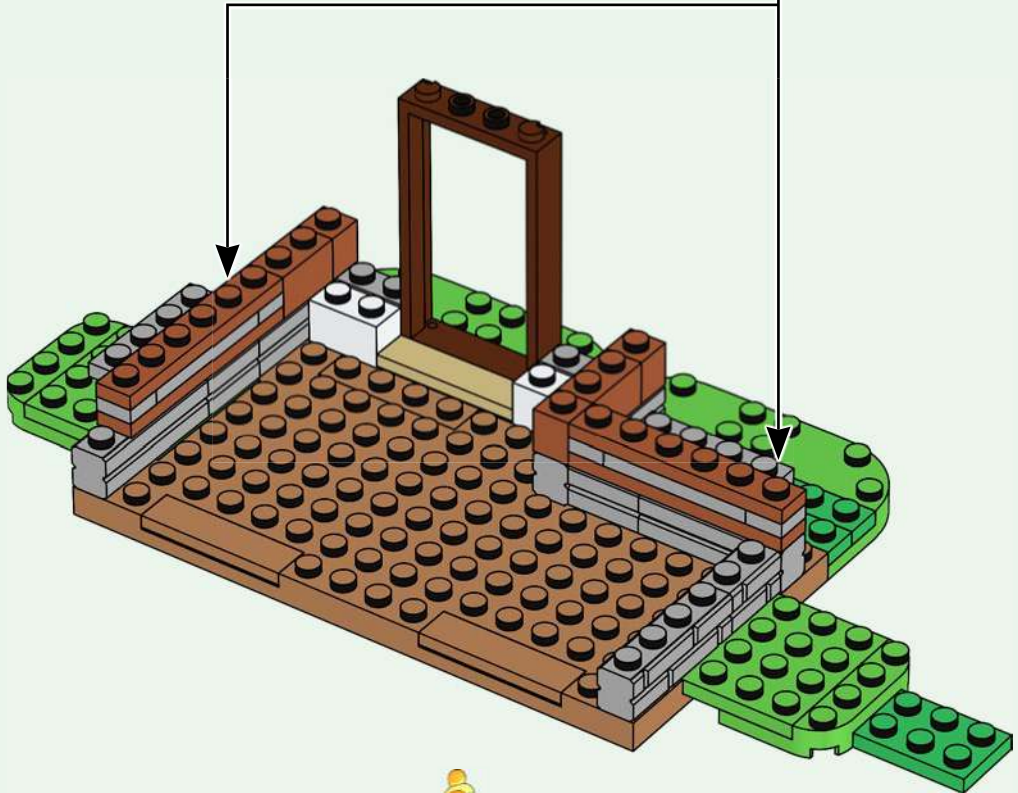
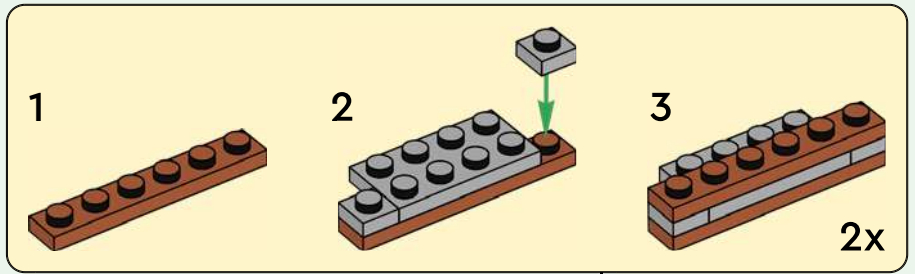



2x



1x

17

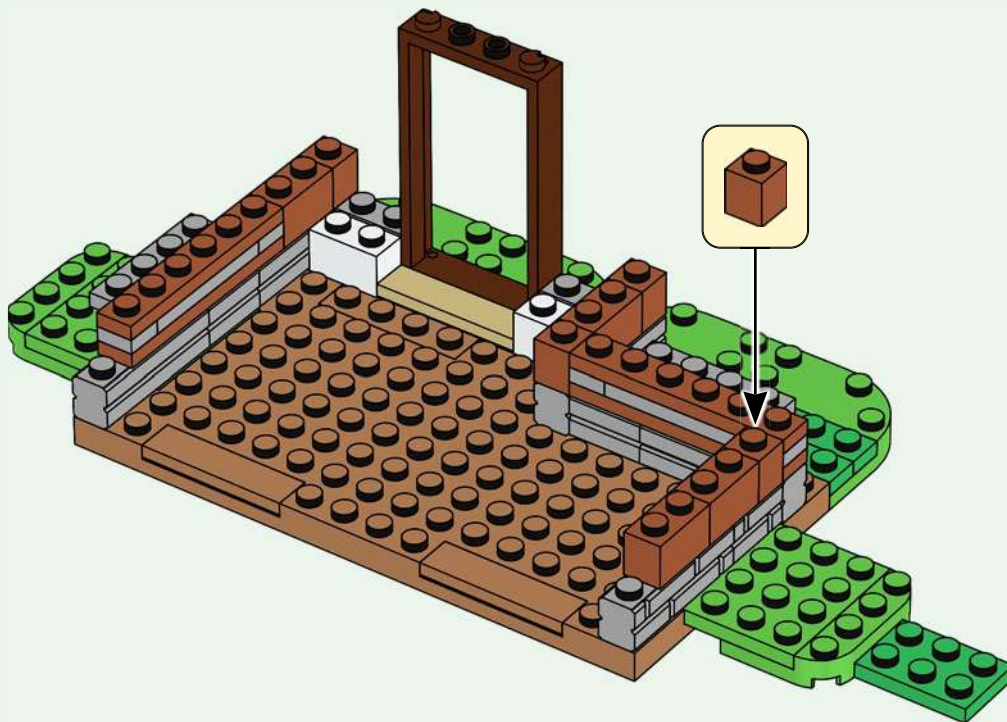



2x

18

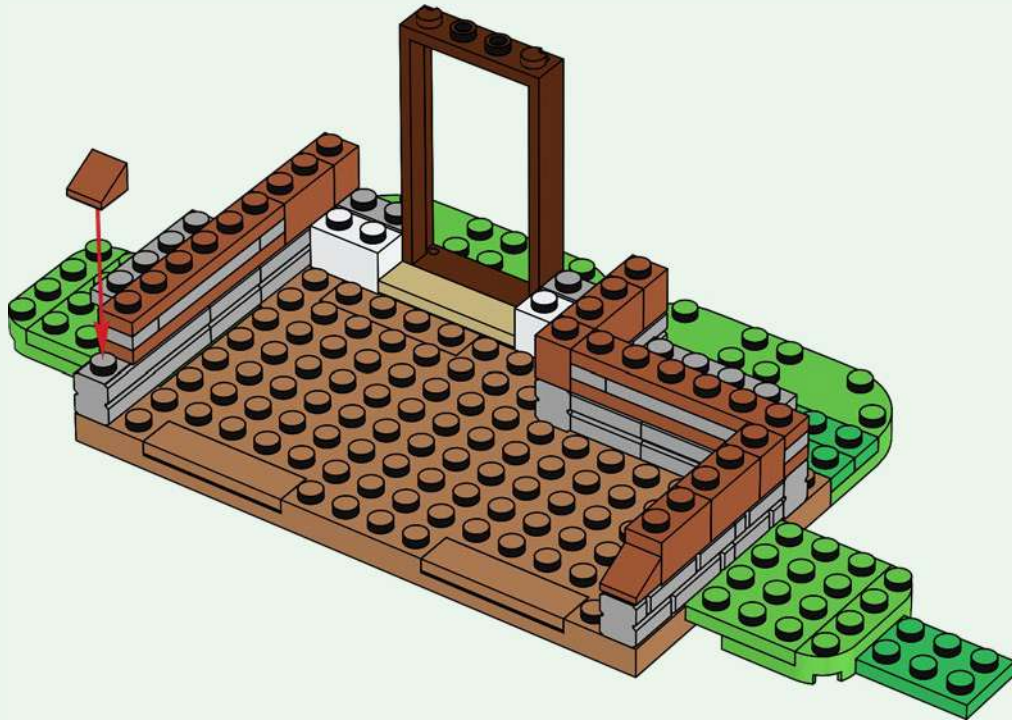

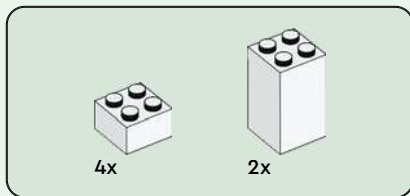

19

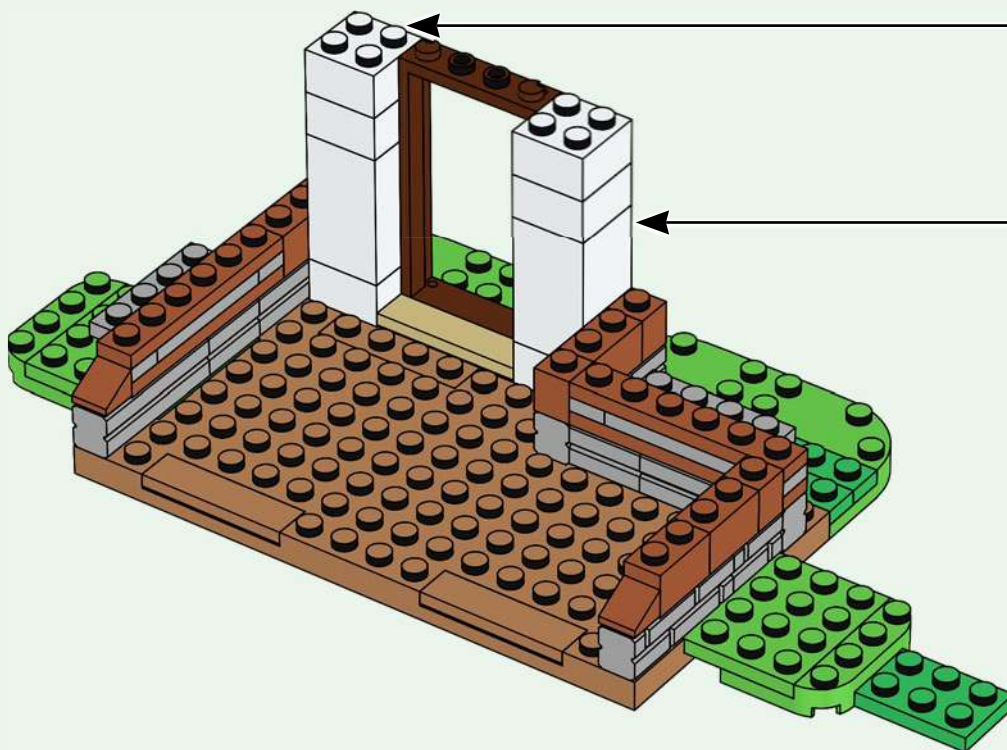
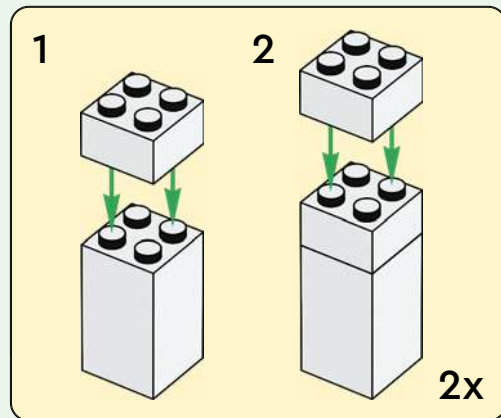

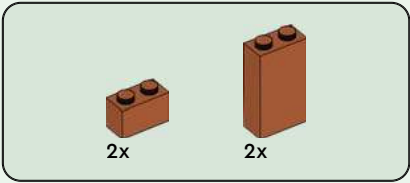

20

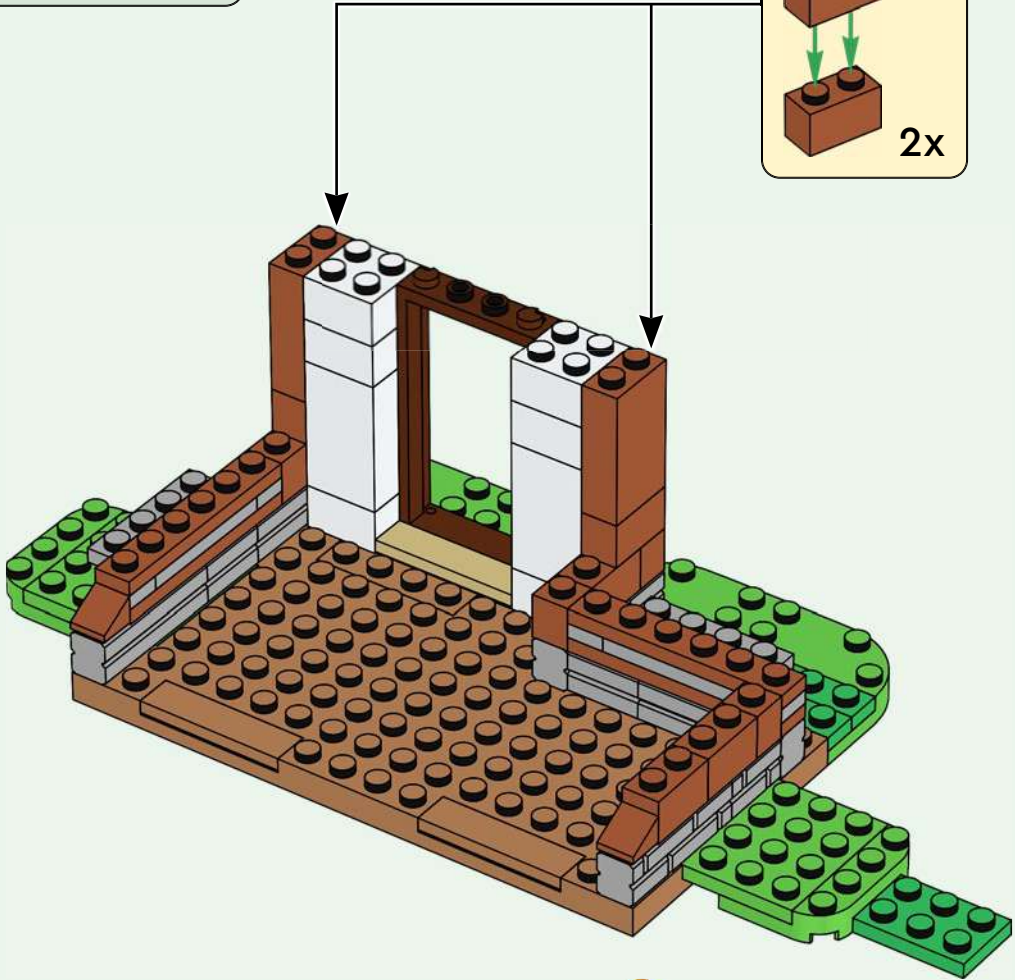
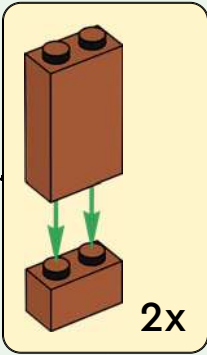



1x

21

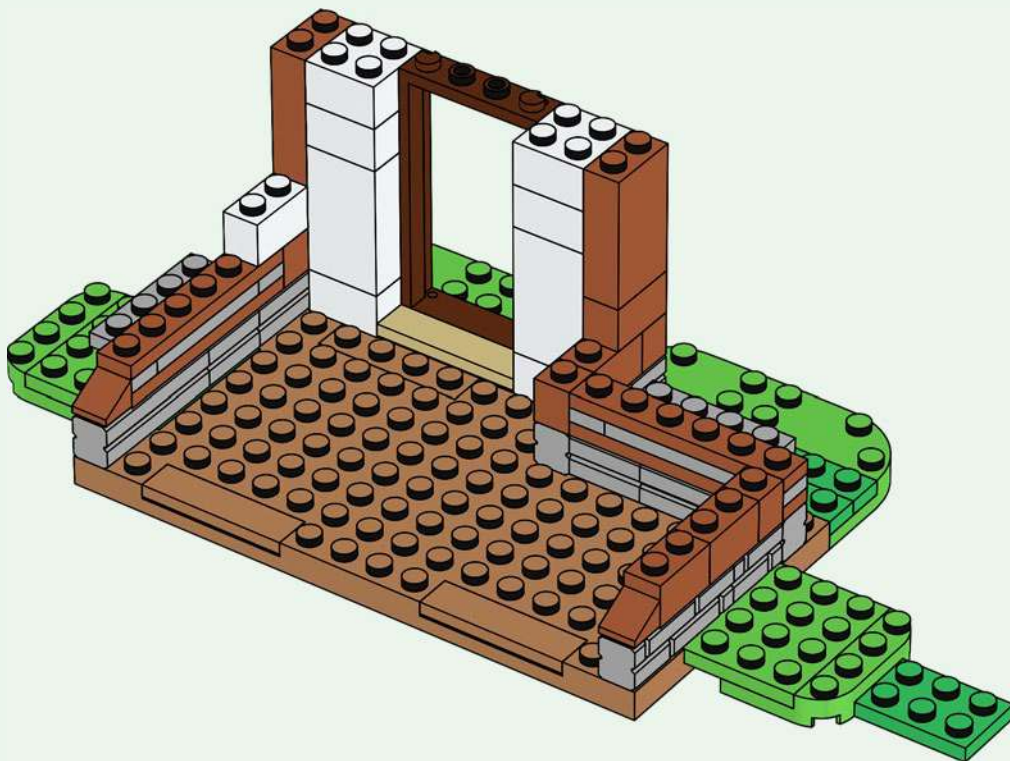



22

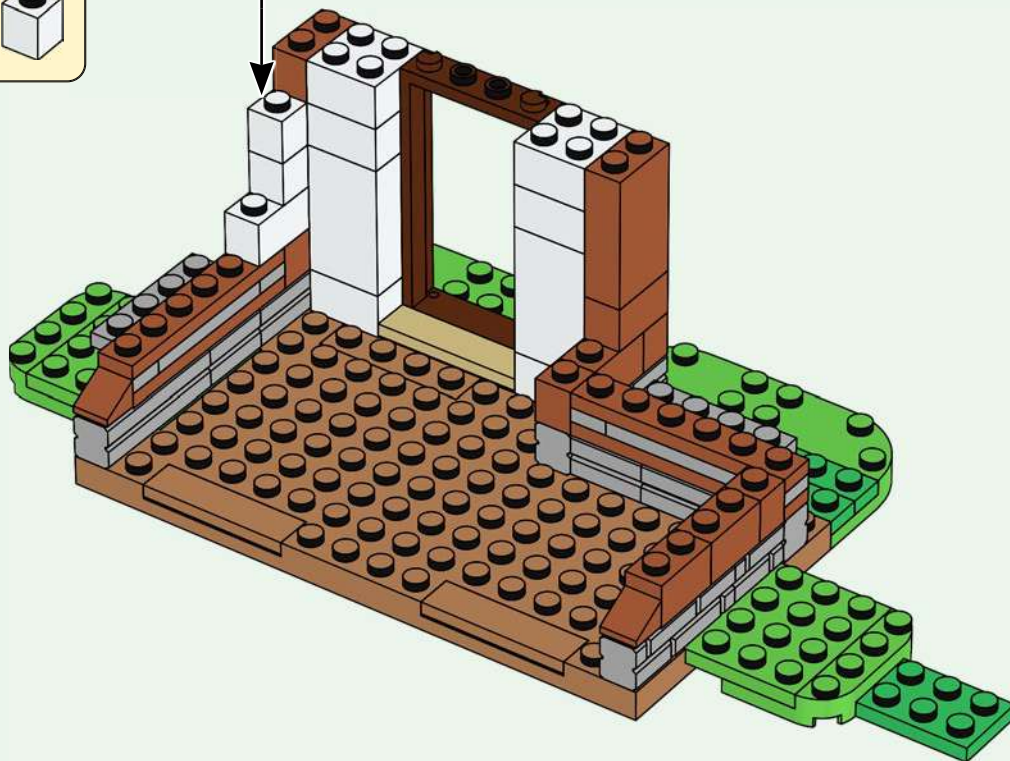
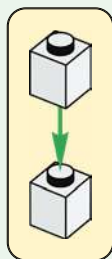





23



2x

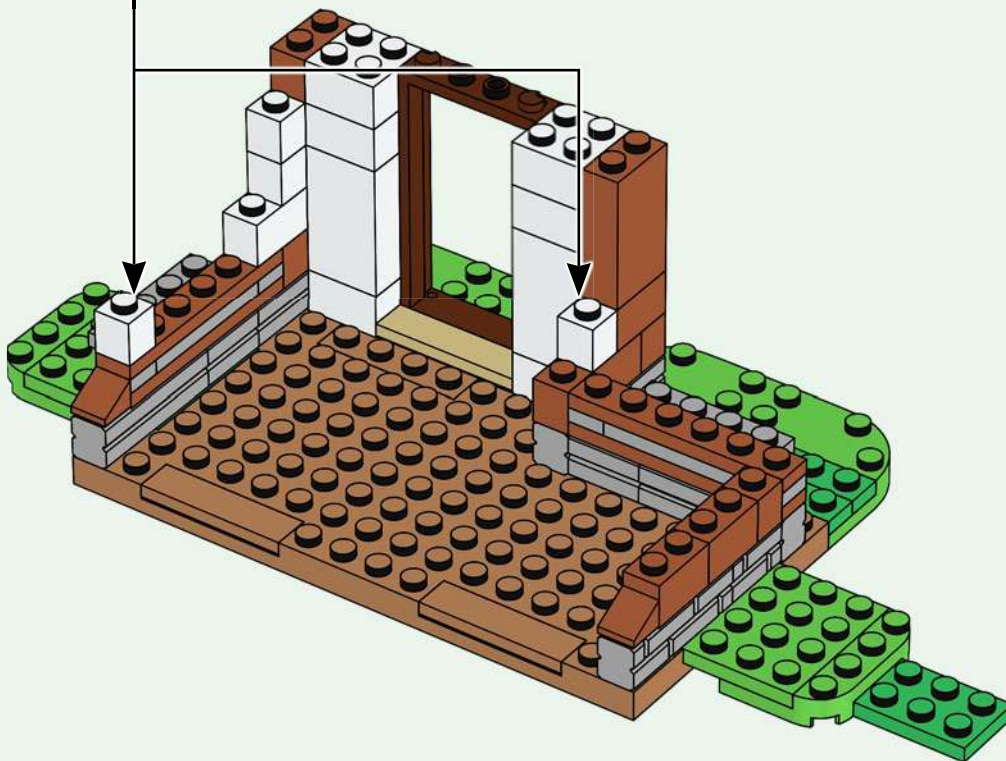

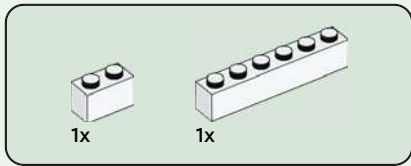

24

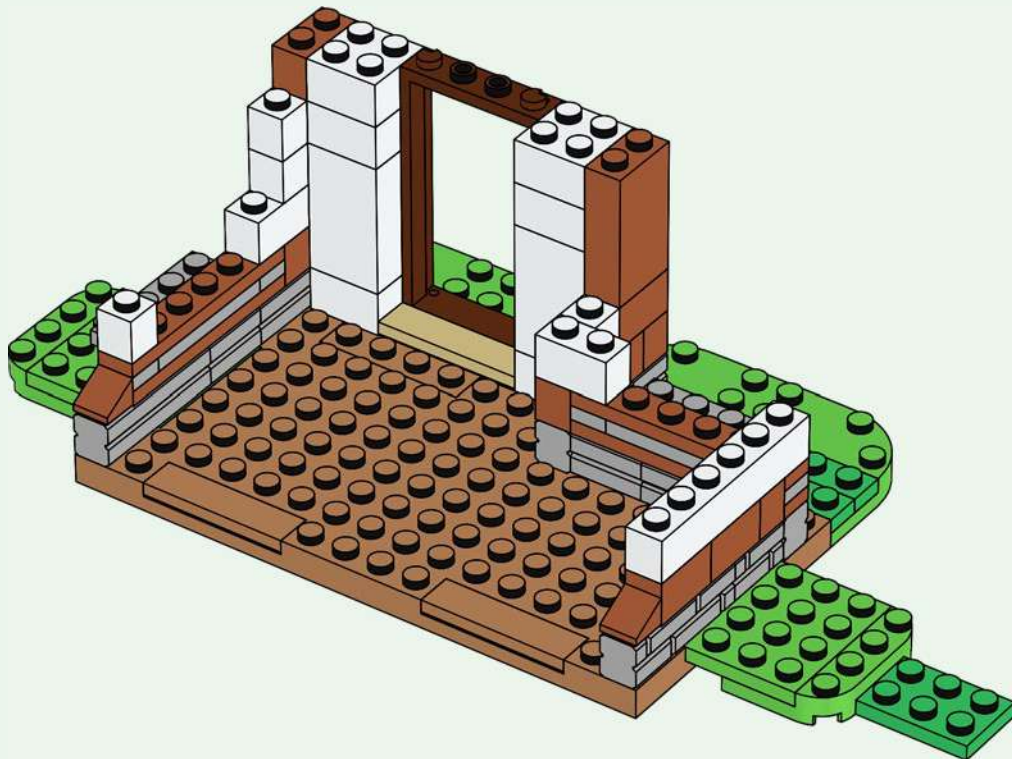



2x

25

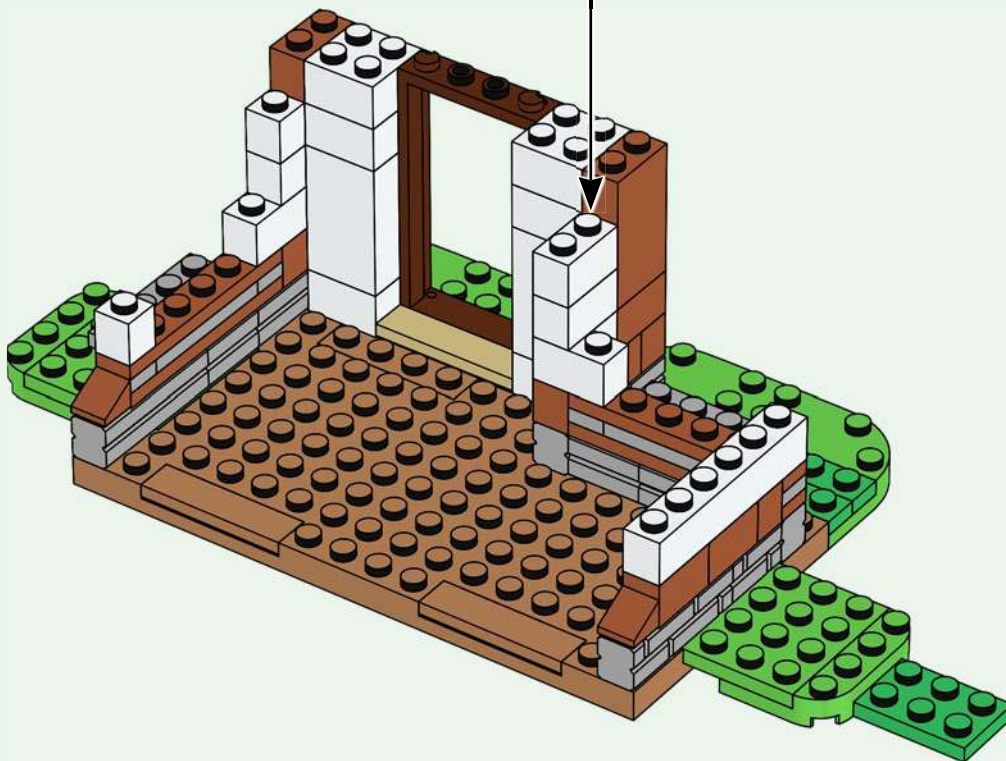
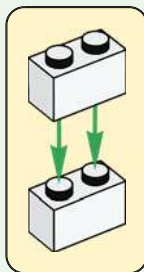

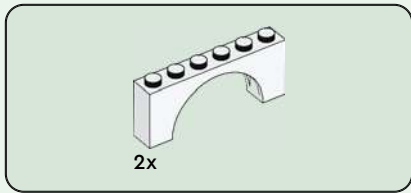

26

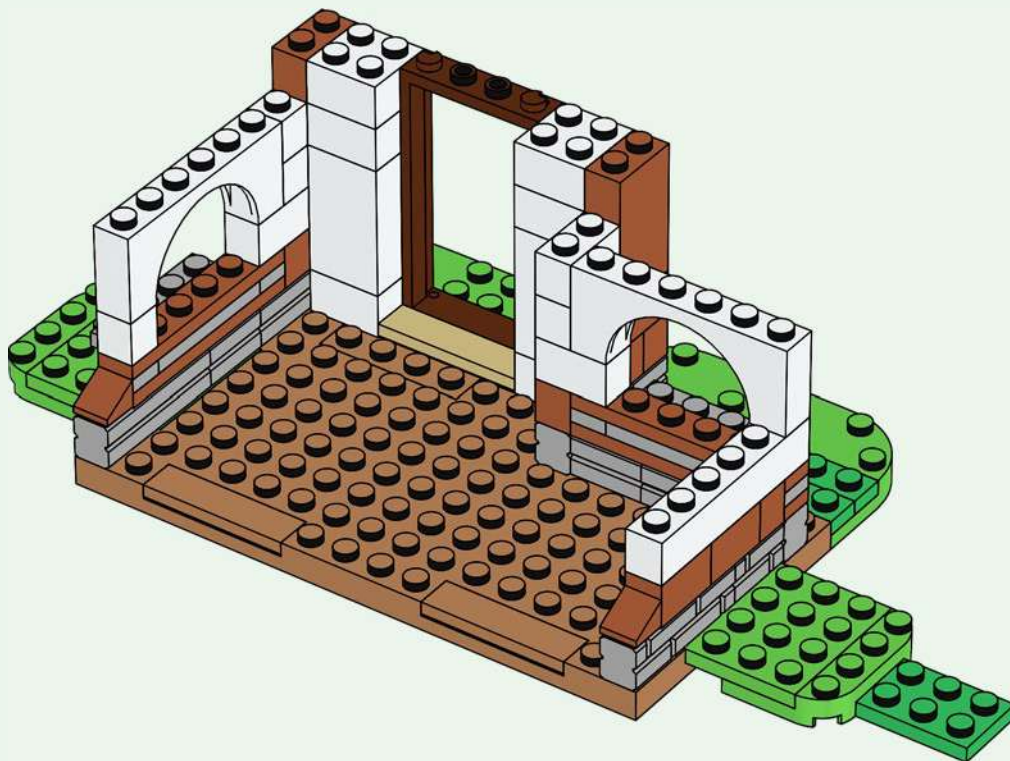



2x



1x

27

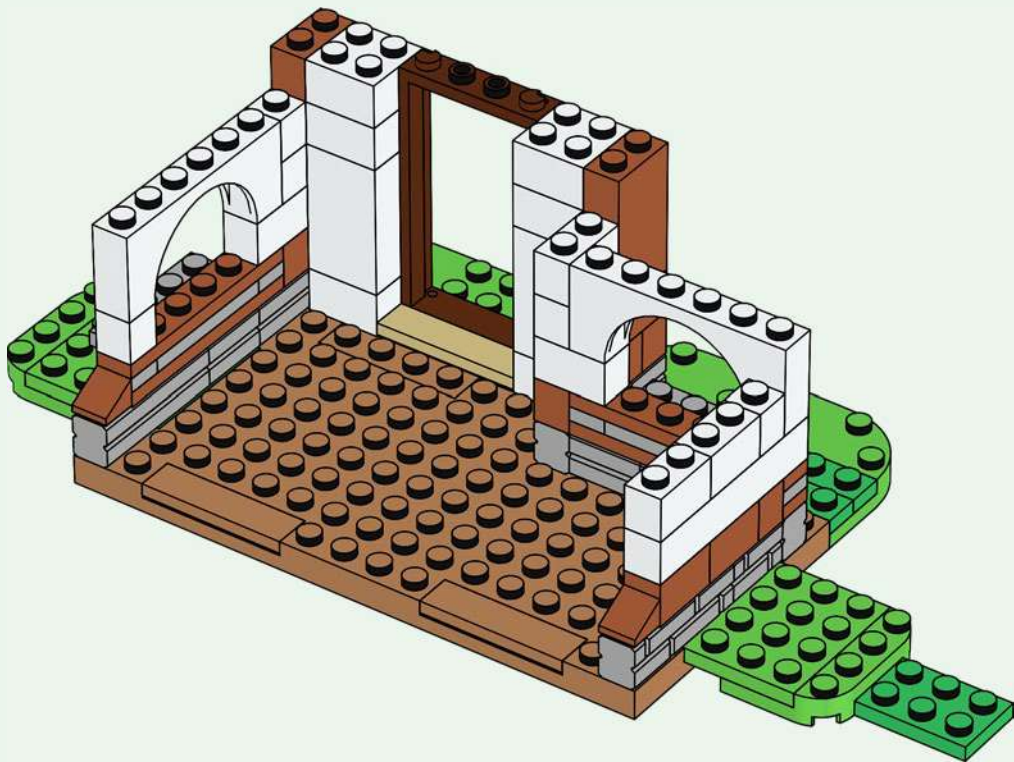

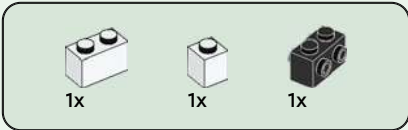

28

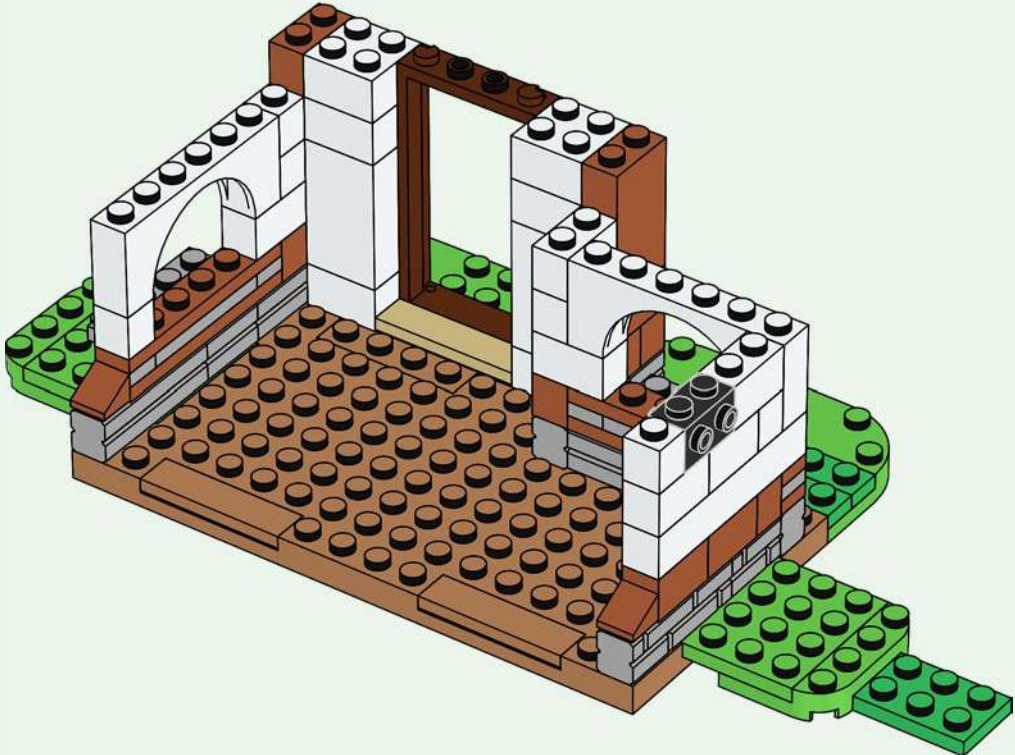

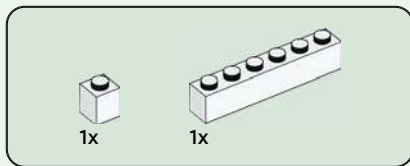

29

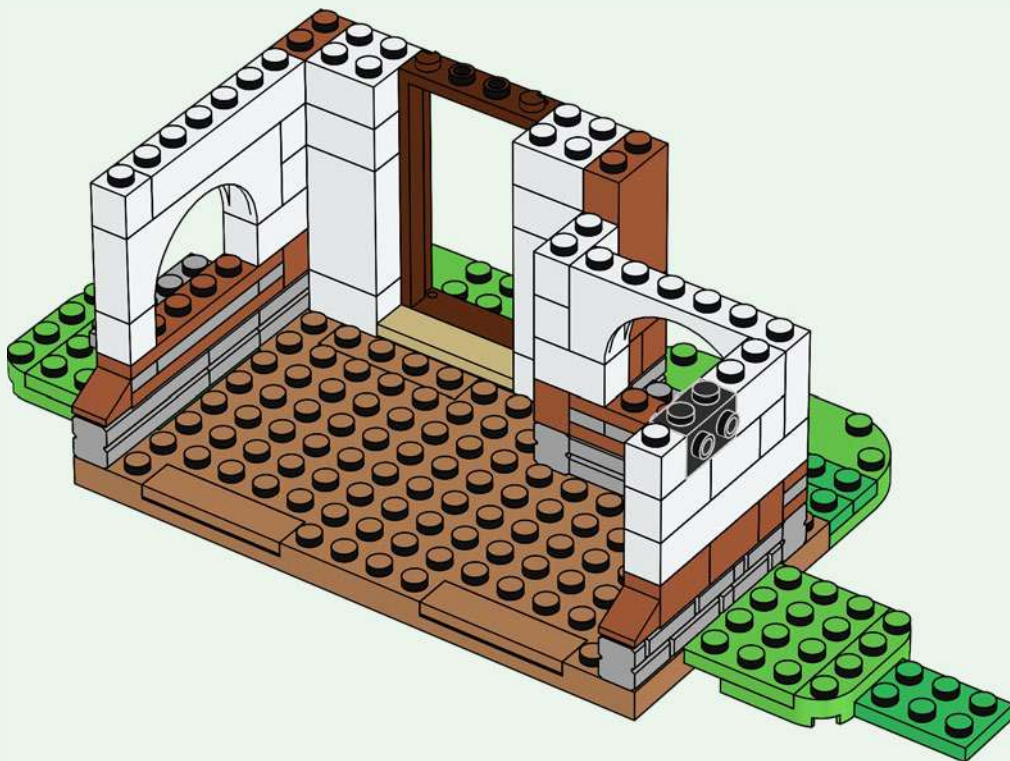

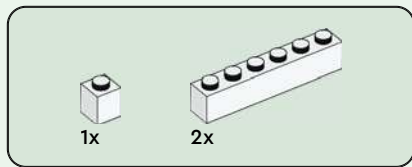

30

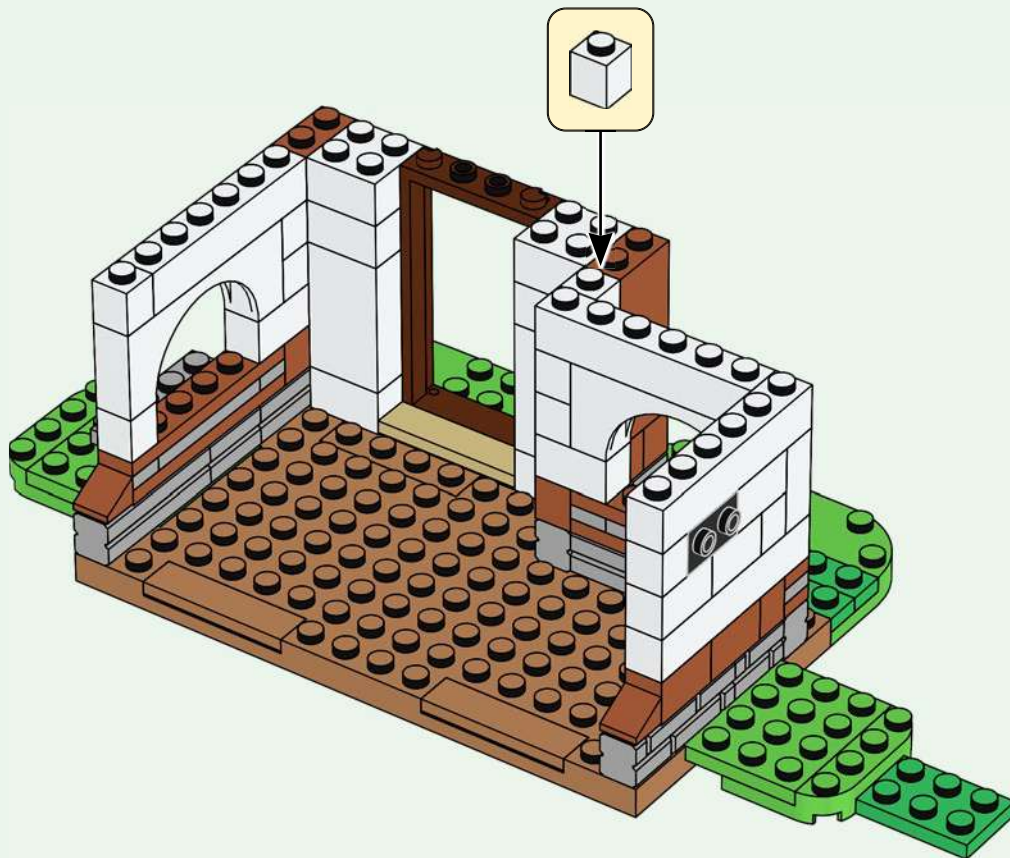





31

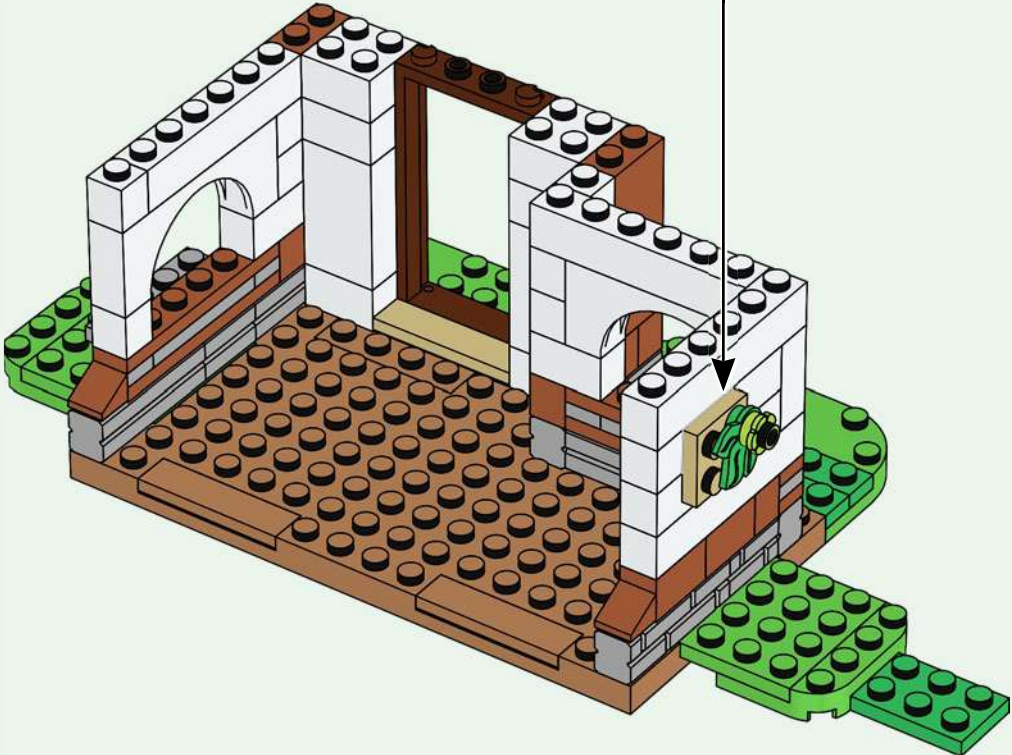
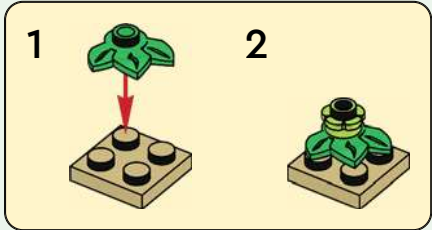



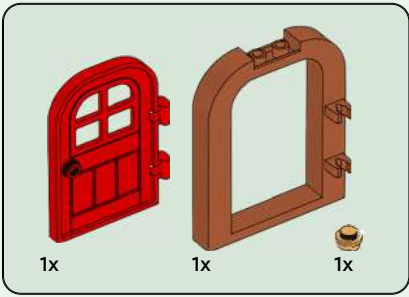

32

1

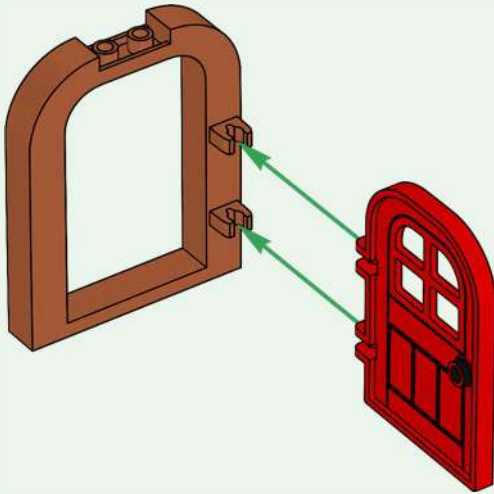

2



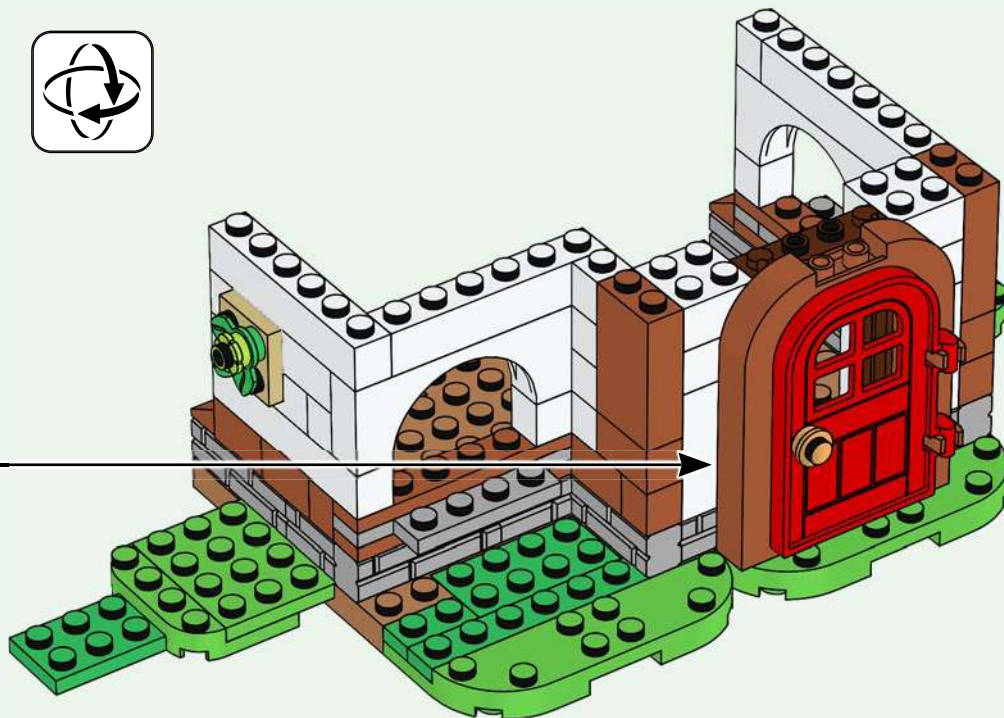
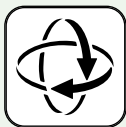



1x



2x

# 33



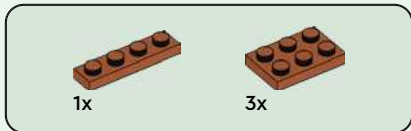

34

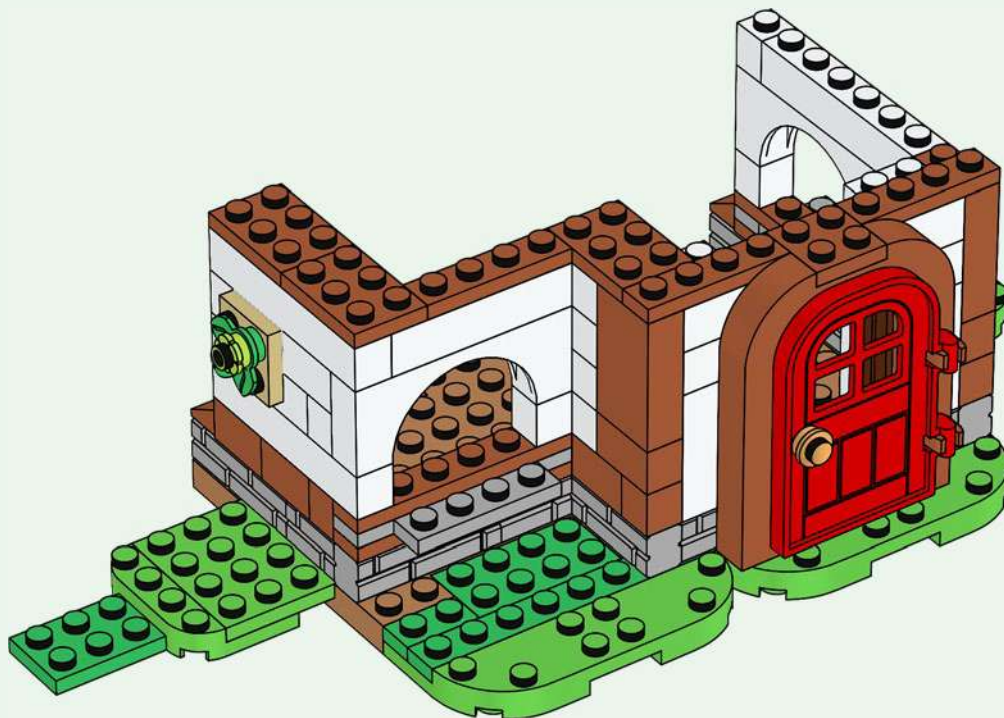



1x



2x

35





2x

36

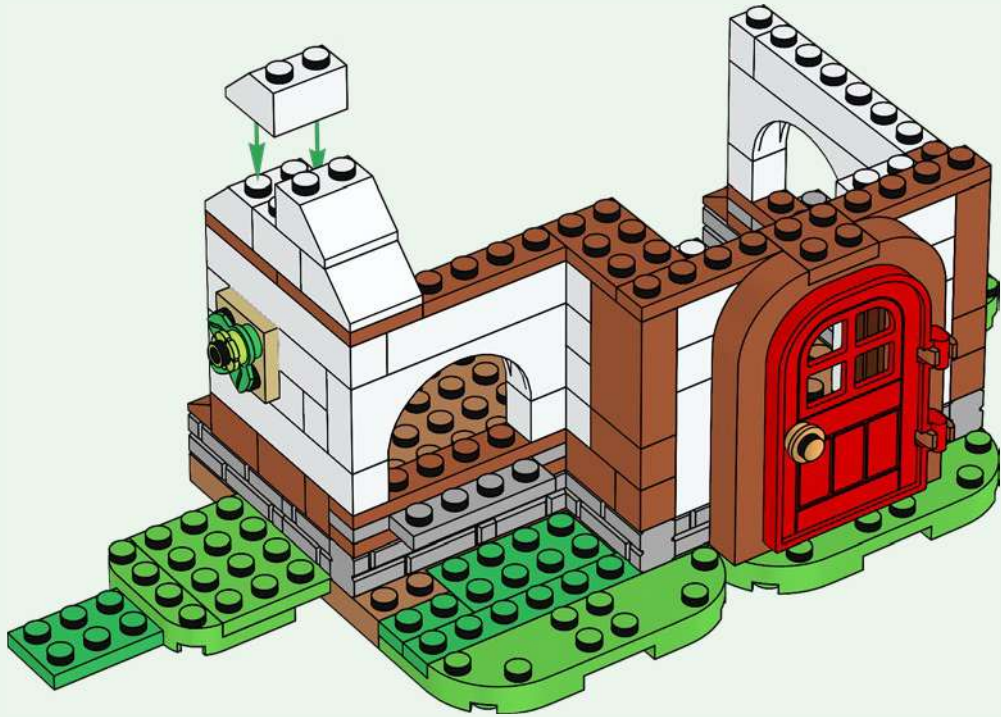





2x

37

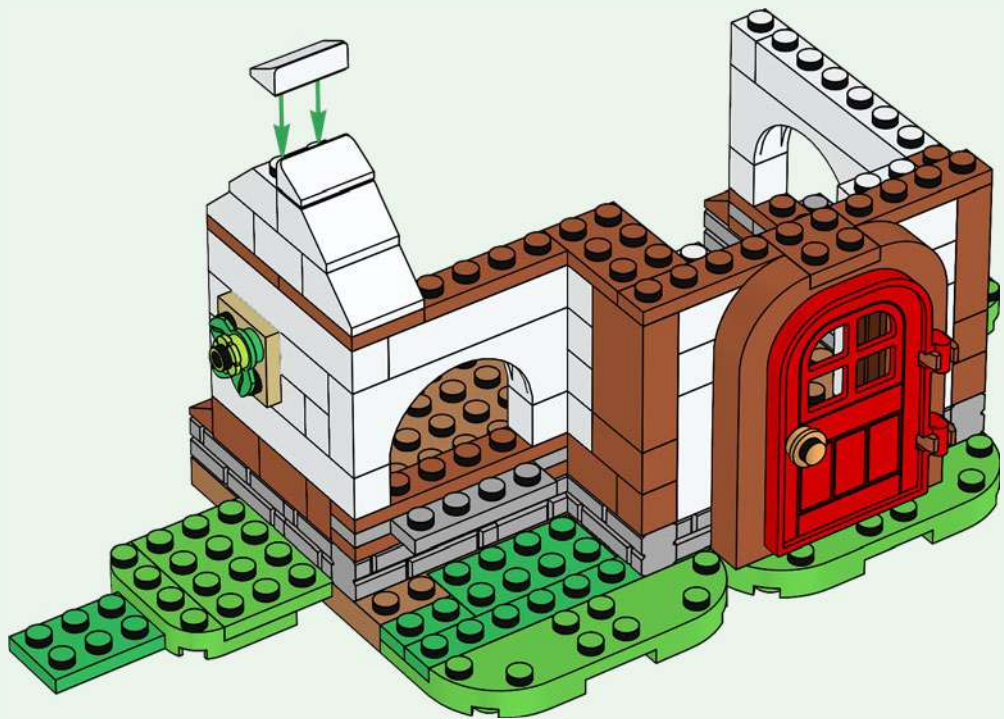

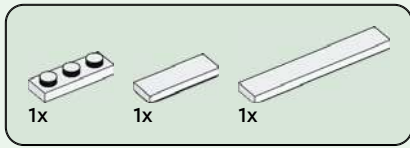

38

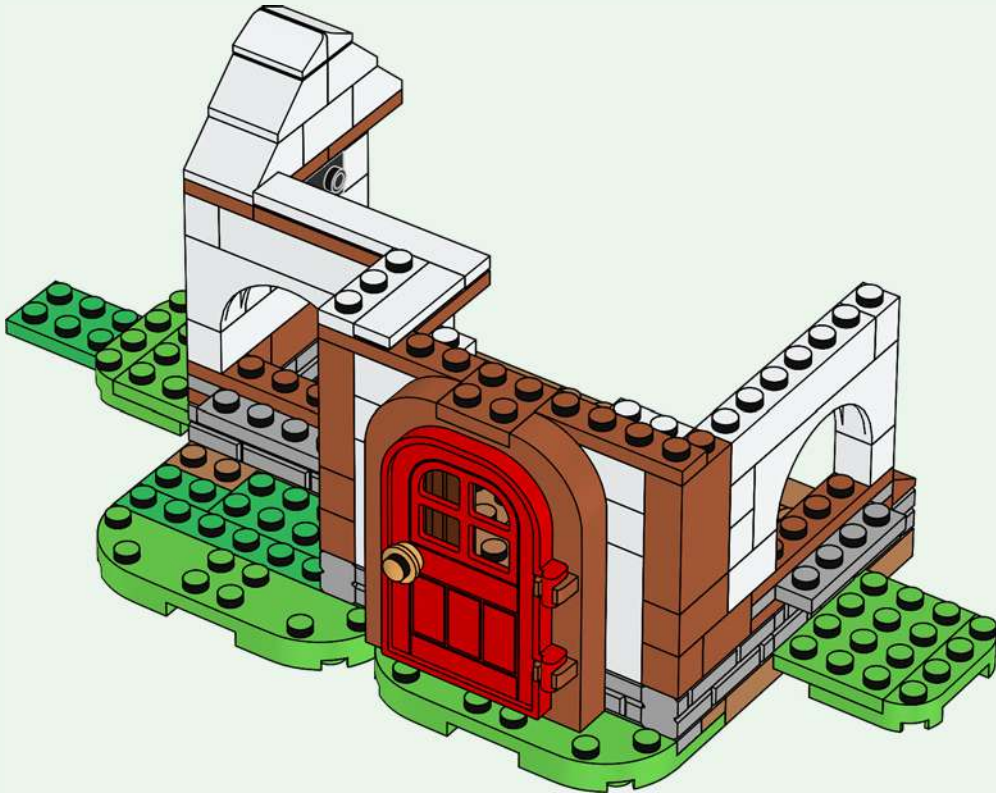

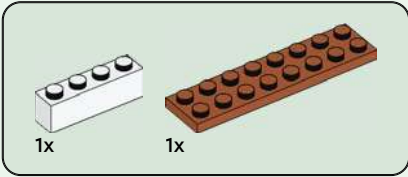
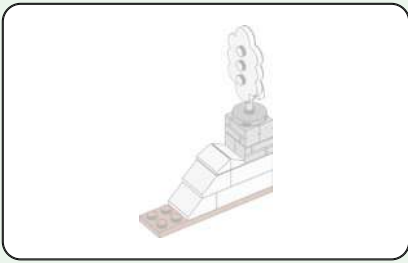

39

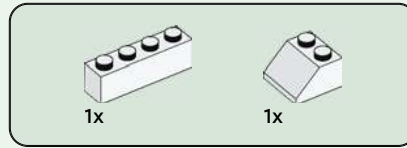
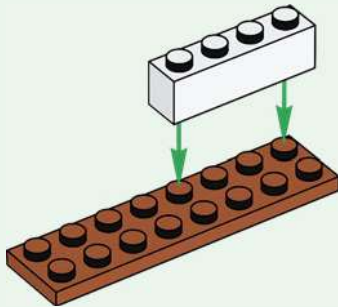

40

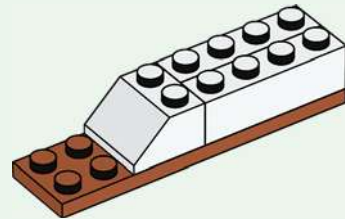



1x



1x

41

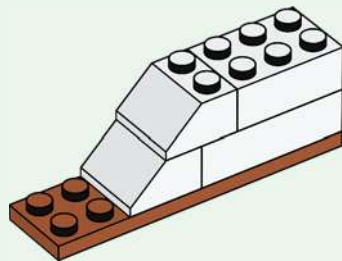



2x

42

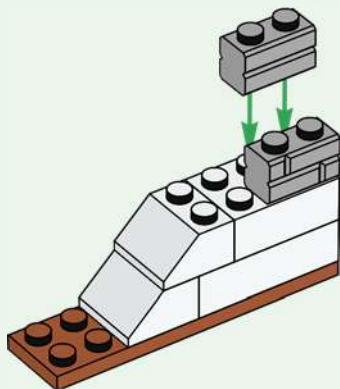

2x

43

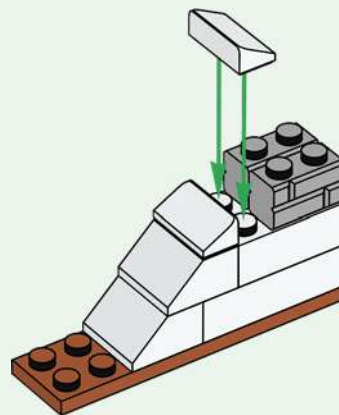



2x

44

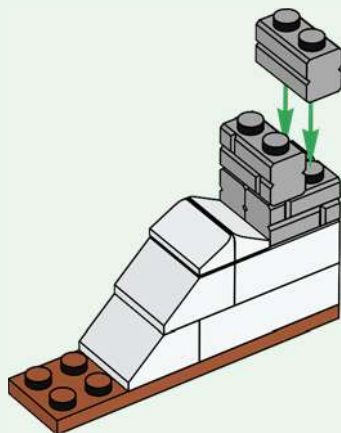

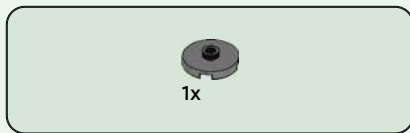

45

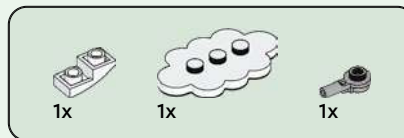
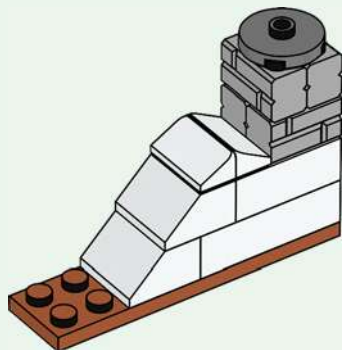

46

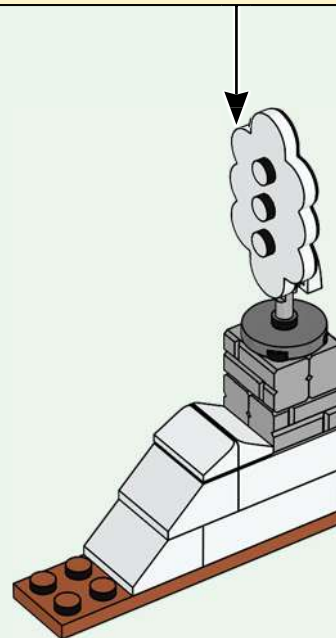
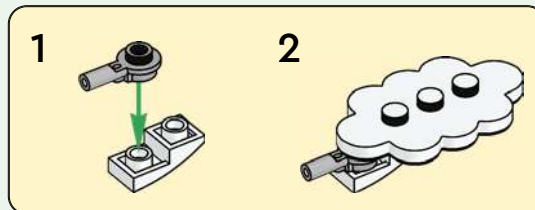

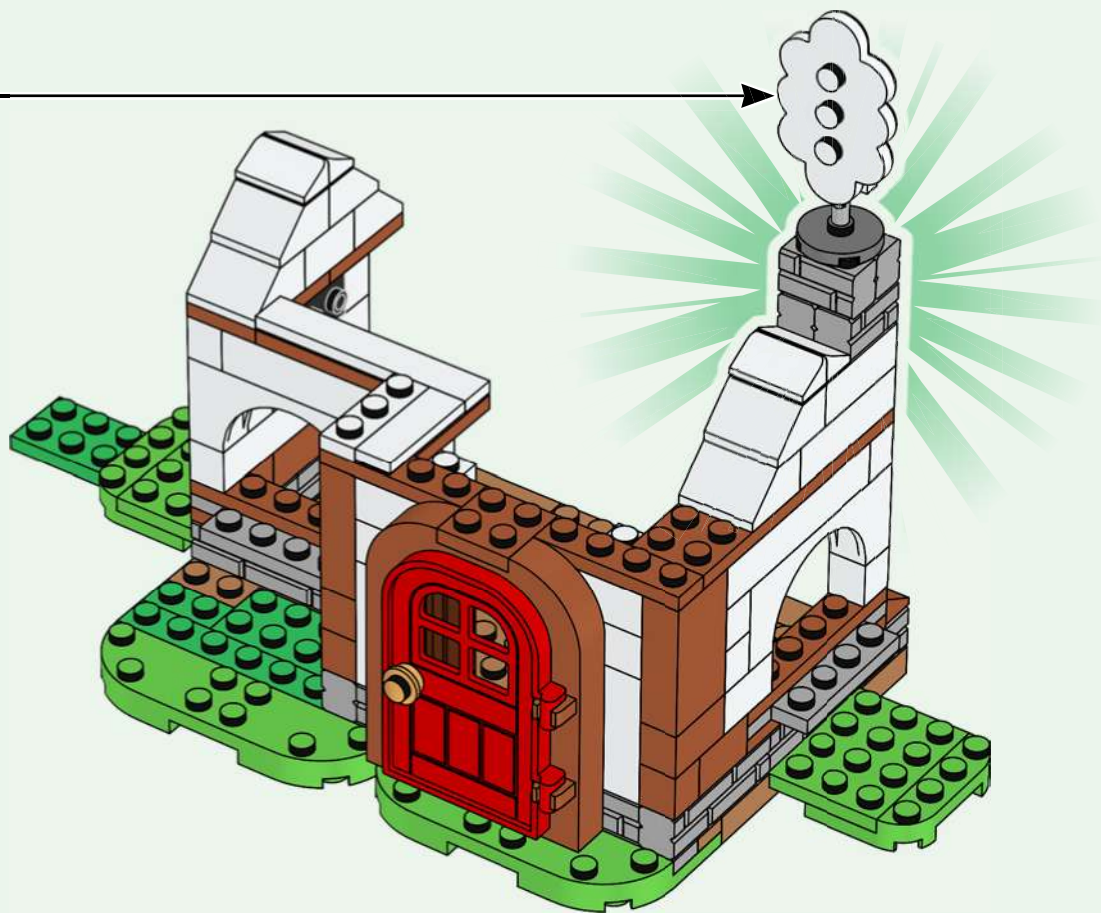



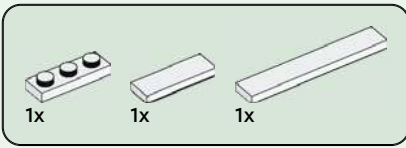

48



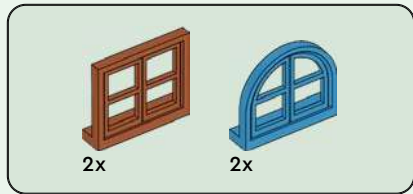

49

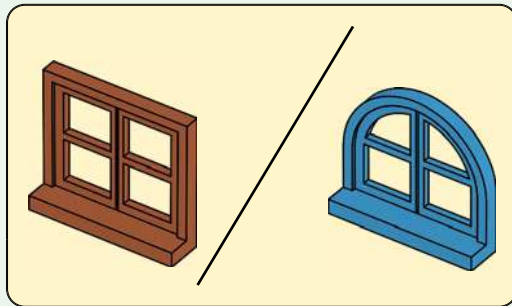

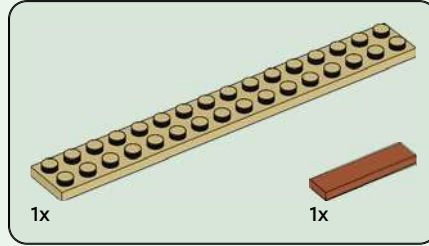
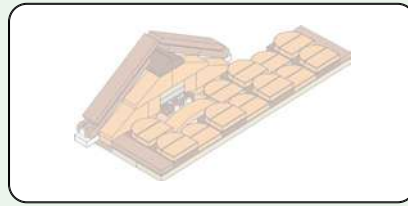

50

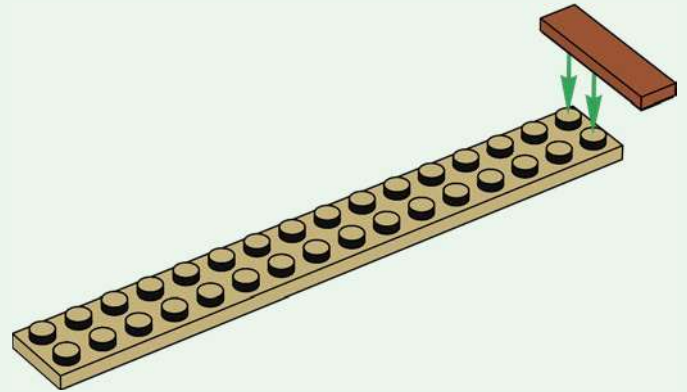

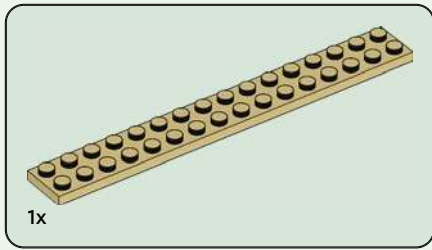

51

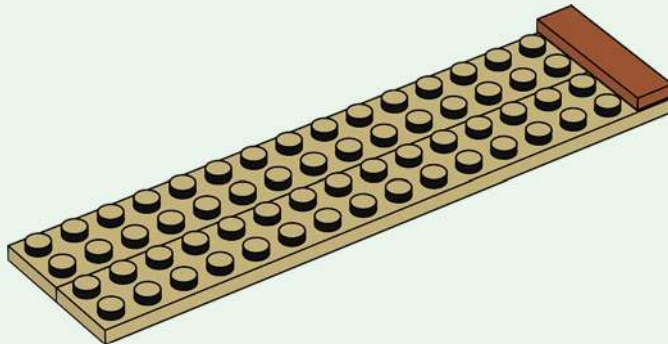

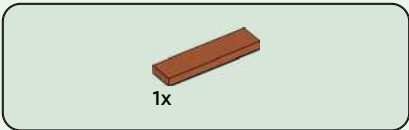

52

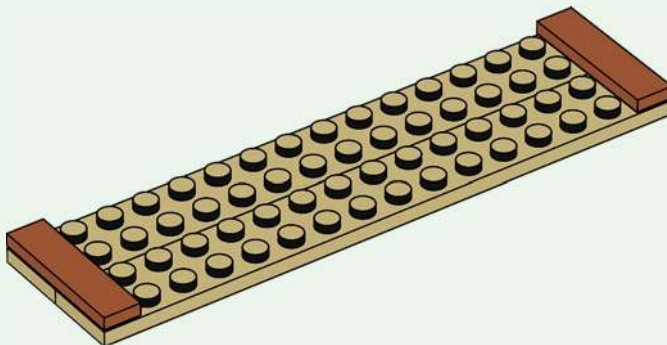

53

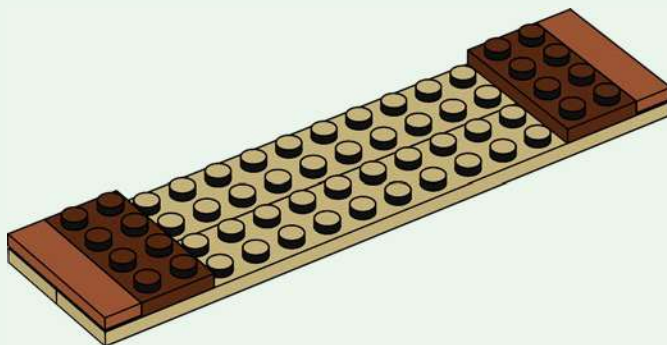

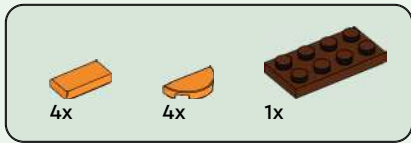

54

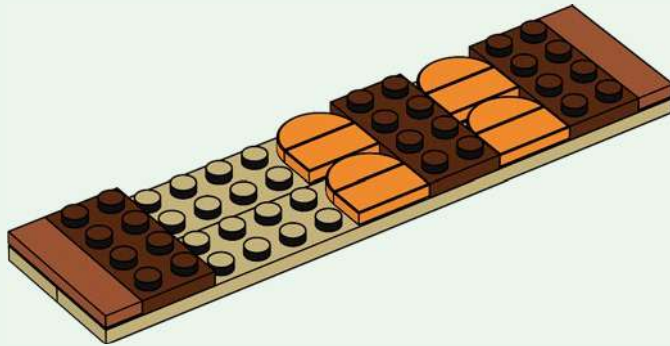



2x



2x

# 55

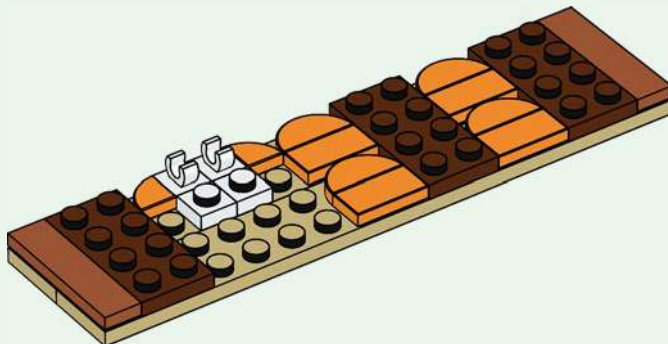

1x

# 56

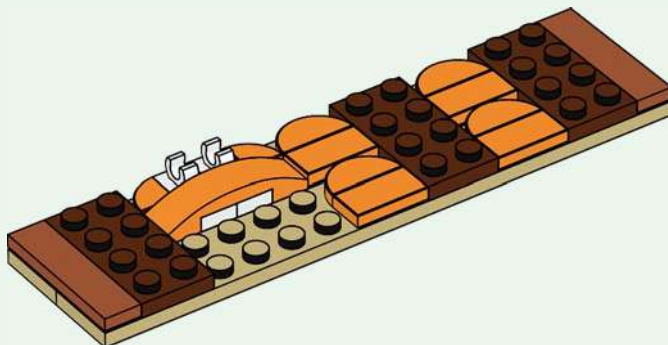



57

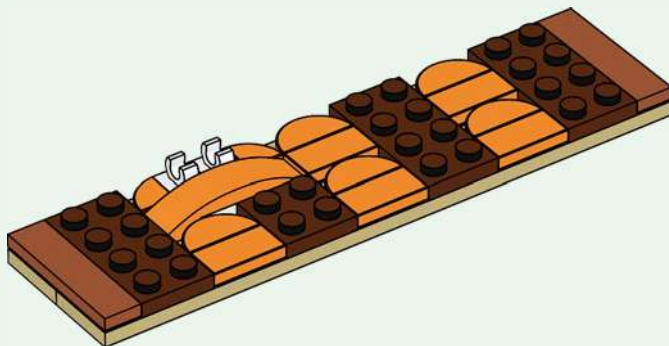





58

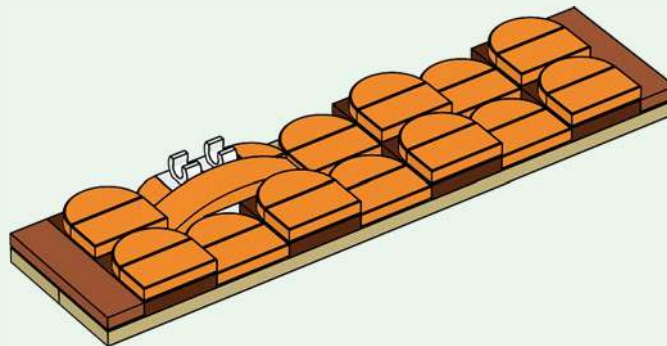

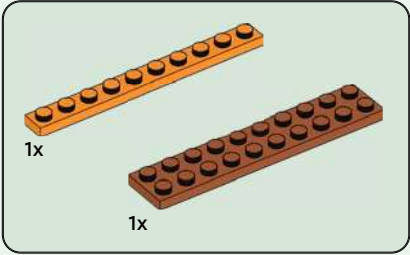
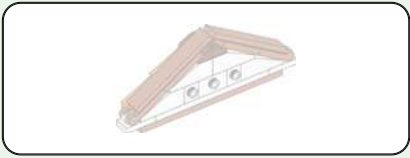

59

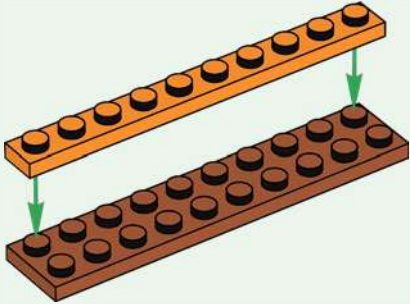

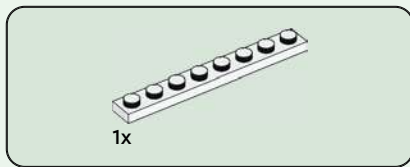

60

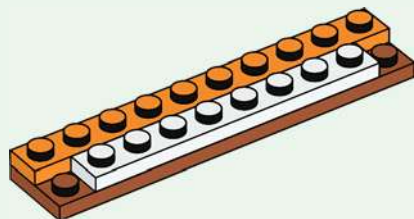

61

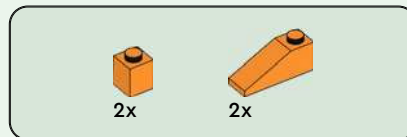
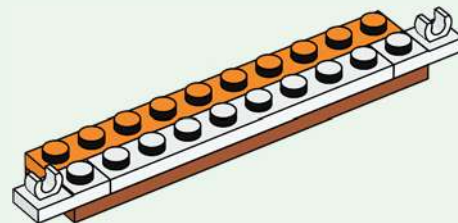

62

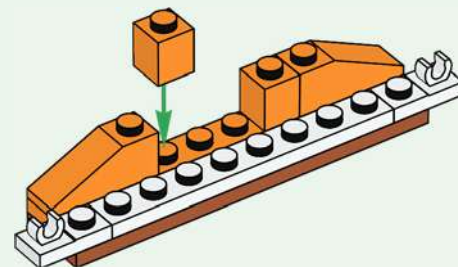

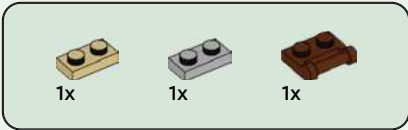

# 63

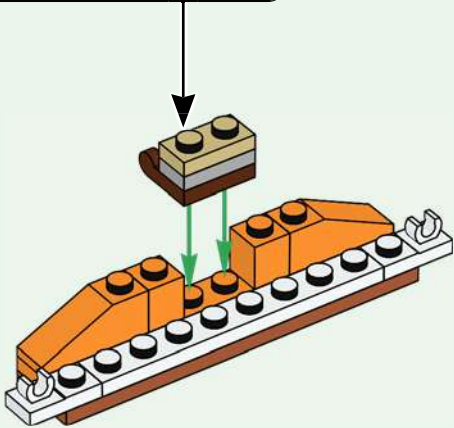
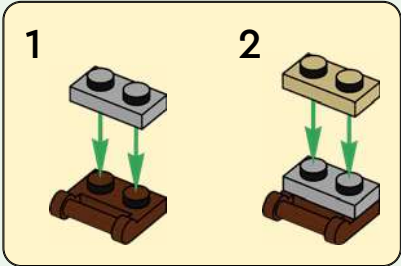



1x

64

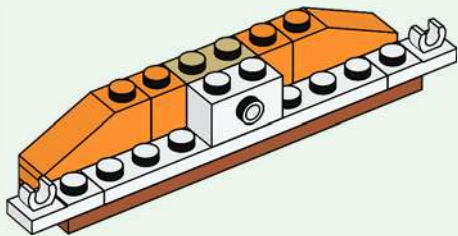

2x



2x

65

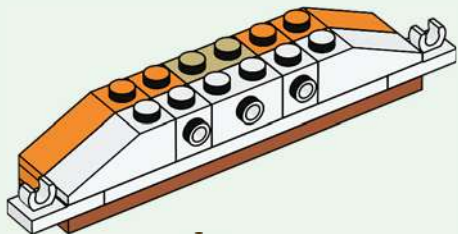

2x



2x

66

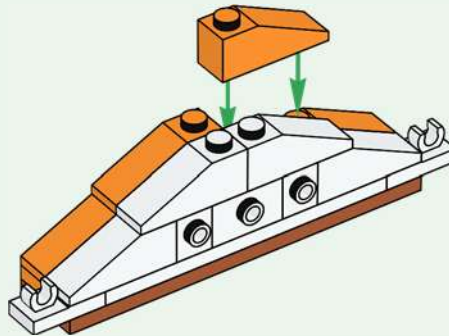

2x

67

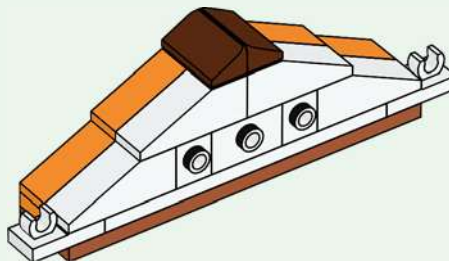

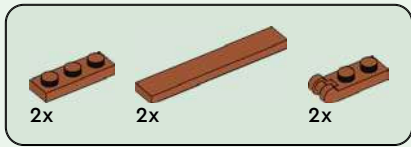

68

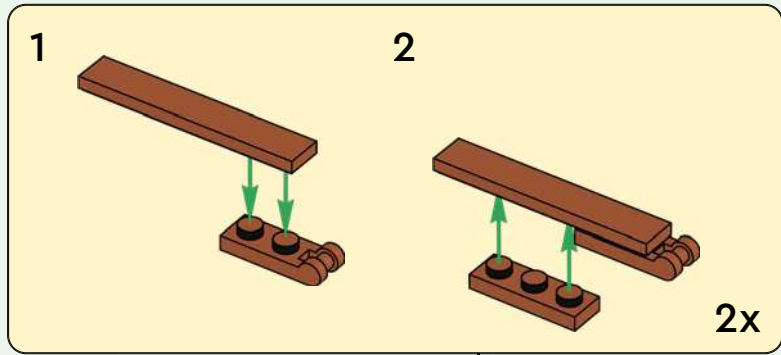

2

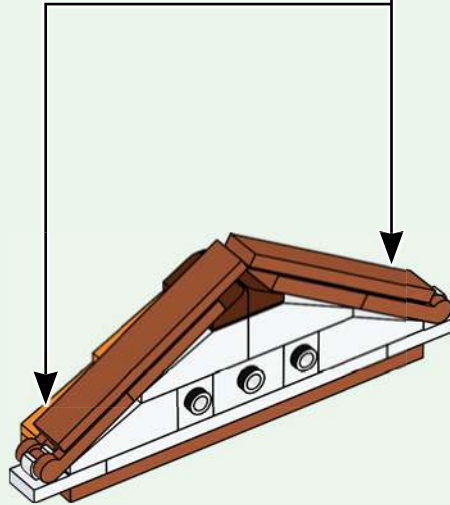
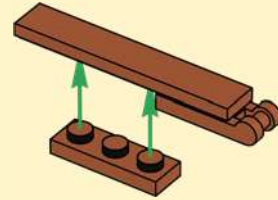

69

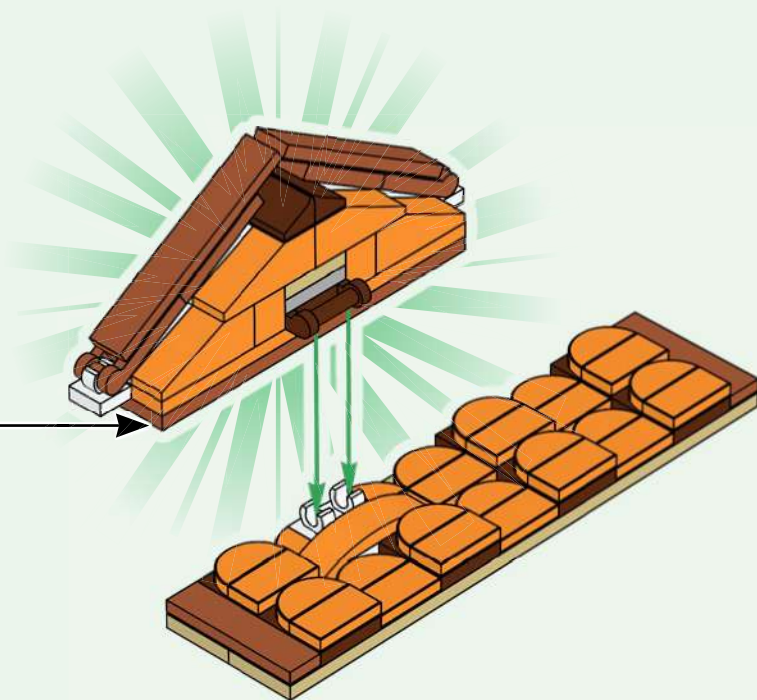

70

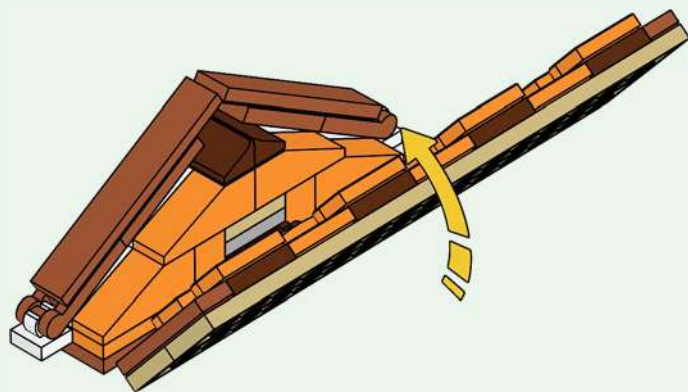

71









2x



1x

72





1x

73

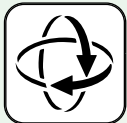

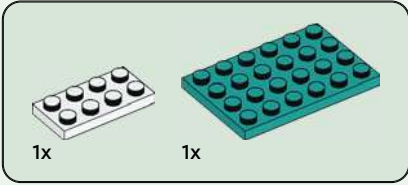
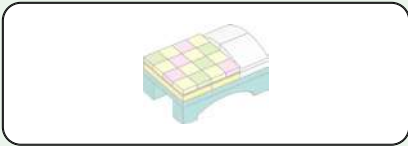

74

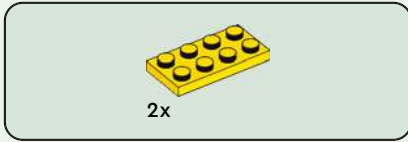
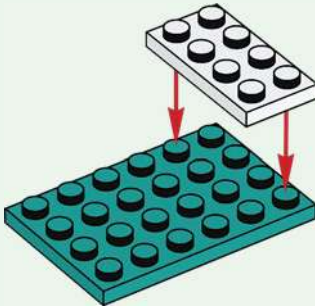

75

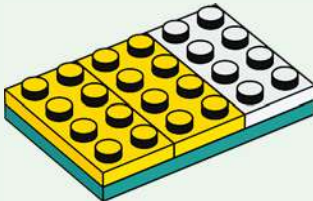



1x

76

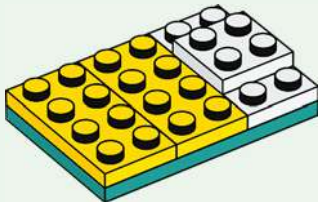

2x

77

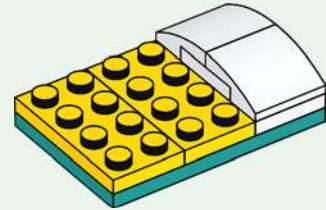

4x



4x



8x

78

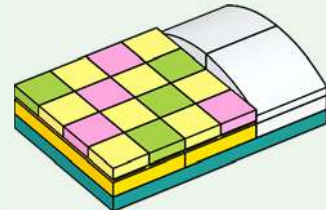

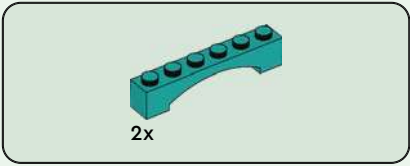

79

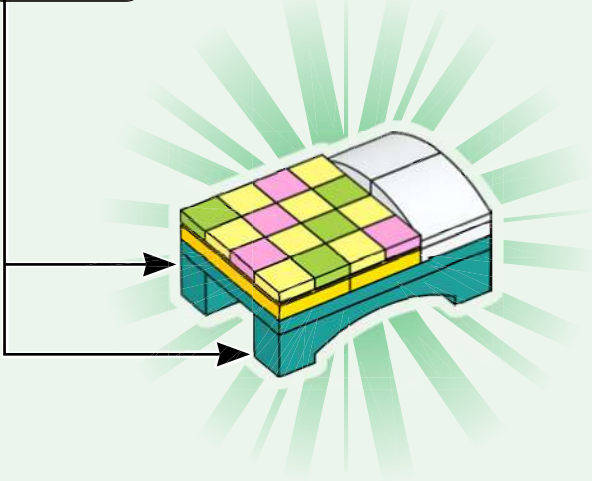
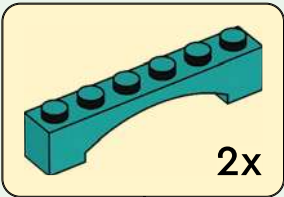

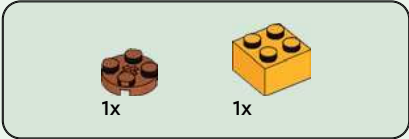

80

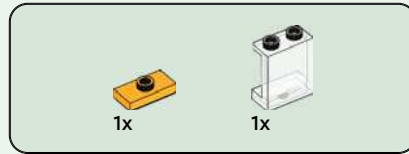
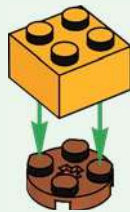

81



82



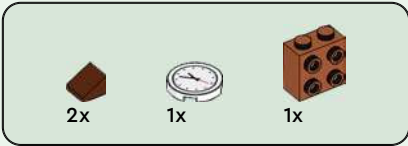

83

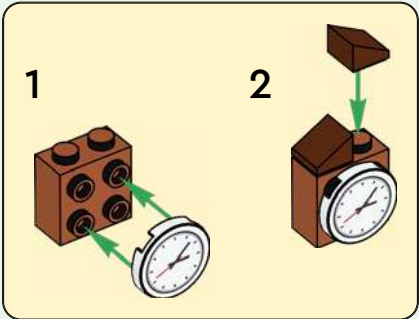





84

1



2



3



4



5



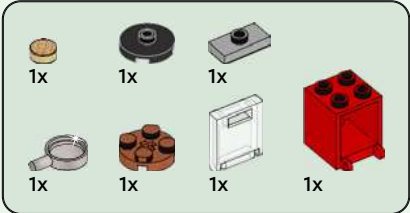

# 85

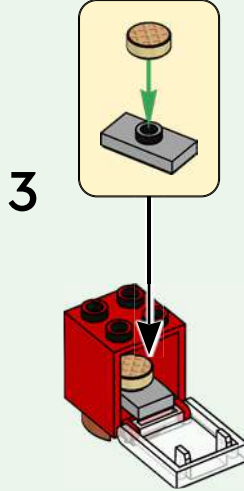
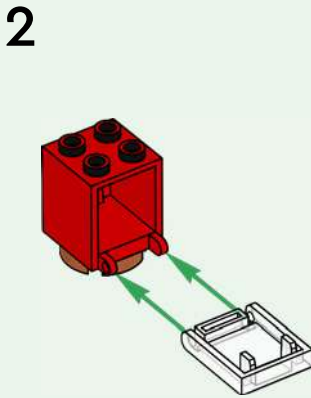
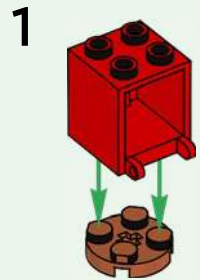

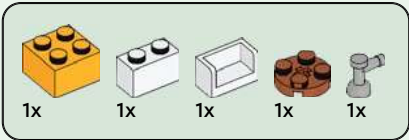

86

1

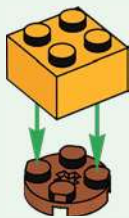

2

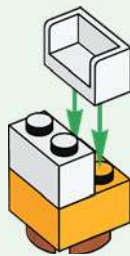

3

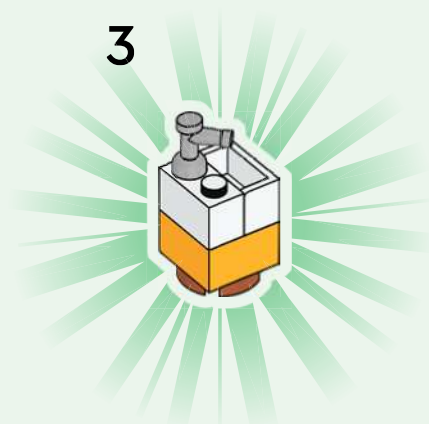

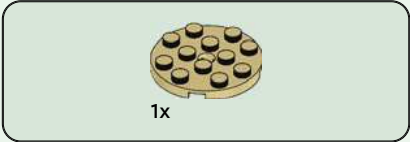

87



88





1x



2x

89



1x

90

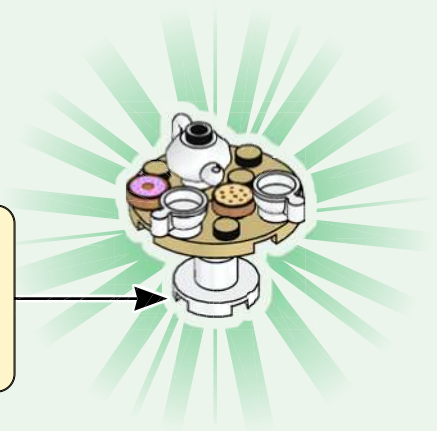



91

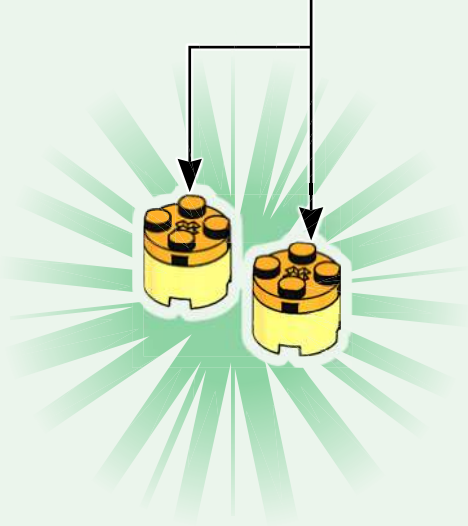
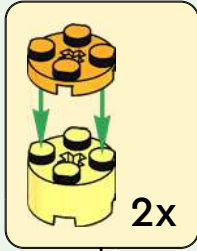

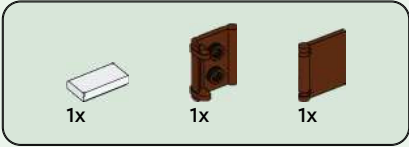

92

1

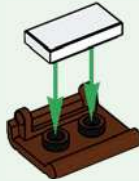

2













3x



3x

93

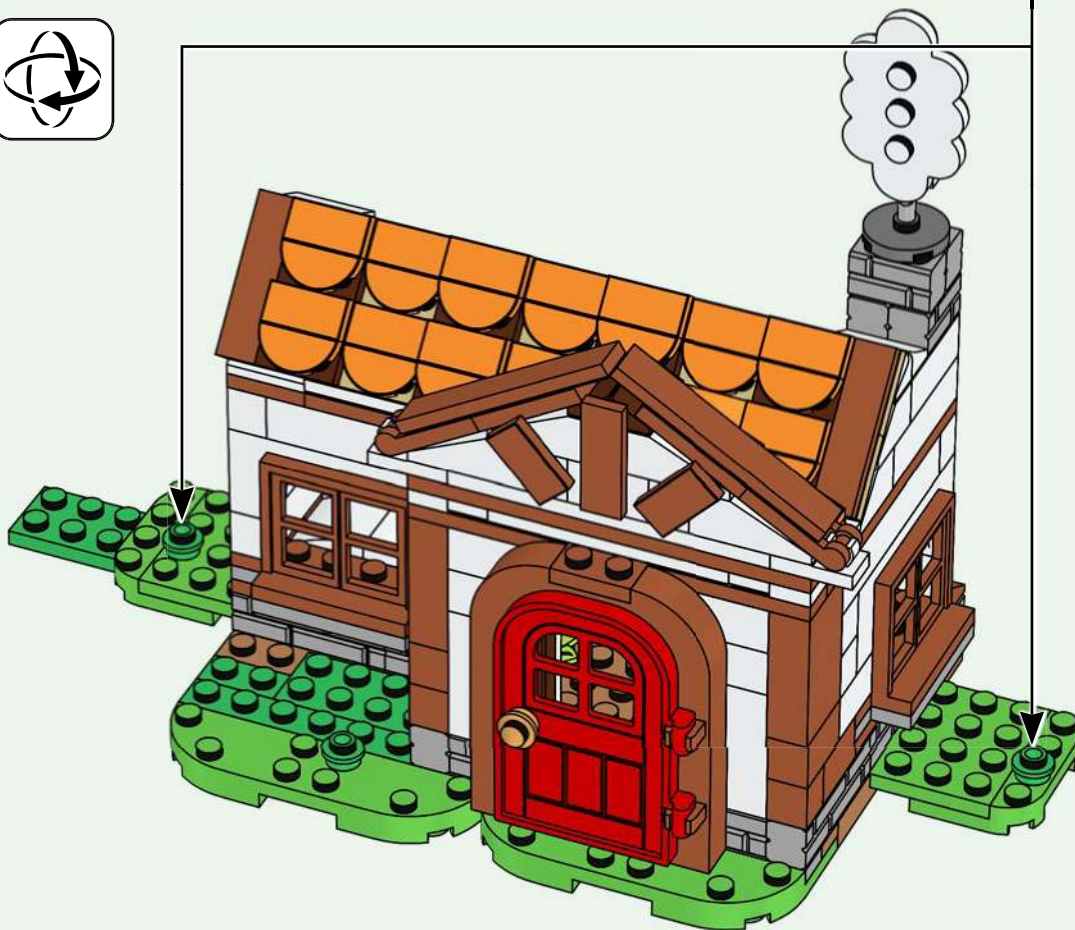
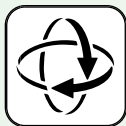



94

1



2

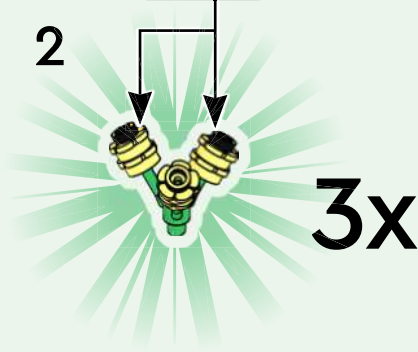
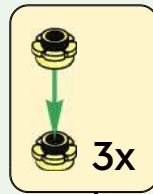



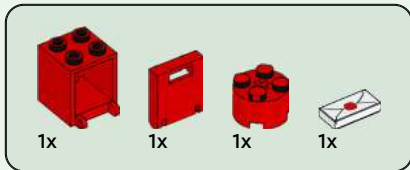

95

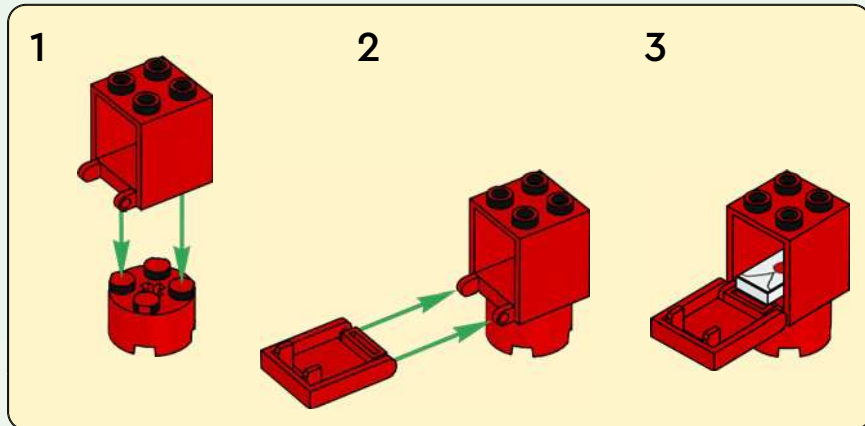

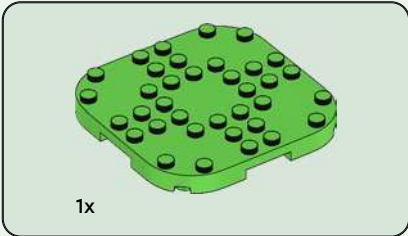
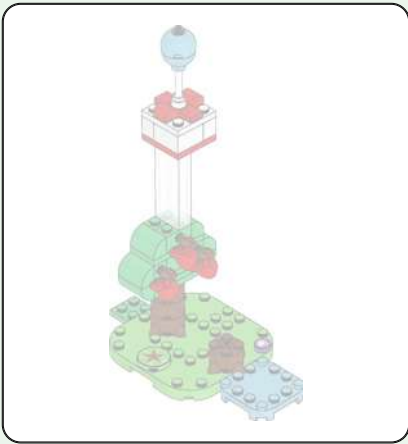

96

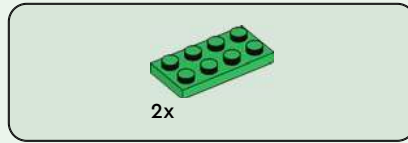
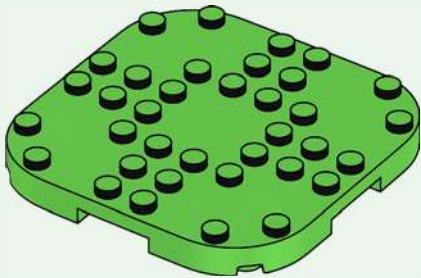

97

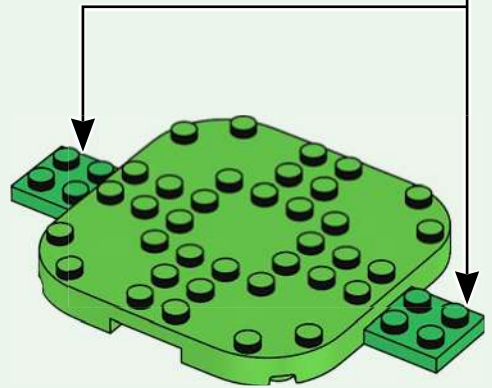
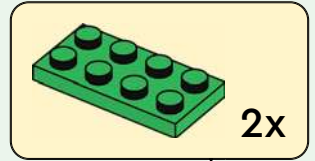



1x

98

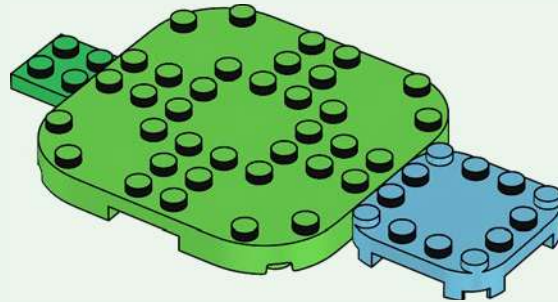





1x



1x

99

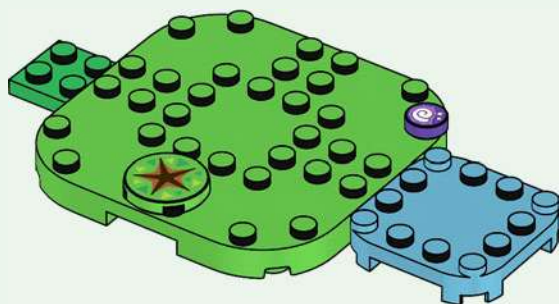

2x

100

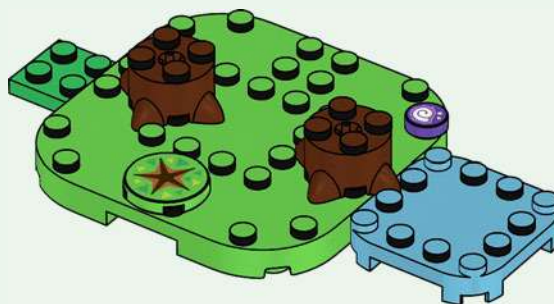



2x

101

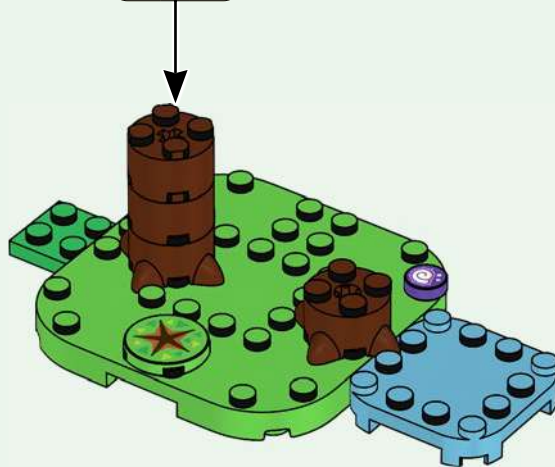
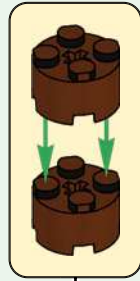

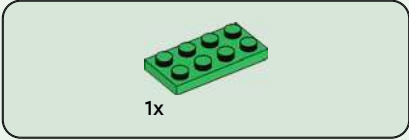
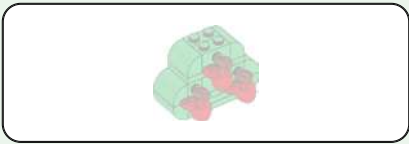

1x

102

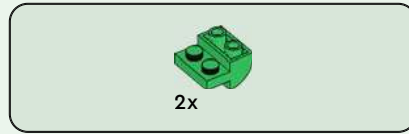
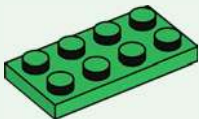

2x

103

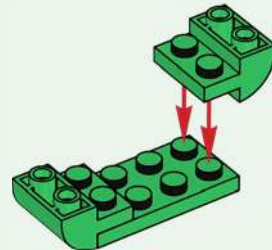



1x

104

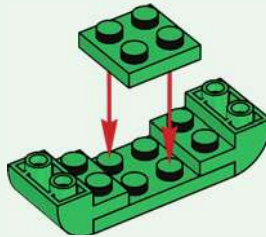

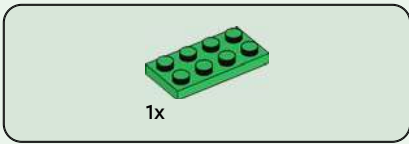

105

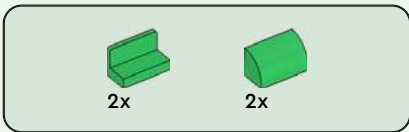
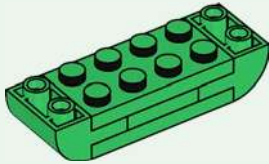

106

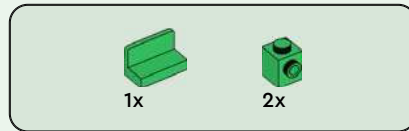
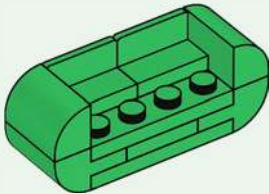

107

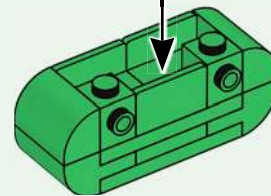
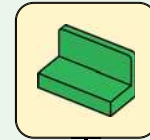



1x

108

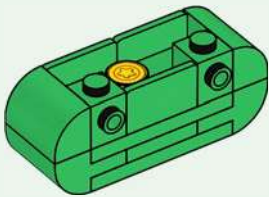

1x

109

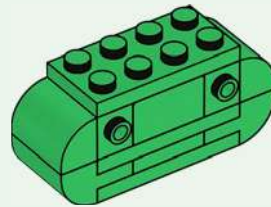

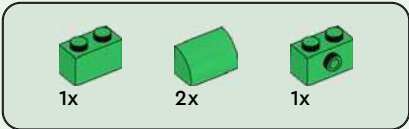

110

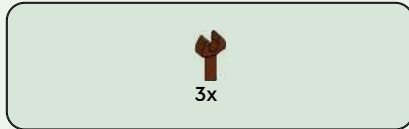
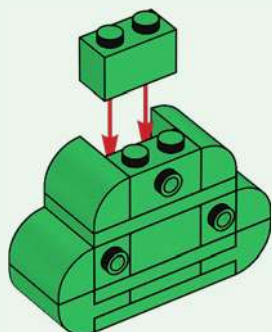

111

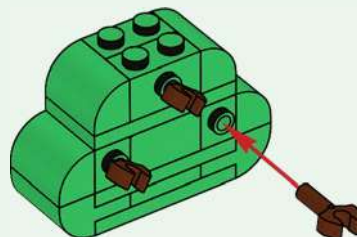



3x

112

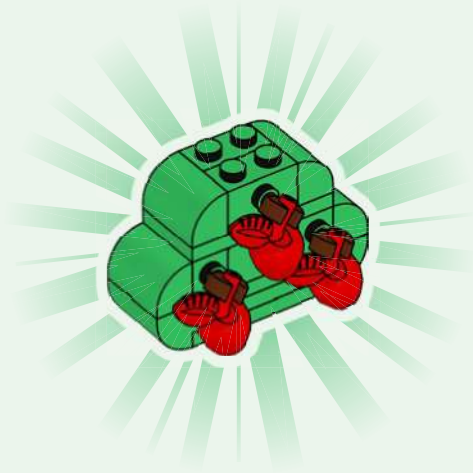



113

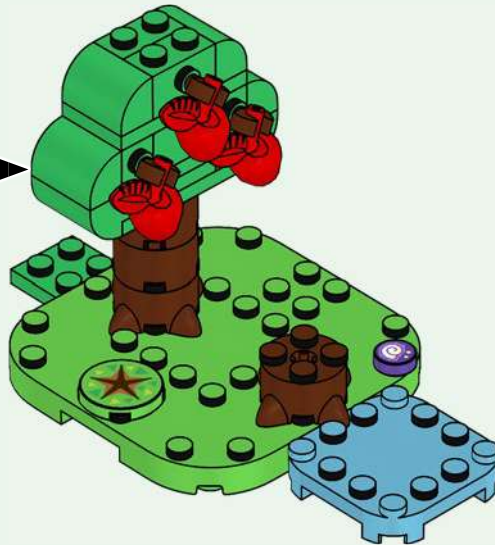

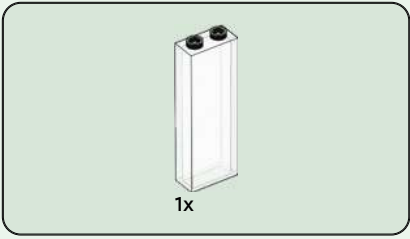

114

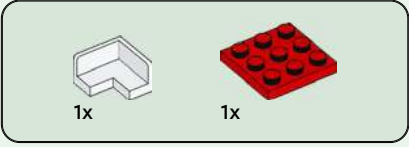
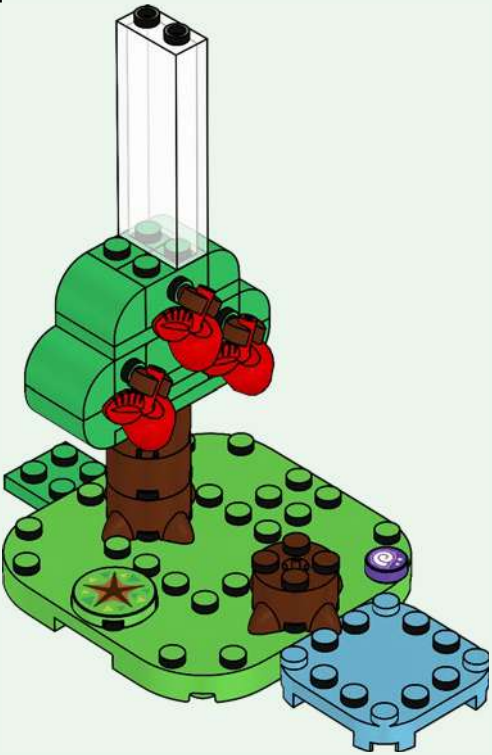

115

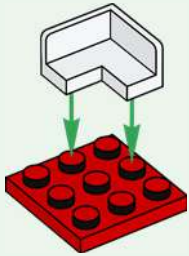



1x



1x



1x

# 116

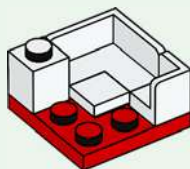

1x

# 117

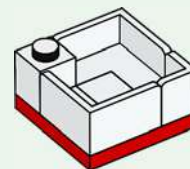

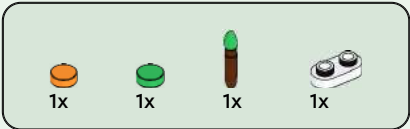

118

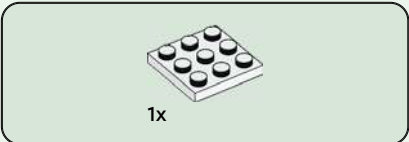
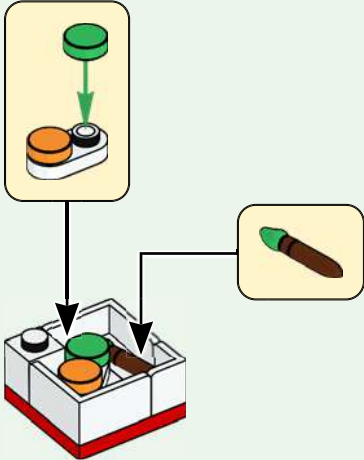

119





1x



2x

120

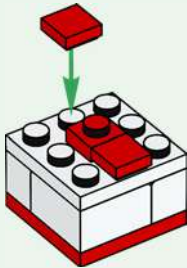

2x

121

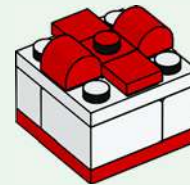

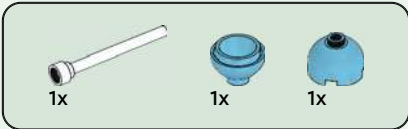

122

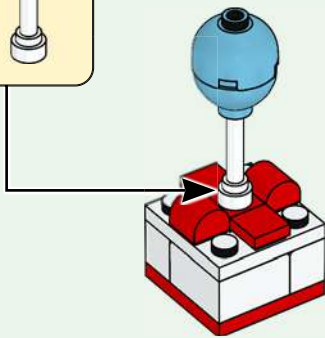
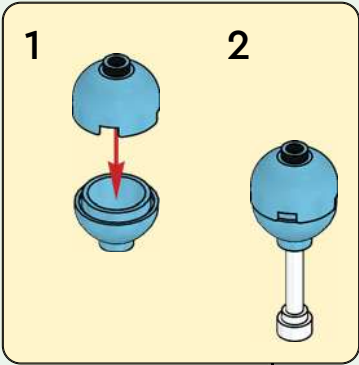

123

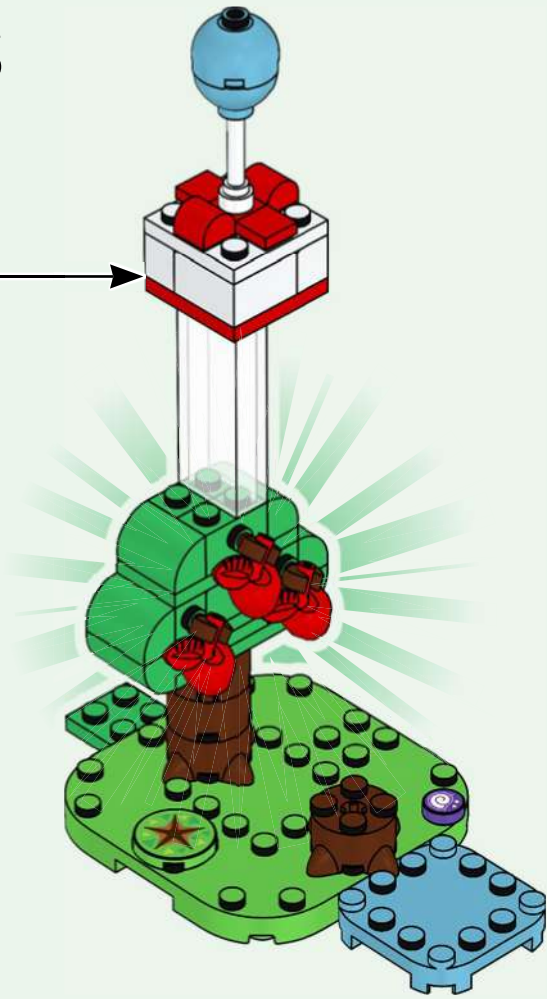

124



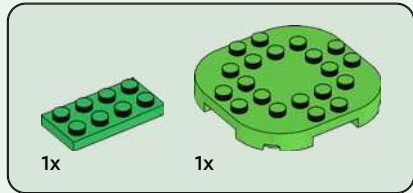

125

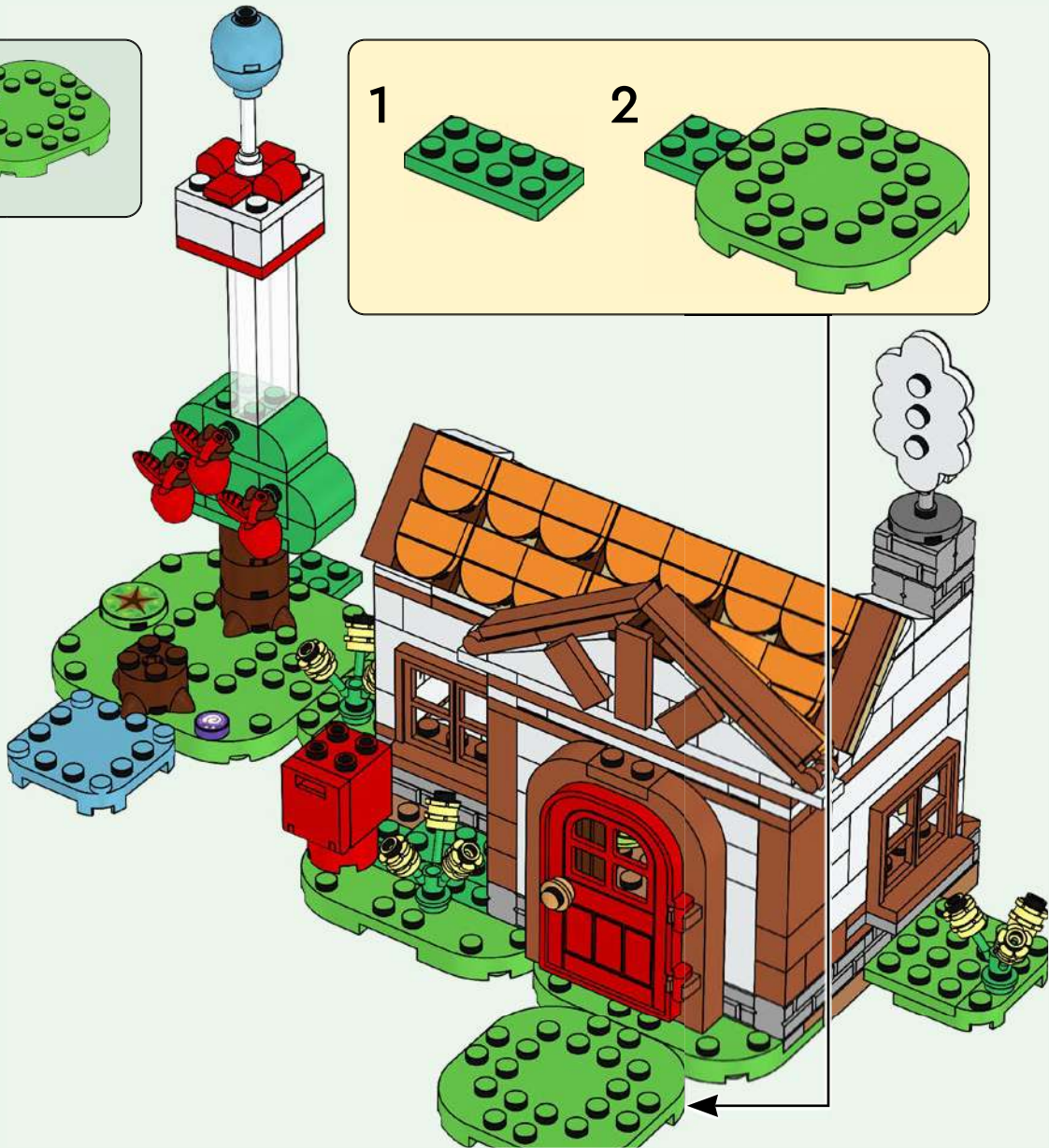
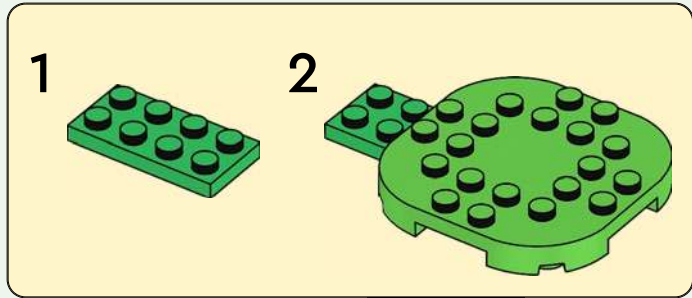











# Welcome to Animal Crossing





77046



77047



77048



77049



77050

9x 300501	1x 6248490	4x 428601	1x 6287774	1x 6484620	1x 6469535	1x 6469903	4x 6254484
2x 4558952	1x 6172927	1x 300201	4x 6092587	1x 306221	2x 302024	1x 302228	2x 6104342
1x 307001	4x 6347309	1x 4141607	2x 6063943	2x 6278441	1x 6195325	2x 6469900	4x 6340735
1x 623101	1x 306901	2x 301001	1x 4113917	2x 307021	1x 4253815	9x 302028	5x 4616027
2x 6235083	6x 303901	1x 6104805	1x 4113917	1x 302421	1x 452226	1x 346028	1x 6486308
1x 6132824	5x 300301	1x 395701	1x 4114084	3x 6054438	1x 6396247	1x 6469544	6x 4579659
1x 6210272	5x 300301	1x 6223667	1x 4113233	1x 4521851	3x 6338221	2x 4119479	2x 6315191
4x 4547489	1x 6469556	2x 6047220	1x 4201062	1x 614321	2x 4569058	2x 6477827	2x 4614158
1x 6329606	1x 302001	1x 302001	2x 4261628	1x 616321	2x 6385644	2x 4617799	1x 6361813
1x 6284507	2x 663601	1x 4113916	2x 6229130	2x 4261628	3x 6269971	2x 6301631	1x 6469560
1x 6469573	2x 6181753	1x 4113916	1x 6468830	2x 4261628	2x 302328	2x 6301631	1x 4615606
1x 6299836	4x 300901	1x 4113916	1x 6217123	1x 6217123	3x 6146227	2x 6340682	2x 6186007
10x 300401	2x 4109791	1x 4113916	1x 6217123	1x 6217123	4x 6270719	2x 6340682	2x 6477977
2x 4558168	2x 6106183	1x 4113916	1x 6217123	1x 6217123	1x 4107736	1x 6301641	2x 6477977
1x 6383982	1x 346001	1x 6302268	2x 6030980	2x 6030980			3x 6359717
2x 362301		2x 6030980					

3x  
6074892

2x  
6074893

2x  
6468832

4x  
6253418

2x  
6359696

1x  
6340118

1x  
6468831

1x  
6477896

1x  
6351327

1x  
6251285

1x  
6253231

1x  
6499105

1x  
6284582

2x  
4173805

2x  
6173925

1x  
6267125

1x  
6469538

12x  
4188771

1x  
6424015

4x  
6477942

12x  
6477975

1x  
4650977

1x  
6337519

1x  
6209692

4x  
4537251

2x  
6286831

1x  
6361353

1x  
6484619

1x  
6489623

2x  
6290541

1x  
6365027

1x  
6096091

2x  
6385485

1x  
6122504

2x  
6295078

3x  
6439053

1x  
6359662

1x  
6167879

1x  
6174229

2x  
4504376

2x  
6035291

2x  
4211166

2x  
6468829

1x  
6236915

1x  
4216695

1x  
6262952

1x  
6307618

3x  
4211186

1x  
4211503

4x  
4211399

1x  
6227897

9x  
6000066

1x  
4211398

1x  
6066097

5x  
6314891

2x  
4211395

1x  
4211425

1x  
6115080

1x  
4211006

1x  
6096990

4x  
6251940

18x  
6426463

8x  
6275877

2x  
6301835

1x  
6486312

1x  
6469559

1x  
6469536

1x  
6287612

1x  
4523159

1x  
4624615

1x  
6329593

1x  
6287854

2x  
6218360

2x  
6102998

2x  
6093494

1x  
6445924

1x  
6445924

1x  
6445924

1x  
6445924

1x  
6445924

1x  
6445924

1x  
6445924

1x  
6445924

2x  
6482656

1x  
6415996

1x  
6132411

1x  
6429058

1x  
6469904

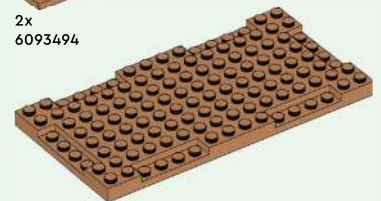

1x  
6445924



 [LEGO.com/service](https://www.LEGO.com/service)

YOU COULD  
**WIN**



Scan this QR code or go to  
**LEGO.COM/PRODUCTFEEDBACK** and give us  
your short feedback about this LEGO® set for a  
chance to win a cool LEGO prize.

Terms and Conditions apply\*

**EN: YOU COULD WIN.** Terms and Conditions apply\* **DE: Du könntest GEWINNEN.** Es gelten die Teilnahmebedingungen\* **FR: Tu pourrais GAGNER.** Des conditions s'appliquent\* **IT: Potresti VINCERE tu.** Termini e condizioni sono applicabili\* **ES: Puedes GANAR.** Aplican términos y condiciones\* **PT: Poderá GANHAR.** Aplicam-se termos e condições\* **ZH: 轻松获奖. 条款和条件适用\*** **PL: Szansa na WYGRANĄ.** Obowiązują warunki korzystania\* **CS: Máte šanci VYHRÁT.** Platí všeobecné smluvní podmínky\* **SK: Máte šancu VYHRAŤ.** Platia všeobecné zmluvné podmienky\* **HU: TE IS NYERHETSZ.** Felhasználási feltételek érvényesek\* **RO: Ai putea CÂȘTIGA.** Se aplică termeni și condiții\* **BG: Можете да СПЕЧЕЛИТЕ.** Има определени правила и условия\* **LV: Tu vari LAIMĒT.** Ir spēkā noteikumi un nosacījumi.\* **ET: Sul on võimalus VÕITA.** Kehtivad tingimused\* **LT: Jūs galite LAIMĖTI.** Taikomos sąlygos\*

\*[LEGO.com/productfeedback-terms](https://www.lego.com/productfeedback-terms)