

ARMED FORCES



MERKAVA MK. I / II

IN PRODUCTION - 1979 - 1990
PLACE OF ORIGIN - ISRAEL
TYPE - MAIN BATTLE TANK
LENGTH - 8.63M (28'3")
WIDTH - 3,70M (12'1")
HEIGHT - 2,75M (9')
WEIGHT - 62T (68,3 SHORT TONES)
ROAD SPEED - 64KM/H (40MPH)
RANGE - 400KM (248,5MI)
ENGINE - DIESEL ENGINE TCM AVDS-1790-6A V-12, 908KM
PRIMARY ARMAMENT - 1x M68 GUN, KAL. 105MM (4,1")
SECONDARY ARMAMENT - 1x MORTAR KAL. 60MM (2,36"),
3x FN MAG KAL. 7,62MM (0,3") MG
CREW - 4



PAD PRINTED
NO STICKERS

Printed in EU

2621



WARNING: CHOKING HAZARD-
Toy contains small parts.
Not for children under 3 years.

825

MERKAVA MK. I / II

SCALE **1:35**



BE CAREFUL: NOTICE THE DIFFERENCE



UWAGA: RÓŻNE KLOCKI

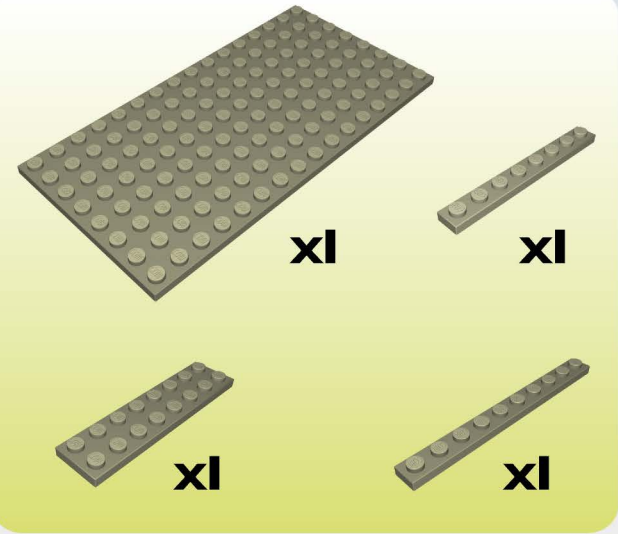

1

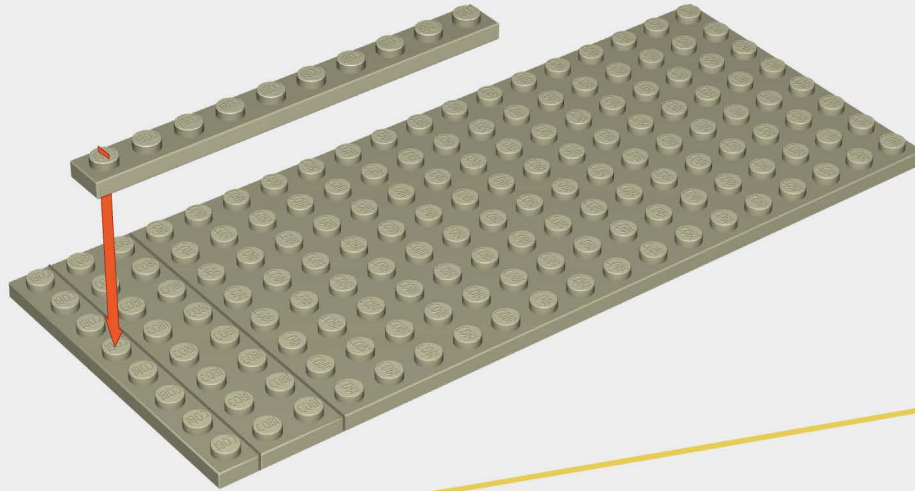

2

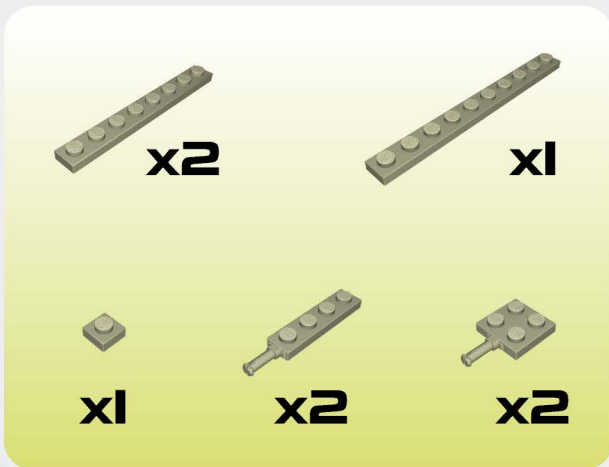
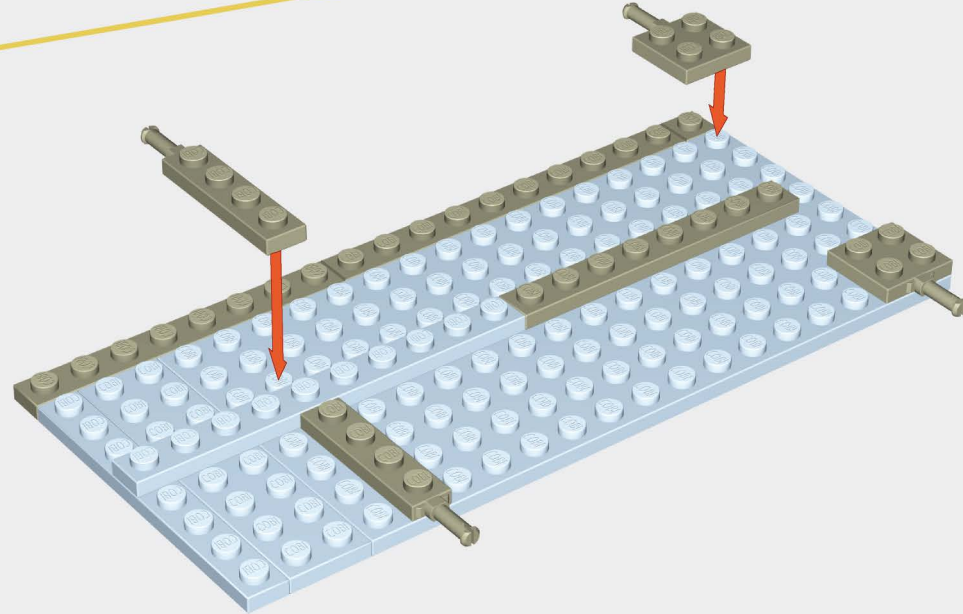

3

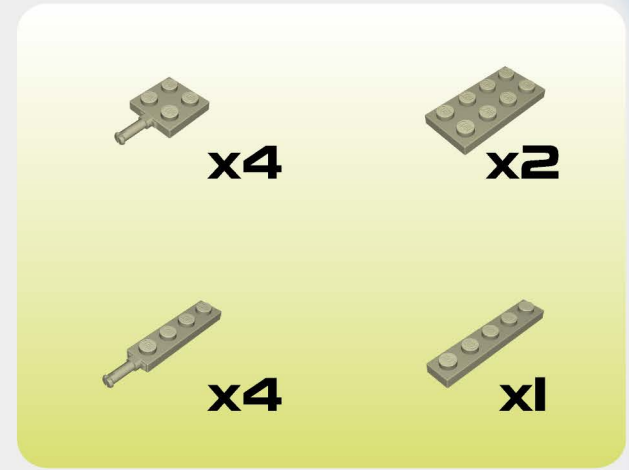
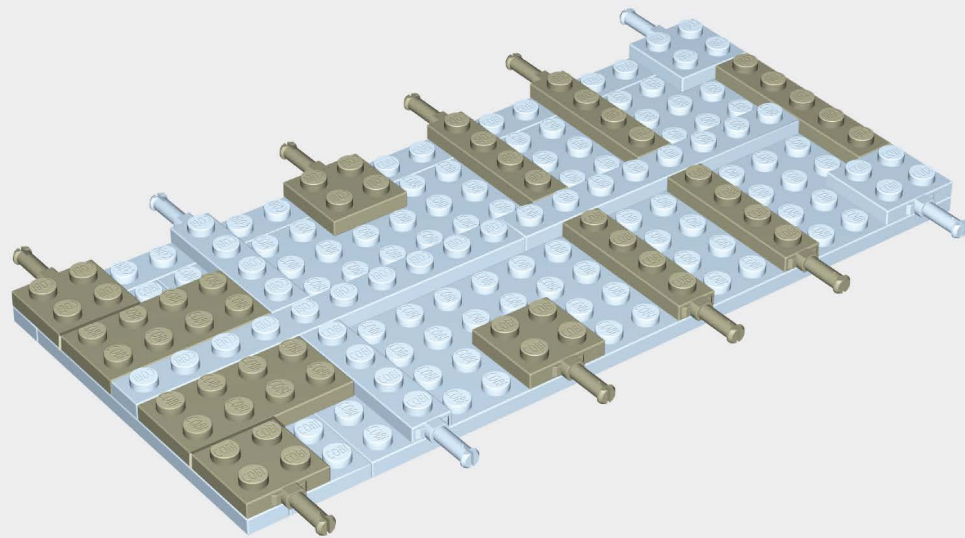

4

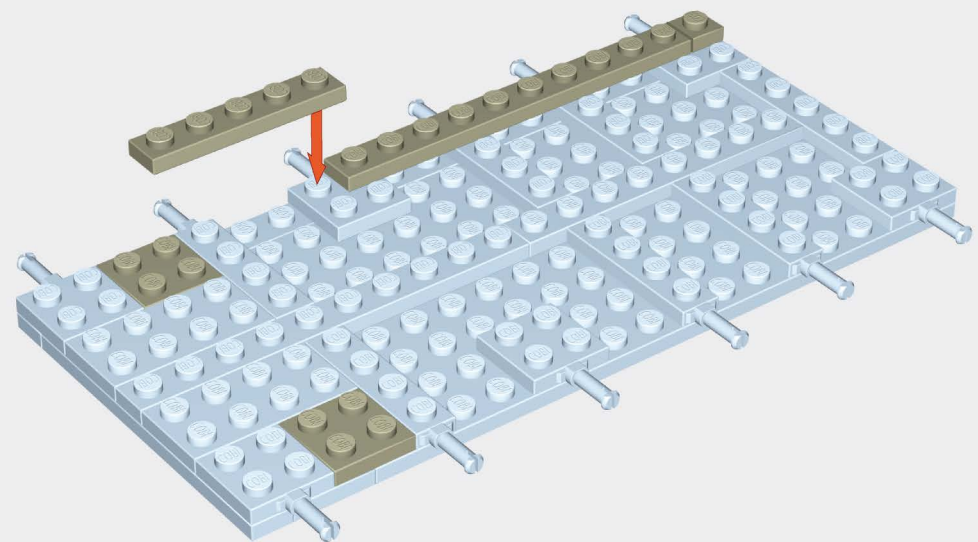
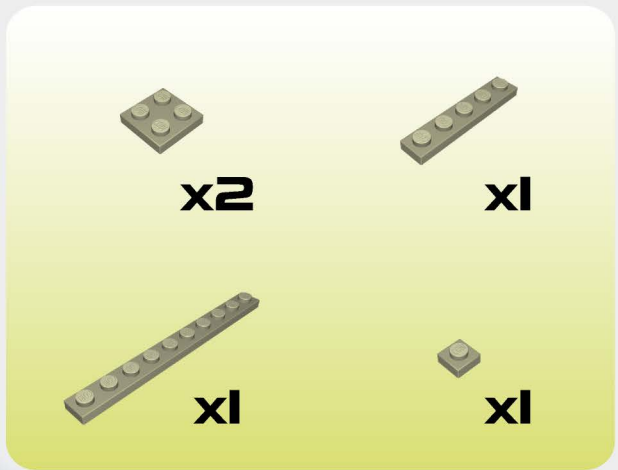

5

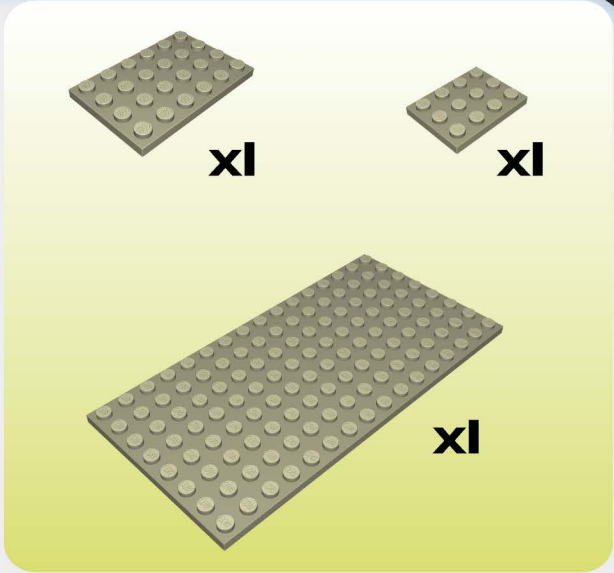
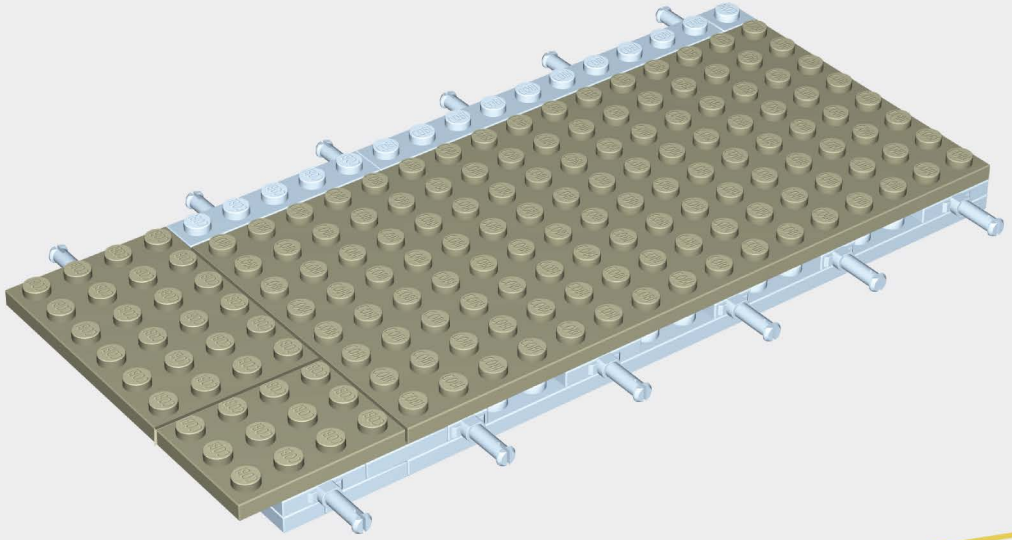

6

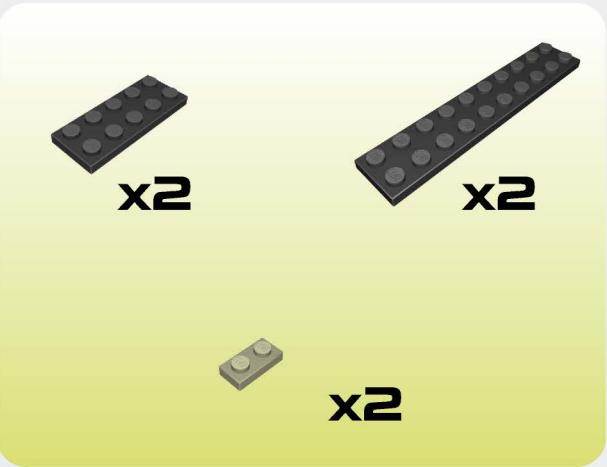
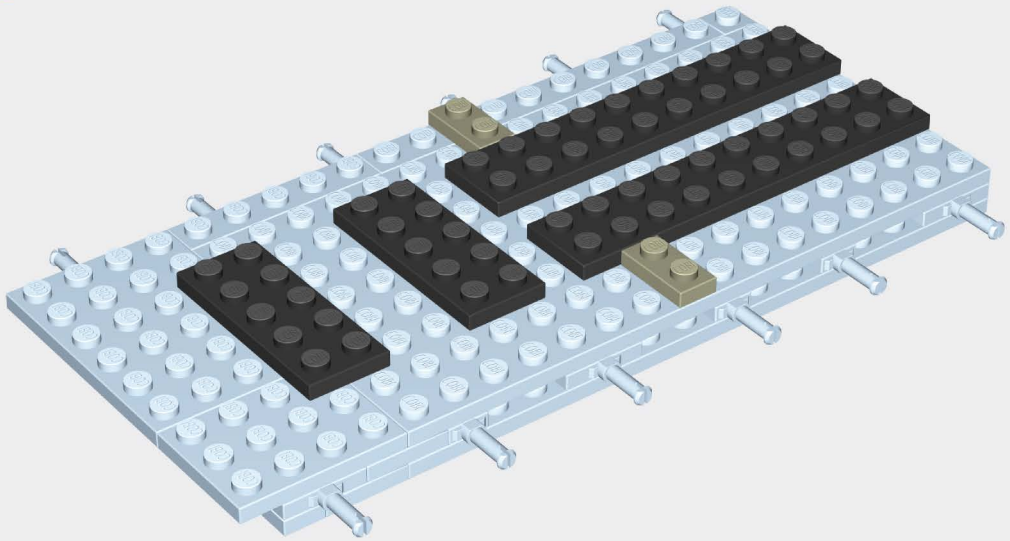

9

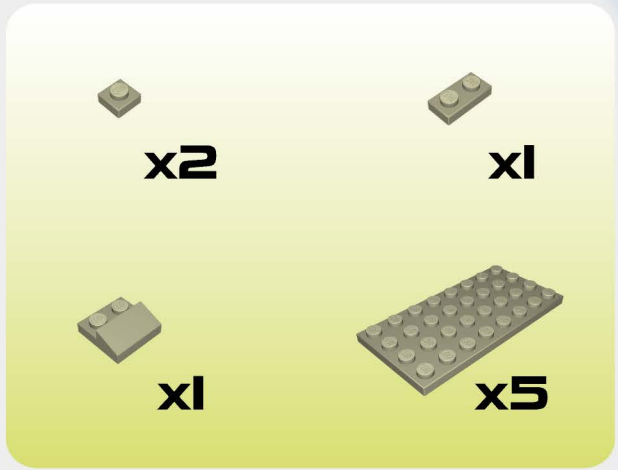
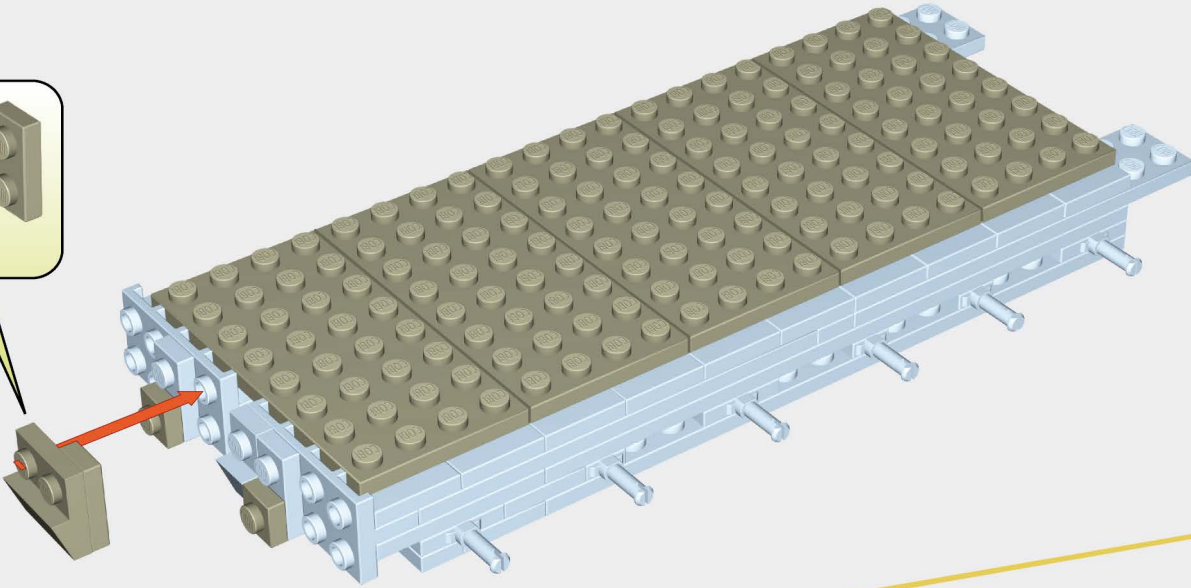
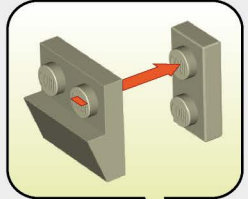

10

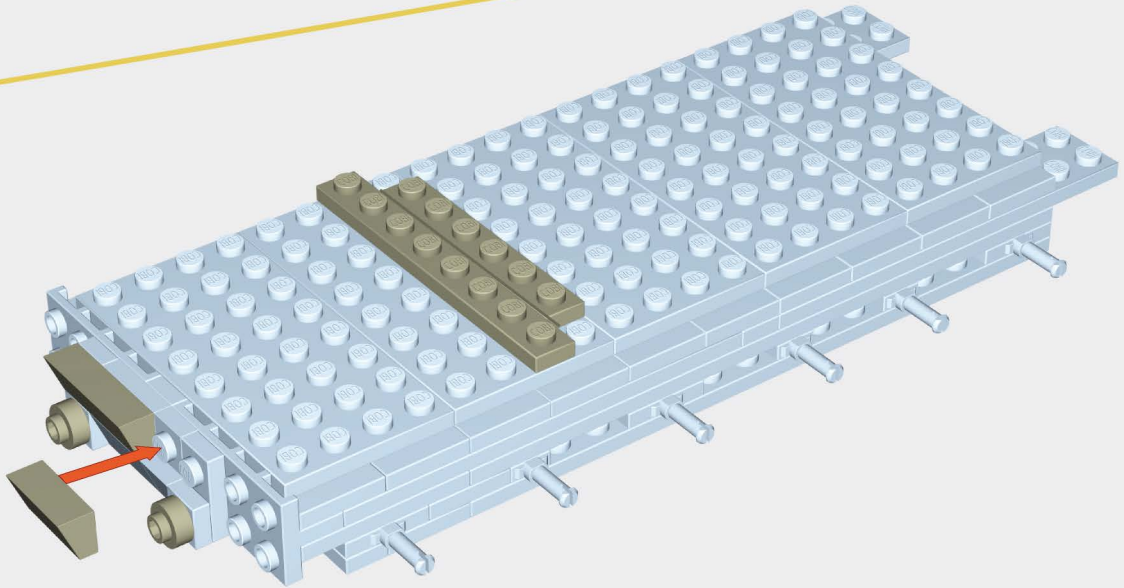
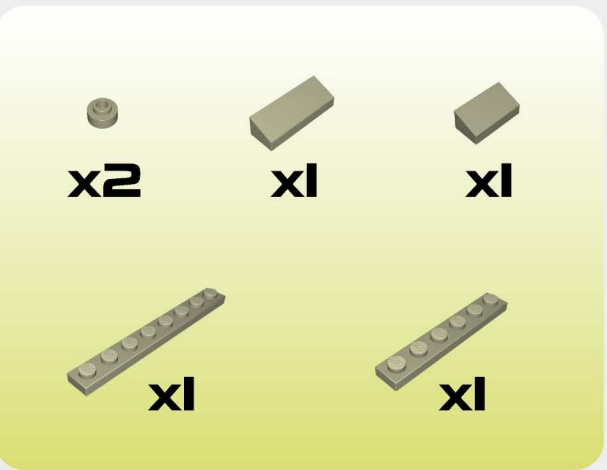

11

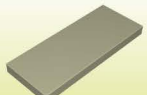
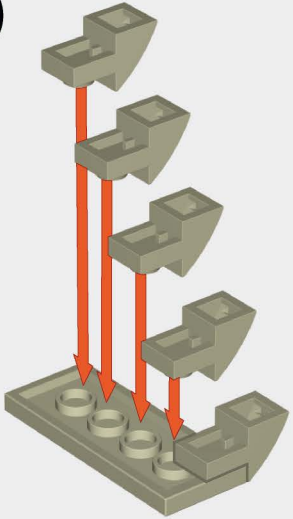

x1



x5

12

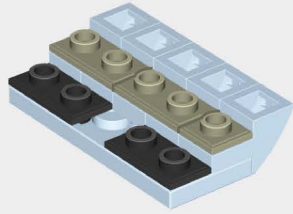

x2



x2



x1

13

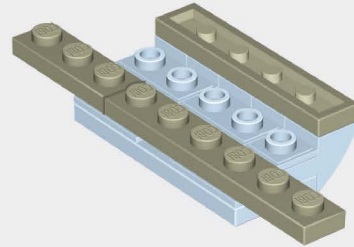

x1

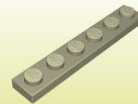

x1



x1

14

1:1

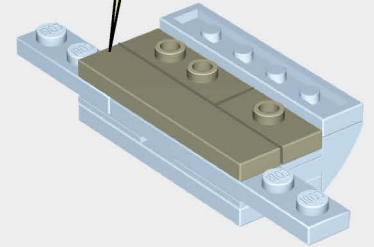

x1



x1



x1

15

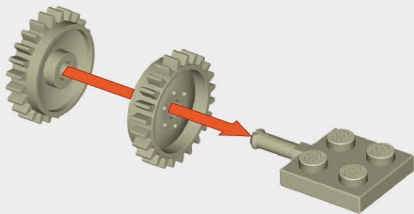

x4



x2

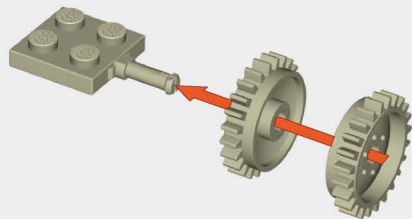

16

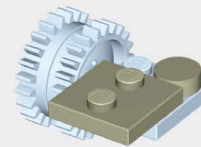

x2



x2

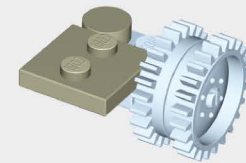

17

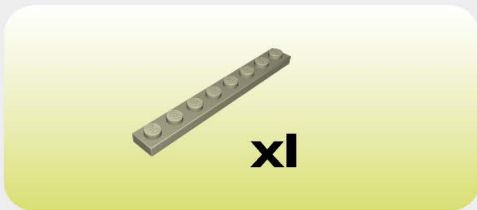
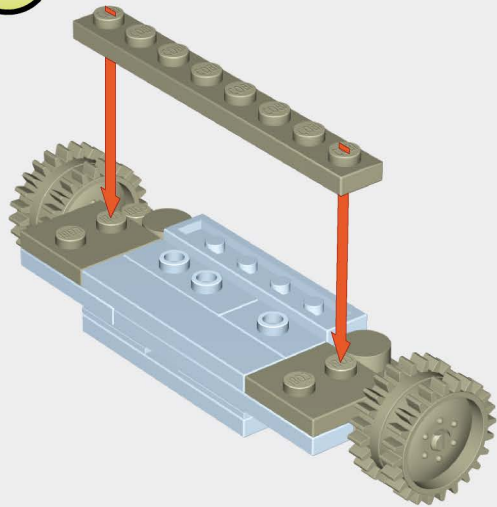

18

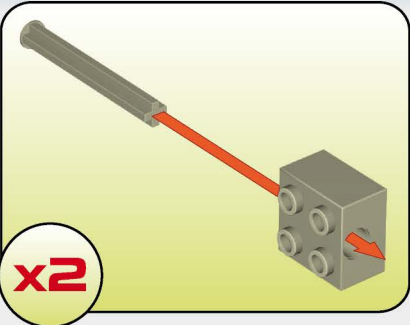

x2

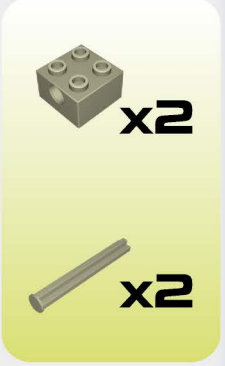
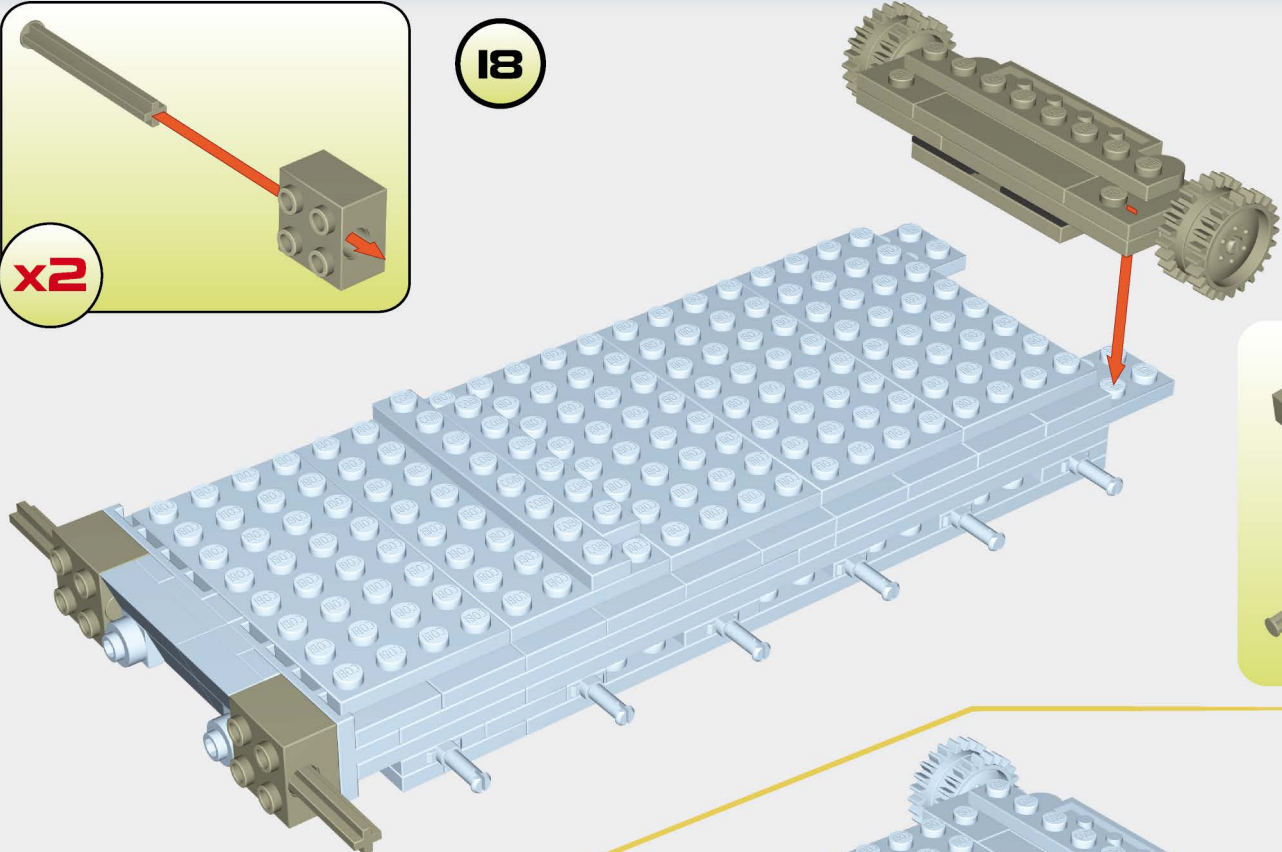

19

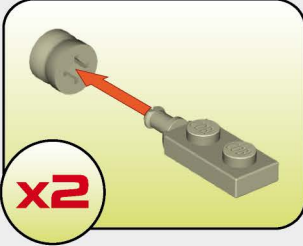
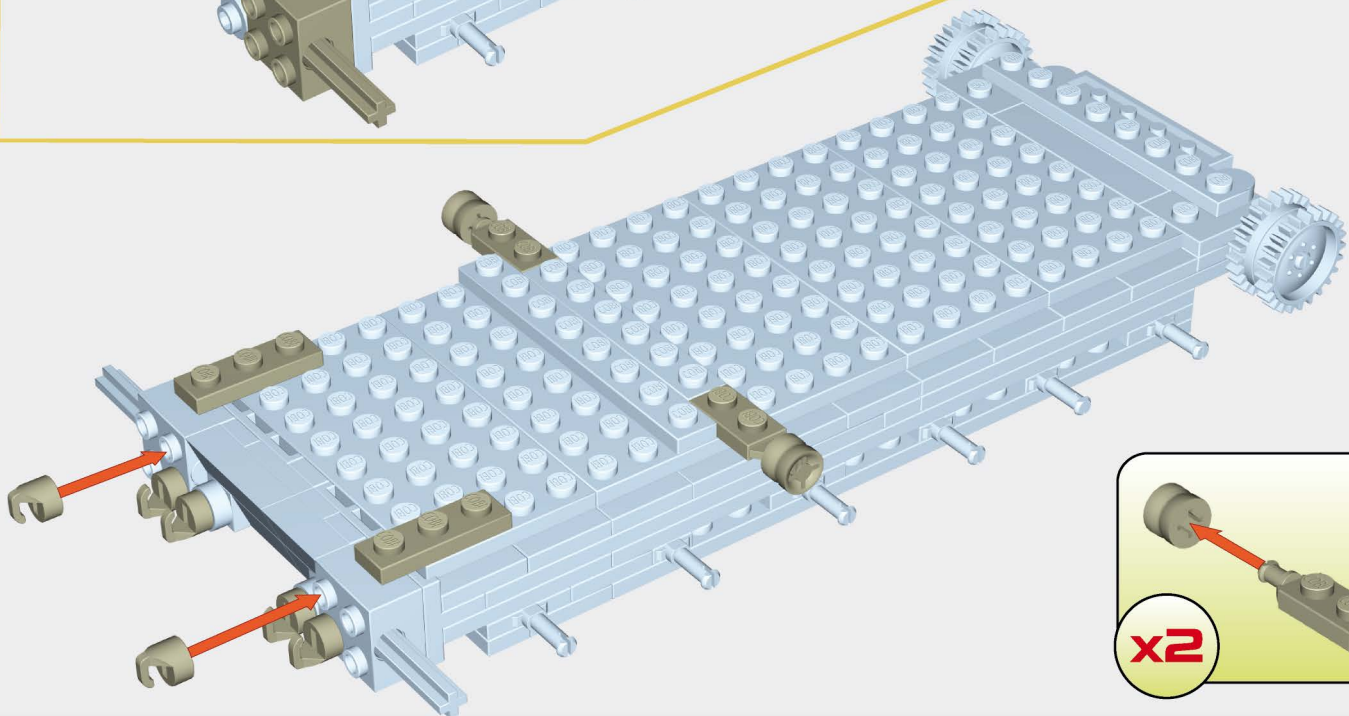
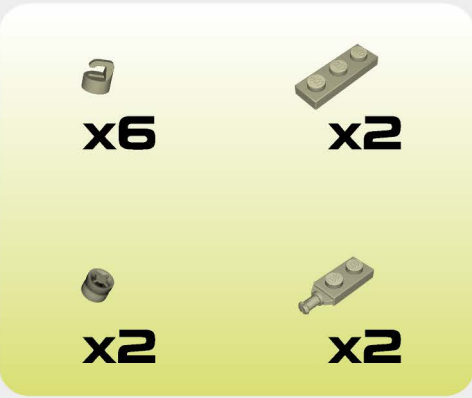

x2

20

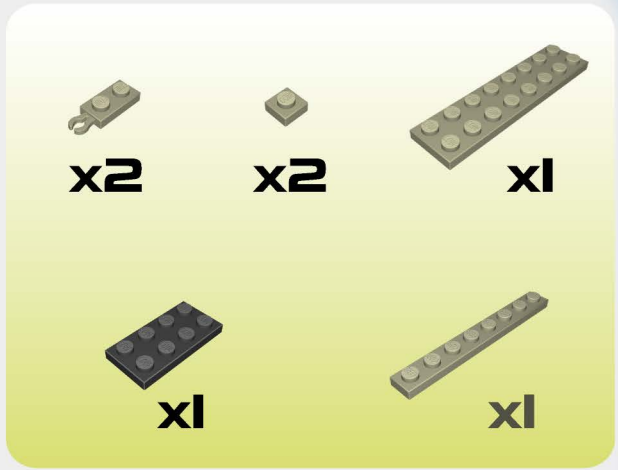
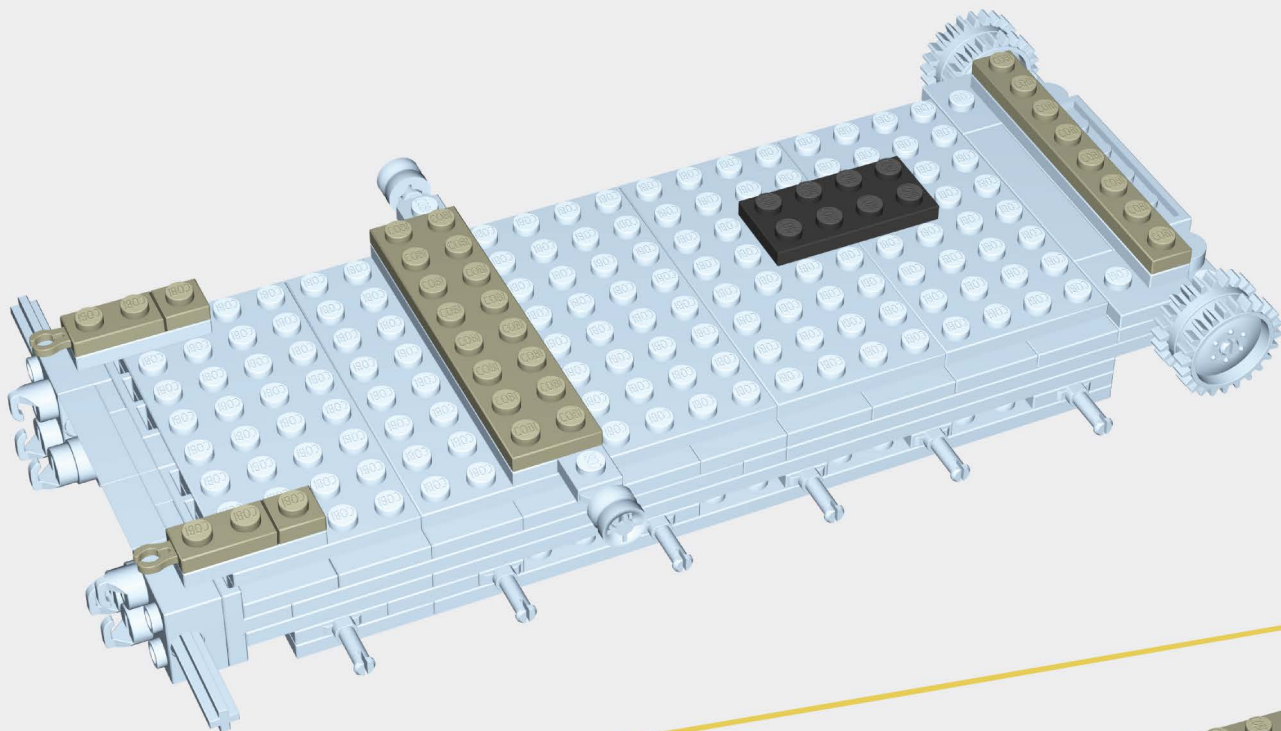

21

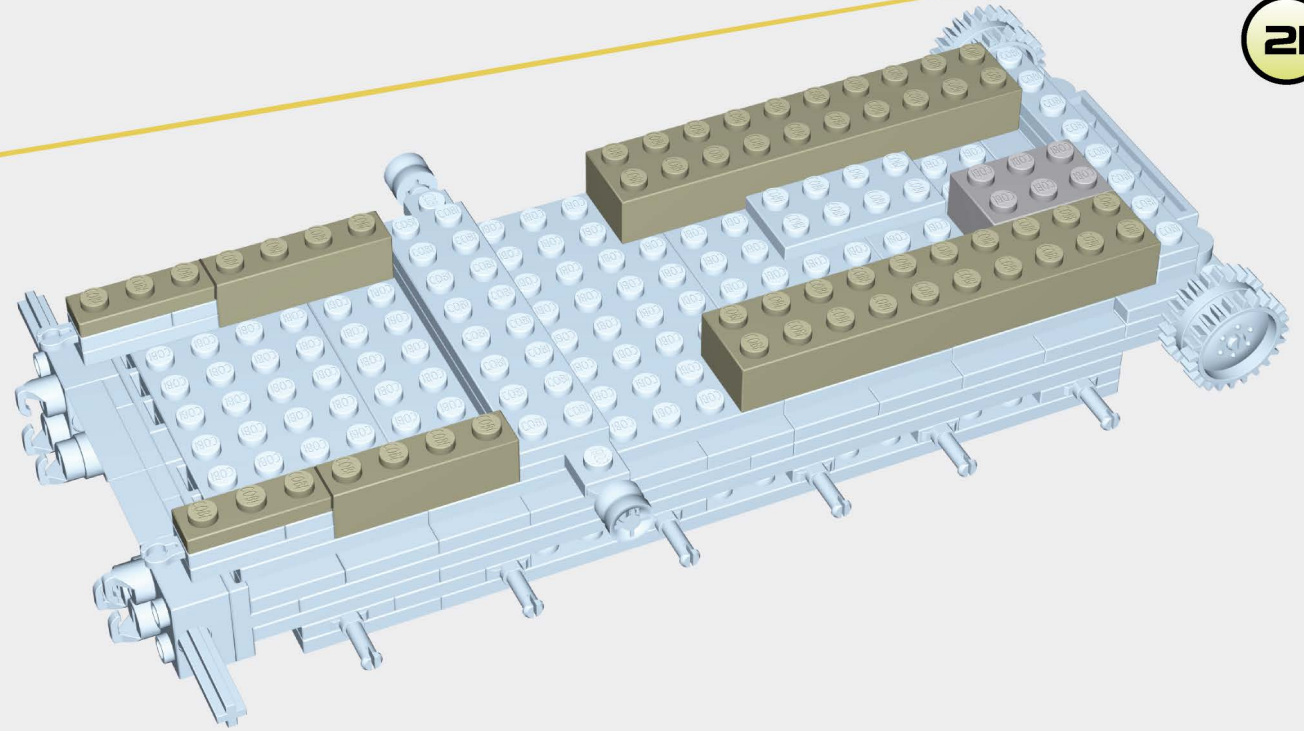
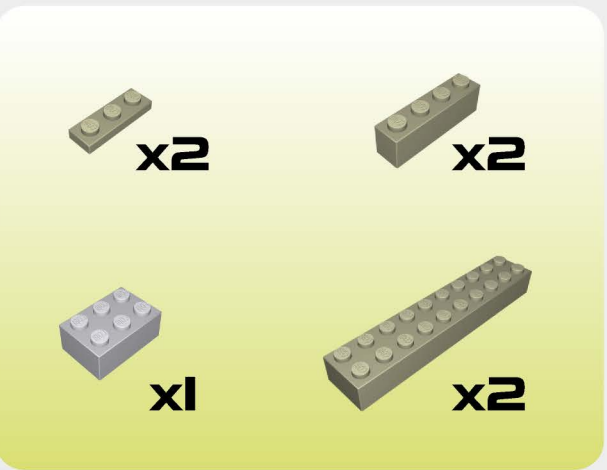

22

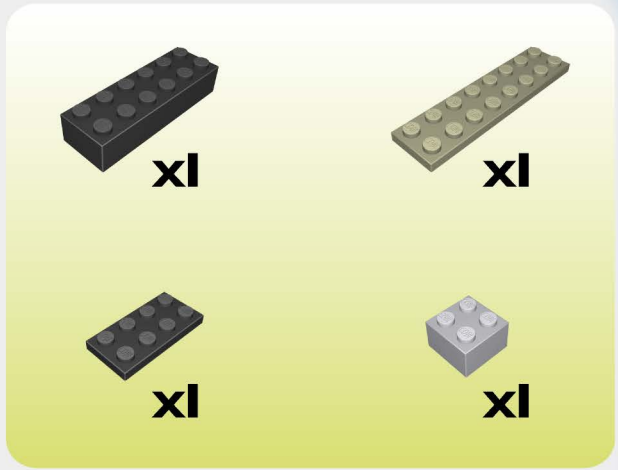
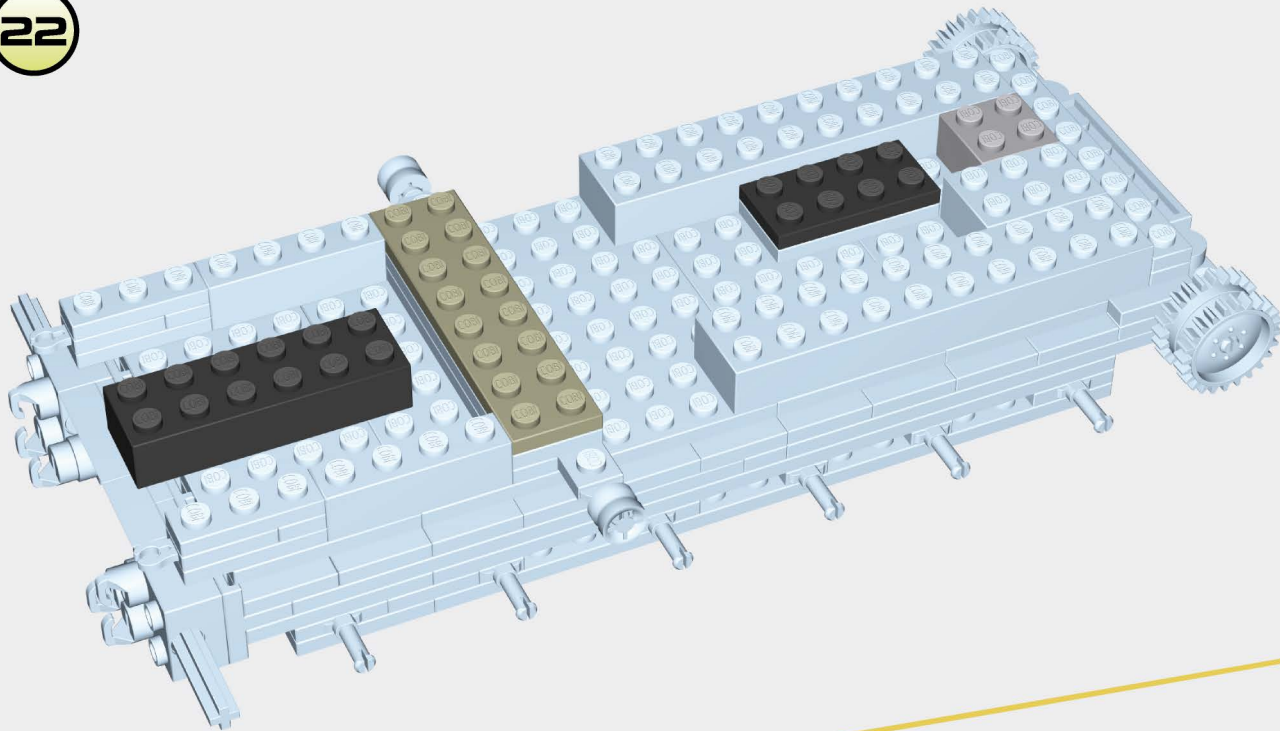

23

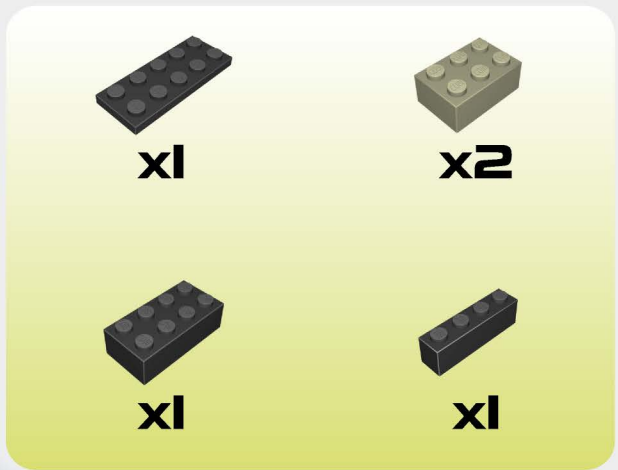
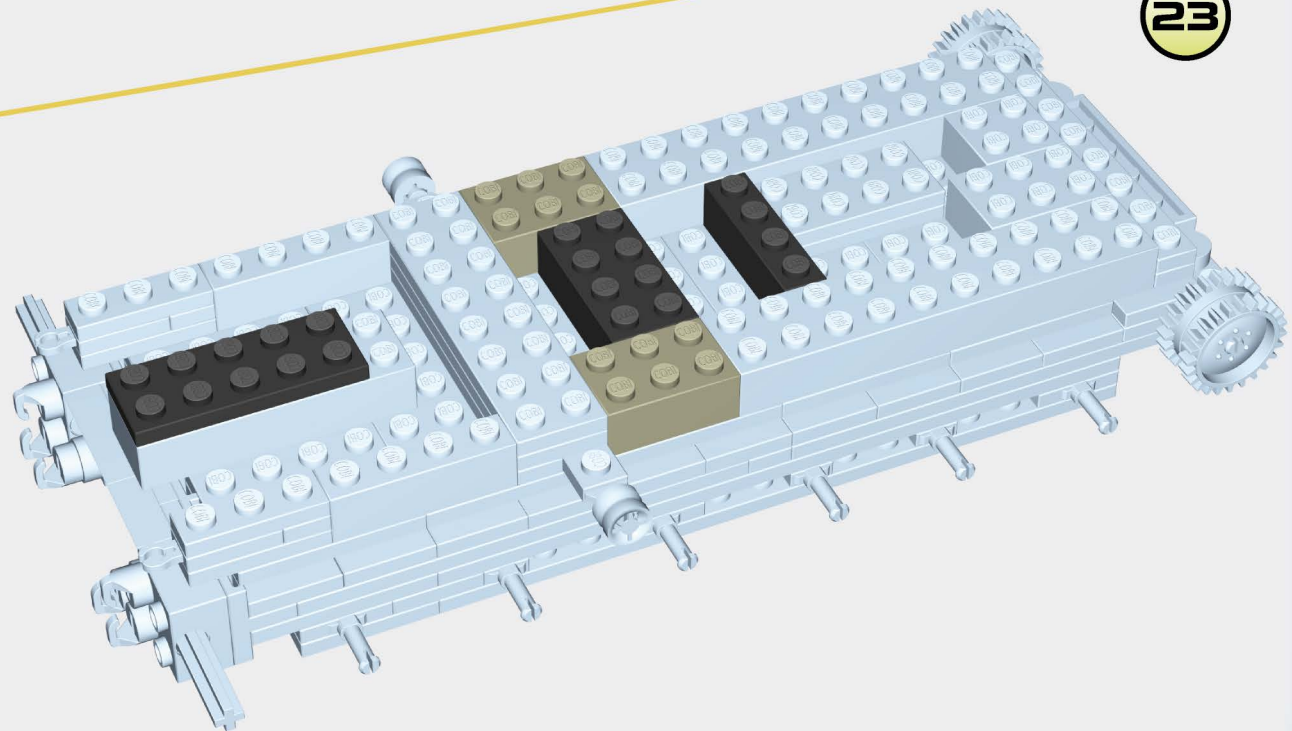

24

1:1

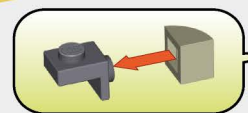
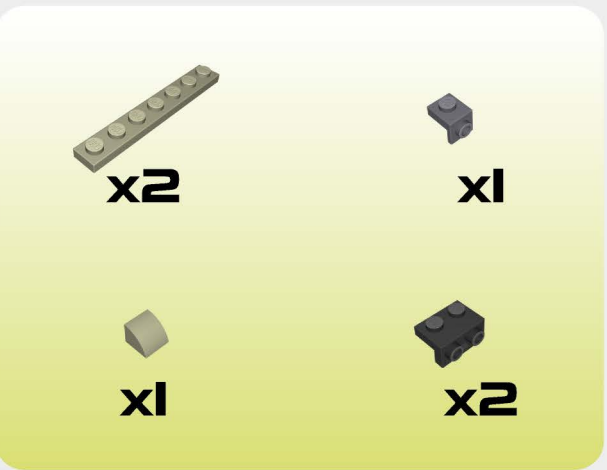
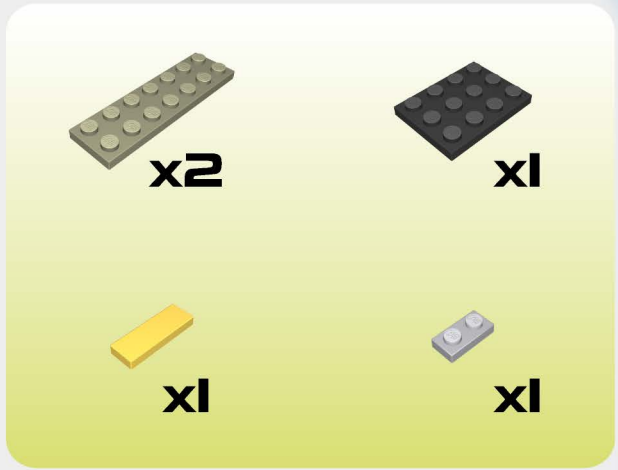
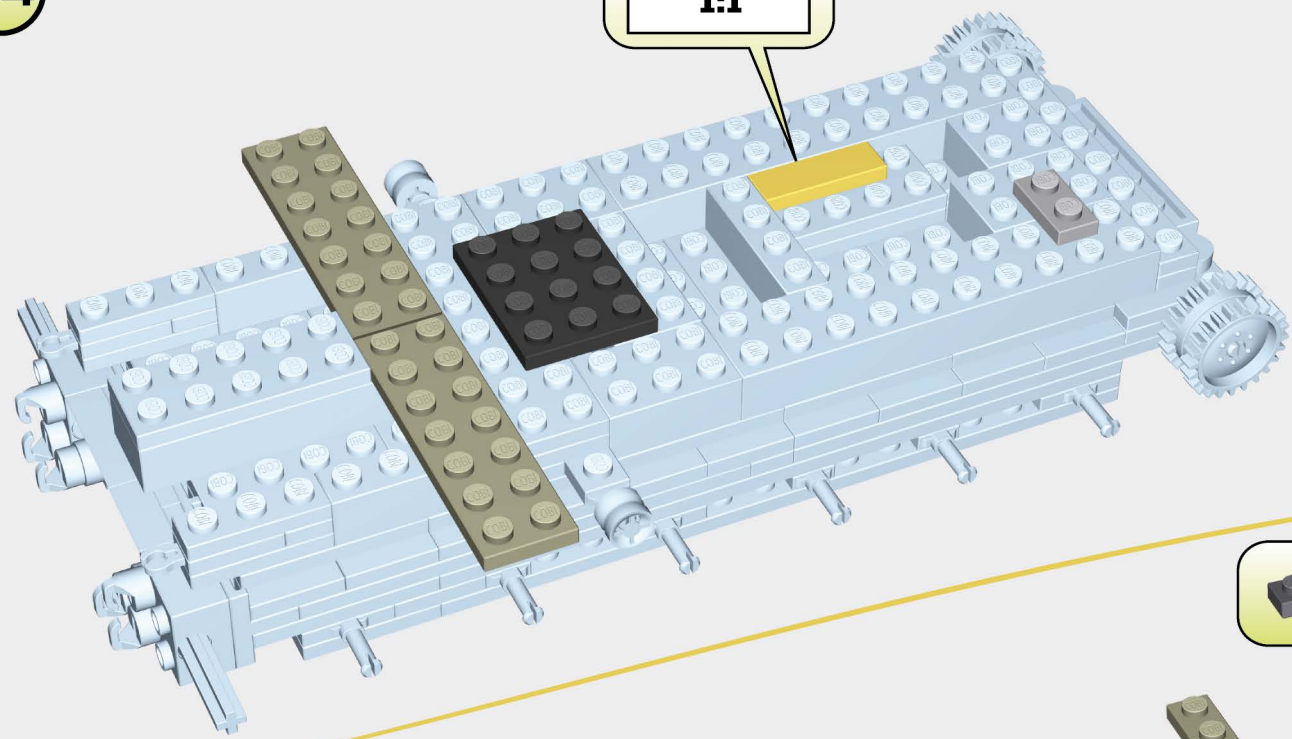

25

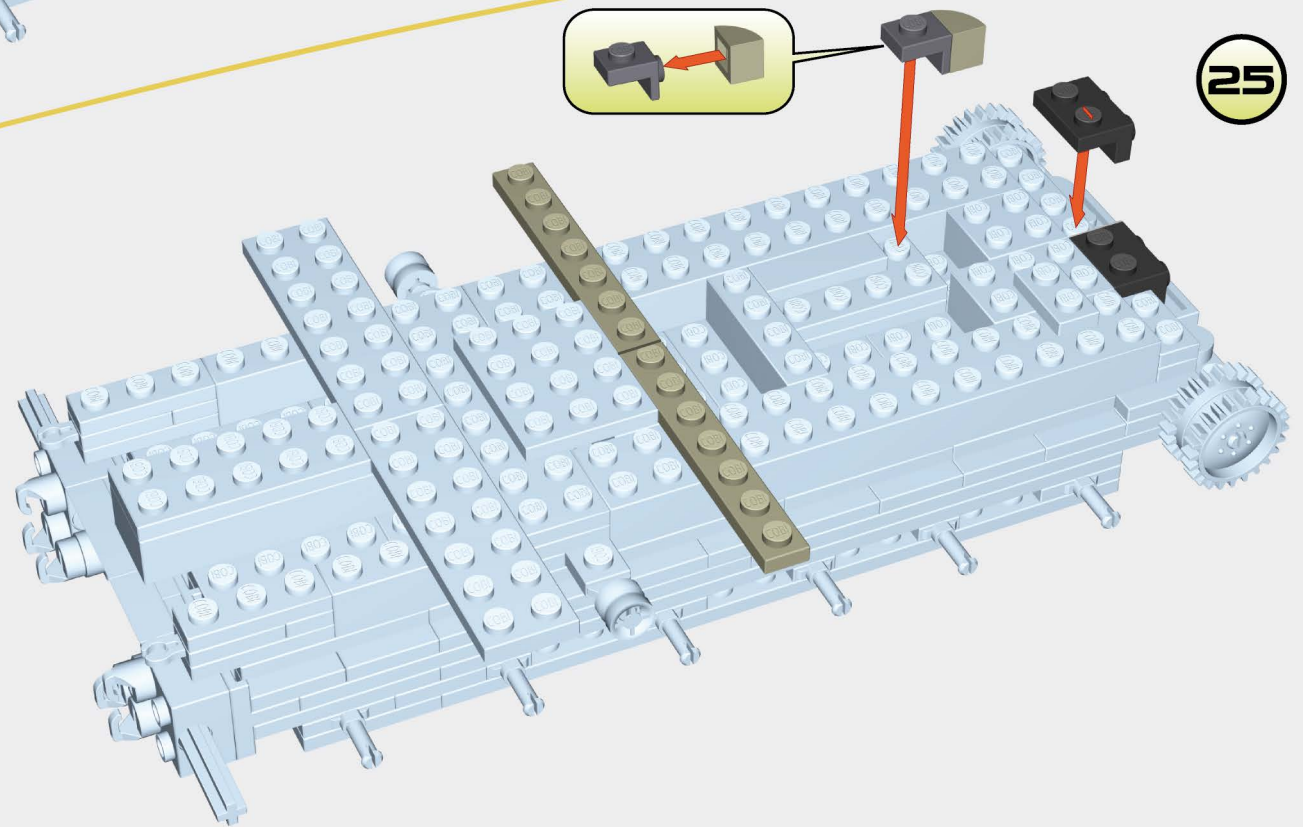

26

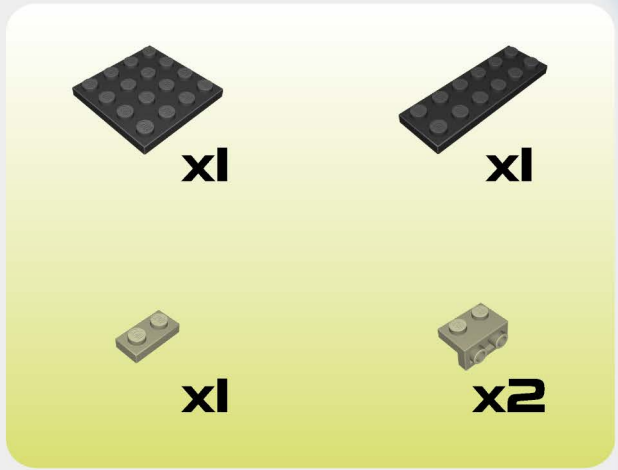
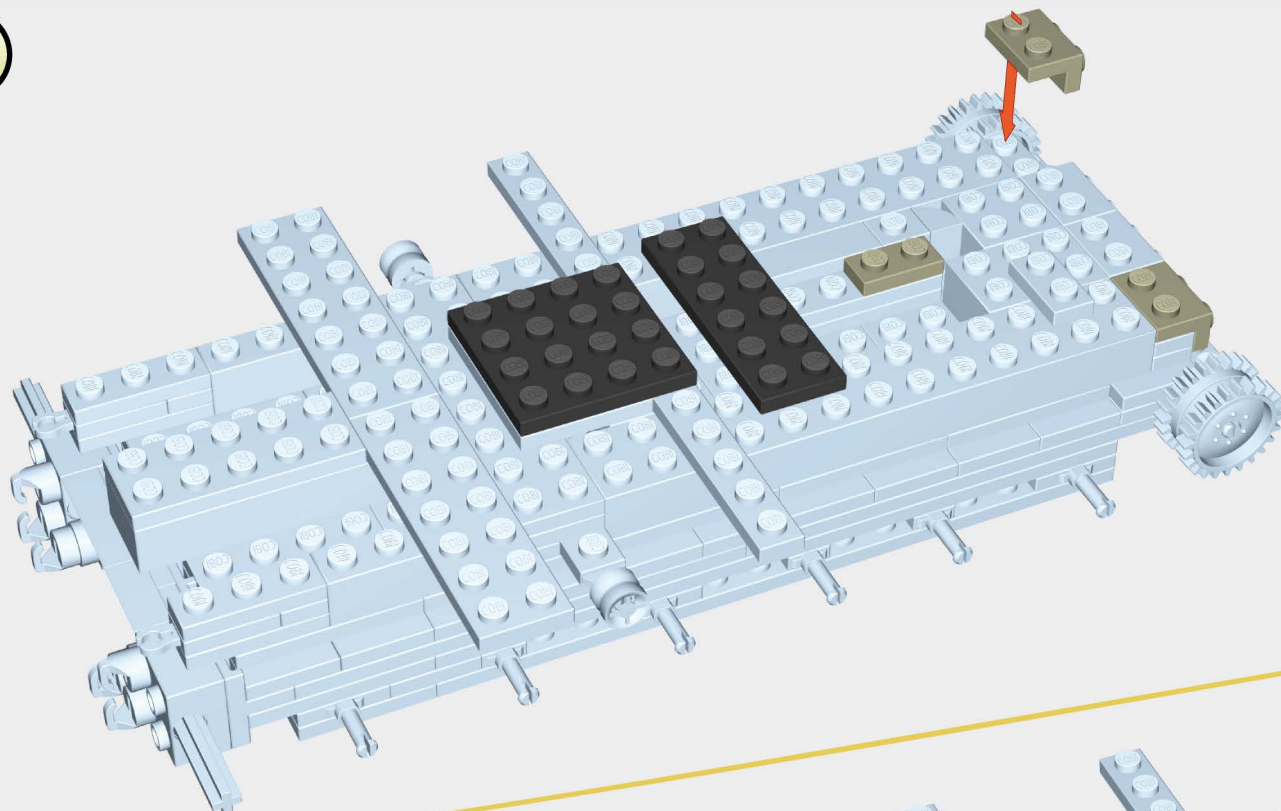

27

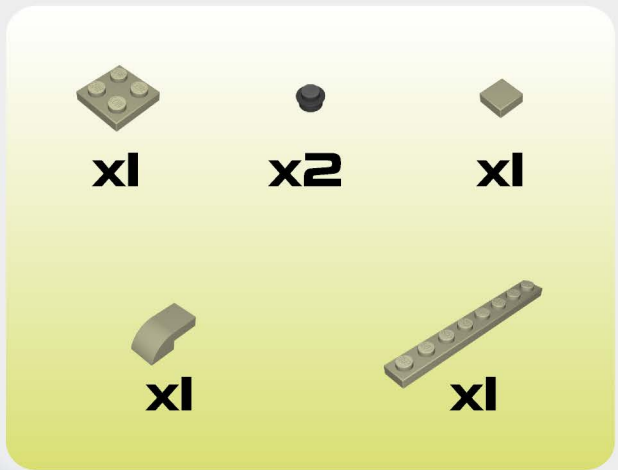
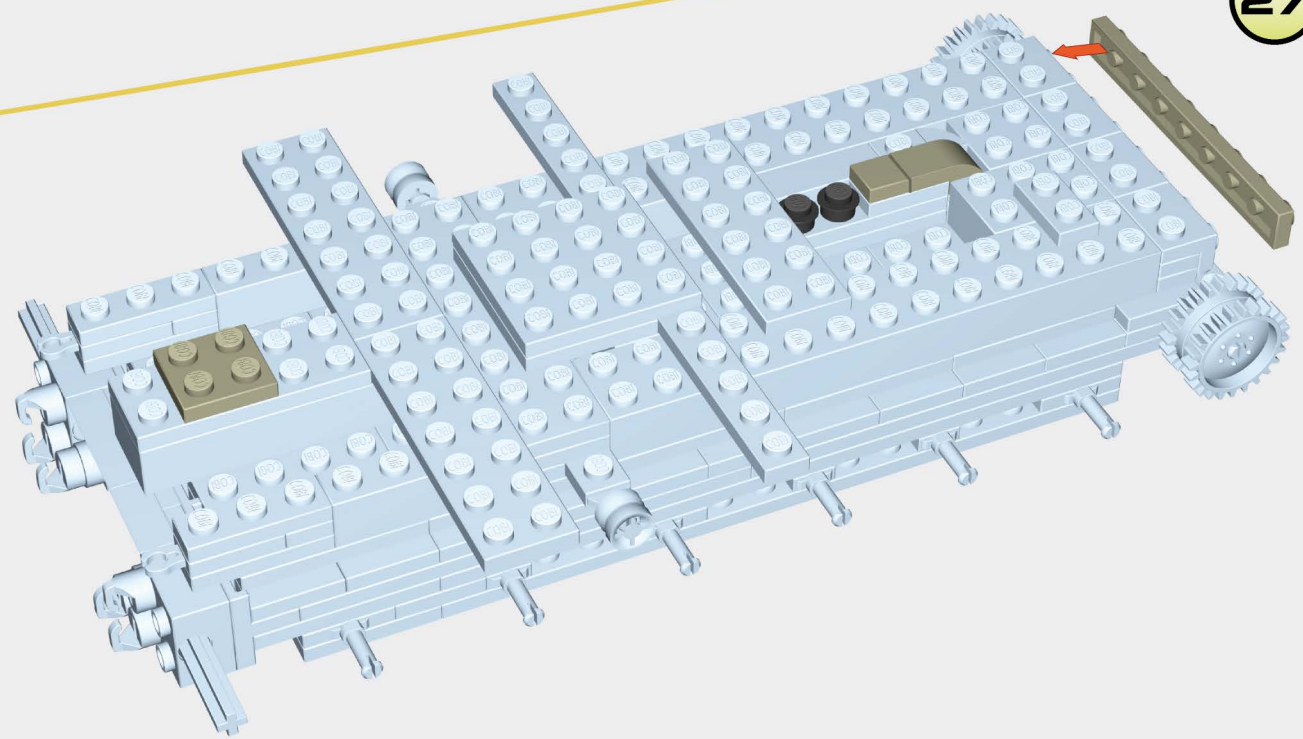

28

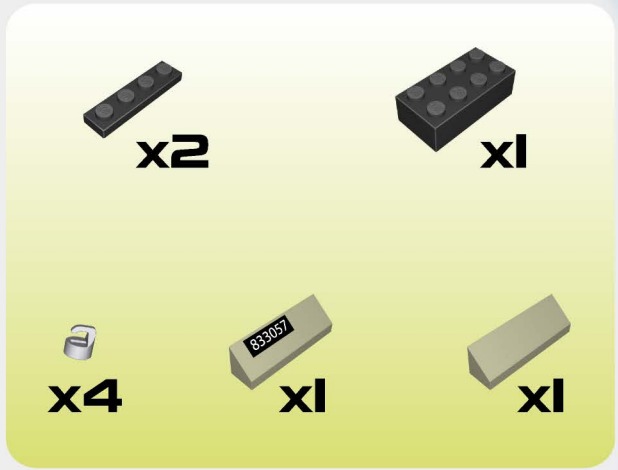
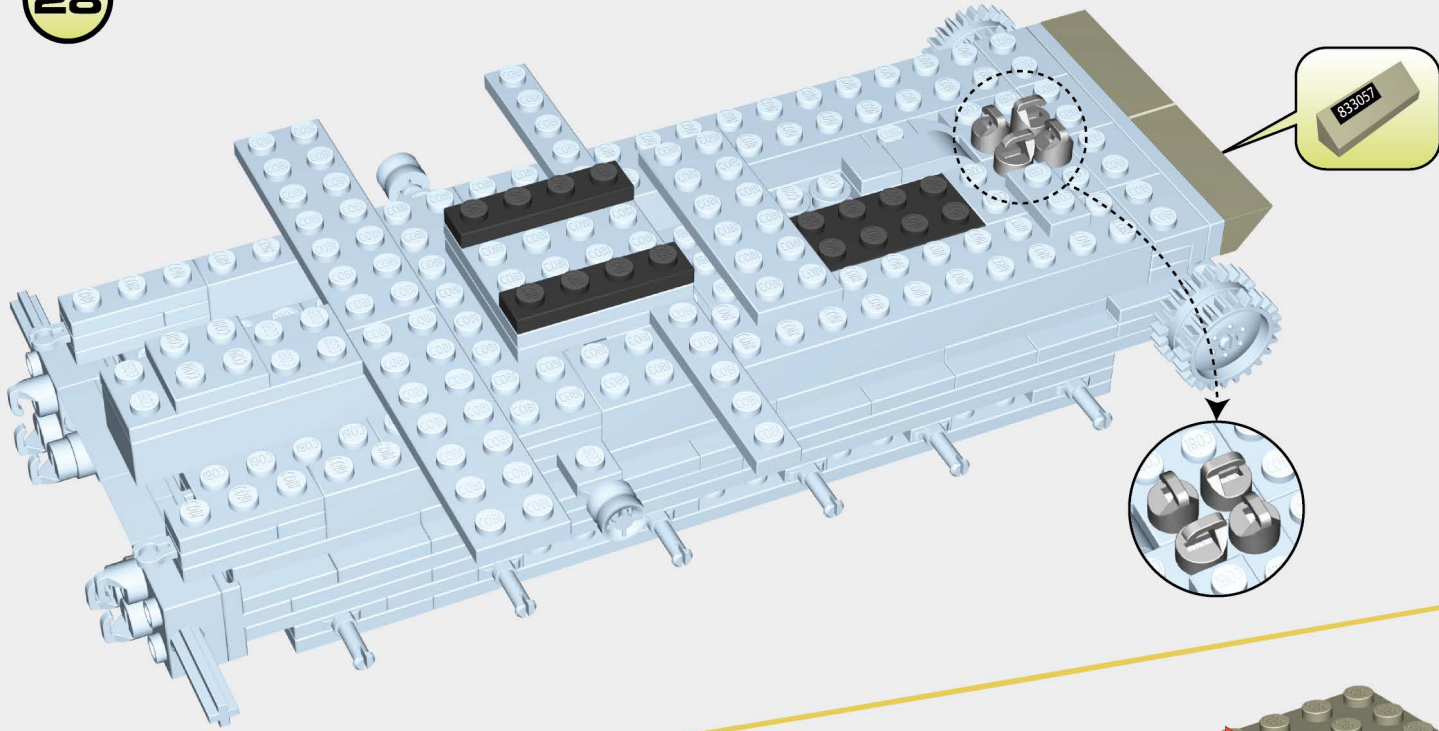

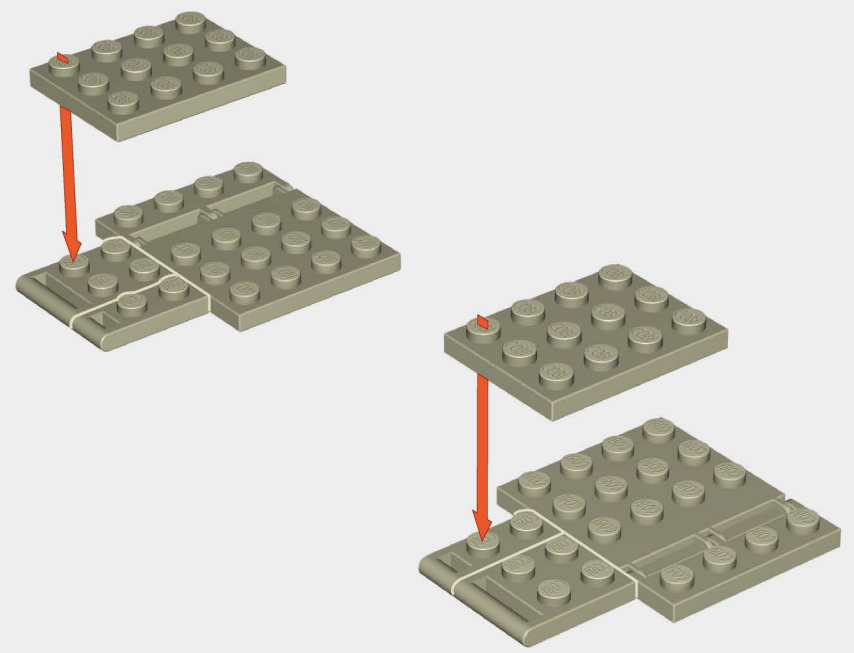
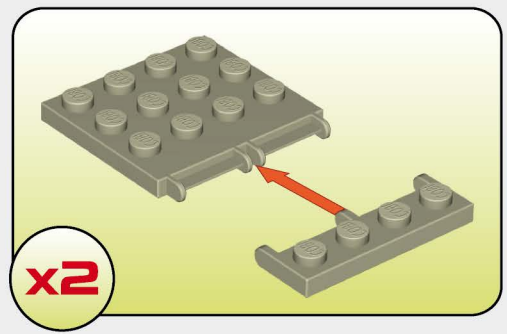
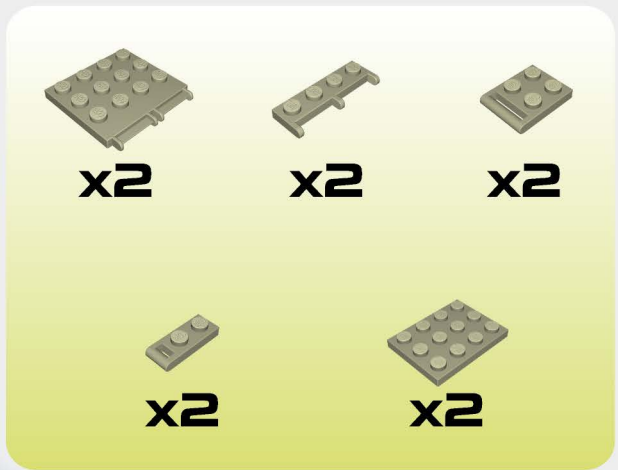

29

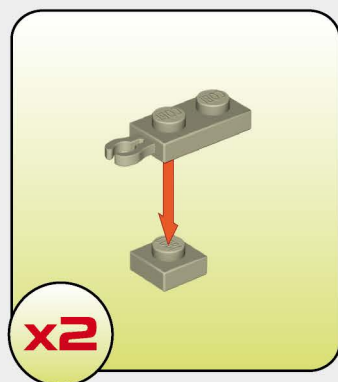
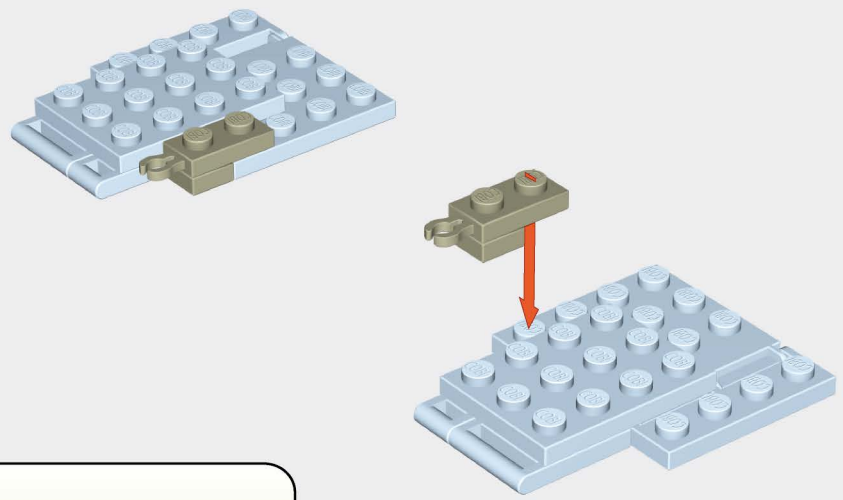

30





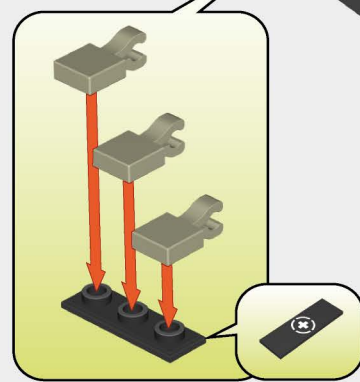
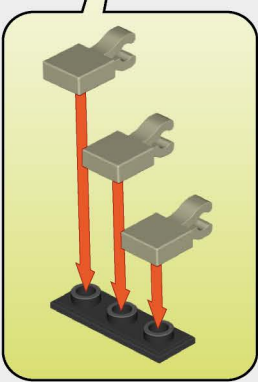
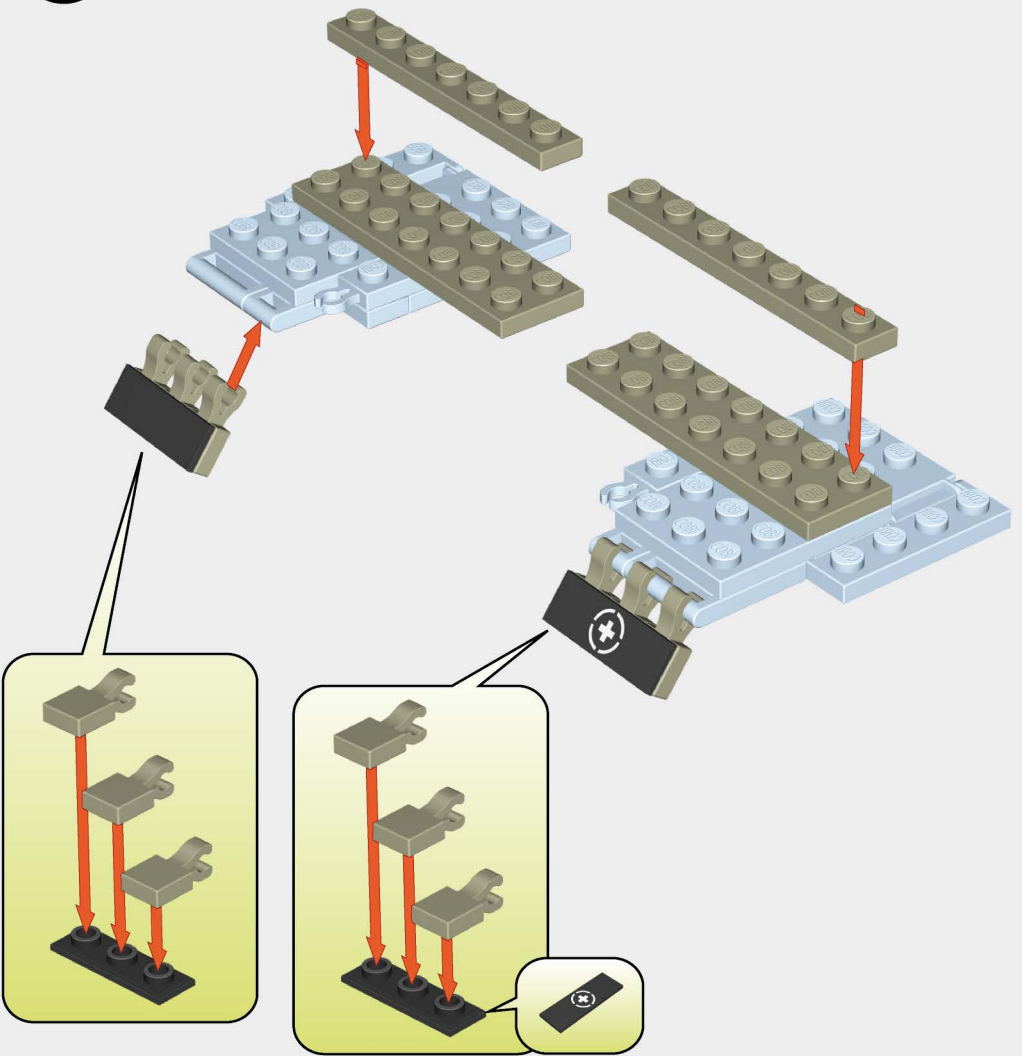

x2

- 
x2
- 
x2

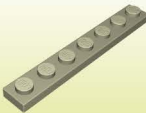
31



- 
x2
- 
x2
- 
x1
- 
x1
- 
x6

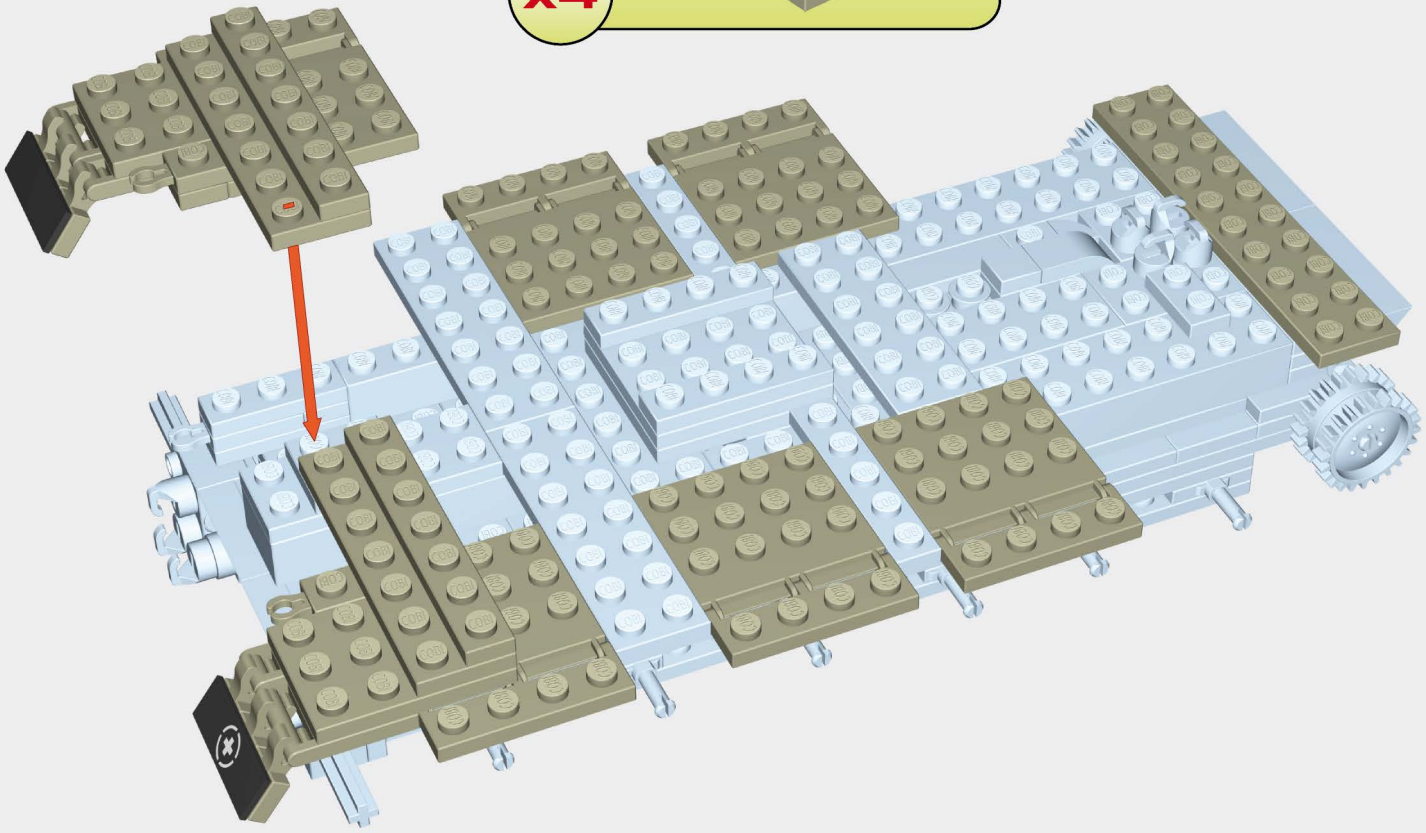
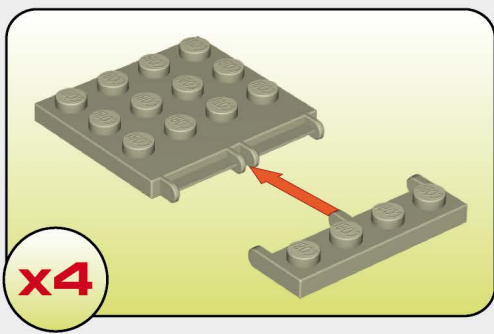

x4





x4



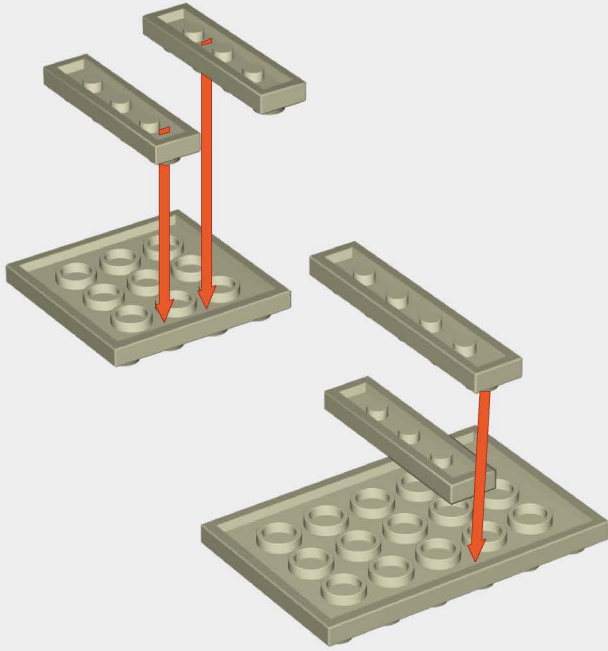

x1

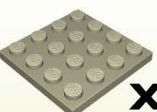
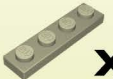
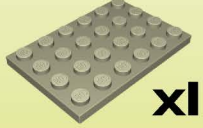
33



-  x1
-  x3
-  x1
-  x1

34

-  x2
-  x2
-  x1

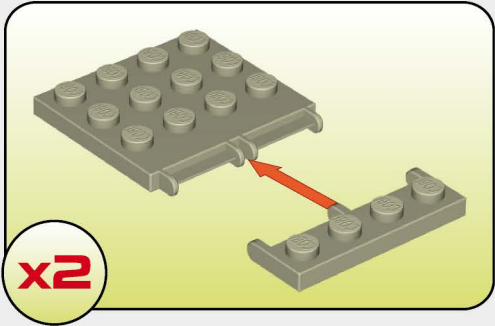
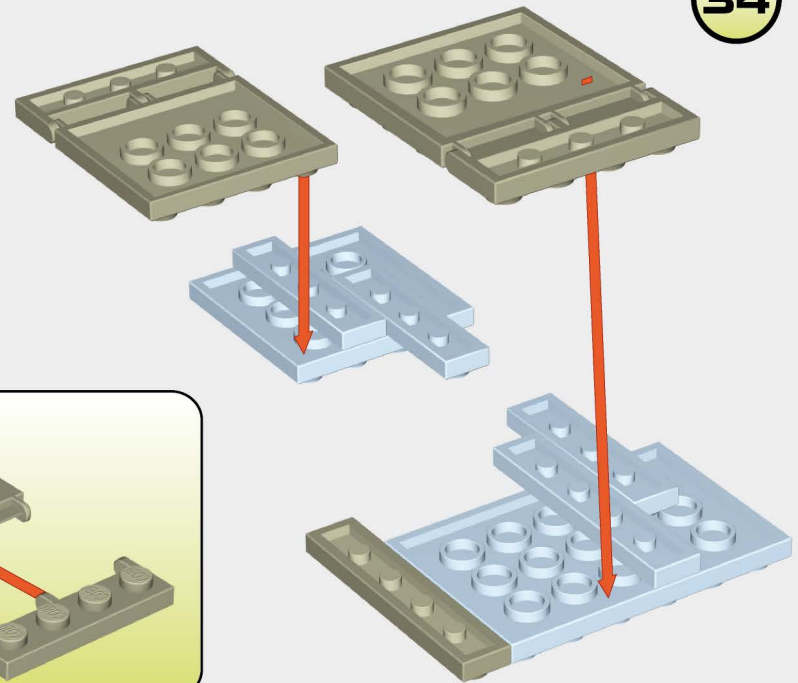

x2

35

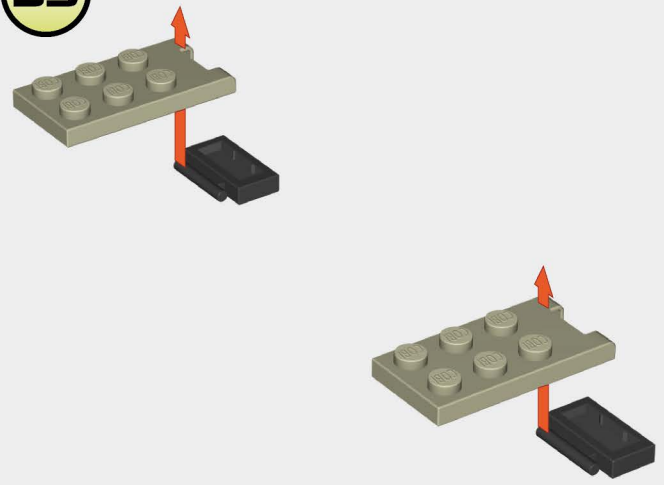

-  x2
-  x2

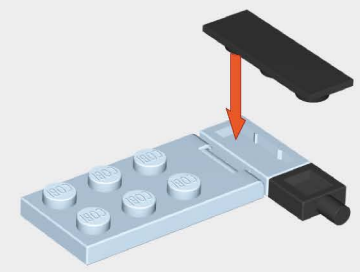
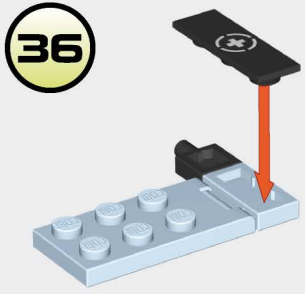

36

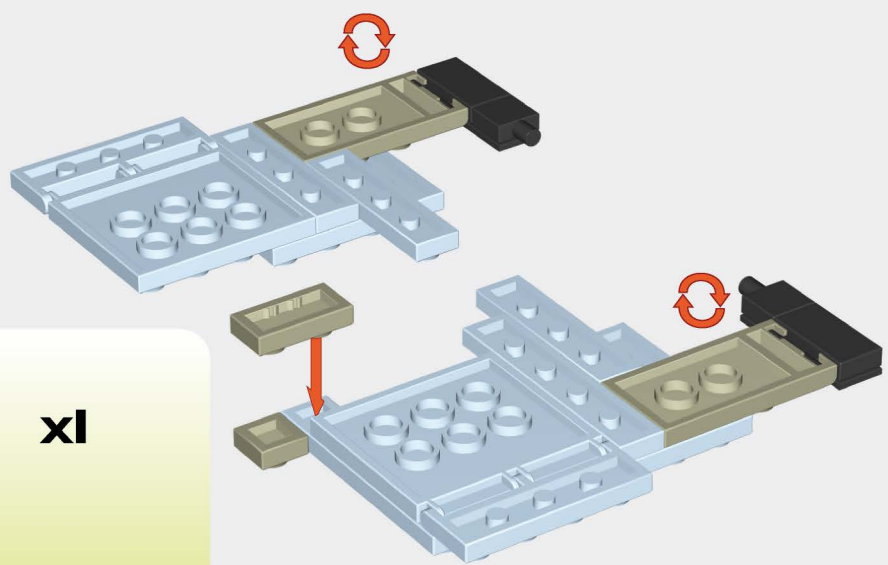

-  x2
-  x1
-  x1

37



-  **x1**
-  **x1**

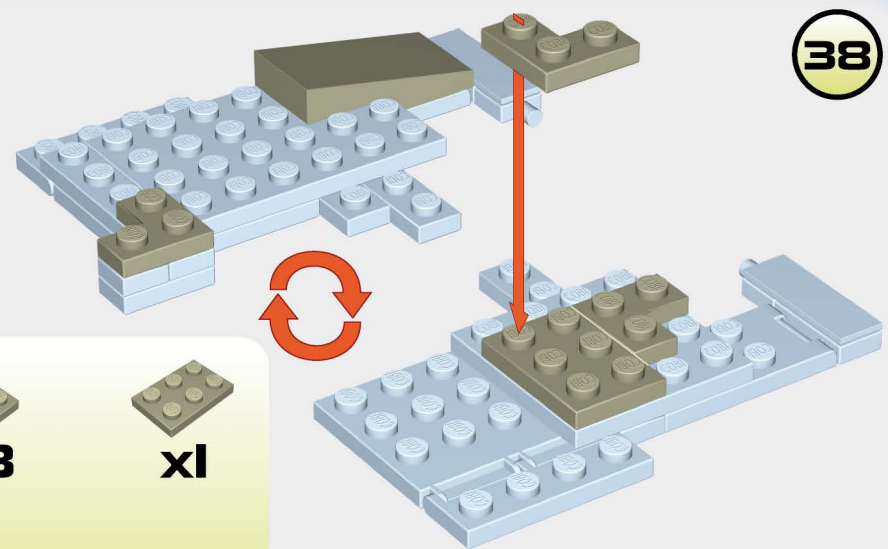

38

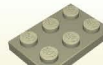
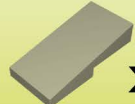

-  **x3**
-  **x1**
-  **x1**

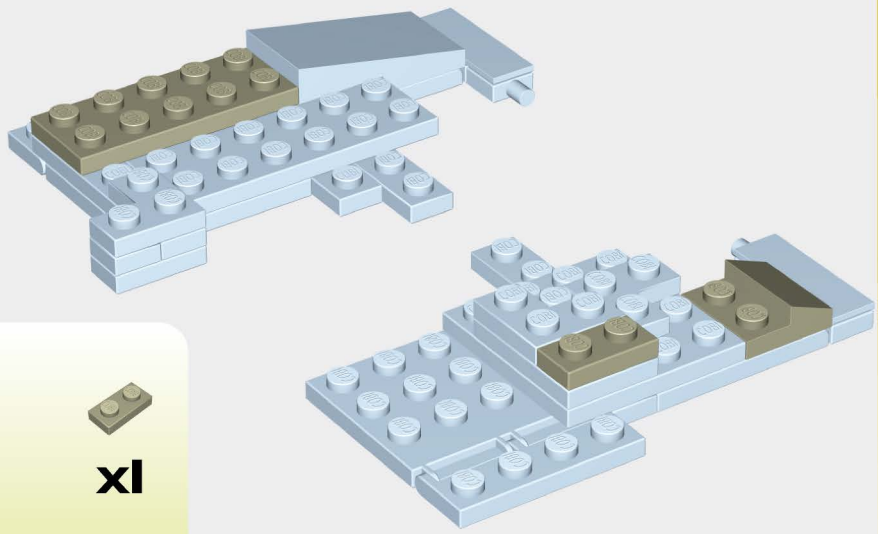

39

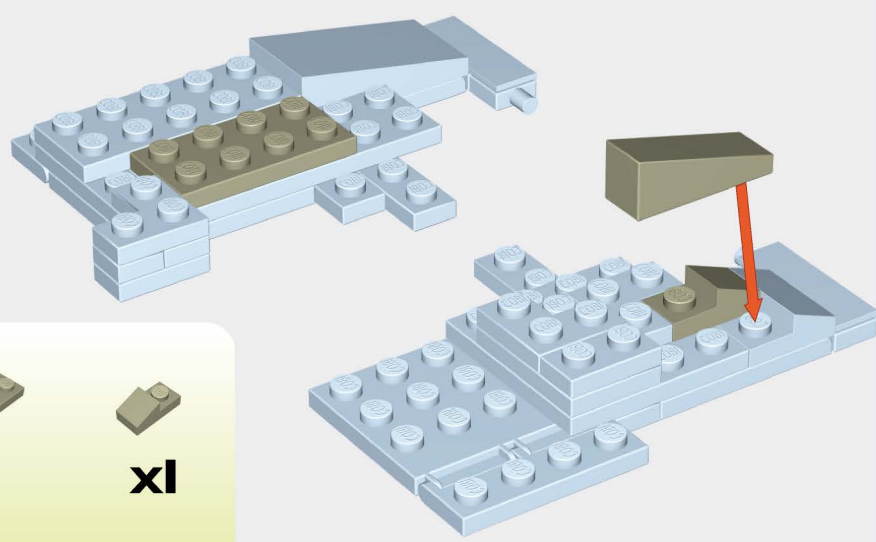

-  **x1**
-  **x1**
-  **x1**

40



-  **x1**
-  **x1**
-  **x1**

41

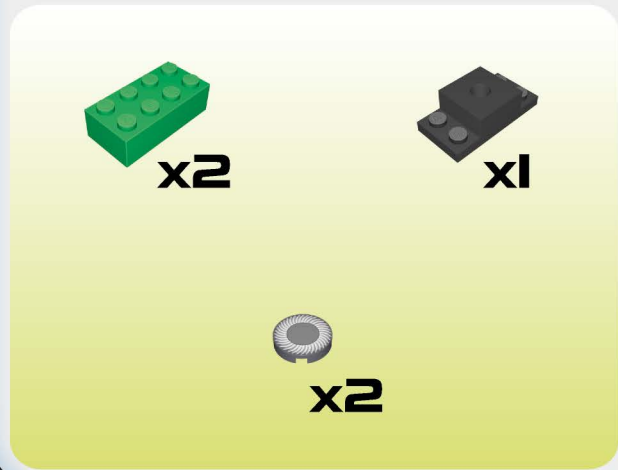
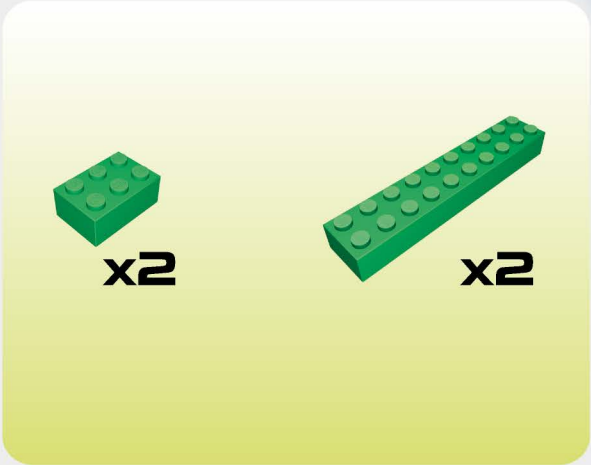
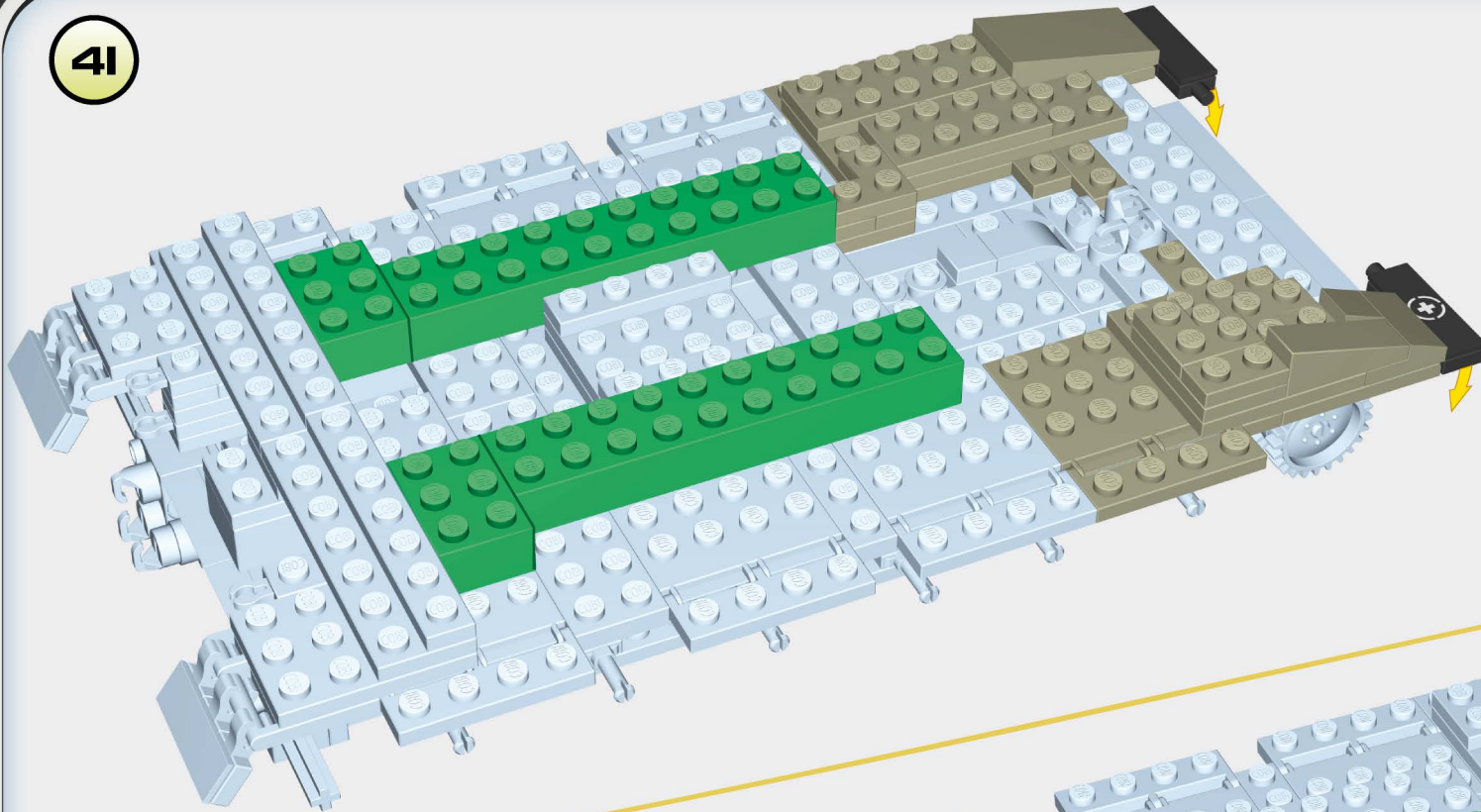

42

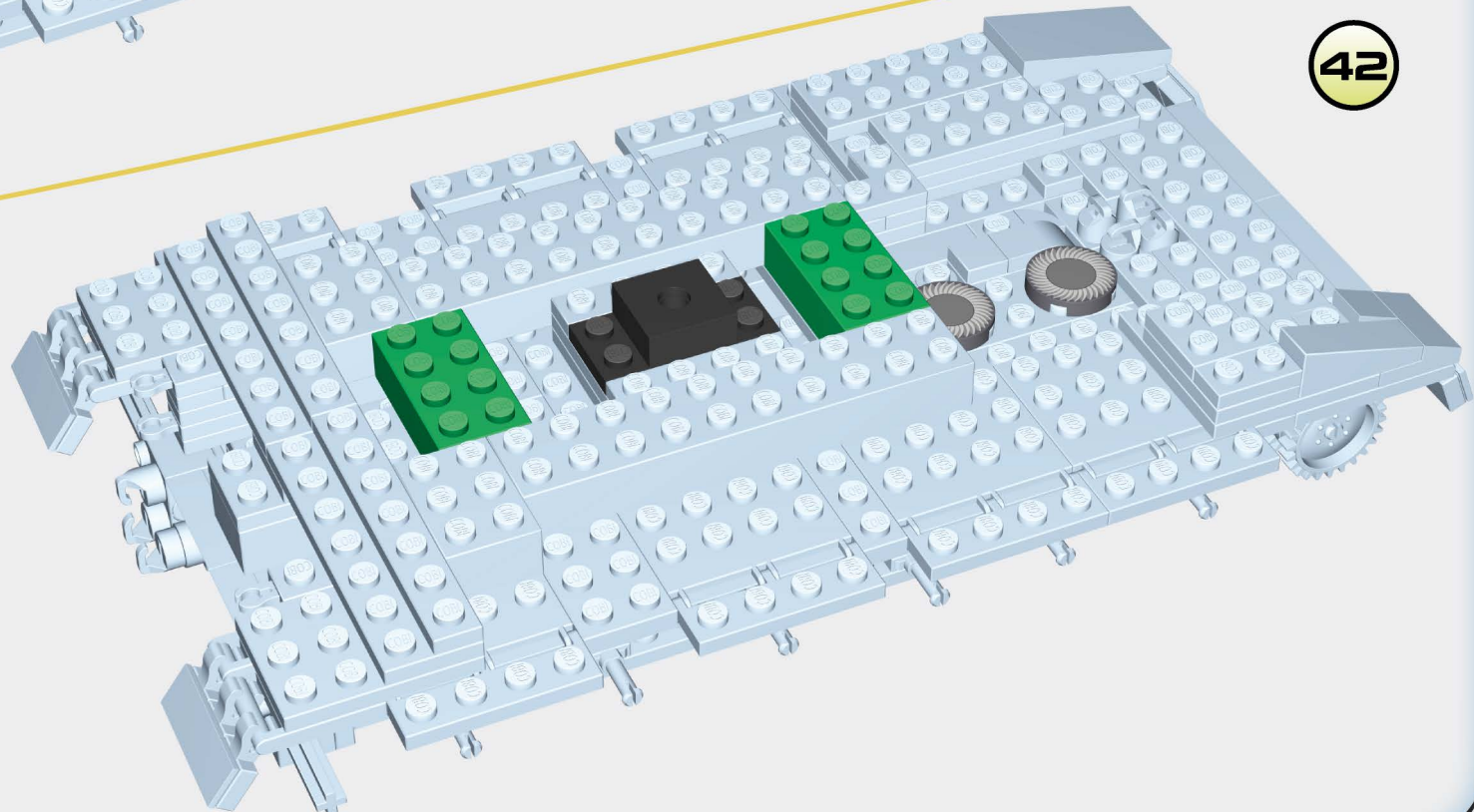





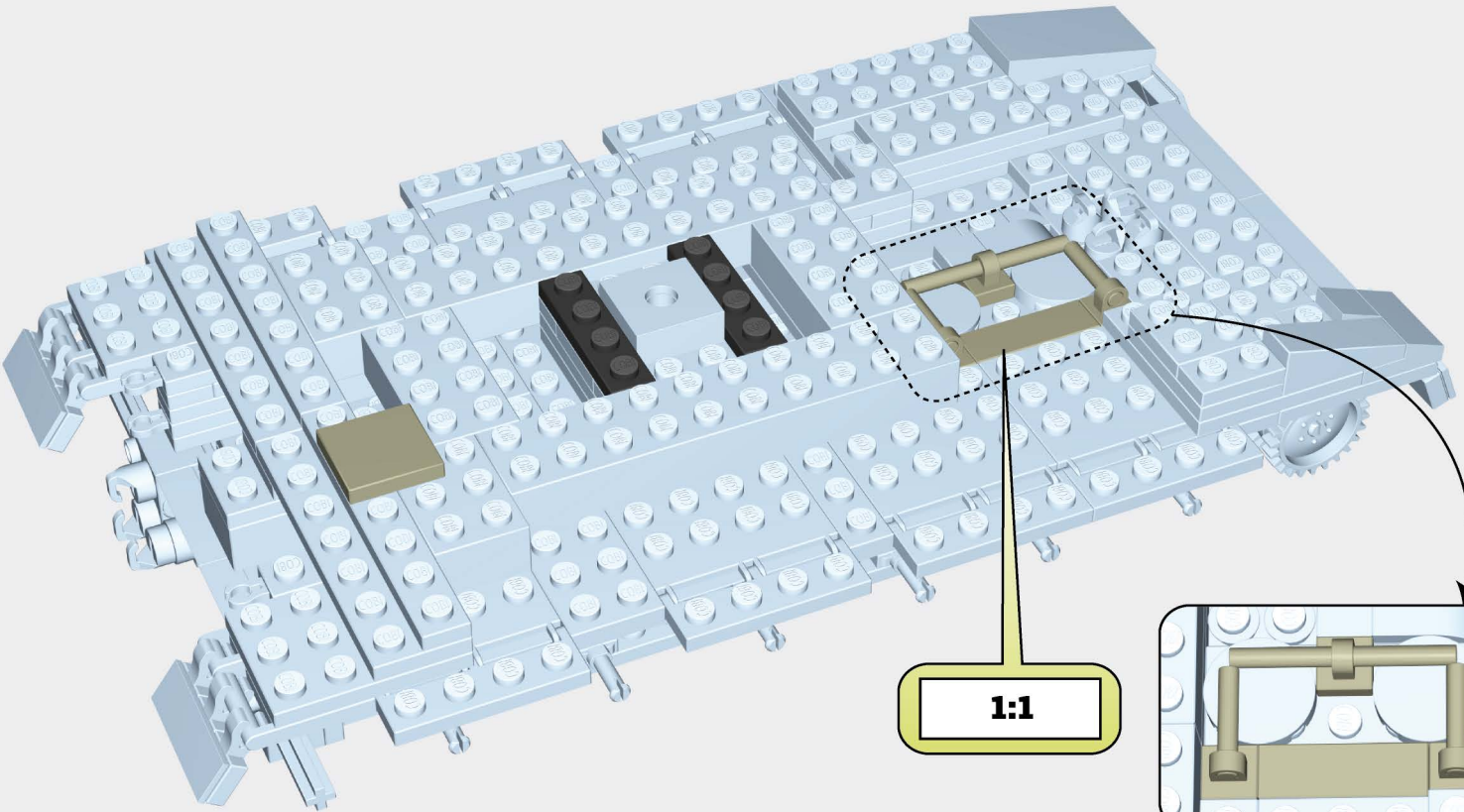
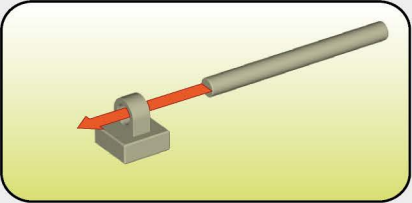
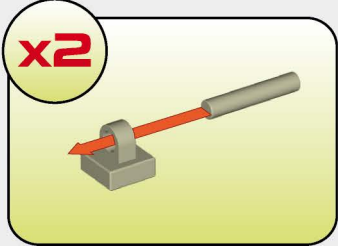

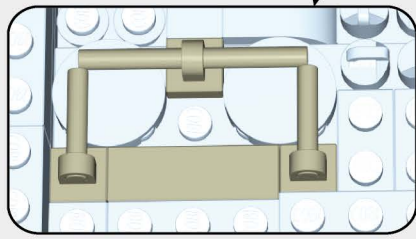

43



1:1



-  x1
-  x2
-  x1
-  x3
-  x2
-  x1

44

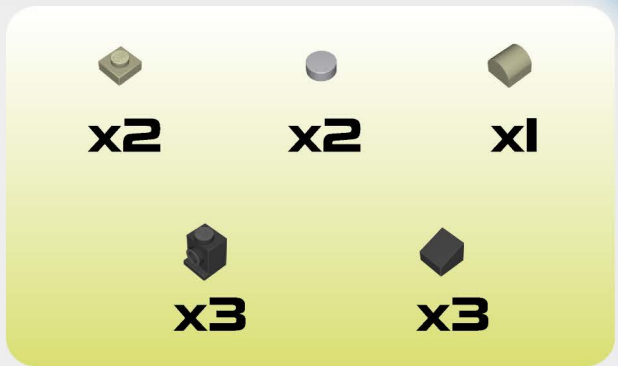
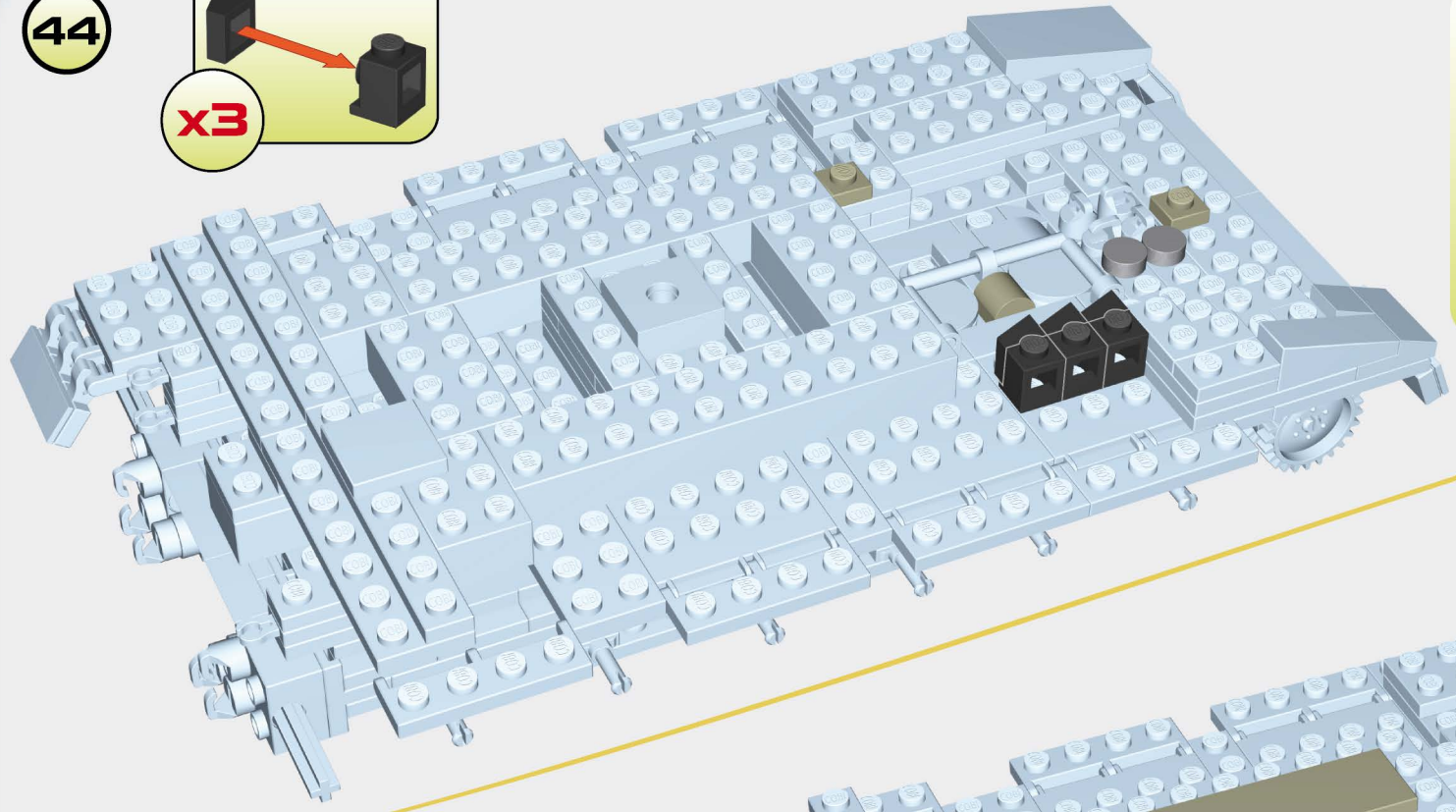
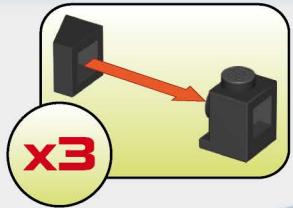



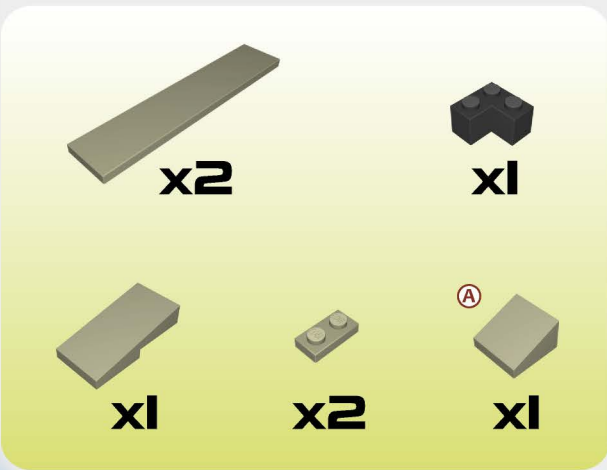
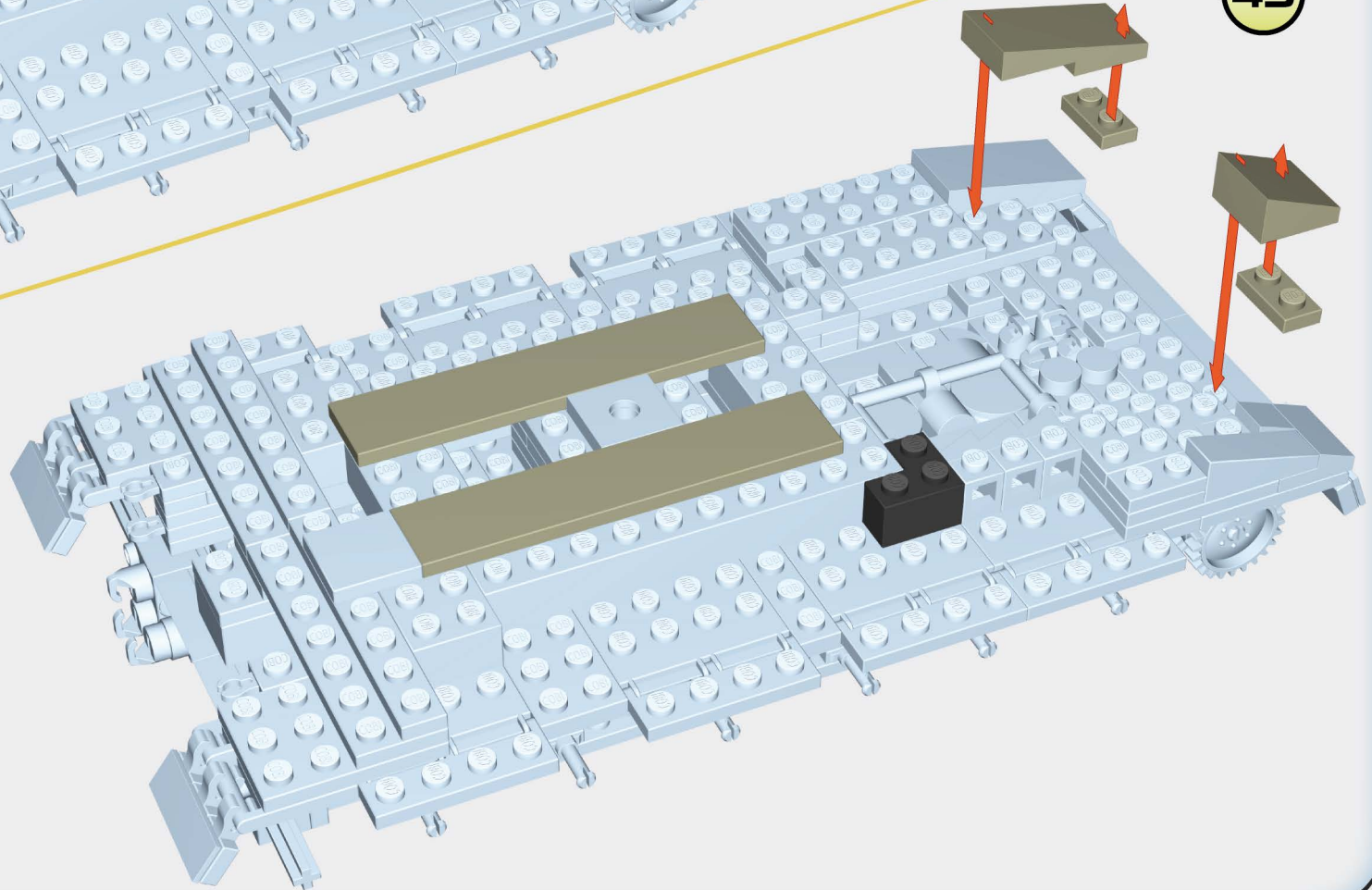

45

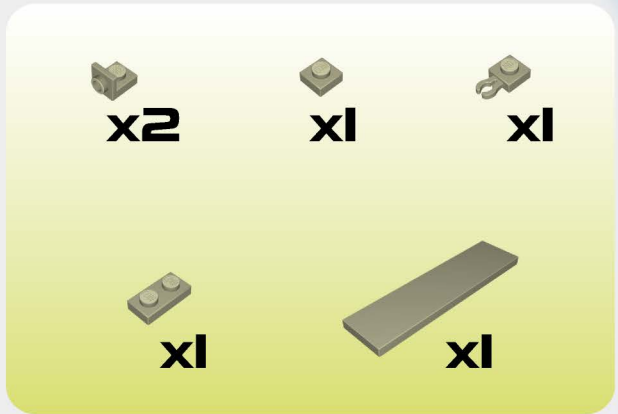
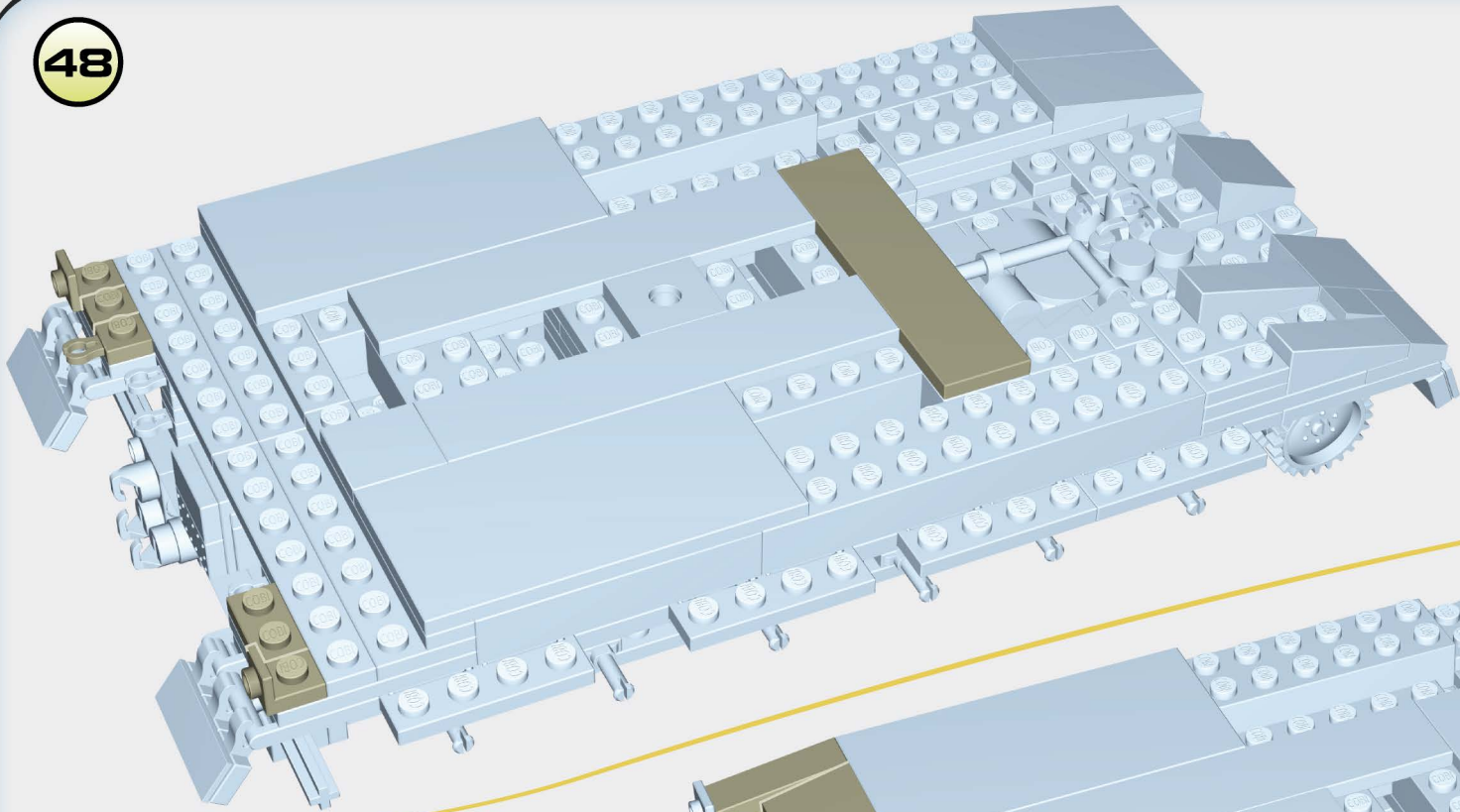

48



- Ⓓ  x2
- Ⓑ  x6
-  x2
-  x2
-  x1

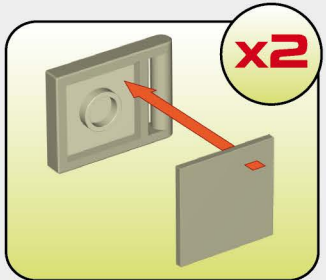

49

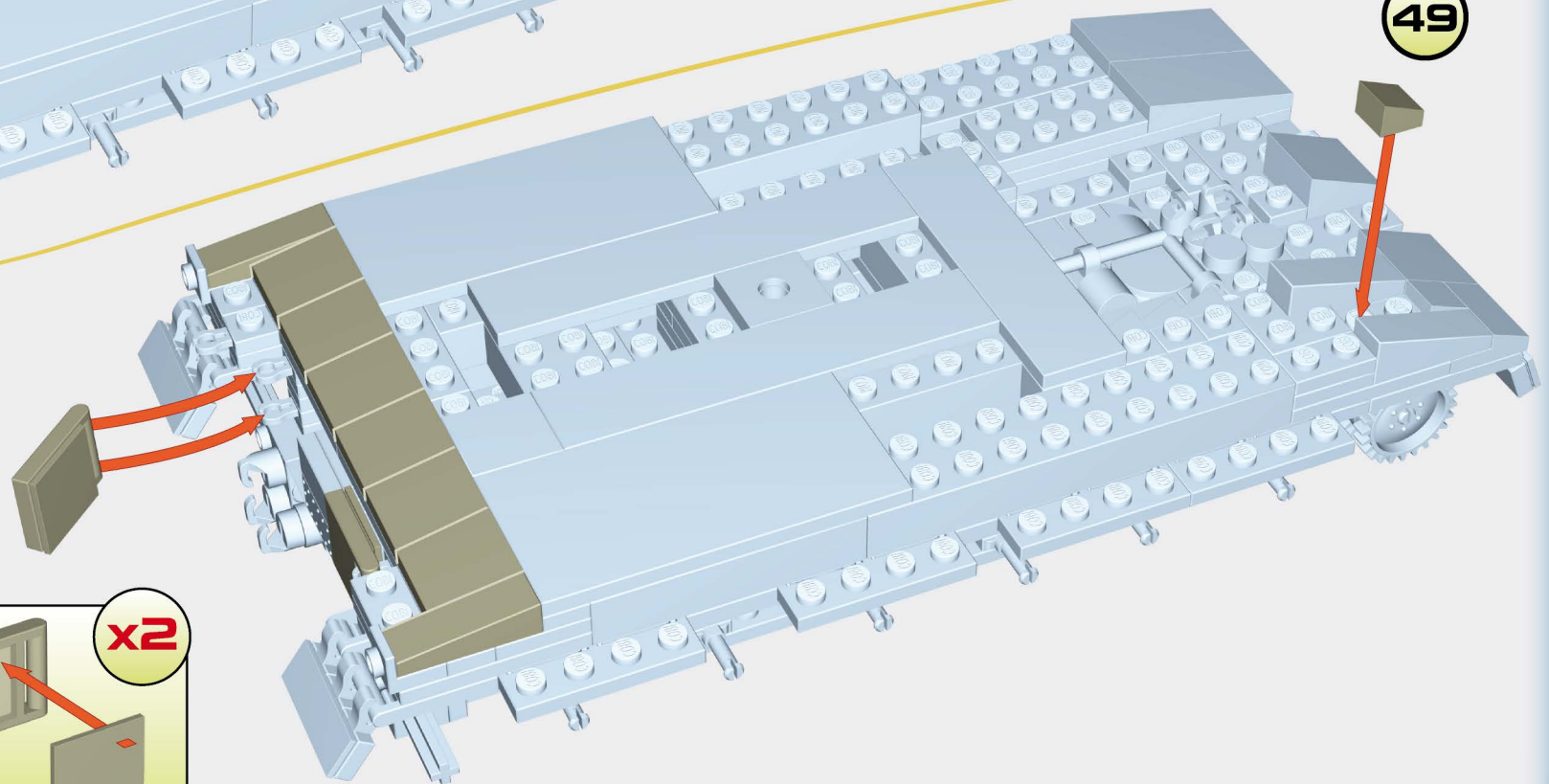

50

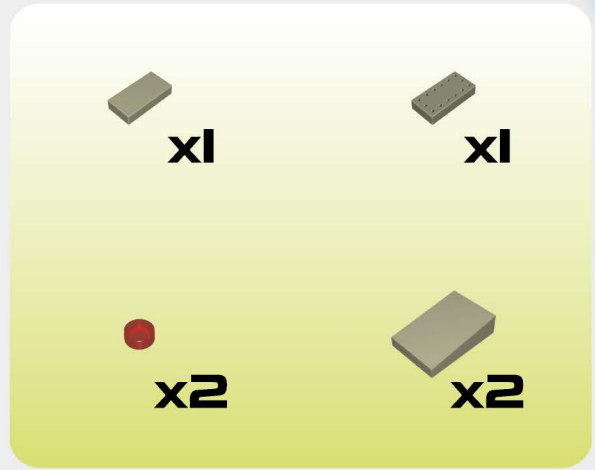
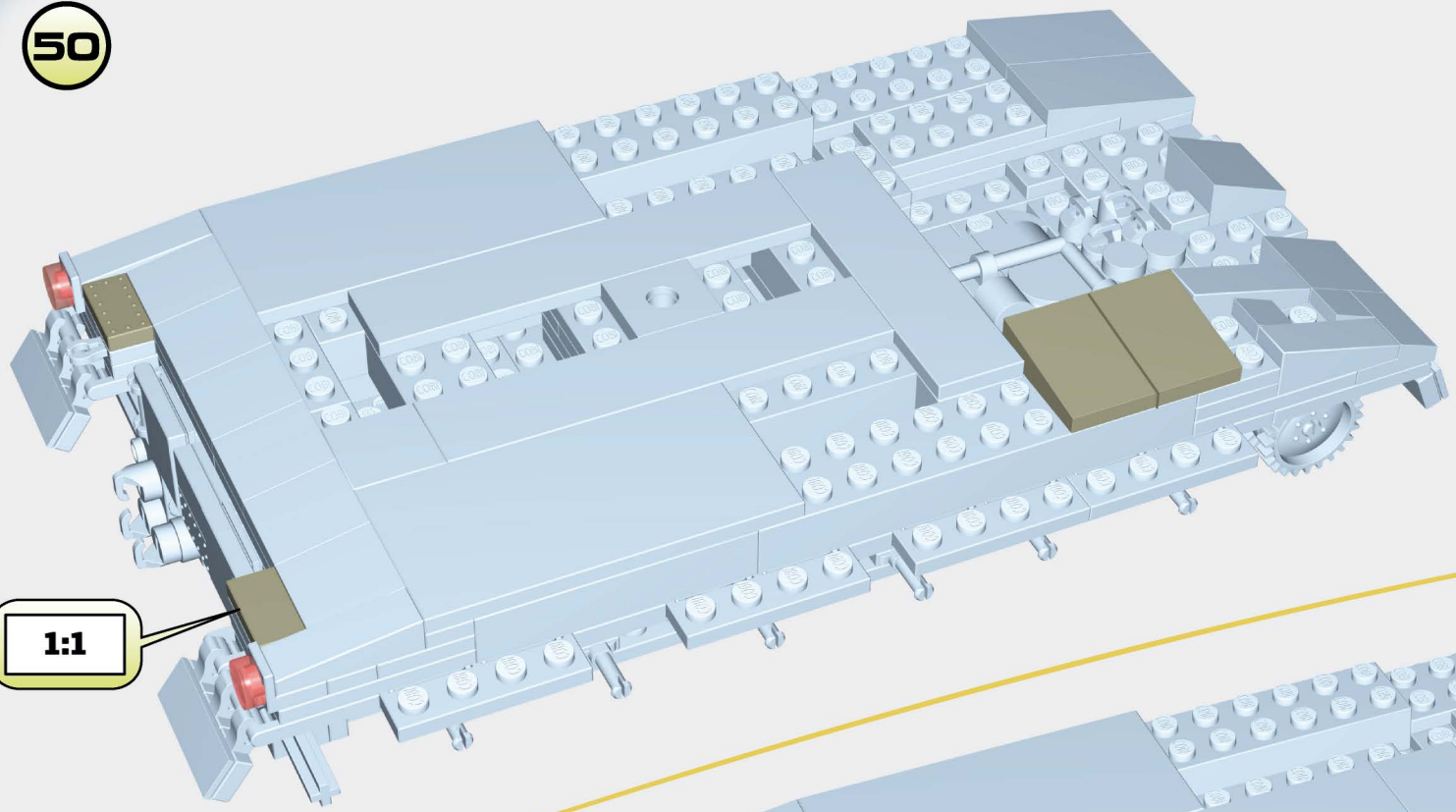

1:1

51

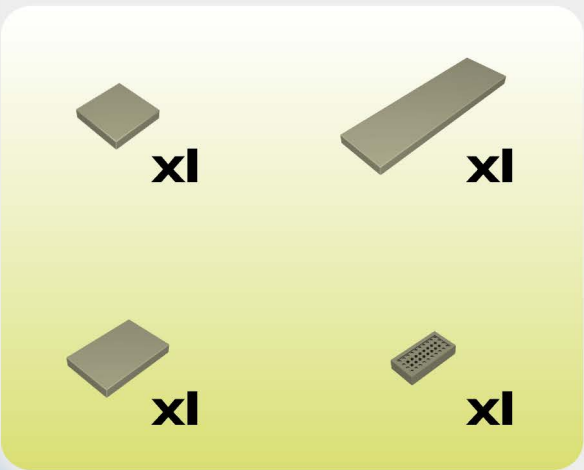
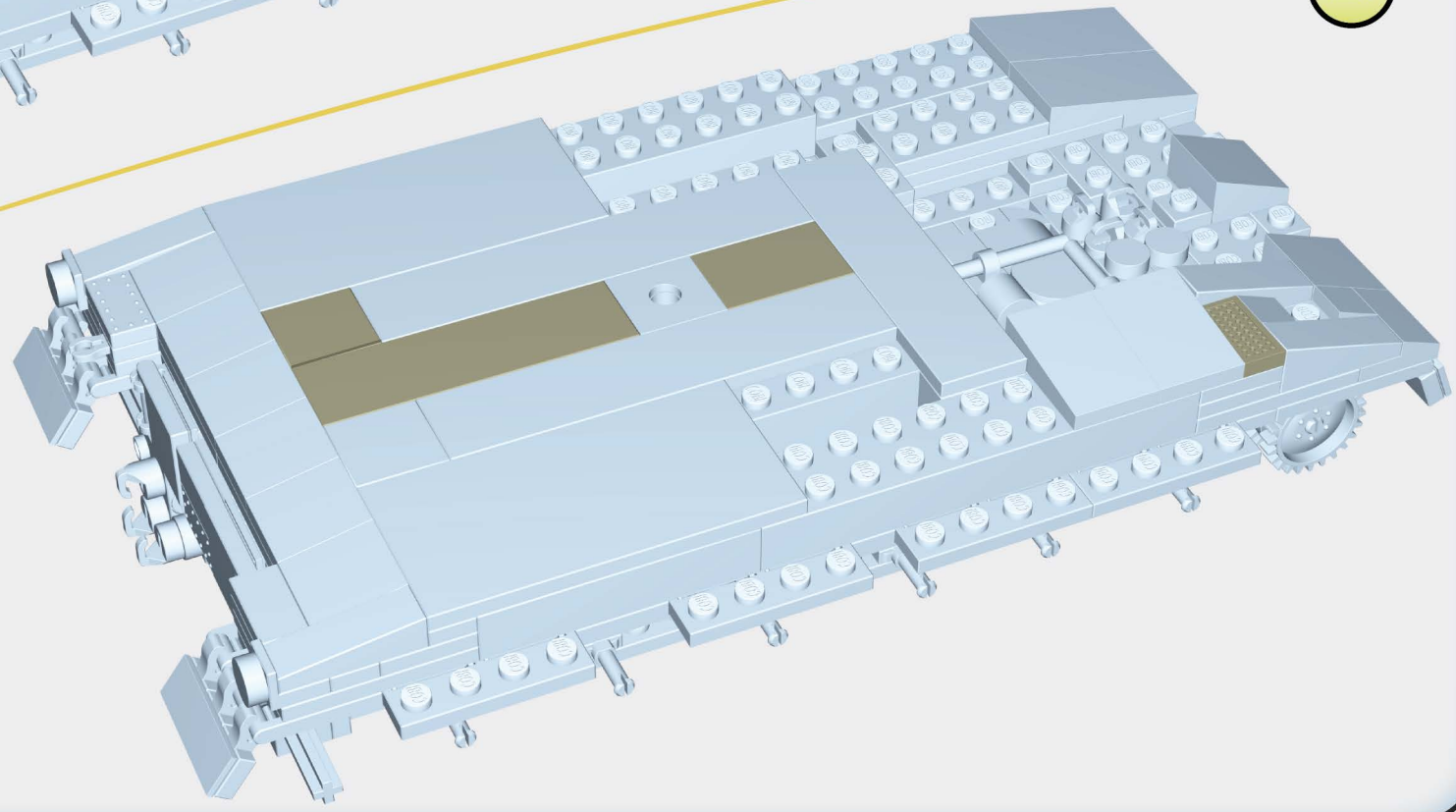

52

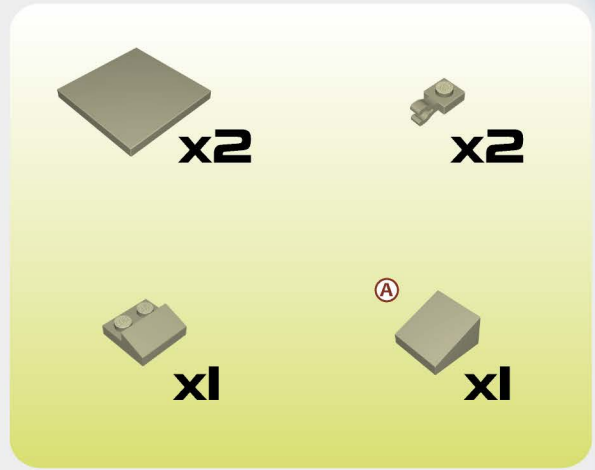
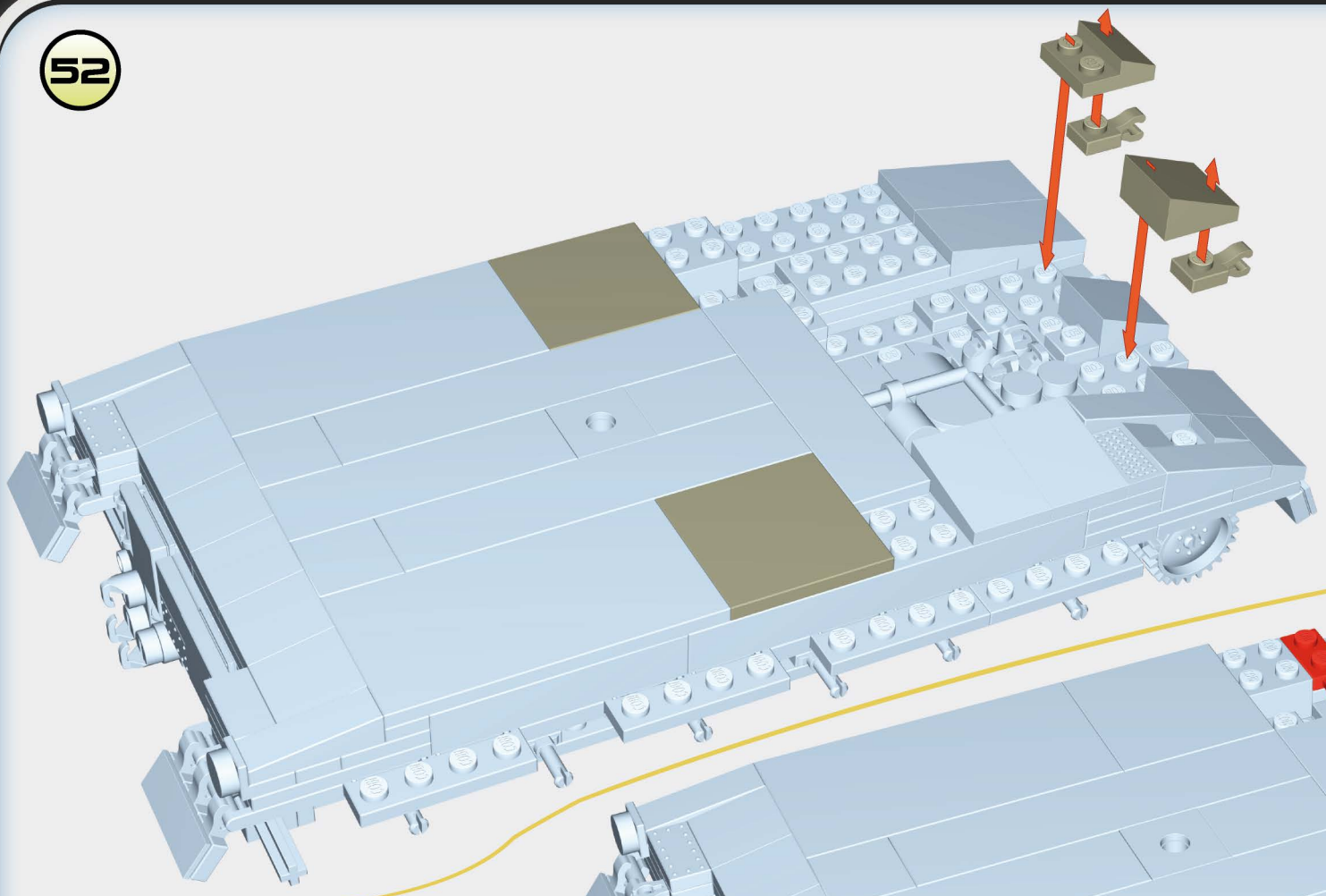

53

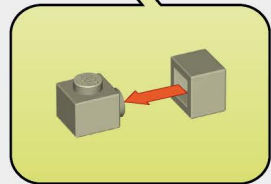
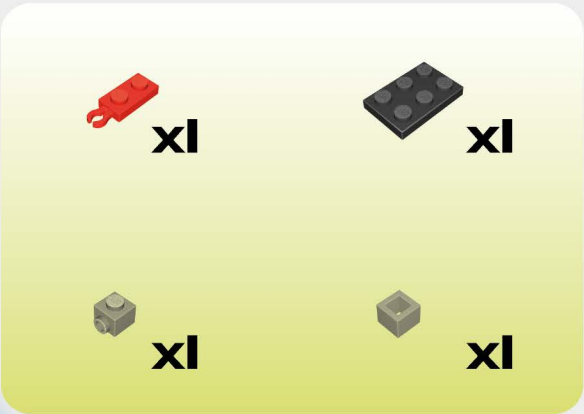
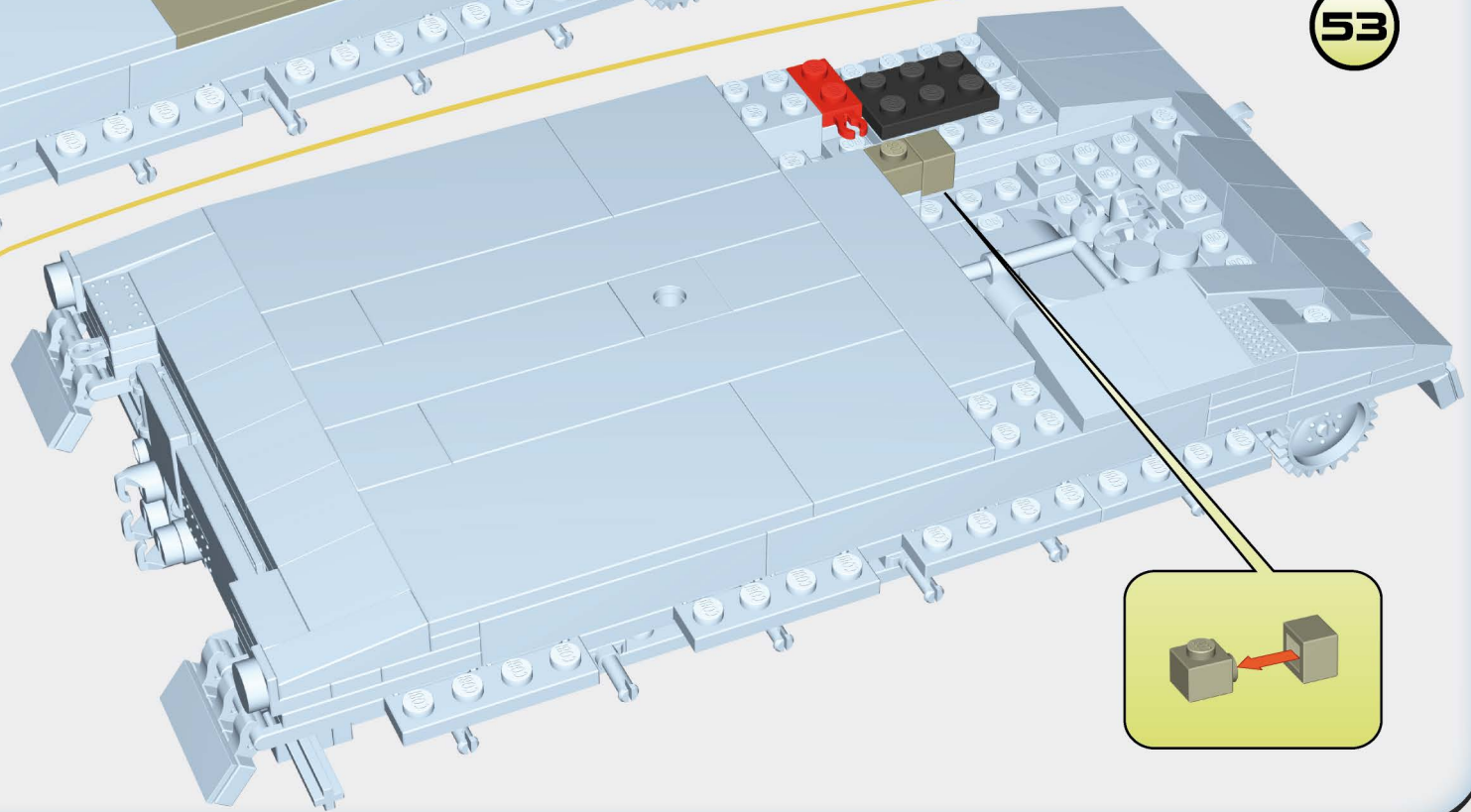

54



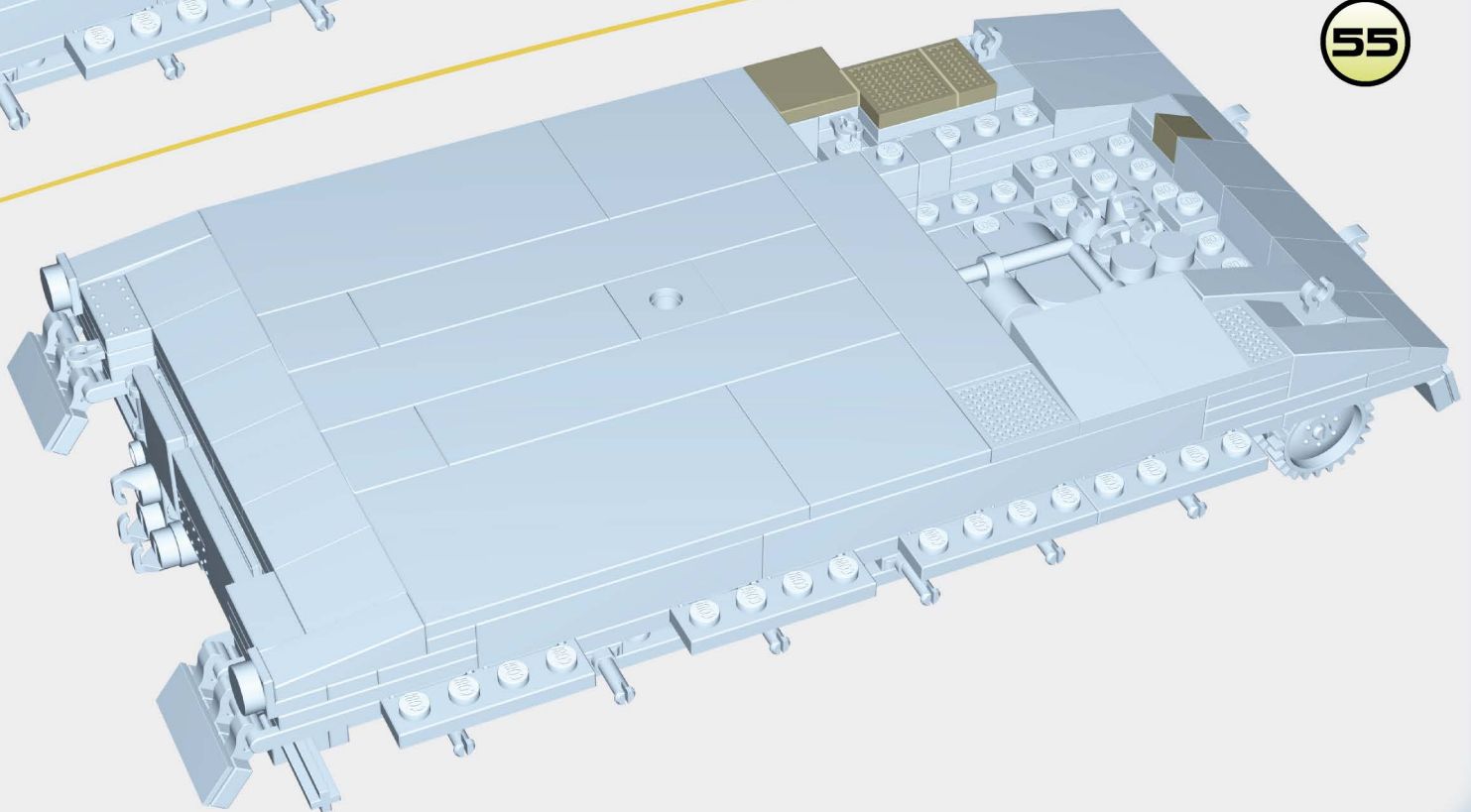
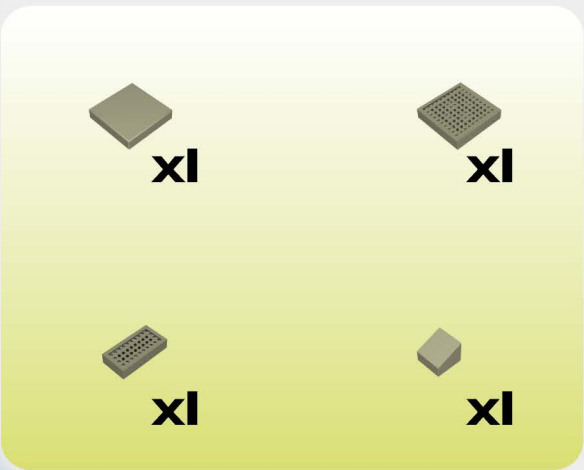
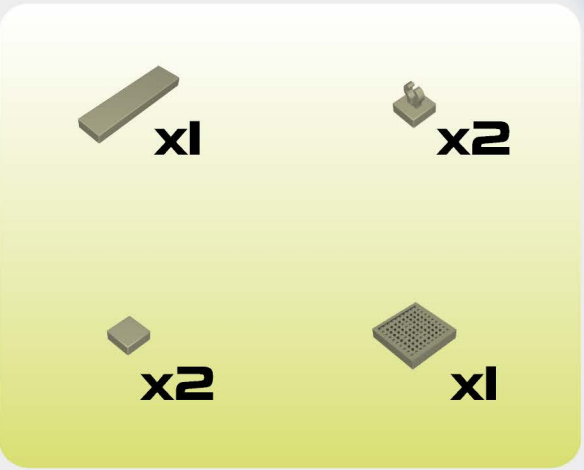
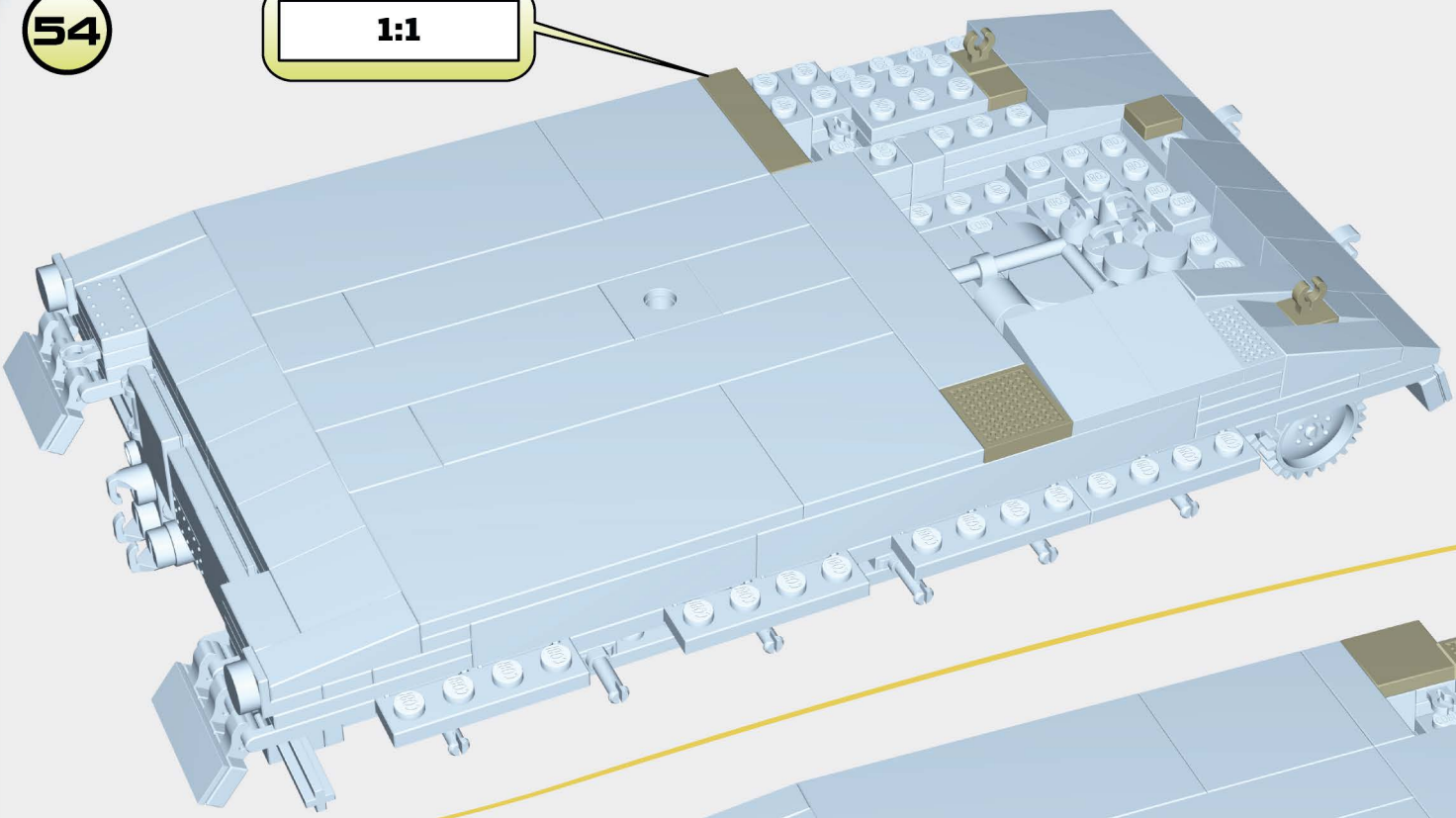

1:1

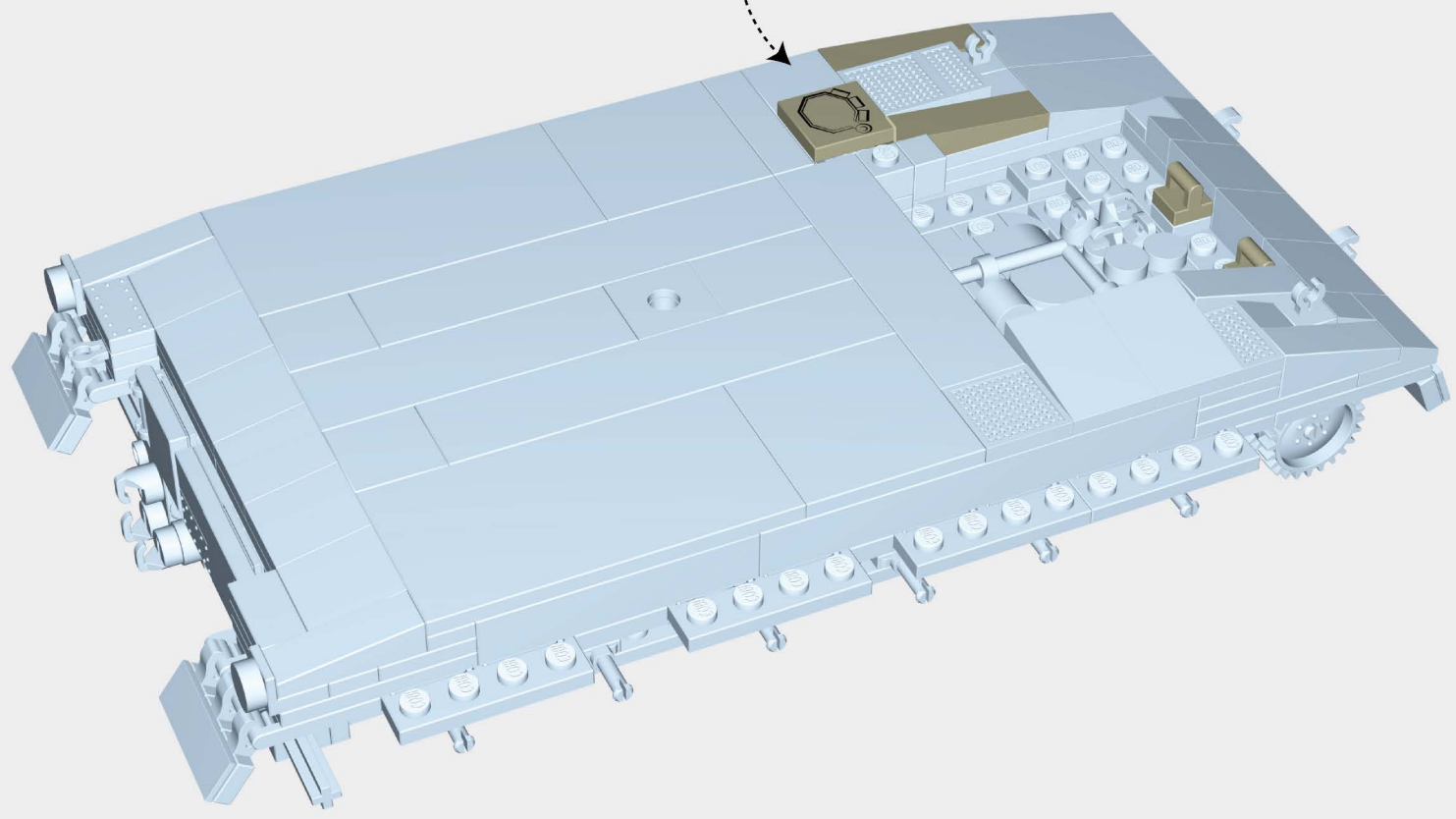
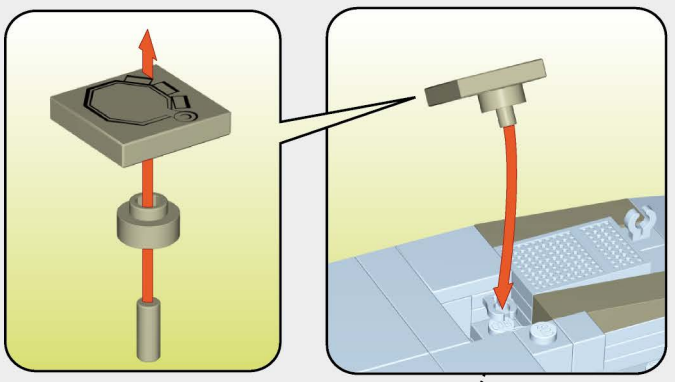

55

56



-  x1
-  x1
-  x1
-  x2
-  x2

57

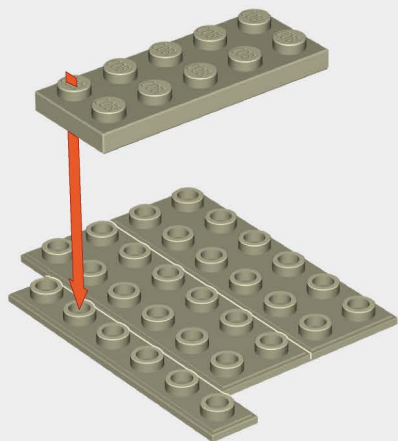

x1



x2

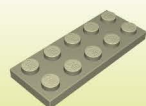

x1

58

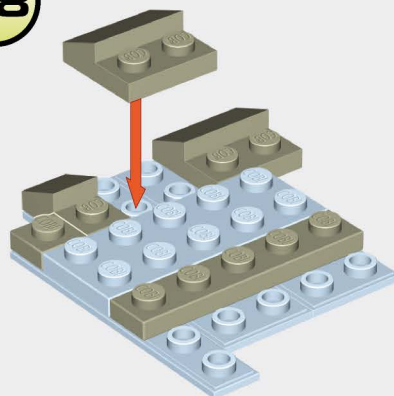

x1



x1



x2



x1

59

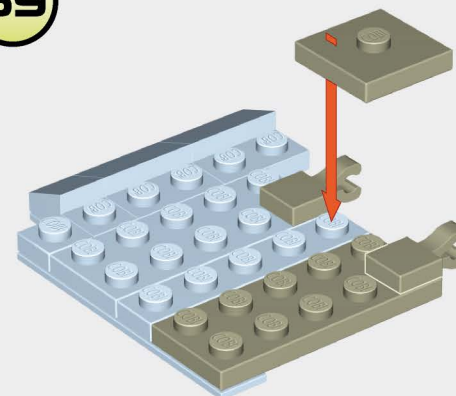

x1



x2



x1

60

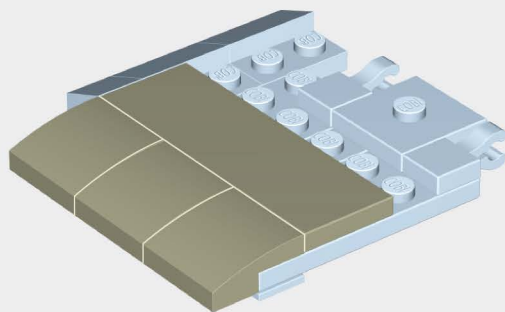

x3

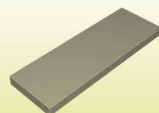

x1

61

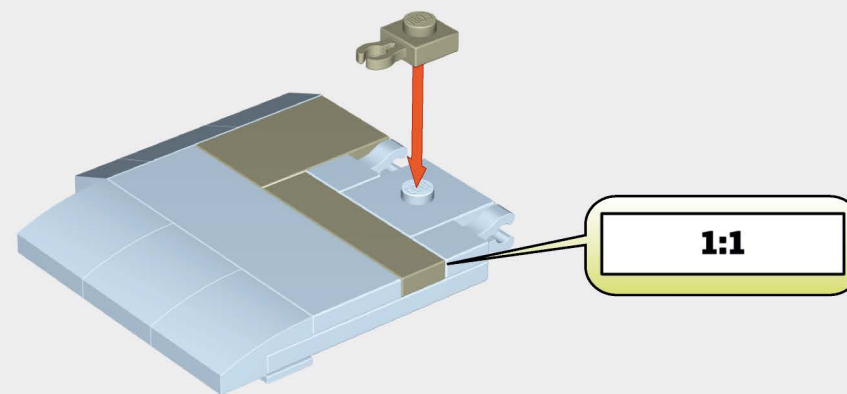

1:1



x1



x1



x1

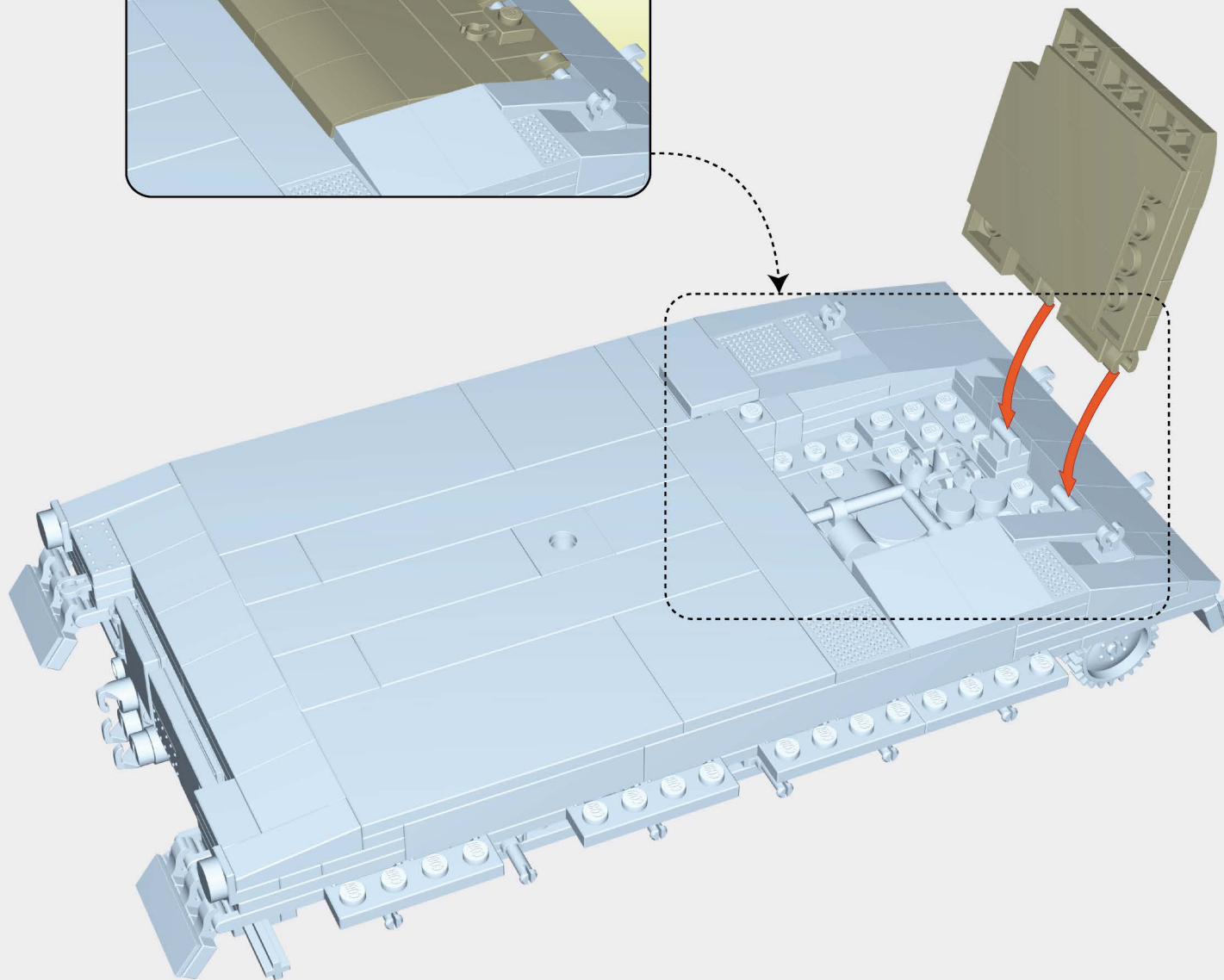
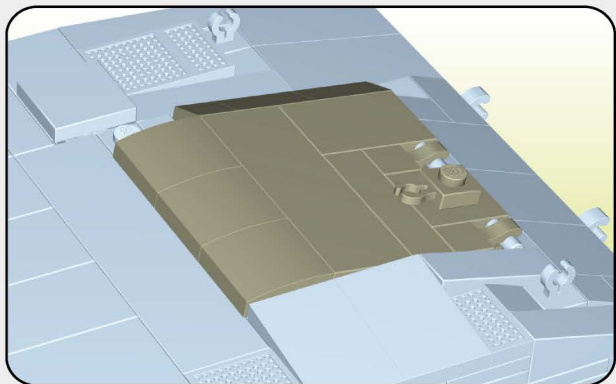

63

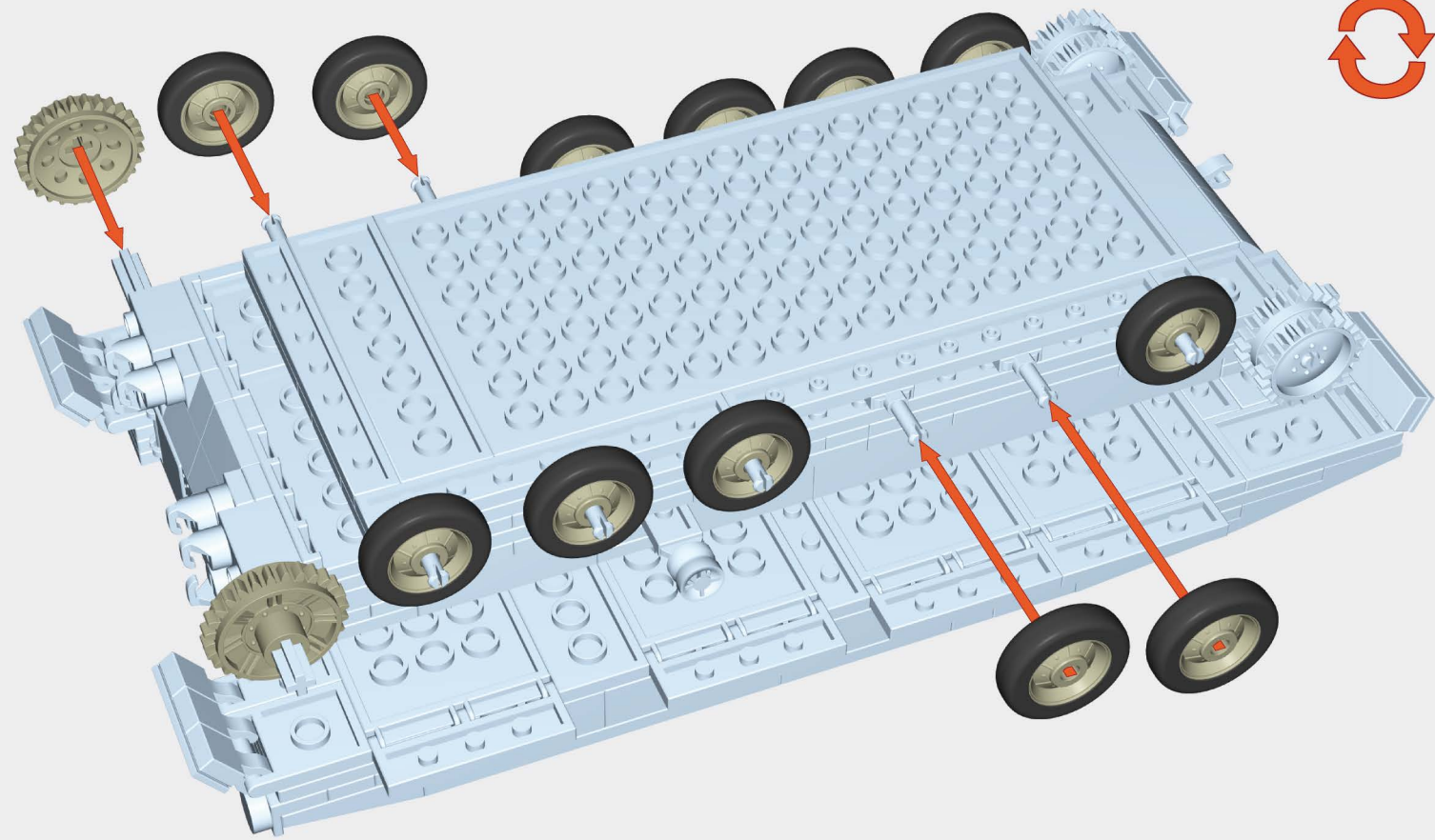
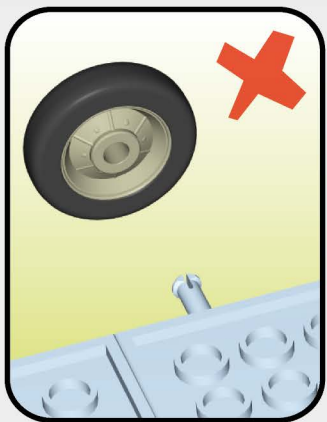
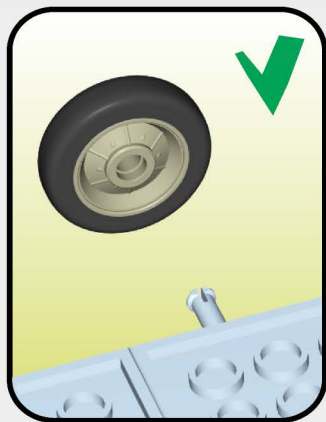

-  x2
-  x12
-  x12

64

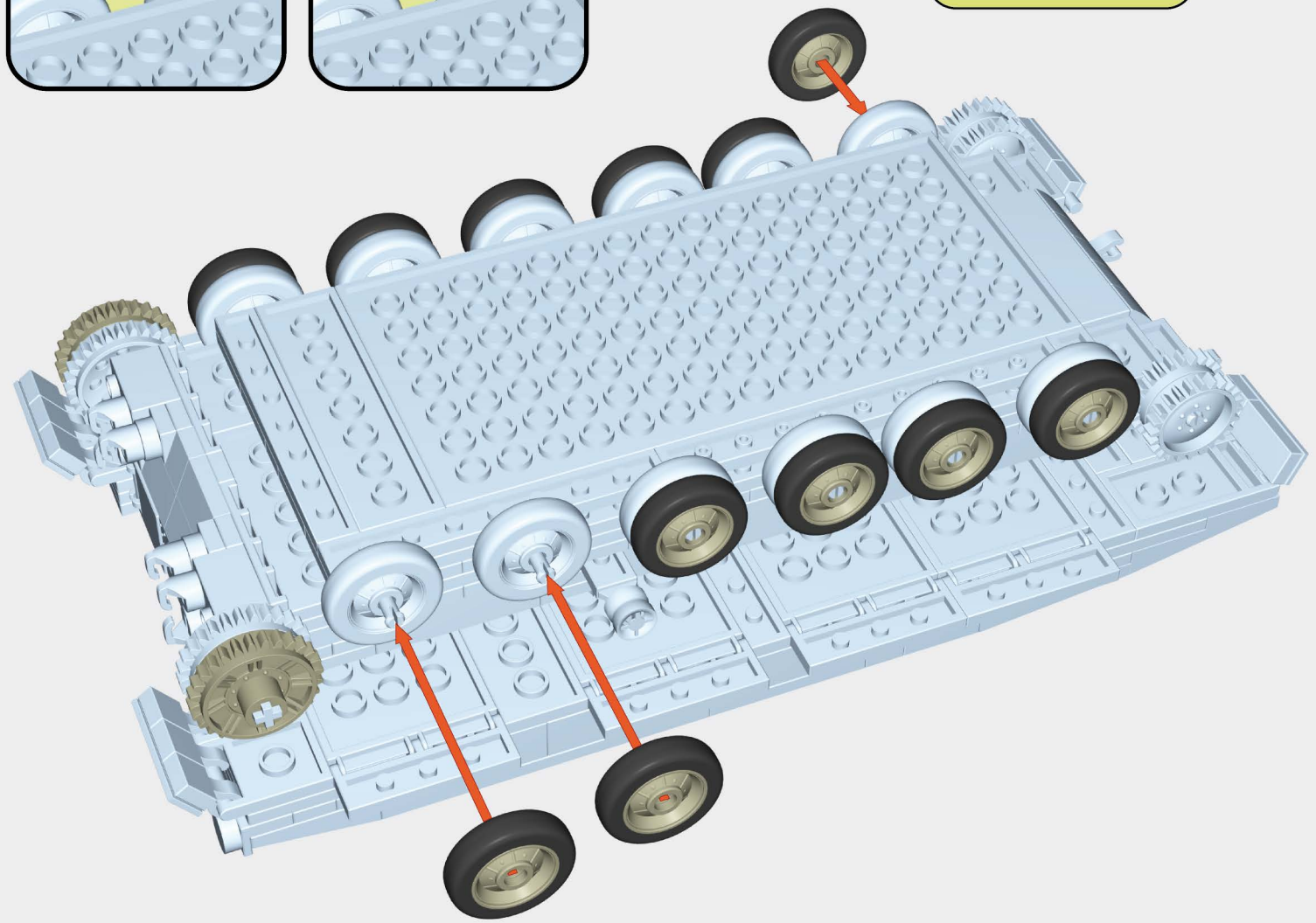
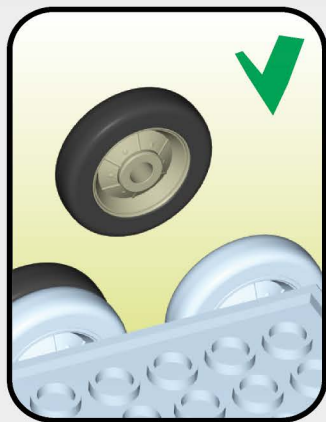

-  x2
-  x12
-  x12

65

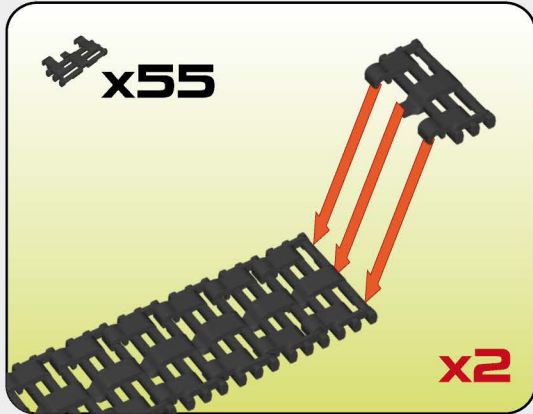
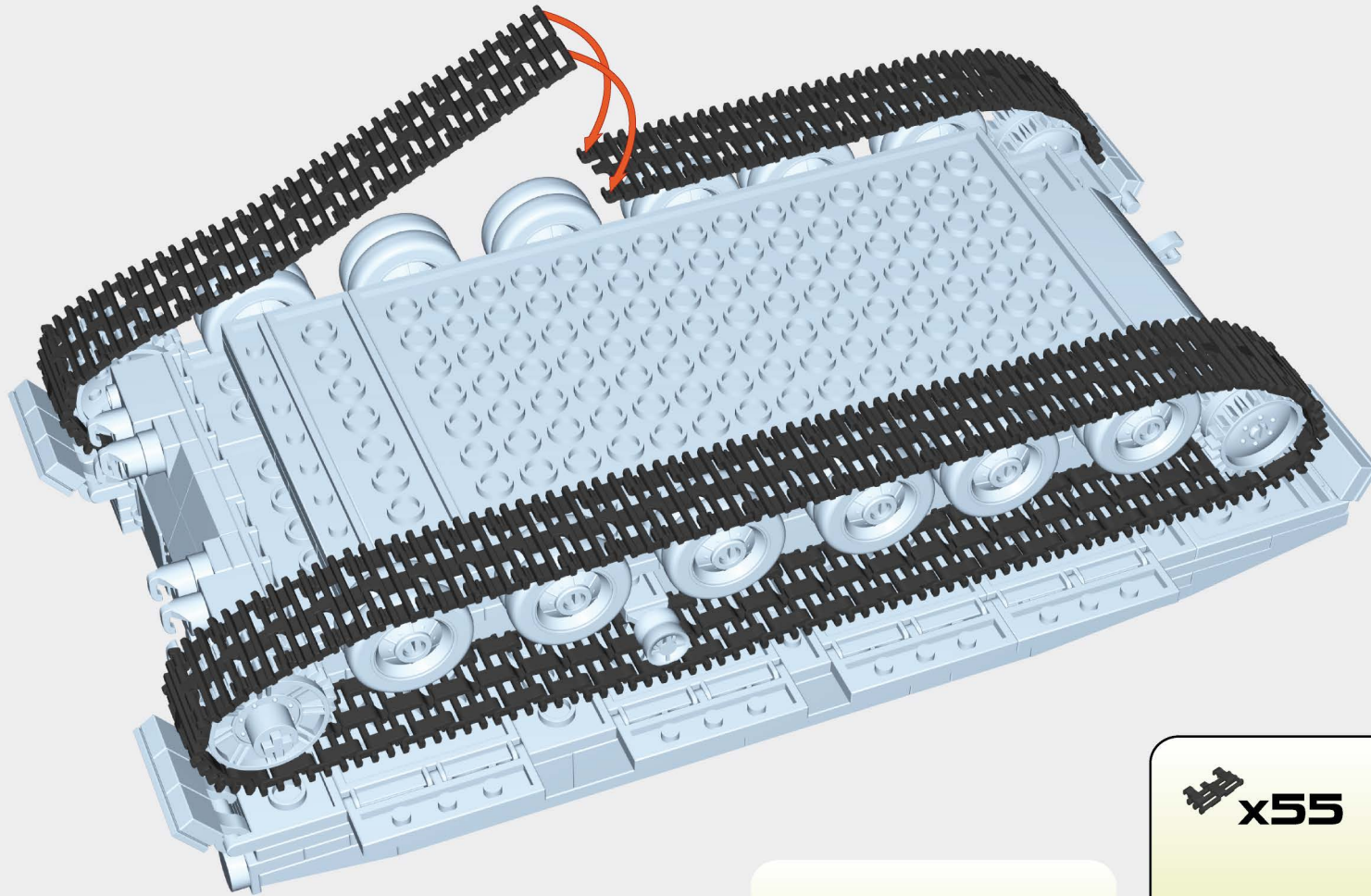



66

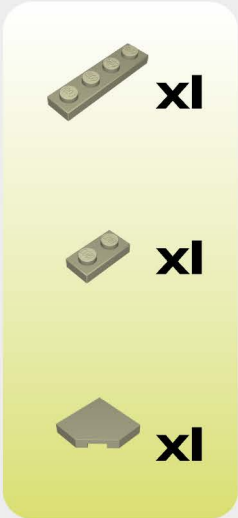
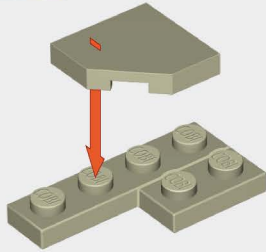

67

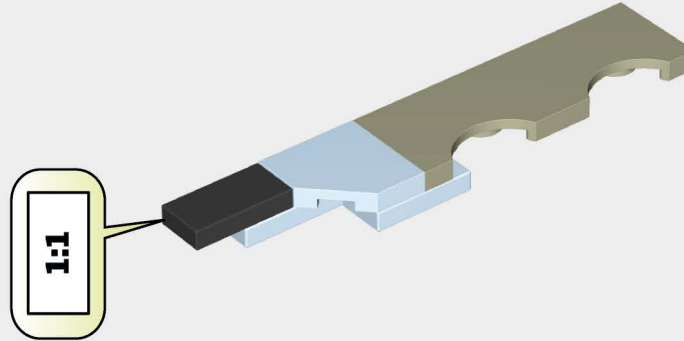

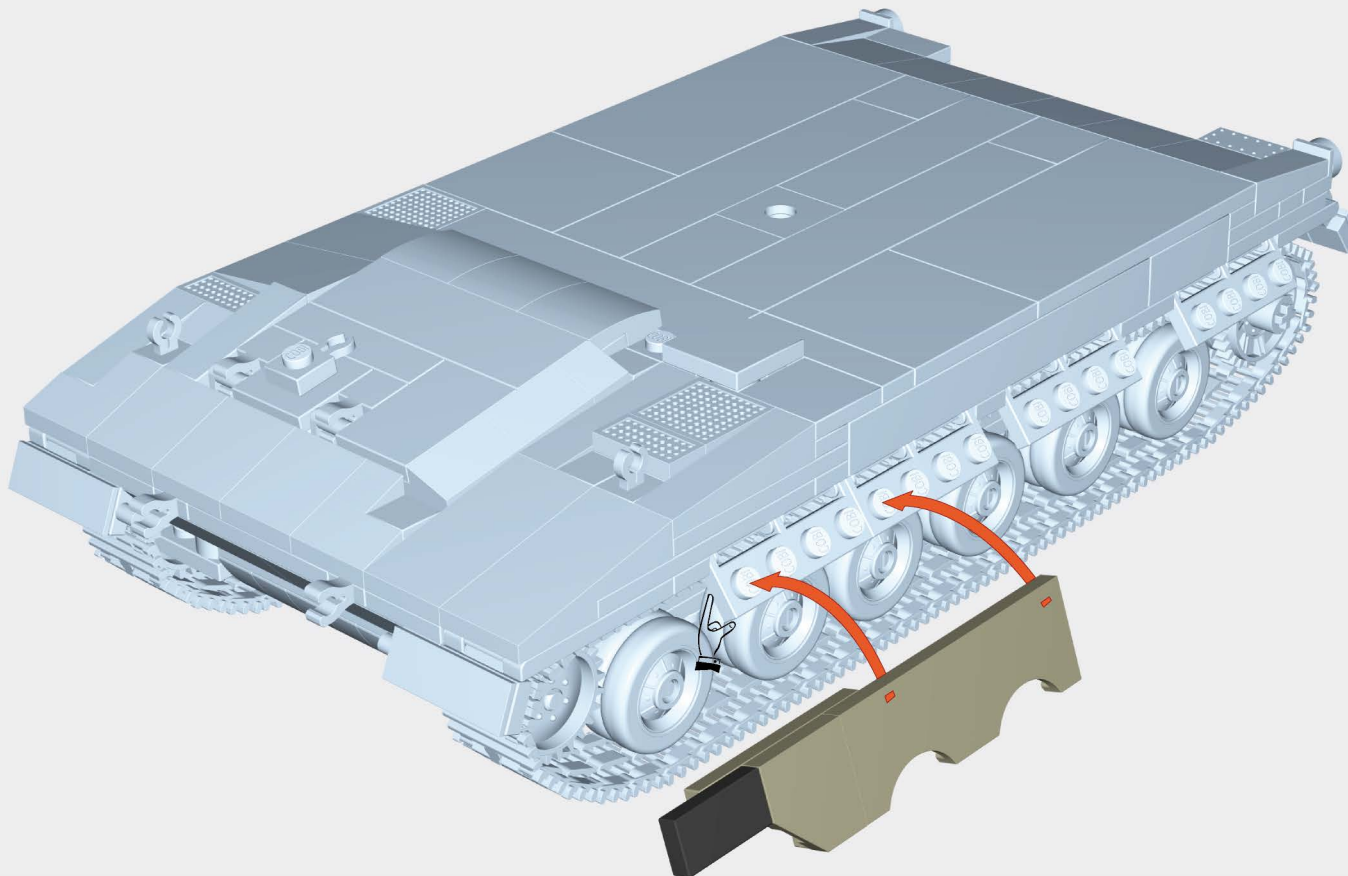

68



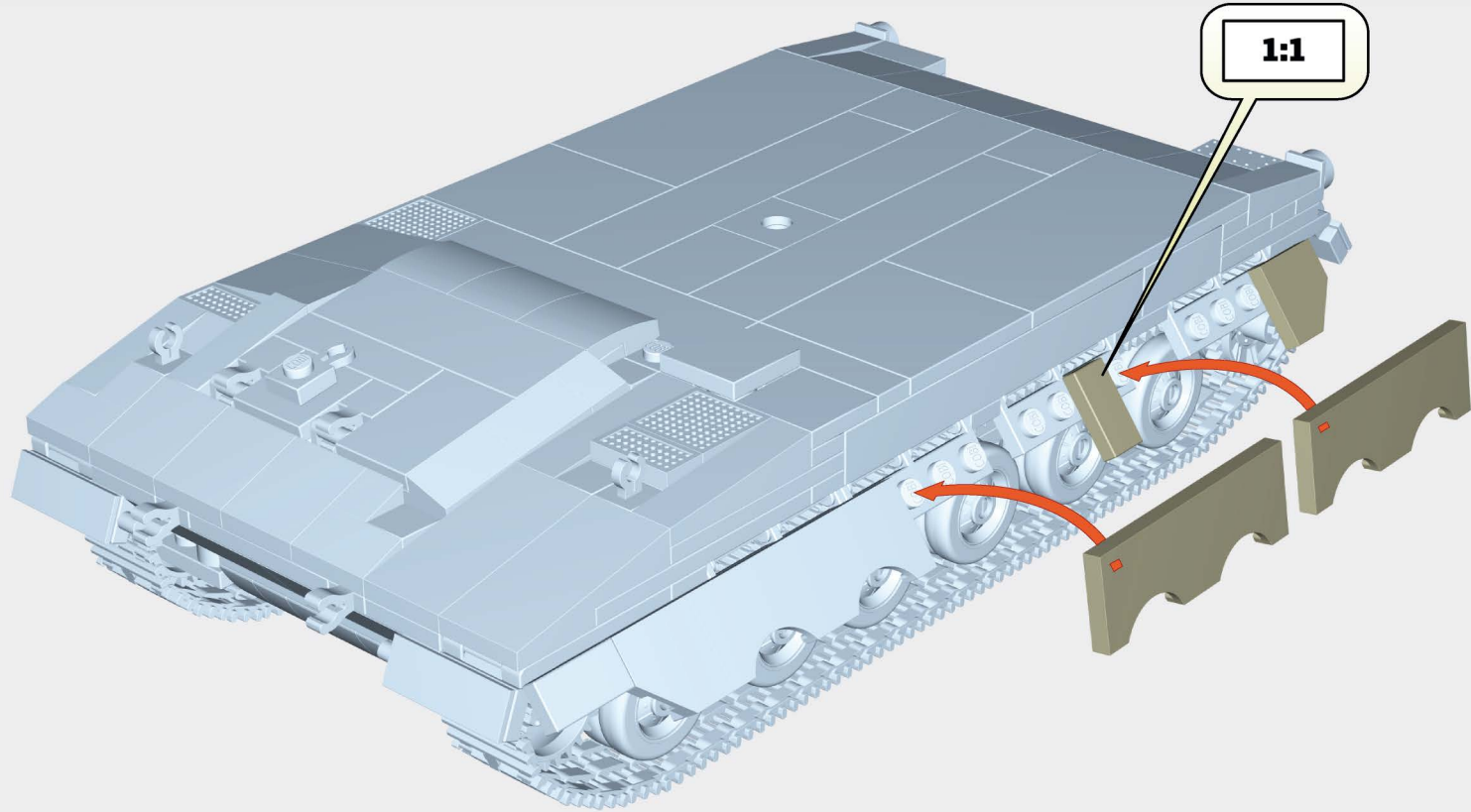

69



-  x1
-  x1
-  x2

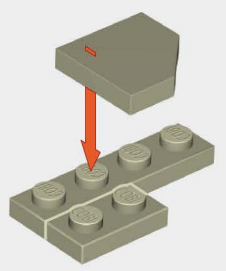

70

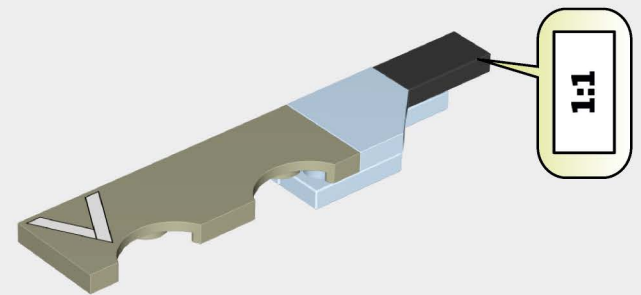

-  x1
-  x1
-  x1

71



-  x1
-  x1

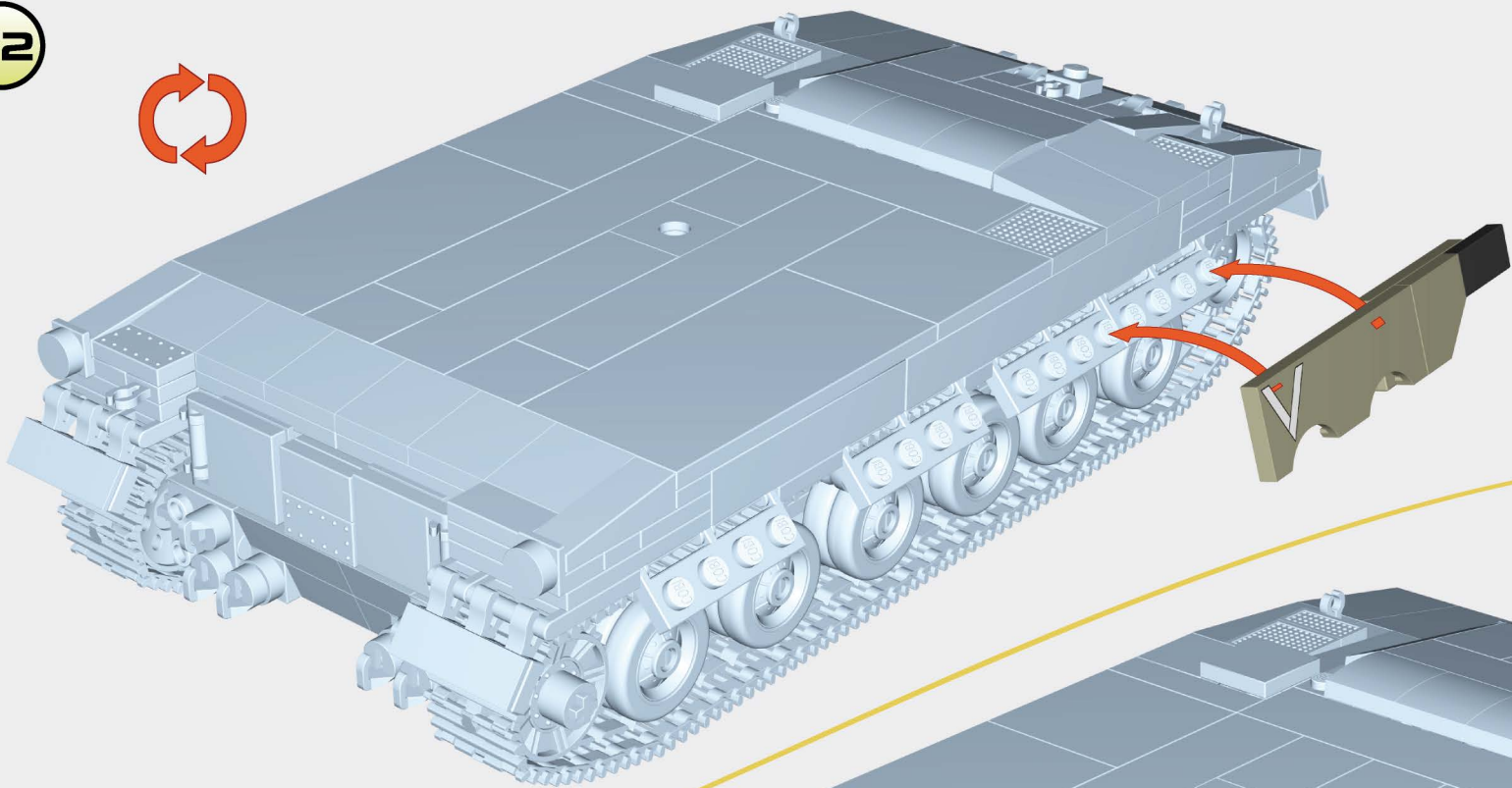

72

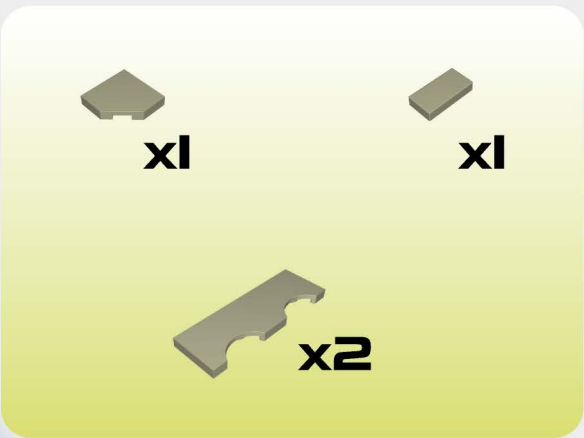
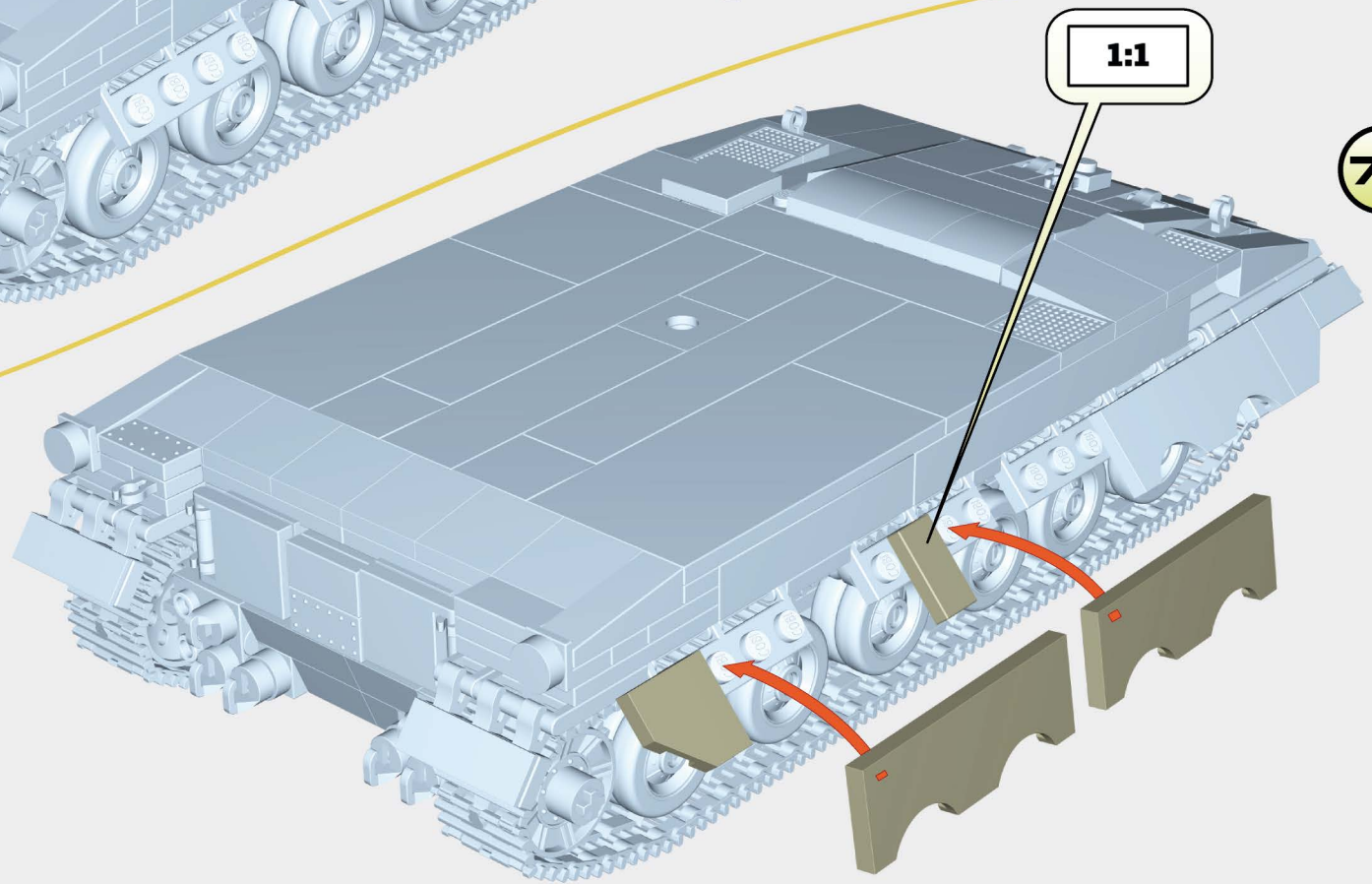

73

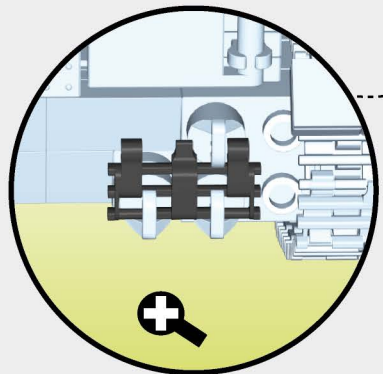
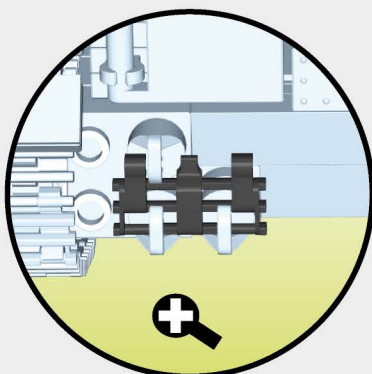
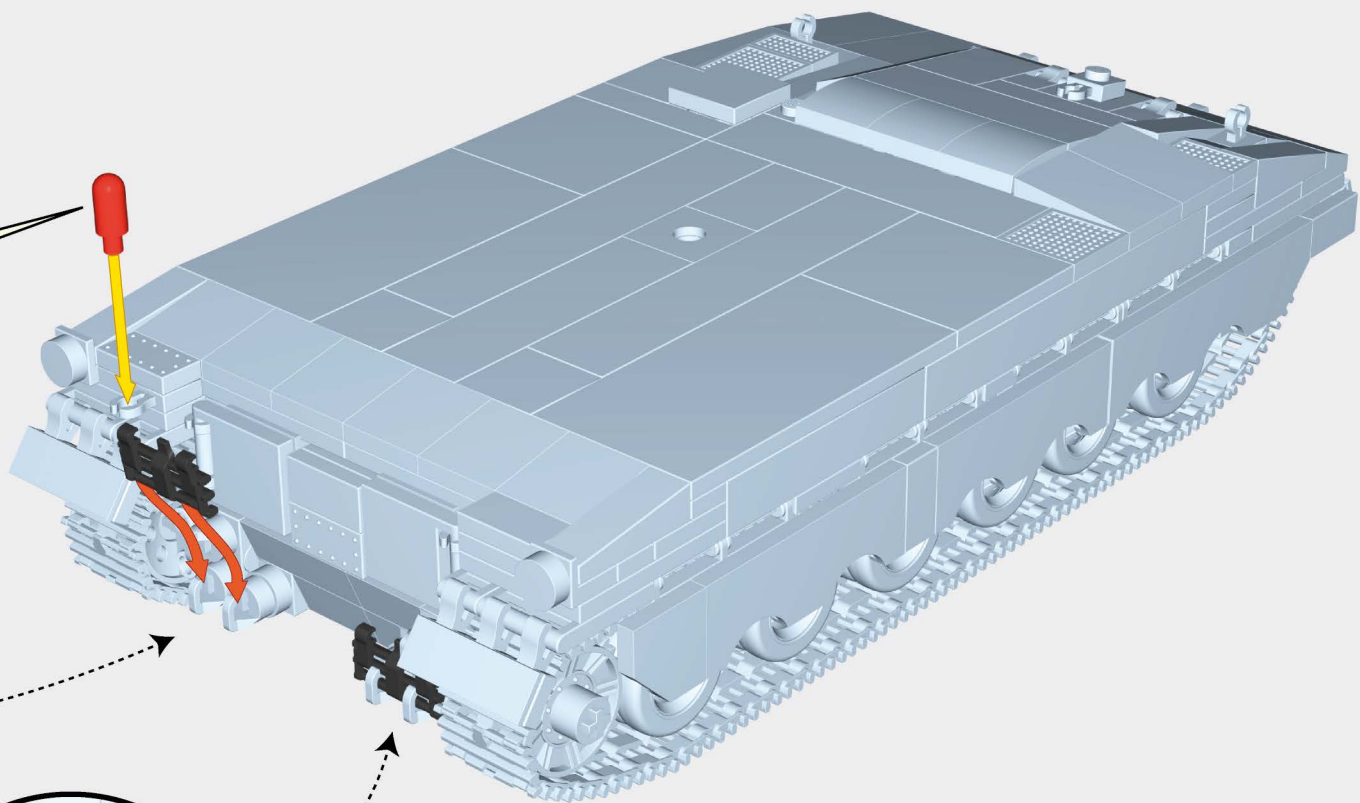
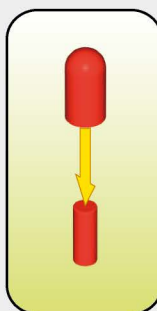



-  x1
-  x1
-  x2

75

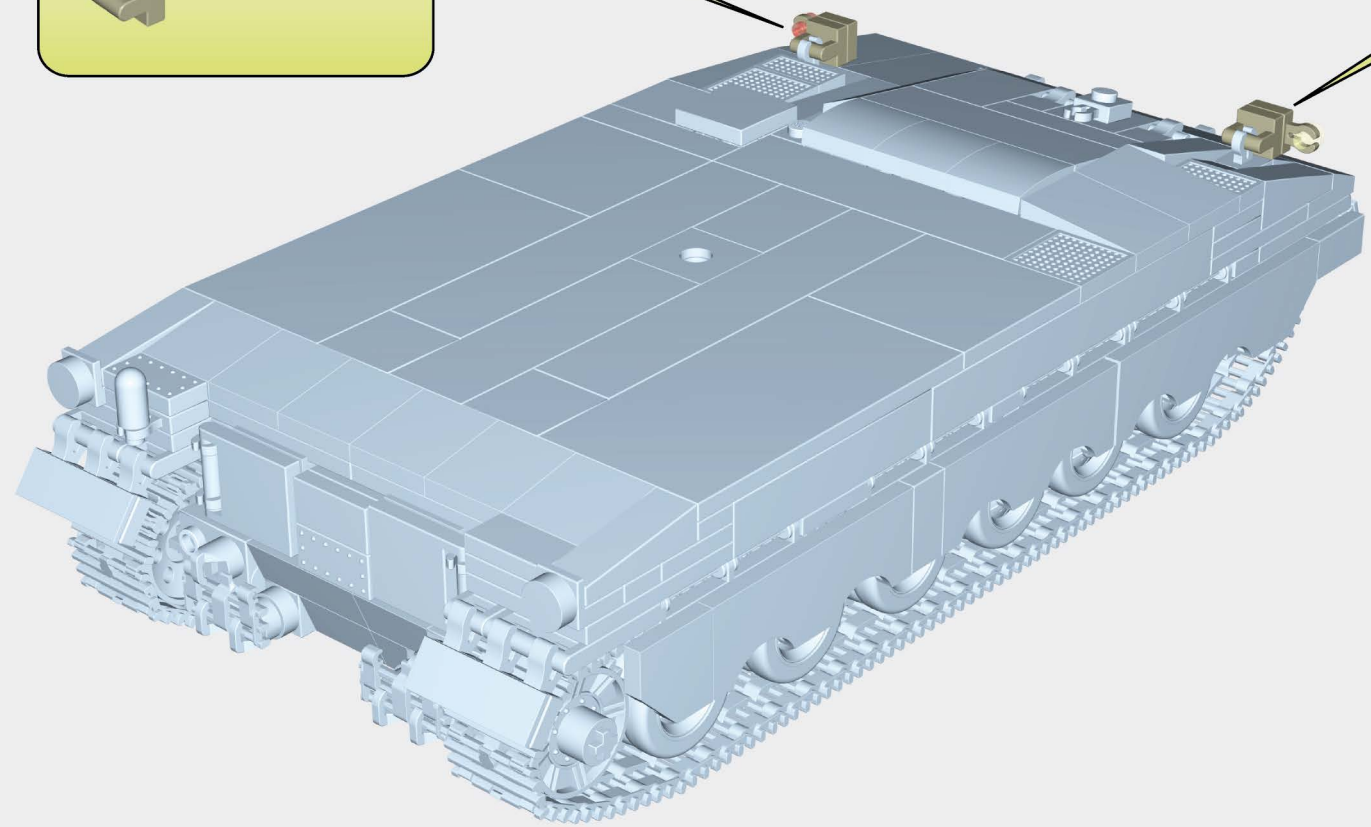
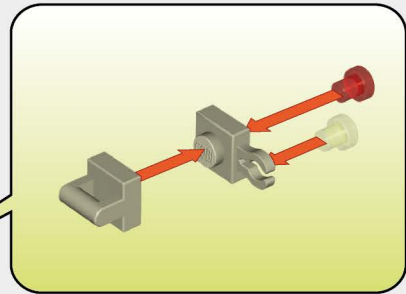
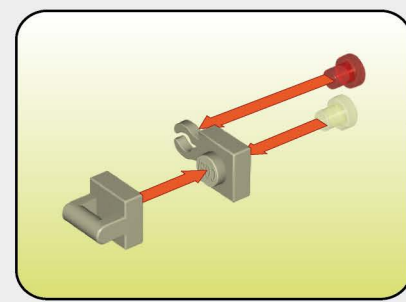

x2



x2



x2



x2

76

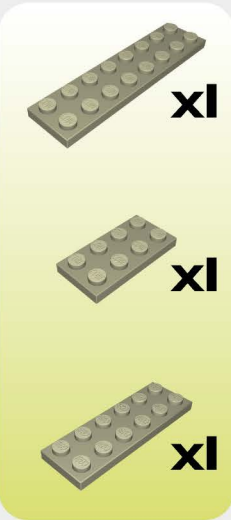
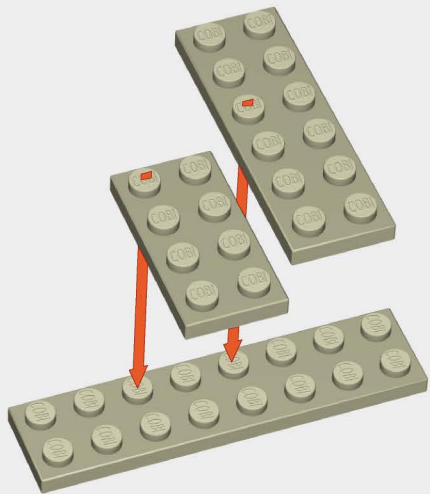

77

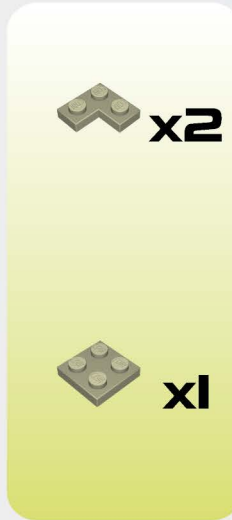

78

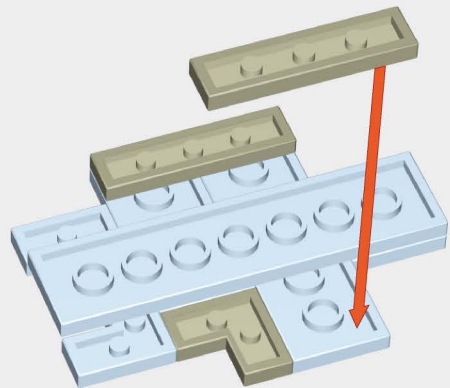

79

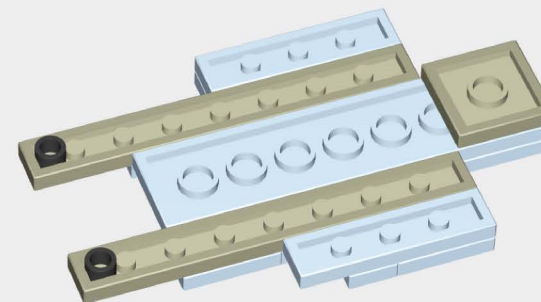
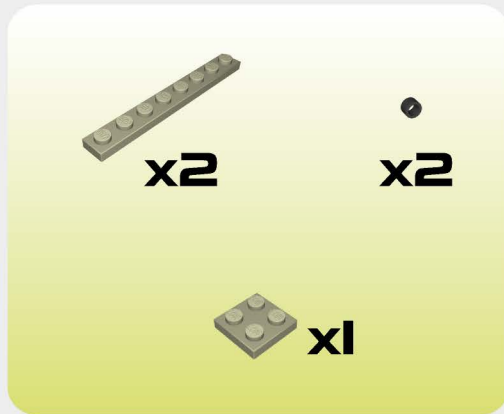
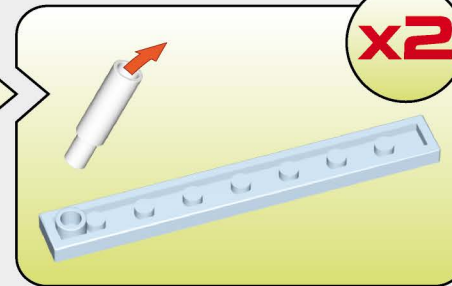
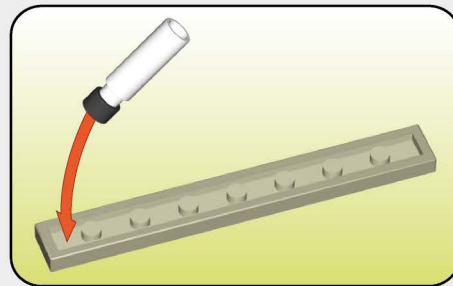

80

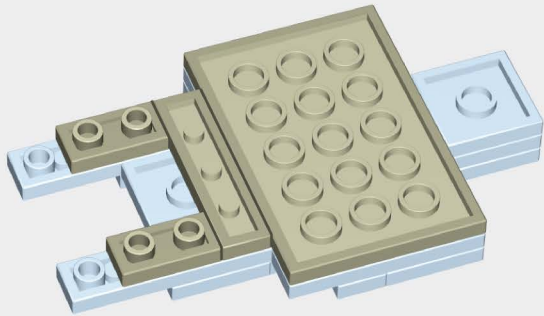

x2



x1

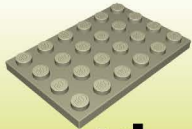

x1

81

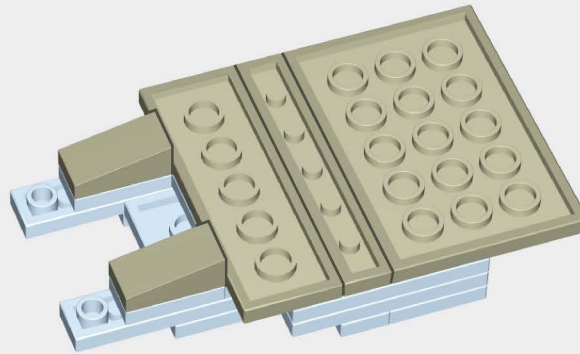

x2



x1



x1

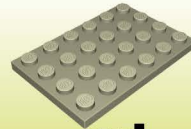

x1

82

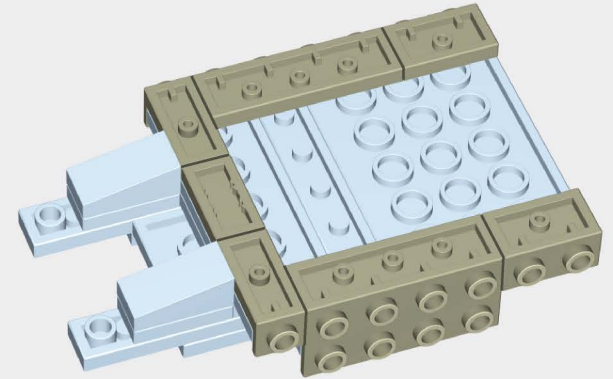

x2



x1



x2



x2

83

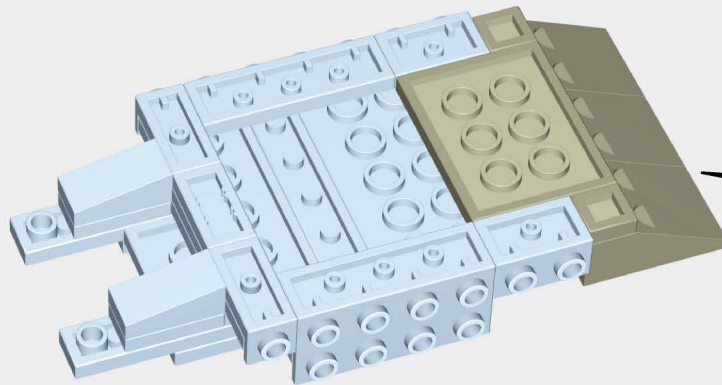

x3

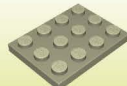

x1



x2

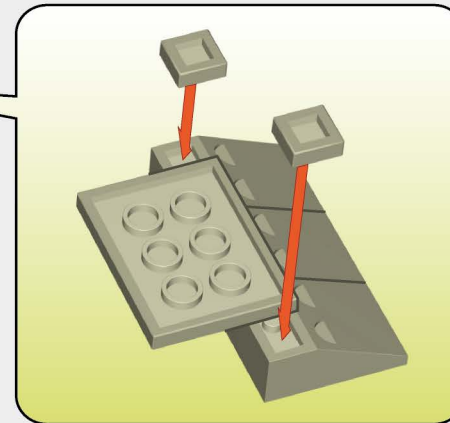

84

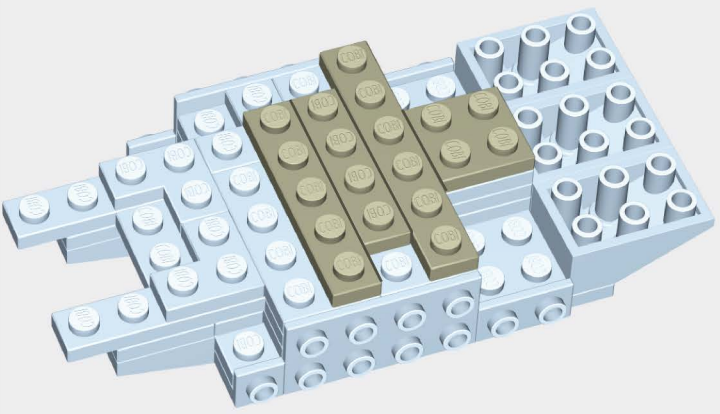

x1



x1



x1

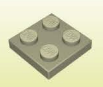

x1

85

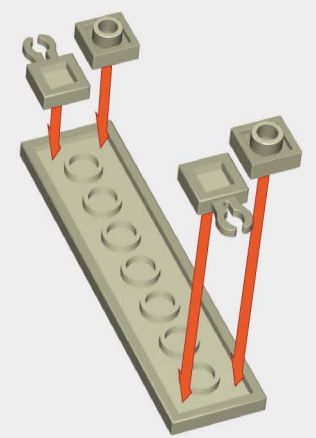

x1



x2



x2

86

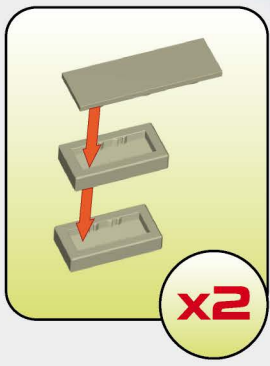
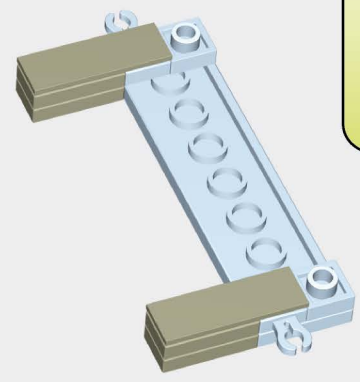

x2



x4



x2

87

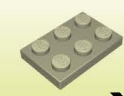
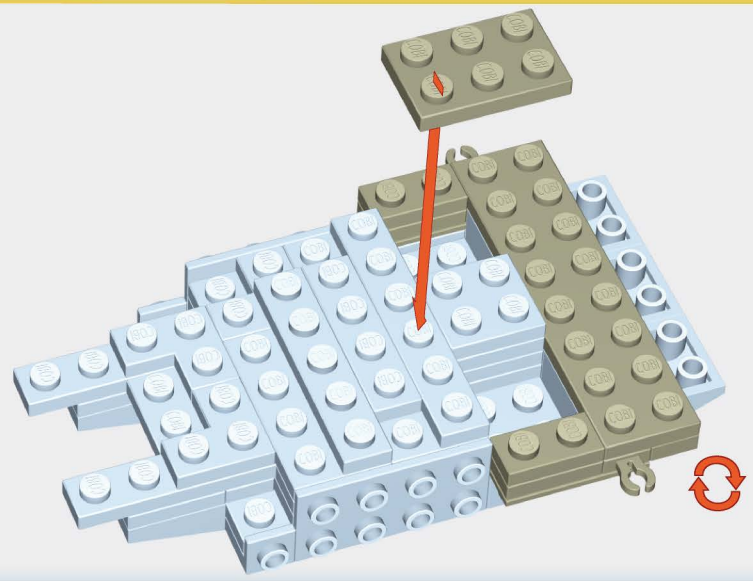

x1

88

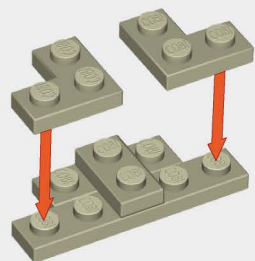

x1



x1



x1



x2

89

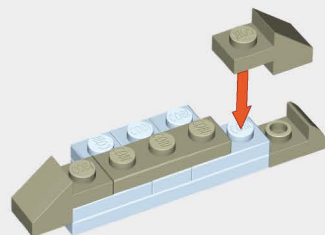

x1



x1



x2

90

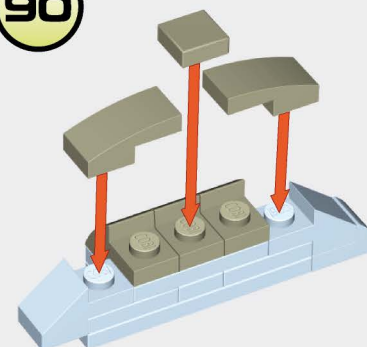

x3



x2



x1

91

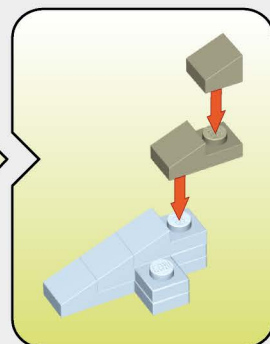
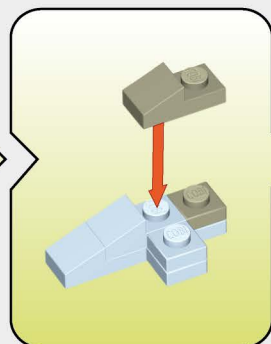
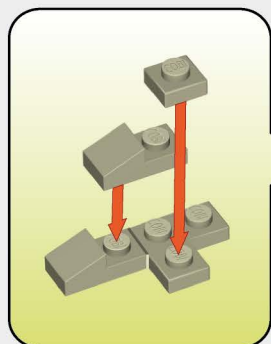

x4



x1



x2



x1



x1

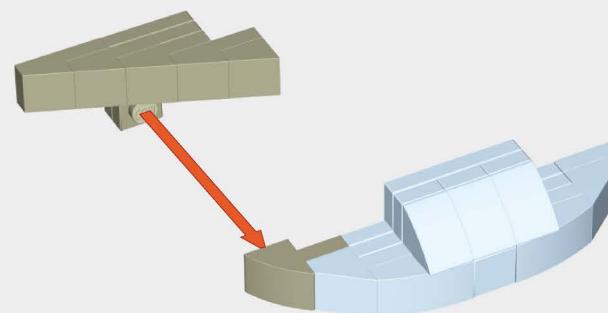

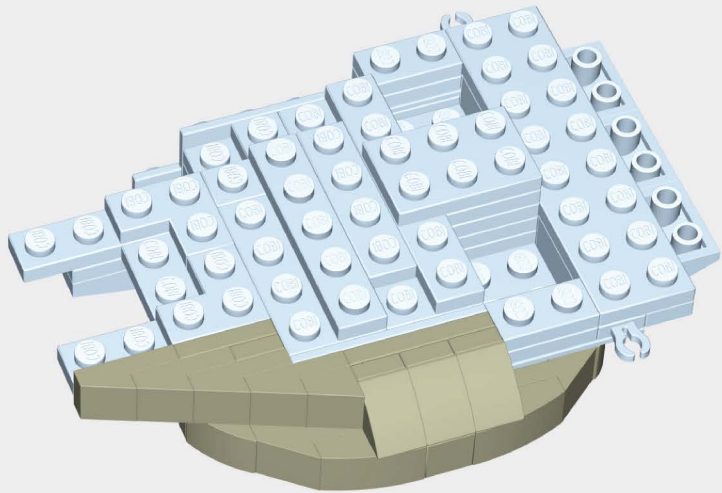

92

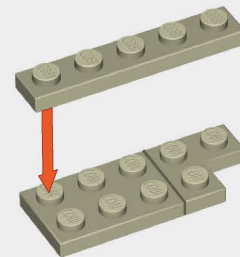

93

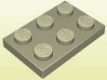

 **x1**
  **x1**
  **x1**



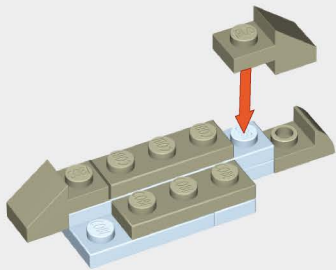

94

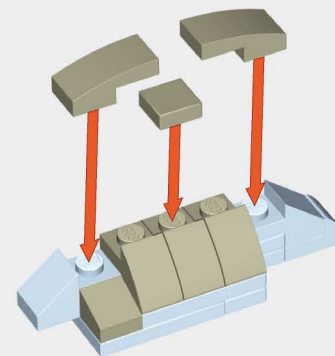

 ^F **x2**
  **x2**
  **x1**







95

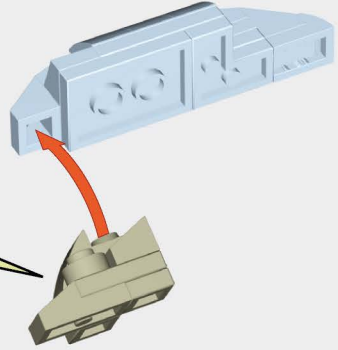
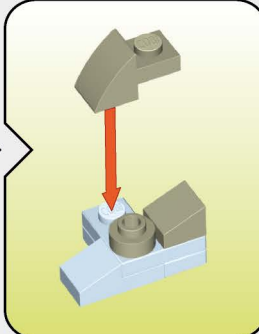
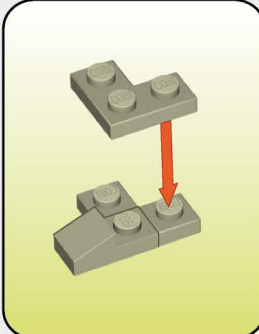

 **x1**
  ^E **x3**
  **x2**
  **x1**

96





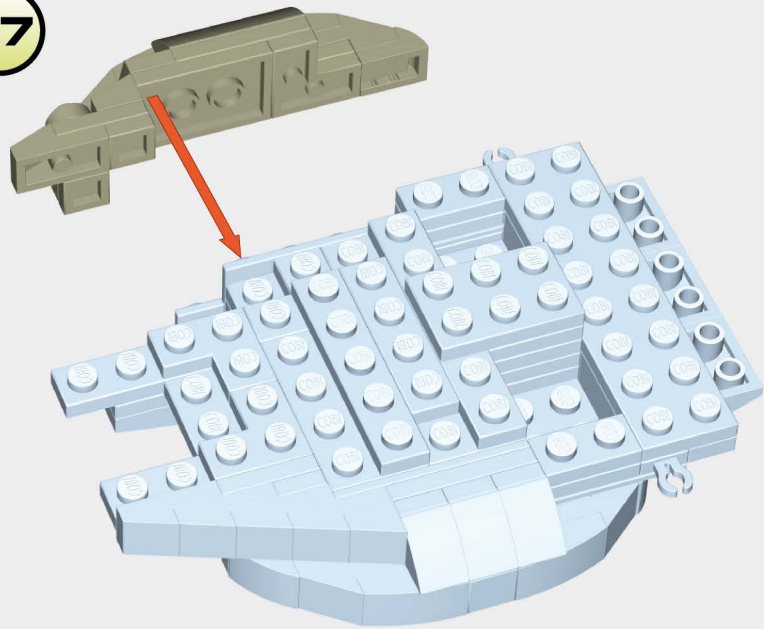

- 
x1
- 
x2
- 
x1
- 
x1
- 
x1
- 
x1

97

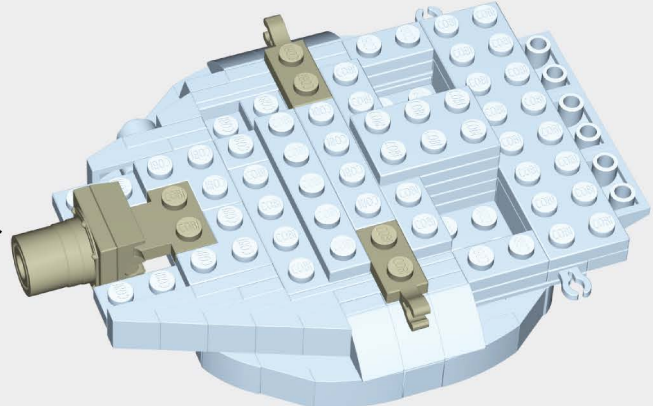
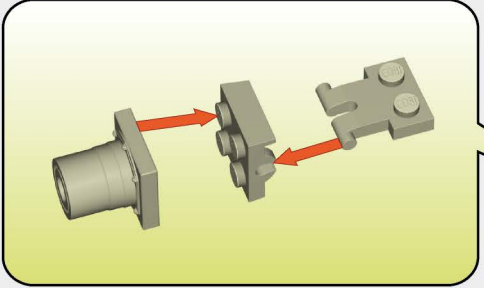

98



- 
x1
- 
x1
- 
x1
- 
x2

99

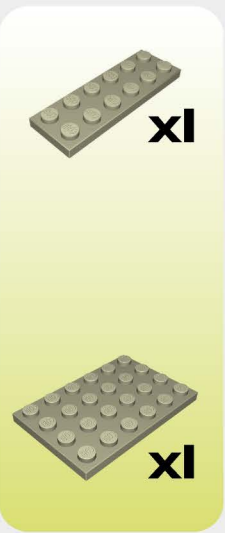
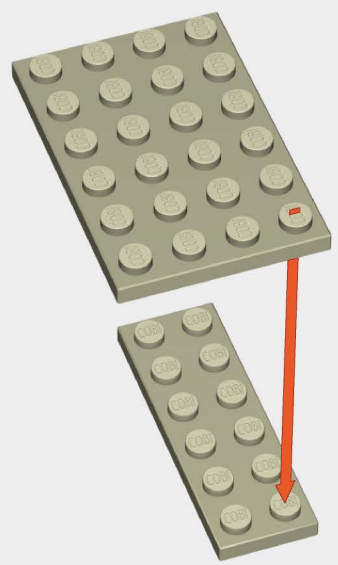

100

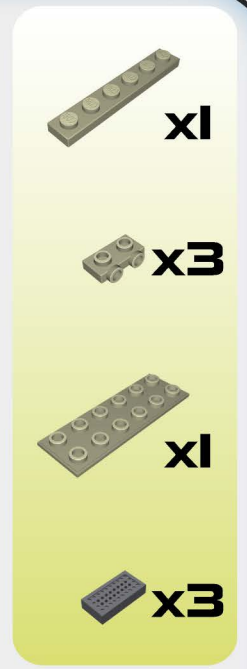
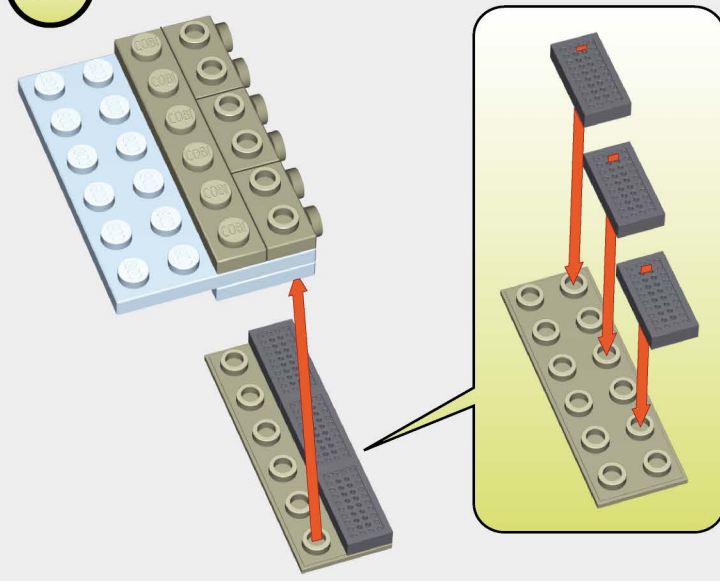

101

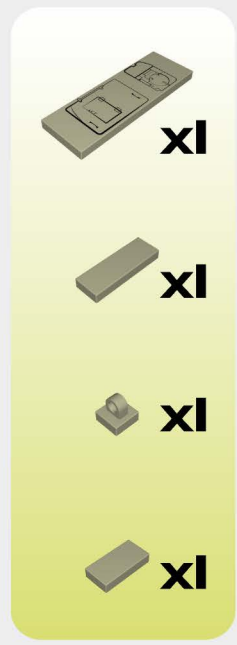
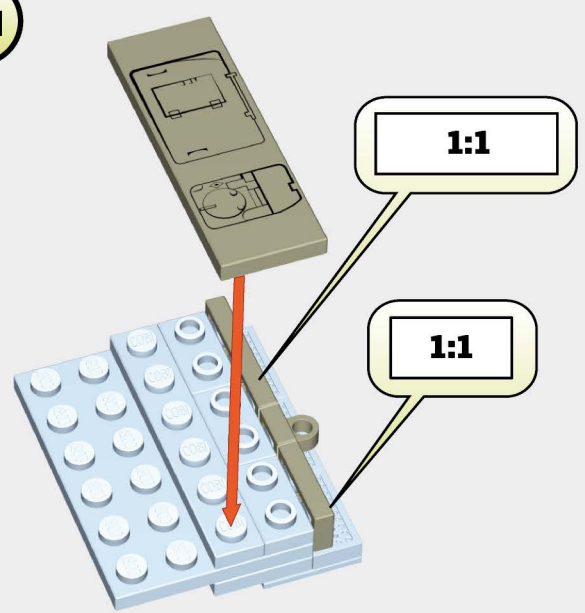

102

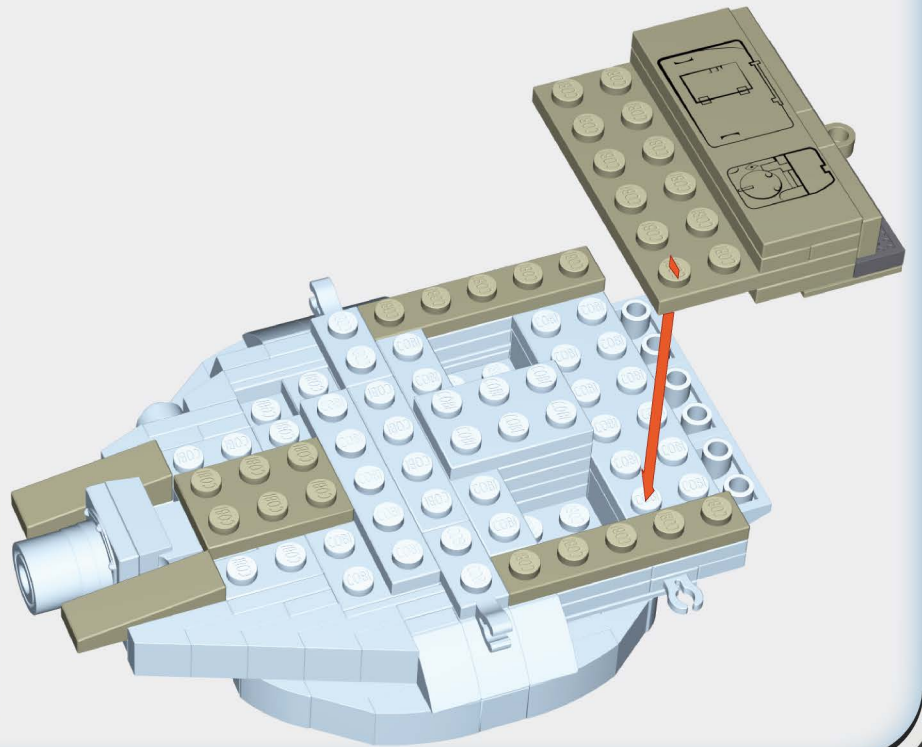
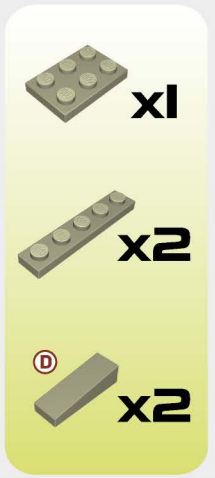

103

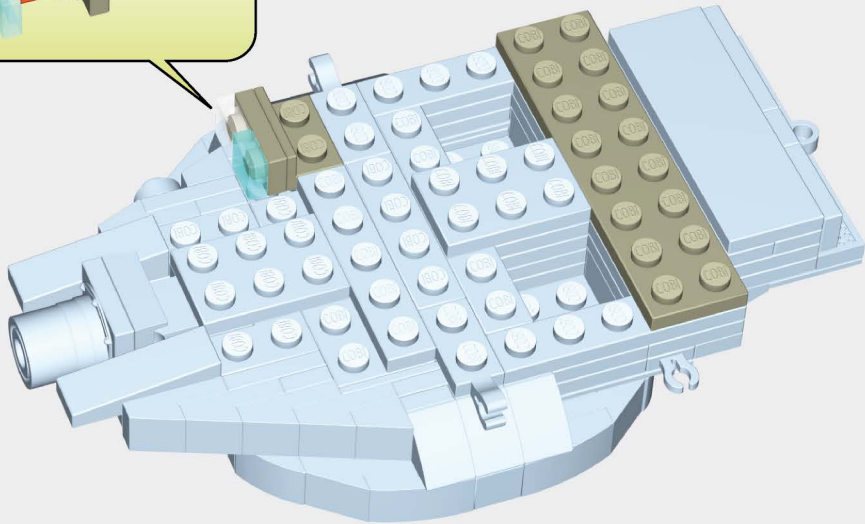
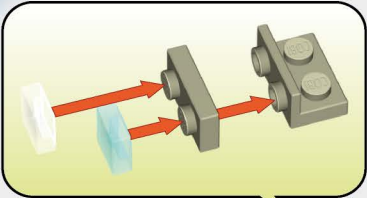

x1



x1



x1



x1

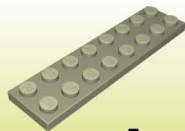

x1

104

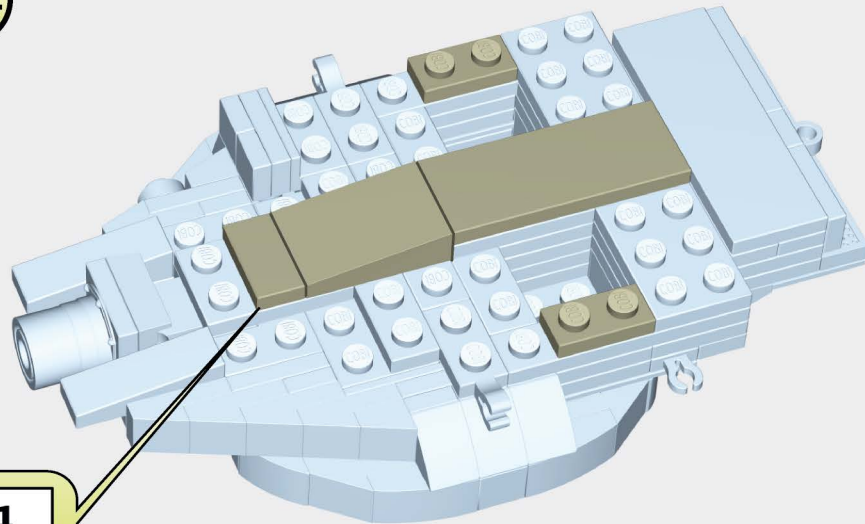

1:1



x1

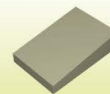

x1

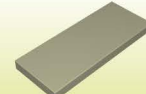

x1



x2

105



x1



x1



x2





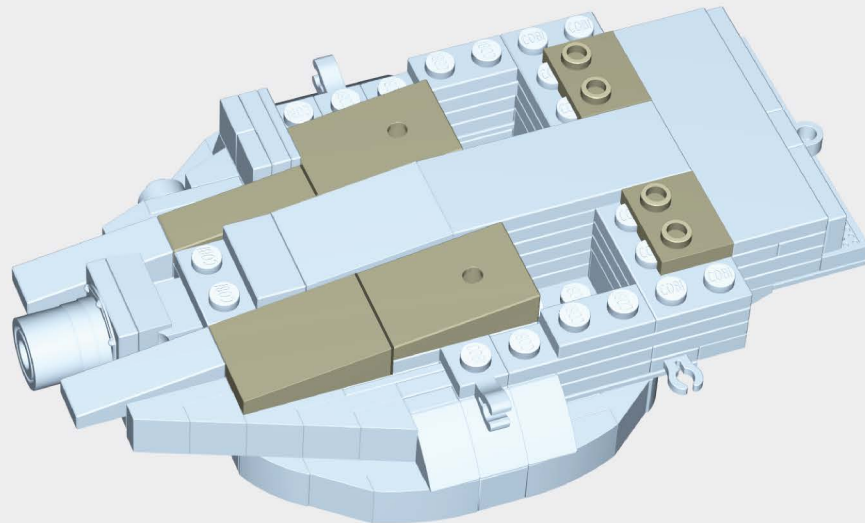

x2

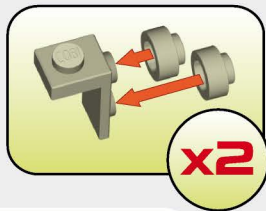
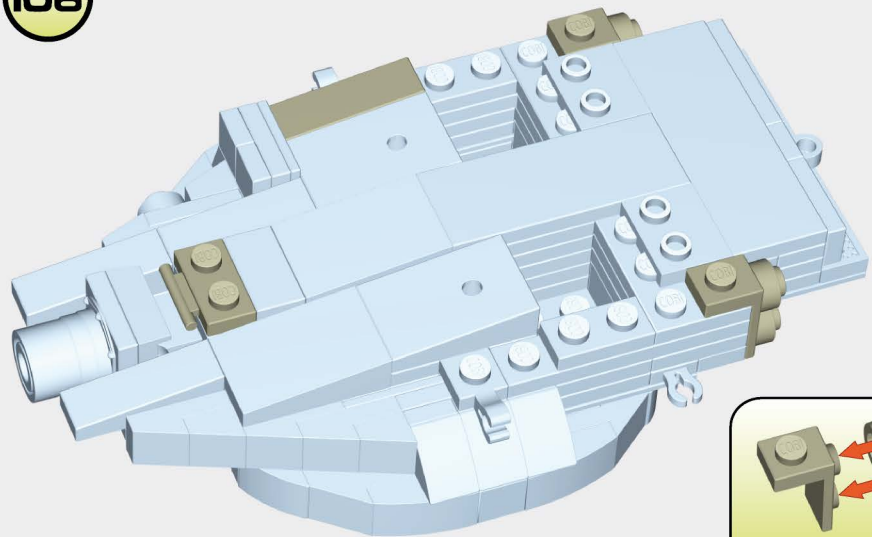







106

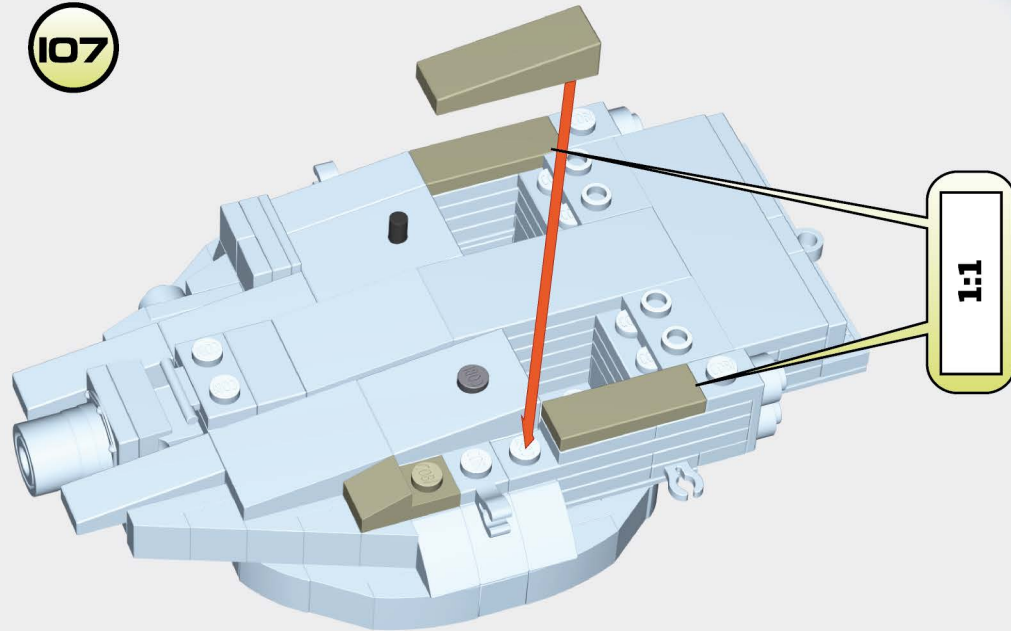

- 
x1
- 
x1
- 
x2
- 
x4





107

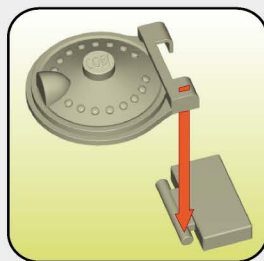

- 
x1
- 
x1
- 
x2
- 
x1
- 
x1

108





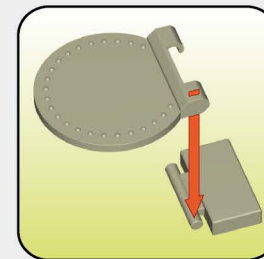
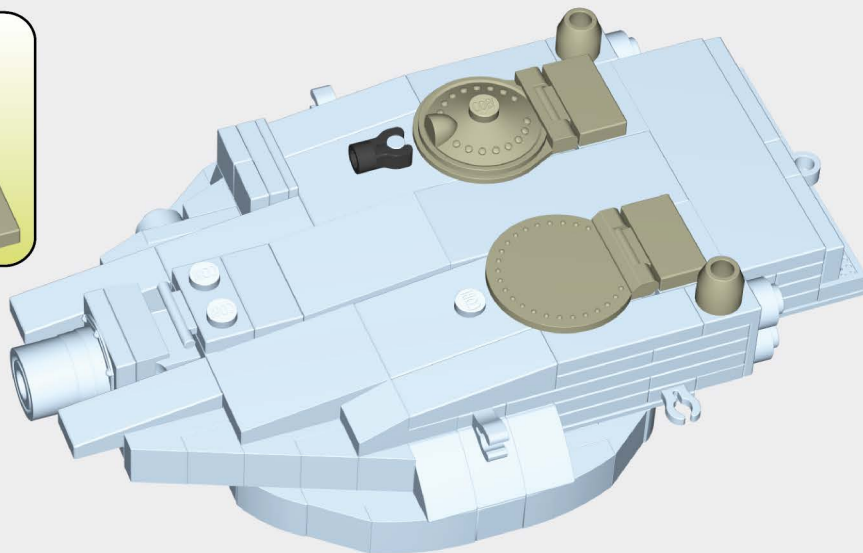

- 
x2
- 
x1
- 
x1
- 
x2
- 
x1

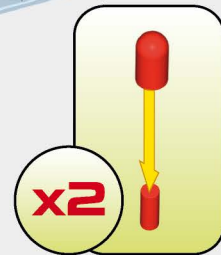
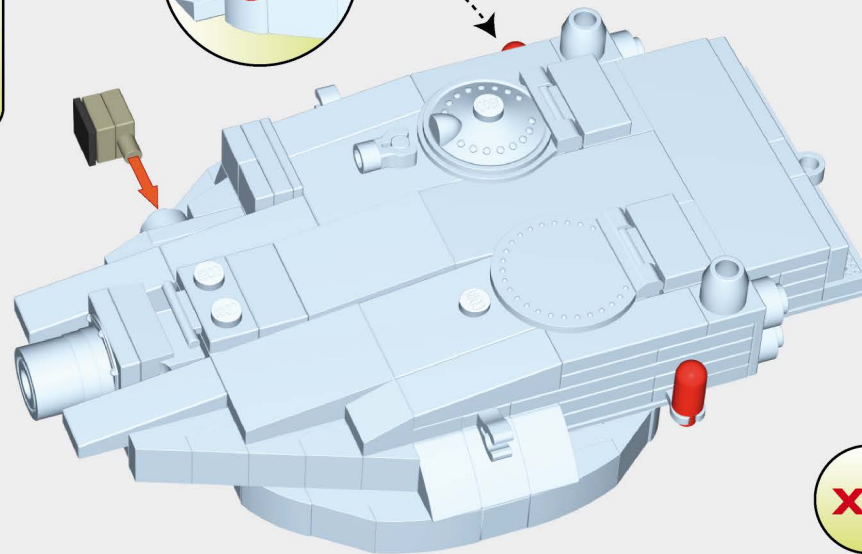
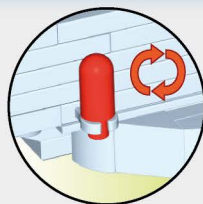
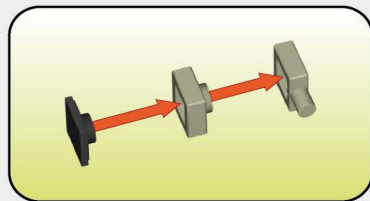





109

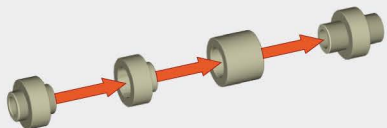

 **x1**
  **x1**
  **x1**
  **x2**
  **x2**



110

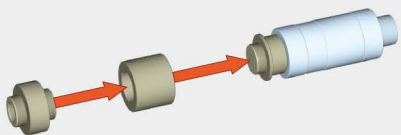

 **x1**
  **x1**
  **x1**
  **x1**

111



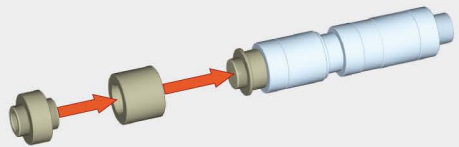

 **x1**
  **x1**
  **x1**

112





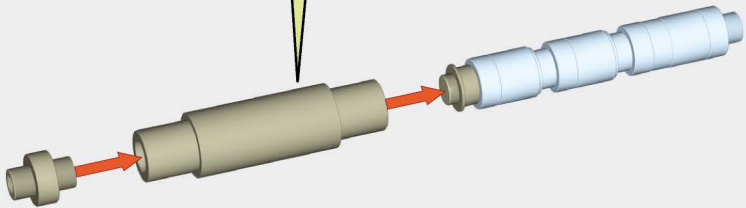
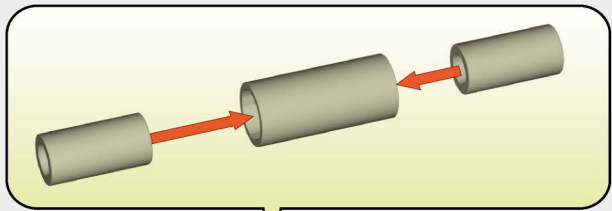

Parts list for step 112:

-  x1
-  x1
-  x1

113



Parts list for step 113:

-  x1
-  x2
-  x1
-  x1

114

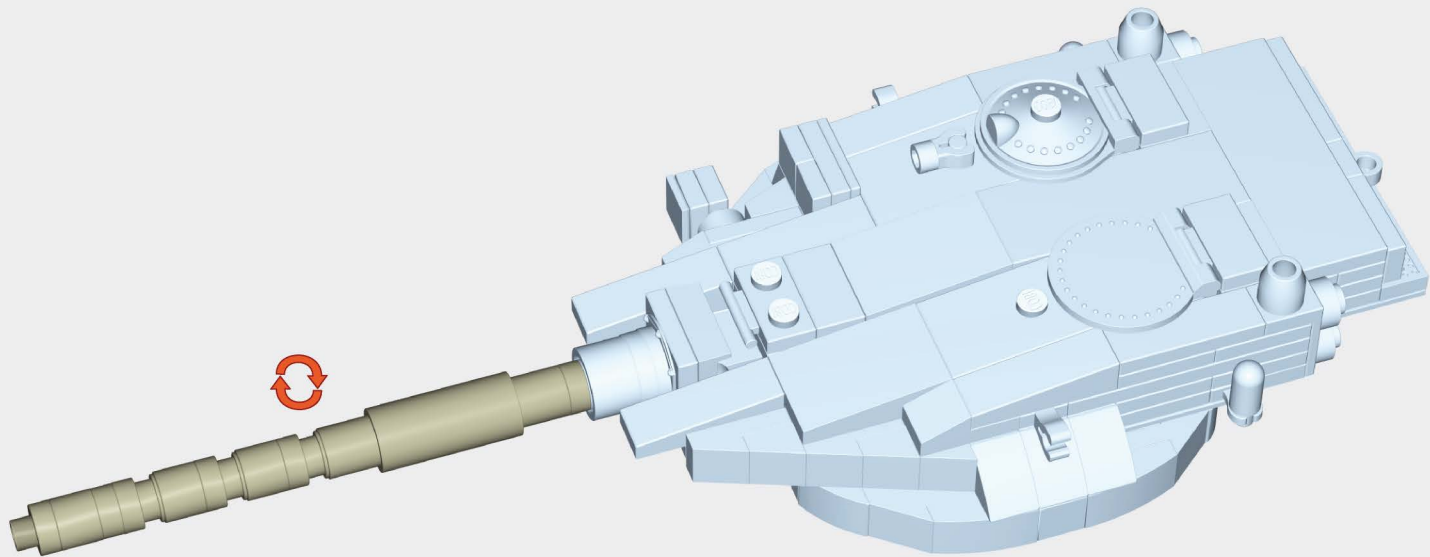

115

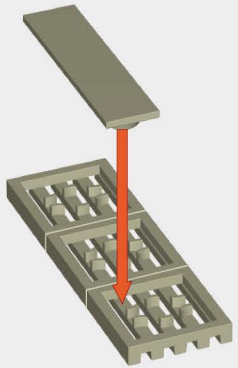

x3



x1

116

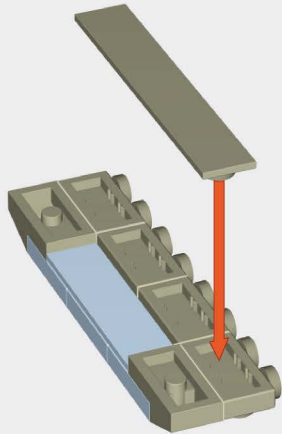

x2



x4



x1

117

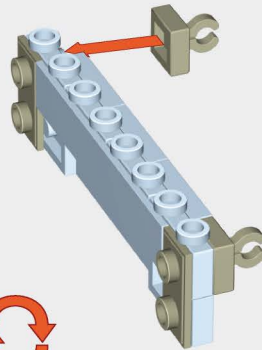

x2



x2

x2

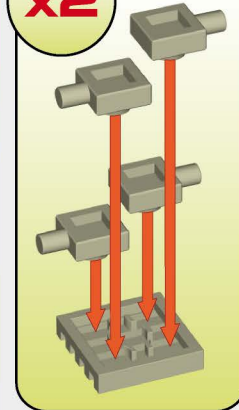

118

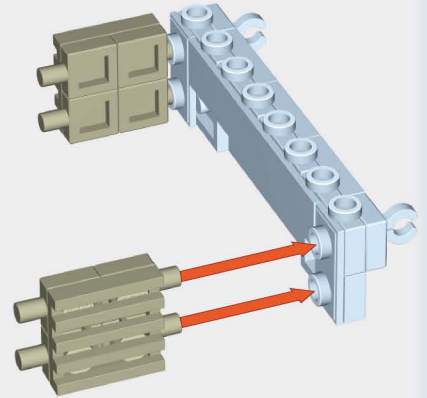

x2





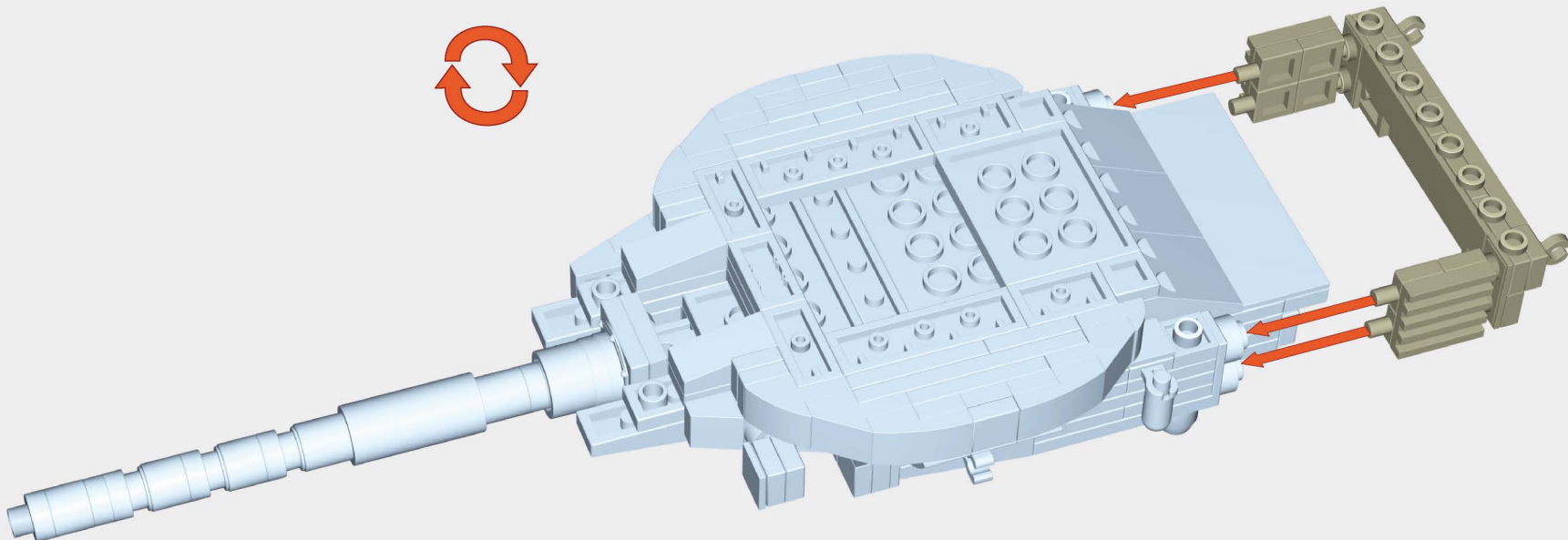

x8

119

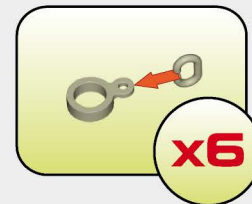
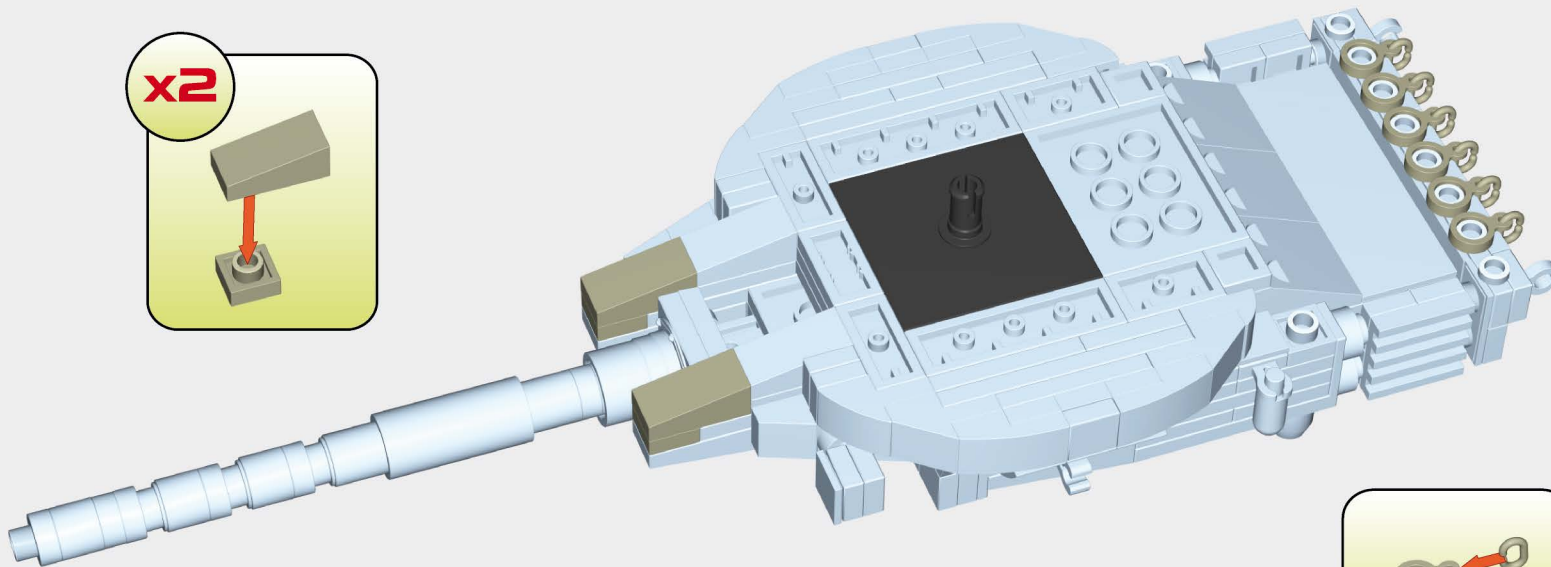
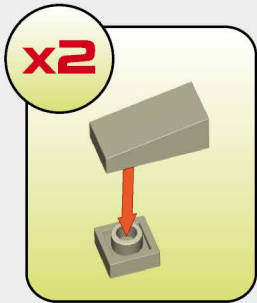

120

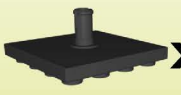

-  x2
-  x2
-  x1
-  x6
-  x6

121

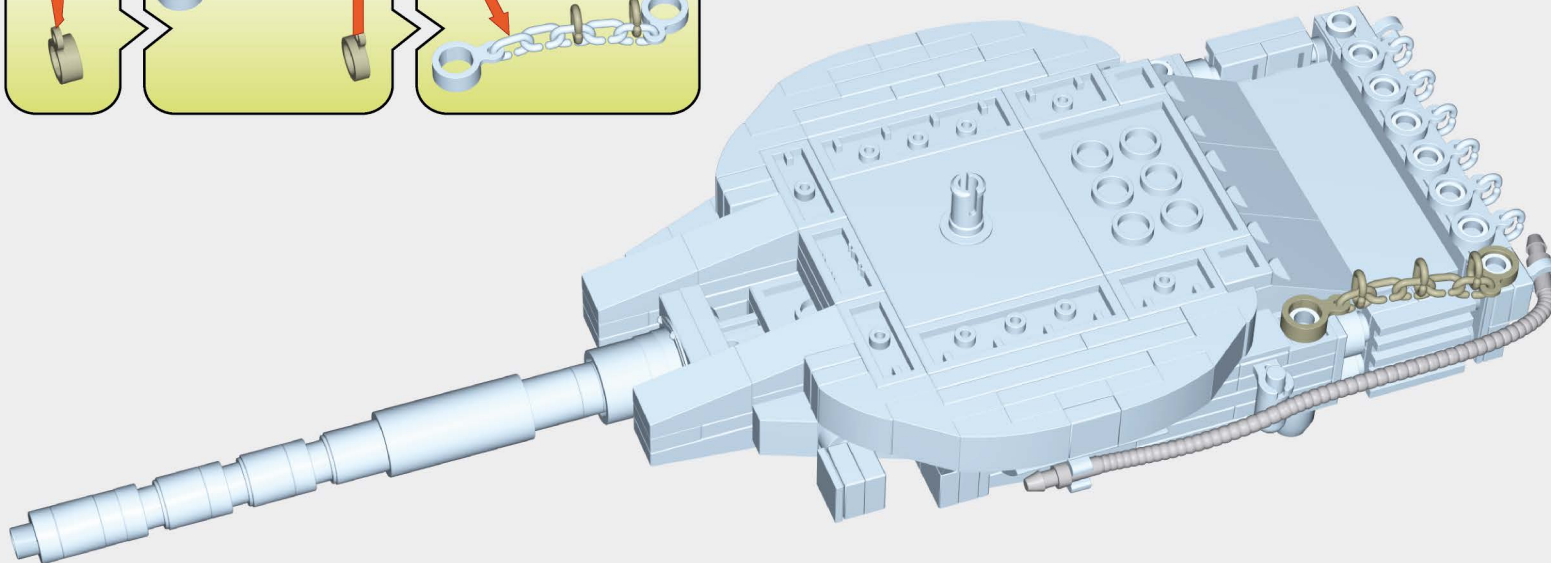
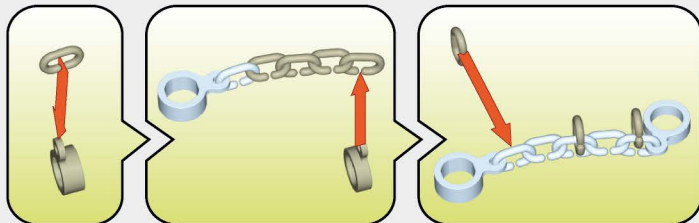

-  x2
-  x8
-  x1

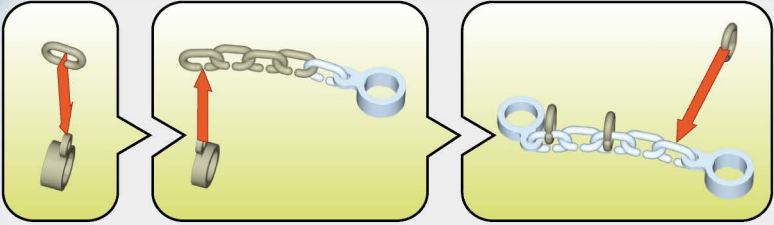

122

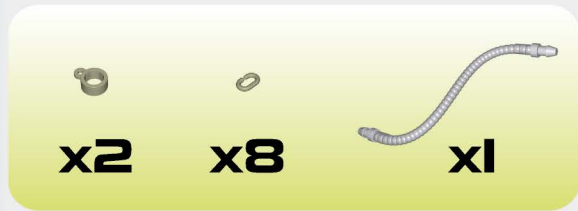
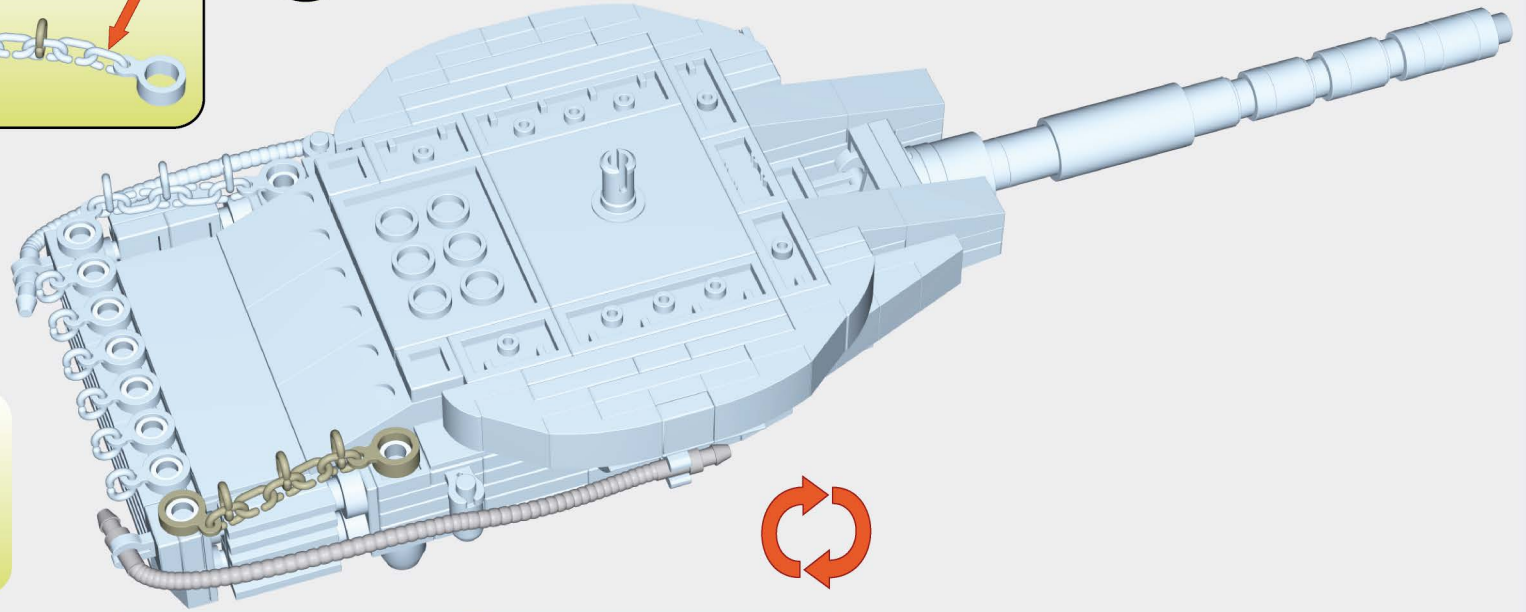

123

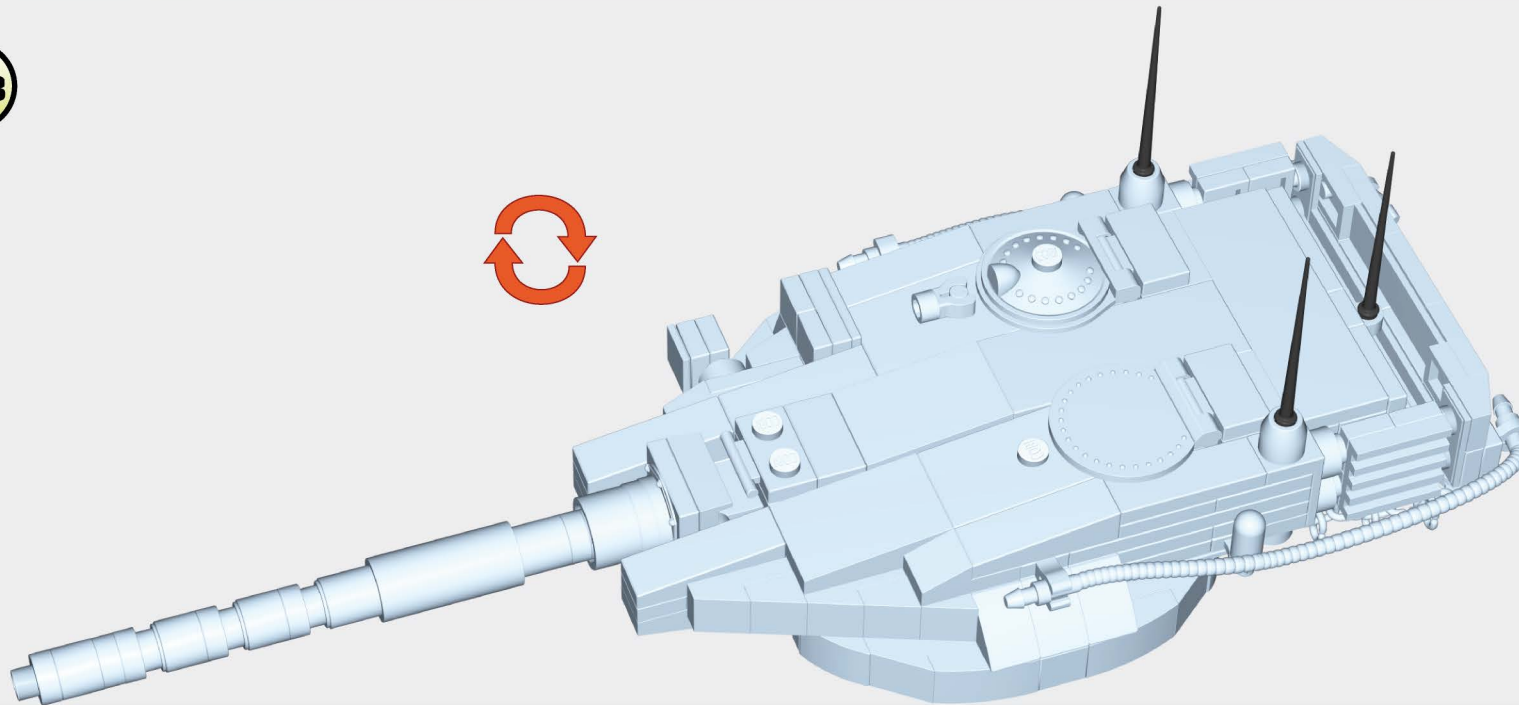

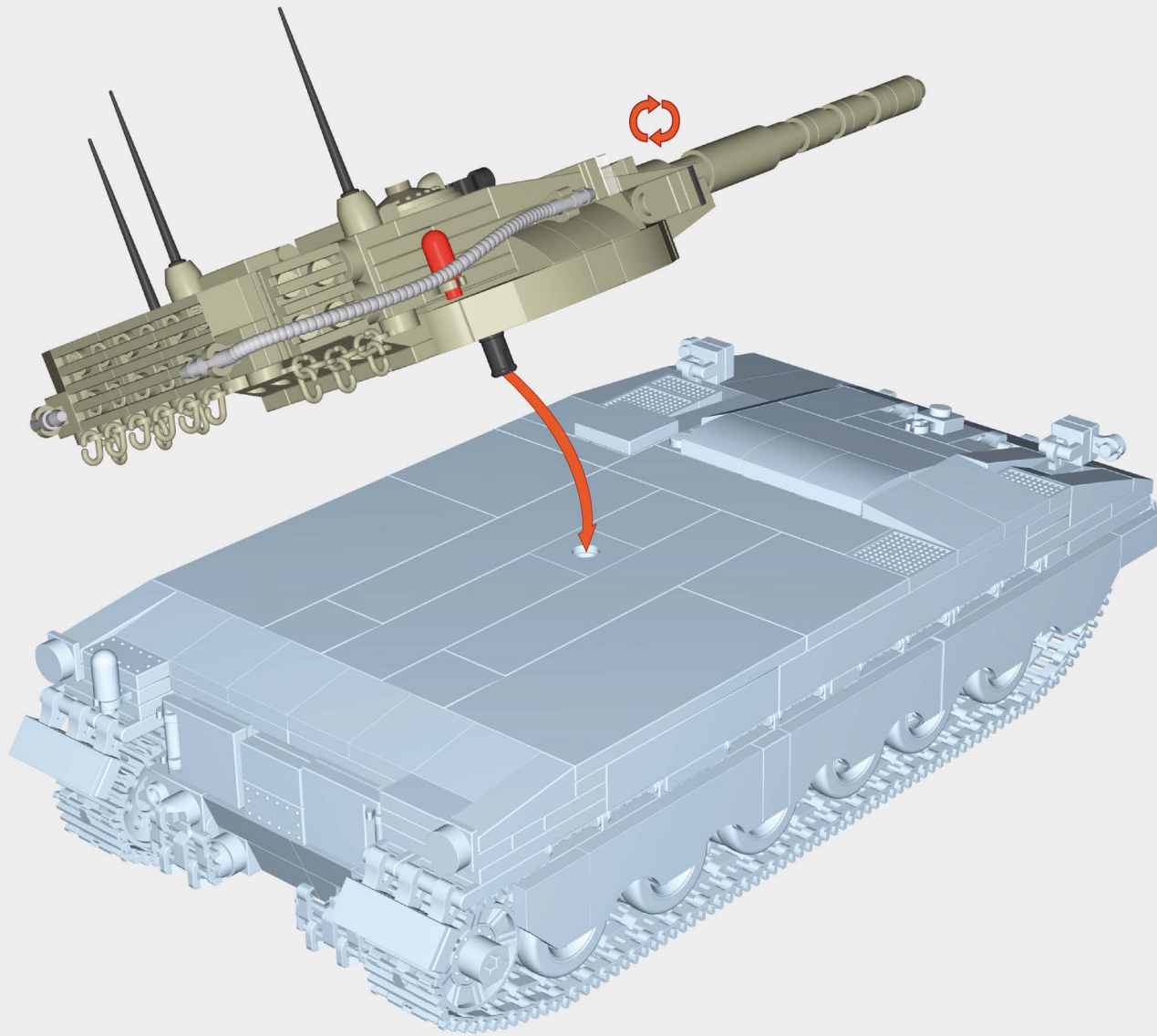

 x2 134434	 x2 141251	 x20 129722	 x3 129870	 x2 141240	 x4 129718	 x8 141239	 x2 119497	 x1 130705	 x6 129723	 x2 129724
 x8 141115	 x1 112792	 x2 129726	 x2 129727	 x9 129701	 x1 138581	 x5 129728	 x1 61490	 x2 129729	 x2 105486	 x2 98822
 x4 129732	 x4 129734	 x4 129735	 x1 129736	 x1 141193	 x1 129737	 x1 129738	 x1 141118	 x13 130630	 x3 95106	 x5 130628
 x4 129741	 x1 135568	 x1 141114	 x22 129744	 x1 43671	 x2 129745	 x1 42938	 x4 136053	 x2 141249	 x1 141199	 x3 129747
 x2 106152	 x2 129871	 x3 45158	 x5 129749	 x3 102290	 x2 141196	 x11 129751	 x7 141245	 x2 141197	 x2 130704	 x2 42950
 x1 129753	 x1 141247	 x1 141244	 x2 95017	 x2 129754	 x4 129755	 x1 130629	 x4 129872	 x2 133043	 x4 129761	 x9 129763
 x4 129765	 x1 101670	 x9 115501	 x1 129766	 x1 129768	 x2 109025	 x2 141004	 x2 129769	 x4 42974	 x10 129771	 x2 141267
 x2 129775	 x6 141176	 x8 141131	 x1 42965	 x2 129770	 x1 141005	 x1 128375	 x2 130701	 x1 141257	 x11 129777	 x1 129875
 x5 129778	 x2 141211	 x6 129781	 x9 129782	 x2 141250	 x6 129785	 x11 129786	 x2 141007	 x3 129882	 x1 141008	 x5 141246
 x2 141194	 x5 129791	 x4 129794	 x1 141198	 x22 129884	 x8 141177	 x1 141248	 x3 129715	 x1 43684	 x1 43055	 x6 129710
 x3 141200	 x2 130598	 x2 141179	 x1 43152	 x4 129800	 x2 129716	 x2 141132	 x3 129886	 x1 43688	 x2 62666	 x4 132304
 x2 129887	 x3 141265	 x2 43166	 x4 129804	 x2 141178	 x1 108935	 x2 43160	 x2 62671	 x2 141180	 x3 109915	 x3 129808

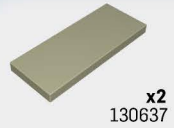

x2
130637



x1
43192



x3
129890



x1
141010

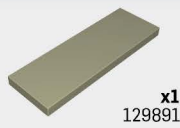

x1
129891

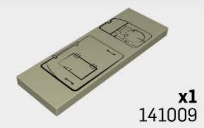

x1
141009



x5
137460



x1
43183



x1
141213



x3
141214



x4
129809

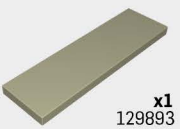

x1
129893



x6
129810

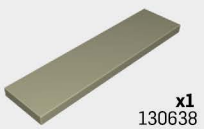

x1
130638



x1
87252



x4
129812

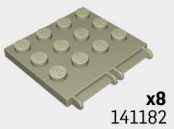

x8
141182

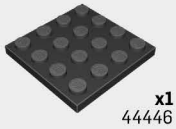

x1
44446

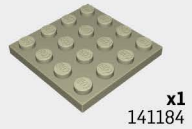

x1
141184

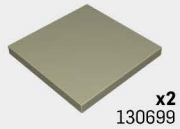

x2
130699

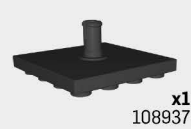

x1
108937

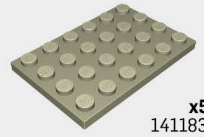

x5
141183

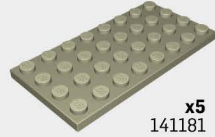

x5
141181

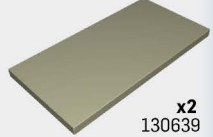

x2
130639



x3
83922



x2
93960



x2
103415



x1
104415



x2
112138



x2
129815



x1
101104



x4
141212



x24
129819



x4
141116



x2
130604



x112
74389



x22
141241



x24
92679



x2
141133



x1
58332

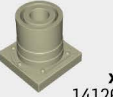

x1
141266



x3
43517



x6
130605



x4
103944



x1
141254



x1
141255



x1
133021



x3
141243



x1
141192



x2
130606



x1
141195



x2
43577



x3
129825



x7
129827



x2
129826



x2
141117

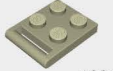

x2
130633

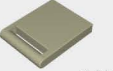

x2
141210



x1
141256



x3
129829



x2
130609



x2
128272



x10
141242



x3
104860



x3
129742

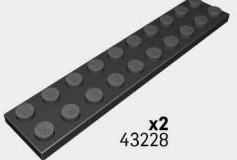

x2
43228

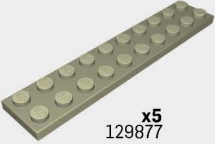

x5
129877

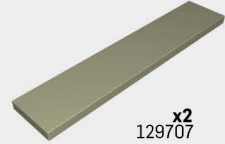

x2
129707

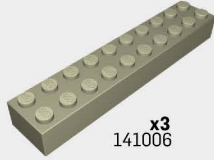

x3
141006



x1
120007

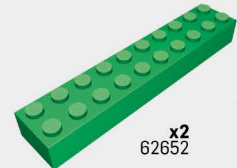

x2
62652



x2
141228



HISTORICAL COLLECTION



HORCH830BK CABRIOLET
🇵🇱 🇩🇪 2262



PANZER VIII "MAUS"
+ 2559



PzKpfw VI TIGER "131"
+ 2556



CITROËN TRACTION 7A
🇫🇷 2263



RENAULT R35
🇫🇷 2553



KV-1
★ 2555



JAGDPANZER 38(t) "HETZER"
+ 2558



CITROËN TRACTION 11CV BL
🇫🇷 2266



HISTORICAL COLLECTION



VICKERS WELLINGTON MK II

🇬🇧 5723



FOCKE-WULF FW 190 A5

✚ 5722



LOCKHEED® P-38 LIGHTNING® (H)

★ 5726



MESSERSCHMITT ME 262A-1A

✚ 5721



MORANE-SAULNIER MS.406

🇵🇱 🇫🇷 5724



Produced under license from Boeing. Boeing, AV-8B Harrier II PLUS, the distinctive Boeing logos, product markings and trade dress are trademarks of The Boeing Company.



AV-8B HARRIER II™ PLUS
5809



F-16®C FIGHTING FALCON®
5814

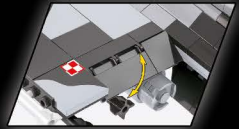

SIKORSKY® UH-60 BLACK HAWK®
5817

SIKORSKY
A LOCKHEED MARTIN COMPANY

OFFICIAL LICENSED PRODUCT
66-SI021-597/04

SIKORSKY®, BLACK HAWK®, associated emblems and logos, and body designs of vehicles are either registered trademarks or trademarks of Lockheed Martin Corporation in the USA and/or other jurisdictions, used under license by COBI.



F-16®C FIGHTING FALCON®
5813

LOCKHEED MARTIN®, F-16®C Fighting Falcon®, associated emblems and logos, and body designs of vehicles are either registered trademarks or trademarks of Lockheed Martin Corporation in the USA and/or other jurisdictions, used under license by COBI.

WWW.COBI.EU

For news and special deals

Find us on:



cobi.bricks
cobi.klocki

COBI SA

19-02621-824