

Maserati Ghibli



MASERATI

OFFICIAL LICENSED PRODUCT



PAD PRINTED
NO STICKERS ✓

Printed in EU

SCALE 1:35

Maserati logo and model designations are registered trademarks or exclusive propriety of Maserati S.p.A. Under license of Maserati S.p.A. All rights reserved.



UK
CA

CE



24566

105 

MASERATI GHIBLI HYBRID



WARNING: CHOKING HAZARD
Small parts. Not for children under 3 years.

1



x3



x1

2



x2

3

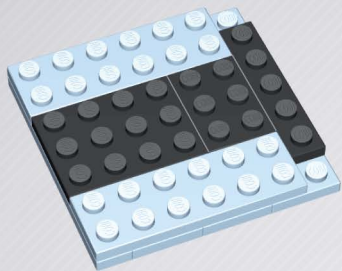

x1

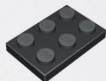

x1



x1

4

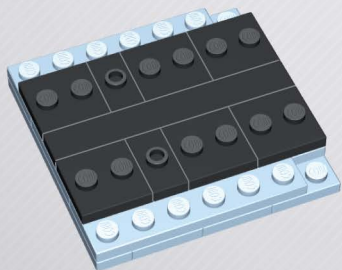

x6



x2



x1

5



x2



x1

6

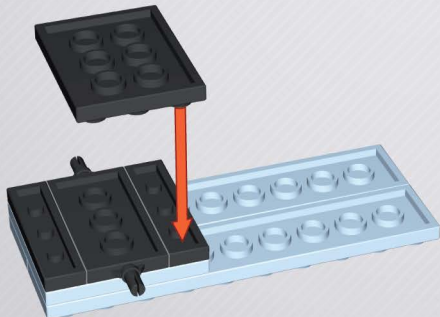

x2



x1



x1

7

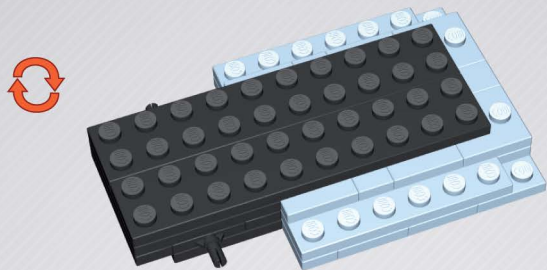

8



xl



xl

9

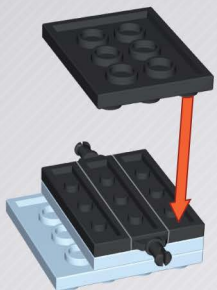

x2



x1



x1

10



11

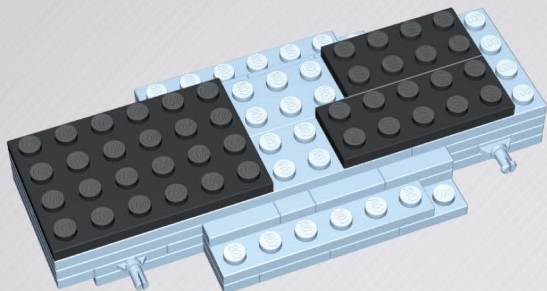

x1



x1



x1

12

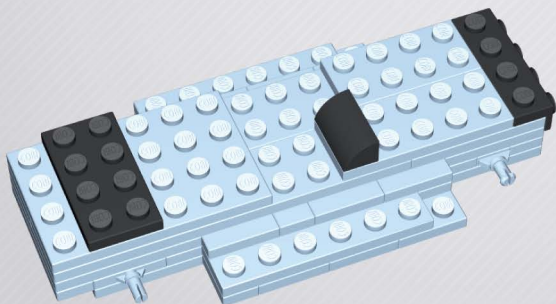

x1



x1



x1

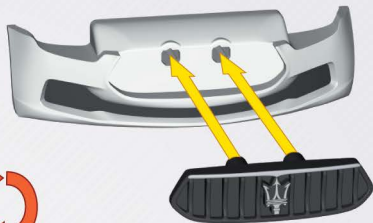
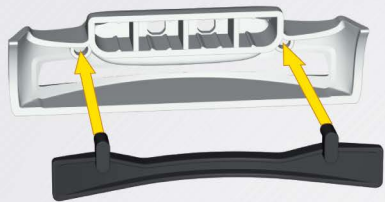

15

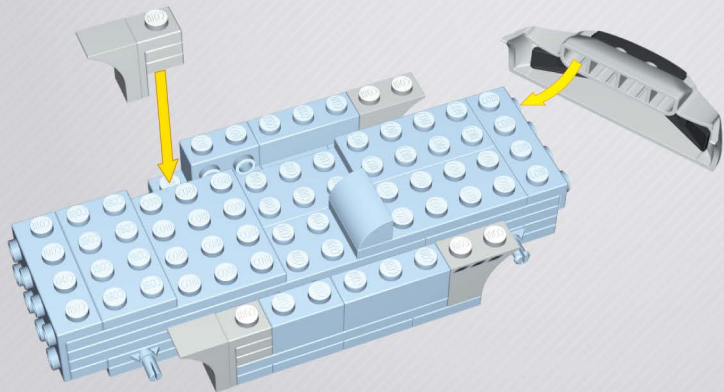

x1



x1



x1



x1



x1

16

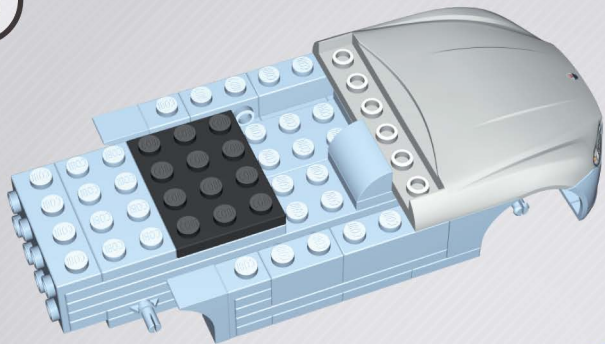

17

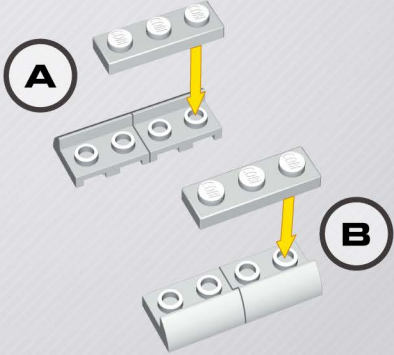
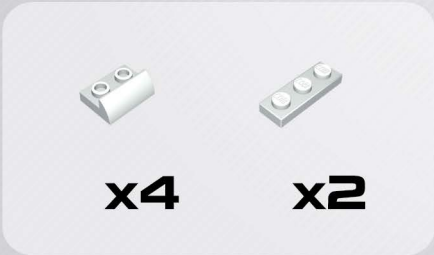

18

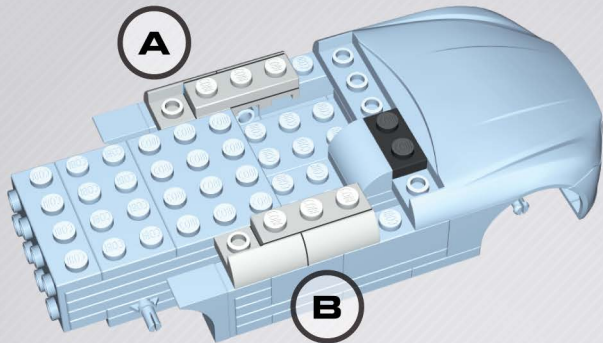

x1

19



x1



x4

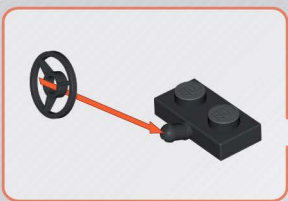

20

 x2

 x1

 x1

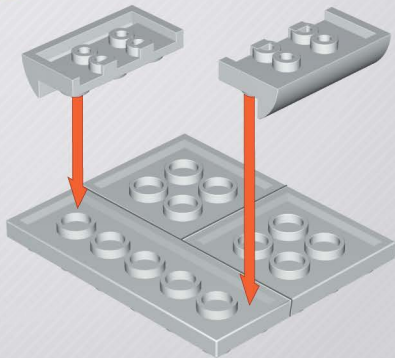
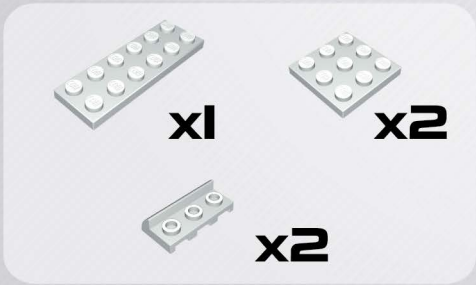
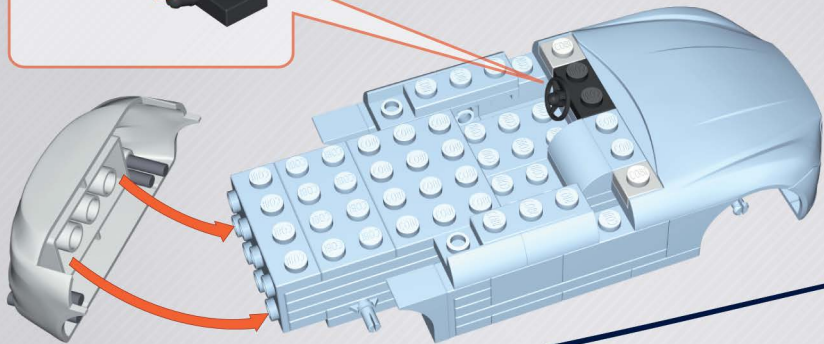

21

22

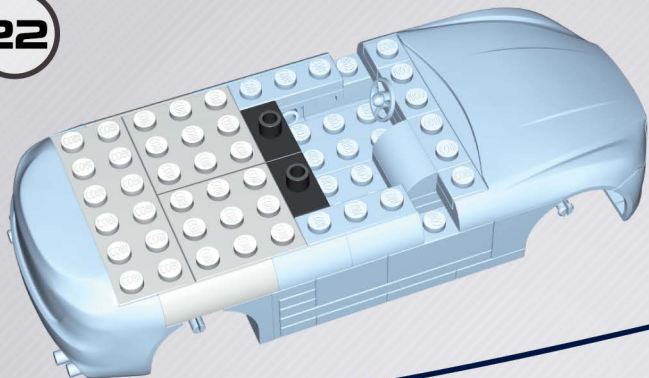

x2

23



x2



x2



x2

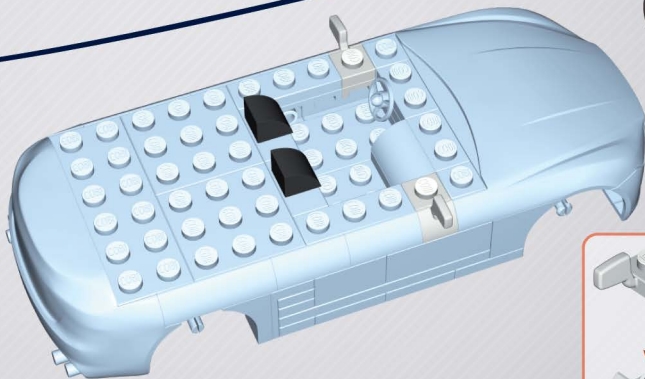

x2

24

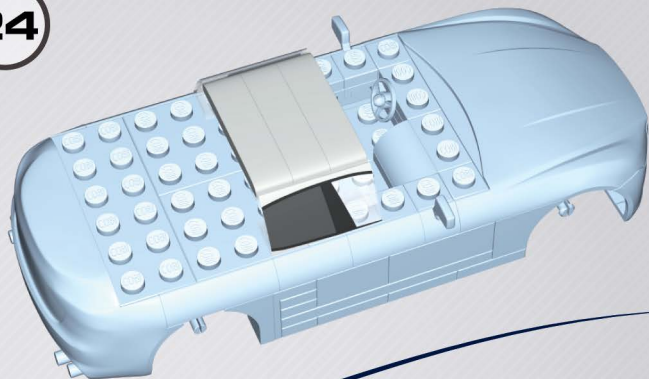
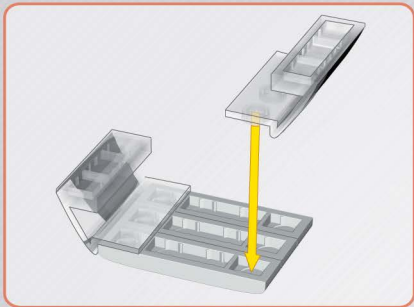

x3



x1



x1



x1



x1

25

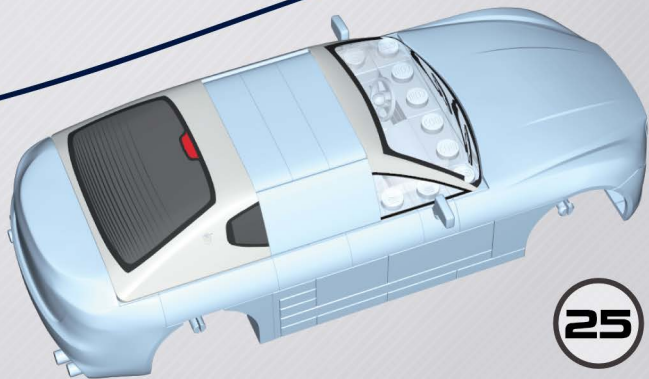

26

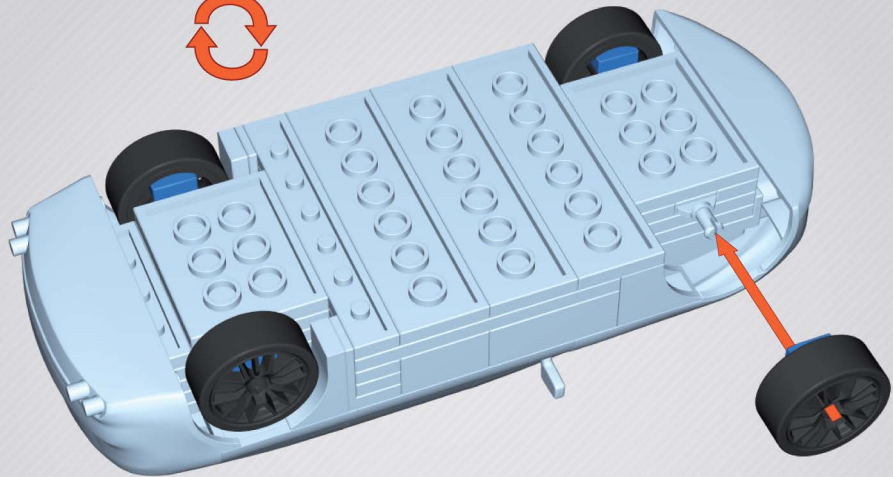

x4



x4



x4

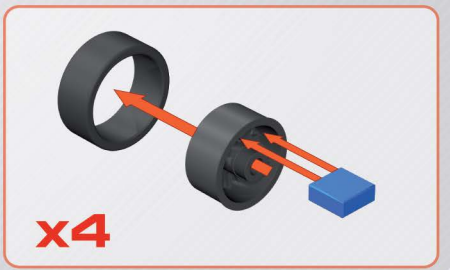

x4



x2
110968



x4
115177



x2
110406



x6
92879



x2
125121



x4
44289



x2
101103



x1
42929



x1
103436



x2
100727



x2
42950



x2
92883



x1
101151



x2
138907



x2
92652



x2
99327



x4
42974



x3
107713



x1
99625



x1
42992



x1
101045

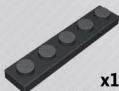

x1
64212



x6
77542



x1
43152

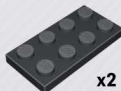

x2
43166



x1
43178



x1
109915



x3
92670



x2
118290



x5
87252



x1
138892



x4
138906



x1
43379



x2
138905



x1
138894



CITROËN 2CV
TYPE A
24510
1:35 SCALE



CITROËN 2CV
TYPE AZ
24511
1:35 SCALE

YOUNGTIMER
collection



CITROËN 2CV
CHARLESTON
24512
1:35 SCALE



Product under License



ABARTH



ABARTH
RACING GARAGE

24501

1:35 SCALE

Manufactured under license of FCA Italy S.p.A. Abarth is a trademark of and licensed by FCA Group Marketing S.p.A.



MASERATI

OFFICIAL LICENSED PRODUCT



Maserati MC20
24335
1:12 scale



Maserati Levante GTS
24569
1:35 scale



Maserati logo and model designations are registered trademarks or exclusive propriety of Maserati S.p.A.
Under license of Maserati S.p.A. All rights reserved.



www.cobi.eu

03-24566-105

Printed in EU

For
news and
special deals

Find us on:

