

**Register Now**   
[www.delonghi.com/register](http://www.delonghi.com/register)

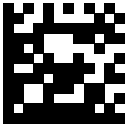

---

EC96XY

# La Specialista MAESTRO

MACCHINA DA CAFFÈ

COFFEE MAKER

MACHINE À CAFÉ

KAFFEEMASCHINE

KOFFIEZETAPPARAAT

CAFETERA

MÁQUINA DE CAFÉ

ΜΗΧΑΝΗ ΓΙΑ ΚΑΦΕ

KAFFEMASKIN

KAFFEMASKIN

KAFFEMASKINE

KAHVINKEITIN

ΚΟΦΕΜΑШИΝΑ

ΚΟΦΕ ЖАСАҒЫШ

ΚΆΝΕΨΌΖΌΓΈΡ

KÁVOVAR

KÁVOVAR

EKSPRES DO KAWY

APARAT DE PREPARAT CAFEA

ماكينة قهوة



---

**De'Longhi**

**IT**

pag. 6

**NO**

sid. 127

**SK**

str. 245

**EN**

page 21

**SV**

sid. 141

**PL**

str. 259

**FR**

pag. 35

**DA**

sid. 155

**RO**

pag. 273

**DE**

S. 50

**FI**

siv. 169

**AR**

2

**NL**

pag. 66

**RU**

стр.184

**ES**

pág. 81

**KZ**

199-6ет

**PT**

pág. 96

**HU**

old. 217

**EL**

σελ 111

**CS**

str. 231

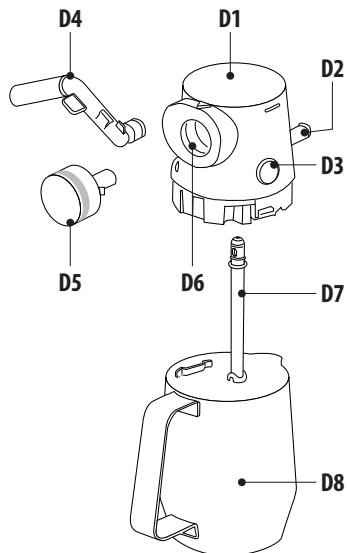
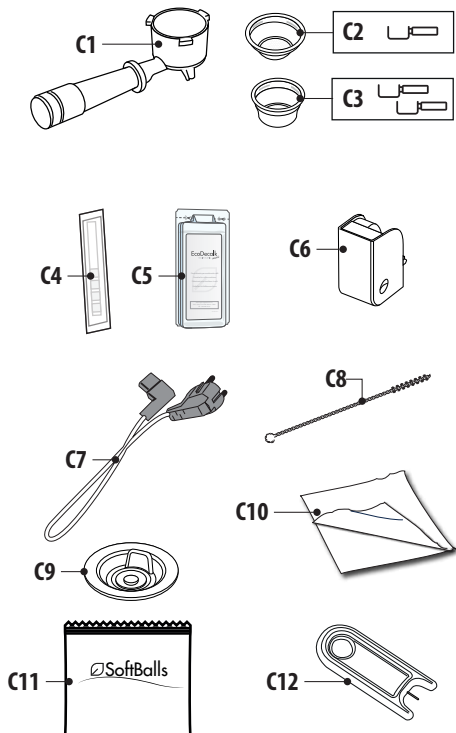
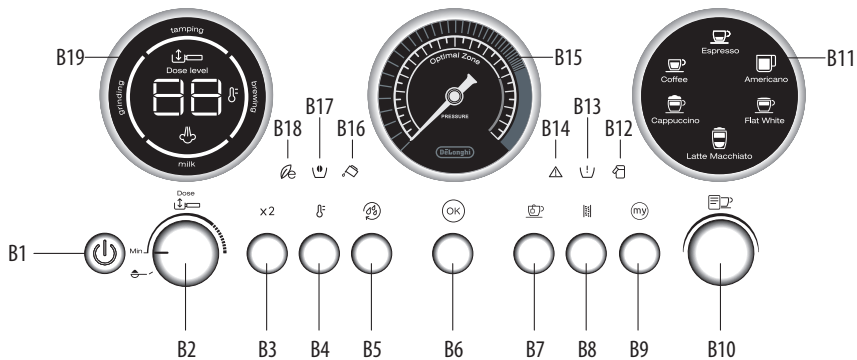

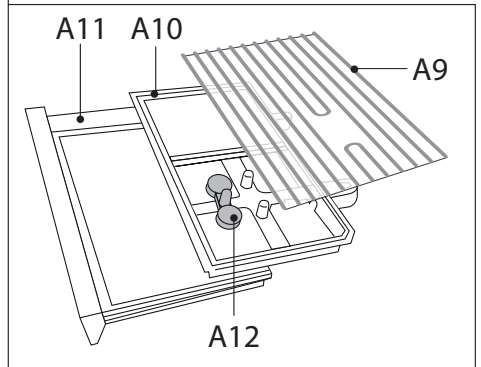
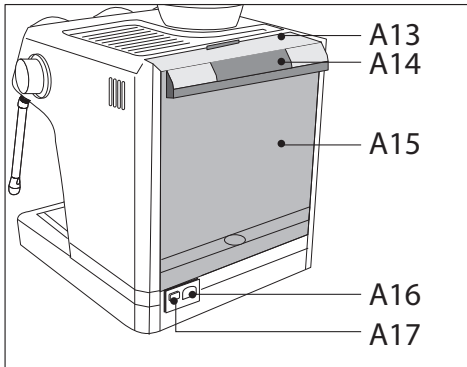
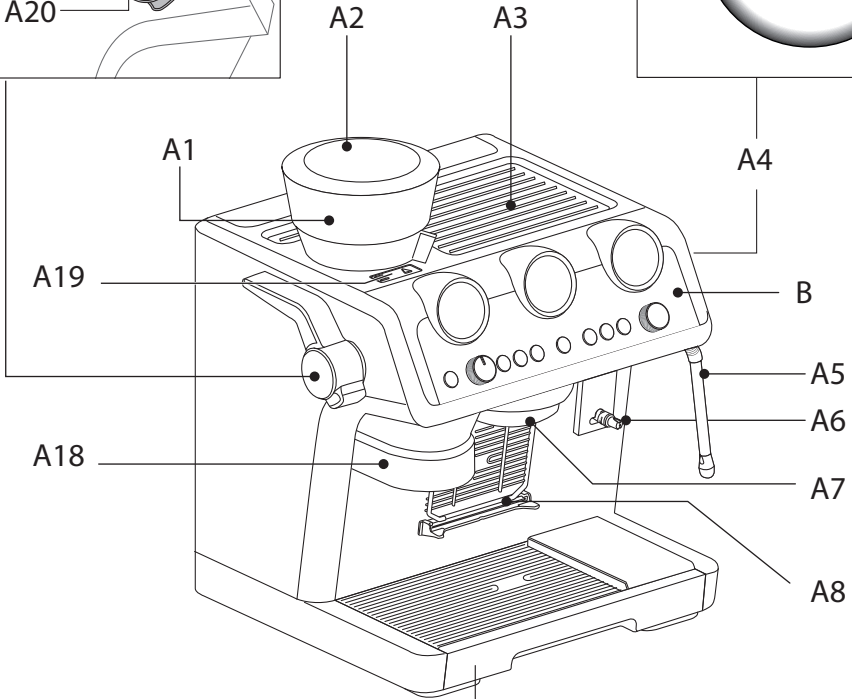
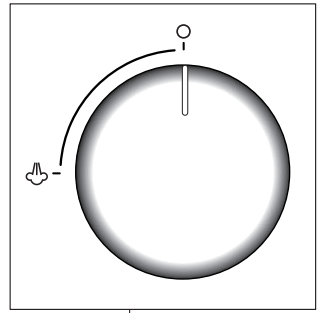
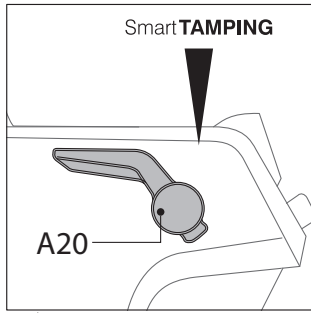

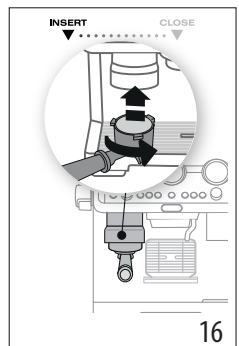
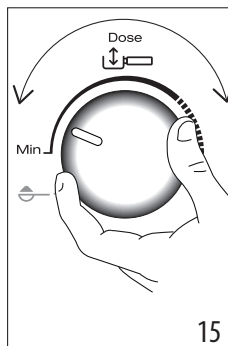
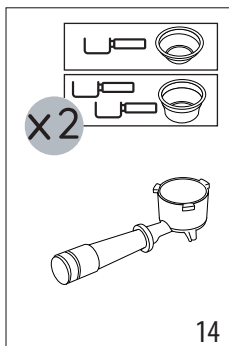
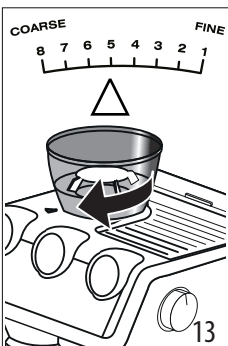
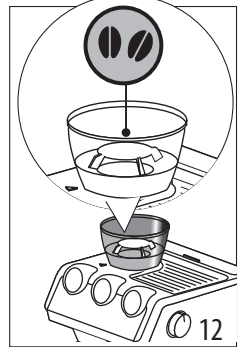
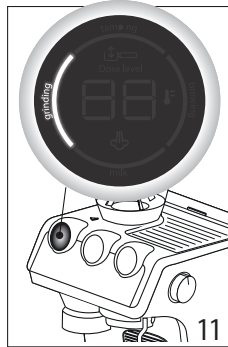
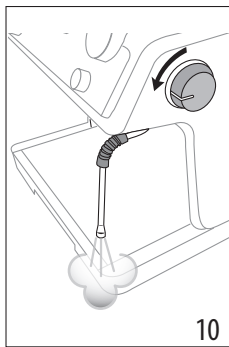
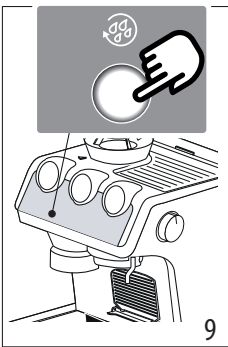
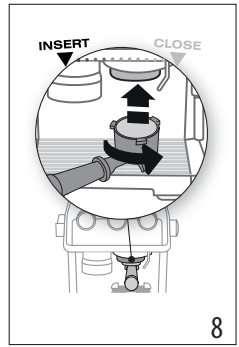
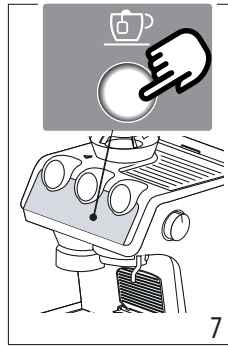
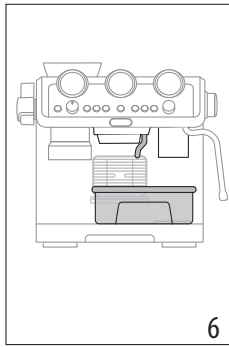
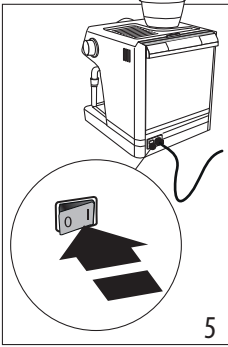
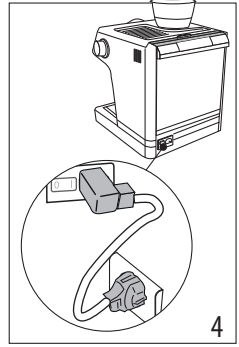
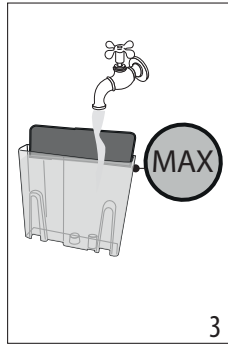
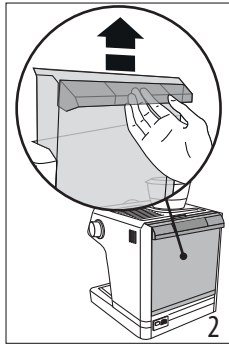
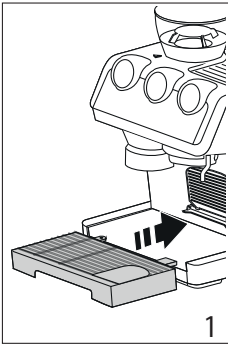

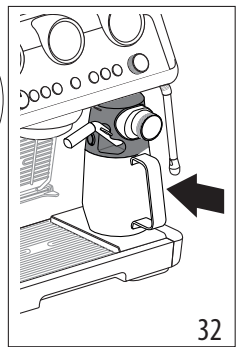
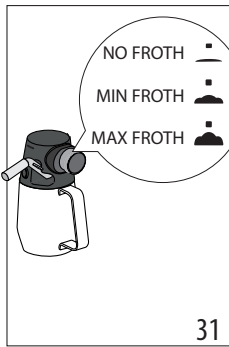
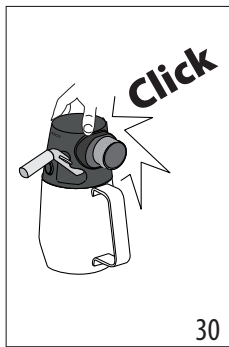
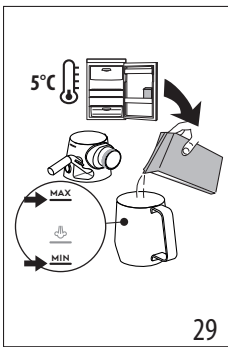
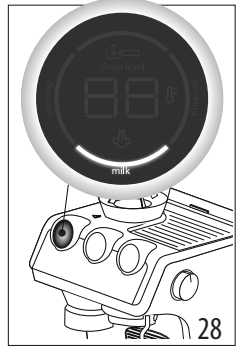
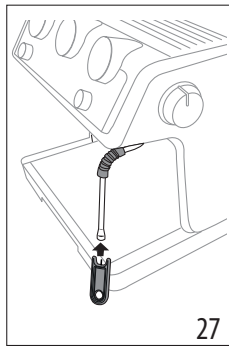
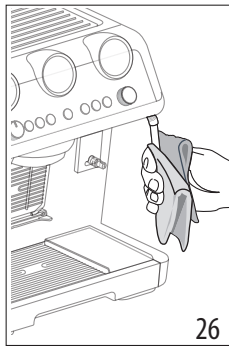
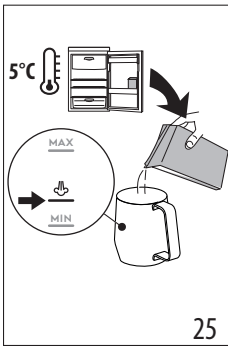
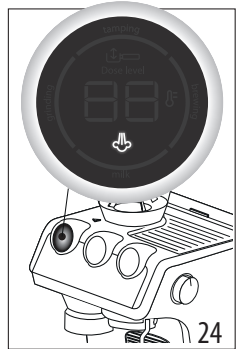
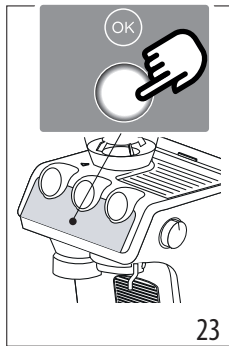
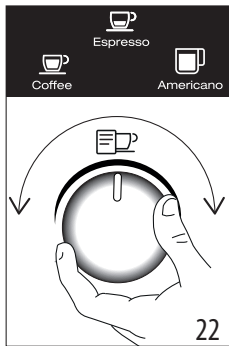
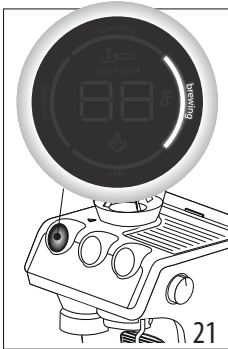
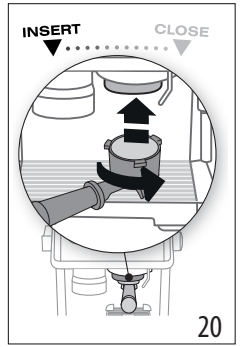
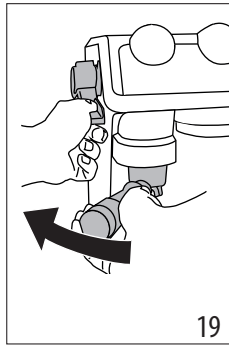
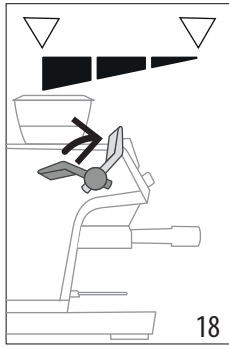
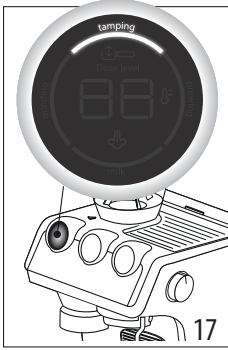

Prima di utilizzare l'apparecchio leggere sempre il fascicolo delle avvertenze di sicurezza.

## 1. DESCRIZIONE

### 1.1 Descrizione dell'apparecchio - A

- A1. Contenitore chicchi
- A2. Coperchio contenitore chicchi
- A3. Poggiatazze
- A4. Manopola vapore
- A5. Tubo erogatore vapore
- A6. Connettore per Lattecrema System
- A7. Erogatore caffè
- A8. Griglia poggiatezze per espresso
- A9. Griglia poggiatezze per bicchieri o mug
- A10. Griglia vaschetta
- A11. Vaschetta raccogliocce
- A12. Indicatore di livello acqua nella vaschetta raccogliocce
- A13. Coperchio serbatoio acqua
- A14. Maniglia estrazione serbatoio acqua
- A15. Serbatoio acqua
- A16. Sede connettore cavo alimentazione
- A17. Interruttore generale (ON/OFF)
- A18. Uscita macinacaffè (Tamping station)
- A19. Sportellino per accedere allo scivolo del macinacaffè
- A20. Leva pressino

### 1.2 Descrizione pannello di controllo - B

- B1. Tasto ON/Standby
- B2. Manopola regolazione quantità caffè macinato
- B3. Tasto "X2": per utilizzare il filtro 2 caffè
- B4. Tasto "temperatura caffè"
- B5. Tasto "risciacquo"
- B6. Tasto "OK": per erogare la bevanda/per confermare
- B7. Tasto "erogazione acqua calda"
- B8. Tasto "decalcificazione"
- B9. Tasto "My": per personalizzare la lunghezza delle bevande
- B10. Manopola selezione funzioni
- B11. Display bevande:

#### Bevande a base di caffè Espresso

- Espresso
- Americano
- Coffee

#### Bevande a base di latte

- Cappuccino
- Flat White
- Latte Macchiato

- B12. Spia "pulizia latte"
- B13. Spia "mancanza contenitore chicchi"
- B14. Spia "allarme generico"
- B15. Manometro

- B16. Spia "mancanza acqua"
- B17. Spia "contenitore chicchi vuoto"
- B18. Spia "risparmio energetico"
- B19. Display impostazioni e processo:

- Indica l'operazione che l'apparecchio sta compiendo
- Indica l'impostazione della dose caffè selezionata
- Indica l'impostazione della temperatura caffè selezionata

### 1.3 Descrizione degli accessori - C

- C1. Coppetta portafiltro
- C2. Filtro 1 tazza
- C3. Filtro 2 tazze
- C4. Striscia reattiva "Total Hardness Test"
- C5. Decalcificante
- C6. Accessorio per decalcificazione
- C7. Cavo alimentazione removibile
- C8. Scovolino
- C9. Accessorio pulizia erogatore caffè
- C10. Panno
- C11. Softballs (addolcitore acqua)
- C12. Ago di pulizia per lancia vapore

### 1.4 Accessori pulizia non inclusi, raccomandati dal costruttore

Per maggiori informazioni, visita [Delonghi.com](http://Delonghi.com).



#### Pastiglie pulizia

(Vedi "8.1 Pulizia dell'erogatore caffè")

 **Detergente**  
EAN: 8004399333307

### 1.5 Descrizione del LatteCrema System - D

- D1. Coperchio contenitore latte
- D2. Connettore contenitore latte
- D3. Pulsante di rilascio del coperchio
- D4. Erogatore latte (regolabile in altezza)
- D5. Manopola regolazione schiuma
- D6. Sede manopola
- D7. Tubo pescaggio latte
- D8. Contenitore latte

## 2. PREPARAZIONE DELL'APPARECCHIO

Lavare con acqua tiepida e detersivo per piatti tutti gli accessori, quindi procedere come segue:

1. Inserire il vassoio raccogliocce (A11) completo di griglia poggiatezze (A9) e griglia vaschetta (A10) (fig. 1);
2. Estrarre il serbatoio acqua (A15) (fig. 2) e riempirlo con acqua fresca e pulita facendo attenzione a non superare la scritta MAX (fig. 3).

3. Quindi reinserire il serbatoio.

**Attenzione:** Non mettere mai in funzione l'apparecchio senza l'acqua nel serbatoio o senza serbatoio.

**Nota bene:** Si consiglia di personalizzare al più presto la durezza dell'acqua seguendo la procedura descritta nel capitolo "7. Menù impostazioni".

### 3. PRIMA MESSA IN FUNZIONE DELL'APPARECCHIO

1. Inserire il connettore del cavo alimentazione (C7) nell'apposita sede (A16) sul retro dell'apparecchio (fig. 4); quindi inserire la spina nella presa. Assicurarsi che l'interruttore generale (A17), posto sul retro dell'apparecchio sia premuto in posizione I (fig. 5);
2. Posizionare sotto l'erogatore acqua calda (in corrispondenza dell'erogatore caffè (A7)) un contenitore con capienza minima di 100 ml (fig. 6);
3. Premere il tasto (B7) in corrispondenza della spia  (fig. 7): l'erogazione inizia e si interrompe automaticamente. Svuotare il contenitore.

Prima di iniziare a utilizzare la macchina, è necessario risciacquare i circuiti interni della macchina. Procedere come segue:

4. Agganciare la coppetta portafiltro (C1) completa di filtro alla macchina: per un aggancio corretto, allineare il manico della coppetta portafiltro a "INSERT" (fig. 8) e ruotare l'impugnatura verso destra, fino ad allinearla alla posizione "CLOSE";
5. Mettere un contenitore sotto la coppetta portafiltro e al tubo erogatore vapore (A5);
6. Premere il tasto (B5) in corrispondenza della spia  (fig. 9): l'erogazione comincia;
7. Finita l'erogazione, ruotare la manopola vapore (A4) (fig. 10) ed erogare vapore per alcuni secondi in modo da risciacquare il circuito vapore: per un'erogazione ottimale di vapore, si consiglia di ripetere quest'operazione per 3 o 4 volte. Questo permette di eliminare l'acqua nel tubo prima di erogare vapore.

L'apparecchio è quindi pronto all'uso.

**Nota bene:** il risciacquo dei circuiti interni è consigliato anche in caso di prolungato inutilizzo dell'apparecchio.

Al primo utilizzo è necessario fare 4-5 caffè prima che la macchina cominci a dare un risultato soddisfacente: dedicare particolare attenzione alla dose caffè macinata nel filtro ((C2) o (C3)) (vedi istruzioni al paragrafo "4.1 Fase 1 - Macinatura (grinding) (fig. 11)").

Procedere come indicato al capitolo "La dose perfetta".

### 4. PREPARARE IL CAFFÈ

#### 4.1 Fase 1 - Macinatura (grinding) (fig. 11)

1. Versare i chicchi nel contenitore (A1) (fig. 12). È consigliabile versare solo i chicchi necessari alla preparazione: in questo modo si utilizzerà sempre caffè fresco;

2. Selezionare il grado di macinatura (fig. 13). L'impostazione di fabbrica è 5 (macinatura media). Se il risultato non fosse soddisfacente, regolare il livello in base al gusto personale e al tipo di caffè (la regolazione va effettuata durante il funzionamento del macinacaffè).
3. Inserire uno dei filtri caffè (C2) o (C3) nel portafiltro (C1) (fig. 14). Se si utilizza il filtro per 2 tazze, premere il tasto 2X (B3): con questa selezione raddoppia anche la quantità erogata di espresso.
4. Regolare la manopola quantità (B2) partendo dalla posizione minima (fig. 15).

**Nota bene:**



I numeri visualizzati sul display (B19) sono un riferimento da annotare una volta raggiunto il livello corretto nel portafiltro.

Non corrispondono alle impostazioni di macinatura, al peso del caffè macinato (gr/oz) o al tempo di macinatura.

Fare riferimento al paragrafo "B3. Tasto "X2": per utilizzare il filtro 2 caffè" per ulteriori indicazioni.

5. Agganciare il portafiltro all'uscita macinacaffè (A18) allineandolo alla scritta INSERT: quindi ruotare verso destra la coppetta (fig. 16). La macinatura inizia quando la coppetta raggiunge la posizione CLOSE e si interrompe automaticamente.

#### Regolare la quantità di caffè macinato nel filtro

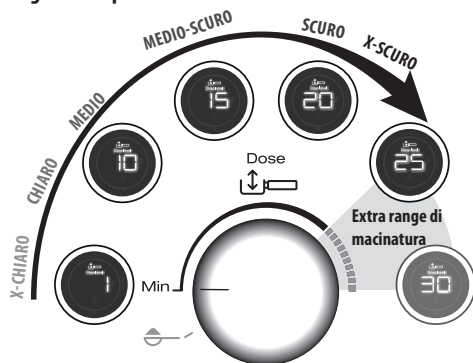

Ogni varietà di chicco dà un risultato diverso durante la macinatura e per questo all'inizio la regolazione della dose richiede estrema cura.

Questa illustrazione dà delle indicazioni su come regolare la dose, basate sul colore di tostatura: sono da considerarsi un punto di partenza, ma possono variare in base alla composizione dei chicchi caffè.

1. Impostare la dose dalla posizione minima.



2. Facendo riferimento al colore di tostatura del vostro caffè, ruotare lentamente la manopola.

#### 4.2 Fase 2 - Pressatura (tamping) (fig. 17)

1. Dopo la macinatura, abbassare la leva pressatura (A20) fino a fine corsa (non rimuovere il portafiltro) (fig. 18). Per un risultato perfetto, ripetere 2 volte.
2. Mantenere abbassata la leva fino a fine corsa durante la rimozione del portafiltro (fig. 19). Poi riportare la leva nella posizione iniziale.
3. Una volta verificato che la dose caffè sia corretta (vedi "La dose perfetta"), agganciare il portafiltro all'erogatore caffè (A7) (fig. 20).

#### La "dose perfetta"

- I filtri caffè, hanno un riferimento interno per identificare la dose perfetta.



#### Marcatura a laser

#### Marcatura in rilievo

- Filtri con marcatura a laser: la dose perfetta corrisponde alla linea superiore della marcatura;
- Filtri con marcatura in rilievo: la dose perfetta corrisponde alla linea in rilievo;
- Assicurarsi che il caffè sia a livello dopo la pressatura. Potrebbe essere necessario regolare più volte la manopola (B2) prima di arrivare alla dose perfetta.
- Se il caffè è sovra- o sotto-estratto e la dose è all'interno della dose perfetta, regolare il grado di macinatura più fine o più grossolana (vedi "4.1 Fase 1 - Macinatura (grinding) (fig. 11)"). Se il caffè è sovra- estratto (erogazione troppo lenta) la macinatura dovrà essere più grossolana. Se il caffè è sotto-estratto (erogazione troppo veloce) la macinatura dovrà essere più fine.
- **Il barista consiglia:** Estrarre il portafiltro mentre la leva del pressino (A20) è abbassata per ottenere una perfetta finitura della dose di caffè.

#### 4.3 Fase 3 - Erogazione (brewing) (fig. 21)

1. Selezionare la bevanda desiderata (fig. 22).
2. Premere OK (B6) per iniziare l'erogazione (fig. 23) (pre-infusione ed infusione). L'erogazione caffè si interrompe automaticamente.

## 5. PREPARAZIONE BEVANDE LATTE

### 5.1 Schiumare il latte (fig. 24)

1. Versare nel contenitore del latte (D8) la quantità di latte che si vuole scaldare/schiumare, tenendo conto che il volume del latte aumenterà di 2 o 3 volte (fig. 25). Per ottenere

una schiuma più densa e omogenea, è consigliabile utilizzare latte vaccino intero ed a temperatura di frigorifero (circa 5°C).

## My Latte Art

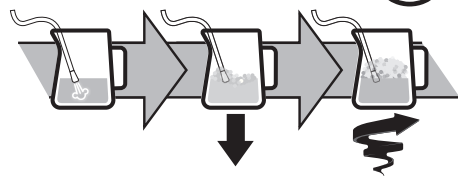

2. Per schiumare il latte, appoggiare il tubo erogatore vapore (A5) sulla superficie del latte: così facendo l'aria si mescola al latte e al vapore.
3. Mantenere l'erogatore vapore sulla superficie, prestando attenzione a non catturare troppa aria creando bolle troppo grosse.
4. Immergere l'erogatore vapore sotto la superficie del latte: in questo modo si crea un vortice. Una volta raggiunta la temperatura desiderata, richiudere la manopola vapore e attendere che l'erogazione vapore si interrompa completamente prima di rimuovere il bricco del latte.

#### Il barista consiglia:

- **Il latte fresco è migliore.** Utilizzare sempre latte fresco a temperatura di frigorifero.
- Il latte intero assicura ottimi risultati. Il risultato e la texture della schiuma variano a seconda del latte vaccino o delle bevande vegetali utilizzate.
- Dopo aver schiumato il latte, eliminare le bolle agitando il bricco del latte.



#### Pulizia dell'erogatore vapore:

1. Dopo ogni uso, rimuovere con un panno i residui di latte dall'erogatore vapore (fig. 26). Per una pulizia profonda, è consigliabile utilizzare Eco MultiClean: assicura l'igiene rimuovendo proteine e grassi del latte e può essere utilizzato per pulire l'intera macchina.
2. Erogare vapore per alcuni secondi per pulire bene l'erogatore (fig. 10).
3. Attendere che l'erogatore si raffreddi: per mantenere l'efficienza dell'erogatore nel tempo, utilizzare l'ago di pulizia (C12) per mantenere liberi i 3 fori (fig. 27).

### 5.2 Preparare le bevande latte con il LatteCrema System (fig. 28)

1. Versare nel contenitore (D8) latte a temperatura di frigorifero (5°C) (fig. 29).
2. Chiudere il coperchio (D1) (fig. 30).

3. Ruotare la manopola regolazione schiuma (D5) sulla posizione desiderata (fig. 31).

Posizione manopola regolazione schiuma				
CLEAN				INSERT
Pulizia dopo ogni uso	Schiuma MAX	Schiuma MED	Schiuma MIN	Per estrarre o inserire la manopola



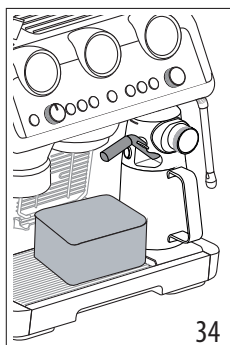
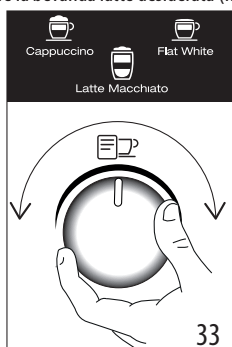

4. Agganciare il contenitore latte alla macchina (fig. 32).  
 5. Preparare la dose perfetta (vedi "4.1 Fase 1 - Macinatura (grinding)" (fig. 11)" e "4.2 Fase 2 - Pressatura (tamping)" (fig. 17)") e inserire il portafiltra.  
 6. Selezionare la bevanda latte desiderata (fig. 33).



3. La pulizia inizia e si interrompe automaticamente. Attenzione: al termine della pulizia, ruotare la manopola su una delle posizioni regolazione schiuma.  
 4. Rimuovere il contenitore latte e riporlo in frigorifero: si consiglia di utilizzarlo entro breve il latte rimanente.

Per una pulizia profonda, è consigliabile utilizzare Eco MultiClean: assicura l'igiene rimuovendo proteine e grassi del latte e può essere utilizzato per pulire l'intera macchina.

## 6. PERSONALIZZARE LA LUNGHEZZA DELLE BEVANDE CAFFÈ CON IL TASTO (B9)

- Preparare la macchina per erogare 1 o 2 tazze della bevanda caffè che si desidera erogare, fino ad agganciare il portafiltra (C1) completo di filtro (C2) o (C3) e caffè macinato. Se si desidera programmare una bevanda a base di latte, collegare il Lattecrema System alla macchina.
- Ruotare la manopola (B10) per selezionare la bevanda da programmare.
- Premere il tasto : la spia corrispondente al tasto OK (B6) si accende fissa e la spia corrispondente al tasto  lampeggia.
- Premere il tasto OK per iniziare l'erogazione. Le spie corrispondenti ai tasti OK e  lampeggiano.
- Una volta raggiunta la quantità desiderata, premere OK. Se la bevanda prevede l'erogazione di un altro ingrediente, comincia l'erogazione di quest'ultimo: una volta raggiunta la quantità desiderata, premere OK.
- Premere il tasto  per salvare. L'apparecchio è pronto per un nuovo utilizzo e la spia  rimane accesa.

Se non si desidera salvare la programmazione, premere qualsiasi altro tasto.

### Nota bene:

- Si possono programmare le bevande con caffè, ma non l'erogazione di vapore e acqua calda.
- La programmazione modifica la quantità delle bevande, ma non del caffè macinato.

Bevanda	Espresso	Latte	Schiuma	Quantità (ml)	X2 (ml)
Cappuccino	1	✓	✓	≈150	≈230
Latte Macchiato	1	✓	✗	≈150	≈230
Flat White	1	✓	✓	≈250	≈330

- Bevande con doppia dose (2x):** Versare nel contenitore (D8) la quantità di latte necessaria per la preparazione, facendo attenzione a non superare il livello MAX (fig. 25). Ogni tacca sul contenitore corrisponde a ≈100 ml di latte.
  - Il latte fresco è migliore.** Utilizzare sempre latte fresco a temperatura di frigorifero.
7. Premere OK (B6) per erogare (fig. 23). L'apparecchio eroga automaticamente caffè e latte in sequenza.







### Pulizia del Lattecrema System dopo ogni uso:

- Lasciare il contenitore latte agganciato alla macchina (non è necessario svuotarlo). Mettere un recipiente sotto il tubo erogazione latte (D4) (fig. 34).
- Ruotare la manopola (D5) su "Clean" (fig. 35).

- Le bevande "X2" possono essere programmate separatamente.

• **My LatteArt**  non è programmabile.

- Per ritornare alle impostazioni di fabbrica, mantenere premuto il tasto  fino allo spegnimento. La bevanda selezionata torna alla quantità di fabbrica.

Ricetta caffè	Quantità di fabbrica	Quantità programmabile
 Espresso	35 ml	da 25 a 90 ml
 Espresso X2	70 ml	da 50 a 180 ml
 Coffee	80 ml	da 50 a 120 ml
 Coffee X2	160 ml	da 120 a 240 ml
 Americano	120 ml	<ul style="list-style-type: none"> <li>• espresso: da 25 a 60ml</li> <li>• acqua: da 25a 120ml</li> </ul>
 Americano X2	240 ml	<ul style="list-style-type: none"> <li>• espresso: da 50 a 120 ml</li> <li>• acqua: da 50 a 240 ml</li> </ul>

## 7. MENÙ IMPOSTAZIONI

### 1. Entrare nel menù:

Premere contemporaneamente per 5 secondi	x2	
--	----	---

### 2. Selezionare l'impostazione da programmare:

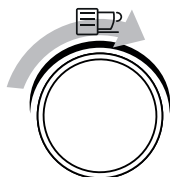

Bevanda	Impostazione corrispondente	Regolazioni
 Espresso	Risparmio energetico	 →  Attivo
		 →  Spento
 Coffee	Auto-spegnimento	 → 9 minuti
		 → 1,5 ore
		 → 3 ore
→		

 Cappuccino	Avviso acustico	 →  Attivo
		 →  Spento
 Latte	Regolazione extra della macinatura	 → Range 1
		 → Range 2
 Flat White	Valori di fabbrica	Mantenere premuto per almeno 5 secondi il tasto OK, finché la spia rimane accesa fissa
 Americano	Durezza acqua	 → dolce
		 → media
		 → dura/molto dura

### 3. Salvare le nuove impostazioni premendo ON/Standby (B1)

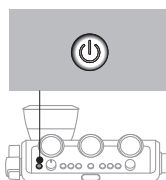













## 8. PULIZIA DELL'APPARECCHIO

### Attenzione!

- Per la pulizia della macchina non usare solventi, detergenti abrasivi o alcool.
- Non utilizzare oggetti metallici per togliere le incrostazioni o i depositi di caffè, perché potrebbero graffiare le superfici in metallo o in plastica.
- Per periodi di inutilizzo superiori alla settimana è consigliato, prima di utilizzare la macchina, di procedere ad un risciacquo.

### Pericolo!

- Durante la pulizia, non immergere mai la macchina nell'acqua: è un apparecchio elettrico.
- Prima di qualsiasi operazione di pulizia delle parti esterne dell'apparecchio, spegnere la macchina, staccare la spina dalla presa di corrente e lasciar raffreddare la macchina.

					
	×	✓	✓	×	×
	✓	×	×	✓	✓
	×	×	×	✓	✓
	×	×	×	✓	✓
	×	×	✓	✓	×
	×	×	×	✓	✓
	✓	✓	×	✓	✓



### 8.1 Pulizia dell'erogatore caffè

Quando la spia  si accende (arancione) (B5), è necessario procedere alla pulizia del circuito caffè. Per eseguire il ciclo di pulizia, acquistare le pastiglie per la pulizia per macchine da caffè. Per maggiori informazioni, visitare [www.Delonghi.com](http://www.Delonghi.com).

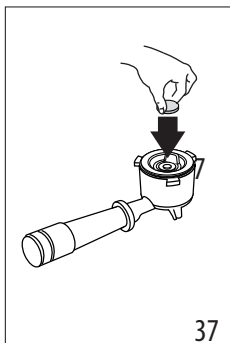
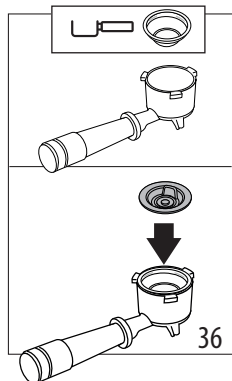
1. Inserire il filtro 1 tazza (C2) nel portafiltro (C1) (fig. 36).
2. Inserire nel filtro l'accessorio pulizia (C9) (fig. 36) e premere a fondo.



3. Mettere la pastiglia per la pulizia sull'accessorio (fig. 37).

4. Attaccare il portafiltro all'erogatore caffè (A7).
5. Riempire il serbatoio acqua (A15). Assicurarsi che la vaschetta raccogliogocce (A11) sia vuota.
6. Mantenere premuto il tasto , finché la relativa spia inizia a lampeggiare (arancione). Dopo alcuni minuti, la pulizia si interrompe automaticamente.
  - Rimuovere il portafiltro e l'accessorio pulizia.
  - Lavare il portafiltro ed il filtro sotto l'acqua corrente.
  - Reinsere il portafiltro e procedere con un risciacquo premendo il tasto  (B5): si consiglia di mettere un contenitore sotto il portafiltro.
  - Rimuovere e svuotare la vaschetta raccogliogocce.

#### Nota bene:

Questo ciclo di pulizia può essere avviato in ogni momento premendo il tasto  (B5) per alcuni secondi. Per cancellare l'operazione, premere il pulsante per 10 secondi.

### 8.2 Pulire l'alloggiamento del contenitore chicchi

1. Assicurarsi che il contenitore chicchi (A1) sia vuoto. Eventualmente procedere con alcune macinature a vuoto per svuotarlo.
2. Sganciare il contenitore ruotandolo in senso antiorario ed estrarlo dalla macchina (fig. 38)

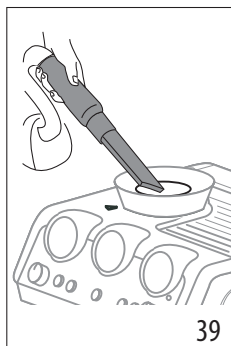
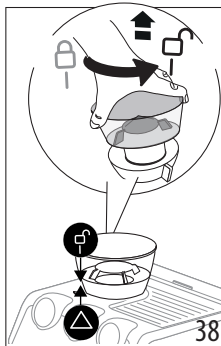

3. Aspirare i residui di caffè (fig. 39).
4. Pulire con un panno umido la sede del contenitore chicchi e asciugare (fig. 40);

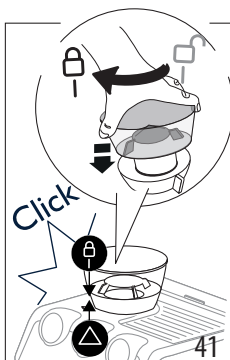
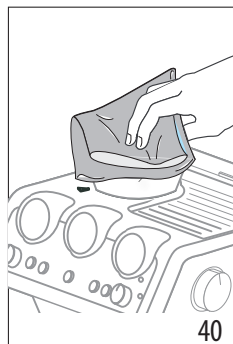

5. Riposizionare il contenitore inserendolo nel macinacaffè. Il contenitore è inserito correttamente quando la freccia ▲ è allineata al simbolo ☐ e si sente un "click" (fig. 41).

### 8.3 Pulizia delle macine

Quando si pulisce il contenitore chicchi (A1), pulire la sede del contenitore e la macina superiore con un panno umido. Rivolgersi ad un centro assistenza per rimuovere e sostituire le macine.

È possibile rimuovere la macina qualora il macinacaffè fosse bloccato da un corpo estraneo. Se questo dovesse accadere, rimuovere il contenitore chicchi e procedere come segue:

1. Agganciare la coppetta portafiltro (C1) e fare una macinatura "a vuoto" per liberare il condotto caffè.
2. Spegner l'apparecchio.
3. Ruotare in senso antiorario il regolatore di macinatura fino a fine corsa, in posizione "REMOVE" (fig. 42).

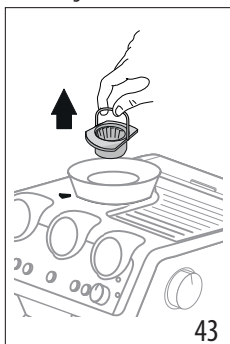
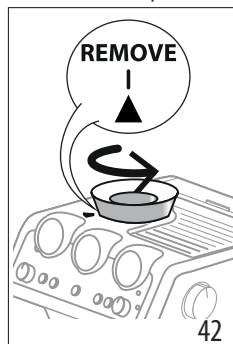

4. Estrarre la parte superiore della macina, afferrandola dall'apposita maniglia (fig.43).
5. Pulire la macina con un pennello (fig. 44) e aspirare i residui di caffè con un aspirapolvere (fig. 39).

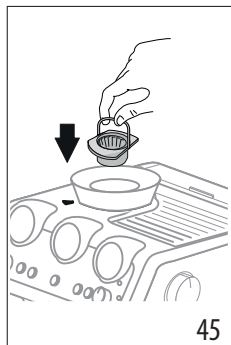
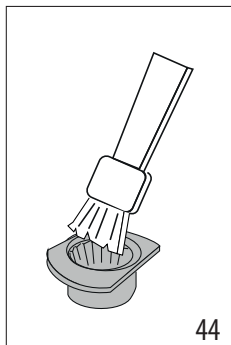

6. Inserire la macina nella sua sede (fig. 45);
7. Ruotare il regolatore selezionando il grado di macinatura desiderato (fig. 13);

Verificare che la macina sia ben inserita, tirandola per la maniglia: la macina è correttamente inserita se non si muove;

### 8.4 Sostituzione delle macine

Quando la quantità di caffè macinato si riduce ancora, rivolgersi ad un centro assistenza per sostituire le macine: poi regolare di nuovo il macinacaffè entrando nel menù impostazioni ("7. Menù impostazioni") e selezionando il primo range della regolazione extra della macinatura. Quindi, ruotare la manopola regolazione quantità (B2) in posizione MIN e regolare la dose come ad il primo utilizzo (vedi "La dose perfetta").

### 8.5 Pulizia della "Smart tamping station"

1. Pulire la zona di aggancio con un pennello (fig. 46).
2. Tirare la leva (A20) fino a fine corsa e pulire con un pennello il pressino (fig.47), quindi rilasciare la leva.
3. Utilizzando lo scovolino (C8), pulire lo scivolo caffè (fig. 48).

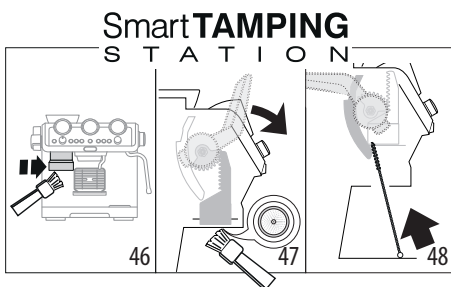

### 8.6 Pulizia del LatteCrema System

Lavare in lavastoviglie tutti i componenti ed il contenitore, posizionandoli però sul cestello superiore della lavastoviglie. Se non si dispone di una lavastoviglie, procedere con il lavaggio a mano come indicato nella nota a fine paragrafo.

1. Premere il pulsante (D3) e sollevare il coperchio del contenitore latte (D1);
2. Sfilare l'erogatore latte (D4) ed il tubo di pescaggio ((D7) (fig. 49);

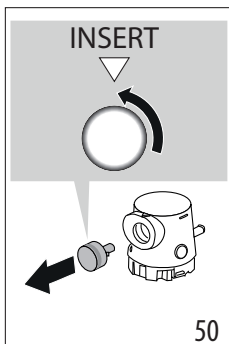
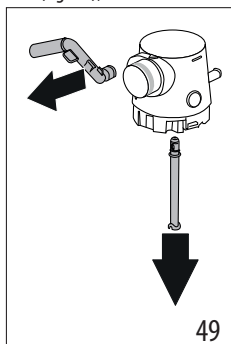

3. Ruotare in posizione "Insert" la manopola ed estrarla (fig. 50);
4. Prestare particolare attenzione che sull'incavo e sul canale situato sotto la manopola (fig. 51) non rimangano residui di latte: eventualmente raschiare il canalino con uno stuzzicadenti;

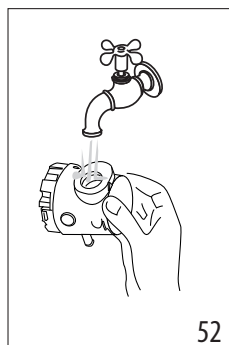
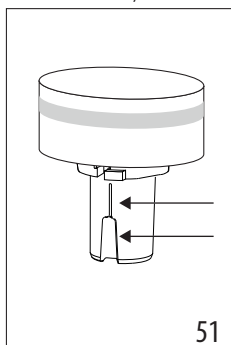

5. Sciacquare l'interno della sede della manopola regolazione schiuma con acqua corrente (fig. 52);
6. Verificare anche che il tubo pescaggio e il tubo erogazione non siano otturati da residui di latte;
7. Riasssemblare tutti i componenti del coperchio;
8. Lavare e risciacquare accuratamente il contenitore latte (D8) ;
9. Riagganciare il coperchio al contenitore latte.







**Nota bene: lavaggio a mano**

Il lavaggio in lavastoviglie assicura una perfetta igiene di tutti i componenti del contenitore latte: nel caso di lavaggio a mano, lavare accuratamente tutti i componenti del contenitore latte con acqua calda e immergerli in una bacinella di acqua calda e di lasciarli per circa 30 minuti, prima di procedere come indicato dal punto 4.

## 9. DUREZZA ACQUA

La spia  (B8) decalcificazione si accende dopo un periodo di funzionamento predeterminato che dipende dalla durezza dell'acqua. È possibile programmare la macchina in base alla reale durezza dell'acqua in utenza nelle varie regioni, rendendo così meno frequente l'operazione di decalcificazione.

1. Togliere dalla sua confezione la striscia reattiva in dotazione "TOTAL HARDNESS TEST" (C4).
2. Immergere completamente la striscia in un bicchiere d'acqua per circa un secondo.
3. Estrarre la striscia dall'acqua e scuoterla leggermente. Impostare l'apparecchio, come indicato nel capitolo "7. Menù impostazioni".

Risultato Test Durezza Acqua	Tasto	Livello
	× 2	1 acqua dolce
		2 acqua media
		3 acqua dura o molto dura
		

4. Impostare l'apparecchio, come indicato nel capitolo "7. Menù impostazioni".

## 10. COME UTILIZZARE SOFTBALLS

Softballs (C11) è un sistema innovativo che allunga la vita della macchina, senza alterare le qualità dell'acqua, garantendo l'erogazione di un caffè cremoso e aromatico. Per ottimizzare l'efficacia, lasciare Softballs nell'acqua per l'intera notte precedente all'uso.

1. Estrarre il pacchetto di Softballs dall'imballo (fig. 53).

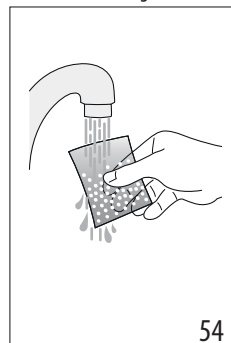
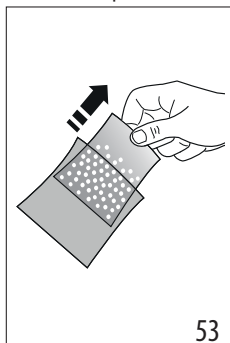

2. Risciacquare con acqua corrente il pacchetto di Softballs (fig. 54).
3. Immergere il sacchetto nel serbatoio acqua (A15) (fig. 55).

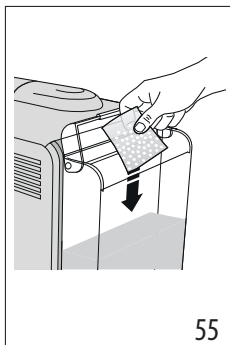

4. Sostituire il sacchetto di Softballs ogni 3 mesi (fig. 56).

## 11. DECALCIFICAZIONE

### Attenzione!

- Prima dell'uso, leggere le istruzioni e l'etichettatura del decalcificante (C5), riportate sulla confezione del decalcificante stesso.
- Si raccomanda di utilizzare esclusivamente decalcificanti De'Longhi. L'utilizzo di decalcificanti non idonei, come pure la decalcificazione non regolarmente eseguita, può comportare l'insorgenza di difetti non coperti dalla garanzia del produttore.
- Il decalcificante può danneggiare le superfici delicate. Se il prodotto viene rovesciato accidentalmente, asciugare immediatamente.

Per effettuare la decalcificazione	
Decalcificante	Decalcificante De'Longhi
Contenitori	2 da 1 litro ciascuno
Tempo	~40min

1. (SE PRESENTE, TOGLIERE IL FILTRO ADDOLCITORE E SOFTBALLS). Versare nel serbatoio acqua (A15) il decalcificante fino al livello  A (corrispondente a una confezione da 100ml) impresso sul lato interno del serbatoio) (fig. 57).

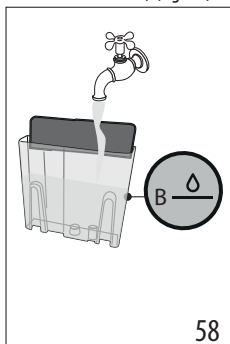
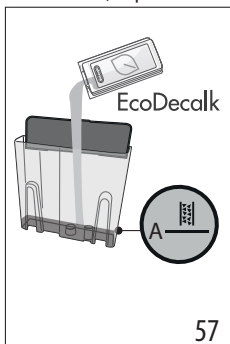

2. Aggiungere acqua fino a raggiungere il livello  B (fig. 58). Reinsерire quindi il serbatoio acqua in macchina.
3. Inserire l'accessorio (C6) al connettore per LatteCrema System (A6) (fig. 59).

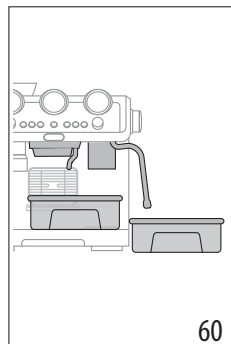
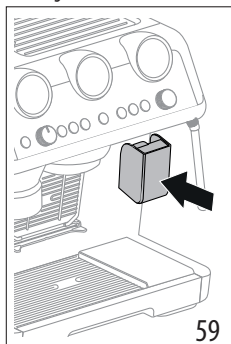

4. Assicurarsi che il portafiltro (C1) non sia agganciato e posizionare un recipiente sotto gli erogatori caffè ed acqua calda (A7), e sotto l'erogatore vapore (A5) (fig. 60).
5. Mantenere premuto il tasto  (B8) finché la spia corrispondente inizierà a lampeggiare.
6. Il programma di decalcificazione si avvia ed il liquido decalcificante esce dagli erogatori. Il programma di decalcificazione esegue automaticamente tutta una serie di risciacqui ad intervalli, per rimuovere i residui di calcare dall'interno della macchina da caffè fino a svuotare il serbatoio.

L'erogazione si interrompe e la spia  diventa bianca. È quindi necessario procedere con il ciclo di risciacquo:

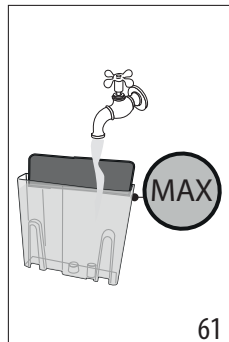

7. Svuotare il recipiente utilizzato per la raccolta del liquido decalcificante e riporlo sotto gli erogatori.
8. Estrarre il serbatoio acqua, svuotarlo da eventuali residui di soluzione decalcificante, sciacquarlo con acqua corrente e riempirlo con acqua fresca fino al livello MAX (fig. 61). Reinsерire quindi il serbatoio nella sua sede.













9. Mantenere premuto il tasto  finché la spia corrispondente inizia a lampeggiare: il risciacquo si avvia.

10. Una volta completato il risciacquo, l'erogazione si interrompe e l'apparecchio è pronto all'uso.
  11. Svuotare i recipienti di raccolta dell'acqua di risciacquo.
  12. Estrarre e svuotare il vassoio raccogli-gocce, quindi reinserirlo.
  13. Estrarre e riempire il serbatoio con acqua fresca, quindi reinserirlo.
- Ora l'apparecchio è pronto all'uso.











**Nota bene:**

- Se si desidera anticipare il ciclo di decalcificazione, mantenere premuto il tasto  per 3 secondi.
- Nel caso la decalcificazione sia stata avviata per sbaglio, premere il tasto  per 10 secondi; il risciacquo non può essere interrotto.

## 12. SIGNIFICATO DELLE SPIE

SPIE	SIGNIFICATO DELLE SPIE	OPERAZIONE
Tutte le spie lampeggiano brevemente	Accensione dell'apparecchio	Autodiagnosi
 fissa	È la prima accensione della macchina ed è necessario procedere al riempimento del circuito acqua	Procedere come indicato al cap. "3. Prima messa in funzione dell'apparecchio"
 fissa	La funzione risparmio energetico è attiva	Fare riferimento al cap. "7. Menù impostazioni" se si desidera disattivare la funzione
 fissa	Il contenitore chicchi (A1) è vuoto	Riempire il contenitore chicchi
 lampeggiante	Si vuole procedere con la macinatura, ma il contenitore chicchi (A1) è vuoto	Riempire il contenitore chicchi
 on	L'acqua nel serbatoio (A15) non è sufficiente oppure il serbatoio acqua non è ben inserito	Riempire il serbatoio oppure estrarre e re-inserire correttamente il serbatoio
 lampeggiante	Si vuole procedere con la preparazione di una bevanda, ma il serbatoio acqua (A15) è vuoto	Riempire il serbatoio acqua
 fissa	Allarme generico	Rivolgersi ad un centro assistenza
 fissa	Il contenitore chicchi non è inserito	Inserire correttamente il contenitore chicchi (A1) o verificare che sia correttamente inserito
 lampeggiante	Il selettore, alla base del contenitore chicchi (A1), non è in posizione corretta	Riportare il selettore in una delle posizioni di macinatura (tra 1 e 8), rammentando di: <ul style="list-style-type: none"> <li>• Regolare la macinatura mentre il macinacaffè è in funzione</li> <li>• Regolare di un livello alla volta e fare almeno 5 macinatura tra una regolazione e l'altra</li> </ul>
	Il contenitore chicchi (A1) non è completamente inserito: interviene il dispositivo di sicurezza	Verificare che il contenitore chicchi sia correttamente inserito
 fissa	Il LatteCrema System deve essere pulito dopo ogni uso	Dopo aver terminato le preparazioni a base di latte, procedere con la pulizia automatica ruotando la manopola (D5) su Clean
		→



SPIE	SIGNIFICATO DELLE SPIE	OPERAZIONE
 fissa	L'apparecchio è pronto per l'erogazione di vapore	L'apparecchio ha raggiunto la temperatura per erogare vapore. Per procedere con l'erogazione, ruotare la manopola vapore (A4)
 lampeggiante	L'apparecchio è acceso e la funzione risparmio energetico è attiva: la manopola vapore (A4) è in posizione per erogare vapore	La spia lampeggia ad indicare che l'apparecchio si sta preparando per erogare vapore: l'erogazione inizia appena l'apparecchio è in temperatura
	L'apparecchio è pronto per l'erogazione di vapore	L'apparecchio è in temperatura per la preparazione di vapore quando la spia rimane fissa
	L'apparecchio sta erogando vapore	
 fissa (arancione)	È necessario procedere con la decalcificazione	Eeguire la decalcificazione come illustrato al cap. "11. Decalcificazione"
 lampeggiante (arancione)	L'apparecchio sta eseguendo la decalcificazione	Procedere completando l'operazione come descritto al cap. "11. Decalcificazione"
 fissa (bianca)	È necessario procedere con con il risciacquo	
 lampeggiante (bianca)	L'apparecchio sta eseguendo il risciacquo	
 fissa (arancione)	È necessario procedere con la pulizia dell'erogatore caffè	Vedi par. "8.1 Pulizia dell'erogatore caffè"
 lampeggiante (arancione)	L'apparecchio sta eseguendo la pulizia dell'erogatore caffè	
 lampeggiante (bianca)	L'apparecchio sta eseguendo un risciacquo	
 lampeggiante	Se è presente il filtro addolcitore, potrebbe essere entrata una bolla d'aria nel circuito, impedendo l'erogazione	Premere il tasto (B7) in corrispondenza della spia  : l'erogazione inizia e si interrompe automaticamente
	La macinatura è troppo fine e quindi il caffè fuoriesce troppo lentamente o non esce del tutto	Estrarre la coppetta portafiltro (C1), ripetere le operazioni per fare il caffè tenendo presente le indicazioni del par. "4.1 Fase 1 - Macinatura (grinding) (fig. 11)"" e "4.2 Fase 2 - Pressatura (tamping) (fig. 17)""
	Il filtro caffè (C2) o (C3) è otturato	Risciacquare i filtri sotto l'acqua corrente o eseguire un risciacquo con il tasto risciacquo (B5)
	Il serbatoio (A15) è mal inserito e le relative valvole non sono aperte	Premere leggermente il serbatoio in modo da aprirne le valvole
	Calcare all'interno del circuito idraulico	Eeguire la decalcificazione come al cap. "11. Decalcificazione"

### 13. SE QUALCOSA NON FUNZIONA

PROBLEMA	CAUSA	SOLUZIONE
C'è dell'acqua nella vaschetta raccogli-gocce (A11)	Fa parte del normale funzionamento dai circuiti interni della macchina	Svuotare e pulire regolarmente la vaschetta raccogli-gocce (A11)
Non esce più il caffè espresso	Mancanza di acqua nel serbatoio (A15)	Riempire il serbatoio
	La spia  (B7) è accesa ad indicare che il circuito caffè o circuito vapore è vuoto	Premere il tasto corrispondente alla spia  per riempire il circuito
	Il filtro (C2) o (C3) è otturato	Risciacquare i filtri sotto l'acqua corrente o eseguire un risciacquo con il relativo tasto (B5)
	Il serbatoio (A15) è mal inserito e le valvole sul suo fondo non sono aperte	Premere leggermente il serbatoio in modo da aprire le valvole sul suo fondo
	Calcare all'interno del circuito idraulico	Eseguire la decalcificazione come al cap. "11. Decalcificazione"
	Macinatura troppo fine	Estrarre la coppetta portafiltro (C1), ripetere le operazioni per fare il caffè tenendo presente le indicazioni del par. "4.1 Fase 1 - Macinatura (grinding) (fig. 11)" e "4.2 Fase 2 - Pressatura (tamping) (fig. 17)"
Il portafiltro non si aggancia all'apparecchio	Il caffè macinato non è stato pressato o è in quantità eccessiva	Ripetere la macinatura con delle impostazioni diverse. Ridurre la quantità della dose: verificare che il filtro (C2) o (C3) (1 o 2 tazze) sia corretto rispetto alla dose da macinare (tasto 2x (B3) selezionato o no)
Il caffè espresso gocciola dai bordi del portafiltro (C1) anziché dai fori	Il portafiltro è male inserito	Agganciare il portafiltro correttamente e ruotarlo fino in fondo con forza
	La guarnizione dell'erogatore caffè (A7) ha perso elasticità o è sporca	Sostituire la guarnizione dell'erogatore caffè presso un Centro Assistenza
	Il filtro (C2) o (C3) è otturato	Risciacquare i filtri sotto l'acqua corrente o eseguire un risciacquo con il tasto corrispondente (B5)
La crema del caffè è chiara (scende velocemente dal beccuccio)	È necessario rivedere le impostazioni dell'apparecchio	Estrarre la coppetta, ripetere le operazioni per fare il caffè tenendo presente le indicazioni del par. "4.1 Fase 1 - Macinatura (grinding) (fig. 11)" e "4.2 Fase 2 - Pressatura (tamping) (fig. 17)"
		→

<b>PROBLEMA</b>	<b>CAUSA</b>	<b>SOLUZIONE</b>
La crema del caffè è scura (il caffè scende lentamente dal beccuccio)	È necessario rivedere le impostazioni dell'apparecchio	Estrarre la cassetta portafiltro (C1), ripetere le operazioni per fare il caffè tenendo presente le indicazioni del par. "4.1 Fase 1 - Macinatura (grinding) (fig. 11)" e "4.2 Fase 2 - Pressatura (tamping) (fig. 17)"
Non si forma la schiuma del latte mentre si fa il cappuccino con il LatteCrema System	Il latte non è abbastanza freddo	Usare sempre latte alla temperatura di frigorifero
	La manopola (D5) non è in posizione corretta	Verificare e ruotare la manopola in posizione corretta ( ☺ max schiuma; ☹ med schiuma; ☹ min schiuma )
	Il LatteCrema System è sporco	Procedere alla pulizia come illustrato al paragrafo "8.6 Pulizia del LatteCrema System"
	Calcare all'interno del circuito idraulico	Eeguire la decalcificazione come al cap. "11. Decalcificazione"
Al termine della decalcificazione, l'apparecchio richiede un altro risciacquo	Durante il ciclo di risciacquo, il serbatoio non è stato riempito fino al livello MAX	Ripetere il risciacquo (vedi cap. "11. Decalcificazione")
L'apparecchio non macina il caffè	All'interno del macinacaffè è presente un corpo estraneo	Procedere alla pulizia delle macine come indicato al par. "8.3 Pulizia delle macine", assicurandosi di aver rimosso tutti i chicchi dal contenitore chicchi (A2) prima di estrarlo. Prima di reinserire la macina, aspirare accuratamente ogni residuo dalla sua sede
	Il contenitore chicchi (A1) non è in posizione corretta	Il contenitore è inserito correttamente quando la freccia ▲ è allineata al simbolo ☞ e si sente un "click"
→		

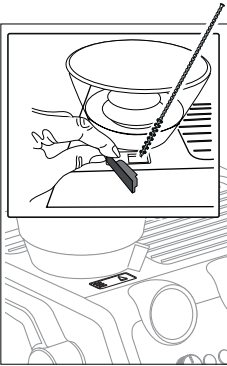
PROBLEMA	CAUSA	SOLUZIONE
Se si desidera cambiare qualità di caffè	È necessario eliminare tutti i chicchi presenti nella macchina	<ul style="list-style-type: none"> <li>• Svuotare il contenitore chicchi (A1) (facendo delle macinature a vuoto o eventualmente aspirando i chicchi residui)</li> <li>• Agganciare la coppetta portafiltro (C1) e fare delle macinature “a vuoto” per liberare il condotto caffè: agganciare quindi il portafiltro all’uscita macinacaffè (A18) allineandolo alla scritta INSERT e ruotare verso destra la coppetta (fig. 22). La macinatura inizia quando la coppetta raggiunge la posizione CLOSE e si interrompe automaticamente. Ripetere finché il filtro rimane vuoto</li> <li>• Inserire nel contenitore (A1) la nuova varietà di chicchi di caffè</li> <li>• Se alla macinatura non si raggiunge la “dose perfetta”, procedere come al primo utilizzo</li> </ul>
<p>Dopo la macinatura, il filtro caffè (C2) o (C3) è vuoto</p> <p>Dopo la macinatura, la polvere caffè nel filtro è sovrabbondante</p>	Lo scivolo caffè del macinacaffè è intasato	<p>Procedere alla pulizia come indicato al par. “8.5 Pulizia della “Smart tamping station””. Se il problema persiste, accedere allo scivolo aprendo l’apposito sportellino (A19) e liberarlo utilizzando lo scovolino</p> 
		→

<b>PROBLEMA</b>	<b>CAUSA</b>	<b>SOLUZIONE</b>
Dopo la macinatura, la polvere caffè nel filtro (C2) o (C3) non raggiunge la "dose perfetta"	La "Smart Tamping Station" necessita pulizia	Procedere alla pulizia come indicato al par. "8.5 Pulizia della "Smart tamping station", quindi ripetere la macinatura
	È necessario regolare la quantità di caffè macinato	Regolare la quantità con la manopola dedicata (B2) seguendo le indicazioni al par. "La "dose perfetta"". Se la manopola è già in posizione max, procedere come indicato nella sezione "Regolazione extra della macinatura"
	Con il tempo le macine si usurano	Procedere alla sostituzione delle macine come indicato al par. "8.4 Sostituzione delle macine"

Before using the appliance, always read the safety warnings.

## 1. DESCRIPTION

### 1.1 Description of appliance - A

- A1. Beans container
- A2. Beans container lid
- A3. Cup tray
- A4. Steam dial
- A5. Steam wand
- A6. Lattecrema System connection
- A7. Coffee outlet
- A8. Cup grille for espresso
- A9. Cup grille for glasses or mugs
- A10. Drip tray grille
- A11. Drip tray
- A12. Drip tray water level indicator
- A13. Water tank lid
- A14. Water tank extraction handle
- A15. Water tank
- A16. Power cord connector socket
- A17. Main switch (ON/OFF)
- A18. Coffee mill outlet (tamping station)
- A19. Cover to access the coffee mill coffee guide
- A20. Presser lever

### 1.2 Description of control panel - B

- B1. ON/Standby button
- B2. Coffee dose dial
- B3. "X2" button: to use the 2 coffees filter
- B4. Coffee Temperature button
- B5. "Active Rinse" button
- B6. "OK" button: to deliver the beverage/confirm
- B7. Hot water button
- B8. "Descaling" button
- B9. "My" button: to customise beverage quantity
- B10. Beverage selector dial
- B11. Beverage selected light:

#### Espresso based beverages

- Espresso
- Americano
- Coffee

#### Milk based beverages

- Cappuccino
- Flat White
- Latte Macchiato
- B12. "Milk clean" light
- B13. "No beans container" light
- B14. "General alarm" light
- B15. Pressure gauge
- B16. "No water" light

- B17. Beans container empty light
- B18. "Energy saving" light
- B19. Led module process:
  - Indicates the operation the appliance is running
  - The setting of the dose level
  - The infusion temperature setting

### 1.3 Description of accessories - C

- C1. Portafilter
- C2. 1-cup coffee filter
- C3. 2-cups coffee filter
- C4. "Water hardness test" indicator paper
- C5. Descaler
- C6. Descaling accessory
- C7. Removable power cord
- C8. Tube brush
- C9. Coffee outlet cleaning disk accessory
- C10. Cloth
- C11. Softballs
- C12. Cleaning needle for steam wand

### 1.4 Optional cleaning accessories

Visit [Delonghi.com](http://Delonghi.com) for more information.



#### Cleaning tab

(See "8.1 Cleaning of the coffee outlet")

 **Cleaner**  
EAN: 8004399333307

### 1.5 Description of LatteCrema System - D

- D1. Milk container lid
- D2. Milk container connector
- D3. Lid release button
- D4. Milk spout (adjustable height)
- D5. Froth selection knob
- D6. Knob housing
- D7. Milk intake tube
- D8. Milk container

## 2. PREPARING THE APPLIANCE

Wash all accessories with warm water and washing-up liquid, then proceed as follows:

1. Insert the drip tray (A11) complete with cup grill (A9) and drip tray grille (A10) (fig. 1);
2. Extract the water tank (A15) (fig. 2) and fill with fresh clean water, taking care not to exceed the MAX level (fig. 3).
3. Put the tank back in the appliance.

**Important:** *Never operate the appliance without water in the tank or without the tank.*

**Please note:** You should customise water hardness as soon as possible following the instructions in section "7. Menu settings".

### 3. SETTING UP THE APPLIANCE

1. Plug the power cord connector (C7) into the socket (A16) at the back of the appliance (fig. 4); then plug the plug into the mains socket. Make sure the main switch (A17), at the back of the appliance is pressed and in the I position (fig. 5);
2. Place a container with a minimum capacity of 100 ml under the hot water spout (A7) and cappuccino maker (fig. 6);
3. Press the button (B7) corresponding to the ☒ light (fig. 7). Delivery begins and stops automatically. Empty the container.

Before using the machine, you must rinse the internal circuits. Proceed as follows:

4. Attach the filter holder (C1) complete with filter to the appliance. To attach correctly, align the filter holder handle with "INSERT" (fig. 8), then turn the handle to the right until it is aligned in the "CLOSE" position;
5. Place a recipient under the filter holder and cappuccino maker (A5);
6. Press the button (B5) corresponding to the ☉ light. Delivery begins (fig. 9);
7. When delivery is complete, turn the steam dial (A4) (fig. 10) and deliver steam for a few seconds to rinse the steam circuit; or optimal steam performance we recommend you repeat this action 3 or 4 times. This is to purge the steam arm before frothing or steaming your milk.

The appliance is ready for use.

**Please note:** We also recommend rinsing the internal circuits if the appliance is not used for a long period.

The first time you use the appliance, you need to make 4-5 cups of coffee before the appliance starts to give satisfactory results. Pay particular attention to the quantity of pre-ground coffee in the filter ((C2) or (C3)) (see instructions in section "4.1 Step 1 - grinding (fig. 11)").

Proceed as described in section "The „perfect dose“".

### 4. COFFEE DELIVERY

#### 4.1 Step 1 - grinding (fig. 11)

1. Add beans to hopper (A1) (fig. 12). Fresh is best; fill in just with the quantity you need.
2. Select the finess (fig. 13). The factory setting is 5 (medium grinding). if you are not satisfied, adjust the level according to your personal taste and the type of coffee (do it while grinding).
3. Select single (C2) or double dose filter (C3) and place in the portafilter (C1) (fig. 14). If you are using the double filter, press the X2 button (B3): this will double the volume of the espresso shot as well.

4. Set the dose level by adjusting the dial (B2) starting from the min. position. (fig. 15).

**Please note:**



The numbers displayed on the indicator (B19) are a setting reference once the right level of coffee in the portafilter is reached. They do not correspond to grinder settings or to measurement units (gr/oz) or to grinding time. Refer to "The „perfect dose“" for

suggestions.

5. Attach portafilter to the coffee mill outlet (A18) aligning it with "INSERT": then turn the portafilter to the right (fig. 16). Grinding begins when the filter holder reaches the CLOSE position and stops automatically.

#### 4.2 Adjust dose

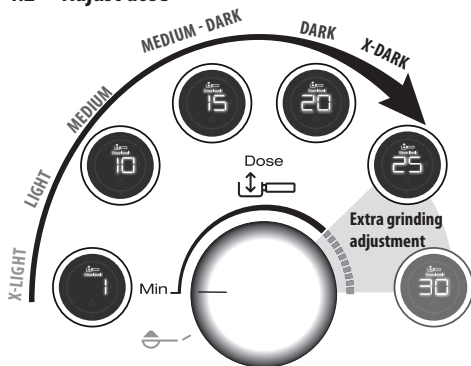

Each variety of coffee beans can behave differently during grinding and this is the reason why setting the dose at the beginning might require extra care.

With this illustration we give you some indications on how to regulate the dose. Please note these suggested setting ranges, based on the roasting level, are certainly a good starting point, but they might slightly vary depending on specific composition of your coffee beans.

1. Set the dose starting from the minimum position.
2. Look at which roasting level your coffee is and based on that, turn the knob slowly, referencing the ranges.

#### 4.3 Step 2 - tamping (fig. 17)

1. After grinding, pull the lever (A20) down fully (do not remove portafilter) (fig. 18). For a perfect result, you can do it twice.
2. Keep the lever down while removing the portafilter (fig. 19). Once it is done, place back the lever in its original position.
3. Check the dose (see "The „perfect dose“") and attach the portafilter to the brewing unit (A7) (fig. 20).

### The „perfect dose“

- A reference mark inside the coffee filters identifies the perfect quantity.

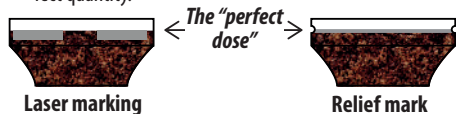

- Laser marked filters: the perfect quantity corresponds to the top line of the mark.
- Filters with relief mark: the perfect quantity corresponds to the line in relief.
- Ensure the coffee is at the recommended dosage level after tamping. You may need to adjust the dosage dial (B2) more times before reaching the perfect dose.
- If your coffee is over or under extracted and the dose is within the perfect dose range, adjust the grinder settings finer or coarser (see “4.1 Step 1 - grinding (fig. 11)”). Over extracted coffee (pouring too slowly) needs coarser grind. Under extracted coffee (pouring too fast) needs finer grind.
- **Barista tip:** Pull the filter holder out while the tamper (A20) is still down for polished finish of coffee.

### 4.4 Step 3 - brewing (fig. 21)

1. Select your beverage (fig. 22).
2. Press OK (B6) to start brewing (fig. 23) (preinfusion and infusion). Coffee delivery stops automatically.

## 5. MAKING MILK BEVERAGES

### 5.1 Manual frothing (fig. 24)

1. Fill the milk jug (D8) with fresh cold milk. Milk will up to triple in volume (fig. 25). For a denser more even froth, you should ideally use whole cow's milk at refrigerator temperature (about 5°C)

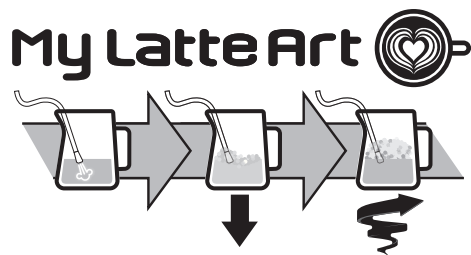

2. To make the froth, put the nozzle (A5) on the surface of the milk and air will catch by the mixing of milk and steam.
3. Keep the steam nozzle just on the surface, careful not to make big bubbles by letting too much air in.
4. Insert the steam nozzle just under the milk: this create a vortex. Once the desired temperature is reached turn the steam knob off and wait till steam stops completely before removing jug.

### Barista tips:









- **Fresh is best :** Be sure to use fresh cold milk every time.
- Whole milk is recommended for best results. Dairy and Non Dairy alternatives will vary in ease of texturing depending on type.
- After foaming milk, eliminate unwanted bubbles by swirling the pitcher.

### Cleaning the steam wand:

1. After every use, remove with a soft damp cloth any milk residues from the steam wand (fig. 26). For perfect cleaning, we recommend Eco MultiClean: it ensures hygiene by removing milk proteins and fats and can be used to clean the whole machine.
2. Use the steam for a deeper cleaning (fig. 10).
3. Wait that the steam wand cool down and open the 3 holes of the nozzle with the Cleaning tool (C12) to maintain the better usability of the steam wand (fig. 27).

### 5.2 Making milk beverages with LatteCrema System (fig. 28)

1. Fill the milk container (D8) with fresh cold milk from the refrigerator (5°C) (fig. 29).
2. Close with the lid (D1) (fig. 30).
3. Turn the knob (D5) to select the desired froth (fig. 31).

Milk froth knob positions:				
				
CLEAN				INSERT
To clean LatteCrema System after each use	MAX froth	MED froth	MIN froth	To extract or insert the knob

4. Attach the milk container (fig. 32).
5. Prepare the perfect dose (see “4.1 Step 1 - grinding (fig. 11)” and “4.3 Step 2 - tamping (fig. 17)”) and attach the portafilter.
6. Select your beverage (fig. 33).

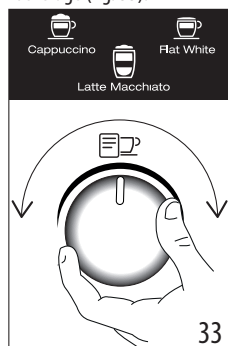



Beverage	Espresso	Milk	Froth	Quantity (ml)	X2 (ml)
Cappuccino	1	✓	✓	≈150	≈230
Latte Macchiato	1	✓	✗	≈150	≈230
Flat White	1	✓	✓	≈250	≈330

- **Double dose milk beverages (2x):** Fill the milk container (D8) with a sufficient quantity of milk, not exceeding the MAX level marked on the container (fig. 25). Each mark on the side of the container corresponds to about 100 ml of milk.
  - **Fresh is best.** Using fresh cold full cream milk will achieve the best results.
7. Press OK (B6) to start brewing (fig. 23). The appliance automatically brews coffee and milk in sequence.

#### Cleaning Lattecrema System after every use:

1. Leave the milk container in the machine (you do not need to empty it). Place a cup or other recipient under the frothed milk spout (D4) (fig. 34).
2. Turn the knob (D5) to "Clean" (fig. 35).

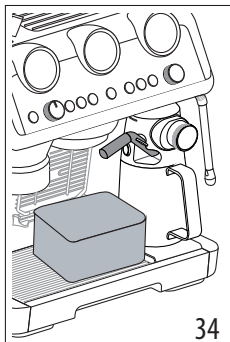

3. Cleaning automatically starts and stops. **Watch out:** Remember, after cleaning, to turn the knob back on foam setting.
4. Remove the milk container and put it in the refrigerator and use soon.

For perfect cleaning, we recommend Eco MultiClean : it ensures hygiene by removing milk proteins and fats and can be used to clean the whole machine.







## 6. CUSTOMISING THE QUANTITY OF COFFEE BEVERAGES WITH THE (my) BUTTON (B9)

1. Prepare the appliance to deliver 1 or 2 cups of the coffee beverage you want to make, as far as attaching the portafilter (C1) complete with the (C2) or (C3) filter and ground coffee. If you have to customise a milk based beverage, prepare and also attach the Lattecrema System
2. Turn the dial (B10) to select the drink to be programmed..

3. Press the (my) button: the light corresponding to the OK button (B6) comes on steadily and the light corresponding to the (my) button flashes.
4. Press the OK button to start delivering the beverage. The lights corresponding to the OK and (my) buttons flash.
5. When you have reached the desired quantity of the beverage, press the OK button again. If the recipe includes another ingredient, it starts delivery: when you have reached the desired quantity, press the OK button again.
6. Press the (my) button to save the new setting. The appliance is ready for use again and the (my) button remains on. If you do not want to save the new setting, press any other button.











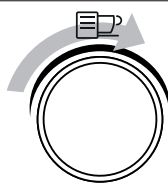











#### Please note:

- You can programme coffee beverages, but not steam and hot water.
- Programming changes the quantity of the beverages, but not the amount of coffee ground.
- "X2" beverages can be programmed separately.
- **My LatteArt**  is not programmable.
- **To reset** the default beverage quantities, **press and hold** the (my) button until it goes off. The selected beverage is reset to the default values.

Coffee Recipe	Default quantity	Programmable quantity
 Espresso	35 ml	from 25 to 90 ml
 Espresso X2	70 ml	from 50 to 180 ml
 Coffee	80 ml	from 50 to 120 ml
 Coffee X2	160 ml	from 120 to 240 ml
 Americano	120 ml	<ul style="list-style-type: none"> <li>• espresso: from 25 to 60 ml</li> <li>• water: from 25 to 120 ml</li> </ul>
 Americano X2	240 ml	<ul style="list-style-type: none"> <li>• espresso: from 50 to 120 ml</li> <li>• water: from 50 to 240 ml</li> </ul>

## 7. MENU SETTINGS

<b>7. Enter the setting menu</b>	➔
----------------------------------	---

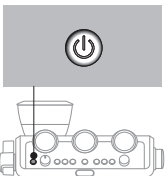
Press both buttons for 5 seconds		x2	
<b>8. Select the setting</b>			
			
Beverage	Corresponding setting	How to set	
 Espresso	Energy saving	 →  On	
		 →  Off	
 Coffee	Auto off	 → <b>9 minutes</b>	
		 → <b>1,5 hours</b>	
		 → <b>3 hours</b>	
 Cappuccino	Beep	 →  On	
		 →  Off	
 Latte	Extra grinding adjustment	 → <b>1<sup>st</sup> range</b>	
		 → <b>2<sup>nd</sup> range</b>	
 Flat White	Default values	Keep pressed <b>OK</b> button for 5 seconds, until led stay fixed	
 Americano	Water hardness	 → <b>soft</b>	
		 → <b>medium</b>	
		 → <b>hard/very hard</b>	
<b>9. Save new settings by pressing the ON/Standby button (B1)</b>			
			













## 8. CLEANING AND MAINTENANCE

### Important!

- Do not use solvents, abrasive detergents or alcohol to clean the coffee machine.
- Do not use metal objects to remove encrustations or coffee deposits as they could scratch metal or plastic surfaces.
- If the appliance is not used for more than a week, before using it again, we recommend you perform a rinse cycle.

### Danger!

- While cleaning, never immerse the coffee maker in water. It is an electrical appliance.
- Before cleaning the outside of the appliance, turn it off, unplug from the mains socket and allow to cool.



					
	×	✓	✓	×	×
	✓	×	×	✓	✓
	×	×	×	✓	✓
	×	×	×	✓	✓
	×	×	✓	✓	×
	×	×	×	✓	✓
	✓	✓	×	✓	✓

### 8.1 Cleaning of the coffee outlet

When the  light comes on (orange) (B5), you have to proceed cleaning the coffee circuit. To run the cleaning, you have to purchase dedicated cleaning tabs for coffee makers. For more info, please visit [Delonghi.com](http://Delonghi.com).

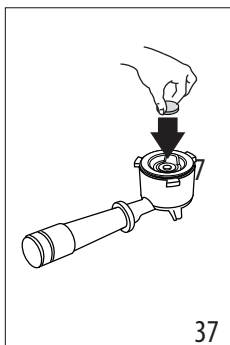
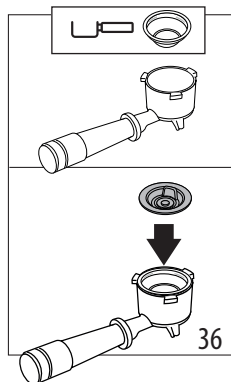
- Insert the 1-cup coffee filter (C2) in the portafilter (C1) (fig. 36).
- Put on the coffee filter the special disk accessory (C9) (fig. 36) and press it to the bottom;



3. Put on the accessory the cleaning tab (fig. 37).
4. Attach the portafilter to the coffee outlet (A7).
5. Fill the water tank (A15). Make sure the drip tray (A11) is empty.
6. Keep pressed the  button, until the related light start blinking (orange). After few minutes the cleaning stops automatically;
7. Remove the portafilter and the cleaning disk accessory;
8. Wash the portafilter and the filter under tap water;
9. Insert the portafilter again and make a rinse by pressing the  button (B5): we suggest to put a container under the portafilter;
10. Remove and empty the drip tray.

**Please note:**

This procedure can start by pressing the  button (B5) for some seconds. To delete this option, press the same button for 10 seconds.

**8.2 Cleaning the beans container housing**

1. Make sure the beans container (A1) is empty. If necessary, operate the coffee mill without beans to empty it;
2. Release the beans container by turning it anticlockwise and extract from the appliance (fig. 38)

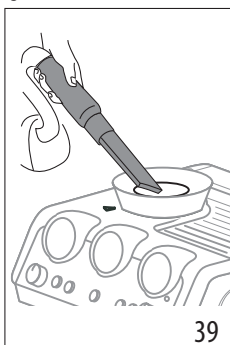
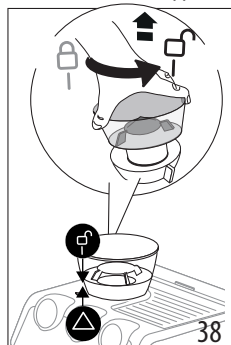

3. Remove coffee residues using a vacuum cleaner (fig. 39).

4. Clean the beans container housing with a damp cloth and dry (fig. 40);

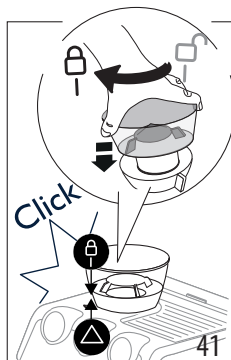
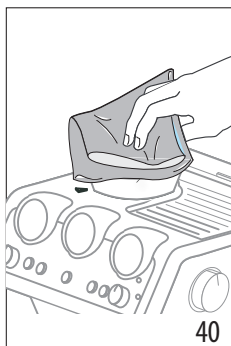

5. Put the container back inserting it in the coffee mill. The container is correctly inserted when the arrow ▲ is lined up with the  symbol and you hear a "click" (fig. 41).

**8.3 Cleaning the burr**

When cleaning the beans container (A1), clean the container housing and upper burr with a damp cloth. The burr can be removed and replaced by an authorised customer services centre. You may also need to remove the burr if it becomes blocked with foreign matter. If this occurs, remove the beans container and clean as follows:

1. Attach the portafilter (C1) and operate the mill without beans to free the coffee guide;
2. Turn the appliance off;
3. Turn the grinding selector anticlockwise as far as it will go to the "REMOVE" position (fig. 42).

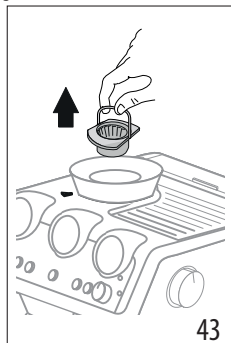
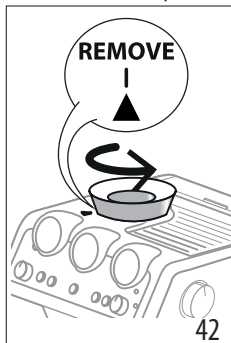

4. Extract the upper burr, gripping it by the handle (fig.43).
5. Clean the burr with a brush (fig. 44) (not included) and remove the coffee residues using a vacuum cleaner (fig. 39).

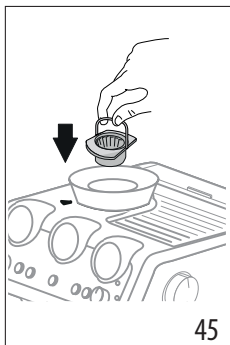
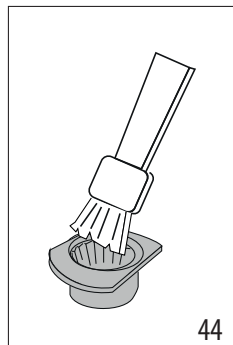

6. Put the upper burr back in place (fig. 45);
7. Turn the selector to select the desired grinding level (fig. 13); Make sure the burr is inserted correctly by pulling it by the handle. If it is correctly inserted, it will not move.

### 8.4 Replacing the burrs

When the quantity of coffee becomes even less, contact a customer services centre to have the burrs replaced, then adjust the mill again as follows entering the setting menu ("7. Menu settings") and selecting the first range of the "Extra grinding adjustment". Then turn the ground coffee quantity dial (B2) to minimum position and set the dose like a first use (see "The „perfect dose“").

### 8.5 Cleaning the "Smart tamping station"

1. Clean the attachment area with a brush (fig. 46).
2. Pull the lever (A20) as far as it will go and clean the presser cylinder with a brush (fig.47). Then release the lever.
3. Use the tube brush (C8) to clean the coffee funnel.(fig. 48).

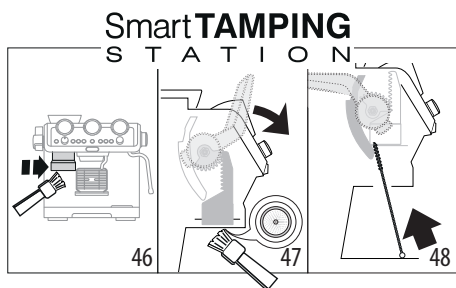

### 8.6 Cleaning Lattecrema System

All components are dishwasher safe, placing them in the top basket. If you do not have a dishwasher, wash by hand as described in the note at the end of the section.

1. Push the release button (D3) and lift the milk container lid (D1);

2. Remove the milk spout (D4) and milk intake tube (D7) (fig. 49);

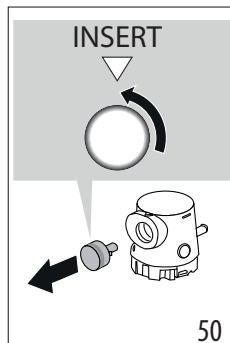
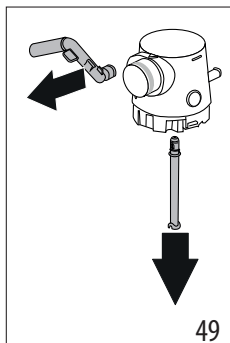

3. Turn the froth adjustment dial (D5) counter-clockwise to the "Insert" position (fig. 50) and pull;
4. Make sure there are no milk residues on the hollow and groove under the dial (fig. 51): if necessary, scrape the groove with a toothpick;

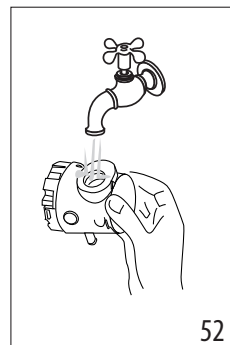
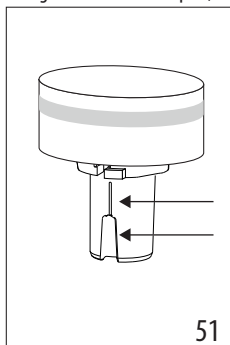

5. Rinse inside the froth adjustment dial seat with running water (fig. 52);
6. Check that the intake tube and spout are not clogged with milk residues;
7. Reassemble all the lid components;
8. Carefully wash and rinse the milk container (D8) ;
9. Attach the lid back on the milk container.

#### **Please note: washing by hand**





Washing the lid in a dishwasher guarantees the perfect hygiene of all the components. When washing by hand, wash all components of the milk container lid thoroughly with hot water and immerse them in a basin of hot water for 30 minutes before proceeding as described in point 4.

## 9. WATER HARDNESS

The descale light (B8) comes on after a period of time established according to water hardness. The machine can also be programmed according to the actual hardness of the water

supply in the various regions, in which case descaling may be required less frequently.

1. Remove the "TOTAL HARDNESS TEST" indicator paper (C4) from its pack.
2. Immerse the paper completely in a glass of water for one second.
3. Remove the paper from the water and shake lightly. After about a minute, 1, 2, 3, or 4 red squares form, depending on the hardness of the water. Each square corresponds to one level.

Total Hardness Test result	Button	Level
	×2	1 soft water
		2 medium water
	OK	3 hard or very hard water
		

4. Set the appliance as indicated in section

## 10. USING THE SOFTBALLS

Softballs (C11) is an innovative system that extends the life of the machine, without altering the sensory properties of the water, guaranteeing consistently creamy and aromatic coffee.

1. Extract the Softballs bag from the packaging (fig. 53).

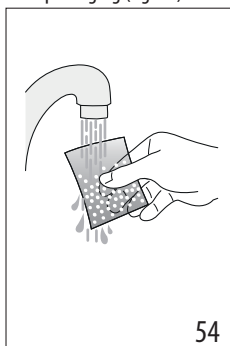
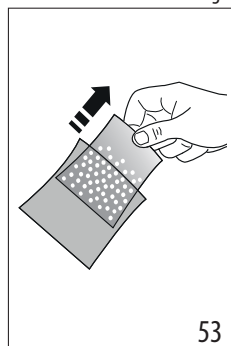

2. Rinse with tap water the Softballs bag (fig. 54).
3. Deep the bag into the water tank (A15) (fig. 55).

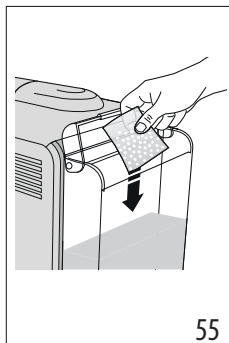

4. Change the Softballs every 3 months (fig. 56).

## 11. DESCALING

### Please note

- Before use, read the instructions and the labelling on the descaler pack (C5)..
- It is important to use De'Longhi descaler only. Using unsuitable descaler and/or performing descaling incorrectly may result in faults not covered by the manufacturer's guarantee.
- Descaler could damage delicate surfaces. If the product is accidentally spilt, dry immediately.

To descale	
Descaler	De'Longhi descaler
Containers	2: Recommended capacity: 1 l each
Time	~40min

1. (IF PRESENT, REMOVE SOFTBALLS AND WATER SOFTENER DEVICE). Pour the descaler into the tank (A15) up to the level  A marked inside the tank (equal to one 100ml packet) (fig. 57).

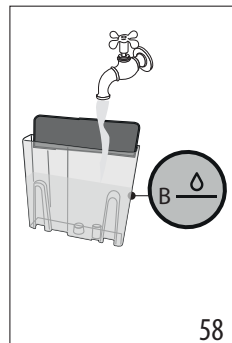
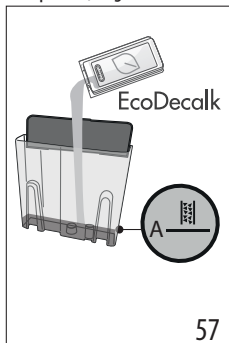

2. Add water up to the level  B (fig. 58). Then put the water tank back in the appliance.

3. Insert the dedicated accessory (C6) to the Latte Crema connection (A6) (fig. 59).

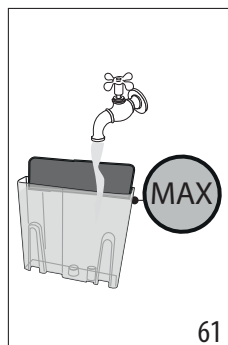
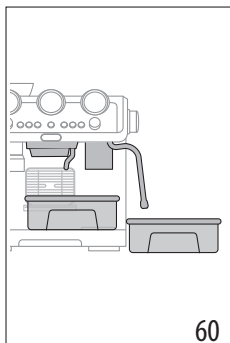
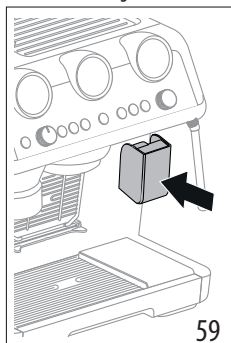

4. Make sure the portafilter (C1) is not attached and position a recipient under the coffee outlet, hot water spout (A7) and the other recipient under the steam wand (A5) (fig. 60).
5. Keep pressed the  (B8) button until the corresponding light begins to blink: descaling starts.
6. The descale programme starts and the descaler liquid comes out of the steam wand and coffee outlet. The descale programme removes limescale deposits from inside the appliance by automatically performing a series of rinses and pauses until the tank is empty.



Delivery stops and the  light turns to white. This indicates that it is necessary to proceed with rinsing; see next page.

7. Empty the recipients used to collect the descaler solution and replace them empty.
8. Remove the water tank, empty any residues of descaler solution, rinse with running water and fill with fresh water up to the MAX level (fig. 61). Put the tank back in its housing.



9. Keep pressed the  button until the corresponding light begins to blink: rinsing starts.
10. When rinsing is complete, delivery stops and the appliance prepares to be used again.
11. Empty the recipients used to collect the rinse water.
12. Extract and empty the drip tray, then put back in the appliance.













Now the appliance is ready to use.







**Please note**

- If you want to anticipate the descaling cycle, keep pressed  for 3 seconds.
- If you start descaling by mistake, keep pressed the  button for 10 seconds; the rinsing cycle cannot be interrupted.



## 12. EXPLANATION OF LIGHTS

LIGHTS	EXPLANATION OF LIGHTS	OPERATION
All the lights flash briefly	Turning the machine on	Self-diagnosis
 on	The appliance is being turned on for the first time and the water circuit must be filled	Proceed as described in section "3. Setting up the appliance"
 on	Energy saving is enabled	See section "7. Menu settings" if you want to disable the function
		→

LIGHTS	EXPLANATION OF LIGHTS	OPERATION
 on	The beans container (A1) is empty	Fill the beans container
 flashing	Grinding is requested, but the beans container (A1) is empty	Fill the beans container
 on	Insufficient water in tank (A15) or the tank is not inserted correctly	Fill the tank or extract the tank and put it back correctly
 flashing	Brewing is requested, but the water tank (A15) is empty	Fill the water tank
 on	General alarm	Contact Customer Services
 on	The beans container is not inserted	Put the beans container (A1) in the appliance correctly or check if it is correctly inserted
 flashing	The selector on the bottom of the container is not correctly positioned.	Move the selector within the 8 levels from coarse to fine, keeping in mind to: <ul style="list-style-type: none"> <li>• Always adjust the coffee mill during the grinding</li> <li>• Adjust one grinding level at a time and make at least 5 coffees before adjusting again</li> </ul>
	The coffee bean container (A1) is not completely insert: the machine does not work for safety reasons	Check that the bean container is completely locked
 on	After every use, the LatteCrema System must be cleaned	When all the milk drinks are ready, proceed with automatic cleaning turning the knob (D5) to Clea
 on	The appliance is on and ready for use	The appliance is at the right temperature to deliver steam. To deliver steam, turn the steam dial (A4)
 flashing	The appliance is on and energy saving is enabled. The steam dial (A4) is in the steam delivery position	The light flashes to indicate that the appliance is preparing to deliver steam. Delivery begins as soon as the appliance is at temperature
	The appliance is heating up to be ready for use	The appliance is at temperature when the light remains on steadily
	The appliance is delivering steam	
 on (orange)	Descaling must be performed	Descalate the appliance as described in section "11. Descaling"
 flashing (orange)	Descaling is underway	Complete the operation as described in section "11. Descaling"
 on (white)	The rinsing cycle of descaling must be performed	
→		

LIGHTS	EXPLANATION OF LIGHTS	OPERATION
 flashing (white)	The rinsing cycle of descaling is underway	
 on (orange)	Cleaning of the coffee outlet must be performed	See section “8.1 Cleaning of the coffee outlet”
 flashing (orange)	Cleaning of the coffee outlet is underway	
 flashing (white)	The active rinse is underway	
 +  flashing	If the water softener filter is present, an air bubble may have been released inside the circuit, obstructing delivery	Press the button (B7) corresponding to the  light. Delivery begins and stops automatically.
	The grinding is too fine and the coffee is delivered too slowly or not at all	Extract the filter holder (C1) (see “4.1 Step 1 - grinding (fig. 11)” and “4.3 Step 2 - tamping (fig. 17)”)
	The coffee filter (C2) or (C3) is blocked	Rinse the filters under abundant running water or by Active Rinse function (B5).
	The tank (A15) has been inserted incorrectly and the valves on the bottom are not open	Press the tank down lightly to open the valves on the bottom
	Scale in the water circuit	Descale as described in section “11. Descaling”

### 13. TROUBLESHOOTING

PROBLEM	CAUSE	SOLUTION
There is water in the drip tray (A11)	It is normal: due to the internal water circuits operations	Regularly empty and clean the drip tray
No espresso coffee is delivered	No water in the tank (A15)	Fill the tank
	The  light (B7) is on to indicate that the coffee or steam circuit is empty	Press the button corresponding to the  light to fill the circuit
	The coffee filter (C2) or (C3) is blocked	Rinse the filters under abundant running water or by Active Rinse function (B5)
	The tank (A15) has been inserted incorrectly and the valves on the bottom are not open	Press the tank down lightly to open the valves on the bottom
	Scale in the water circuit	Descale as described in section “11. Descaling”
	Coffee grind too fine	Extract the filter holder (C1) and repeat grinding with new settings (see “4.1 Step 1 - grinding (fig. 11)” and “4.3 Step 2 - tamping (fig. 17)”)
→		



<b>PROBLEM</b>	<b>CAUSE</b>	<b>SOLUTION</b>
The portafilter cannot be attached to the appliance	The ground coffee has not been pressed or is too much	Extract the filter holder (C1) and repeat grinding with new settings (see “4.1 Step 1 - grinding (fig. 11)” and “4.3 Step 2 - tamping (fig. 17)”)
The espresso coffee drips from the edges of the portafilter rather than the holes	The portafilter is inserted incorrectly	Attach the portafilter correctly and rotate firmly as far as it will go
	The espresso boiler gasket has lost elasticity or is dirty	Have the espresso boiler gasket replaced by Customer Services
	The coffee filter (C2) or (C3) is clogged	Rinse the filters under abundant running water or by Active Rinse function (B5)
The coffee crema is too light (delivered from the spout too fast)	The appliance settings need reviewing	Extract the filter holder (C1) and repeat grinding with new settings (see “4.1 Step 1 - grinding (fig. 11)” and “4.3 Step 2 - tamping (fig. 17)”)
The coffee crema is too dark (delivered from the spout too slowly)	The appliance settings need reviewing	Extract the filter holder (C1) and repeat grinding with new settings (see “4.1 Step 1 - grinding (fig. 11)” and “4.3 Step 2 - tamping (fig. 17)”)
No milk froth is formed when making cappuccino with LatteCrema System	Milk not cold enough	Always use milk at refrigerator temperature
	The froth selection knob (D5) is not in the correct position	Check and turn to the right position the froth selection knob (☺ max froth; ☹ med froth; ☹ min froth)
	The LatteCrema System is dirty	Clean the cappuccino maker as described in section “8.6 Cleaning Lattecrema System”
	Scale in the water circuit	Descale as described in section “11. Descaling”
At the end of descaling, the appliance requests a further rinse	During the rinse cycle, the water tank has not been filled to the MAX level	Repeat the rinse (see “11. Descaling”)
The appliance does not grind the coffee	There is foreign matter that cannot be ground in the coffee mill	Clean the burrs as described in section “8.3 Cleaning the burr”, making sure you remove all the beans from the beans container (A2) before extracting it. Before putting the burr back, vacuum all residues from the housing
	The coffee beans container (A1) is not in the right position	The container is correctly inserted when the arrow ▲ is lined up with the ☹ symbol and you hear a “click”.
→		

PROBLEM	CAUSE	SOLUTION
If you want to change the type of coffee	You must remove all the beans present in the machine	<ul style="list-style-type: none"> <li>• Empty the beans container (A1) (if necessary, operate the coffee mill without beans or use a vacuum cleaner to remove any remaining beans)</li> <li>• Attach the filter holder (C1) and operate the coffee mill a number of times without beans to free the grinder. Attach the filter holder to the outlet of the grinder (A18), lining it up with "INSERT", then turning it to the right (fig. 22). Grinding begins when the filter holder reaches the CLOSE position and stops automatically. Repeat until the filter is empty</li> <li>• Place the new coffee in the beans container (A1)</li> <li>• If the amount of coffee ground is not enough to reach the perfect dose, proceed setting the appliance as for the first use</li> </ul>
After grinding, the coffee filter (C2) or (C3) is empty	The coffee grinder coffee funnel is clogged	Clean as described in section "8.5 Cleaning the "Smart tamping station"". If the problem persists, access the guide by opening the hatch (A19) and free it using the brush.
After tamping, there is too much coffee in the filter		
		→

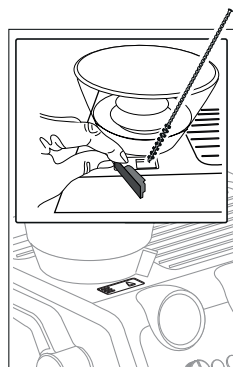

<b>PROBLEM</b>	<b>CAUSE</b>	<b>SOLUTION</b>
After grinding, the ground coffee in the filter (C2) or (C3) does not reach the “perfect dose	The “Smart Tamping Station” needs cleaning	Clean as described in section “8.5 Cleaning the “Smart tamping station””, then grind again
	The quantity of ground coffee needs adjusting	Adjust the quantity of coffee with the dial (B2) referring to “The „perfect dose””. If the dial is already in the max. position, select the second range of grinding adjustment, proceed as indicated in section “7. Menu settings”.
	Over time the burrs wear down	Replace the burrs as described in section “8.4 Replacing the burrs”

Avant d'utiliser l'appareil toujours lire la brochure des consignes de sécurité.

## 1. DESCRIPTION

### 1.1 Description de l'appareil - A

- A1. Réservoir à grains
- A2. Couvercle du réservoir à grains
- A3. Range-tasses
- A4. Bouton vapeur
- A5. Tube buse vapeur
- A6. Connecteur pour Lattecrema System
- A7. Buse à café
- A8. Grille d'appui pour tasses espresso
- A9. Grille d'appui pour verres ou mugs
- A10. Grille égouttoir
- A11. Égouttoir
- A12. Indicateur du niveau de l'eau dans l'égouttoir
- A13. Couvercle réservoir à eau
- A14. Poignée extraction réservoir à eau
- A15. Réservoir à eau
- A16. Logement connecteur cordon d'alimentation
- A17. Interrupteur général (ON/OFF)
- A18. Sortie moulin à café (Tamping station)
- A19. Volet pour accéder à la goulotte du moulin à café
- A20. Levier tasseur

### 1.2 Description panneau de contrôle - B

- B1. Touche ON/Veille
- B2. Bouton de réglage de la quantité de café moulu
- B3. Touche « X2 » : pour utiliser le filtre 2 cafés
- B4. Touche « température café »
- B5. Touche « rinçage »
- B6. Touche « OK » : pour préparer la boisson/pour confirmer
- B7. Touche « écoulement eau chaude »
- B8. Touche « détartrage »
- B9. Touche « My » : pour personnaliser la longueur des boissons
- B10. Bouton de sélection fonctions
- B11. Écran boissons

#### Boissons à base de café Espresso

- Espresso
- Americano
- Café

#### Boissons à base de lait

- Cappuccino
- Flat White
- Latte Macchiato

- B12. Voyant « nettoyage lait »
- B13. Voyant « absence réservoir à grains »
- B14. Voyant « alarme générale »
- B15. Manomètre

- B16. Voyant « manque d'eau »
- B17. Voyant « réservoir à grains vide »
- B18. Voyant « économie d'énergie »
- B19. Écran Paramètres et procédé :

- Indique l'opération que l'appareil est en train d'accomplir
- Indique le paramètre de la dose café sélectionnée
- Indique le paramètre de la température café sélectionnée

### 1.3 Description des accessoires - C

- C1. Coupelle porte-filtre
- C2. Filtre 1 tasse
- C3. Filtre 2 tasses
- C4. Bande réactive « Total Hardness Test »
- C5. Détartrant
- C6. Accessoire pour le détartrage
- C7. Cordon d'alimentation amovible
- C8. Écouvillon
- C9. Accessoire de nettoyage buse à café
- C10. Chiffon
- C11. Softballs (adoucisseur eau)
- C12. Aiguille de nettoyage pour lance à vapeur

### 1.4 Accessoires de nettoyage non inclus, recommandés par le constructeur

Pour de plus amples informations, visitez [Delonghi.com](http://Delonghi.com).



#### Pastilles de nettoyage

(Voir « 8.1 Nettoyage de la buse à café »)

EcoMultiClean

#### Nettoyant

EAN : 8004399333307

### 1.5 Description du LatteCrema System - D

- D1. Couvercle de la carafe à lait
- D2. Connecteur carafe à lait
- D3. Bouton de déblocage du couvercle
- D4. Buse à lait (réglable en hauteur)
- D5. Bouton de réglage mousse
- D6. Logement bouton
- D7. Tube de prise du lait
- D8. Carafe à lait

## 2. PRÉPARATION DE L'APPAREIL

Laver tous les accessoires à l'eau tiède avec du savon à vaisselle puis procéder comme suit :

1. Insérer l'égouttoir (A11) avec la grille d'appui pour tasses (A9) et la grille égouttoir (A10) (fig. 1) ;

2. Extraire le réservoir à eau (A15) (fig. 2) et le remplir d'eau fraîche et propre en veillant à ne pas dépasser l'inscription MAX (fig. 3).
3. Puis réinsérer le réservoir.

**Attention :** Ne jamais mettre en marche l'appareil sans eau dans le réservoir ou sans réservoir.

**Nota Bene :** Il est conseillé de personnaliser le plus rapidement possible la dureté de l'eau en suivant la procédure décrite dans le chapitre « 7. Menu paramètres ».

### 3. PREMIÈRE MISE EN MARCHÉ DE LA MACHINE

1. Insérer le connecteur du cordon d'alimentation (C7) dans le logement prévu à cet effet (A16) à l'arrière de l'appareil (fig. 4) ; puis brancher la fiche sur la prise. S'assurer et vérifier que l'interrupteur général (A17), au dos de l'appareil, est enfoncé sur la position I (fig. 5) ;
2. Positionner un récipient ayant une capacité minimale de 100 ml sous la buse à eau chaude (au niveau de la buse à café (A7)) (fig. 6) ;
3. Appuyer sur la touche (B7) au niveau du voyant  (fig. 7) : l'écoulement commence et s'interrompt automatiquement. Vider le récipient.

Avant de commencer à utiliser la machine, il faut rincer les circuits internes de la machine. Procéder de la manière suivante :

4. Accrocher la coupelle porte-filtre (C1) munie du filtre à la machine : pour un accrochage correct, aligner la poignée de la coupelle porte-filtre à « INSERT » (fig. 8) et tourner la poignée vers la droite, jusqu'à l'aligner à la position « CLOSE » ;
5. Mettre un récipient sous la coupelle porte-filtre et le tube de la buse vapeur (A5) ;
6. Appuyer sur la touche (B5) au niveau du voyant  (fig. 9) : la préparation commence ;
7. Une fois la préparation finie, tourner le bouton vapeur (A4) (fig. 10) et débiter de la vapeur pendant quelques secondes de manière à rincer le circuit vapeur : pour une distribution optimale de vapeur, on conseille de répéter cette opération 3 ou 4 fois. Ceci permet d'éliminer l'eau dans le tube avant de distribuer de la vapeur.

L'appareil est donc prêt à l'usage.

**Nota Bene :** Le rinçage des circuits internes est conseillé même en cas d'utilisation prolongée de l'appareil.

À la première utilisation il faut faire 4-5 cafés avant que la machine ne commence à donner un résultat satisfaisant : prêter une attention particulière à la dose de café moulu dans le filtre ((C2) ou (C3)) (voir instructions du paragraphe « 4.1 Phase 1 - Mouture (grinding) (fig. 11) »).

Procéder comme indiqué au chapitre « La « dose parfaite » ».

## 4. PRÉPARER LE CAFÉ

### 4.1 Phase 1 - Mouture (grinding) (fig. 11)

1. Verser les grains dans le réservoir (A1) (fig. 12). Il est recommandé de ne verser que les grains nécessaires à la

préparation : de cette manière on utilisera toujours du café frais ;

2. Sélectionner le degré de mouture (fig. 13). Le paramètre d'usine est 5 (mouture moyenne). Si le résultat n'est pas satisfaisant, régler le niveau en fonction du goût personnel et du type de café (le réglage doit être effectué durant le fonctionnement du moulin à café).
3. Insérer l'un des filtres café (C2) ou (C3) dans le porte-filtre (C1) (fig. 14). Si l'on utilise le filtre pour 2 tasses, appuyer sur la touche 2X (B3) : cette sélection permet de doubler la quantité d'espresso préparée.
4. Régler le bouton quantité (B2) en partant de la position minimale (fig. 15).

#### Nota bene :



Après avoir atteint le niveau correct dans le porte-filtre, prendre note des chiffres affichés à l'écran (B19).

Ils ne correspondent pas aux paramètres de mouture, au poids du café moulu (gr/oz) ou au temps de mouture.

Se référer au paragraphe « B3. Touche « X2 » : pour utiliser le filtre 2 cafés » pour de plus amples indications.

5. Accrocher le porte-filtre à la sortie du moulin à café (A18) en l'alignant à l'inscription INSERT : puis tourner la coupelle vers la droite (fig. 16). La mouture commence lorsque la coupelle atteint la position CLOSE et s'interrompt automatiquement.

### Régler la quantité de café moulu dans le filtre

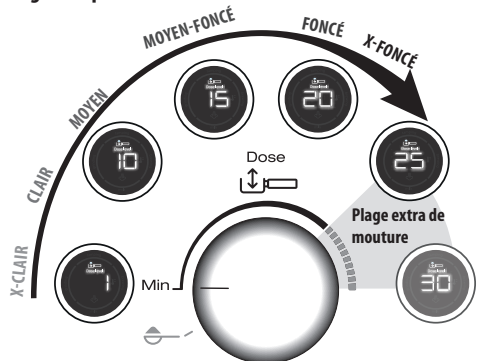

Chaque variété de grain donne un résultat différent durant la mouture c'est pourquoi, au début, le réglage de la dose demande le plus grand soin.

Cette illustration donne des indications sur la manière de régler la dose, basées sur la couleur de torréfaction : elles doivent être considérées comme un point de départ, mais peuvent varier suivant la composition des grains de café.

1. Programmer la dose en commençant par la position minimale.
2. En faisant référence à la couleur de torréfaction de votre café, tourner lentement le bouton.

#### 4.2 Phase 2 - Tassement (tamping) (fig. 17)

1. Après la mouture, abaisser le levier de tassement (A20) jusqu'en butée (ne pas enlever le porte-filtre) (fig. 18). Pour un résultat parfait, répéter 2 fois.
2. Maintenir le levier abaissé jusqu'en butée durant le retrait du porte-filtre (fig. 19). Puis ramener le levier dans la position initiale.
3. Après avoir vérifié que la dose est correcte (voir « La « dose parfaite » », accrocher le porte-filtre à la buse à café (A7) (fig. 20).

#### La « dose parfaite »

- Les filtres café, ont un repère interne pour identifier la dose parfaite.



#### Marquage au laser

- Filtres avec marquage au laser : la dose parfaite correspond à la ligne supérieure du marquage ;
- Filtres avec marquage en relief : la dose parfaite correspond à la ligne en relief ;

#### Marquage en relief

- S'assurer que le café est à niveau après le tassement. Il pourrait être nécessaire de régler plusieurs fois le bouton (B2) avant de parvenir à la dose parfaite.
- Si le café est sur- ou sous-extrait et que la dose est à l'intérieur de la dose parfaite, régler le degré de mouture le plus fin ou le plus grossier (voir « 4.1 Phase 1 - Mouture (grinding) (fig. 11) »). Si le café est sur-extrait (distribution trop lente) la mouture devra être plus grossière. Si le café est sous-extrait (distribution trop rapide) la mouture devra être plus fine.
- **Le barista conseille :** Extraire le porte-filtre alors que le levier du tasseur (A20) est abaissé pour obtenir une finition parfaite de la dose de café.

#### 4.3 Phase 3 - Distribution (brewing) (fig. 21)

1. Sélectionner la boisson souhaitée (fig. 22).
2. Appuyer sur OK (B6) pour commencer la distribution (fig. 23) (pré-infusion et infusion). La distribution du café s'interrompt automatiquement.

## 5. PRÉPARATION DE BOISSONS À BASE DE LAIT

### 5.1 Émulsionner le lait (fig. 24)

1. Verser dans la carafe à lait (D8) la quantité de lait que l'on veut chauffer/émulsionner, en tenant compte du fait que le volume du lait augmentera de 2 à 3 fois (fig. 25). Pour obtenir une mousse plus dense et homogène, il est recommandé d'utiliser du lait de vache entier et à la température du réfrigérateur (environ 5° C).

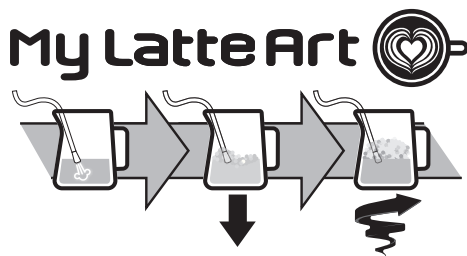

2. Pour émulsionner le lait, appuyer le tube buse vapeur (A5) sur la surface du lait : de cette façon l'air se mélange au lait et à la vapeur.
3. Maintenir la buse vapeur sur la surface, en veillant à ne pas capturer trop d'air en créant des bulles trop grosses.
4. Plonger la buse vapeur sous la surface du lait : de cette manière il se forme un tourbillon. Après avoir atteint la température souhaitée, refermer le bouton vapeur et attendre que la distribution de la vapeur s'interrompte complètement avant d'enlever le pot à lait.

#### Le barista conseille :

- **Le lait frais est meilleur.** Toujours utiliser du lait frais à la température du réfrigérateur.
- Le lait entier assure d'excellents résultats. Le résultat et la texture de la mousse varient en fonction du lait de vache ou des boissons végétales utilisées.
- Après avoir émulsionné le lait, éliminer les bulles en agitant le pot à lait.

#### Nettoyage de la buse vapeur :

1. Après chaque utilisation, éliminer les résidus de lait de la buse vapeur à l'aide d'un chiffon (fig. 26). Pour un nettoyage profond, il est recommandé d'utiliser Eco MultiClean : il assure l'hygiène en éliminant les protéines et les graisses du lait et peut être utilisé pour nettoyer toute la machine.
2. Distribuer de la vapeur pendant quelques secondes pour bien nettoyer la buse (fig. 10).
3. Attendre que la buse refroidisse : pour maintenir l'efficacité de la buse dans le temps, utiliser l'aiguille de nettoyage (C12) pour maintenir libres les 3 orifices (fig. 27).

## 5.2 Prépare les boissons à base de lait avec le LatteCrema System (fig. 28)

1. Verser dans la carafe (D8) du lait à la température du réfrigérateur (5°C) (fig. 29).
2. Fermer le couvercle (D1) (fig. 30).
3. Tourner le bouton de réglage mousse (D5) sur la position souhaitée (fig. 31).

Position bouton de réglage mousse				
CLEAN				INSERT
Nettoyage après chaque utilisation	Mousse MAX	Mousse MOY	Mousse MIN	Pour extraire ou insérer le bouton

4. Accrocher la carafe à lait à la machine (fig. 32).
5. Préparer la dose parfaite (voir « 4.1 Phase 1 - Mouture (grinding) (fig. 11) » et « 4.2 Phase 2 - Tassement (tamping) (fig. 17) ») et insérer le porte-filtre.
6. Sélectionner la boisson à base de lait souhaitée (fig. 33).

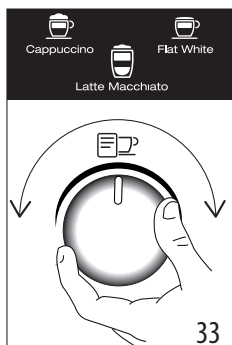

Boisson	Espresso	Lait	Mousse de lait	Quantité (ml)	X2 (ml)
Cappuccino	1	✓	✓	≈150	≈230
Latte Macchiato	1	✓	✗	≈150	≈230
Flat White	1	✓	✓	≈250	≈330

- **Boissons avec double dose (2x) :** Verser dans la carafe (D8) la quantité de lait nécessaire pour la préparation, en veillant à ne pas dépasser le niveau MAX (fig. 25). Chaque graduation sur la carafe correspond à ≈100 ml de lait.
- **Le lait frais est meilleur.** Toujours utiliser du lait frais à la température du réfrigérateur.

7. Appuyer sur OK (B6) pour distribuer (fig. 23). L'appareil distribue automatiquement le café et le lait en séquence.

## Nettoyage du Lattecrema System après chaque utilisation :

1. Laisser la carafe à lait accrochée à la machine (il n'est pas nécessaire de la vider). Mettre un récipient sous le tube d'écoulement du lait (D4) (fig. 34).
2. Tourner le bouton (D5) sur « Clean » (fig. 35).

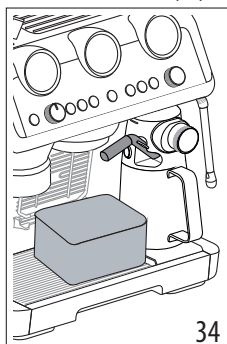



3. Le nettoyage commence et s'interrompt automatiquement. Attention : à la fin du nettoyage, tourner le bouton sur l'une des positions de réglage mousse.
  4. Enlever la carafe à lait et la mettre au réfrigérateur : on conseille d'utiliser rapidement le lait restant.
- Pour un nettoyage profond, il est recommandé d'utiliser Eco MultiClean : il assure l'hygiène en éliminant les protéines et les graisses du lait et peut être utilisé pour nettoyer toute la machine.

## 6. PERSONNALISER LA LONGUEUR DES BOISSONS AU CAFÉ À L'AIDE DE LA TOUCHE

(B9)

1. Préparer la machine pour faire 1 ou 2 tasses de la boisson au café que l'on souhaite préparer, jusqu'à accrocher le porte-filtre (C1) doté de filtre (C2) ou (C3) et de café moulu. Si l'on souhaite programmer une boisson à base de lait, connecter le Lattecrema System à la machine.
2. Tourner le bouton (B10) pour sélectionner la boisson à programmer.
3. Appuyer sur la touche : le voyant correspondant à la touche OK (B6) s'allume fixe et le voyant correspondant à la touche clignote.
4. Appuyer sur la touche OK pour commencer la distribution. Les voyants correspondants aux touches OK et clignent.
5. Après avoir atteint la quantité souhaitée, appuyer sur OK. Si la boisson prévoit la préparation d'un autre ingrédient, la







préparation de ce dernier commence : après avoir atteint la quantité souhaitée, appuyer sur OK.

- Appuyer sur la touche  pour enregistrer. L'appareil est prêt pour une nouvelle utilisation et le voyant  reste allumé.

Si l'on ne souhaite pas enregistrer la programmation, appuyer sur n'importe quelle autre touche.









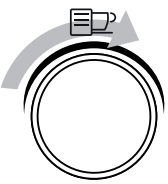













**Nota bene :**

- Il est possible de programmer les boissons à base de café, mais non la distribution de vapeur et d'eau chaude.
- La programmation modifie les quantités des boissons, mais non du café moulu.
- Les boissons « X2 » peuvent être programmées séparément.
- **My LatteArt**  n'est pas programmable.
- **Pour revenir aux paramètres d'usine, maintenir enfoncée la touche**  **jusqu'à l'arrêt. La boisson sélectionnée revient à la quantité d'usine.**

Recette café	Quantité d'usine	Quantité programmable
 Espresso	35 ml	de 25 à 90 ml
 Espresso X2	70 ml	de 50 à 180 ml
 Coffee	80 ml	de 50 à 120 ml
 Coffee X2	160 ml	de 120 à 240 ml
 Americano	120 ml	<ul style="list-style-type: none"> <li>• espresso : de 25 à 60 ml</li> <li>• eau : de 25 à 120 ml</li> </ul>
 Americano X2	240 ml	<ul style="list-style-type: none"> <li>• espresso : de 50 à 120 ml</li> <li>• eau : de 50 à 240 ml</li> </ul>

## 7. MENU PARAMÈTRES

1. Entrer dans le menu :		
Presser simultanément pendant 5 secondes	x2	
2. Sélectionner le paramètre à programmer :		
		
→		

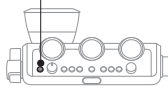
Boisson	Paramètre correspondant	Réglages
 Espresso	Économie d'énergie	 →  <b>Activé</b>
		 →  <b>Éteint</b>
 Coffee	Arrêt automatique	 → <b>9 minutes</b>
		 → <b>1,5 heures</b>
		 → <b>3 heures</b>
 Cappuccino	Signal sonore	 →  <b>Activé</b>
		 →  <b>Éteint</b>
 Latte	Réglage extra de la mouture	 → <b>Page 1</b>
		 → <b>Page 2</b>
 Flat White	Valeurs d'usine	Maintenir enfoncée la touche OK pendant au moins 5 secondes, jusqu'à ce que le voyant reste allumé fixe
 Americano	Dureté de l'eau	 → <b>douce</b>
		 → <b>moyenne</b>
		 → <b>dure/très dure</b>
<b>3. Enregistrer les nouveaux paramètres en appuyant sur ON/Veille (B1)</b>		
 		

## 8. NETTOYAGE DE L'APPAREIL













**Attention !**

- Pour le nettoyage de la machine, ne pas utiliser de solvants, de nettoyeurs abrasifs ou de l'alcool.
- Ne pas utiliser d'objets métalliques pour retirer les incrustations ou les dépôts de café car ils pourraient rayer les surfaces en métal ou en plastique.
- Pour des périodes d'inutilisation supérieures à 1 semaine il est recommandé, avant d'utiliser la machine, de procéder à un rinçage.



## Danger!

- Au cours du nettoyage, ne jamais plonger la machine dans l'eau : c'est un appareil électrique.
- Avant toute opération de nettoyage des parties extérieures de l'appareil, éteindre la machine, retirer la fiche de la prise de courant et laisser refroidir la machine.



					
	×	✓	✓	×	×
	✓	×	×	✓	✓
	×	×	×	✓	✓
	×	×	×	✓	✓
	×	×	✓	✓	×
	×	×	×	✓	✓
	✓	✓	×	✓	✓

## 8.1 Nettoyage de la buse à café

Quand le voyant  s'allume (orange) (B5), il faut procéder au nettoyage du circuit café. Pour effectuer le cycle de nettoyage, acheter les pastilles de nettoyage pour machines à café. Pour de plus amples informations, visiter [www.Delonghi.com](http://www.Delonghi.com).

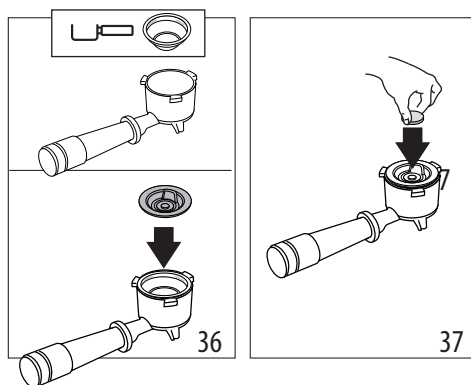
1. Insérer le filtre 1 tasse (C2) dans le porte-filtre (C1) (fig. 36).
2. Insérer l'accessoire de nettoyage (C9) dans le filtre (fig. 36) et le presser à fond.



3. Mettre la pastille pour le nettoyage sur l'accessoire (fig. 37).
  4. Accrocher le porte-filtre à la buse à café (A7).
  5. Remplir le réservoir d'eau (A15). S'assurer que l'égouttoir (A11) est vide.
  6. Maintenir enfoncée la touche  jusqu'à ce que le voyant correspondant commence à clignoter (orange). Après quelques minutes, le nettoyage s'interrompt automatiquement.
- Enlever le porte-filtre et l'accessoire de nettoyage.
  - Laver le porte-filtre et le filtre à l'eau courante.
  - Réinsérer le porte-filtre et procéder à un rinçage en appuyant sur la touche  (B5) : on conseille de mettre un récipient sous le porte-filtre.
  - Enlever et vider l'égouttoir.

### Nota Bene :

Ce cycle de nettoyage peut être lancé à tout moment en appuyant sur la touche  (B5) pendant quelques secondes. Pour annuler l'opération, appuyer sur le bouton pendant 10 secondes.

## 8.2 Nettoyer le logement du réservoir à grains

1. S'assurer que le réservoir à grains (A1) est vide. Éventuellement procéder à quelques moutures à vide pour le vider.
2. Décrocher le réservoir de la machine en le tournant dans le sens inverse des aiguilles d'une montre (fig. 38)

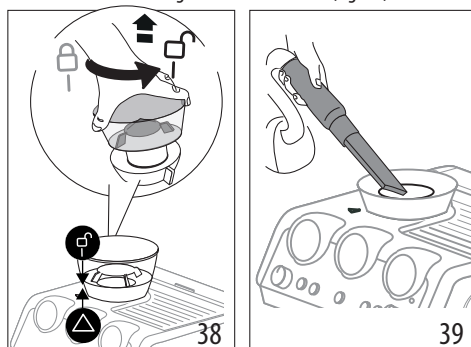

3. Aspirer les résidus de café (fig. 39).
4. Nettoyer le logement du réservoir à grains à l'aide d'un chiffon humide et essuyer (fig. 40) ;

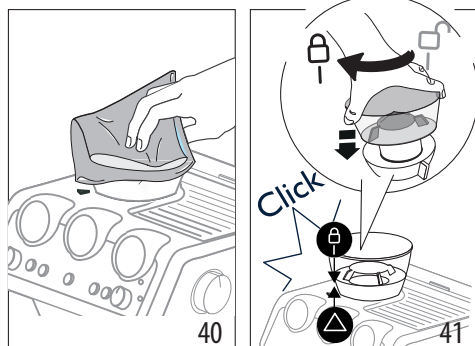

5. Repositionner le réservoir en l'insérant dans le moulin à café. Le réservoir est inséré correctement quand la flèche ▲ est alignée au symbole  et que l'on entend un « clic » (fig. 41).

### 8.3 Nettoyage des meules

Lorsqu'on nettoie le réservoir à grains (A1), nettoyer le logement du réservoir et la meule supérieure à l'aide d'un chiffon humide. S'adresser à un centre d'assistance pour enlever ou remplacer les meules.

Il est possible d'enlever la meule au cas où le moulin à café serait bloqué par un corps étranger. Si c'est le cas, enlever le réservoir à grains et procéder de la manière suivante :

1. Accrocher la coupelle porte-filtre (C1) et faire une mouture « à vide » pour libérer le conduit du café.
2. Éteindre l'appareil.
3. Tourner le régulateur de mouture dans le sens inverse des aiguilles d'une montre jusqu'en butée, sur la position « REMOVE » (fig. 42).

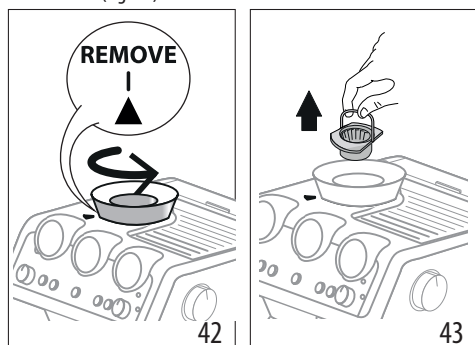

4. Extraire la partie supérieure de la meule, en la saisissant par la poignée prévue à cet effet (fig. 43).

5. Nettoyer la meule à l'aide d'un pinceau (fig. 44) et aspirer les résidus de café avec un aspirateur (fig. 39).

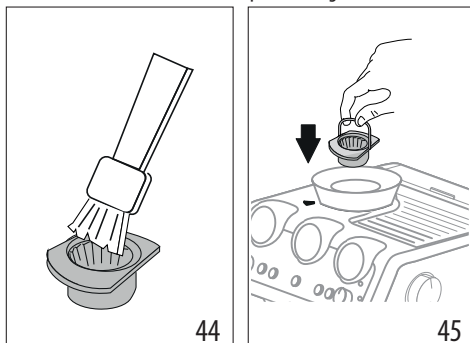

6. Insérer la meule dans son logement (fig. 45) ;
7. Tourner le régulateur en sélectionnant le degré de mouture souhaité (fig. 13) ;

Vérifier que la meule est bien insérée, en la tirant par la poignée : la meule est insérée correctement si elle ne bouge pas ;

### 8.4 Remplacement des meules

Quand la quantité de café moulu diminue encore, s'adresser à un centre d'assistance pour remplacer les meules : puis régler à nouveau le moulin à café en entrant dans le menu paramètres (« 7. Menu paramètres ») et en sélectionnant la première plage du réglage extra de la mouture. Puis, tourner le bouton de réglage quantité (B2) sur la position MIN et régler la dose comme à la première utilisation (voir « La « dose parfaite » »).

### 8.5 Nettoyage de la « Smart tamping station »

1. Nettoyer la zone d'accrochage avec un pinceau (fig. 46).
2. Tirer le levier (A20) jusqu'en butée et nettoyer le tasseur à l'aide d'un pinceau (fig. 47), puis relâcher le levier.
3. En utilisant l'écouvillon (C8), nettoyer la goulotte café (fig. 48).

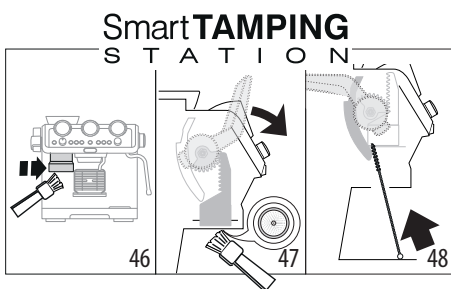

### 8.6 Nettoyage du LatteCrema System

Laver au lave-vaisselle tous les composants et la carafe, en les plaçant pendant sur le panier supérieur du lave-vaisselle. Si l'on

ne dispose pas d'un lave-vaisselle, laver à la main comme indiqué dans la note à la fin du paragraphe.

- Appuyer sur le bouton (D3) et soulever le couvercle de la carafe à lait (D1) ;
- Ôter la buse à lait (D4) et le tube de prise (D7) (fig. 49) ;

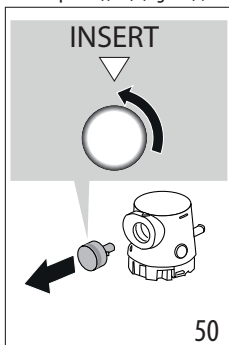
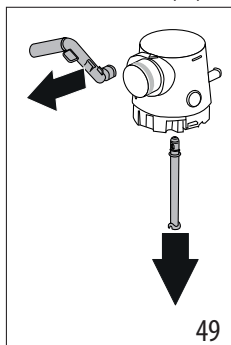

- Tourner le bouton sur la position « Insert » et l'extraire (fig. 50) ;
- Faire particulièrement attention à ce qu'il n'y ait aucun résidu de lait sur l'encoche et sur la rainure située sous le bouton (fig. 51) : éventuellement racler la rainure à l'aide d'un cure-dents ;

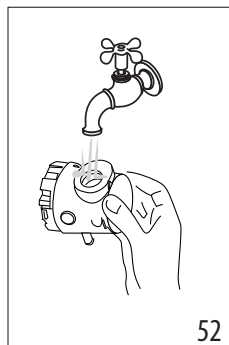
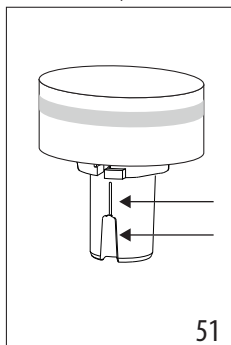

- Rincer l'intérieur du logement du bouton de réglage de la mousse à l'eau courante (fig. 52) ;
- Vérifier également que le tube de prise et le tube d'écoulement du lait ne soient pas bouchés par des résidus de lait ;
- Ré-assembler tous les composants du couvercle ;
- Laver et rincer soigneusement la carafe à lait (D8) ;
- Remettre le couvercle sur la carafe à lait.







#### **Nota Bene : lavage à la main**

Le lavage au lave-vaisselle assure une hygiène parfaite de tous les composants de la carafe à lait : en cas de lavage à la main, laver soigneusement tous les composants de la carafe à lait à l'eau chaude et les plonger dans une cuvette d'eau chaude, les y laisser pendant environ 30 minutes, avant de procéder comme indiqué à partir du point 4.

## 9. DURETÉ DE L'EAU

Le voyant  (B8) d'entartrage s'allume après une période de fonctionnement prédéfinie qui dépend de la dureté de l'eau. Il est possible de programmer la machine en fonction de la dureté réelle de l'eau courante dans les différentes régions, en rendant ainsi l'opération de détartrage moins fréquente.

- Retirer la bande réactive fournie « TOTAL HARDNESS TEST » (C4) de son emballage.
- Plonger entièrement la bande réactive dans un verre d'eau pendant environ une seconde.
- Extraire la bande de l'eau et la secouer légèrement. Programmer l'appareil, comme indiqué dans le chapitre « 7. Menu paramètres ».

Résultat Test Dureté De L'eau	Touche	Niveau
	× 2	1 eau douce
		2 eau moyenne
		3 Eau dure ou très dure
		

- Programmer l'appareil, comme indiqué dans le chapitre « 7. Menu paramètres ».

## 10. COMMENT UTILISER SOFTBALLS

Softballs (C11) est un système innovant qui prolonge la durée de vie de la machine, sans altérer la qualité de l'eau, en garantissant la préparation d'un café crémeux et aromatique. Pour optimiser l'efficacité, laisser Softballs dans l'eau pendant toute la nuit précédant l'utilisation.

- Extraire le paquet de Softballs de l'emballage (fig. 53).

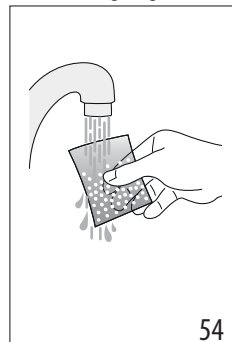
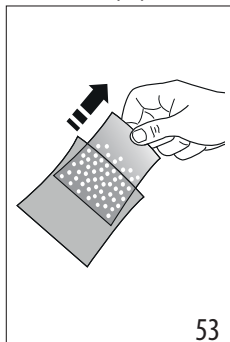

- Rincer le paquet de Softballs à l'eau courante (fig. 54).
- Plonger le sachet dans le réservoir d'eau (A15) (fig. 55).

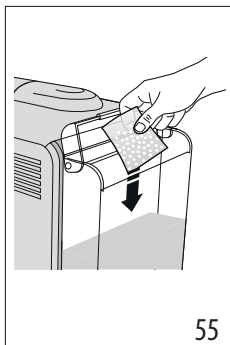

55



56

4. Remplacer le sachet de Softballs tous les 3 mois (fig. 56).

## 11. DÉTARTRAGE

### Attention !

- Avant l'utilisation, lire les instructions et l'étiquette du détartrant (C5), reportées sur l'emballage du détartrant.
- Il est conseillé d'utiliser exclusivement un détartrant De'Longhi. L'utilisation de détartrants non appropriés, ainsi que le détartrage non régulièrement effectué, peut entraîner l'apparition de défauts non couverts par la garantie du producteur.
- Le détartrant peut abîmer les surfaces délicates. Si le produit est renversé accidentellement, essayer immédiatement.

Pour effectuer le détartrage	
Détartrant	Détartrant De'Longhi
Récipients	2 de 1 litre chacun
Temps	~40min

1. (SI PRÉSENTS, ENLEVER FILTRE ADOUCISSEUR ET SOFT-BALLS). Verser dans le réservoir d'eau (A15) le détartrant jusqu'au niveau **A** (correspondant à un emballage de 100ml) imprimé sur le côté interne du réservoir (fig. 57).

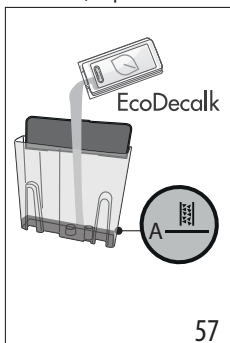

57

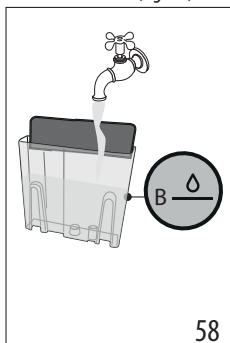

58

2. Ajouter de de l'eau jusqu'à atteindre le niveau **B** (fig. 58). Réinsérer donc le réservoir d'eau dans la machine.

3. Insérer l'accessoire (C6) sur le connecteur pour Lattecrema System (A6) (fig. 59).

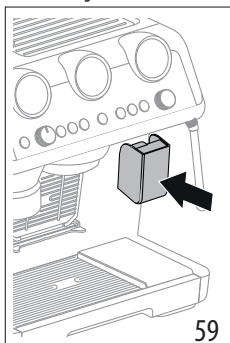

59

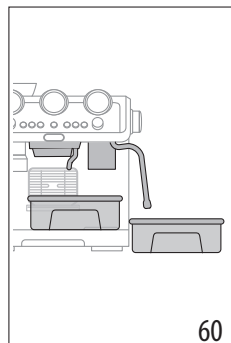

60

4. S'assurer que le porte-filtre (C1) n'est pas accroché et positionner un récipient sous les buses à café et à eau chaude (A7), et sous la buse vapeur (A5) (fig. 60).
5. Maintenir enfoncée la touche  (B8) jusqu'à ce que le voyant correspondant commence à clignoter.
6. Le programme de détartrage démarre et le liquide détartrant s'écoule des buses. Le programme de détartrage effectue automatiquement et par intervalles toute une série de rinçages pour enlever les résidus de calcaire qui se trouvent à l'intérieur de la machine à café jusqu'à vider le réservoir.

La distribution s'interrompt et le voyant  devient blanc. Il est donc nécessaire de procéder au cycle de rinçage :

7. Vider le récipient utilisé pour la récupération du liquide détartrant et le remettre sous les buses.
8. Extraire le réservoir à eau, le vider d'éventuels résidus de solution détartrante, le rincer à l'eau courante et le remplir d'eau fraîche jusqu'au niveau MAX (fig. 61). Réinsérer donc le réservoir dans son logement.

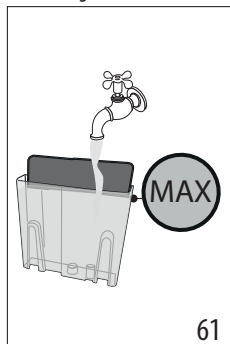



61











9. Maintenir enfoncée la touche  jusqu'à ce que le voyant correspondant commence à clignoter : le rinçage démarre.
10. Une fois le rinçage terminé, la distribution s'interrompt et l'appareil est prêt à l'emploi.

11. Vider les récipients de récupération de l'eau de rinçage.
  12. Extraire et vider l'égouttoir, puis le réinsérer.
  13. Extraire et remplir le réservoir d'eau fraîche, puis le réinsérer.
- L'appareil est maintenant prêt à l'usage.













**Nota bene :**

- Si l'on souhaite anticiper le cycle de détartrage, maintenir enfoncée la touche  pendant 3 secondes.
- Au cas où le détartrage aurait été lancé par erreur, appuyer sur la touche  pendant 10 secondes, le rinçage ne peut pas être interrompu.



## 12. SIGNIFICATION DES VOYANTS

VOYANTS	SIGNIFICATION DES VOYANTS	OPÉRATION
Tous les voyants clignotent brièvement	Allumage de l'appareil	Autodiagnostic
 fixe	C'est le premier allumage de la machine et il est nécessaire de procéder au remplissage du circuit eau	Procéder comme indiqué au chap. « 3. Première mise en marche de la machine »
 fixe	La fonction économie d'énergie est activée	Se référer au chap. « 7. Menu paramètres » si l'on souhaite désactiver la fonction
 fixe	Le réservoir à grains (A1) est vide	Remplir le réservoir à grains
 clignotant	On souhaite procéder à la mouture, mais le réservoir à grains (A1) est vide	Remplir le réservoir à grains
 on	L'eau dans le réservoir (A15) n'est pas suffisante ou le réservoir d'eau n'est pas bien inséré	Remplir le réservoir ou extraire et réinsérer correctement le réservoir
 clignotant	On souhaite procéder à la préparation d'une boisson, mais le réservoir d'eau (A15) est vide	Remplir le réservoir d'eau
 fixe	Disfonctionnement	S'adresser à un centre d'assistance
 fixe	Le réservoir à grains n'est pas inséré	Insérer correctement le réservoir à grains (A1) ou vérifier qu'il est inséré correctement
 clignotant	Le sélecteur, à la base du réservoir à grains (A1), n'est pas dans la position correcte	Remettre le sélecteur sur l'une des positions de mouture (entre 1 et 8), en se souvenant de : <ul style="list-style-type: none"> <li>• Régler la mouture alors que le moulin à café est en marche</li> <li>• Régler d'un niveau à la fois et faire au moins 5 moutures entre un réglage et l'autre</li> </ul>
	Le réservoir à grains (A1) n'est pas complètement inséré : le dispositif de sécurité se déclenche	Vérifier que le réservoir à grains est inséré correctement
 fixe	Le LatteCrema System doit être nettoyé après chaque utilisation	Après avoir terminé les préparations à base de lait, procéder au nettoyage automatique en tournant le bouton (D5) sur Clean



VOYANTS	SIGNIFICATION DES VOYANTS	OPÉRATION
 fixe	L'appareil est prêt pour la distribution de vapeur.	L'appareil a atteint la température pour distribuer de la vapeur. Pour procéder à la distribution, tourner le bouton vapeur (A4)
 clignotant	L'appareil est allumé et la fonction économie d'énergie est activée : la manette vapeur (A4) est en position pour distribuer de la vapeur	Le voyant clignote pour indiquer que l'appareil est en train de se préparer pour distribuer de la vapeur : la distribution commence dès que l'appareil est en température
	L'appareil est prêt pour la distribution de vapeur	L'appareil est à la bonne température pour la préparation de vapeur lorsque le voyant reste fixe
	L'appareil est en train de distribuer de la vapeur	
 fixe (orange)	Il est nécessaire de procéder au détartrage	Effectuer le détartrage comme illustré au chap. « 11. Détartrage »
 clignotant (orange)	L'appareil est en train d'effectuer le détartrage	Compléter l'opération comme décrit au chap. « 11. Détartrage »
 fixe (blanc)	Il faut procéder au rinçage	
 clignotant (blanc)	L'appareil est en train d'effectuer le rinçage	
 fixe (orange)	Il faut procéder au nettoyage de la buse à café	Voir par. « 8.1 Nettoyage de la buse à café »
 clignotant (orange)	L'appareil est en train d'effectuer le nettoyage de la buse à café	
 clignotant (blanc)	L'appareil est en train d'effectuer un rinçage	
 +  clignotant	Si le filtre adoucisseur est présent, il se pourrait qu'une bulle d'air soit entrée dans le circuit en empêchant la distribution	Appuyer sur la touche (B7) au niveau du voyant  : la distribution commence et s'interrompt automatiquement.
	La mouture est trop fine et le café sort par conséquent trop lentement ou ne sort pas du tout.	Extraire la coupelle porte-filtre (C1), répéter les opérations pour faire le café en tenant compte des indications du par. « 4.1 Phase 1 - Mouture (grinding) (fig. 11) » et « 4.2 Phase 2 - Tassement (tamping) (fig. 17) »
	Le filtre café (C2) ou (C3) est bouché	Rincer les filtres à l'eau courante ou effectuer un rinçage avec la touche rinçage (B5).
	Le réservoir (A15) est mal inséré et les clapets correspondants ne sont pas ouverts	Presser légèrement le réservoir de manière à en ouvrir les clapets
	Calcaire à l'intérieur du circuit hydraulique	Effectuer le détartrage comme au chap. « 11. Détartrage »

### 13. SI QUELQUE CHOSE NE FONCTIONNE PAS

PROBLÈME	CAUSE	SOLUTION
Il y a de l'eau dans l'égouttoir (A11)	Cela fait partie du fonctionnement normal des circuits internes de la machine	Vider et nettoyer régulièrement l'égouttoir (A11)
Le café espresso ne sort plus	Absence d'eau dans le réservoir (A15)	Remplir le réservoir
	Le voyant  (B7) est allumé et indique que le circuit café ou le circuit vapeur est vide.	Appuyer sur la touche correspondante au voyant  pour remplir le circuit.
	Le filtre (C2) ou (C3) est bouché	Rincer les filtres à l'eau courante ou effectuer un rinçage avec la touche correspondante (B5)
	Le réservoir (A15) est mal inséré et les clapets sur le fond ne sont pas ouverts	Enfoncer légèrement le réservoir pour ouvrir les clapets sur le fond
	Calcaire à l'intérieur du circuit hydraulique	Effectuer le détartrage comme au chap. « 11. Détartrage »
	Mouture trop fine	Extraire la coupelle porte-filtre (C1), répéter les opérations pour faire le café en tenant compte des indications du par. « 4.1 Phase 1 - Mouture (grinding) (fig. 11) » et « 4.2 Phase 2 - Tassement (tamping) (fig. 17) »
Le porte-filtre ne s'accroche pas à l'appareil	Le café moulu n'a pas été tassé ou est en quantité excessive	Répéter la mouture avec des paramètres différents. Réduire la quantité de la dose : vérifier que le filtre (C2) ou (C3) (1 ou 2 tasses) est correct par rapport à la dose à moulin (touche 2x (B3) sélectionnée ou non sélectionnée)
Le café espresso goutte sur les bords du porte-filtre (C1) et non des orifices	Le porte-filtre est mal inséré	Fixer correctement le porte-filtre et le tourner à fond avec force
	Le joint de la buse à café (A7) n'est plus élastique ou est sale	Remplacer le joint de la buse à café auprès d'un Centre d'Assistance
	Le filtre (C2) ou (C3) est bouché	Rincer les filtres à l'eau courante ou effectuer un rinçage avec la touche correspondante (B5)
La crème du café est claire (le café sort rapidement du bec)	Il faut revoir les paramètres de l'appareil	Extraire la coupelle, répéter les opérations pour faire le café en tenant compte des indications du par. « 4.1 Phase 1 - Mouture (grinding) (fig. 11) » et « 4.2 Phase 2 - Tassement (tamping) (fig. 17) »
		→

PROBLÈME	CAUSE	SOLUTION
La crème du café est foncée (le café sort lentement du bec)	Il faut revoir les paramètres de l'appareil	Extraire la coupelle porte-filtre (C1), répéter les opérations pour faire le café en tenant compte des indications du par. « 4.1 Phase 1 - Mouture (grinding) (fig. 11) » et « 4.2 Phase 2 - Tassement (tamping) (fig. 17) »
La mousse du lait ne se forme pas pendant la préparation du cappuccino avec le LatteCrema System	Le lait n'est pas assez froid	Utiliser toujours le lait à la température du réfrigérateur
	Le bouton (D5) n'est pas sur la position correcte	Vérifier et tourner le bouton sur la position correcte (☺ mousse max; ☹ mousse moy; ☹ mousse min)
	Le LatteCrema System est sale	Procéder au nettoyage comme illustré au paragraphe « 8.6 Nettoyage du LatteCrema System »
	Calcaire à l'intérieur du circuit hydraulique	Effectuer le détartrage comme au chap. « 11. Détartrage »
Au terme du détartrage, l'appareil a besoin d'un autre rinçage	Durant le cycle de rinçage, le réservoir n'a pas été rempli jusqu'au niveau MAX	Répéter le rinçage (voir chap. « 11. Détartrage »)
L'appareil ne moule pas le café	Un corps étranger est présent à l'intérieur du moulin à café	Effectuer le nettoyage des meules en suivant les instructions du par. « 8.3 Nettoyage des meules », en s'assurant d'avoir enlevé tous les grains du réservoir à grains (A2) avant de l'extraire. Avant de réinsérer la meule, aspirer soigneusement chaque résidu de son logement
	Le réservoir à grains (A1) n'est pas dans la position correcte	Le réservoir est inséré correctement quand la flèche ▲ est alignée au symbole ☺ et que l'on entend un « clic »
→		



PROBLÈME	CAUSE	SOLUTION
Si l'on souhaite changer de qualité de café	Il est nécessaire d'éliminer tous les grains présents dans la machine	<ul style="list-style-type: none"> <li>• Vider le réservoir à grains (A1) (en faisant des moutures à vide ou éventuellement en aspirant les grains résiduels).</li> <li>• Accrocher la coupelle porte-filtre (C1) et faire des moutures « à vide » pour libérer le conduit du café : accrocher le porte-filtre à la sortie du moulin à café (A18) en l'alignant à l'inscription INSERT et tourner la coupelle vers la droite (fig. 22). La mouture commence lorsque la coupelle atteint la position CLOSE et s'interrompt automatiquement. Répéter jusqu'à ce que le filtre soit vide</li> <li>• Insérer la nouvelle variété de grains de café dans le réservoir (A1)</li> <li>• Si la « dose parfaite » n'est pas atteinte lors de la mouture, procéder comme à la première utilisation</li> </ul>
Après la mouture, le filtre café (C2) ou (C3) est vide	La goulotte café du moulin à café est engorgée	Effectuer le nettoyage en suivant les instructions du par. « 8.5 Nettoyage de la « Smart tamping station » ». Si le problème persiste, accéder à la goulotte en ouvrant le volet (A19) prévu à cet effet et la libérer en utilisant l'écouvillon
Après la mouture, la poudre de café dans le filtre est surabondante		
		→

<b>PROBLÈME</b>	<b>CAUSE</b>	<b>SOLUTION</b>
Après la mouture, la poudre de café dans le filtre (C2) ou (C3) n'atteint pas la « dose parfaite »	La « Smart Tamping Station » a besoin d'être nettoyée	Effectuer le nettoyage en suivant les instructions du par. « 8.5 Nettoyage de la « Smart tamping station » », puis répéter la mouture
	Il faut régler la quantité de café moulu	Régler la quantité à l'aide du bouton dédié (B2) en suivant les indications du par. « La « dose parfaite » ». Si le bouton est déjà sur la position max, procéder comme indiqué à la section « Réglage extra de la mouture »
	Avec le temps les meules s'usent	Procéder au remplacement des meules comme indiqué au par. « 8.4 Remplacement des meules »

Vor dem Gebrauch des Gerätes lesen Sie bitte immer das Heft mit den Sicherheitshinweisen durch.

## 1. BESCHREIBUNG

### 1.1 Beschreibung des Gerätes - A

- A1. Kaffeebohnenbehälter
- A2. Deckel des Kaffeebohnenbehälters
- A3. Tassenrost
- A4. Ausgabeknopf für Dampf
- A5. Dampfausgaberohr
- A6. Steckverbindung für Lattecrema System
- A7. Kaffeeauslauf
- A8. Tassenrost für Espresso
- A9. Tassenrost für Gläser oder große Tassen
- A10. Rost der Abtropfschale
- A11. Abtropfschale
- A12. Wasserstandsanzeige in der Abtropfschale
- A13. Deckel des Wassertanks
- A14. Griff zur Entnahme des Wassertanks
- A15. Wassertank
- A16. Aufnahme Steckverbinder Netzkabel
- A17. Hauptschalter (ON/OFF)
- A18. Mahlwerkzugang (Tamperstation)
- A19. Tür für den Zugang zur Rutsche des Mahlwerks
- A20. Anpresshebel

### 1.2 Beschreibung der Bedienblende - B

- B1. Taste ON/Bereitschaft
- B2. Mengenregler für Kaffeepulver
- B3. Taste „X2“: zur Verwendung des Siebs für 2 Kaffees
- B4. Taste „Kaffeetemperatur“
- B5. Taste „Spülvorgang“
- B6. Taste „OK“: zur Ausgabe des Getränks/Bestätigung
- B7. Taste „Heißwasserausgabe“
- B8. Taste „Entkalkung“
- B9. Taste „My“: zur individuellen Einstellung der Menge des Getränks
- B10. Funktionswahlschalter
- B11. Getränkeanzeige:

#### Espressogetränke

- Espresso
- Americano
- Kaffee

#### Milchgetränke

- Cappuccino
- Flat White
- Latte Macchiato

- B12. Kontrolllampe „Reinigung Milch“
- B13. Kontrolllampe „Kaffeebohnenbehälter fehlt“
- B14. Kontrolllampe „Allgemeiner Alarm“

- B15. Manometer
- B16. Kontrolllampe „Wasser fehlt“
- B17. Kontrolllampe „Kaffeebohnenbehälter leer“
- B18. Kontrolllampe „Energiesparmodus“
- B19. Display Einstellungen und Prozess:
  - Zeigt den Vorgang an, den das Gerät gerade durchführt
  - Zeigt die Einstellung der gewählten Kaffeemenge an
  - Zeigt die Einstellung der gewählten Kaffeetemperatur an

### 1.3 Beschreibung der Zubehöerteile - C

- C1. Siebträger
- C2. 1-Tassen-Sieb
- C3. 2-Tassen-Sieb
- C4. Reaktionsstreifen „Total Hardness Test“
- C5. Entkalker
- C6. Zubehör für Entkalkung
- C7. Abnehmbares Netzkabel
- C8. Bürste
- C9. Reinigungszubehör für Kaffeeauslauf
- C10. Tuch
- C11. Softballs (Wasserfilter)
- C12. Reinigungsnadel für Dampfzange

### 1.4 Vom Hersteller empfohlenes, nicht im Lieferumfang enthaltenes Reinigungszubehör

Für weitere Informationen besuchen Sie bitte [Delonghi.com](http://Delonghi.com).

#### Reinigungstabs

(Siehe „8.1 Reinigung des Kaffeeauslaufs“)



 EcoMultiClean

#### Reiniger

EAN: 8004399333307

### 1.5 Beschreibung des LatteCrema Systems - D

- D1. Deckel für Milchbehälter
- D2. Steckverbindung für Milchbehälter
- D3. Entriegelungstaste des Deckels
- D4. Milchauslauf (höhenverstellbar)
- D5. Milchschaumregler
- D6. Aufnahme für Drehknopf
- D7. Milchansaugrohr
- D8. Milchbehälter

## 2. VORBEREITUNG DES GERÄTES

Reinigen Sie alle Zubehöerteile mit lauwarmem Wasser und Geschirrspülmittel und fahren Sie dann wie folgt fort:

1. Setzen Sie die Abtropfschale (A11) zusammen mit dem Tassenrost (A9) und dem Rost der Abtropfschale (A10) ein (Abb. 1);

- Nehmen Sie den Wassertank heraus (A15) (Abb. 2) und füllen Sie ihn mit frischem, sauberem Wasser, wobei darauf zu achten ist, dass die Markierung MAX nicht überschritten wird (Abb. 3).

- Setzen Sie dann den Wassertank wieder ein.

**Vorsicht:** Das Gerät nie mit leerem Wassertank oder ohne Wassertank in Betrieb setzen.

**Hinweis:** Wir empfehlen Ihnen, die Wasserhärte so bald wie möglich je nach individuellem Bedarf einzustellen, indem Sie, wie in Kapitel „7. Menü Einstellungen“ beschrieben, vorgehen.

### 3. ERSTE INBETRIEBNAHME DES GERÄTES

- Stecken Sie die Steckverbindung des Netzkabels (C7) in ihre Aufnahme (A16) an der Rückseite des Gerätes (Abb. 4); stecken Sie dann den Stecker in die Steckdose. Stellen Sie sicher, dass der Hauptschalter (A17) an der Rückseite des Gerätes auf I steht (Abb. 5);
- Stellen Sie einen Behälter mit einem Mindestfassungsvermögen von 100 ml unter den Heißwasserauslauf (in Höhe des Kaffeeauslaufs (A7)) (Abb. 6);
- Drücken Sie die Taste (B7) für die Kontrolllampe  (Abb. 7): die Ausgabe beginnt und wird automatisch abgebrochen. Leeren Sie den Behälter.

Vor dem ersten Gebrauch der Kaffeemaschine müssen die internen Leitungen der Kaffeemaschine durchgespült werden. Dazu wie folgt vorgehen:

- Rasten Sie den Siebträger (C1) mit dem Sieb an der Kaffeemaschine ein: zum richtigen Einrasten muss der Griff des Siebträgers auf „INSERT“ (Abb. 8) ausgerichtet und der Handgriff nach rechts gedreht werden, bis er mit der Position „CLOSE“ übereinstimmt;
- Stellen Sie einen Behälter unter den Siebträger und das Dampfausgaberohr (A5));
- Drücken Sie die Taste (B5) für die Kontrolllampe  (Abb. 9): die Ausgabe beginnt;
- Drehen Sie nach Beendigung der Ausgabe den Ausgabeknopf für Dampf (A4) (Abb. 10) und geben Sie für einige Sekunden Dampf aus, um den Dampfkreislauf durchzuspülen: für eine optimale Dampfausgabe wird empfohlen, diesen Vorgang drei- oder viermal zu wiederholen. Dadurch wird vor der Dampfausgabe das Wasser im Rohr beseitigt.

Danach ist das Gerät betriebsbereit.

**Hinweis:** das Spülen der internen Leitungen wird auch bei längerem Nichtgebrauch des Gerätes empfohlen.

Beim ersten Gebrauch müssen Sie mindestens 4-5 Kaffees zubereiten, bevor die Kaffeemaschine ein zufriedenstellendes Resultat erzielt: achten Sie besonders auf die in das Sieb ((C2) oder (C3)) gemahlene Kaffeemenge (siehe Anleitung im Abschnitt „4.1 Schritt 1 - Mahlvorgang (grinding) (Abb. 11)“).

Gemäß den Angaben im Kapitel „Die „perfekte Menge““ vorgehen.

## 4. ZUBEREITUNG VON KAFFEE

### 4.1 Schritt 1 - Mahlvorgang (grinding) (Abb. 11)

- Füllen Sie die Bohnen in den Behälter (A1) (Abb. 12). Es ist empfehlenswert, nur die für die Zubereitung benötigten Bohnen einzufüllen: auf diese Weise ist der Kaffee bei der Verwendung immer frisch;
- Mahlgrad einstellen (Abb. 13). Die werkseitige Einstellung ist 5 (mittlerer Mahlgrad). Sollte das Resultat nicht zufriedenstellend sein, kann die Stufe anhand des eigenen Geschmacks und der Kaffeesorte eingestellt werden (Einstellung muss bei laufendem Mahlwerk erfolgen).
- Setzen Sie eines der Kaffeesiebe (C2) oder (C3) in den Siebträger (C1) ein (Abb. 14). Wenn das Sieb für 2 Tassen verwendet wird, muss die Taste 2X (B3) gedrückt werden: bei dieser Auswahl wird auch die doppelte Menge Espresso ausgegeben.
- Regeln Sie den Drehknopf zur Auswahl der Menge (B2), indem Sie auf kleinster Stufe beginnen (Abb. 15).

**Hinweis:**



Die auf dem Display (B19) angezeigten Zahlen sind ein Bezugswert, den Sie sich notieren sollten, sobald die richtige Füllmenge im Siebträger erreicht ist.

Sie entsprechen nicht den Mahlgradeinstellungen, dem Gewicht des gemahlene Kaffees (gr/oz) oder der Mahldauer.

Für weitere Angaben wird auf den Abschnitt „Die „perfekte Menge““ verwiesen.

- Rasten Sie den Siebträger am Ausgang des Mahlwerks (A18) ein und richten Sie ihn zum Text INSERT aus: drehen Sie dann den Siebträger nach rechts (Abb. 16). Der Mahlvorgang beginnt, wenn der Siebträger die Position CLOSE erreicht und wird automatisch abgebrochen.

### Die in das Sieb gemahlene Kaffeemenge einstellen

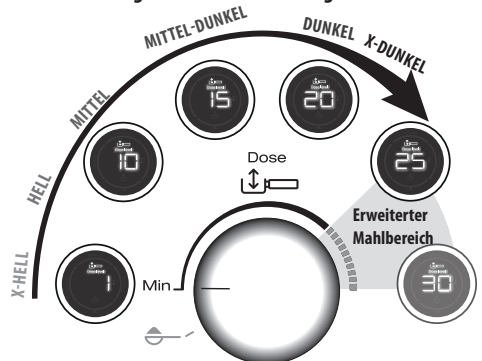

Jede Kaffeebohnsorte erzielt ein anderes Mahlergebnis; die Einstellung der Menge muss daher zu Beginn sehr sorgfältig erfolgen.

Diese Erläuterung gibt Hinweise zur Einstellung der Menge, die auf der Röstfarbe basieren: sie sind als Ausgangspunkt zu verstehen, können aber anhand der Zusammensetzung der Kaffeebohnen variieren.

1. Stellen Sie die Menge der kleinsten Position ein.
2. Drehen Sie den Drehknopf langsam unter Berücksichtigung der Röstfarbe Ihres Kaffees.

#### 4.2 Schritt 2 - Anpressen (tamping) (Abb. 17)

1. Drücken Sie nach dem Mahlvorgang den Anpresshebel (A20) bis zum Anschlag nach unten (entfernen Sie den Siebträger nicht) (Abb. 18). Für ein perfektes Resultat muss der Vorgang zweimal wiederholt werden.
2. Halten Sie den Hebel beim Entfernen des Siebträgers bis zum Anschlag nach unten gedrückt (Abb. 19). Bringen Sie den Hebel dann wieder in die Ausgangsstellung zurück.
3. Rasten Sie den Siebträger, nachdem sie geprüft haben, dass die Kaffeemenge korrekt ist (siehe „Die „perfekte Menge““), am Kaffeeauslauf ein (A7) (Abb. 20).

#### Die „perfekte Menge“

- Die Kaffeesiebe haben innen eine Markierung für die Anzeige der perfekten Menge.



- Siebe mit Lasermarkierung: die perfekte Menge entspricht der oberen Linie der Markierung;
  - Siebe mit erhabener Markierung: die perfekte Menge entspricht der erhabenen Linie;
- Vergewissern Sie sich, dass sich der Kaffee nach dem Anpressen in diesem Bereich befindet. Es könnte notwendig sein, den Drehknopf (B2) mehrfach zu regeln, bevor die perfekte Menge erreicht ist.
  - Wenn der Kaffee über- oder unterextrahiert ist und sich die Dosierung im Bereich der perfekten Menge befindet, muss der Mahlgrad feiner oder gröber eingestellt werden (siehe „4.1 Schritt 1 - Mahlvorgang (grinding) (Abb. 11)“). Wenn der Kaffee überextrahiert ist (Ausgabe zu langsam), muss der Mahlgrad gröber eingestellt werden. Wenn der Kaffee unterextrahiert ist (Ausgabe zu schnell), muss der Mahlgrad feiner eingestellt werden.
  - **Der Barista empfiehlt:** Nehmen Sie den Siebträger (A20) heraus während der Anpresshebel nach unten gedrückt ist, um das Kaffeepulver perfekt gleichmäßig zu verteilen.

#### 4.3 Schritt 3 - Ausgabe (brewing) (Abb. 21)

1. Wählen Sie das gewünschte Getränk (Abb. 22).
2. Drücken Sie OK (B6), um mit der Ausgabe zu beginnen (Abb. 23) (Vorbrühen und Brühen). Die Kaffeeausgabe wird automatisch abgebrochen.

### 5. ZUBEREITUNG VON MILCHGETRÄNKEN

#### 5.1 Milch aufschäumen (Abb. 24)

1. Füllen Sie den Milchbehälter (D8) mit der Milchmenge, die erhitzt/aufgeschäumt werden soll; beachten Sie dabei, dass sich das Milchvolumen verdoppelt bis verdreifacht (Abb. 25). Um einen üppigeren und gleichmäßigeren Schaum zu erhalten, verwenden Sie Kuhvollmilch mit Kühl-schranktemperatur (etwa 5°C).

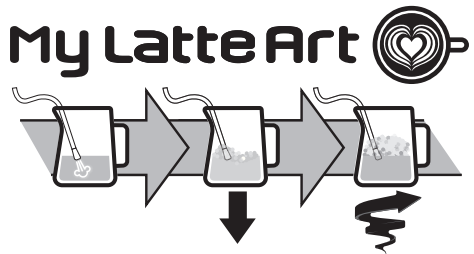

2. Um die Milch aufzuschäumen, legen Sie das Dampfausgaberohr (A5) auf die Milchoberfläche: so vermischt sich die Luft mit der Milch und dem Dampf.
3. Halten Sie das Dampfausgaberohr auf der Oberfläche und achten Sie darauf, dass nicht zu viel Luft aufgenommen wird und sich nicht zu große Blasen bilden.
4. Tauchen Sie das Dampfausgaberohr unter die Milchoberfläche: auf diese Weise entsteht ein Wirbel. Sobald die gewünschte Temperatur erreicht ist, schließen Sie den Ausgabeknopf für Dampf wieder und warten, bis die Dampfausgabe vollständig beendet ist, bevor Sie das Milchkännchen entnehmen.

#### Der Barista empfiehlt:

- **Frische Milch ist besser.** Verwenden Sie immer Milch mit Kühl-schranktemperatur.
- Vollmilch bietet ausgezeichnete Resultate. Das Resultat und die Textur des Schaums variieren, je nachdem, ob Kuhmilch oder pflanzliche Getränke verwendet werden.
- Schwenken Sie das Milchkännchen nach dem Aufschäumen, damit die Blasen aufplatzen.

#### Reinigung des Dampfausgaberohrs:

1. Entfernen Sie nach jedem Gebrauch die Milchrückstände mit einem weichen Tuch vom Dampfausgaberohr (Abb. 26). Für eine gründliche Reinigung ist die Verwendung von Eco MultiClean empfehlenswert: es garantiert Hygiene, da Milcheiweiße und Milchfette beseitigt werden, und kann

für die Reinigung der gesamten Kaffeemaschine verwendet werden.

- Geben Sie für einige Sekunden Dampf aus, um das Ausgaberohr gut zu reinigen (Abb. 10).
- Warten Sie, bis das Ausgaberohr abgekühlt ist: damit das Ausgaberohr langfristig funktionstüchtig bleibt, halten Sie die 3 Löcher mit der Reinigungsnadel (C12) frei (Abb. 27).

## 5.2 Zubereitung von Milchgetränken mit dem LatteCrema System (Abb. 28)

- Füllen Sie den Milchbehälter (D8) mit Milch mit Kühlschranktemperatur (5°C) (Abb. 29).
- Schließen Sie den Deckel (D1) (Abb. 30).
- Drehen Sie den Milchschaumregler (D5) auf die gewünschte Position (Abb. 31).

Position des Milchschaumreglers				
CLEAN	MAX Schaum	MED Schaum	MIN Schaum	INSERT
Reinigung nach jedem Gebrauch				Um den Drehknopf herauszuziehen oder einzusetzen

- Setzen Sie den Milchbehälter in die Maschine ein (Abb.32).
- Bereiten Sie die perfekte Menge vor (siehe „4.1 Schritt 1 - Mahlvorgang (grinding) (Abb. 11)“ und „4.2 Schritt 2 - Anpressen (tamping) (Abb. 17)“) und setzen Sie den Siebträger ein.
- Wählen Sie das gewünschte Milchgetränk (Abb. 33).



Getränk	Espresso	Milch	Schaum	Menge (ml)	X2 (ml)
Cappuccino	1	✓	✓	≈150	≈230

Getränk	Espresso	Milch	Schaum	Menge (ml)	X2 (ml)
Latte Macchiato	1	✓	✗	≈150	≈230
Flat White	1	✓	✓	≈250	≈330

- Getränke mit doppelter Menge (2x):** Füllen Sie die für die Zubereitung notwendige Milchmenge in den Milchbehälter (D8) und achten Sie dabei darauf, den MAX Füllstand nicht zu überschreiten (Abb. 25). Jede Markierung auf dem Behälter entspricht ≈100 ml Milch.
  - Frische Milch ist besser.** Verwenden Sie immer Milch mit Kühlschranktemperatur.
- Drücken Sie für die Ausgabe OK (B6) (Abb. 23). Das Gerät gibt automatisch Kaffee und Milch nacheinander aus.

## Reinigung des Lattecrema Systems nach jedem Gebrauch:

- Lassen Sie den Milchbehälter in der Maschine (er muss nicht geleert werden). Stellen Sie einen Behälter unter das Milchabgaberohr (D4) (Abb. 34).
- Drehen Sie den Drehknopf (D5) auf „Clean“ (Abb. 35).

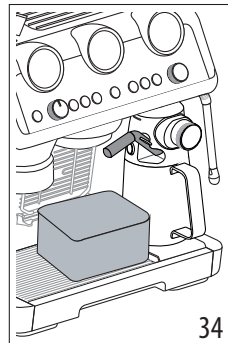





- Die Reinigung beginnt und wird automatisch abgebrochen. Vorsicht: drehen Sie den Drehknopf nach Beendigung der Reinigung auf eine der möglichen Schaumarten.
- Entnehmen Sie den Milchbehälter und stellen Sie ihn in den Kühlschrank: es wird empfohlen, die restliche Milch innerhalb von kurzer Zeit zu verwenden.

Für eine gründliche Reinigung ist die Verwendung von Eco MultiClean empfehlenswert: es garantiert Hygiene, da Milcheiweiße und Milchfette beseitigt werden, und kann für die Reinigung der gesamten Kaffeemaschine verwendet werden.

## 6. INDIVIDUELLE EINSTELLUNG DER MENGE DER KAFFEEGETRÄNKE MIT DER TASTE (B9)







- Bereiten Sie die Kaffeemaschine vor, um 1 oder 2 Tassen des gewünschten Kaffeegetränks auszugeben, und rasten Sie den Siebträger (C1) mit Sieb (C2) oder (C3) und mit Kaffeepulver ein. Wenn Sie ein Milchgetränk programmieren

- möchten, schließen Sie das Lattecrema System an die Kaffeemaschine an.
- Drehen Sie den Drehknopf (B10), um das Getränk auszuwählen, das programmiert werden soll.
  - Drücken Sie die Taste : die Kontrolllampe für die Taste OK (B6) schaltet sich permanent ein und die Kontrolllampe für die Taste  blinkt.
  - Drücken Sie die Taste OK, um mit der Ausgabe zu beginnen. Die Kontrolllampe für die Tasten OK und  blinken.
  - Sobald die gewünschte Menge erreicht ist, drücken Sie OK. Falls das Getränk die Ausgabe einer weiteren Zutat vorsieht, beginnt deren Ausgabe: sobald die gewünschte Menge erreicht ist, drücken Sie OK.
  - Drücken Sie die Taste , um zu speichern. Das Gerät ist für einen neuen Gebrauch bereit und die Kontrolllampe  bleibt eingeschaltet.

Wenn die Programmierung nicht gespeichert werden soll, drücken Sie eine beliebige andere Taste.

#### Hinweis:

- Kaffeegetränke können programmiert werden, nicht aber die Dampfausgabe und die Heißwasserausgabe.
- Die Programmierung ändert die Mengen der Getränke, aber nicht die Menge des gemahlten Kaffees.
- Die Getränke „X2“ können separat programmiert werden.
- My LatteArt**  ist nicht programmierbar.
- Um zu den Werkseinstellungen zurückzukehren, halten Sie die Taste  bis zur Ausschaltung anhaltend gedrückt. Das gewählte Getränk kehrt auf die Werkseinstellung zurück.**

Kaffeerezept	Werkseinstellung	Programmierbare Menge
 Espresso	35 ml	25 bis 90 ml
 Espresso X2	70 ml	50 bis 180 ml
 Coffee	80 ml	50 bis 120 ml
 Coffee X2	160 ml	120 bis 240 ml
 Americano	120 ml	• Espresso: 25 bis 60 ml • Wasser: 25 bis 120 ml
 Americano X2	240 ml	• Espresso: 50 bis 120 ml • Wasser: 50 bis 240 ml









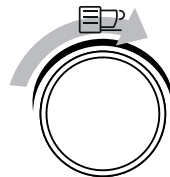













## 7. MENÜ EINSTELLUNGEN

### 1. Das Menü aufrufen:

Drücken Sie gleichzeitig für 5 Sekunden	x2	
→		

### 2. Die Einstellung wählen, die programmiert werden soll:



Getränk	Entsprechende Einstellung	Regelungen
 Espresso	Energiesparmodus	 →  <b>Aktiv</b>
		 →  <b>Ausgeschaltet</b>
 Coffee	Auto-Abschaltung	 → <b>9 Minuten</b>
		 → <b>1,5 Stunden</b>
		 → <b>3 Stunden</b>
 Cappuccino	Signalton	 →  <b>Aktiv</b>
		 →  <b>Ausgeschaltet</b>
 Latte	Erweiterte Einstellung des Mahlgrads	 → <b>Bereich 1</b>
		 → <b>Bereich 2</b>
 Flat White	Werkseinstellungen	Halten Sie die Taste OK für mindestens 5 Sekunden gedrückt, bis die Kontrolllampe permanent eingeschaltet bleibt
 Americano	Wasserhärte	 → <b>weich</b>
		 → <b>mittel</b>
		 → <b>hart/sehr hart</b>

### 3. Speichern Sie die neuen Einstellungen durch Drücken von ON/Bereitschaft (B1)

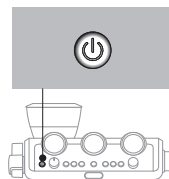













## 8. REINIGUNG DES GERÄTES

### Vorsicht!

- Verwenden Sie zur Reinigung der Maschine keine Lösungs- und Scheuermittel oder Alkohol.
- Verwenden Sie zum Entfernen von Verkrustungen oder Kaffeelagerungen keine Metallgegenstände, weil sie Oberflächen aus Metall oder Kunststoff verkratzen könnten.
- Bei Nichtgebrauch von mehr als einer Woche wird empfohlen, vor dem Gebrauch der Kaffeemaschine einen Spülvorgang durchzuführen.

### Gefahr!

- Während der Reinigung die Kaffeemaschine nie ins Wasser tauchen: es handelt sich um ein Elektrogerät.
- Vor jeder Reinigung der äußeren Teile des Gerätes die Kaffeemaschine ausschalten, den Netzstecker aus der Steckdose ziehen und die Kaffeemaschine abkühlen lassen.



					
	×	✓	✓	×	×
	✓	×	×	✓	✓
	×	×	×	✓	✓
	×	×	×	✓	✓
	×	×	✓	✓	×
	×	×	×	✓	✓
	✓	✓	×	✓	✓

### 8.1 Reinigung des Kaffeeauslaufs

Wenn die Kontrolllampe  sich einschaltet (orange) (B5), muss der Kaffeekreislauf gereinigt werden. Kaufen Sie die Reinigungstabs für Kaffeemaschinen, um den Reinigungszyklus durchzuführen. Für weitere Informationen besuchen Sie bitte [www.Delonghi.com](http://www.Delonghi.com).

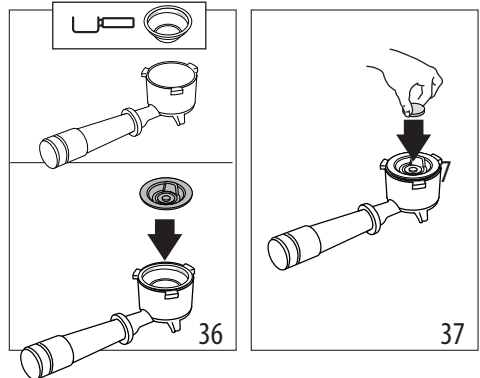
1. Setzen Sie das 1-Tassen-Sieb (C2) in den Siebträger (C1) (Abb. 36).
2. Setzen Sie das Reinigungszubehör (C9) in das Sieb (Abb. 36) und drücken Sie es fest nach unten.



3. Legen Sie den Reinigungstab auf das Zubehör (Abb. 37).
4. Rasten Sie den Siebträger am Kaffeeauslauf (A7) ein.
5. Füllen Sie den Wassertank (A15). Vergewissern Sie sich, dass die Abtropfschale (A11) leer ist.
6. Halten Sie die Taste  gedrückt, bis die entsprechende Kontrolllampe zu blinken beginnt (orange). Nach einigen Minuten wird die Reinigung automatisch abgebrochen.
- Entnehmen Sie den Siebträger und das Reinigungszubehör.
- Waschen Sie den Siebträger und das Sieb unter fließendem Wasser.
- Setzen Sie den Siebträger wieder ein und führen Sie einen Spülvorgang durch, indem Sie die Taste  (B5) drücken: es wird empfohlen, einen Behälter unter den Siebträger zu stellen.
- Nehmen Sie die Abtropfschale heraus und leeren Sie sie.

### Hinweis:

Dieser Reinigungszyklus kann jederzeit gestartet werden, indem die Taste  (B5) für einige Sekunden gedrückt wird. Um den Vorgang abzubrechen, drücken Sie die Taste für 10 Sekunden.

### 8.2 Reinigen Sie das Fach des Kaffeebohnenbehälters

1. Vergewissern Sie sich, dass der Kaffeebohnenbehälter (A1) leer ist. Lassen Sie das Mahlwerk eventuell einige Male leer laufen, um es zu leeren.
2. Rasten Sie den Kaffeebohnenbehälter aus, indem Sie ihn nach links drehen, und ziehen Sie ihn aus der Kaffeemaschine (Abb. 38).



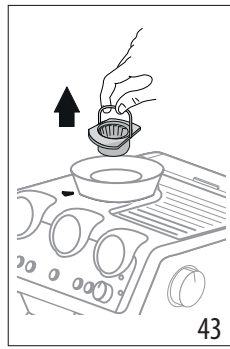
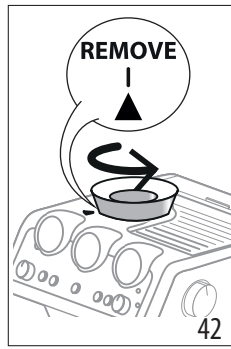
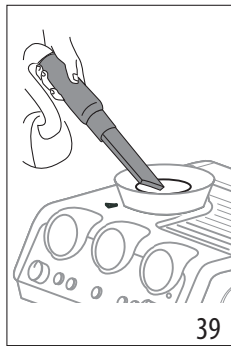
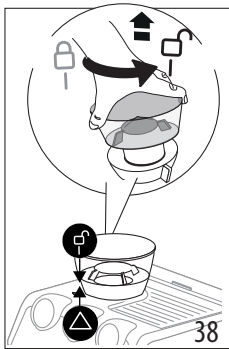

3. Saugen Sie Kaffeerückstände auf (Abb. 39).
4. Reinigen Sie die Aufnahme des Kaffeebohnenbehälters mit einem feuchten Tuch und trocknen Sie sie ab (Abb. 40);

4. Ziehen Sie den oberen Teil des Mahlwerkzeugs an seinem Griff heraus (Abb. 43).
5. Reinigen Sie das Mahlwerkzeug mit einem Pinsel (Abb. 44) und saugen Sie Kaffeerückstände mit einem Staubsauger auf (Abb. 39).

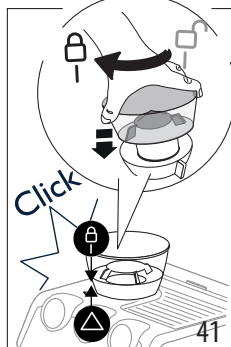
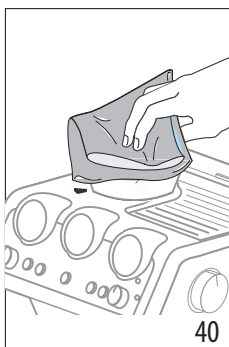

5. Setzen Sie den Kaffeebohnenbehälter wieder in das Mahlwerk ein. Der Behälter ist richtig eingesetzt, wenn der Pfeil ▲ mit dem Symbol ☐ übereinstimmt und ein „Klicken“ zu hören ist (Abb. 41).

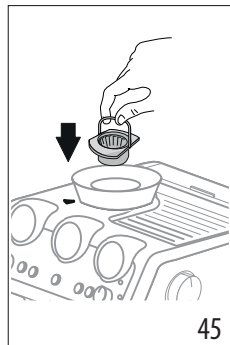
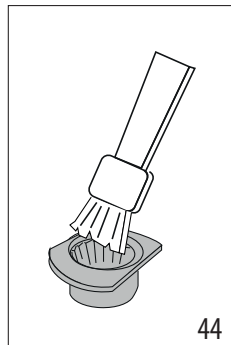

6. Setzen Sie das Mahlwerkzeug in seine Aufnahme (Abb. 45);
7. Drehen Sie den Regler auf den gewünschten Mahlgrad (Abb. 13);

Überprüfen Sie, ob das Mahlwerkzeug richtig eingesetzt ist, indem Sie am Griff ziehen: das Mahlwerkzeug ist richtig eingesetzt, wenn es sich nicht bewegt;

### 8.3 Reinigung der Mahlwerkzeuge

Wenn der Kaffeebohnenbehälter (A1) gereinigt wird, müssen auch die Aufnahme des Behälters und das obere Mahlwerkzeug mit einem feuchten Tuch gereinigt werden. Wenden Sie sich an ein Kundendienstzentrum, um die Mahlwerkzeuge zu entfernen und auszutauschen.

Das Mahlwerkzeug kann entfernt werden, wenn das Mahlwerk durch einen Fremdkörper blockiert ist. Sollte dies passieren, entfernen Sie den Kaffeebohnenbehälter und gehen Sie wie folgt vor:

1. Rasten Sie den Siebträger (C1) ein und lassen Sie das Mahlwerk einmal „leer“ laufen, um den Kaffeeschacht zu befreien.
2. Schalten Sie das Gerät aus.
3. Drehen Sie den Mahlgradregler bis zum Anschlag nach links auf die Position „REMOVE“ (Abb. 42).

### 8.4 Austauschen der Mahlwerkzeuge

Wenn sich die Kaffeepulvermenge weiterhin reduziert, wenden Sie sich an ein Kundendienstzentrum, um die Mahlwerkzeuge auszutauschen: stellen Sie dann das Mahlwerk erneut ein, indem Sie das Menü Einstellungen („7. Menü Einstellungen“) aufrufen und den ersten Bereich der erweiterten Einstellung des Mahlgrads wählen. Drehen Sie dann den Mengenregler (B2) auf MIN und stellen Sie die Menge wie beim ersten Gebrauch ein (siehe „Die „perfekte Menge““).

### 8.5 Reinigung der „Smart Tamping Station“

1. Reinigen Sie den Bereich zum Einrasten mit einem Pinsel (Abb. 46).

- Ziehen Sie den Hebel (A20) bis um Anschlag und reinigen Sie den Tamper mit einem Pinsel (Abb. 47): lassen Sie dann den Hebel wieder los.
- Reinigen Sie die Kaffeerutsche mit einer Bürste (C8)(Abb. 48).

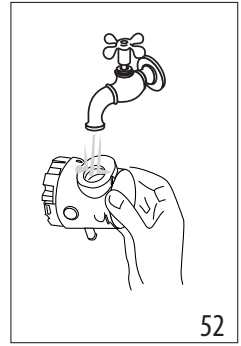
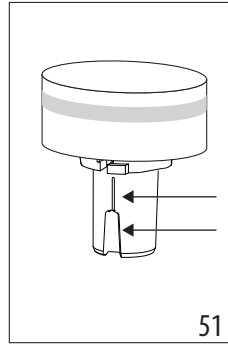
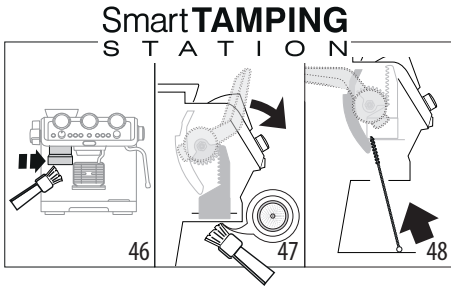

### 8.6 Reinigung des LatteCrema Systems

Alle Teile und den Behälter im Geschirrspüler reinigen, allerdings müssen sie auf der oberen Ablage des Geschirrspülers positioniert werden. Falls kein Geschirrspüler vorhanden ist, die Teile gemäß den Angaben im Hinweis am Ende des Abschnitts von Hand reinigen.

- Drücken Sie die Taste (D3) und haben Sie den Deckel des Milchbehälters (D1) an;
- Ziehen Sie das Milchausgaberoehr (D4) und das Ansaugrohr (D7) heraus (Abb. 49);

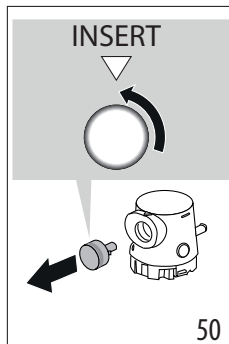
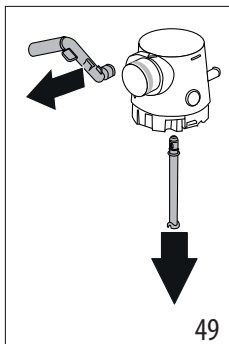

- Drehen Sie den Drehknopf auf „Insert“ und ziehen Sie ihn heraus (Abb. 50);
- Achten Sie besonders darauf, dass an der Aussparung und am Kanal unter dem Drehknopf (Abb. 51) keine Milchrückstände zurückbleiben: schaben Sie den Kanal eventuell mit einem Zahnstocher aus;

- Spülen Sie das Innere der Aufnahme des Milchschaumreglers unter fließendem Wasser aus (Abb. 52);
- Überprüfen Sie ebenfalls, dass das Ansaugrohr und das Ausgaberoehr nicht durch Milchrückstände verstopft sind;
- Alle Teile des Deckels wieder zusammenbauen;
- Waschen und spülen Sie den Milchbehälter (D8) sorgfältig;
- Rasten Sie den Deckel wieder am Milchbehälter ein.



#### Hinweis: Reinigung von Hand

Die Reinigung im Geschirrspüler garantiert die perfekte Hygiene aller Teile des Milchbehälters: bei der Reinigung von Hand alle Teile des Milchbehälters sorgfältig mit Heißwasser reinigen; die Teile in eine Schüssel mit Heißwasser legen und für etwa 30 Minuten eingetaucht lassen, anschließend gemäß den Angaben ab Punkt 4 vorgehen.

### 9. WASSERHÄRTE

Die Kontrolllampe  (B8) Entkalkung schaltet sich nach einer voreingestellten Betriebszeit ein, die von der Wasserhärte abhängt. Die Kaffeemaschine kann je nach der in den verschiedenen Wohnregionen vorhandenen Wasserhärte programmiert werden, sodass die Entkalkung weniger häufig durchgeführt werden muss.

- Nehmen Sie den mitgelieferten Reaktionsstreifen „TOTAL HARDNESS TEST“ (C4) aus seiner Packung;
- Den Streifen etwa eine Sekunde lang vollständig in ein Glas Wasser eintauchen.
- Den Streifen aus dem Wasser nehmen und leicht schütteln. Stellen Sie das Gerät gemäß den Angaben im Kapitel „7. Menü Einstellungen“ ein.

Ergebnis Wasserhärtestest	Taste	Stufe
	× 2	1 weiches Wasser
		2 normales Wasser

Ergebnis Wasserhärte-test	Taste	Stufe
	OK	3 hartes oder sehr hartes Wasser

- Stellen Sie das Gerät gemäß den Angaben im Kapitel „7. Menü Einstellungen“ ein.

## 10. VERWENDUNG VON SOFTBALLS

Softballs (C11) ist ein innovatives System, das die Lebensdauer der Kaffeemaschine verlängert, ohne die Wasserqualität zu beeinflussen, und so die Ausgabe eines cremigen und aromatischen Kaffees garantiert. Um die Wirksamkeit zu optimieren, sollte Softballs vor dem Gebrauch über Nacht im Wasser gelassen werden.

- Nehmen Sie das Softballs-Paket aus der Verpackung (Abb. 53).

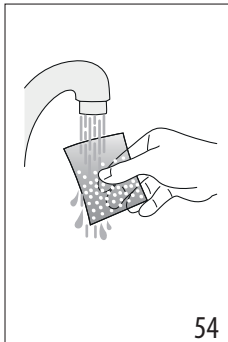
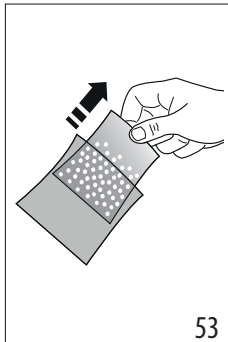

- Spülen Sie das Softballs-Paket unter fließendem Wasser ab (Abb. 54).
- Tauchen Sie den Beutel in den Wassertank (A15) (Abb. 55).

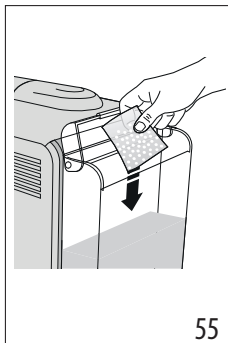

- Tauschen Sie den Softballs-Beutel alle 3 Monate aus (Abb. 56).

## 11. ENTKALKUNG

### Vorsicht!

- Vor dem Gebrauch lesen Sie bitte die Gebrauchsanweisung und die Angaben auf dem Etikett des Entkalkers (C5) durch, die sich auf der Packung des Entkalkers befinden.
- Verwenden Sie ausschließlich Entkalker von De'Longhi. Die Verwendung von ungeeigneten Entkalkern sowie die nicht regelmäßig durchgeführte Entkalkung können zum Auftreten von Defekten führen, die nicht durch die Herstellergarantie abgedeckt sind.
- Der Entkalker kann empfindliche Oberflächen beschädigen. Sollte das Produkt versehentlich verschüttet werden, bitte sofort wegwischen.

### Zur Durchführung der Entkalkung

Entkalker	Entkalker De'Longhi
Behälter	2 zu je 1 Liter
Zeit	~40min

- (FALLS VORHANDEN, DEN WASSERFILTER UND SOFTBALLS ENTFERNEN). Geben Sie den Entkalker bis zum auf der Innenseite des Tanks aufgedruckten Füllstand A in den Wassertank (A15) (entspricht einer 100ml Packung) (Abb. 57).

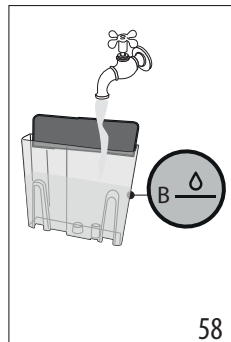
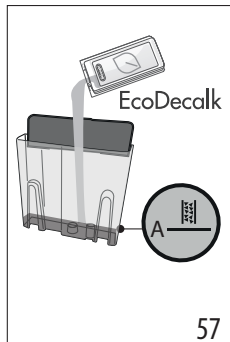

- Füllen Sie bis zum Füllstand B mit Wasser auf (Abb. 58). Setzen Sie dann den Wassertank wieder in die Kaffeemaschine ein.
- Setzen Sie das Zubehör (C6) in die Steckverbindung für das Latte-Crema System (A6) (Abb. 59).

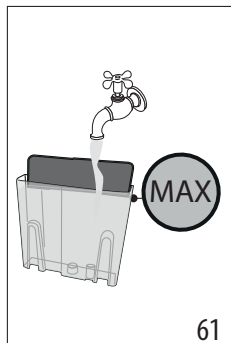
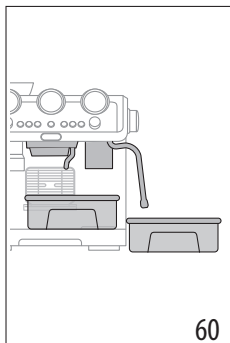
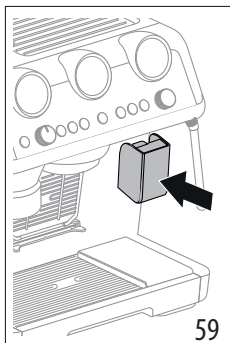



4. Stellen Sie sicher, dass der Siebträger (C1) nicht eingerastet ist, und stellen Sie ein Gefäß unter den Kaffee- und Heißwasser-auslauf (A7) und unter das Dampfausgaberohr (A5) (Abb. 60).
5. Halten Sie die Taste  (B8) gedrückt, bis die entsprechende Kontrolllampe zu blinken beginnt.
6. Das Entkalkungsprogramm startet und die Entkalkungslösung tritt aus den Ausläufen heraus. Das Entkalkungsprogramm führt automatisch eine Reihe von Spülvorgängen und Pausen durch, um die Kalkablagerungen in der Kaffeemaschine zu beseitigen, bis der Tank vollständig geleert ist.

Die Ausgabe wird abgebrochen und die Kontrolllampe  wird weiß. Nun muss ein Spülvorgang durchgeführt werden:



7. Leeren Sie das zum Auffangen der Entkalkungslösung verwendete Gefäß und stellen Sie es erneut unter die Ausläufe.
8. Entnehmen Sie den Wassertank, leeren Sie mögliche Rückstände der Entkalkungslösung aus, spülen Sie den Tank unter fließendem Wasser aus und füllen Sie ihn bis zum Füllstand MAX mit frischem Wasser (Abb. 61). Setzen Sie dann den Wassertank wieder in seine Aufnahme.











9. Halten Sie die Taste  gedrückt, bis die entsprechende Kontrolllampe zu blinken anfängt: der Spülvorgang beginnt.
  10. Nach Beendigung des Spülvorgangs wird die Ausgabe abgebrochen und das Gerät ist betriebsbereit.
  11. Leeren Sie die zum Auffangen des Spülwassers verwendeten Gefäße.
  12. Ziehen Sie die Abtropfschale heraus, leeren Sie sie und setzen Sie sie dann wieder ein.
  13. Ziehen Sie den Wassertank heraus, füllen Sie ihn mit frischem Wasser und setzen Sie ihn dann wieder ein.
- Nun ist das Gerät betriebsbereit.











**Hinweis:**

- Wenn Sie den Entkalkungszyklus zu einem früheren Zeitpunkt durchführen möchten, halten Sie die Taste  für 3 Sekunden gedrückt.
- Falls die Entkalkung versehentlich gestartet wurde, drücken Sie die Taste  für 10 Sekunden; der Spülvorgang kann nicht abgebrochen werden.

**12. BEDEUTUNG DER KONTROLLAMPEN**



KONTROLLAMPEN	BEDEUTUNG KONTROLLAMPEN	DER	VORGANG
Alle Kontrolllampen blinken kurz auf	Einschalten des Geräts		Eigendiagnose
 leuchtet permanent	Die Kaffeemaschine wurde zum ersten Mal eingeschaltet und der Kreislauf muss mit Wasser gefüllt werden		Gemäß den Angaben im Kapitel vorgehen "3. Erste Inbetriebnahme des Gerätes"
 leuchtet permanent	Der Energiesparmodus ist aktiv		Auf den Abschnitt "7. Menü Einstellungen" Bezug nehmen, wenn die Funktion deaktiviert werden soll
			→

KONTROLLAMPEN	BEDEUTUNG KONTROLLAMPEN	DER	VORGANG
 leuchtet permanent	Der Kaffeebohnenbehälter (A1) ist leer		Kaffeebohnenbehälter füllen
 blinkt	Der Mahlvorgang soll durchgeführt werden, aber der Kaffeebohnenbehälter (A1) ist leer		Kaffeebohnenbehälter füllen
 leuchtet permanent	Das Wasser im Tank (A15) ist nicht ausreichend oder der Wassertank ist nicht richtig eingesetzt		Den Wassertank füllen oder den Wassertank entnehmen und wieder korrekt einsetzen
 blinkt	Ein Getränk soll zubereitet werden, aber der Wassertank (A15) ist leer		Den Wassertank füllen
 leuchtet permanent	Allgemeine Störung		Wenden Sie sich an eine Kundendienststelle
 leuchtet permanent	Der Kaffeebohnenbehälter ist nicht eingesetzt		Den Kaffeebohnenbehälter (A1) richtig einsetzen oder überprüfen, dass er richtig eingesetzt ist
 blinkt	Der Wahlschalter unten am Kaffeebohnenbehälter (A1) befindet sich nicht in der richtigen Position		Den Wahlschalter wieder auf eine der Mahlpositionen (zwischen 1 und 8) stellen und dabei folgendes beachten: <ul style="list-style-type: none"> <li>• Den Mahlgrad einstellen während das Mahlwerk in Betrieb ist</li> <li>• Immer nur um eine Stufe verstellen und zwischen zwei Einstellungen mindesten 5 Mahlvorgänge durchführen</li> </ul>
	Der Kaffeebohnenbehälter (A1) ist nicht ganz eingesetzt: die Sicherheitsvorrichtung löst aus		Überprüfen, dass der Kaffeebohnenbehälter richtig eingesetzt ist
 leuchtet permanent	Das LatteCrema System muss nach jedem Gebrauch gereinigt werden		Nach der Zubereitung von Milchgetränken muss die automatische Reinigung durchgeführt werden, indem der Drehknopf (D5) auf Clean gedreht wird
 leuchtet permanent	Das Gerät ist für die Dampfausgabe bereit.		Das Gerät hat die Temperatur erreicht, um Dampf auszugeben. Für die Ausgabe den Ausgabeknopf für Dampf (A4) drehen
 blinkt	Das Gerät ist eingeschaltet und der Energiesparmodus ist aktiv: der Ausgabeknopf für Dampf (A4) ist eingestellt, um Dampf auszugeben		Die Kontrolllampe blinkt, um anzuzeigen, dass das Gerät sich vorbereitet, um Dampf auszugeben: die Ausgabe beginnt, sobald das Gerät aufgeheizt ist
	Das Gerät ist für die Dampfausgabe bereit		Das Gerät ist für die Dampfausgabe aufgeheizt, wenn die Kontrolllampe permanent leuchtet
	Das Gerät gibt gerade Dampf aus		
			→

KONTROLLAMPEN	BEDEUTUNG KONTROLLAMPEN	DER	VORGANG
 leuchtet permanent (orange)	Die Entkalkung muss durchgeführt werden		Die Entkalkung durchführen, wie im Kapitel erläutert "11. Entkalkung"
 blinkt (orange)	Das Gerät führt gerade die Entkalkung durch		Den Vorgang zu Ende führen, wie im Kapitel "11. Entkalkung" beschrieben
 leuchtet permanent (weiß)	Der Spülvorgang muss durchgeführt werden		
 blinkt (weiß)	Das Gerät führt gerade den Spülvorgang durch		
 leuchtet permanent (orange)	Die Reinigung des Kaffeeauslaufs muss durchgeführt werden		Siehe Abschnitt "8.1 Reinigung des Kaffeeauslaufs"
 blinkt (orange)	Das Gerät führt gerade die Reinigung des Kaffeeauslaufs durch		
 blinkt (weiß)	Das Gerät führt gerade einen Spülvorgang durch		
 +  blinkt	Falls der Wasserfilter vorhanden ist, könnte eine Luftblase in den Kreislauf gelangt sein, wodurch die Ausgabe verhindert wird		Die Taste (B7) für die Kontrolllampe  drücken: die Ausgabe beginnt und wird automatisch abgebrochen.
	Der Mahlgrad ist zu fein, sodass der Kaffee zu langsam oder gar nicht herausläuft		Den Siebträger (C1) entnehmen, die Vorgänge für die Kaffeezubereitung wiederholen und dabei die Angaben im Abschnitt "4.1 Schritt 1 - Mahlvorgang (grinding) (Abb. 11)" und "4.2 Schritt 2 - Anpressen (tamping) (Abb. 17)" beachten
	Das Kaffeesieb (C2) oder (C3) ist verstopft		Die Siebe unter fließendem Wasser ausspülen oder mit der Spültaste (B5) einen Spülvorgang durchführen.
	Der Wassertank (A15) ist nicht richtig eingesetzt und die Ventile am Boden sind nicht geöffnet		Den Wassertank leicht andrücken, damit sich die Ventile öffnen
	Kalk im Wasserkreislauf		Die Entkalkung gemäß Kapitel "11. Entkalkung" durchführen

### 13. BETRIEBSSTÖRUNGEN

PROBLEM	URSACHE	ABHILFE
In der Abtropfschale (A11) befindet sich Wasser	Dies gehört zum normalen Betrieb der internen Kreisläufe der Kaffeemaschine	Die Abtropfschale (A11) regelmäßig leeren und reinigen
		→

<b>PROBLEM</b>	<b>URSACHE</b>	<b>ABHILFE</b>
Der Espresso läuft nicht mehr heraus	Kein Wasser im Tank (A15)	Den Tank füllen
	Die Kontrolllampe  (B7) ist eingeschaltet, um anzuzeigen, dass der Kaffeekreislauf oder der Dampfkreislauf leer ist.	Die Taste für die Kontrolllampe  drücken, um den Kreislauf zu füllen.
	Das Sieb (C2) oder (C3) ist verstopft	Die Siebe unter fließendem Wasser ausspülen oder mit der entsprechenden Taste (B5) einen Spülvorgang durchführen.
	Der Wassertank (A15) ist nicht richtig eingesetzt und die Ventile am Boden sind nicht geöffnet	Den Wassertank leicht andrücken, damit sich die Ventile am Boden öffnen
	Kalk im Wasserkreislauf	Die Entkalkung gemäß Kapitel "11. Entkalkung"durchführen
	Mahlgrad zu fein	Den Siebträger (C1) entnehmen, die Vorgänge für die Kaffeezubereitung wiederholen und dabei die Angaben im Abschnitt "4.1 Schritt 1 - Mahlvorgang (grinding) (Abb. 11)" und "4.2 Schritt 2 - Anpressen (tamping) (Abb. 17)" beachten
Der Siebträger rastet nicht am Gerät ein	Das Kaffeepulver wurde nicht gepresst oder die Menge ist zu groß	Den Mahlvorgang mit anderen Einstellungen wiederholen. Die Dosiermenge reduzieren: überprüfen, dass das Sieb (C2) oder (C3) (1 oder 2 Tassen) für die zu mahrende Menge richtig ist (Taste 2x (B3) gewählt oder nicht)
	Der Espresso tropft über die Ränder des Siebträgers (C1) anstatt aus den Löchern	Der Siebträger ist nicht richtig eingesetzt
Der Espresso tropft über die Ränder des Siebträgers (C1) anstatt aus den Löchern	Die Dichtung des Kaffeeauslaufs (A7) hat an Elastizität verloren oder ist verschmutzt	Den Siebträger richtig einrasten und kräftig bis zum Anschlag drehen
	Das Sieb (C2) oder (C3) ist verstopft	Die Dichtung des Kaffeeauslaufs bei einem Kundendienstzentrum austauschen
		Die Siebe unter fließendem Wasser ausspülen oder mit der entsprechenden Taste (B5) einen Spülvorgang durchführen
Die Crema des Kaffees ist hell (der Kaffee läuft zu schnell aus dem Ausguss)	Die Einstellungen des Gerätes müssen überprüft werden	Den Siebträger entnehmen, die Vorgänge für die Kaffeezubereitung wiederholen und dabei die Angaben im Abschnitt „4.1 Schritt 1 - Mahlvorgang (grinding) (Abb. 11)" und „4.2 Schritt 2 - Anpressen (tamping) (Abb. 17)" beachten
→		

<b>PROBLEM</b>	<b>URSACHE</b>	<b>ABHILFE</b>
Die Crema des Kaffees ist dunkel (der Kaffee läuft zu langsam aus dem Ausguss)	Die Einstellungen des Gerätes müssen überprüft werden	Den Siebträger (C1) entnehmen, die Vorgänge für die Kaffeezubereitung wiederholen und dabei die Angaben im Abschnitt "4.1 Schritt 1 - Mahlvorgang (grinding) (Abb. 11)" und "4.2 Schritt 2 - Anpressen (tamping) (Abb. 17)" beachten
Bei der Zubereitung von Cappuccino mit dem LatteCrema System schäumt die Milch nicht auf	Die Milch ist nicht kalt genug	Immer Milch mit Kühlschranktemperatur verwenden
	Der Drehknopf (D5) befindet sich nicht in der richtigen Position	Überprüfen und den Drehknopf auf die richtige Position stellen (☞ max Schaum; ☞ med Schaum; ☞ min Schaum)
	Das LatteCrema System ist verschmutzt	Wie im Abschnitt „8.6 Reinigung des LatteCrema Systems“ erläutert, die Reinigung durchführen
	Kalk im Wasserkreislauf	Die Entkalkung gemäß Kapitel "11. Entkalkung" durchführen
Nach Beendigung der Entkalkung fordert das Gerät einen weiteren Spülvorgang an	Während des Spülvorgangs wurde der Tank nicht bis zum Füllstand MAX gefüllt	Den Spülvorgang wiederholen (siehe Kapitel "11. Entkalkung")
Das Gerät mahlt den Kaffee nicht	Im Mahlwerk befindet sich ein Fremdkörper	Die Mahlwerkzeuge gemäß den Angaben im Abschnitt "8.3 Reinigung der Mahlwerkzeuge" reinigen und sich dabei vergewissern, dass alle Bohnen aus dem Kaffeebohnenbehälter (A2) entfernt wurden, bevor er herausgezogen wird. Bevor das Mahlwerkzeug wieder eingebaut wird, müssen alle Rückstände sorgfältig von seiner Aufnahme abgesaugt werden
	Der Kaffeebohnenbehälter (A1) befindet sich nicht in der richtigen Position	Der Behälter ist richtig eingesetzt, wenn der Pfeil ▲ mit dem Symbol ☞ übereinstimmt und ein „Klicken“ zu hören ist
→		



PROBLEM	URSACHE	ABHILFE
Wenn die Kaffeesorte gewechselt werden soll	Es müssen alle in der Kaffeemaschine vorhandenen Kaffeebohnen entfernt werden	<ul style="list-style-type: none"> <li>• Den Kaffeebohnenbehälter (A1) leeren (das Mahlwerk leer laufen lassen oder restliche Kaffeebohnen eventuell aufsaugen)</li> <li>• Den Siebträger (C1) einrasten und das Mahlwerk „leer“ laufen lassen, um den Kaffeeschacht zu befreien: dann den Siebträger am Ausgang des Mahlwerks (A18) einrasten, indem er zum Text INSERT ausgerichtet wird, und den Siebträger nach rechts drehen (Abb. 22). Der Mahlvorgang beginnt, wenn der Siebträger die Position CLOSE erreicht und wird automatisch abgebrochen. Den Vorgang wiederholen, bis das Sieb leer bleibt</li> <li>• Den Behälter (A1) mit der neuen Kaffeebohnen-sorten füllen</li> <li>• Wenn beim Mahlvorgang nicht die „perfekte Menge“ erreicht wird, wie beim ersten Gebrauch vorgehen</li> </ul>
Nach dem Mahlvorgang ist das Kaffeesieb (C2) oder (C3) leer	Die Kaffeerutsche des Mahlwerks ist verstopft	Wie im Abschnitt „8.5 Reinigung der „Smart Tamping Station““ beschrieben, die Reinigung durchführen. Wenn das Problem weiterhin besteht, die entsprechende Tür (A19) öffnen und die Rutsche mithilfe der Bürste von der Verstopfung befreien
Nach dem Mahlvorgang ist zu viel Kaffeepulver im Sieb		
		→

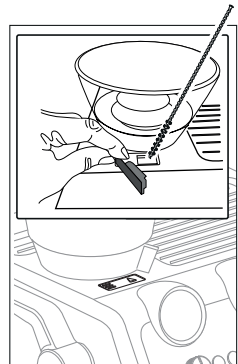

<b>PROBLEM</b>	<b>URSACHE</b>	<b>ABHILFE</b>
Nach dem Mahlvorgang erreicht das Kaffeepulver im Sieb (C2) oder (C3) nicht die „perfekte Menge“	Die „Smart Tamping Station“ muss gereinigt werden	Wie im Abschnitt „8.5 Reinigung der „Smart Tamping Station““ beschrieben, die Reinigung durchführen, dann den Mahlvorgang wiederholen
	Die Kaffeepulvermenge muss eingestellt werden	Die Menge mit dem entsprechenden Drehknopf (B2) einstellen, indem die Angaben im Abschnitt „Die „perfekte Menge““ befolgt werden. Wenn der Drehknopf bereits auf höchster Stufe steht, gemäß den Angaben im Abschnitt „Erweiterte Einstellung des Mahlgrads“ vorgehen
	Mit der Zeit nutzen sich die Mahlwerkzeuge ab	Die Mahlwerkzeuge, wie im Abschnitt „8.4 Austauschen der Mahlwerkzeuge“ beschrieben, austauschen

Lees altijd het boekje met de veiligheidsvoorschriften voordat u het apparaat gebruikt.

## 1. BESCHRIJVING

### 1.1 Beschrijving van het apparaat - A

- A1. Koffiebonereservoir
- A2. Deksel koffiebonereservoir
- A3. Kopjesblad
- A4. Stoomknop
- A5. Stoompijpje
- A6. Aansluiting voor Lattecrema System
- A7. Koffieuitloop
- A8. Kopjesrooster voor espresso
- A9. Kopjesrooster voor glazen of bekers
- A10. Rooster drupbakje
- A11. Drupbakje
- A12. Indicator waterniveau van het drupbakje
- A13. Deksel waterreservoir
- A14. Handgreep uitnemen waterreservoir
- A15. Waterreservoir
- A16. Aansluiting stekker voedingskabel
- A17. Hoofdschakelaar (ON/OFF)
- A18. Uitlaat koffiemolen (Tamping station)
- A19. Luikje voor bereiken koffiegoot koffiemolen
- A20. Hendel koffiestamper

### 1.2 Beschrijving bedieningspaneel - B

- B1. Toets ON/Stand-by
- B2. Regelknop hoeveelheid gemalen koffie
- B3. Toets "X2": voor gebruik filter 2 kopjes koffie
- B4. Toets "koffietemperatuur"
- B5. Toets "spoelen"
- B6. Toets "OK": voor afgifte drank / voor bevestiging
- B7. Toets "afgifte heet water"
- B8. Toets "ontkalking"
- B9. Toets "My": voor personalisatie hoeveelheid dranken
- B10. Selectieknop functies
- B11. Display dranken

#### Dranken op basis van espressokoffie

- Espresso
- Americano
- Koffie

#### Dranken op basis van melk

- Cappuccino
- Flat White
- Latte Macchiato

- B12. Lampje "reiniging melk"
- B13. Lampje "koffiebonereservoir ontbreekt"
- B14. Lampje "algemeen alarm"
- B15. Manometer

- B16. Lampje "geen water"
- B17. Lampje "koffiebonereservoir leeg"
- B18. Spia "energiebesparing"
- B19. Display instellingen en werking:

- Aanduiding van de handeling die het apparaat aan het uitvoeren is
- Aanduiding van de instelling van de geselecteerde koffiedosis
- Aanduiding van de instelling van de geselecteerde koffietemperatuur

### 1.3 Beschrijving van de accessoires - C

- C1. Filterhouder
- C2. Filter 1 kopje
- C3. Filter 2 kopjes
- C4. Teststrookje "Total Hardness Test"
- C5. Ontkalker
- C6. Accessoire voor ontkalking
- C7. Afneembare voedingskabel
- C8. Rond borsteltje
- C9. Reinigingsaccessoire koffieuitloop
- C10. Doek
- C11. Softballs (waterverzachter)
- C12. Naald reiniging stoomsproeier

### 1.4 Niet inbegrepen accessoires reiniging, aanbevolen door de fabrikant

Ga voor meer informatie naar de website [Delonghi.com](http://Delonghi.com).



#### Reinigingstabletten

(Zie "8.1 Reiniging koffieuitloop")



#### Reinigingsmiddel

EAN: 8004399333307

### 1.5 Beschrijving van het LatteCrema System - D

- D1. Deksel melkreservoir
- D2. Aansluiting melkreservoir
- D3. Ontgrendelingsknop deksel
- D4. Melkuitloop (in hoogte verstelbaar)
- D5. Schuimregelknop
- D6. Zitting regelknop
- D7. Melkopvoerpijpje
- D8. Melkreservoir

## 2. HET APPARAAT VOORBEREIDEN

Was alle accessoires met lauwwarm water en afwasmiddel en ga dan als volgt verder:

1. Plaats het drupbakje (A11) compleet met het kopjesrooster (A9) en het rooster van het drupbakje (A10) (afb. 1);

2. Verwijder het waterreservoir (A15) (afb. 2) en vult het tot aan de aanduiding MAX met vers en schoon water (afb. 3).
3. Plaats het waterreservoir dan terug.

**Opgelet:** *Stel het apparaat nooit in werking zonder water in het reservoir of zonder het reservoir.*

**Opgelet:** *Wij raden u aan de waterhardheid zo spoedig mogelijk in te stellen volgens de procedure beschreven in hoofdstuk "7. Menu instellingen".*

### 3. EERSTE INWERKINGSTELLING VAN HET APPARAAT

1. Steek de connector van de voedingskabel (C7) in de daarvoor bestemde aansluiting (A16) op de achterkant van het apparaat (afb. 4); steek vervolgens de stekker in het stopcontact. Zorg ervoor dat de hoofdschakelaar (A17), op de achterkant van het apparaat, geplaatst is op stand I (afb. 5);
2. Plaats onder de heetwateruitloop (ter hoogte van de koffieuitloop (A7)) een bakje met een minimuminhoud van 100 ml (afb. 6);
3. Druk op toets (B7) in overeenstemming met het lampje  (afb. 7): de afgifte start en wordt vervolgens automatisch onderbroken. Maak het bakje leeg.

Voorafgaand aan het eerste gebruik van de machine moeten haar interne circuits gespoeld worden. Ga als volgt te werk:

4. Breng de filterhouder (C1), compleet met filterzeef, aan op de machine: voor een correcte bevestiging moet de greep van de filterhouder uitgelijnd worden met "INSERT" (afb. 8) en vervolgens naar rechts worden gedraaid tot hij is uitgelijnd met de stand "CLOSE";
5. Plaats een bakje onder de filterhouder en onder het stoompijpje (A5);
6. Druk op toets (B5) in overeenstemming met het lampje  (afb. 9): de afgifte start;
7. Draai, na het voltooiën van de afgifte, de stoomknop (A4) (afb. 10) en laat enkele seconden stoom afgeven om het stoomcircuit te spoelen: voor een optimale stoomafgifte wordt aangeraden deze handeling 3 of 4 keer te herhalen. Op deze manier wordt het water uit het pijpje verwijderd alvorens stoom af te geven.

Het apparaat is nu klaar voor gebruik.

**Opgelet:** *de spoeling van de interne circuits wordt ook aangeraden in geval van een langdurig niet-gebruik van het apparaat.*

Bij het eerste gebruik moeten er 4-5 kopjes koffie worden gezet voordat de machine een bevredigend resultaat begint te geven: besteed bijzondere aandacht aan de hoeveelheid gemalen koffie in het filter ((C2) of (C3)) (zie de aanwijzingen van paragraaf "4.1 Fase 1 - Malen (grinding) (afb. 11)").

Ga verder zoals aangegeven in hoofdstuk "De "perfecte dosis"".

## 4. KOFFIE ZETTEN

### 4.1 Fase 1 - Malen (grinding) (afb. 11)

1. Voeg de koffiebonen toe aan het reservoir (A1) (afb. 12). Aangeraden wordt om slechts de hoeveelheid koffiebonen toe te voegen die noodzakelijk is voor de bereiding: op deze manier gebruikt u altijd verse koffie;
2. Selecteer de maalgraad (afb. 13). De fabrieksinstelling is 5 (gemiddelde maalgraad). Als het resultaat niet bevredigend is, pas het niveau dan aan op basis van uw persoonlijke smaak en het type koffie (de regeling moet gebeuren tijdens de werking van de koffiemolen).
3. Plaats een van de filterzeven (C2) of (C3) in de filterhouder (C1) (afb. 14). Als de filterzeef voor 2 kopjes wordt gebruikt, druk dan op toet 2X (B3): met deze selectie wordt ook de afgegeven hoeveelheid espresso verdubbeld.
4. Stel de regelknop hoeveelheid (B2) in; begin bij de minimale stand (afb. 15).

**Opgelet:**



Noteer, na het bereiken van het correcte niveau in de filterhouder, de op het display (B19) weergegeven cijfers ter referentie.

Deze komen niet overeen met de instellingen van de maalgraad, van het gewicht van de gemalen koffie (gr/

oz) of van de maaltijd.

Verwijs naar paragraaf "B3. Toets "X2": voor gebruik filter 2 kopjes koffie" voor meer informatie.

5. Breng de filterhouder aan op de uitloop van de koffiemolen (A18), uitgelijnd met het opschrift INSERT: draai de houder vervolgens naar rechts (afb. 16). De maling start wanneer de houder de stand CLOSE bereikt en wordt automatisch onderbroken.

### Aanpassing van de hoeveelheid koffie in de filterzeef

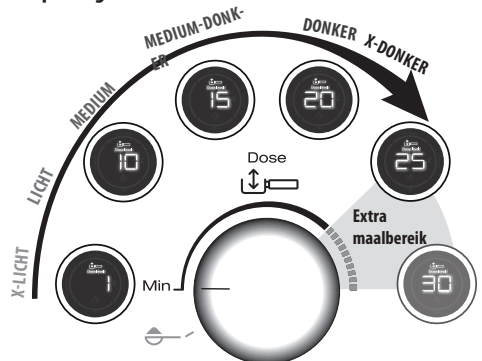

De verschillende soorten koffiebonen geven tijdens de maling verschillende resultaten; om deze reden is er aan het begin van de regeling van de dosering uiterste aandacht nodig.

Deze afbeelding geeft aan hoe de dosis moet worden aangepast op basis van de kleur van de gebrande koffie: neem deze aanwijzingen als uitgangspunt, maar het resultaat kan variëren op basis van de samenstelling van de koffiebonen.

1. Stel de dosis in vanaf de minimale stand.
2. Verwijs naar de kleur van de gebrande koffiebonen en draai de knop langzaam.

#### 4.2 Fase 2 - Aanstampen (tamping) (afb. 17)

1. Verplaats, na het malen, de hendel voor aanstampen (A20) omlaag naar de uiterste stand (verwijder de filterhouder niet) (afb. 18). Voor een perfect resultaat moet deze handeling 2 maal herhaald worden.
2. Houd de hendel op de uiterste lage stand tijdens de verwijdering van de filterhouder (afb. 19). Breng de hendel vervolgens terug naar de uitgangsstand.
3. Controleer of de koffiedosis correct is (zie "De perfecte dosis"), en breng de filterhouder aan op de koffieuitloop (A7) (afb. 20).

#### De "perfecte dosis"

- De koffiefilters hebben aan hun binnenkant een markering voor de identificatie van de perfecte dosis.



#### Lasermarkering

#### Reliëfmarkering

- Filters met lasermarkering: de perfecte dosis komt overeen met de bovenste lijn van de markering;
- Filters met reliëfmarkering: de perfecte dosis komt overeen met de reliëflijn;
- Controleer of de koffie na het aanstampen het correcte niveau heeft. Mogelijk moet de knop (B2) meerdere keren geregeld worden voordat de perfecte dosis wordt gevonden.
- Als de afgegeven koffie te sterk of te slap is en de dosis in de filterzeef is perfect, stel dan een fijnere of grovere maalgraad in (zie "4.1 Fase 1 - Malen (grinding)" (afb. 11)). Als de koffie te sterk is (te langzame afgifte), dan moet de maalgraad grover zijn. Als de koffie te slap is (te snelle afgifte), dan moet de maalgraad fijner zijn.
- **De barista adviseert:** Verwijder de filterhouder terwijl u de hendel van de koffiestamper (A20) omlaag houdt, om een perfecte afwerking van de koffiedosis te verkrijgen.

#### 4.3 Fase 3 - Afgifte (brewing) (afb. 21)

1. Selecteer de gewenste drank (afb. 22).

2. Druk op OK (B6) om de afgifte te starten (afb. 23) (voor-infusie en infusie). De koffieafgifte wordt automatisch onderbroken.

## 5. BEREIDING MELKDRANKEN

### 5.1 Melk opschuimen (afb. 24)

1. Giet de te verwarmen/op te schuimen hoeveelheid melk in het melkreservoir (D8) en houd er rekening mee dat het volume van de melk 2 of 3 keer zal toenemen (afb. 25). Voor rijker en gladder schuim wordt aangeraden om volle koemelk op koelkasttemperatuur te gebruiken (ongeveer 5°C).

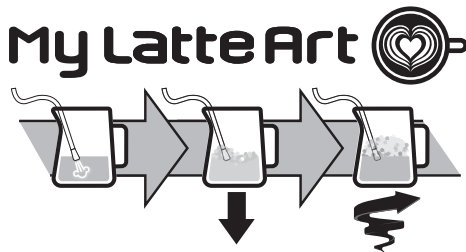

2. Voor het opschuimen van de melk, moet het stoompijpje (A5) op het oppervlak van de melk steunen: op deze manier zal de lucht zich mengen met de melk en de stoom.
3. Houd het stoompijpje op het oppervlak van de melk en let op niet te veel lucht te mengen om grote luchtballen te voorkomen.
4. Dompel het stoompijpje onder het oppervlak van de melk: op deze manier ontstaat er een draaikolk. Draai de stoomknop na het bereiken van de gewenste temperatuur dicht en wacht tot de stoomafgifte volledig stopt alvorens de melkkan weg te nemen.

#### De barista adviseert:

- **Geef de voorkeur aan verse melk.** Gebruik altijd verse melk op koelkasttemperatuur.
- Volle melk geeft de beste resultaten. Het resultaat en de textuur van het schuim variëren afhankelijk van de gebruikte koemelk of plantaardige drank.
- Na het opschuimen van de melk moeten de luchtballen verwijderd worden door de melkkan te schudden.





#### Reiniging van het stoompijpje:

1. Na elk gebruik moeten de melkresten met een doek van het stoompijpje verwijderd worden (afb. 26). Voor een grondige reiniging wordt aangeraden het product Eco MultiClean te gebruiken: op deze manier wordt de hygiëne gewaarborgd door de melkeiwitten en -vetten te verwijderen. Het product kan voor de reiniging van de gehele machine gebruikt worden.
2. Laat gedurende enkele seconden stoom afgeven om het stoompijpje goed schoon te maken (afb. 10).

- Wacht tot het stoompijpje is afgekoeld; gebruik, om de efficiëntie van het stoompijpje te handhaven, de naald voor de reiniging (C12) om de 3 gaatjes vrij te houden (afb. 27).

## 5.2 Melkdranken bereiden met het LatteCrema System (afb. 28)

- Giet in het reservoir (D8) melk op koelkasttemperatuur (5°C) (afb. 29).
- Sluit de deksel (D1) (afb. 30).
- Draai de schuimregelknop (D5) naar de gewenste stand (afb. 31).

Stand schuimregelknop				
				
Reiniging na elk gebruik	MAX schuim	MED schuim	MIN schuim	Voor plaatsing of verwijdering knop

- Breng het melkreservoir aan op de machine (afb. 32).
- Bereid de perfecte dosis (zie "4.1 Fase 1 - Malen (grinding)" (afb. 11)" en "4.2 Fase 2 - Aanstampen (tamping)" (afb. 17)) breng de filterhouder aan.
- Selecteer de gewenste melkdrink (afb. 33).



Drank	Espresso	Melk	Schuim	Hoeveelheid (ml)	X2 (ml)
Cappuccino	1	✓	✓	≈150	≈230
Latte Macchiato	1	✓	✗	≈150	≈230
Flat White	1	✓	✓	≈250	≈330

- Dranken met dubbele dosis (2x):** Giet in het reservoir (D8) de voor de bereiding noodzakelijke hoeveelheid melk; let op het aangegeven niveau MAX niet te overschrijden

(afb. 25). Elke markering op het reservoir komt overeen met ≈100 ml melk.

- Geef de voorkeur aan verse melk.** Gebruik altijd verse melk op koelkasttemperatuur.
- Druk op OK (B6) voor de afgifte (afb. 23). Het apparaat bereid automatisch op volgorde de koffie en de melk.

## Reiniging van het Lattecrema System na elk gebruik:

- Laat het melkreservoir op de machine aangebracht (het is niet nodig het reservoir leeg te maken). Plaats een bakje onder het melkpijpje (D4) (afb. 34).
- Draai de schuimregelknop (D5) naar "Clean" (afb. 35).

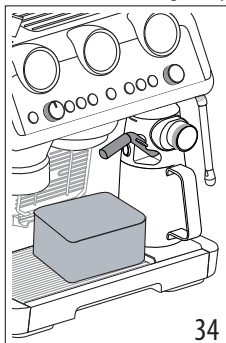

- De reiniging start en wordt automatisch gestopt. Opgelet: aan het einde van de reiniging moet de schuimregelknop worden teruggedraaid naar een van de standen voor schuim.
- Verwijder het melkreservoir en bewaar het in de koelkast: aangeraden wordt om de resterende melk binnen korte tijd op te gebruiken.

Voor een grondige reiniging wordt aangeraden het product Eco MultiClean te gebruiken: op deze manier wordt de hygiëne gewaarborgd door de melkeiwitten en -vetten te verwijderen. Het product kan voor de reiniging van de gehele machine gebruikt worden.

## 6. PERSONALISATIE VAN DE HOEVEELHEID VAN DE KOFFIEDRANKEN MET TOETS (my) (B9)

- Bereid de machine voor, voor het zetten van 1 of 2 kopjes van de gewenste koffiedrank, tot aan het aanbrengen van de filterhouder (C1), compleet met filterzeef (C2) of (C3) en gemalen koffie. Als u een drank op basis van melk wenst te programmeren, breng dan het Lattecrema System aan op de machine.
- Draai de knop (B10) om de te programmeren drank te selecteren.

- Druk op toets : het met toets OK overeenkomstige lampje (B6) gaat continu branden en het lampje van de toets knippert.
- Druk op de toets OK om de afgifte te starten. De lampjes van de toetsen OK en knipperen.
- Druk, wanneer de gewenste hoeveelheid wordt bereikt, op OK. Als de drank de afgifte van een ander ingrediënt voorziet, zal deze afgifte starten: druk, wanneer de gewenste hoeveelheid wordt bereikt, op OK.
- Druk op toets om op te slaan. Het apparaat is klaar voor een nieuw gebruik en het lampje blijft continu branden. Als u het programma niet wenst op te slaan, druk dan op een willekeurige andere toets.

### Opgelet:

- Het is mogelijk om de dranken met koffie te programmeren, maar niet de afgifte van stoom en heet water.
- De programmering wijzigt de hoeveelheden van de dranken, maar niet van de gemalen koffie.
- De dranken "X2" kunnen apart geprogrammeerd worden.
- My LatteArt** kan niet geprogrammeerd worden.
- Houd, om terug te keren naar de fabrieksinstellingen, de toets tot aan de uitschakeling ingedrukt. De geselecteerde drank keert terug naar de fabrieksinstelling.**

Recept koffie	Hoeveelheid fabrieksinstelling	Programmeerbare hoeveelheid
Espresso	35 ml	van 25 tot 90 ml
Espresso X2	70 ml	van 50 tot 180 ml
Coffee	80 ml	van 50 tot 120 ml
Coffee X2	160 ml	van 120 tot 240 ml
Americano	120 ml	<ul style="list-style-type: none"> <li>espresso: van 25 tot 60 ml</li> <li>water: van 25 tot 120ml</li> </ul>
Americano X2	240 ml	<ul style="list-style-type: none"> <li>espresso: van 50 tot 120 ml</li> <li>water: van 50 tot 240 ml</li> </ul>

## 7. MENU INSTELLINGEN

1. Open het menu:		
Druk gedurende 5 seconden gelijktijdig op	x2	
→		

2. Selecteer de te programmeren instelling:		
Drank	Overeenkomstige instelling	Afstellingen
Espresso	Energiebesparing	→  Actief Uitgeschakeld →
Coffee	Automatische uitschakeling	→ 9 minuten
		→ 1,5 uur
		→ 3 uur
Cappuccino	Geluidssignaal	→  Actief Uitgeschakeld →
Latte	Extra regeling van de maalgraad	→ Bereik 1 → Bereik 2
Flat White	Fabriekswaarden	Houd de toets ten minste 5 seconden ingedrukt, tot het lampje continu blijft branden
Americano	Waterhardheid	→ zacht → middelhard → hard/zeer hard
3. Sla de nieuwe instellingen op door te drukken op ON/Standby (B1)		













## 8. REINIGING VAN HET APPARAAT

### Let op!

- Gebruik voor de reiniging van de machine geen oplosmiddelen, schurende reinigingsmiddelen of alcohol.
- Gebruik geen metalen voorwerpen om aanslag of koffieresten te verwijderen omdat ze de metalen of plastic oppervlakken kunnen beschadigen.
- In geval van perioden van niet-gebruik langer dan één week wordt aangeraden een spoeling uit te voeren alvorens de machine weer te gebruiken.

### Gevaar!

- Dompel het apparaat tijdens de reiniging nooit onder in water: het is een elektrisch apparaat.
- Voordat de buitenkant van het apparaat wordt gereinigd, moet het uitgeschakeld worden en moet de stekker uit het stopcontact verwijderd worden. Laat de machine vervolgens afkoelen.

					
	×	✓	✓	×	×
	✓	×	×	✓	✓
	×	×	×	✓	✓
	×	×	×	✓	✓
	×	×	✓	✓	×
	×	×	×	✓	✓
	✓	✓	×	✓	✓

### 8.1 Reiniging koffieuitloop

Als het lampje  (oranje) gaat branden, (B5), moet de reiniging van het koffiecircuit worden uitgevoerd. Voor de reinigingscyclus moeten reinigingstabletten voor koffiemachines worden

aangeschaft. Ga voor meer informatie naar de website [www.Delonghi.com](http://www.Delonghi.com).

1. Breng de filterzeef 1 kopje (C2) aan in de filterhouder (C1) (afb. 36).
2. Plaats het reinigungsaccessoire (C9) in de filterzeef (afb. 36) en druk stevig aan.

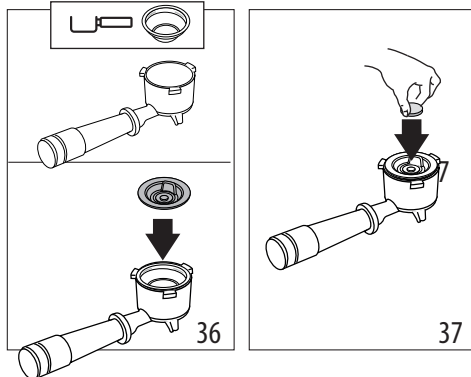

3. Plaats de reinigingstablet op het accessoire (afb. 37).
4. Breng de filterhouder aan op de koffieuitloop (A7).
5. Vul het waterreservoir (A15). Zorg ervoor dat het drupbakje (A11) leeg is.
6. Houd toets  ingedrukt, tot het betreffende lampje begint te knipperen (oranje). De reiniging wordt na enkele minuten automatisch onderbroken.
  - Verwijder de filterhouder en het reinigungsaccessoire.
  - Spoel de filterhouder en de filterzeef onder stromend water.
  - Plaats de filterhouder terug en voer een spoeling uit door te drukken op toets  (B5): we raden aan een bakje onder de filterhouder te plaatsen.
  - Verwijder en ledig het drupbakje.

### Opgelet:

Deze reinigingscyclus kan op elk moment gestart worden door de toets  (B5) enkele seconden ingedrukt te houden. Houd de toets gedurende 10 seconden ingedrukt als u de handeling wenst te annuleren.

### 8.2 Reiniging van het koffiebonenreservoir

1. Zorg ervoor dat het koffiebonenreservoir (A1) leeg is. Maal eventueel enkele keren, zonder koffiebonen toe te voegen, om het reservoir te ledigen.
2. Neem het reservoir weg uit de machine door het linksom te draaien (afb. 38)



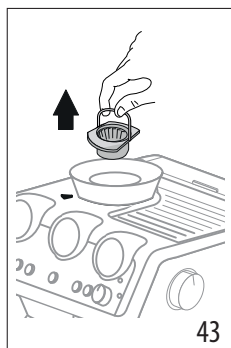
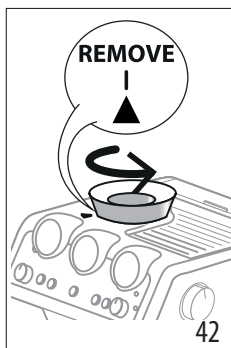
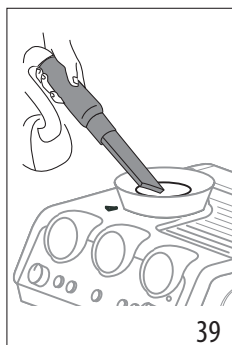
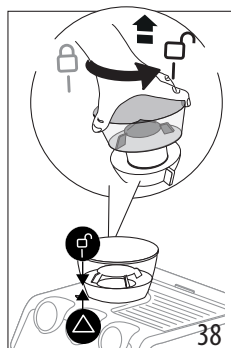

3. Zuig de koffieresten op (afb. 39).
4. Reinig de zitting van het koffiebonenreservoir met een vochtige doek en droog daarna af (afb. 40);

4. Verwijder het bovenste gedeelte van het maalmechanisme door het bij het speciale handvat vast te pakken (afb.43).
5. Reinig het maalmechanisme met een kwast (afb. 44) en zuig de koffieresten op met een stofzuiger (afb. 39).

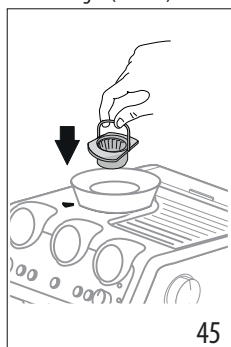
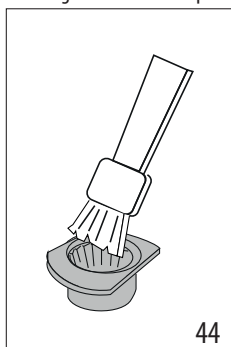
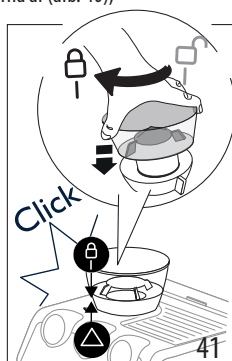
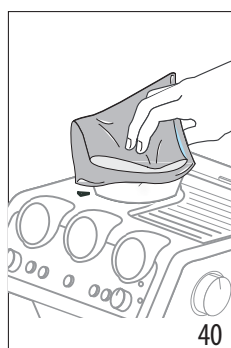

5. Plaats het reservoir terug door het op de koffiemolen aan te brengen. Het reservoir is correct aangebracht als het pijltje ▲ is uitgelijnd met het symbool ☒ en u een "klik" hoort (afb. 41).

6. Plaats het maalmechanisme terug in zijn zitting (afb. 45);
7. Draai de regelknop en selecteer de gewenste maalgraad (afb. 13);

### 8.3 Reiniging van het maalmechanisme

Bij de reiniging van het koffiebonenreservoir (A1), moeten ook de zitting van het reservoir en het bovenste maalmechanisme met een vochtige doek gereinigd worden. Neem voor de verwijdering en vervanging van het maalmechanisme contact op het een servicecentrum.

In geval de koffiemolen geblokkeerd raakt door een vreemd voorwerp, is het mogelijk om het maalmechanisme te verwijderen. Verwijder in dat geval het koffiebonenreservoir en handel als volgt:

1. Breng de filterhouder (C1) aan en maal eenmaal, zonder koffiebonen, om het traject van de koffie vrij te maken.
2. Schakel het apparaat uit.
3. Draai de regelknop van de maalgraad naar de uiterste stand "REMOVE" (afb. 42).

Controleer de correcte plaatsing van het maalmechanisme door aan het handvat te trekken; een goed aangebracht maalmechanisme beweegt niet;

### 8.4 Het maalmechanisme vervangen

Neem, als de hoeveelheid gemalen koffie verder afneemt, contact op met een servicecentrum om het maalmechanisme te laten vervangen. Vervolgens moet de koffiemolen worden afgesteld: open menu instellingen ("7. Menu instellingen") en selecteer het eerste extra regelbereik van de maalgraad. Draai de regelknop van de hoeveelheid (B2) vervolgens naar stand MIN en pas de dosis aan zoals voor het eerste gebruik (zie "De "perfecte dosis"").

### 8.5 Reiniging van het "Smart tamping station"

1. Reinig het koppelingsgebied met een kwast (afb. 46).
2. Trek de hendel (A20) uit tot aan zijn eindstand en reinig de stamper met een kwast (afb.47); laat de hendel dan los.
3. Reinig de koffiegoot met het ronde borsteltje (C8) (afb. 48).

## Smart TAMPING STATION

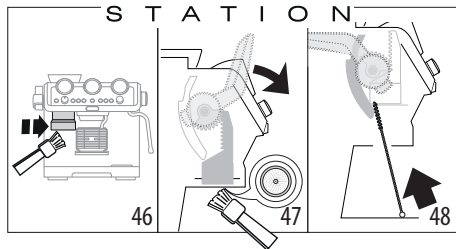

### 8.6 Reiniging van het LatteCrema System

Was alle onderdelen en het reservoir in de vaatwasser; plaats ze daarvoor echter in de bovenste mand van de vaatwasser. Beschikt u niet over een vaatwasmachine, was alles dan met de hand, zoals aangegeven in de opmerking aan het einde van de paragraaf.

1. Druk op de knop (D3) en til de deksel van het melkreservoir op (D1);
2. Neem het melkpijpe (D4) en het opvoerpijpe weg ((D7) (afb. 49);

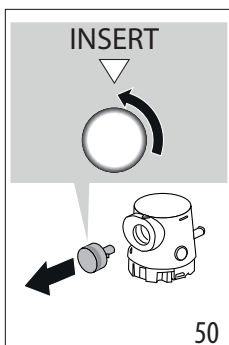
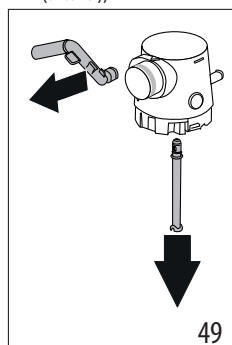

3. Draai de knop naar de stand "Insert" en neem de knop weg (afb. 50);
4. Let met name op dat er in de gleuf en de groef onder de knop (afb. 51) geen melkresten achterblijven: gebruik eventueel een tandenstoker om de groef schoon te schrapen;

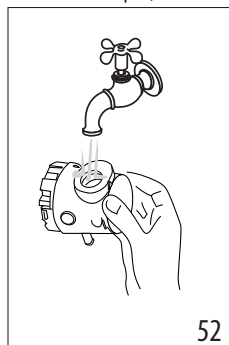
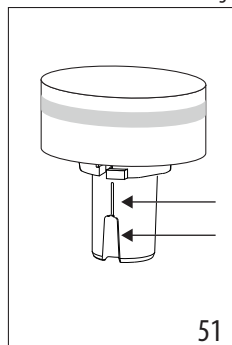

5. Spoel de binnenkant van de zitting van de schuimregelknop af onder stromend water (afb. 52);
6. Controleer ook of het opvoerpijpe en het afgiftepijpe vrij zijn van melkresten;
7. Hermonteer alle onderdelen van de deksel;
8. Was en spoel het melkreservoir zorgvuldig (D8) ;
9. Bevestig de deksel op het melkreservoir.

### Opgelet: met de hand wassen

De vaatwasser verzekert een perfecte hygiëne voor alle onderdelen van het melkreservoir. Worden ze met de hand gewassen, dan moeten alle onderdelen van het melkreservoir zorgvuldig gewassen worden met warm water en moeten ze gedurende ongeveer 30 minuten ondergedompeld blijven in een bak met warm water alvorens verder te gaan zoals beschreven onder stap 4.

### 9. WATERHARDHEID

Het lampje  (B8) ontkalking gaat branden na een vooraf bepaalde periode van werking die afhankelijk is van de waterhardheid. Het is mogelijk om de machine te programmeren op basis van de werkelijke plaatselijke waterhardheid, zodat de ontkalking minder vaak uitgevoerd hoeft te worden.

1. Verwijder het meegeleverde reactiestrookje "TOTAL HARDNESS TEST" (C4) uit zijn verpakking.
2. Dompel het strookje ongeveer één seconde geheel onder in een glas water.
3. Neem het strookje uit het water en schud het lichtjes. Stel het apparaat in zoals beschreven in hoofdstuk "7. Menu instellingen".

Resultaat test waterhardheid	Toets	Niveau
	× 2	1 zacht water
		2 middelhard water
	OK	3 hard of zeer hard water

4. Stel het apparaat in zoals beschreven in hoofdstuk "7. Menu instellingen".

### 10. SOFTBALLS GEBRUIKEN

Softballs (C11) is een innovatief systeem dat de levensduur van de machine verlengt, zonder de kwaliteit van het water te wijzigen, en de afgifte van romige en geurende koffie garandeert. Om de doeltreffendheid ervan te verbeteren, moet Softballs voorafgaand aan het gebruik een hele nacht in het water gelaten worden.

1. Neem het zakje Softballs uit de verpakking (afb. 53).

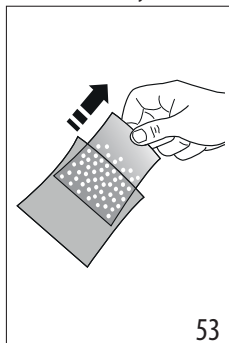

2. Spoel het zakje Softballs af onder stromend water (afb. 54).
3. Dompel het zakje onder in het waterreservoir (A15) (afb. 55).

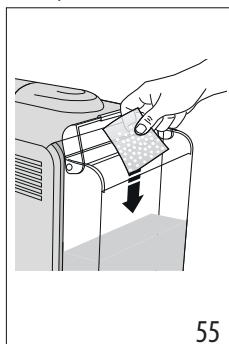

4. Vervang het zakje Softballs om de 3 maanden (afb. 56).

## 11. ONTKALKING

### Let op!

- Lees voorafgaand aan het gebruik de aanwijzingen en het etiket van de ontkalker (C5), zoals aangegeven op de verpakking van het product.
- Wij raden aan uitsluitend de ontkalker van De'Longhi te gebruiken. Het gebruik van ongeschikte ontkalkers en het niet regelmatig uitvoeren van de ontkalking kan leiden tot het optreden van gebreken die niet gedekt worden door de garantie van de fabrikant.
- De ontkalker kan kwetsbare oppervlakken beschadigen. Bij per ongeluk morsen van het product onmiddellijk opnemen en drogen.

Voor de ontkalking	
Ontkalker	Ontkalker De'Longhi
Bakjes	2 van 1 liter elk
Tijd	~40min

1. (INDIEN AANWEZIG, HET VERZACHTINGSFILTER EN SOFTBALLS VERWIJDEREN). Giet de ontkalker in het waterreservoir (A15), tot aan niveau A (komt overeen met een verpakking van 100ml) aangegeven op de binnenkant van het reservoir (afb. 57).

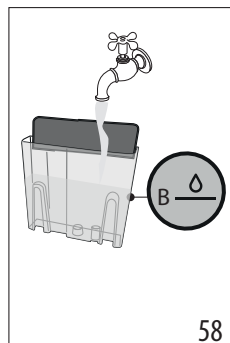
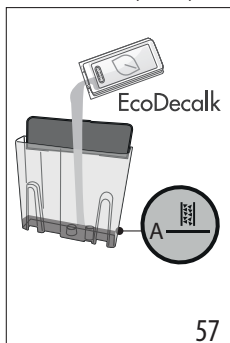

2. Voeg water toe tot aan niveau B (afb. 58). Plaats het waterreservoir terug in de machine.
3. Breng het accessoire (C6) aan op de aansluiting voor LatteCrema System (A6) (afb. 59).

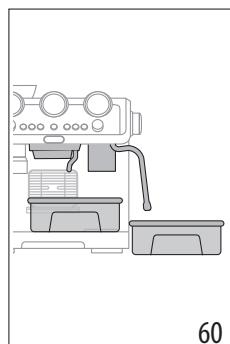
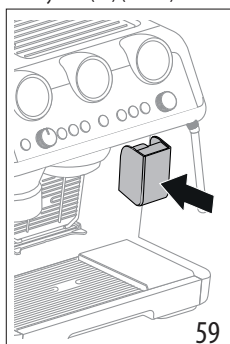



4. Zorg ervoor dat de filterhouder (C1) niet is aangebracht en plaats een bakje onder de uitlopen van koffie en heet water (A7), en onder het stoompijpje (A5) (afb. 60).
5. Houd toets (B8) ingedrukt tot het betreffende lampje begint te knipperen.
6. Het ontkalkingsprogramma wordt gestart en de ontkalkingsvloeistof stroomt uit de uitlopen. Het ontkalkingsprogramma voert automatisch, met tussenpozen, een reeks spoelingen uit om de kalkresten uit het koffiezetapparaat te verwijderen, tot het reservoir leeg is.

De afgifte stopt en het lampje wordt wit gekleurd. Vervolgens moet er een spoelcyclus worden uitgevoerd:

7. Maak de voor het opvangen van de ontkalkingsoplossing gebruikte bak leeg en plaats hem terug onder de uitlopen.

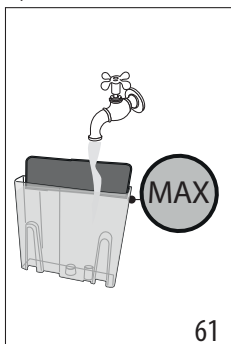

8. Verwijder het waterreservoir, verwijder de eventuele resten van ontkalkingsoplossing, spoel het reservoir af onder stromend water en vul het met vers water tot aan niveau MAX (afb. 61). Plaats het reservoir dan terug in zijn zitting.











9. Houd toets  ingedrukt tot het betreffende lampje begint te knipperen: de spoeling wordt gestart.
10. Na het voltooiën van de spoeling wordt de afgifte onderbroken en is het apparaat klaar voor gebruik.
11. Ledig de voor het opvangen van het spoelwater gebruikte bak.
12. Verwijder en ledig het drupbakje en plaats het terug.
13. Verwijder het waterreservoir, vul het met vers water en plaats het terug.











Het apparaat is nu klaar voor gebruik.

**Opgelet:**



- Als u de ontkalkingscyclus eerder wenst uit te voeren, houd toets  dan gedurende 3 seconden ingedrukt.
- Mocht de ontkalking per ongeluk zijn gestart, houd toets  dan 10 seconden ingedrukt; de spoeling kan niet onderbroken worden.

## 12. BETEKENIS VAN DE LAMPJES



LAMPJES	BETEKENIS VAN DE LAMPJES	HANDELING
Alle lampjes knipperen kort	Inschakeling van het apparaat	Zelfdiagnose
 continu brandend	Het betreft de eerste inschakeling van de machine en het watercircuit moet gevuld worden	Ga te werk zoals beschreven in hfdst. "3. Eerste inwerkingstelling van het apparaat"
 continu brandend	De functie energiebesparing is actief	Verwijs voor de eventuele deactivering van de functie naar hfdst. "7. Menu instellingen"
 continu brandend	Het koffiebonenreservoir (A1) is leeg	Vul het koffiebonenreservoir
 knipperend	Er is geprobeerd koffie te malen, maar het koffiebonenreservoir (A1) is leeg	Vul het koffiebonenreservoir
 on	Het water in het reservoir (A15) is niet voldoende of het waterreservoir is niet goed geplaatst	Vul het reservoir of verwijder het en plaats het correct terug
 knipperend	Er is geprobeerd een drank te bereiden, maar het waterreservoir (A15) is leeg	Vul het waterreservoir
 continu brandend	Algemeen alarm	Neem contact op met een servicecentrum
 continu brandend	Het koffiebonenreservoir is niet aangebracht	Plaats het koffiebonenreservoir (A1) of controleer de correcte plaatsing ervan
		→

LAMPJES	BETEKENIS VAN DE LAMPJES	HANDELING
 knipperend	De keuzeschakelaar onder op het koffiebonenreservoir (A1) is niet in de juiste stand geplaatst	Breng de keuzeschakelaar naar één van de standen voor malen (van 1 tot 8) en denk eraan: <ul style="list-style-type: none"> <li>• De maalgraad moet worden afgesteld tijdens de werking van de koffiemolen</li> <li>• Pas één niveau per keer aan en maal ten minste 5 keer tussen de verschillende aanpassingen</li> </ul>
	Het koffiebonenreservoir (A1) is niet goed aangebracht: de veiligheidsvoorziening grijpt in	Controleer of het koffiebonenreservoir correct is aangebracht
 continu brandend	Het LatteCrema System moet na elk gebruik gereinigd worden	Voer na het voltooien van de bereidingen op basis van meld de automatische reiniging uit door de knop (D5) naar Clean te draaien
 continu brandend	Het apparaat is klaar voor de afgifte van stoom.	Het apparaat heeft de temperatuur bereikt voor de afgifte van stoom. Voor de afgifte moet de stoomknop (A4) gedraaid worden
 knipperend	Het apparaat is ingeschakeld en de functie energiebesparing is actief: de stoomknop (A4) staat op de stand voor de afgifte van stoom	Het knipperende lampje geeft aan dat het apparaat zich voorbereid op de afgifte van stoom: de afgifte start zodra het apparaat op temperatuur is
	Het apparaat is klaar voor de afgifte van stoom	Het apparaat is op temperatuur voor de bereiding van stoom als het lampje continu brandt
	Het apparaat geeft stoom af	
 continu brandend (oranje)	De ontkalking moet worden uitgevoerd	Voer de ontkalking uit zoals aangegeven in hfdst. "11. Ontkalking"
 knipperend (oranje)	Het apparaat is de ontkalking aan het uitvoeren	Ga verder met de handeling volgens de beschrijvingen van hfdst. "11. Ontkalking"
 continu brandend (wit)	De spoeling moet worden uitgevoerd	
 knipperend (wit)	Het apparaat is de spoeling aan het uitvoeren	
 continu brandend (oranje)	De koffieuitloop moet gereinigd worden	Zie par. "8.1 Reiniging koffieuitloop"
 knipperend (oranje)	Het apparaat is de reiniging van de koffieuitloop aan het uitvoeren	
 knipperend (wit)	Het apparaat is een spoeling aan het uitvoeren	



LAMPJES	BETEKENIS VAN DE LAMPJES	HANDELING
 knipperend	In geval het verzachtingsfilter aanwezig is, zou een luchtbel in het circuit de afgifte kunnen blokkeren	Druk op toets (B7) in overeenstemming met het lampje  : de afgifte start en wordt automatisch onderbroken.
	De maalgraad is te fijn en de koffie loopt daardoor te langzaam of helemaal niet.	Verwijder de filterhouder (C1) en herhaal de handelingen voor het zetten van koffie volgens de aanwijzingen van par. "4.1 Fase 1 - Malen (grinding) (afb. 11)" en "4.2 Fase 2 - Aanstampen (tamping) (afb. 17)"
	De filterzeef (C2) of (C3) is verstopt	Spoel de filterzeven onder stromend water of voer een spoeling uit met toets (B5).
	Het reservoir (A15) is niet goed geplaatst of de ventielen ervan zijn niet geopend	Druk het reservoir licht aan om de ventielen ervan te openen
	Kalk in het hydraulische circuit	Voer de ontkalking uit zoals beschreven in hfdst. "11. Ontkalking"

### 13. ALS ER IETS NIET WERKT

PROBLEEM	OORZAAK	OPLOSSING
Er is water aanwezig in het drupbakje (A11)	Dit maakt deel uit van de normale werking van de interne circuit van de machine	Ledig en reinig het drupbakje regelmatig (A11)
Er wordt geen espresso afgegeven	Geen water in het reservoir (A15)	Vul het waterreservoir
	Het lampje  (B7) brandt om aan te geven dat het koffie- of stoomcircuit leeg is.	Druk op de toets van het lampje  om het circuit te vullen.
	De filterzeef (C2) of (C3) is verstopt	Spoel de filterzeven onder stromend water of voer een spoeling uit met toets (B5)
	Het reservoir (A15) is niet goed geplaatst en de ventielen op de bodem ervan zijn niet geopend	Druk het reservoir licht aan om de ventielen op de bodem te openen
	Kalk in het hydraulische circuit	Voer de ontkalking uit zoals beschreven in hfdst. "11. Ontkalking"
	Te fijne maalgraad	Verwijder de filterhouder (C1) en herhaal de handelingen voor het zetten van koffie volgens de aanwijzingen van par. "4.1 Fase 1 - Malen (grinding) (afb. 11)" en "4.2 Fase 2 - Aanstampen (tamping) (afb. 17)"
→		

<b>PROBLEEM</b>	<b>OORZAAK</b>	<b>OPLOSSING</b>
De filterhouder kan niet op het apparaat bevestigd worden	De gemalen koffie is niet aangestampt of de filterhouder bevat te veel koffie	Herhaal de maling met andere instellingen. Verminder de hoeveelheid koffie: controleer of de filterzeef (C2) of (C3) (1 of 2 kopjes) correct zijn ten opzichte van de te malen dosis (toets 2x (B3) wel of niet geselecteerd)
De espressokoffie druppelt over de rand van de filterhouder (C1) in plaats van door de gaatjes	De filterhouder is niet goed geplaatst	Bevestig de filterhouder correct en draai hem stevig tot aan de uiterste stand vast
	De pakking van de koffieuitloop (A7) is niet langer elastisch of is vuil	Laat de pakking van de koffieuitloop vervangen door een servicecentrum
	De filterzeef (C2) of (C3) is verstopt	Spoel de filterzeven onder stromend water of voer een spoeling uit met de betreffende toets (B5)
De crème van de koffie is licht van kleur (de koffie stroomt snel uit de tuitjes)	De instellingen van het apparaat moeten gecontroleerd worden	Verwijder de filterhouder en herhaal de handelingen voor het zetten van koffie volgens de aanwijzingen van par. "4.1 Fase 1 - Malen (grinding) (afb. 11)" en "4.2 Fase 2 - Aanstampen (tamping) (afb. 17)"
De crème van de koffie is donker (de koffie stroomt langzaam uit de tuitjes)	De instellingen van het apparaat moeten gecontroleerd worden	Verwijder de filterhouder (C1) en herhaal de handelingen voor het zetten van koffie volgens de aanwijzingen van par. "4.1 Fase 1 - Malen (grinding) (afb. 11)" en "4.2 Fase 2 - Aanstampen (tamping) (afb. 17)"
Tijdens het bereiden van een cappuccino met het LatteCrema System wordt er geen melkschuim gevormd	De melk is niet koud genoeg	Gebruik altijd melk op koelkasttemperatuur
	De regelknop (D5) staat niet op de juiste stand	Controleer en draai de knop naar de juiste stand ( ☺ max schuim; ☹ med schuim; ☹ min schuim )
	Het LatteCrema System is vuil	Voer de reiniging uit zoals beschreven in paragraaf "8.6 Reiniging van het Latte-Crema System"
	Kalk in het hydraulische circuit	Voer de ontkalking uit zoals beschreven in hfdst. "11. Ontkalking"
Na het voltooien van de ontkalking vereist het apparaat nog een spoeling	Tijdens de ontkalking is het reservoir niet tot aan het niveau MAX gevuld	Herhaal de spoeling (zie hfdst. "11. Ontkalking")
		→

PROBLEEM	OORZAAK	OPLOSSING
Het apparaat maalt de koffie niet	Een vreemd voorwerp in de koffiemolen	Reinig de maalmechanismen zoals beschreven in par. "8.3 Reiniging van het maalmechanisme", en zorg ervoor dat alle koffiebonen uit het koffiebonenreservoir (A2) zijn verwijderd voordat het reservoir wordt weggenomen. Voorafgaand aan de terugplaatsing moeten alle resten zorgvuldig uit de zitting van het reservoir worden opgezogen
	Het koffiebonenreservoir (A1) is niet correct geplaatst	Het reservoir is goed geplaatst als het pijltje ▲ is uitgelijnd met het symbool  en u een "klik" hoort
Als u het type koffie wenst te wijzigen	Alle in de machine aanwezige koffiebonen moeten verwijderd worden	<ul style="list-style-type: none"> <li>• Maak het koffiebonenreservoir (A1) leeg (door te malen zonder koffiebonen toe te voegen of door de resterende bonen op te zuigen).</li> <li>• Breng de filterhouder (C1) aan op de machine en maal een paar keer zonder koffiebonen toe te voegen om het kanaal van de gemalen koffie vrij te maken: bevestig de filterhouder vervolgens op de uitloop van de koffiemolen (A18), uitgelijnd met het opschrift INSERT, en draai de houder naar rechts (afb. 22). De maling start wanneer de houder de stand CLOSE bereikt en wordt automatisch onderbroken. Herhaal tot de filterhouder leeg blijft</li> <li>• Voeg de nieuwe kwaliteit koffie toe aan het koffiebonenreservoir (A1)</li> <li>• Als met de maling niet de "perfecte dosis" wordt verkregen, ga dan te werk zoals voor het eerste gebruik</li> </ul>
→		

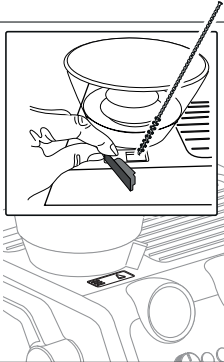

PROBLEEM	OORZAAK	OPLOSSING
<p>Na het malen is de filterzeef (C2) of (C3) leeg</p> <p>Na de maling bevat de filterzeef te veel koffie</p>	<p>De koffiegoot van de koffiemolen is verstopt</p>	<p>Voer de reiniging uit zoals beschreven in par. "8.5 Reiniging van het "Smart tamping station"". Als het probleem aanhoudt, open dan het luikje (A19) om de koffiegoot te bereiken en reinig de goot met het ronde borsteltje</p> 
<p>Na de maling bereikt de gemalen koffie in de filterzeef (C2) of (C3) niet de "perfecte dosis"</p>	<p>Het "Smart Tamping Station" moet gereinigd worden</p> <p>De hoeveelheid gemalen koffie moet worden aangepast</p> <p>Na verloop van tijd zullen het maalmechanisme verslijten</p>	<p>Voer de reiniging uit zoals beschreven in par. "8.5 Reiniging van het "Smart tamping station"", en herhaal vervolgens de maling</p> <p>Regel de hoeveelheid met de daarvoor bestemde knop (B2) en volgens de aanwijzingen van par. "De "perfecte dosis"". Als de knop al op stand max staat, ga dan te werk zoals aangegeven onder paragraaf "Extra regeling van de maalgraad"</p> <p>Vervang het maalmechanisme zoals aangegeven in par. "8.4 Het maalmechanisme vervangen"</p>

Antes de utilizar el aparato lea siempre el folleto en que figuran las advertencias de seguridad.

## 1. DESCRIPCIÓN

### 1.1 Descripción del aparato - A

- A1. Recipiente del café en granos
- A2. Tapa del recipiente para el café en granos
- A3. Apoyatazas
- A4. Botón vapor
- A5. Tubo salida vapor
- A6. Conector para Sistema Lattecrema
- A7. Salida café
- A8. Rejilla apoyatazas para espresso
- A9. Rejilla apoyatazas para vasos o mug
- A10. Rejilla bandeja
- A11. Recipiente recogegotas
- A12. Indicador del nivel del agua de la bandeja recogegotas
- A13. Tapa depósito de agua
- A14. Asa extracción depósito de agua
- A15. Depósito de agua
- A16. Soporte del conector del cable de alimentación
- A17. Interruptor general (ON/OFF)
- A18. Salida molinillo (Tamping station)
- A19. Puerta para acceder a la rampa del molinillo
- A20. Palanca prensador

### 1.2 Descripción del panel de control - B

- B1. Botón ON/Standby
- B2. Botón regulación cantidad de café molido
- B3. Botón "X2": para utilizar el filtro 2 cafés
- B4. Botón "temperatura café"
- B5. Botón "enjuague"
- B6. Botón "OK": para que salga la bebida/para confirmar
- B7. Botón "salida de agua caliente"
- B8. Botón "descalcificación"
- B9. Botón "My": para personalizar la longitud de las bebidas
- B10. Botón selección funciones
- B11. Display bebidas:

#### Bebidas a base de café Espresso

- Espresso
- Americano
- Café

#### Bebidas a base de leche

- Cappuccino
- Flat White
- Latte Macchiato

- B12. Indicador "limpieza leche"
- B13. Indicador "falta recipiente del café en granos"
- B14. Indicador "alarma general"
- B15. Manómetro

- B16. Indicador "falta agua"
- B17. Indicador "recipiente del café en granos vacío"
- B18. Indicador "ahorro energético"
- B19. Display configuraciones y proceso:
  - Indica la operación que está realizando el aparato
  - Indica la configuración de la dosis de café seleccionada
  - Indica la configuración de la temperatura del café seleccionada

### 1.3 Descripción de los accesorios - C

- C1. Copa portafiltro
- C2. Filtro 1 taza
- C3. Filtro 2 tazas
- C4. Tira reactiva "Prueba dureza total"
- C5. Descalcificador
- C6. Accesorio para descalcificación
- C7. Cable de alimentación extraíble
- C8. Escobilla
- C9. Accesorio limpieza surtidor de café
- C10. Paño
- C11. Softballs (ablandador de agua)
- C12. Aguja de limpieza para varilla de vapor

### 1.4 Accesorios de limpieza no incluidos, recomendados por el fabricante

Para más información, visita [Delonghi.com](http://Delonghi.com).



#### Pastillas limpieza

(Véase "8.1 Limpieza del surtidor de café")

 **Limpiador**  
EAN: 8004399333307

### 1.5 Descripción del LatteCrema System - D

- D1. Tapadera del recipiente de leche
- D2. Conector del recipiente de la leche
- D3. Botón de liberación de la tapa
- D4. Surtidor leche (ajustable en altura)
- D5. Botón de regulación espuma
- D6. Compartimiento botón regulador
- D7. Tubo de aspiración de leche
- D8. Recipiente de la leche

## 2. PREPARACIÓN DEL APARATO

Lave con agua tibia y detergente para vajillas todos los accesorios, después proceda de la siguiente manera:

1. Meta la bandeja recogegotas (A11) con la rejilla apoyatazas (A9) y la rejilla bandeja (A10) (fig. 1);

2. Saque el depósito de agua (A15) (fig. 2) y llénelo con agua fresca y limpia sin superar el mensaje MÁX (fig. 3).
3. A continuación vuelva a meter el depósito.

**Atención:** No ponga nunca en funcionamiento el aparato sin agua en el depósito o sin depósito.

**Nota Bene:** Le aconsejamos personalizar cuanto antes la dureza del agua, para ello siga el procedimiento descrito en el capítulo "7. Menú configuraciones".

### 3. PRIMERA PUESTA EN FUNCIONAMIENTO DEL APARATO

1. Introduzca el conector del cable de alimentación (C7) en su soporte (A16), situado en la parte posterior del aparato (fig. 4); a continuación meta la clavija en la toma. Asegurándose que el interruptor general (A17), que se encuentra en la parte posterior del aparato esté pulsado en la posición I (fig. 5);
2. Coloque debajo del surtidor de agua caliente (a nivel del surtidor de café (A7)) un recipiente con capacidad mínima de 100 ml (fig. 6);
3. Pulse el botón (B7) correspondiente al indicador  (fig. 7): la salida comienza y se interrumpe automáticamente. Vacíe el recipiente.

Antes de empezar a utilizar la cafetera es necesario enjuagar sus circuitos internos. Proceda de la siguiente manera:

4. Enganche la copa portafiltro (C1) con el filtro a la máquina para un enganche correcto; alinee el asa de la copa portafiltro a «INSERT» (fig. 8) y gire el asa hacia la derecha, hasta alinearla a la posición «CLOSE»;
5. Coloque un recipiente bajo la copa portafiltro y del tubo de salida del vapor (A5);
6. Pulse el botón (B5) correspondiente al indicador  (fig. 9): la salida comienza;
7. Finalizado el suministro, gire el botón vapor (A4) (fig. 10) y suministre café por algunos segundos de modo de enjuagar el circuito vapor: para un suministro óptimo de vapor, se recomienda repetir esta operación 3 o 4 veces. Esto permite eliminar el agua en el tubo antes de que salga vapor.

El aparato está listo para el uso.

**Nota Bene:** se aconseja enjuagar los circuitos internos también en caso de que no se use el aparato durante un tiempo prolongado.

Cuando utilice por primera vez la cafetera, será necesario preparar 4-5 cafés antes de obtener buenos resultados: dedique atención especial a la dosis de café molida en el filtro ((C2) o (C3)) (véanse las instrucciones en el apartado "4.1 Fase 1 - Molienda (grinding) (fig. 11)").

Proceda tal y como indicado en el capítulo "La "dosis perfecta"".

## 4. PREPARAR EL CAFÉ

### 4.1 Fase 1 - Molienda (grinding) (fig. 11)

1. Vierta los granos en el recipiente (A1) (fig. 12). Se recomienda verter solo los granos necesarios para la preparación: de este modo se utilizará siempre café fresco;

2. Seleccione el grado de molienda (fig. 13). La configuración de fábrica es 5 (molienda media). Si el resultado no fuera satisfactorio, regule el nivel en base al gusto personal y al tipo de café (la regulación debe realizarse durante el funcionamiento del molinillo).
3. Introduzca uno de los filtros de café (C2) o (C3) en el portafiltro (C1) (fig. 14). Si se utiliza el filtro para 2 tazas, pulse el botón 2X (B3): con esta selección se dobla también la cantidad suministrada de espresso.
4. Regule el botón cantidad (B2) partiendo de la posición mínima (fig. 15).

**Nota bene:**



Los números visualizados en el display (B19) son una referencia a anotar una vez alcanzado el nivel correcto en el portafiltro.

No corresponden a las configuraciones de molienda, al peso del café molido (gr/oz) o al tiempo de molienda.

Consulte el apartado "B3. Botón "X2": para utilizar el filtro 2 cafés" para indicaciones adicionales.

5. Enganche el portafiltro a la salida del molinillo (A18) alineándolo con el mensaje INSERT: a continuación gire hacia la derecha la copa (fig. 16). La molienda inicia cuando la copa alcanza la posición CLOSE y se interrumpe automáticamente.

### Regule la cantidad de café molido en el filtro

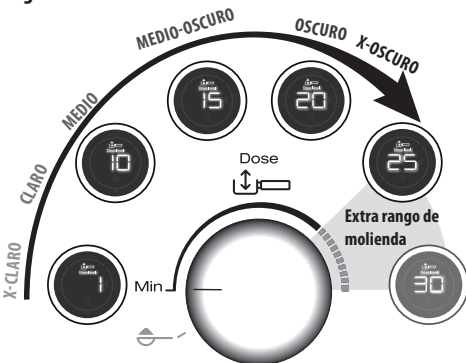

Cada variedad de grano da un resultado diverso durante la molienda y por esto al inicio la regulación de la dosis requiere cuidado extremo.

Esta ilustración da las indicaciones sobre cómo regular la dosis, basadas en el color del tostado: se deben considerar un punto de partida, pero pueden variar en base a la composición de los granos de café.

1. Configure la dosis desde la posición mínima.
2. Haciendo referencia al color del tostado de su café, gire lentamente el botón.

## 4.2 Fase 2 - Prensado (tamping) (fig. 17)

1. Después de la molienda, baje la palanca de prensado (A20) hasta final de carrera (no quite el portafiltro) (fig. 18). Para un resultado perfecto, repítalo 2 veces.
2. Mantenga bajada la palanca hasta el final de carrera durante la remoción del portafiltro (fig. 19). Para regresar la palanca a la posición inicial.
3. Una vez verificada que la dosis de cafés sea correcta (véase "La "dosis perfecta""), enganche el portafiltro al surtidor del café (A7) (fig. 20).

### La "dosis perfecta"

- Los filtros de café tienen un marcado interno para identificar el nivel para la dosis perfecta.



- Filtro con marcado con laser: la dosis perfecta corresponde a la línea superior del marcado.
- Filtro con marcado en relieve: la dosis perfecta corresponde a la línea en relieve.
- Asegúrese de que el café esté al nivel después del prensado. Podría ser necesario regular el botón más veces (B2) antes de llegar a la dosis perfecta.
- Si el café está sobre- o bajo-extraído y la dosis está dentro de la dosis perfecta, regule el grado de molienda más fino o más grueso (véase "4.1 Fase 1 - Molienda (grinding) (fig. 11)"). Si el café está sobre- extraído (suministro demasiado lento) la molienda deberá ser más gruesa. Si el café está bajo-extraído (suministro demasiado rápido) la molienda deberá ser más fina.
- **El barman aconseja:** Saque el portafiltro mientras la palanca del prensador (A20) está bajada para obtener un acabado perfecto de la dosis de café.

## 4.3 Fase 3 - Suministro (brewing) (fig. 21)

1. Seleccione la bebida deseada (fig. 22).
2. Pulse OK (B6) para iniciar el suministro (fig. 23) (pre-infusión e infusión). El suministro del café se interrumpe automáticamente.

## 5. PREPARACIÓN DE BEBIDAS A BASE DE LECHE

### 5.1 Espumar la leche (fig. 24)

1. Vierta en el recipiente de la leche (D8) la cantidad de leche que se desea calentar/espumar, teniendo en cuenta que el volumen de la leche aumentará 2 o 3 veces (fig. 25). Para obtener una espuma más densa y homogénea, se recomienda utilizar leche entera de vaca y a temperatura de la heladera (aproximadamente 5° C).

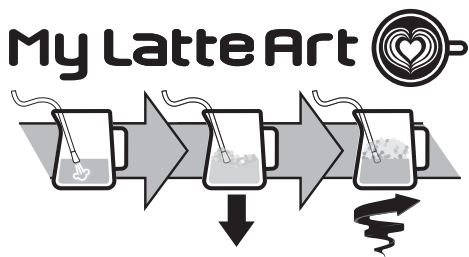

2. Para espumar la leche, apoye el tubo de salida del vapor (A5) en la superficie de la leche: haciendo esto el aire se mezcla con la leche y el vapor.
3. Mantenga el tubo de salida de vapor en la superficie, prestando atención a no capturar demasiado aire creando burbujas demasiado gruesas.
4. Sumerja el tubo de salida de vapor bajo la superficie de la leche: de este modo se crea un vórtice. Una vez alcanzada la temperatura deseada, vuelva a cerrar el botón de vapor y espere a que el suministro de vapor se interrumpa completamente antes de quitar la jarra de leche.

### El barman aconseja:

- **La leche fresca es mejor.** Use siempre leche fresca a temperatura de la heladera.
- La leche entera asegura resultados óptimos. El resultado y la textura de la espuma varían de acuerdo a la leche de vaca o de las bebidas vegetales utilizadas.
- Después de haber espumado la leche, elimine las burbujas agitando la jarra de la leche.

### Limpieza del surtidor de vapor:

1. Después de cada uso, remueva con un paño los residuos de leche del surtidor de vapor (fig. 26). Para una limpieza profunda, se recomienda utilizar Eco MultiClean: asegura la higiene removiendo proteínas y grasas de la leche y puede utilizarse para limpiar toda la máquina.
2. Suministre vapor por algunos segundos para limpiar bien el surtidor (fig. 10).
3. Espere hasta que el surtidor se enfríe: para mantener la eficiencia del surtidor en el tiempo, utilice la aguja de limpieza (C12) para mantener libres los 3 orificios (fig. 27).

### 5.2 Prepare las bebidas a base de leche con el LatteCrema System (fig. 28)

1. Vierta en el recipiente (D8) de la leche a temperatura de heladera (5° C) (fig. 29).
2. Cierre la tapa (D1) (fig. 30).
3. Gire el botón de regulación de espuma (D5) a la posición deseada (fig. 31).

Posición botón de regulación espuma				
				INSERT
Limpieza después de cada uso	Espuma MÁX	Espuma MED	Espuma MÍN	Para extraer o introducir el botón

- Enganche el recipiente de la leche en la máquina (fig. 32).
- Prepare la dosis perfecta (véase "4.1 Fase 1 - Molienda (grinding)" (fig. 11)" y "4.2 Fase 2 - Prensado (tamping)" (fig. 17)") e introduzca el portafiltro.
- Seleccione la bebida a base de leche deseada (fig. 33).

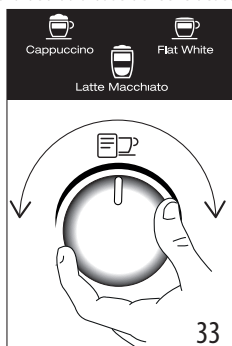

Bebida	Espresso	Leche	Espuma	Cantidad (ml)	X2 (ml)
Cappuccino	1	✓	✓	≈150	≈230
Latte Macchiato	1	✓	✗	≈150	≈230
Flat White	1	✓	✓	≈250	≈330

- Bebidas con doble dosis (2x):** Vierta en el recipiente (D8) la cantidad de leche necesaria para la preparación, prestando atención a no superar el nivel MÁX (fig. 25). Cada muesca en el recipiente corresponde a ≈100 ml de leche.
  - La leche fresca es mejor.** Use siempre leche fresca a temperatura de la heladera.
- Pulse OK (B6) para suministrar (fig. 23). El aparato suministra automáticamente café y leche en secuencia.

#### Limpieza del Lattecrema System después de cada uso:

- Deje el recipiente de la leche enganchado a la máquina (no es necesario vaciarlo). Meta un recipiente debajo del tubo de suministro de la leche (D4) (fig. 34).
- Gire el botón (D5) a "Clean" (fig. 35).

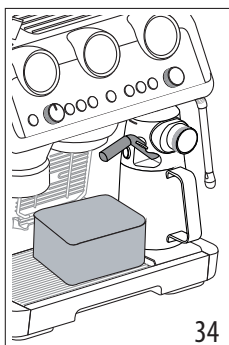

- La limpieza inicia y se interrumpe automáticamente. Atención: al final de la limpieza, gire el botón a una de las posiciones de regulación de la espuma.
- Quite el recipiente de la leche y colóquelo en la heladera: se recomienda utilizar en breve tiempo la leche restante. Para una limpieza profunda, se recomienda utilizar Eco Multi-Clean: asegura la higiene removiendo proteínas y grasas de la leche y puede utilizarse para limpiar toda la máquina.





#### 6. PERSONALICE LA LONGITUD DE LAS BEBIDAS DE CAFÉ CON EL BOTÓN (B9)

- Prepare la cafetera para hacer 1 o 2 tazas de la bebida café que desee, hasta enganchar el portafiltro (C1) con el filtro (C2) o (C3) el café molido. Si se desea programar una bebida a base de leche, conecte el Lattecrema System a la máquina.
  - Gire el botón (B10) para seleccionar la bebida a programar.
  - Pulse la tecla : el indicador correspondiente a la tecla OK (B6) se enciende fijo y el indicador correspondiente a la tecla parpadea.
  - Pulse la tecla OK para iniciar el suministro. Los indicadores correspondientes a las teclas OK y parpadean.
  - Una vez alcanzada la cantidad deseada, pulse OK. Si la bebida prevé el suministro de otro ingrediente, comienza el suministro de este último: una vez alcanzada la cantidad deseada, pulse OK.
  - Pulse la tecla para guardar. El aparato está listo para un nuevo uso y el indicador permanece encendido.
- Si no se desea guardar la programación, pulse cualquier otra tecla.



#### Nota bene:







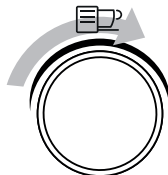

- Se pueden programar las bebidas con café, pero no el suministro de vapor y agua caliente.
- La programación modifica las cantidades de las bebidas, pero no del café molido.
- Las bebidas "X2" pueden programarse separadamente.
- My LatteArt** no es programable.

- **Para regresar a las configuraciones de fábrica, mantenga pulsada la tecla  hasta el apagado. La bebida seleccionada regresa a la cantidad de fábrica.**

Receta de café	Cantidad de fábrica	Cantidad programable
 Espresso	35 ml	de 25 a 90 ml
 Espresso X2	70 ml	de 50 a 180 ml
 Coffee	80 ml	de 50 a 120 ml
 Coffee X2	160 ml	de 120 a 240 ml
 Americano	120 ml	<ul style="list-style-type: none"> <li>• espresso: de 25 a 60 ml</li> <li>• agua: de 25a 120 ml</li> </ul>
 Americano X2	240 ml	<ul style="list-style-type: none"> <li>• espresso: de 50 a 120 ml</li> <li>• agua: de 50 a 240 ml</li> </ul>

## 7. MENÚ CONFIGURACIONES

1. Entre en el menú:		
Pulse contemporáneamente por 5 segundos	x2	
2. Seleccione la configuración a programar:		
		
Bebida	Configuración correspondiente	Regulaciones
 Espresso	Ahorro energético	 ➔  <b>Activo</b>
		 ➔  <b>Apagado</b>
 Coffee	Autoapagado	 ➔ <b>9 minutos</b>
		 ➔ <b>1,5 horas</b>
		 ➔ <b>3 horas</b>
 Cappuccino	Señal acústica	 ➔  <b>Activo</b>
		 ➔  <b>Apagado</b>
➔		

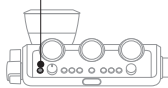
 Latte	Regulación extra el grado de molienda	 ➔ <b>Rango 1</b>  ➔ <b>Rango 2</b>
 Flat White	Valor fábrica	Mantenga pulsada por al menos 5 segundo la tecla OK, hasta que el indicador permanece encendido fijo
 Americano	Dureza del agua	 ➔ <b>blanda</b>
		 ➔ <b>media</b>
		 ➔ <b>dura/muy dura</b>
3. Guarde las nuevas configuraciones pulsando ON/Standby (B1)		
 		







## 8. LIMPIEZA DEL APARATO

### ¡Atención!

- Para limpiar la cafetera no use disolventes ni detergentes abrasivos, ni alcohol.
- No utilice objetos metálicos para eliminar las incrustaciones o los depósitos de café porque podrían rayar las superficies metálicas o plásticas.
- Para periodos de inutilización superiores a una semana se recomienda, antes de utilizar la máquina, proceder a un enjuague.

### ¡Peligro!

- No sumerja la máquina en el agua durante la limpieza: es un aparato eléctrico.
- Antes de cualquier operación de limpieza de las partes externas del aparato apague la cafetera quitando la clavija de la toma de corriente y deje enfriar la máquina.

					
	✗	✓	✓	✗	✗
➔					

	✓	✗	✗	✓	✓
	✗	✗	✗	✓	✓
	✗	✗	✗	✓	✓
	✗	✗	✓	✓	✗
	✗	✗	✗	✓	✓
	✓	✓	✗	✓	✓

### 8.1 Limpieza del surtidor de café

Cuando el indicador se enciende (naranja) (B5), es necesario proceder a la limpieza del circuito café. Para realizar el ciclo de limpieza, compre las pastillas para la limpieza de máquinas de café. Para más información, visite [www.Delonghi.com](http://www.Delonghi.com).

1. Introduzca el filtro 1 taza (C2) en el portafiltro (C1) (fig. 36).
2. Introduzca en filtro el accesorio de limpieza (C9) (fig. 36) y presiónelo hasta el fondo.

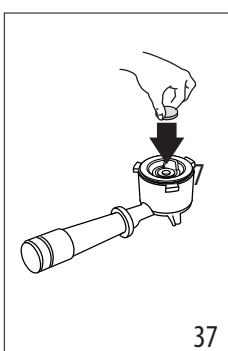
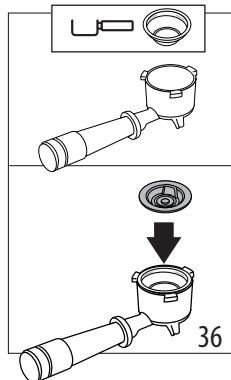

3. Meta la pastilla para la limpieza en el accesorio (fig. 37).
4. Conecte el portafiltro al surtidor de café (A7).
5. Llene el depósito del agua (A15). Asegúrese de que la bandeja recogegotas (A11) esté vacía.

6. Mantenga pulsada la tecla , hasta que el relativo indicador comienza a parpadear (naranja) . Después de algunos minutos, la limpieza se interrumpe automáticamente.

- Quite el portafiltro y el accesorio de limpieza.
- Lave el portafiltro y el filtro bajo agua corriente.
- Vuelva a colocar el y proceda con un enjuague pulsando la tecla (B5): se recomienda colocar un recipiente debajo del portafiltro.
- Quite y vacíe la bandeja recogegotas.

#### Nota Bene:

Este ciclo de limpieza puede ponerse en marcha en cualquier momento pulsando la tecla (B5) por unos segundos. Para cancelar la operación, pulse el botón por 10 segundos.

### 8.2 Limpie al alojamiento del recipiente del café en granos

1. Asegúrese de que el recipiente del café en granos (A1) esté vacío. Eventualmente proceda con algunas moliendas al vacío para vaciarlo.
2. Desenganche el recipiente girándolo en sentido antihorario y sáquelo de la máquina (fig. 38)

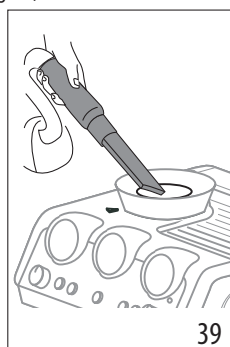
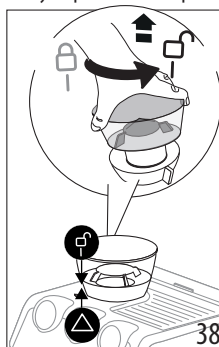

3. Aspire los residuos de café (fig. 39).
4. Limpie con un paño húmedo el lugar del recipiente del café en granos y séquelo (fig. 40);

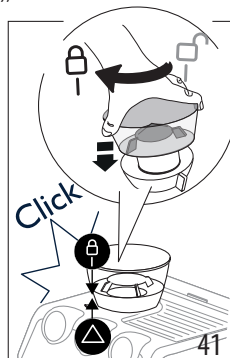
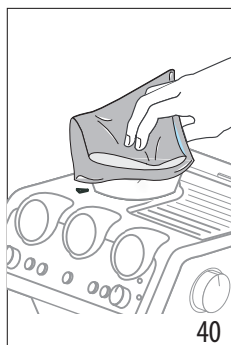

- Vuelva a colocar el recipiente introduciéndolo en el molinillo. El recipiente está bien colocado cuando la flecha ▲ está alineada con el símbolo ☞ y se escucha un "clik" (fig. 41).

### 8.3 Limpieza de las muelas

Cuando se limpia el recipiente del café en granos (A1), limpie el soporte del recipiente y la muela superior con un paño húmedo. Diríjase a un centro de asistencia para quitar y cambiar las muelas. Es posible quitar la muela en el caso de que el molinillo estuviera bloqueado por un cuerpo extraño. Si esto sucede quite el recipiente del café en granos y proceda de la siguiente manera:

- Enganche la copa portafiltro (C1) y haga una molienda "al vacío" para liberar el conducto del café.
- Apague el aparato.
- Gire en sentido antihorario el regulador de molienda hasta el final de carrera, a la posición "REMOVE" (fig. 42).

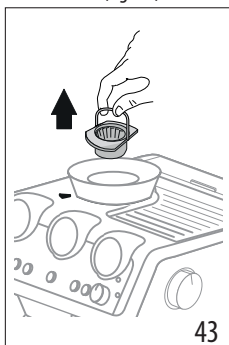
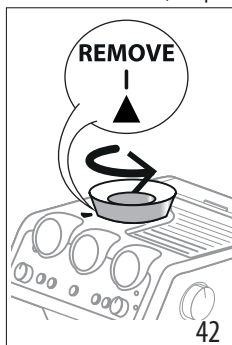

- Extraiga la parte superior de la muela, agarrándola por la respectiva asa (fig.43).
- Limpie la muela con una brocha (fig. 44) y aspire los residuos de café con un aspirador (fig. 39).

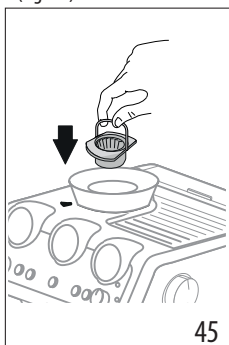
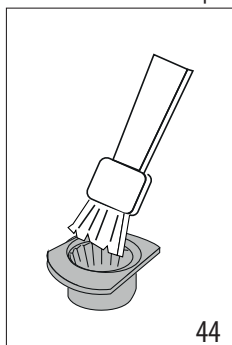

- Meta la muela en su soporte (fig. 45);
- Gire el regulador seleccionando el grado de molienda deseado (fig. 13);

Verifique si la máquina está bien metida tirando de ella por el asa: si no se mueve, significa que la muela está bien metida;

### 8.4 Sustitución de las muelas

Cuando la cantidad de café molido se reduce aun mas, diríjase a un centro de asistencia para cambiar las muelas: después regule de nuevo el molinillo entrando en el menú configuraciones ("7. Menú configuraciones") y seleccionando el primer rango de la regulación extra del grado de molienda. Luego, gire el botón regulación cantidad (B2) a posición MÍN y regule la dosis como en el primer uso (véase "La "dosis perfecta"").

### 8.5 Limpieza de la "Smart tamping station"

- Limpie la zona de enganche con un pincel (fig. 46).
- Tire la palanca (A20) hasta final de carrera y limpie con un pincel el prensador (fig.47), luego suelte la palanca.
- Limpie la rampa de café (fig. 48) (C8) con el cepillo.

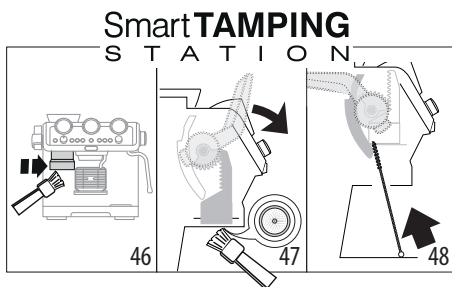

### 8.6 Limpieza del LatteCrema System

Lave en el lavavajillas todos los componentes y el recipiente, colocándolos en la cesta superior del lavavajillas. Si no dispone de lavavajillas, realice el lavado manual tal y como se indica en la nota al final de apartado.

- Pulse el botón (D3) y levante la tapa del recipiente de la leche (D1);
- Saque el surtidor de leche (D4) y el tubo de aspiración ((D7) (fig. 49);

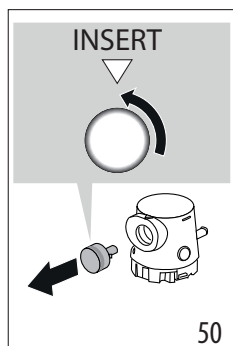
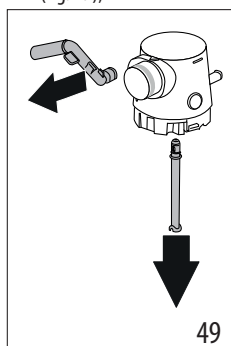

- Gire a posición "Insert" el botón y sáquelo (fig. 50);



4. Preste particular atención que en la ranura y en el canal debajo del botón (fig. 51) no queden residuos de leche: eventualmente raspar el canal con un palillo de dientes;

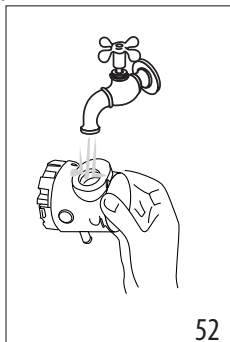
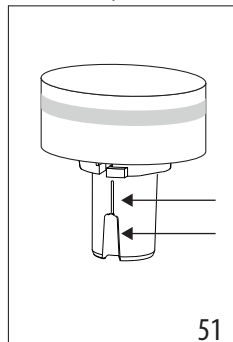

5. Enjuague el interior del alojamiento del regulador espuma con agua corriente (fig. 52);  
 6. Compruebe también que el tubo de aspiración y el tubo de salida no estén obstruidos con restos de leche;  
 7. Vuelva a montar todos los componentes de la tapadera;  
 8. Lave y seque cuidadosamente el recipiente de la leche (D8);  
 9. Vuelva a enganchar la tapa del recipiente de la leche.

**Nota Bene: lavado manual**

El lavado en lavavajillas garantiza la higiene perfecta de todos los componentes del recipiente de leche: en el caso de lavado manual, lave meticulosamente todos los componentes del recipiente de leche con agua caliente y dejelos en remojo dentro de un cuenco con agua caliente durante 30 minutos, antes de proceder según indicado en el punto 4.

**9. DUREZA AGUA**

El indicador [B8] (B8) descalcificación se enciende después de un periodo de funcionamiento predeterminado que depende de la dureza del agua. Si lo desea, es posible programar la máquina en función de la dureza real del agua de las diferentes regiones, de esta forma la operación de descalcificación será menos frecuente.

1. Saque de su envase la tira suministrada «TOTAL HARDNESS TEST» (C4).  
 2. Sumerja por completo la tira en un vaso de agua durante un segundo más o menos.  
 3. Saque la tira del agua y sacúdala ligeramente. Configure el aparato, como se indica en el capítulo "7. Menú configuraciones".

Resultado Prueba Dureza del Agua	Botón	Nivel
	x2	1 agua dulce

Resultado Prueba Dureza del Agua	Botón	Nivel
		2 agua media
	OK	3 agua dura o muy dura

4. Configure el aparato, como se indica en el capítulo "7. Menú configuraciones".

**10. CÓMO UTILIZAR SOFTBALLS**

Softballs (C11) es un sistema innovador que prolonga la vida de la máquina, sin alterar las cualidades del agua, garantizando el suministro de un café cremoso y aromático. Para optimizar la eficacia, deje Softballs en el agua toda la noche antes del uso.

1. Saque el paquete de Softballs del empaque (fig. 53).

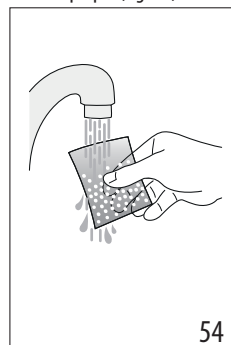
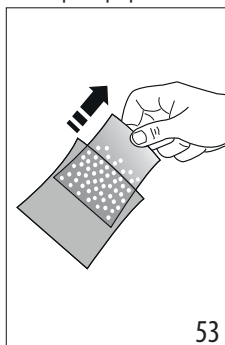

2. Enjuague con agua corriente el paquete de Softballs (fig. 54).  
 3. Sumerja la bolsa en el depósito de agua (A15) (fig. 55).

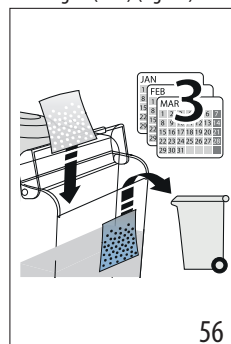
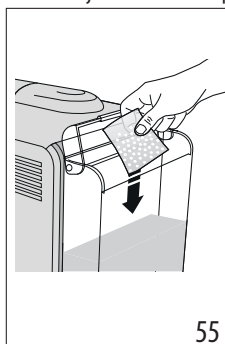

4. Sustituya la bolsa de Softballs cada 3 meses (fig. 56).

## 11. DESCALCIFICACIÓN

### ¡Atención!

- Antes del uso, lea las instrucciones y las etiquetas del descalcificador (C5), que figuran en su embalaje.
- Se recomienda usar solo descalcificador De'Longhi. El uso de descalcificadores no idóneos, como también la descalcificación no realizada regularmente, puede comportar la aparición de defectos no cubiertos por la garantía.
- El descalcificador puede dañar superficies delicadas. Si el producto se derrama accidentalmente, secar inmediatamente.

Para efectuar la descalcificación	
Descalcificador	Descalcificador De'Longhi
Recipientes	2 de 1 litro cada uno
Tiempo	~40min

1. (SI LO HAY, quite el filtro ABLANDADOR Y LAS SOFT-BALLS). Vierta en el depósito de agua (A15) el descalcificador hasta el nivel  **A** (correspondiente a un embalaje de 100ml) impreso del lado interno del depósito (fig. 57).

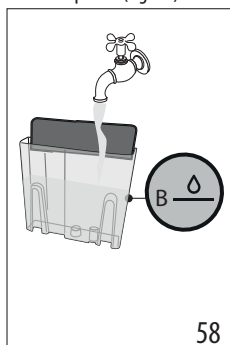
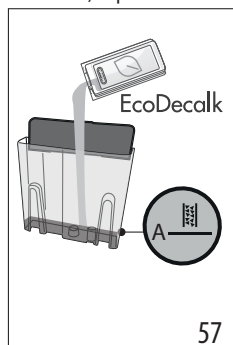

2. Agregue agua hasta alcanzar el nivel  **B** (fig. 58). Vuelva a meter el depósito de agua en la máquina.
3. Introduzca el accesorio (C6) al conector para el LatteCrema System (A6) (fig. 59).

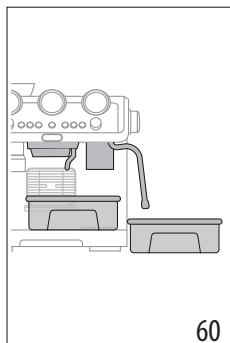
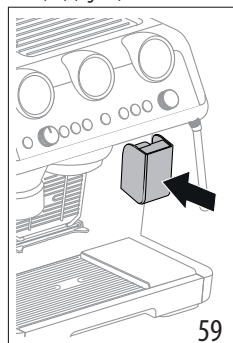

4. Asegúrese de que el portafiltro (C1) no esté enganchado y coloque un recipiente debajo de los surtidores de café y agua caliente (A7), y debajo del surtidor de café (A5) (fig. 60).
5. Mantenga pulsado el botón  (B8) hasta que el indicador correspondiente comience a parpadear.
6. El programa de descalcificación comienza y el líquido descalcificador sale de los surtidores. El programa de descalcificación realiza automáticamente una serie de enjuagues a intervalos para eliminar los residuos de cal del interior de la cafetera hasta vaciar por completo el depósito.

El suministro se interrumpe y el indicador  se pone blanco. Luego es necesario proceder con el ciclo de enjuagado:

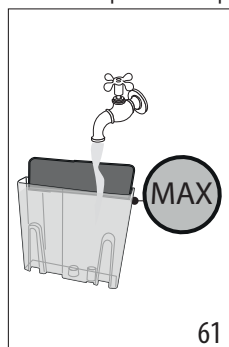

7. Vacíe el recipiente utilizado para recoger el líquido descalcificador y póngalo bajo los surtidores.
8. Saque el depósito del agua, vacíelo de los eventuales residuos de solución descalcificadora, enjuáguelo con agua corriente y llénelo con agua fresca hasta el nivel MÁX (fig. 61). Vuelva a meter el depósito en su soporte.













9. Mantenga pulsado el botón  hasta que el indicador comienza a parpadear: el enjuague se pone en marcha.
10. Una vez completado el enjuague, el suministro se interrumpe y el aparato está listo para el uso.
11. Vacíe los recipientes de recogida del agua del enjuague.
12. Saque y vacíe la bandeja recogegotas y vuelva a meterla después.
13. Saque y llene el depósito con agua fresca, vuelva a meterlo después.











El aparato está listo para el uso.

### Nota bene:



- Si se desea anticipar el ciclo de descalcificación, mantenga pulsado el botón  por 3 segundos.
- En el caso de que la descalcificación haya sido iniciada por error, pulse la tecla  por 10 segundos; el enjuague no puede interrumpirse.

## 12. SIGNIFICADO DE LOS INDICADORES

INDICADORES	SIGNIFICADO DE LOS INDICADORES	OPERACIÓN
Todos los indicadores luminosos parpadean brevemente	Encendido del aparato	Autodiagnóstico
 fija	Es el primer encendido de la máquina y es necesario llenar el circuito de agua	Proceda como se indica en el cap. "3. Primera puesta en funcionamiento del aparato"
 fija	La función ahorro energético está activa	Consulte el cap. "7. Menú configuraciones" si se desea desactivar la función
 fija	El recipiente del café en granos (A1) está vacío	Llene el recipiente del café en granos
 intermitente	Si se desea proceder con la molienda, pero el recipiente del café en granos (A1) está vacío	Llene el recipiente del café en granos
 on	El agua del depósito (A15) es insuficiente o el depósito del agua no está bien metido	Llene el depósito o sáquelo y vuelva a meterlo correctamente
 intermitente	Se desea proceder con la preparación de una bebida, pero el depósito de agua (A15) está vacío	Llene el depósito del agua
 fija	Alarma general	Diríjase a un centro de asistencia
 fija	El recipiente del café en granos no está metido	Meta correctamente el recipiente del café en granos (A1) o verifique que esté metido correctamente
 intermitente	El selector, en la base del recipiente del café en granos (A1), no está en la posición correcta	Regrese el selector a una de las posiciones de molienda (entre 1 y 8), recordando: <ul style="list-style-type: none"> <li>Regular la molienda mientras el molinillo está en funcionamiento</li> <li>Regular un nivel a la vez haga al menos 5 moliendas entre una regulación y la otra</li> </ul>
	El recipiente del café en granos (A1) no está completamente metido: intervenga el dispositivo de seguridad	Verifique que el recipiente del café en granos esté metido correctamente
 fija	El LatteCrema System debe limpiarse después de cada uso	Después de haber finalizado las preparaciones a base de leche, proceda con la limpieza automática girando el botón (D5) a Clean
 fija	El aparato no está listo para el suministro de vapor.	El aparato ha alcanzado la temperatura para suministrar vapor. Para proceder con el suministro gire el botón vapor (A4)
→		

INDICADORES	SIGNIFICADO DE LOS INDICADORES	OPERACIÓN
 intermitente	El aparato está encendido y la función ahorro energético está activa: el botón (A4) está en posición para suministrar vapor	El indicador luminoso parpadea para indicar que el aparato se está preparando para suministrar vapor: la salida empieza en cuanto el aparato alcanza la correspondiente temperatura
	El aparato está listo para el suministro de vapor	El aparato está en temperatura para la preparación de vapor cuando el indicador permanece fijo
	El aparato está suministrando vapor	
 fijo (naranja)	Es necesario efectuar la descalcificación	Efectúe la descalcificación como se explica en el cap. "11. Descalcificación"
 intermitente (naranja)	El aparato está efectuando la descalcificación	Termine la operación como se describe en el cap. "11. Descalcificación"
 fijo (blanco)	Es necesario proceder con el enjuague	
 intermitente (blanco)	El aparato está efectuando el enjuague	
 fijo (naranja)	Es necesario proceder con la limpieza del surtidor de café	Véase apdo. "8.1 Limpieza del surtidor de café"
 intermitente (naranja)	El aparato está efectuando la limpieza del surtidor de café	
 intermitente (blanco)	El aparato está efectuando la enjuague	
 intermitente	Si está presente el filtro ablandador, podría haber entrado una burbuja de aire en el circuito, impidiendo el suministro	Pulse el botón (B7) correspondiente al indicador  : la salida comienza y se interrumpe automáticamente.
	La molienda es demasiado fina. Por lo tanto, el café sale muy lentamente o no sale del todo.	Saque la copa portafiltro (C1), repita las operaciones para hacer el café teniendo presente las indicaciones del apdo. "4.1 Fase 1 - Molienda (grinding) (fig. 11)" y "4.2 Fase 2 - Prensado (tamping) (fig. 17)"
	El filtro de café (C2) o (C3) está obstruido	Enjuague los filtros bajo el agua corriente o realice un enjuague con el botón enjuague (B5).
	El depósito (A15) está mal colocado y las relativas válvulas no están abiertas	Presione ligeramente el depósito para abrir las válvulas
	Cal en el interior del circuito hidráulico	Efectúe la descalcificación como se explica en el cap. "11. Descalcificación"

### 13. SI ALGO NO FUNCIONA

PROBLEMA	CAUSA	SOLUCIÓN
Hay agua en la bandeja recogegotas (A11)	Forma parte del funcionamiento normal de los circuitos internos de la máquina	Vacíe y limpie regularmente la bandeja recogegotas (A11)
El café espresso no sale	Falta de agua en el depósito (A15)	Llene el depósito
	El indicador  (B7) está encendido para indicar que el circuito de café o de vapor está vacío.	Pulse el botón correspondiente al indicador  para llenar el circuito.
	El filtro (C2) o (C3) está obstruido	Enjuague el filtro bajo el agua corriente o realice un enjuague con el relativo botón (B5)
	El depósito (A15) está mal colocado y las válvulas del fondo no están abiertas	Presione ligeramente el depósito para abrir las válvulas del fondo
	Cal en el interior del circuito hidráulico	Efectúe la descalcificación como se explica en el cap. "11. Descalcificación"
	Molienda demasiado fina	Saque la copa portafiltro (C1), repita las operaciones para hacer el café teniendo presente las indicaciones del apdo. "4.1 Fase 1 - Molienda (grinding) (fig. 11)" y "4.2 Fase 2 - Prensado (tamping) (fig. 17)"
El portafiltro no se engancha en el aparato	El café molido no ha sido prensado o hay excesiva cantidad	Repita la molienda con diferentes configuraciones. Reduzca la cantidad de la dosis: verifique que el filtro (C2) o (C3) (1 o 2 tazas) sea correcto respecto a la dosis a moler (botón 2x (B3) seleccionado o no)
El café espresso gotea por los bordes del portafiltro (C1) en lugar de por los orificios	El portafiltro está mal colocado	Enganche el portafiltro correctamente y gírelo hasta el tope con firmeza
	La junta del surtidor de café (A7) ha perdido elasticidad o está sucia	Sustituya la junta del surtidor de café en un Centro de Asistencia
	El filtro (C2) o (C3) está obstruido	Enjuague los filtros bajo el agua corriente o realice un enjuague con el botón correspondiente (B5)
La crema del café es clara (cae rápidamente por la boquilla)	Es necesario ver de nuevo las configuraciones del aparato	Saque la copa, repita las operaciones para hacer el café teniendo presentes las indicaciones del apdo. "4.1 Fase 1 - Molienda (grinding) (fig. 11)" y "4.2 Fase 2 - Prensado (tamping) (fig. 17)"
		→

<b>PROBLEMA</b>	<b>CAUSA</b>	<b>SOLUCIÓN</b>
La crema del café es oscura (el café sale lentamente por la boquilla)	Es necesario ver de nuevo las configuraciones del aparato	Saque la copa portafiltro (C1), repita las operaciones para hacer el café teniendo presente las indicaciones del apdo. "4.1 Fase 1 - Molienda (grinding) (fig. 11)" y "4.2 Fase 2 - Prensado (tamping) (fig. 17)"
No se forma la espuma de la leche cuando se prepara el cappuccino con el LatteCrema System	La leche no está bastante fría	Use siempre leche a temperatura de la heladera
	El botón (D5) no está en posición correcta	Verifique y gire el botón a la posición correcta ( ☺ máx espuma; ☻ med espuma; ☹ mín espuma )
	El LatteCrema System está sucio	Límpielo como se ilustra en el apdo "8.6 Limpieza del LatteCrema System"
	Cal en el interior del circuito hidráulico	Efectúe la descalcificación como se explica en el cap. "11. Descalcificación"
Al finalizar la descalcificación el aparato requiere un nuevo enjuague	Durante el enjuague el depósito no se ha llenado hasta el nivel MÁX	Repita el enjuague (véase apdo. "11. Descalcificación")
El aparato no muele el café	Dentro de la molienda hay un cuerpo extraño	Limpie las muelas como se indica en el apdo. "8.3 Limpieza de las muelas", asegurándose de haber quitado todos los granos del recipiente del café en granos (A2) antes de sacarlo. Antes de volver a colocar la muela, aspire cuidadosamente todo residuo de su lugar
	El recipiente del café en granos (A1) no está en la posición correcta	El recipiente está bien colocado cuando la flecha ▲ está alineada con el símbolo ☒ y se escucha un "clac"
→		

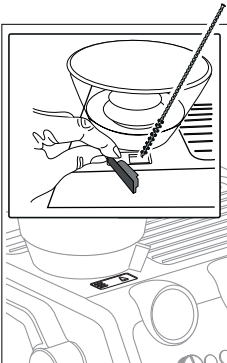
PROBLEMA	CAUSA	SOLUCIÓN
Si desea cambiar la calidad del café	Es necesario eliminar todos los granos presentes en la máquina	<ul style="list-style-type: none"> <li>• Vacíe el recipiente de café en granos (A1) (moliendo en vacío o, en su caso, aspirando los granos residuales).</li> <li>• Enganche la copa portafiltro (C1) y haga moliendas “en vacío” para liberar el conducto del café; a continuación enganche el portafiltro a la salida del molinillo (A18) alineándolo el mensaje INSERT gire la copa hacia la derecha (fig. 22). La molienda inicia cuando la copa alcanza la posición CLOSE y se interrumpe automáticamente. Repita hasta que el filtro se quede vacío</li> <li>• Coloque en el recipiente (A1) el nuevo tipo de granos de café</li> <li>• Si con la molienda no se alcanza la “dosis perfecta”, proceda como en el primer uso</li> </ul>
<p>Después de la molienda, el filtro de café (C2) o (C3) está vacío</p> <p>Una vez terminada la molienda, el polvo de café en el filtro es excesivo</p>	La rampa del café del molinillo está obstruido	<p>Límpiala como se indica en el apdo. “8.5 Limpieza de la “Smart tamping station””.</p> <p>Si el problema persiste, acceda a la rampa abriendo la respectiva puerta (A19) y libérela utilizando la escobilla</p> 
→		

<b>PROBLEMA</b>	<b>CAUSA</b>	<b>SOLUCIÓN</b>
Después de la molienda, el polvo de café en el filtro (C2) o (C3) no alcanza la "dosis perfecta"	La "Smart Tamping Station" precisa de limpieza	Límpiala como se indica en el apdo. "8.5 Limpieza de la "Smart tamping station", luego repita la molienda
	Es necesario regular la cantidad de café molido	Regule la cantidad con el botón correspondiente (B2) siguiendo las indicaciones en el apdo. "La "dosis perfecta"". Si el botón está ya en posición máx, proceda como se indica en la sección "Regulación extra el grado de molienda"
	Con el tiempo las muelas se desgastan	Proceda a la sustitución de las muelas tal y como indicado en el apdo. "8.4 Sustitución de las muelas"



Antes de utilizar o aparelho leia sempre o folheto dos avisos de segurança.

## 1. DESCRIÇÃO

### 1.1 Descrição do aparelho - A

- A1. Depósito de café em grão
- A2. Tampa depósito de café em grãos
- A3. Superfície de apoio das chávenas
- A4. Botão do vapor
- A5. Tubo dispensador do vapor
- A6. Conector para o Lattecrema System
- A7. Dispensador de café
- A8. Grelha de apoio das chávenas para expresso
- A9. Grelha de apoio das chávenas para copos ou malgas
- A10. Grelha do tabuleiro
- A11. Tabuleiro de recolha dos pingos
- A12. Indicador de nível da água no recipiente de recolha de pingos
- A13. Tampa do reservatório de água
- A14. Asa extração depósito da água
- A15. Reservatório de água
- A16. Alojamento do conector do cabo de alimentação
- A17. Interruptor geral (ON/OFF)
- A18. Saída do moedor de café (Tamping station)
- A19. Portinhola para aceder à tremonha do moinho de café
- A20. Alavanca de pressão

### 1.2 Descrição do painel de comando - B

- B1. Tecla ON/Standby
- B2. Manípulo de regulação quantidade café moído
- B3. Tecla "X2": para a utilizar o filtro 2 de café
- B4. Botão "temperatura do café"
- B5. Tecla de "enxaguamento"
- B6. Tecla "OK": para dispensar a bebida/para confirmar
- B7. Tecla de "dispensação água quente"
- B8. Botão "descalcificação"
- B9. Tecla "My": para personalizar o comprimento das bebidas
- B10. Botão de seleção de funções
- B11. Ecrã bebidas

#### Bebidas à base de café Expresso

- Espresso
- Americano
- Coffee

#### Bebidas à base de leite

- Cappuccino
- Flat White
- Latte Macchiato

- B12. Indicador luminoso "limpeza leite"
- B13. Indicador "ausência depósito de café em grão"
- B14. Indicador luminoso "alarme genérico"

- B15. Manómetro
- B16. Indicador luminoso "falta água"
- B17. Indicador luminoso "depósito de café em grãos vazio"
- B18. Indicador luminoso "poupança energética"
- B19. Ecrã de configurações e processo:
  - Indica a operação que o aparelho está a realizar
  - Indica a configuração da dose de café selecionada
  - Indica a configuração da temperatura do café selecionada

### 1.3 Descrição dos acessórios - C

- C1. Compartimento porta-filtro
- C2. Filtro 1 chávena
- C3. Filtro 2 chávenas
- C4. Tira-teste "Total Hardness Test"
- C5. Descalcificante
- C6. Acessório para descalcificação
- C7. Cabo de alimentação removível
- C8. Escovinha
- C9. Acessório limpeza dispensador de café
- C10. Pano
- C11. Softballs (amaciador da água)
- C12. Agulha de limpeza para lança vapor

### 1.4 Acessórios limpeza não incluídos, recomendados pelo fabricante

Para mais informações, consulte a [Delonghi.com](http://Delonghi.com).



#### Pastilhas limpeza

(Ver "8.1 Limpeza do dispensador de café")

 **Limpador**  
EAN: 8004399333307

### 1.5 Descrição do LatteCrema System - D

- D1. Tampa do recipiente de leite
- D2. Conector recipiente do leite
- D3. Botão de desengate da tampa
- D4. Bico de leite (regulável em altura)
- D5. Manípulo de regulação de espuma
- D6. Sede do manípulo
- D7. Tubo de sucção de leite
- D8. Recipiente de leite

## 2. PREPARAÇÃO DO APARELHO

Lavar com água morna e detergente da louça todos os acessórios e, em seguida, proceder conforme se segue:

1. Inserir o recipiente de recolha de pingos (A11) completo com grelha de apoio das chávenas (A9) e grelha do tabuleiro (A10) (fig. 1);
2. Extrair o reservatório de água (A15) (fig. 2) e enchê-lo com água fresca e limpa, tendo o cuidado para não ultrapassar a inscrição MAX (fig. 3).
3. Em seguida, reinserir o depósito.

**Atenção:** *Jamais ligar a máquina sem água no reservatório ou sem este último.*

**Nota:** *Aconselha-se a personalizar o quanto antes o grau de dureza da água seguindo o procedimento descrito no capítulo "7. Menu de configurações".*

### 3. PRIMEIRA COLOCAÇÃO EM FUNCIONAMENTO DO APARELHO

1. Inserir o conector do cabo de alimentação (C7) no alojamento específico (A16) na traseira do aparelho (fig. 4); em seguida, introduzir a ficha do aparelho na tomada elétrica. Certificar-se de que o interruptor geral (A17), situado na parte traseira do aparelho, está premido na posição I (fig. 5);
2. Coloque sob o dispensador de água quente (em correspondência ao dispensador de café (A7)) um recipiente com capacidade mínima de 100 ml (fig. 6);
3. Premir a tecla (B7) correspondente ao indicador luminoso (fig. 7): a dispensação inicia e interrompe-se automaticamente. Esvaziar o depósito.

Antes de começar a utilizar a máquina, é necessário enxaguar os circuitos internos da mesma. Proceda da seguinte maneira:

4. Encaixar o compartimento porta-filtro (C1) completo com filtro na máquina: para um encaixe correto, alinhar a pega do compartimento porta-filtro com "INSERT" (fig. 8) e rodar o manípulo para a direita, até o alinhar com a posição "CLOSE";
5. Coloque um recipiente sob o copo porta-filtro e o tubo de fornecimento do vapor (A5);
6. Premir a tecla (B5) correspondente ao indicador luminoso (fig. 9): a dispensação é iniciada;
7. Uma vez terminada a dispensação, rode o manípulo do vapor (A4) (fig. 10) e dispense vapor durante alguns segundos, de forma a enxaguar o circuito de vapor: para uma dispensação ótima do vapor, aconselha-se a repetir esta operação 3 ou 4 vezes. Isto permite eliminar a água no tubo antes de dispensar o vapor.

O aparelho fica assim pronto para o uso.

**Nota:** *o enxaguamento dos circuitos internos é recomendado também em caso de inutilização prolongada do aparelho.*

Na primeira utilização, é necessário fazer 4-5 cafés antes de a máquina começar a dar um resultado satisfatório: dedique particular atenção à dose de café moído no filtro ((C2) ou (C3)) (ver instruções na secção "4.1 Fase 1 - Moagem (grinding) (fig. 11)". Proceder conforme o indicado no capítulo "A "dose perfeita"".

## 4. PREPARAR O CAFÉ

### 4.1 Fase 1 - Moagem (grinding) (fig. 11)

1. Verta os grãos para o depósito (A1) (fig. 12). É aconselhável verter apenas os grãos necessários para a preparação: desta forma, será sempre usado café fresco;
2. Selecione o grau de moagem (fig. 13). As configurações de fábrica é 5 (moagem média). Se o resultado não for satisfatório, regule o nível com base no sabor pessoal e no tipo de café (a regulação deve ser efetuada durante o funcionamento do moinho de café).
3. Insira um dos filtros de café (C2) ou (C3) no porta-filtro (C1) (fig. 14). Caso seja usado o filtro para 3 chávenas, prima o botão 2X (B3): com esta seleção, duplica também a quantidade de expresso dispensada.
4. Regule o manípulo da quantidade (B2) partindo da posição mínima (fig. 15).

**Observação:**



Os números apresentados no ecrã (B19) são uma referência a anotar uma vez atingido o nível correto no porta-filtro.

Não correspondem às configurações de moagem, ao peso do café moído (gr/oz) ou ao tempo de moagem.

Para mais indicações, consulte a secção "B3. Tecla "X2": para a utilizar o filtro 2 de café".

5. Engatar o porta-filtro à saída do moedor de café (A18) alinhando-o com a inscrição INSERT: em seguida, rodar para a direita o compartimento (fig. 16). A moagem tem início quando o compartimento atinge a posição CLOSE e é automaticamente interrompida.

### Regular a quantidade de café moído no filtro

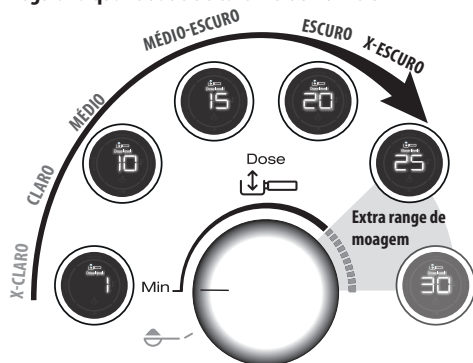

Cada variedade de grão dá um resultado diferente durante a moagem e para tal, no início da regulação da dose, é necessário um extremo cuidado.

Esta ilustração dá indicações sobre como regular a dose, com base na cor de tostagem: devem ser consideradas como um ponto de partida, mas podem variar em função da composição do café em grão.

1. Configure a dose a partir da posição mínima.
2. Verificando a cor de tostagem do seu café, rode lentamente o manípulo.

#### 4.2 Fase 2 - Prensagem (tamping) (fig. 17)

1. Após a moagem, abaixe a alavanca de prensagem (A20) até ao fim de curso (não remova o porta-filtro) (fig. 18). Para um resultado perfeito, repita 2 vezes.
2. Mantenha a alavanca abaixada até ao fim de curso durante a remoção do porta-filtro (fig. 19). Em seguida, recoloque a alavanca na posição inicial.
3. Depois de se certificar de que a dose do café está correta (ver "A dose perfeita"), engate o porta-filtro no dispensador de café (A7) (fig. 20).

#### A "dose perfeita"

- Os filtros de café possuem uma referência interna para identificar a dose perfeita.

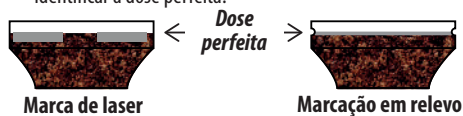

- Filtros com marcação de laser: a dose perfeita corresponde à linha superior da marcação;
- Filtro com marcação em relevo: a dose perfeita corresponde à linha em relevo;
- Certifique-se de que o café esteja no nível após a prensagem. Poderá ser necessário regular mais vezes o manípulo (B2) antes de se chegar à dose perfeita.
- Se o café for sobre ou subextraído e a dose estiver dentro da dose perfeita, regule o grau de moagem para mais fino ou mais grosso (ver "4.1 Fase 1 - Moagem (grinding) (fig. 11)"). Se o café estiver sobreextraído (dispensação demasiado lenta), a moagem deverá ser mais grossa. Se o café estiver subextraído (dispensação demasiado rápida), a moagem deverá ser mais fina.
- **O barista aconselha:** Extraia o porta-filtro enquanto a alavanca da prensa (A20) é abaixada para obter um acabamento perfeito da dose de café.

#### 4.3 Fase 3 - Preparação (brewing) (fig. 21)

1. Selecione a bebida desejada (fig. 22).
2. Prima OK (B6) para iniciar a preparação (fig. 23) (pré-infusão e infusão). A preparação do café interrompe-se automaticamente.

## 5. PREPARAÇÃO DE BEBIDAS À BASE DE LEITE

### 5.1 Espume o leite (fig. 24)

1. Verta para o recipiente do leite (D8) a quantidade de leite que se pretende aquecer/espumar, tendo em conta que o volume do leite aumentará 2 ou 3 vezes (fig.25). Para obter uma espuma mais densa e homogênea, é aconselhável utilizar leite de vaca gordo à temperatura de frigorífico (cerca de 5° C).

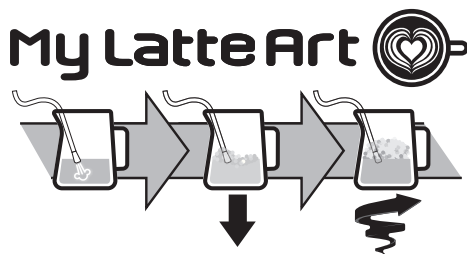

2. Para espumar o leite, apoie o tubo dispensador do vapor (A5) na superfície do leite: ao proceder assim, o ar mistura o leite com o vapor.
3. Mantenha o dispensador do vapor na superfície, prestando atenção para não captar demasiado ar, criando bolhas demasiado grossas.
4. Submerja o dispensador de vapor sob a superfície do leite: desta forma, cria-se um vórtice. Uma vez atingida a temperatura desejada, volte a fechar o manípulo do vapor e aguarde que a dispensação de vapor se interrompa completamente, antes de remover o jarro de leite.

#### O barista aconselha:

- **O leite fresco é melhor.** Utilizar sempre leite fresco à temperatura do frigorífico.
- O leite gordo assegura resultados ótimos. O resultado e as texturas da espuma variam consoante seja leite de vaca ou bebidas vegetais.
- Depois de ter espumado o leite, elimine as bolhas agitando o jarro do leite.

#### Limpeza do dispensador de vapor:

1. Após cada utilização, remova com um pano os resíduos de leite do dispensador de vapor (fig. 26). Para uma limpeza profunda, é aconselhável utilizar o Eco MultiClean: assegura a higiene removendo as proteínas e gorduras do leite, e pode ser usado para limpar a máquina inteira.
2. Dispense vapor durante alguns segundos para limpar bem o dispensador (fig. 10).
3. Aguarde que o dispensador arrefeça; para manter a eficácia do dispensador ao longo do tempo, utilize a agulha de limpeza (C12) para manter os 3 orifícios livres (fig. 27).

## 5.2 Preparar as bebidas à base de leite com o LatteCrema System (fig. 28)

1. Verta para o recipiente (D8) leite à temperatura do frigorífico (5°C) (fig. 29).
2. Feche a tampa (D1) (fig. 30).
3. Rode o manípulo de regulação de espuma (D5) para a posição desejada (fig. 31).

Posição do manípulo de regulação de espuma				
CLEAN				INSERT
Limpeza após cada utilização	Espuma MÁX	Espuma MÉD	Espuma MÍN	Para extrair ou inserir o manípulo

4. Engate o recipiente de leite na máquina (fig. 32).
5. Prepare a dose perfeita (ver “4.1 Fase 1 - Moagem (grinding)” (fig. 11) e “4.2 Fase 2 - Prensagem (tamping)” (fig. 17)”) e insira o porta-filtro.
6. Selecione a bebida à base de leite desejada (fig. 33).

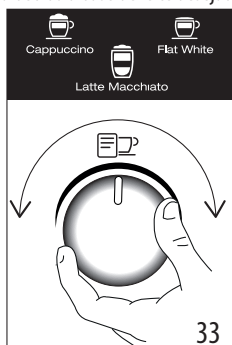

Bebida	Espresso	Leite	Espuma	Quantidade (ml)	X2 (ml)
Cappuccino	1	✓	✓	≈150	≈230
Latte Macchiato	1	✓	✗	≈150	≈230
Flat White	1	✓	✓	≈250	≈330

- **Bebidas com dupla dose (2x):** Verta para o recipiente (D8) a quantidade de leite necessária para a preparação, prestando atenção para não ultrapassar o nível MÁX (fig. 25). Cada entalhe no recipiente corresponde a ≈100 ml de leite.
- **O leite fresco é melhor.** Utilizar sempre leite fresco à temperatura do frigorífico.

7. Prima OK (B6) para dispensar (fig. 23). O aparelho dispensa automaticamente café e leite em sequência.

### Limpeza do LatteCrema System após cada utilização:

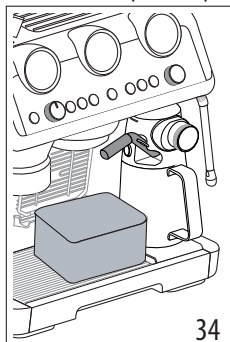

1. Deixe o recipiente do leite engatado na máquina (não é necessário esvaziá-lo). Coloque um recipiente sob o tubo de dispensação do leite (D4) (fig. 34).
2. Rode o manípulo (D5) para “Clean” (fig. 35).



3. A limpeza inicia e interrompe-se automaticamente. Atenção: no final da limpeza, rode o manípulo para uma das posições de regulação da espuma.
4. Remova o recipiente de leite e reponha-o no frigorífico: aconselha-se a utilizar o leite restante com brevidade. Para uma limpeza profunda, é aconselhável utilizar o Eco Multi-Clean: assegura a higiene removendo as proteínas e gorduras do leite, e pode ser usado para limpar a máquina inteira.

## 6. PERSONALIZAR O COMPRIMENTO DAS BEBIDAS À BASE DE CAFÉ COM A TECLA (my) (B9)

1. Preparar a máquina para dispensar 1 ou 2 chávenas da bebida à base de café que deseja dispensar, até engatar o porta-filtro (C1) completo com filtro (C2) ou (C3) e café moído. Caso deseje programar uma bebida à base de leite, ligue o LatteCrema System à máquina.
2. Rode o manípulo (B10) para selecionar a bebida a programar.
3. Prima o botão (my): o indicador luminoso correspondente ao botão OK (B6) acende-se de forma fixa e o indicador luminoso correspondente ao botão (my) pisca.
4. Prima o botão OK para iniciar a dispensação. Os indicadores luminosos correspondentes aos botões OK e (my) piscam.
5. Uma vez atingida a quantidade desejada, prima OK. Se a bebida previr a dispensação de outro ingrediente, começa a dispensação deste último: uma vez atingida a quantidade desejada, prima OK.

6. Prima o botão  para guardar. O aparelho está pronto para uma nova utilização e o indicador luminoso  permanece aceso.







Caso não deseje guardar a programação, prima qualquer outro botão.

**Nota Importante:**

- É possível programar as bebidas com café, mas não a dispensação de vapor e água quente.
- A programação modifica as quantidades das bebidas, mas não do café moído.
- As bebidas "X2" podem ser programadas separadamente.









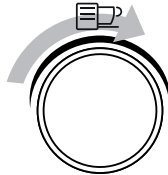













• **My LatteArt**  não é programável.

• **Para regressar às configurações de fábrica, mantenha premido o botão  até ao desligamento. A bebida selecionada regressa à quantidade de fábrica.**

Receita de café	Quantidade de fábrica	Quantidade programável
 Espresso	35 ml	de 25 a 90 ml
 Espresso X2	70 ml	de 50 a 180 ml
 Coffee	80 ml	de 50 a 120 ml
 Coffee X2	160 ml	de 120 a 240 ml
 Americano	120 ml	<ul style="list-style-type: none"> <li>• espresso: de 25 a 60 ml</li> <li>• água: de 25 a 120 ml</li> </ul>
 Americano X2	240 ml	<ul style="list-style-type: none"> <li>• espresso: de 50 a 120 ml</li> <li>• água: de 50 a 240 ml</li> </ul>

**7. MENU DE CONFIGURAÇÕES**

1. Entre no menu:		
Prima em simultâneo durante 5 segundos	x2	
2. Seleccione a configuração a programar:		
		
Bebida	Configuração correspondente	Regulações
→		

 Espresso	Poupança energia	 →  Ativo
		 →  Desligado
 Coffee	Desligar automático	 → 9 minutos
		 → 1,5 horas
		 → 3 horas
 Cappuccino	Sinal sonoro	 →  Ativo
		 →  Desligado
 Latte	Regulação extra da moagem	 → Range 1
		 → Range 2
 Flat White	Valores fábrica	Mantenha premido durante pelo menos 5 segundos o botão OK, até o indicador luminoso permanecer continuamente aceso
 Americano	Dureza da água	 → macia
		 → média
		 → dura/muito dura

**3. Guarde as novas configurações premindo ON/Standby (B1)**

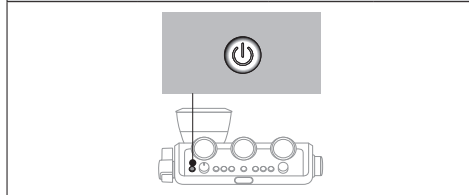













**8. LIMPEZA DO APARELHO**

**Atenção!**

- Para a limpeza da máquina, não utilize solventes, detergentes abrasivos ou álcool.
- Não utilize objetos metálicos para retirar incrustações ou depósitos de café, porque podem riscar as superfícies metálicas ou plásticas.
- Para períodos de inutilização superiores à semana é aconselhado, antes de utilizar a máquina, proceder a um enxaguamento.

### Perigo!

- Durante a limpeza, jamais mergulhar a máquina na água: é um aparelho elétrico.
- Antes de qualquer operação de limpeza das partes externas do aparelho, desligar a máquina, tirar o plugue da tomada e esperar até que a máquina esfrie.



					
	×	✓	✓	×	×
	✓	×	×	✓	✓
	×	×	×	✓	✓
	×	×	×	✓	✓
	×	×	✓	✓	×
	×	×	×	✓	✓
	✓	✓	×	✓	✓

### 8.1 Limpeza do dispensador de café

Quando o indicador luminoso  se acender (laranja) (B5), é necessário proceder à limpeza do circuito do café. Para efetuar o ciclo de limpeza, adquira as pastilhas para a limpeza de máquinas de café. Para mais informações, visite [www.Delonghi.com](http://www.Delonghi.com).

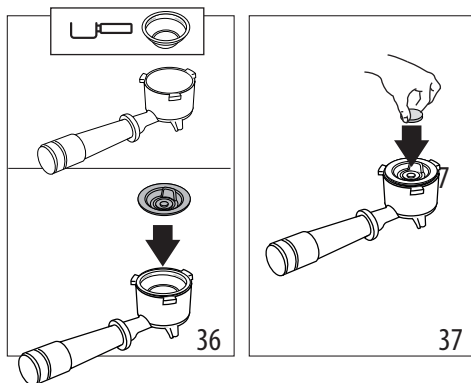
1. Insira no filtro 1 chávena (C2) no porta-filtro (C1) (fig. 36).
2. Insira no filtro o acessório de limpeza (C9) (fig. 36) e prima-o a fundo.



3. Coloque a pastilha para a limpeza no acessório (fig. 37).
  4. Engate o porta-filtro no dispensador de café (A7).
  5. Encha o reservatório de água (A15). Certifique-se de que o tabuleiro de recolha dos pingos (A11) está vazio.
  6. Mantenha premido o botão  até que o respetivo indicador luminoso comece a piscar (a laranja). Após alguns minutos, a limpeza interrompe-se automaticamente.
- Remova o porta-filtro e o acessório de limpeza.
  - Lave o porta-filtro e o filtro sob água corrente.
  - Reinsira o porta-filtro e proceda a um enxaguamento, premindo o botão  (B5): aconselha-se a colocar um recipiente sob o porta-filtro.
  - Remova e esvazie o tabuleiro de recolha pingos.

#### Nota:

Este ciclo de limpeza pode ser iniciado a qualquer momento premindo o botão  (B5) durante alguns segundos. Para cancelar a operação, prima o botão durante 10 segundos.

### 8.2 Limpe o alojamento do recipiente de depósito em grãos

1. Certifique-se de que o recipiente de depósito em grãos (A1) esteja vazio. Eventualmente, proceda a efetuar algumas moagens no vazio para o esvaziar.
2. Desengate o recipiente rodando-o para a esquerda e extraia-o da máquina (fig. 38)

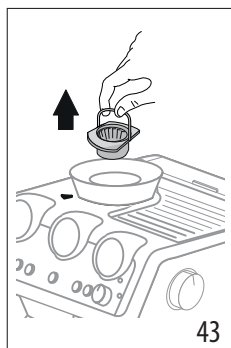
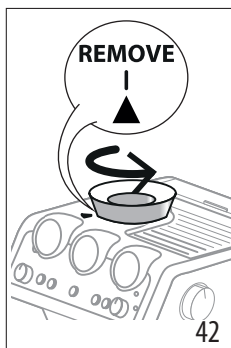
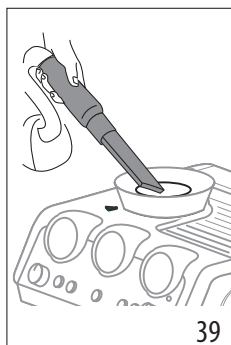
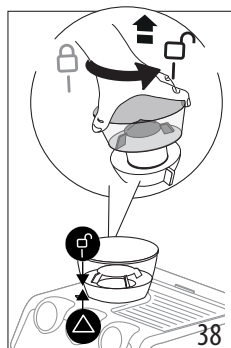

3. Aspirar os resíduos de café (fig. 39).
4. Limpar com um pano macio a sede do depósito do café em grão e secar (fig. 40);

4. Extraia a parte superior do moedor, pegando no mesmo pela correspondente asa (fig.43).
5. Limpar o moedor com um pincel (fig. 44) e aspirar os resíduos de café com um aspirador do pó (fig. 39).

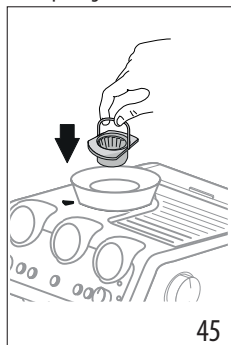
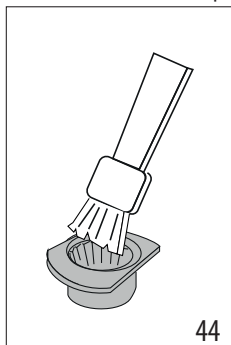
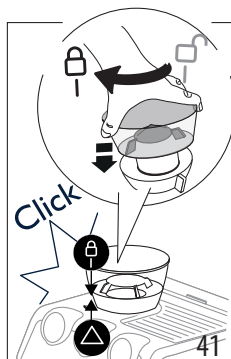
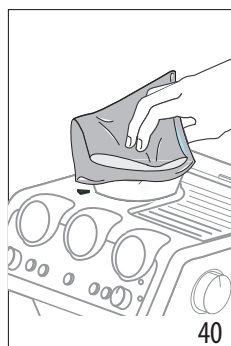

5. Reposicione o depósito, inserindo-o no moinho de café. O depósito está inserido corretamente quando a seta ▲ fica alinhada com o símbolo ☐ e se sente um estalido (fig. 41).

6. Inserir o moedor no seu alojamento (fig. 45);
7. Rodar o regulador selecionando o grau de moagem desejado (fig. 13);

Verificar se o moedor se encontra bem inserido, puxando-o pela asa: o moedor encontra-se corretamente inserido caso não se mova;

### 8.3 Limpeza dos moedores

Quando se limpa o depósito para café em grão (A1), limpe a sede do depósito e o moedor superior com um pano húmido. Dirija-se a um centro de assistência para remover e substituir os moedores. É possível remover o moedor sempre que o moinho de café estiver bloqueado por um corpo estranho. Se tal ocorrer, remova o depósito para café em grão e proceda como explicado a seguir:

1. Engate o copo do porta-filtro (C1) e faça uma moagem “no vazio” para escoar a conduta do café.
2. Desligar o aparelho.
3. Rodar para a esquerda o regulador de moagem até ao bafente, na posição “REMOVE” (fig. 42).

### 8.4 Substituição dos moedores

Quando a quantidade de café moído diminuir ainda mais, dirija-se a um centro de assistência para substituir os moedores: em seguida, regule de novo o moinho de café entrando no menu de configurações (“7. Menu de configurações”) e selecionando o primeiro range de regulação adicional da moagem. Em seguida, rode o manípulo de regulação da quantidade (B2) para a posição MÍN e regule a dose como para a primeira utilização (ver “A”dose perfeita”).

### 8.5 Limpeza da “Smart tamping station”

1. Limpar a zona de engate com um pincel (fig. 46).
2. Puxe pela alavanca (A20) até ao fim de curso e limpe com um pincel a prensa (fig.47) e, em seguida, solte a alavanca.

- Utilizando a escova (C8), limpar a tremonha de café (fig. 48).

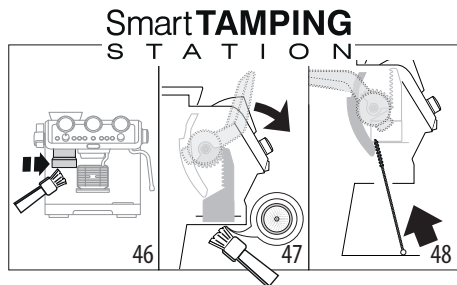

## 8.6 Limpeza do LatteCrema System

Lave na máquina de lavar louça todos os componentes e o recipiente, colocando-os contudo no cesto superior da máquina de lavar louça. Se não tiver uma máquina de lavar louça, proceda à lavagem à mão, conforme indicado na nota no final do parágrafo.

- Prima o botão (D3) e levante a tampa do recipiente de leite (D1);
- Retire o dispensador de café (D4) e o tubo de sucção ((D7) (fig. 49);

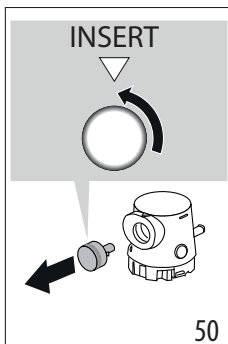
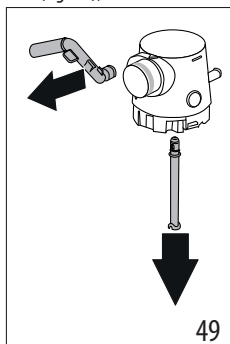

- Rode para a posição "Insert" o manipulador e extraia-o (fig. 50);
- Preste atenção particular para que, na cavidade e no canal situado sob o botão (fig. 51), não restem resíduos de leite: se for o caso, raspe o canal com um palito de dente;

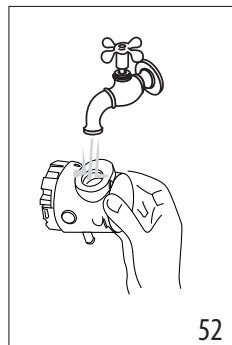
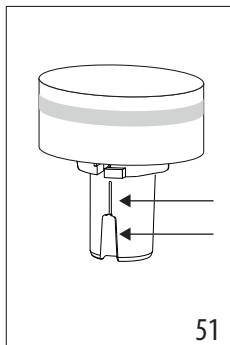

- Enxágue o interior da posição de encaixe do botão de regulação da espuma com água corrente (fig. 52);
- Verificar também que resíduos de leite não tenham obstruído o tubo de imersão e o tubo de saída;
- Remonte todos os componentes da tampa;
- Lave e enxague bem o recipiente de leite (D8) ;
- Reencaixe a tampa no recipiente de leite.

### Nota: lavagem à mão

A lavagem na máquina de lavar louça garante uma higiene perfeita de todos os componentes do recipiente de leite: no caso de lavagem à mão, lave cuidadosamente todos os componentes do recipiente de leite com água quente e mergulhe-os numa bacia de água quente e deixe-os por cerca de 30 minutos, antes de prosseguir como indicado desde o ponto 4.



## 9. DUREZA DA ÁGUA

O indicador luminoso  (B8) de descalcificação acende-se depois de um período de funcionamento pré-determinado, que depende do grau de dureza da água. É possível programar a máquina com base na dureza real da água fornecida pela rede nas diversas regiões, tornando, assim, menos frequente a operação de descalcificação.

- Retirar da embalagem a tira reativa a fornecida "TOTAL HARDNESS TEST" (C4).
- Mergulhar completamente a tira num copo com água durante cerca de um segundo.
- Extraia a tira da água e sacuda-a ligeiramente. Configure o aparelho, conforme indicado no capítulo "7. Menu de configurações".

Resultado do teste de dureza da água	Tecla	Nível
	× 2	1 água doce
		2 água média



Resultado do teste de dureza da água	Tecla	Nível
	OK	3 água dura ou muito dura
		

- Configure o aparelho, conforme indicado no capítulo "7. Menu de configurações".

## 10. COMO UTILIZAR SOFTBALLS

Softballs (C11) consiste num sistema inovador que prolonga a vida útil da máquina sem alterar as qualidades da água, garantindo a extração de um café cremoso e aromático. Para otimizar a eficácia, deixe Softballs na água durante a noite anterior à utilização.

- Extraia o pacote de Softballs da embalagem (fig. 53).

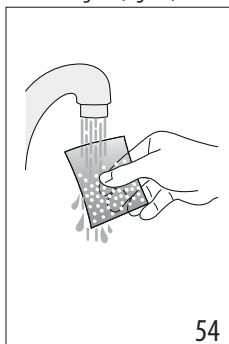
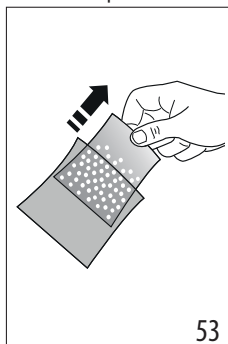

- Enxague com água corrente o pacote de Softballs (fig. 54).
- Submerja a saqueta no reservatório de água (A15) (fig. 55).

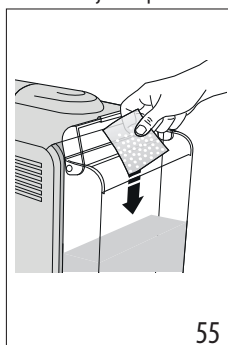

- Substitua a saqueta de Softballs a cada 3 meses (fig. 56).

## 11. DESCALCIFICAÇÃO

### Atenção!

- Antes de utilizar, leia as instruções e a etiqueta do descalcificante (C5), indicadas na embalagem do próprio descalcificante.
- Recomenda-se utilizar exclusivamente o descalcificante De'Longhi. O uso de descalcificantes inadequados, assim como a descalcificação não realizada regularmente, pode comportar o surgimento de defeitos não cobertos pela garantia do fabricante.
- O descalcificante pode danificar as superfícies delicadas. Se o produto for acidentalmente derramado, seque-o de imediato.

### Para efetuar a descalcificação

Descalcificador	Descalcificador De'Longhi
Recipientes	2 de 1 litro cada
Tempo	~40min

- (SE PRESENTE, RETIRE O FILTRO AMACIADOR E SOFTBALLS). Verta o descalcificante no depósito de água (A15) até ao nível  A (correspondente a uma embalagem de 100 ml) impresso no lado interno do depósito (fig. 57).

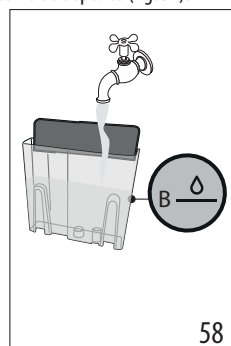
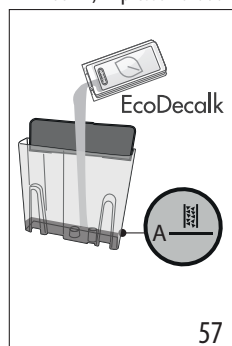

- Adicione água até atingir o nível  B (fig. 58). Em seguida, reintroduza o reservatório de água na máquina.
- Insira o acessório (C6) no conector para o LatteCrema System (A6) (fig. 59).

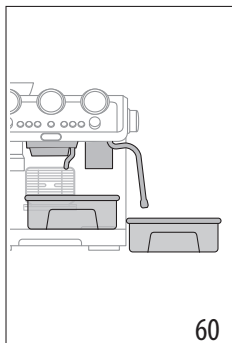
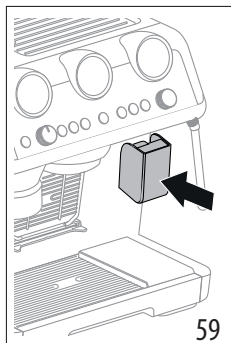

4. Certifique-se de que o porta-filtro (C1) não esteja engatado e coloque um recipiente sob os dispensadores de café e de água quente (A7), e sob o dispensador de vapor (A5) (fig. 60).
5. Mantenha premida a tecla  (B8) até que o indicador luminoso correspondente comece a piscar.
6. O programa de descalcificação inicia e o líquido descalcificante sai pelos dispensadores. O programa de descalcificação executa automaticamente toda uma série de enxaguamentos a intervalos regulares para remover os resíduos de calcário do interior da máquina de café até esvaziar o reservatório.

A dispensação é interrompida e o indicador luminoso  passa a branco. É então necessário proceder a um ciclo de enxaguamento:

7. Esvaziar o depósito usado para a recolha do líquido descalcificante e voltar a colocá-lo sob os dispensadores.
8. Extrair o reservatório de água, esvaziá-lo de eventuais resíduos de solução descalcificador, enxaguá-lo com água corrente e enchê-lo com água fresca até ao nível MAX (fig. 61). Reinsere-lo depois no seu alojamento.

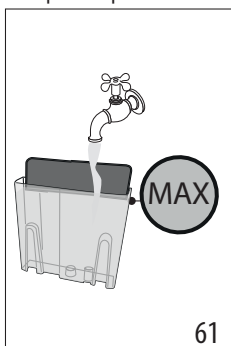



9. Mantenha premido o botão  até que o indicador luminoso correspondente comece a piscar: o enxaguamento inicia.
10. Uma vez concluído o enxaguamento, a dispensação interrompe-se e o aparelho está pronto para ser utilizado.
11. Esvaziar os depósitos de recolha da água de enxaguamento.











12. Extrair e esvaziar o compartimento de recolha de pingos e, em seguida, voltar a inseri-lo.
13. Extrair e encher o reservatório de água com água fresca e, em seguida, voltar a inseri-lo.











O aparelho assim está pronta ao uso.

**Nota Importante:**



- Caso deseje antecipar o ciclo de descalcificação, mantenha premido o botão  durante 3 segundos.
- Caso a descalcificação tenha sido acionada por engano, prima o botão  durante 10 segundos; o enxaguamento não pode ser interrompido.

## 12. SIGNIFICADO DOS INDICADORES LUMINOSOS

INDICADORES LUMINOSOS	SIGNIFICADO INDICADORES LUMINOSOS	OPERAÇÃO
Todos os indicadores luminosos piscam curtamente	Ligação do aparelho	Auto-diagnóstico
 fixo	É a primeira ativação da máquina e é necessário proceder ao enchimento do circuito da água	Proceda conforme o indicado no cap. "3. Primeira colocação em funcionamento do aparelho"
 fixo	A função de poupança energética encontra-se ativa	Consulte o cap. "7. Menu de configurações" caso deseje reativar a função
 fixo	O depósito de café em grãos (A1) está vazio	Encher o depósito de café em grãos
 intermitente	Caso deseje proceder à moagem, mas o recipiente de café em grãos (A1) estiver vazio	Encher o depósito de café em grãos
 on	A água no depósito (A15) não é suficiente ou o reservatório de água não se encontra bem inserido	Encher o depósito ou extrair e voltar a inserir corretamente o depósito
 intermitente	Caso deseje proceder à preparação de uma bebida, mas o reservatório de água (A15) esteja vazio	Encher o reservatório de água
 fixo	Alarme genérico	Dirija-se a um centro de assistência
 fixo	O depósito de borras de café não está inserido	Insira corretamente o depósito para café em grão (A1) ou certifique-se de que esteja corretamente inserido
 intermitente	O seletor, na base do depósito para café em grão (A1), não está na posição correta	Volte a colocar o seletor numa das posições de moagem (entre 1 e 8), lembrando-se de: <ul style="list-style-type: none"> <li>Regular a moagem enquanto o moinho de café está em funcionamento</li> <li>Regular em um nível de cada vez e fazer pelo menos 5 moagens entre uma regulação e a outra</li> </ul>
	O depósito para café em grão (A1) não está completamente inserido: intervém o dispositivo de segurança	Certifique-se de que o depósito de café em grão está corretamente inserido
 fixo	O LatteCrema System deve ser limpo após cada utilização	Após ter terminado as preparações à base de leite, proceda à limpeza automática rodando o manípulo (D5) para Clean
 fixo	O aparelho está pronto para a dispensação de vapor.	O aparelho atingiu a temperatura para dispensar vapor. Para proceder à dispensação, rode o manípulo do vapor (A4)
→		

INDICADORES LUMINOSOS	SIGNIFICADO INDICADORES LUMINOSOS	OPERAÇÃO
 intermitente	O aparelho está ligado e a função de poupança energética encontra-se ativa: o botão do vapor (A4) está na posição de dispensação de vapor	O indicador luminoso pisca a indicar que o aparelho se está a preparar para dispensar vapor: o dispensador inicia mal o aparelho esteja à temperatura
	O aparelho está pronto para a dispensação de vapor	O aparelho está à temperatura para a preparação de vapor quando o indicador luminoso permanece fixo
	O aparelho está a dispensar vapor	
 fixo (laranja)	É necessário proceder à descalcificação	Efetuar a descalcificação conforme o ilustrado na sec. "11. Descalcificação"
 intermitente (laranja)	O aparelho encontra-se a realizar a descalcificação	Proceda realizando a operação conforme o descrito no cap. "11. Descalcificação"
 fixa (branca)	É necessário proceder ao enxaguamento	
 intermitente (branca)	O aparelho está a realizar o enxaguamento	
 fixa (laranja)	É necessário proceder à limpeza do dispensador de café	Ver par. "8.1 Limpeza do dispensador de café"
 intermitente (laranja)	O aparelho está a efetuar a limpeza do dispensador de café	
 intermitente (branca)	O aparelho está a realizar um enxaguamento	
 intermitente	Se estiver presente o filtro amaciador, poderá entrar uma bolha de ar no circuito, impedindo a dispensação	Premir a tecla (B7) correspondente ao indicador luminoso  : a dispensação inicia e interrompe-se automaticamente.
	A moagem é muito fina e, portanto, o café sai muito lentamente ou não sai de todo.	Extrair o compartimento (C1), repetir as operações para fazer o café, tendo em mente as indicações da sec. "4.1 Fase 1 - Moagem (grinding) (fig. 11)" e "4.2 Fase 2 - Prensagem (tamping) (fig. 17)"
	O filtro de café (C2) ou (C3) está obturado	Enxague os filtros sob a água corrente ou efetue um enxaguamento com o botão enxaguamento (B5).
	O depósito (A15) está mal inserido e as respetivas válvulas não estão abertas	Prima levemente o reservatório de forma a abrir as válvulas
	Há calcário no circuito hidráulico	Efetuar a descalcificação conforme indicado no cap. "11. Descalcificação"

### 13. SE ALGO NÃO FUNCIONAR

PROBLEMA	CAUSA	SOLUÇÃO
Está presente água no tabuleiro de recolha dos pingos (A11)	Faz parte do funcionamento normal dos circuitos internos da máquina	Esvazie e limpe regularmente o tabuleiro de recolha pingos (A11)
Não sai mais café expresso	Falta de água no reservatório (A15)	Encher o reservatório
	O indicador luminoso  (B7) está aceso para indicar que o circuito de café ou circuito de vapor está vazio.	Prima o botão correspondente ao indicador luminoso  para encher o circuito.
	O filtro (C2) ou (C3) está obturado	Enxague os filtros sob a água corrente ou efetue um enxaguamento com o respetivo botão (B5)
	O depósito (A15) está mal inserido e ad válvula no fundo não estão abertas	Pressionar levemente o depósito de modo a abrir as válvulas em seu fundo
	Há calcário no circuito hidráulico	Efetuar a descalcificação conforme indicado no cap. “11. Descalcificação”
	Moagem demasiado fina	Extrair o compartimento (C1), repetir as operações para fazer o café, tendo em mente as indicações da sec. “4.1 Fase 1 - Moagem (grinding) (fig. 11)” e “4.2 Fase 2 - Prensagem (tamping) (fig. 17)”
O porta-filtro não se encaixa ao aparelho	O café moído não foi prensado ou está em quantidade excessiva	Repita a moagem com configurações diferentes. Reduza a quantidade da dose: certifique-se de que o filtro (C2) ou (C3) (1 ou 2 chávenas) está correto em relação à dose a moer (botão 2x (B3) selecionado ou não)
O café expresso pinga das bordas do porta-filtro (C1) e não através dos furos	O porta-filtro está mal inserido	Encaixar o porta-filtro corretamente e girá-lo até o fim com força
	O vedante do dispensador do café (A7) perdeu elasticidade ou está suja	Substitua o vedante do dispensador de café junto de um Centro de Assistência
	O filtro (C2) ou (C3) está obturado	Enxague os filtros sob a água corrente ou efetue um enxaguamento com o botão correspondente (B5)
O creme do café é claro (desce rapidamente do bico)	É necessário rever as configurações do aparelho	Extrair o compartimento, repetir as operações para fazer o café, tendo em mente as indicações da sec. “4.1 Fase 1 - Moagem (grinding) (fig. 11)” e “4.2 Fase 2 - Prensagem (tamping) (fig. 17)”
O creme do café é escuro (o café desce lentamente do bico)	É necessário rever as configurações do aparelho	Extrair o compartimento (C1), repetir as operações para fazer o café, tendo em mente as indicações da sec. “4.1 Fase 1 - Moagem (grinding) (fig. 11)” e “4.2 Fase 2 - Prensagem (tamping) (fig. 17)”
		→

<b>PROBLEMA</b>	<b>CAUSA</b>	<b>SOLUÇÃO</b>
Não se forma espuma do leite enquanto se faz o cappuccino com o LatteCrema System	O leite não está suficientemente frio	Utilizar sempre leite com temperatura do frigorífico
	O manípulo (D5) não está na posição correta	Verifique e rode o manípulo para a posição correta ( ☞ máx. espuma; ☞ méd espuma; ☞ mín espuma )
	O LatteCrema System está sujo	Proceda à limpeza conforme ilustrado na secção “8.6 Limpeza do LatteCrema System”
	Há calcário no circuito hidráulico	Efetuar a descalcificação conforme indicado no cap. “11. Descalcificação”
No término da descalcificação, o aparelho precisa de outro enxaguamento	Durante o ciclo de enxaguamento, o depósito não foi enchido até ao nível MAX	Repita o enxaguamento (ver cap. “11. Descalcificação”)
O aparelho não mói o café	No interior do moinho de café está presente um corpo estranho	Proceder à limpeza dos moedores conforme indicado na sec. “8.3 Limpeza dos moedores”, certificando-se de remover todo o café em grãos do depósito do café em grãos (A2) antes de o extrair. Antes de reinserir o moinho, aspire cuidadosamente todos os resíduos da sua sede
	O depósito de café em grão (A1) não está na posição correta	O depósito está inserido corretamente quando a seta ▲ fica alinhada com o símbolo ☞ e sente-se um estalido
Se se desejar alterar a qualidade do café	É necessário eliminar todo o café em grãos presente na máquina	<ul style="list-style-type: none"> <li>• Esvazie o depósito café em grãos (A1) (fazendo moagens em vazio ou eventualmente aspirando o café em grãos residual).</li> <li>• Engate o compartimento porta-filtro (C1) e efetuar moagens “vazias” para libertar o tubo de passagem do café: engatar em seguida o porta-filtro à saída do moedor do café (A18) alinhando-o com a inscrição INSERT e rodar para a direita o compartimento (fig. 22). A moagem tem início quando o compartimento atinge a posição CLOSE e é automaticamente interrompida. Repetir até que o filtro permaneça vazio</li> <li>• Insira no depósito (A1) a nova variedade de café em grão</li> <li>• Se a moagem não atingir a “dose perfeita”, proceda conforme na primeira utilização</li> </ul>
		→

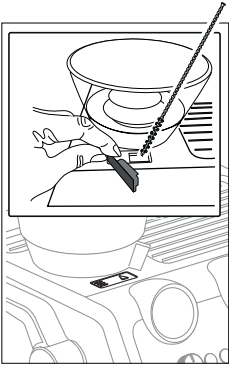
<b>PROBLEMA</b>	<b>CAUSA</b>	<b>SOLUÇÃO</b>
Após a moagem, o filtro de café (C2) ou (C3) está vazio	A tremonha do café do moedor de café está entupida	<p>Proceder à limpeza conforme indicado na sec. "8.5 Limpeza da "Smart tamping station"". Se o problema persistir, aceda à tremonha abrindo a portinhola correspondente (A19) e solte-a utilizando a escovinha</p> 
Após a moagem, o pó do café no filtro é demasiado abundante		
Após a moagem, o café em pó no filtro (C2) ou (C3) não atinge a "dose perfeita"	A "Smart Tamping Station" precisa de ser limpa	Proceder à limpeza conforme indicado na sec. "8.5 Limpeza da "Smart tamping station"", em seguida, repita a moagem
	É necessário regular a quantidade de café moído	Regular a quantidade com o manípulo correspondente, (B2) seguindo as indicações na secç. "A "dose perfeita"". Se o manípulo já estiver na posição máx., proceda conforme indicado na secção "Regulação extra da moagem"
	Com o tempo os moedores desgastam-se	Proceder à substituição dos moedores conforme indicado na sec. "8.4 Substituição dos moedores"

Πριν χρησιμοποιήσετε τη συσκευή, διαβάζετε πάντα το φύλλο των προειδοποιήσεων ασφαλείας.

## 1. ΠΕΡΙΓΡΑΦΗ

### 1.1 Περιγραφή της συσκευής - A

- A1. Δοχείο για κόκκους
- A2. Καπάκι δοχείου κόκκων
- A3. Δίσκος φλιτζανιών
- A4. Διακόπτης ατμού
- A5. Σωλήνας παροχής ατμού
- A6. Εξάρτημα σύνδεσης για το Lattecrema System
- A7. Ακροφύσιο καφέ
- A8. Σχάρα φλιτζανιών για espresso
- A9. Σχάρα φλιτζανιών για ποτήρια ή κούπες
- A10. Σχάρα δίσκου
- A11. Δίσκος συλλογής σταγόνων
- A12. Δείκτης στάθμης νερού στο δίσκο συλλογής σταγόνων
- A13. Καπάκι δοχείου νερού
- A14. Λαβή αφαίρεσης δοχείου νερού
- A15. Δοχείο νερού
- A16. Σημείο σύνδεσης καλωδίου τροφοδοσίας
- A17. Γενικός διακόπτης (ON/OFF)
- A18. Έξοδος μύλου καφέ (Tamping station)
- A19. Πορτάκι για πρόσβαση στο χωνί του μύλου καφέ
- A20. Μοχλός πατητηριού

### 1.2 Περιγραφή πίνακα ελέγχου - B

- B1. Κουμπί ON/Standby
- B2. Κουμπί ρύθμισης ποσότητα αλεσμένου καφέ
- B3. Κουμπί «Χ2»: για χρήση του φίλτρου 2 καφέδων
- B4. Κουμπί «θερμοκρασία καφέ»
- B5. Κουμπί «ξεβγαλμα»
- B6. Κουμπί «OK»: για την παροχή ροφήματος/για επιβεβαίωση
- B7. Κουμπί «παροχή ζεστού νερού»
- B8. Κουμπί «αφαλάτωση»
- B9. Κουμπί «My»: για εξατομίκευση της γεύσης των ροφημάτων
- B10. Διακόπτης επιλογής λειτουργιών
- B11. Οθόνη προβολής ροφημάτων:

#### Ροφήματα με βάση τον καφέ Espresso

- Espresso
- Americano
- Coffee

#### Ροφήματα με βάση το γάλα

- Cappuccino
- Flat White
- Latte Macchiato

- B12. Λυχνία «καθαρισμός γάλακτος»
- B13. Λυχνία «απουσία δοχείου για κόκκους»
- B14. Λυχνία «γενικός συναγερμός»
- B15. Μανόμετρο

B16. Λυχνία «απουσία νερού»

B17. Λυχνία «άδειο δοχείο για κόκκους»

B18. Λυχνία «εξοικονόμηση ενέργειας»

B19. Οθόνη ρυθμίσεων και διαδικασίας:

- Δείχνει την ενέργεια που εκτελεί η συσκευή
- Δείχνει τη ρύθμιση της επιλεγμένης δόσης καφέ
- Δείχνει την επιλεγμένη ρύθμιση της θερμοκρασίας καφέ

### 1.3 Περιγραφή των εξαρτημάτων - C

- C1. Κύπελλο θήκης φίλτρου
- C2. Φίλτρο 1 φλιτζανιού
- C3. Φίλτρο 2 φλιτζανιών
- C4. Δοκιμαστική ταινία «Total Hardness Test»
- C5. Αφαλατικό
- C6. Εξάρτημα για αφαλάτωση
- C7. Αποσπώμενο ηλεκτρικό καλώδιο
- C8. Βουρτσάκι
- C9. Εξάρτημα καθαρισμού ακροφυσίου καφέ
- C10. Πανί
- C11. Softballs (αποσκληρυντής νερού)
- C12. Βελόνα καθαρισμού για ακροφύσιο ατμού

### 1.4 Τα εξαρτήματα καθαρισμού δεν περιλαμβάνονται, συνιστώνται από τον κατασκευαστή

Για περισσότερες πληροφορίες, επισκεφθείτε το [Delonghi.com](http://Delonghi.com).



#### Ταμπλέτες καθαρισμού

(Δείτε «8.1 Καθαρισμός του ακροφυσίου καφέ»)

 **Καθαριστής**  
EAN: 8004399333307

### 1.5 Περιγραφή του LatteCrema System - D

- D1. Καπάκι δοχείου γάλακτος
- D2. Σύνδεσμος δοχείου γάλακτος
- D3. Κουμπί απελευθέρωσης καπακιού
- D4. Στόμιο παροχής γάλακτος (ρυθμιζόμενο σε ύψος)
- D5. Κουμπί ρύθμισης αφρού
- D6. Υποδοχή διακόπτη
- D7. Σωλήνας άντλησης γάλακτος
- D8. Δοχείο γάλακτος

## 2. ΠΡΟΕΤΟΙΜΑΣΙΑ ΤΗΣ ΣΥΣΚΕΥΗΣ

Πλύνετε όλα τα εξαρτήματα με χλιαρό νερό και απορρυπαντικό πιάτων, στη συνέχεια, προχωρήστε με τον ακόλουθο τρόπο:

1. Τοποθετήστε το δίσκο συλλογής σταγόνων (A11) μαζί με τη σχάρα φλιτζανιών (A9) και τη σχάρα δίσκου (A10) (εικ. 1).



2. Αφαιρέστε το δοχείο νερού (A15) (εικ. 2) και γεμίστε το με φρέσκο και καθαρό νερό με προσοχή ώστε να μην ξεπεράσετε την επιγραφή MAX (εικ. 3).

3. Στη συνέχεια εισάγετε το δοχείο.

**Προσοχή:** Μη θέτετε ποτέ σε λειτουργία τη συσκευή χωρίς νερό στο δοχείο ή χωρίς δοχείο.

**Σημείωση:** Συνιστάται να ρυθμίσετε το ταχύτερο δυνατόν τη σκληρότητα του νερού σύμφωνα με τη διαδικασία που περιγράφει το κεφάλαιο «7. ΜΕΝΟΥ ΡΥΘΜΙΣΕΙΣ».

### 3. ΑΡΧΙΚΗ ΛΕΙΤΟΥΡΓΙΑ ΤΗΣ ΣΥΣΚΕΥΗΣ

1. Συνδέστε το καλώδιο τροφοδοσίας (C7) στην αντίστοιχη θέση (A16) στο πίσω μέρος του μηχανήματος (εικ. 4) και στη συνέχεια βάλτε το καλώδιο στην πρίζα. Βεβαιωθείτε ότι ο γενικός διακόπτης (A17), που βρίσκεται στο πίσω μέρος της μηχανής είναι πατημένος στη θέση 1 (εικ. 5)
2. Τοποθετήστε κάτω από το ακροφύσιο ζεστού νερού (σε αντιστοιχία με το ακροφύσιο καφέ (A7)) ένα δοχείο ελάχιστης χωρητικότητας 100 ml (εικ. 6).
3. Πατήστε το πλήκτρο (B7) που αντιστοιχεί στη λυχνία  (εικ. 7): η παροχή αρχίζει και διακόπεται αυτόματα. Αδειάστε το δοχείο.

Πριν ξεκινήσετε τη χρήση της μηχανής πρέπει να ξεπλύνετε τα εσωτερικά κυκλώματά της. Ακολουθήστε τον παρακάτω τρόπο:

4. Συνδέστε ολόκληρο το κύπελλο θήκης φίλτρου (C1) στη μηχανή: για τη σωστή σύνθεση ευθυγραμμίστε τη λαβή του κυπέλλου θήκης φίλτρου στο σύμβολο «INSERT» (εικ. 8) και στρέψτε τη λαβή προς τα δεξιά μέχρι να την ευθυγραμμίσετε στη θέση «CLOSE».
5. Τοποθετήστε ένα δοχείο κάτω από το κύπελλο θήκης φίλτρου και στον σωλήνα παροχής ατμού (A5).
6. Πατήστε το πλήκτρο (B5) που αντιστοιχεί στη λυχνία  (εικ. 9): η παροχή ξεκινά.
7. Μόλις ολοκληρωθεί η παροχή, περιστρέψτε τον διακόπτη ατμού (A4) (εικ. 10) και αφήστε να βγει ατμός για μερικά δευτερόλεπτα έτσι ώστε να ξεπλυθεί το κύκλωμα του ατμού: για να έχετε την βέλτιστη παροχή ατμού, συνιστάται η επανάληψη αυτής της ενέργειας επί 3 ή 4 φορές. Αυτό επιτρέπει την απομάκρυνση του νερού του σωλήνα πριν την παροχή ατμού.

Η μηχανή είναι τώρα έτοιμη για χρήση.

**Σημείωση:** το ξέβγαλμα των εσωτερικών κυκλωμάτων συνιστάται και σε περίπτωση παρατεταμένης περιόδου αχρησίας της μηχανής.

Κατά την πρώτη χρήση, θα πρέπει πρώτα να παρασκευάσετε 4-5 καφέδες προκειμένου το μηχάνημα να αρχίσει να δίνει ικανοποιητικό αποτέλεσμα: δώστε ιδιαίτερη προσοχή στη δόση του αλεσμένου καφέ στο φίλτρο ((C2) ή (C3)) (δείτε οδηγίες στην παράγραφο «4.1 Στάδιο 1 - Άλεση (grinding)» (εικ. 11)).

προχωρήστε όπως υποδεικνύεται στο κεφάλαιο «Η «τέλεια δόση»».

## 4. ΠΡΟΕΤΟΙΜΑΣΙΑ ΤΟΥ ΚΑΦΕ

### 4.1 Στάδιο 1 - Άλεση (grinding) (εικ. 11)

1. Ρίξτε τους κόκκους μέσα στο δοχείο (A1) (εικ. 12). Συνιστάται να ρίχνετε μόνο τους κόκκους που απαιτούνται για την παρασκευή: με αυτόν τον τρόπο χρησιμοποιείτε πάντα φρέσκο καφέ.
2. Επιλέξτε τον βαθμό άλεσης (εικ. 13). Η εργοστασιακή ρύθμιση είναι στο 5 (μέτρια άλεση). Αν το αποτέλεσμα δεν είναι ικανοποιητικό, ρυθμίστε το επίπεδο με βάση την προσωπική σας προτίμηση και τον τύπο του καφέ (η ρύθμιση πρέπει να πραγματοποιείται κατά τη διάρκεια λειτουργίας του μύλου καφέ).
3. Εισάγετε ένα από τα φίλτρα του καφέ (C2) ή (C3) μέσα στη θήκη του φίλτρου (C1) (εικ. 14). Αν χρησιμοποιήσετε το φίλτρο για τα 2 φιλτζάνια, πατήστε το κουμπί 2X (B3): με αυτή την επιλογή διπλασιάζεται και η ποσότητα παροχής του espresso.
4. Ρυθμίστε τον διακόπτη της ποσότητας (B2) ξεκινώντας από την ελάχιστη θέση (εικ. 15).

**Σημείωση:**



Οι αριθμοί που εμφανίζονται στην οθόνη (B19) χρησιμεύουν ως αναφορά μόλις επιτευχθεί το σωστό επίπεδο μέσα στη θήκη του φίλτρου.

Δεν αντιστοιχούν στις ρυθμίσεις της άλεσης, στο βάρος του αλεσμένου καφέ (gr/oz) ή στον χρόνο άλεσης.

Συμβουλευτείτε την παράγραφο «B3. Κουμπί «X2»: για χρήση του φίλτρου 2 καφέδων» για περισσότερες οδηγίες.

5. Συνδέστε το φίλτρο στην έξοδο του μύλου του καφέ (A18) ευθυγραμμίζοντας με την επιγραφή INSERT: στη συνέχεια στρέψτε προς τα δεξιά το κύπελλο (εικ. 16). Η άλεση ξεκινά όταν το κύπελλο φτάσει στη θέση CLOSE και διακόπεται αυτόματα.

### Ρυθμίστε την ποσότητα του αλεσμένου καφέ στο φίλτρο

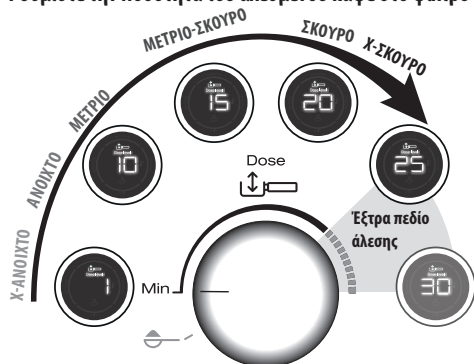

Κάθε ποικιλία κόκκου δίνει διαφορετικό αποτέλεσμα κατά τη διάρκεια της άλεσης και γι' αυτό στην αρχή η ρύθμιση της δόσης απαιτεί εξαιρετική προσοχή.

Η εικόνα αυτή δίνει οδηγίες ως προς τη ρύθμιση της δόσης, με βάση το χρώμα του ψησίματος: πρέπει να θεωρούνται σημείο εκκίνησης, ωστόσο ενδέχεται να διαφέρουν ανάλογα με τη σύνθεση των κόκκων του καφέ.

1. Ρυθμίστε τη δόση από την ελάχιστη θέση.
2. Έχοντας ως αναφορά το χρώμα ψησίματος του καφέ σας, περιστρέψτε αργά το κουμπί.

## 4.2 Στάδιο 2 - Πάτημα (tamping) (εικ. 17)

1. Μετά την άλεση, χαμηλώστε τον μοχλό του πατητηριού (A20) ως το τέρμα της διαδρομής (μην αφαιρείτε τη θήκη φίλτρου) (εικ. 18). Για να έχετε τέλειο αποτέλεσμα, επαναλάβετε 2 φορές.
2. Κρατήστε χαμηλωμένο τον μοχλό ως το τέρμα της διαδρομής κατά τη διάρκεια της αφαίρεσης της θήκης φίλτρου (εικ. 19). Έπειτα επαναφέρετε τον μοχλό στην αρχική θέση.
3. Μόλις επιβεβαιώσετε ότι η δόση του καφέ είναι σωστή (δείτε «Η «τέλεια δόση»»), συνδέστε τη θήκη του φίλτρου στο ακροφύσιο καφέ (A7) (εικ. 20).

### Η «τέλεια δόση»

- Τα φίλτρα του καφέ διαθέτουν εσωτερική ένδειξη αναφοράς για τον προσδιορισμό της τέλειας δόσης.



### Χάραξη με λείζερ

### Ανάγλυφη χάραξη

- Φίλτρα με χάραξη λείζερ: η τέλεια δόση αντιστοιχεί στην πάνω γραμμή της χάραξης.
- Φίλτρα με ανάγλυφη χάραξη: η τέλεια δόση αντιστοιχεί στην ανάγλυφη γραμμή.
- Βεβαιωθείτε ότι ο καφές είναι σε αυτό το επίπεδο μετά το πάτημα. Μπορεί να χρειαστεί να ρυθμίσετε περισσότερες φορές το κουμπί (B2) προτού φτάσετε στην τέλεια δόση.
- Αν ο καφές υπερ- ή υπο-εκχυλίζεται και η δόση βρίσκεται εντός της τέλειας δόσης, ρυθμίστε τον βαθμό άλεσης σε πιο λεπτό ή πιο χοντρό (δείτε «4.1 Στάδιο 1 - Άλεση (grinding)» (εικ. 11)»). Αν ο καφές υπερ-εκχυλίζεται (πολύ αργή παροχή) η άλεση πρέπει να είναι πιο χοντρή. Αν ο καφές υπο-εκχυλίζεται (πολύ γρήγορη παροχή) η άλεση πρέπει να είναι πιο λεπτή.
- **Ο μπαρίστα συστή:** Βγάλτε τη θήκη του φίλτρου ενώ ο μοχλός του πατητηριού (A20) είναι χαμηλωμένος για να έχετε ένα τέλειο φινιρίσμα της δόσης του καφέ.

## 4.3 Στάδιο 3 - Παροχή (brewing) (εικ. 21)

1. Επιλέξτε το επιθυμητό ρόφημα (εικ. 22).

2. Πατήστε OK (B6) για να ξεκινήσει η παροχή (εικ. 23) (προ-έγχυση και έγχυση). Η παροχή του καφέ διακόπτεται αυτόματα.

## 5. ΠΡΟΕΤΟΙΜΑΣΙΑ ΡΟΦΗΜΑΤΩΝ ΓΑΛΑΚΤΟΣ

### 5.1 Φτιάξτε το αφρόγαλα (εικ. 24)

1. Ρίξτε στο δοχείο του γάλακτος (D8) την ποσότητα γάλακτος που θέλετε να ζεψάνετε/να αφρίσει, λαμβάνοντας υπόψη ότι ο όγκος του γάλακτος θα αυξηθεί κατά 2 ή 3 φορές (εικ. 25). Για να έχετε πιο πυκνό και ομοιογενή αφρό, συστήνεται η χρήση πλήρους αγελαδινού γάλακτος σε θερμοκρασία ψυγείου (περίπου 5° C).

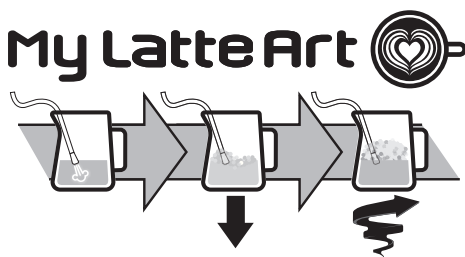

2. Για να φτιάξετε το αφρόγαλα, τοποθετήστε τον σωλήνα παροχής ατμού (A5) πάνω στην επιφάνεια του γάλακτος: με αυτόν τον τρόπο ο αέρας ανακατεύεται με το γάλα και τον ατμό.
3. Διατηρήστε το ακροφύσιο του ατμού πάνω στην επιφάνεια, φροντίζοντας να μην λαμβάνετε πάρα πολύ αέρα δημιουργώντας πολύ μεγάλες φουσκάλες.
4. Βυθίστε το ακροφύσιο ατμού κάτω από την επιφάνεια του γάλακτος: με αυτόν τον τρόπο δημιουργείται μια δίνη. Μόλις επιτευχθεί η επιθυμητή θερμοκρασία, ξανακλείστε τον διακόπτη ατμού και περιμένετε έως ότου η παροχή του ατμού σταματήσει εντελώς προτού αφαιρέσετε το μπρίκι με το γάλα.

### Ο μπαρίστα συστή:

- **Το φρέσκο γάλα είναι καλύτερο.** Χρησιμοποιείτε πάντα φρέσκο γάλα σε θερμοκρασία ψυγείου.
- Το πλήρες γάλα δίνει άριστα αποτελέσματα. Το αποτέλεσμα και η υφή του αφρού διαφέρουν ανάλογα με το αγελαδινό γάλα ή με τα φυτικά ροφήματα που χρησιμοποιούνται.
- Αφού φτιάξετε το αφρόγαλα, εξαφανίστε τις φουσκάλες ανακινώντας το μπρίκι με το γάλα.





### Καθαρισμός του ακροφυσίου ατμού:

1. Μετά από κάθε χρήση, αφαιρέστε με ένα πανί τα υπολείμματα του γάλακτος από το ακροφύσιο του ατμού (εικ. 26). Για ένα βαθύ καθαρίσμα, συστήνεται η χρήση του Eco MultiClean: εξασφαλίζει την υγιεινή αφαιρώντας τις πρωτεΐνες και τα λίπη του γάλακτος και μπορεί να χρησιμοποιηθεί για τον καθαρισμό ολόκληρης της μηχανής.

- Αφήστε να βγει ατμός για μερικά δευτερόλεπτα ώστε να καθαριστεί καλά το ακροφύσιο (εικ. 10).
- Περιμένετε έως ότου κρυώσει το στόμιο εκροής: για να διατηρήσετε την αποδοτικότητα του στόμιου εκροής με την πάροδο του χρόνου, χρησιμοποιήστε τη βελόνα καθαρισμού (C12) ώστε να διατηρούνται ανοιχτές οι 3 οπές (εικ. 27).

## 5.2 Φτιάξτε ροφήματα γάλακτος με το LatteCrema System (εικ. 28)

- Ρίξτε στο δοχείο (D8) γάλα που βρίσκεται σε θερμοκρασία ψυγείου (5°C) (εικ. 29).
- Κλείστε το καπάκι (D1) (εικ. 30).
- Περιστρέψτε το κουμπί ρύθμισης αφρού (D5) στη θέση που επιθυμείτε (εικ. 31).

Θέση κουμπιού ρύθμισης αφρού				
 CLEAN				 INSERT
Καθαρισμός μετά από κάθε χρήση	Αφρός MAX	Αφρός MED	Αφρός MIN	Για να αφαιρέσετε ή να τοποθετήσετε τον διακόπτη

- Συνδέστε το δοχείο γάλακτος στη μηχανή (εικ. 32).
- Ετοιμάστε την τέλεια δόση (δείτε «4.1 Στάδιο 1 - Άλεση (grinding)» (εικ. 11) και «4.2 Στάδιο 2 - Πάτημα (tamping)» (εικ. 17)») και τοποθετήστε τη θήκη του φίλτρου.
- Επιλέξτε το ρόφημα γάλακτος που επιθυμείτε (εικ. 33).



Ρόφημα	Espresso	Γάλα	Αφρός	Ποσότητα (ml)	X2 (ml)
Flat White	1	✓	✓	≈250	≈330

- Ροφήματα με διπλή δόση (2x):** Ρίξτε στο δοχείο (D8) την ποσότητα γάλακτος που απαιτείται για την παρασκευή, φροντίζοντας να μην ξεπεράσετε το επίπεδο MAX (εικ. 25). Κάθε γραμμή πάνω στο δοχείο αντιστοιχεί σε ≈100 ml γάλακτος.
  - Το φρέσκο γάλα είναι καλύτερο.** Χρησιμοποιείτε πάντα φρέσκο γάλα σε θερμοκρασία ψυγείου.
- Πατήστε OK (B6) για να ξεκινήσει η παροχή (εικ. 23). Η συσκευή παρέχει αυτόματα καφέ και γάλα διαδοχικά.

## Καθαρισμός του Lattecrema System μετά από κάθε χρήση:

- Αφήστε το δοχείο γάλακτος συνδεδεμένο στη μηχανή (δεν είναι απαραίτητο να το αδειάσετε). Τοποθετήστε ένα δοχείο κάτω από τον σωλήνα παροχής γάλακτος (D4) (εικ. 34).
- Περιστρέψτε τον διακόπτη (D5) στο «Clean» (εικ. 35).

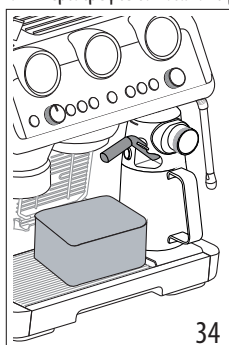





- Ο καθαρισμός ξεκινά και έπειτα σταματά αυτόματα. Προσοχή: στο τέλος του καθαρισμού, περιστρέψτε τον διακόπτη σε μία από τις θέσεις ρύθμισης αφρού.
- Αφαιρέστε το δοχείο γάλακτος και ξαναβάλτε το στο ψυγείο: συνιστάται η χρήση του υπόλοιπου γάλακτος εντός σύντομου χρονικού διαστήματος.

Για ένα βαθύ καθαρισμό, συνιστάται η χρήση του Eco MultiClean: εξασφαλίζει την υγιεινή αφαιρώντας τις πρωτεΐνες και τα λίπη του γάλακτος και μπορεί να χρησιμοποιηθεί για τον καθαρισμό ολόκληρης της μηχανής.

## 6. ΕΞΑΤΟΜΙΚΕΥΣΗ ΤΗΣ ΠΟΣΟΤΗΤΑΣ ΤΩΝ ΡΟΦΗΜΑΤΩΝ ΚΑΦΕ ΜΕ ΤΟ ΚΟΥΜΠΙ (my) (B9)







- Ετοιμάστε τη μηχανή για την παροχή 1 ή 2 φλιτζανιών του ροφήματος καφέ που επιθυμείτε, μέχρι να συνδεθεί η θήκη του φίλτρου (C1) μαζί με το φίλτρο (C2) ή (C3) τον αλεσμέ-

Ρόφημα	Espresso	Γάλα	Αφρός	Ποσότητα (ml)	X2 (ml)
Cappuccino	1	✓	✓	≈150	≈230
Latte Macchiato	1	✓	×	≈150	≈230











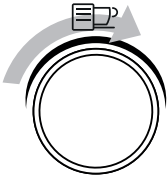







- να καφέ. Αν επιθυμείτε να προγραμματίσετε ένα ρόφημα με βάση το γάλα, συνδέστε το Lattecrema System στη μηχανή.
- Περιστρέψτε τον διακόπτη (B10) για να επιλέξετε το ρόφημα που θα προγραμματίσετε.
  - Πατήστε το κουμπί : η λυχνία που αντιστοιχεί στο κουμπί OK (B6) παραμένει σταθερά αναμμένη ενώ η λυχνία που αντιστοιχεί στο κουμπί  αναβοσβήνει.
  - Πατήστε το κουμπί OK για να ξεκινήσει η παροχή. Οι λυχνίες που αντιστοιχούν στα κουμπιά OK και  αναβοσβήνουν.
  - Μόλις επιτευχθεί η επιθυμητή ποσότητα, πατήστε OK. Αν το ρόφημα προβλέπει την παροχή και κάποιου άλλου συστατικού, ξεκινά η παροχή αυτού: μόλις επιτευχθεί η επιθυμητή ποσότητα, πατήστε OK.
  - Πατήστε το κουμπί  για αποθήκευση. Η συσκευή είναι έτοιμη για νέα χρήση και η λυχνία  παραμένει αναμμένη. Αν δεν επιθυμείτε να αποθηκεύσετε τον προγραμματισμό, πατήστε οποιοδήποτε άλλο κουμπί.

#### Σημαντικό:

- Μπορείτε να προγραμματίσετε τα ροφήματα καφέ, αλλά όχι την παροχή ατμού και ζεστού νερού.
- Ο προγραμματισμός αλλάζει τις ποσότητες των ροφημάτων, αλλά όχι του αλεσμένου καφέ.
- Τα ροφήματα «X2» μπορούν να προγραμματιστούν ξεχωριστά.
- Το **My LatteArt**  δεν μπορεί να προγραμματιστεί.
- Για να επιστρέψετε στις εργοστασιακές ρυθμίσεις, κρατήστε πατημένο το κουμπί  μέχρι να γίνει απενεργοποίηση. Το επιλεγμένο ρόφημα επανέρχεται στην εργοστασιακή ποσότητα.

Συνταγή καφέ	Εργοστασιακή ποσότητα	Προγραμματιζόμενη ποσότητα
 Espresso	35 ml	από 25 έως 90 ml
 Espresso X2	70 ml	από 50 έως 180 ml
 Coffee	80 ml	από 50 έως 120 ml
 Coffee X2	160 ml	από 120 έως 240 ml
 Americano	120 ml	<ul style="list-style-type: none"> <li>espresso: από 25 έως 60 ml</li> <li>νερό: από 25 έως 120 ml</li> </ul>
 Americano X2	240 ml	<ul style="list-style-type: none"> <li>espresso: από 50 έως 120 ml</li> <li>νερό: από 50 έως 240 ml</li> </ul>

## 7. ΜΕΝΟΥ ΡΥΘΜΙΣΕΙΣ

1. Μπίε στο μενού:		
Πατήστε ταυτόχρονα για 5 δευτερόλεπτα	x2	
2. Επιλέξτε τη ρύθμιση που θα προγραμματίσετε:		
		
Ρόφημα	Αντίστοιχη ρύθμιση	Ρυθμίσεις
 Espresso	Εξοικονόμηση ενέργειας	 →  <b>Ενεργό</b>
		 →  <b>Ανενεργό</b>
 Coffee	Αυτόματο σβήσιμο	 → <b>9 λεπτά</b>
		 → <b>1,5 ώρα</b>
		 → <b>3 ώρες</b>
 Cappuccino	Ακουστικό σήμα	 →  <b>Ενεργό</b>
		 →  <b>Ανενεργό</b>
 Latte	Έξτρα ρύθμιση της άλεσης	 → <b>Πεδίο 1</b>
		 → <b>Πεδίο 2</b>
 Flat White	Εργοστασιακές ρυθμίσεις	Κρατήστε πατημένο για τουλάχιστον 5 δευτερόλεπτα το κουμπί OK, έως ότου η λυχνία παραμείνει σταθερά αναμμένη
		→

	<b>Σκληρότητα νερού</b>	→ <b>μαλακό</b>
		→ <b>μέτριο</b>
		→ <b>σκληρό/πολύ σκληρό</b>
<b>3. Αποθηκεύστε τις νέες ρυθμίσεις πατώντας ON/Standby (B1)</b>		

## 8. ΚΑΘΑΡΙΣΜΟΣ ΤΗΣ ΣΥΣΚΕΥΗΣ

### Προσοχή!

- Για τον καθαρισμό της μηχανής, μη χρησιμοποιείτε διαλυτές ή διαβρωτικά απορρυπαντικά ή αλκοόλ.
- Μη χρησιμοποιείτε μεταλλικά αντικείμενα για να αφαιρέσετε τα άλατα ή τα κατακάθια καφέ γιατί μπορεί να γρατζουνιστούν οι μεταλλικές ή πλαστικές επιφάνειες.
- Σε περίπτωση μη χρήσης για πάνω από μία εβδομάδα συνιστάται, προτού χρησιμοποιήσετε τη μηχανή, να προβείτε σε ξέβγαλμα.

### Κίνδυνος!

- Κατά τον καθαρισμό, μη βυθίζετε ποτέ τη συσκευή σε νερό: είναι ηλεκτρική συσκευή.
- Πριν από οποιαδήποτε εργασία καθαρισμού των εξωτερικών μερών της συσκευής, σβήστε τη μηχανή, αποσυνδέστε το φις από την πρίζα του ρεύματος και αφήστε τη μηχανή να κρυώσει.

	×	✓	✓	×	×
	✓	×	×	✓	✓
	×	×	×	✓	✓
→					

	×	×	×	✓	✓
	×	×	✓	✓	×
	×	×	×	✓	✓
	✓	✓	×	✓	✓

## 8.1 Καθαρισμός του ακροφυσίου καφέ

Όταν ανάβει η λυχνία (πορτοκαλί) (B5), είναι απαραίτητο να προχωρήσετε στον καθαρισμό του κυκλώματος του καφέ. Για να εκτελέσετε τον κύκλο καθαρισμού, προμηθευτείτε τις ταμπλέτες καθαρισμού για μηχανή καφέ. Για περισσότερες πληροφορίες, επισκεφθείτε το [www.Delonghi.com](http://www.Delonghi.com).

1. Τοποθετήστε το φίλτρο 1 φλιτζανιού (C2) στη θήκη του φίλτρου (C1) (εικ. 36).
2. Τοποθετήστε στο φίλτρο το εξάρτημα καθαρισμού (C9) (εικ. 36) και πιέστε το καλά.

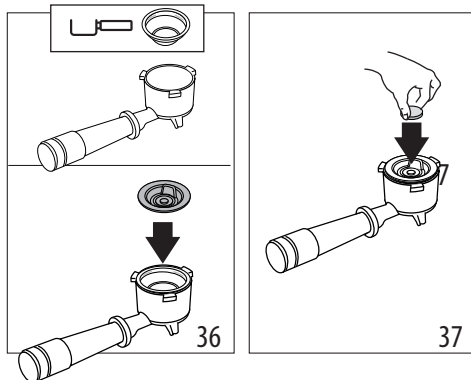

3. Εισάγετε την ταμπλέτα καθαρισμού στο εξάρτημα (εικ. 37).
  4. Συνδέστε τη θήκη του φίλτρου στο ακροφύσιο καφέ (A7).
  5. Γεμίστε το δοχείο νερού (A15). Βεβαιωθείτε ότι ο δίσκος συλλογής σταγόνων (A11) είναι άδειος.
  6. Κρατήστε πατημένο το κουμπί , έως ότου η αντίστοιχη λυχνία αρχίσει να αναβοσβήνει (πορτοκαλί). Ύστερα από μερικά λεπτά, ο καθαρισμός σταματά αυτόματα.
- Αφαιρέστε τη θήκη του φίλτρου και το εξάρτημα καθαρισμού.

- Πλύνετε τη θήκη του φίλτρου και το φίλτρο με νερό βρύσης.
- Ξαναβάλτε τη θήκη του φίλτρου και προχωρήστε σε ένα ξέβγαλμα πατώντας το κουμπί  (B5): συνιστάται η τοποθέτηση ενός δοχείου κάτω από τη θήκη του φίλτρου.
- Αφαιρέστε και αδειάστε τον δίσκο συλλογής σταγόνων.

#### Σημείωση:

Αυτός ο κύκλος καθαρισμού μπορεί να ξεκινήσει οποιαδήποτε στιγμή πατώντας τον κουμπί  (B5) για μερικά δευτερόλεπτα. Για να ακυρώσετε την ενέργεια, πατήστε το κουμπί για 10 δευτερόλεπτα.

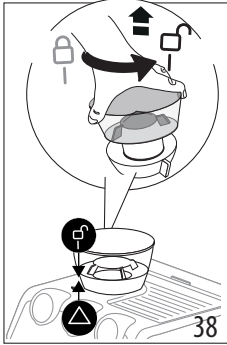

### 8.2 Καθαρίστε την υποδοχή του δοχείου για κόκκους

1. Βεβαιωθείτε ότι το δοχείο για κόκκους (A1) είναι άδειο. Ενδεχομένως εκτελέστε μερικές αλέσεις εν κενώ για να το αδειάσετε.
2. Αποσυνδέστε το δοχείο περιστρέφοντάς το αριστερόστροφα και τραβήξτε το από τη μηχανή (εικ. 38)

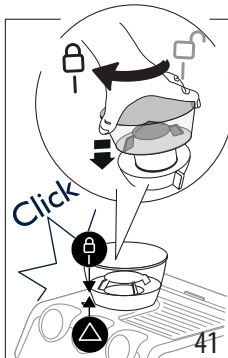
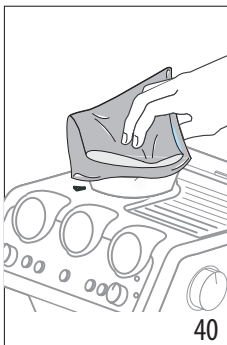

3. Αναρροφήστε τα υπολείμματα του καφέ (εικ. 39)
4. Καθαρίστε με ένα υγρό πανί την υποδοχή του δοχείου κόκκων και στεγνώστε (εικ. 40).



5. Επανασυνδέστε το δοχείο τοποθετώντας το στον μύλο του καφέ. Το δοχείο τοποθετείται σωστά όταν το βέλος  είναι ευθυγραμμισμένο με το σύμβολο  και ακούγεται ένα «κλικ» (εικ. 41).

### 8.3 Καθαρισμός των μύλων

Όταν καθαρίζετε το δοχείο των κόκκων (A1), καθαρίζετε την υποδοχή του δοχείου και τον μύλο στο πάνω μέρος με ένα υγρό πανί. Απευθυνθείτε σε ένα κέντρο υποστήριξης για να αφαιρέσετε και να αντικαταστήσετε τους μύλους άλεσης.

Μπορείτε να αφαιρέσετε τον μύλο άλεσης σε περίπτωση που ο μύλος του καφέ μπλοκάρει εξαιτίας κάποιου ξένου σώματος. Εάν συμβεί κάτι τέτοιο, αφαιρέστε το δοχείο για κόκκους και προχωρήστε ως εξής:

1. Συνδέστε το κύπελλο θήκης φίλτρου (C1) και εκτελέστε μια αλέση «εν κενώ» για να ελευθερωθεί η διόδος του καφέ.
2. Απευθροποιήστε τη συσκευή.
3. Περιστρέψτε αριστερόστροφα τον ρυθμιστή άλεσης μέχρι το τέρμα, στη θέση «REMOVE» (εικ. 42).

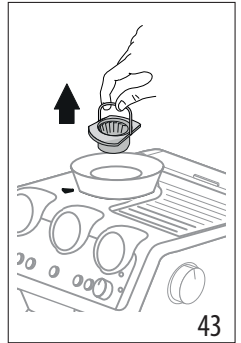
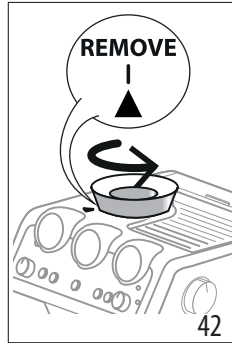

4. Αφαιρέστε το πάνω μέρος του μύλου, πιάνοντάς το καλά από την ειδική λαβή (εικ. 43).
5. Καθαρίστε τον μύλο με ένα πινέλο (εικ. 44) και αναρροφήστε το υπόλειμμα καφέ με μια ηλεκτρική σκούπα (εικ. 39).

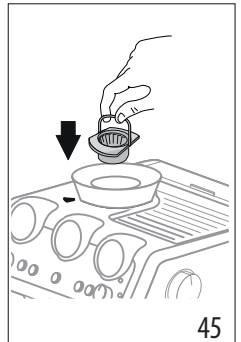
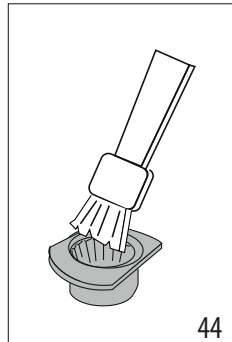

6. Εισάγετε τον μύλο στη θέση του (εικ. 45).
7. Περιστρέψτε τον ρυθμιστή επιλέγοντας τον βαθμό άλεσης που επιθυμείτε (εικ. 13).

Βεβαιωθείτε ότι ο μύλος έχει τοποθετηθεί σωστά, τραβώντας τον από τη λαβή: ο μύλος έχει τοποθετηθεί σωστά όταν αυτός δεν κινείται.

### 8.4 Αντικατάσταση των μύλων

Όταν η ποσότητα του αλεσμένου καφέ μειωθεί κι άλλο, απευθυνθείτε σε ένα κέντρο υποστήριξης για να αντικαταστήσετε τους μύλους άλεσης: έπειτα ρυθμίστε εκ νέου τον μύλο του καφέ μπαίνοντας στο μενού Ρυθμίσεις («7. ΜΕΝΟΥ ΡΥΘΜΙΣΕΙΣ») και επιλέγοντας το πρώτο πεδίο της έξτρα ρύθμισης της άλεσης. Έπειτα, περιστρέψτε το κουμπί ρύθμισης ποσότητας (B2) στη θέση MIN και ρυθμίστε τη δόση όπως κατά την πρώτη χρήση (δείτε «Η «τέλεια δόση»»).

### 8.5 Καθαρισμός του «Smart tamping station»

1. Καθαρίστε την περιοχή σύνδεσης με ένα πινέλο (εικ. 46).
2. Τραβήξτε τον μοχλό (A20) μέχρι το τέρμα, καθαρίστε το πατητήρι με ένα πινέλο (εικ. 47) και έπειτα αφήστε τον μοχλό.
3. Με ένα σκουπάκι (C8), καθαρίστε την έξοδο του καφέ (εικ. 48).

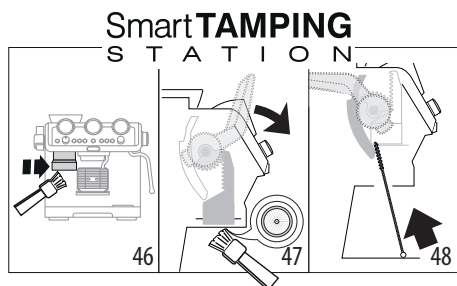

### 8.6 Καθαρισμός του LatteCrema System

Πλύνετε σε πλυντήριο πιάτων όλα τα εξαρτήματα και το δοχείο, τοποθετώντας τα στο πάνω καλάθι του πλυντηρίου πιάτων. Εάν δεν διαθέτετε πλυντήριο πιάτων, πλύντέ τα στο χέρι σύμφωνα με τις οδηγίες της σημείωσης στο τέλος της παραγράφου.

1. Πατήστε το κουμπί (D3) και σηκώστε το καπάκι του δοχείου γάλακτος (D1).
2. Αφαιρέστε το ακροφύσιο γάλακτος (D4) και τον σωλήνα αναρρόφησης (D7) (εικ. 49).

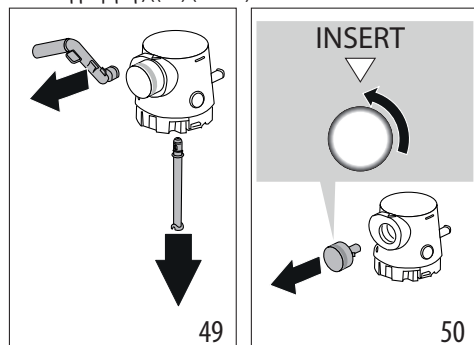

3. Περιστρέψτε στη θέση «Insert» το κουμπί και αφαιρέστε το (εικ. 50).
4. Προσέξτε ιδιαίτερα στην εσοχή και στην εγκοπή κάτω από το κουμπί (εικ. 51) να μην παραμείνουν υπολείμματα γάλακτος: αν χρειάζεται ξύστε την εγκοπή με μια οδοντογλυφίδα.

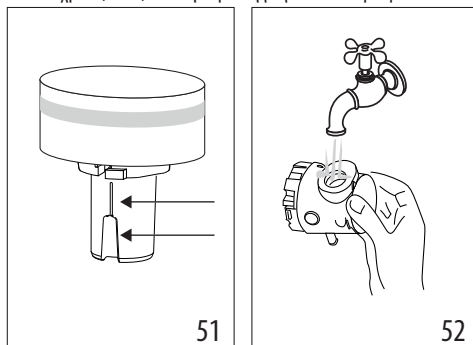

5. Ξεπλύνετε το εσωτερικό της θέσης του κουμπιού ρύθμισης αφρού με τρεχούμενο νερό (εικ. 52).
6. Βεβαιωθείτε επίσης ότι ο σωλήνας αναρρόφησης και ο σωλήνας παροχής δεν έχουν βουλώσει από υπολείμματα γάλακτος.
7. Επανασυναρμολογήστε όλα τα εξαρτήματα του καπακιού.
8. Πλύνετε και ξεβγάλετε καλά το δοχείο γάλακτος (D8).
9. Ασφαλίστε εκ νέου το καπάκι στο δοχείο γάλακτος.

### Σημείωση: πλύσιμο στο χέρι

Το πλύσιμο σε πλυντήριο πιάτων εξασφαλίζει την άριστη υγιεινή όλων των εξαρτημάτων του δοχείου γάλακτος: σε περίπτωση πλυσίματος στο χέρι, πλύνετε προσεκτικά όλα τα εξαρτήματα του δοχείου γάλακτος με ζεστό νερό και βυθίστε τα σε μια λεκάνη με ζεστό νερό αφήνοντάς τα για περίπου 30 λεπτά, προτού προχωρήσετε στις ενέργειες που αναφέρονται στο σημείο 4.

### 9. ΣΚΛΗΡΟΤΗΤΑ ΝΕΡΟΥ

Η λυχνία  (B8) αφαλάτωσης ανάβει μετά από ένα προκαθορισμένο διάστημα λειτουργίας που εξαρτάται από τη σκληρότητα του νερού. Μπορείτε να προγραμματίσετε τη μηχανή βάσει της πραγματικής σκληρότητας του νερού στις αντίστοιχες περιοχές, κάνοντας λιγότερο τακτική, με τον τρόπο αυτό, τη διαδικασία αφαλάτωσης.

1. Βγάλετε από τη συσκευασία της την ταινία αντίδρασης «TOTAL HARDNESS TEST» (C4).
2. Βυθίστε την εντελώς σε ένα ποτήρι νερό για ένα δευτερόλεπτο περίπου.
3. Αφαιρέστε την ταινία από το νερό και τινάξτε την ελαφρά. Ρυθμίστε τη συσκευή όπως υποδεικνύεται στο κεφάλαιο «7. ΜΕΝΟΥ ΡΥΘΜΙΣΕΙΣ».

Αποτέλεσμα Σκληρότητας Νερού	Δοκιμή	Κουμπί	Στάθμη
		x2	1 μαλακό νερό
			2 μέτριο νερό
		OK	3 σκληρό ή πολύ σκληρό νερό

4. Ρυθμίστε τη συσκευή όπως υποδεικνύεται στο κεφάλαιο «7. ΜΕΝΟΥ ΡΥΘΜΙΣΕΙΣ».

## 10. ΠΩΣ ΝΑ ΧΡΗΣΙΜΟΠΟΙΗΣΕΤΕ ΤΑ SOFTBALLS

Τα Softballs (C11) είναι ένα καινοτόμο σύστημα που επιμηκύνει τη διάρκεια ζωής της μηχανής, χωρίς να αλλοιώνει την ποιότητα του νερού, εξασφαλίζοντας έναν κρεμώδη και αρωματικό καφέ. Για να βελτιστοποιήσετε την αποτελεσματικότητα, αφήστε τα Softballs στο νερό για μια ολόκληρη νύχτα πριν από τη χρήση.

1. Βγάλτε το πακέτο με τα Softballs μέσα από τη συσκευασία (εικ. 53).

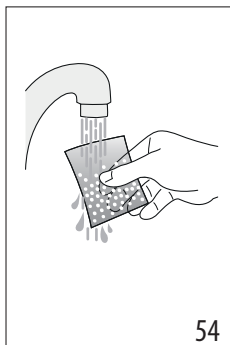
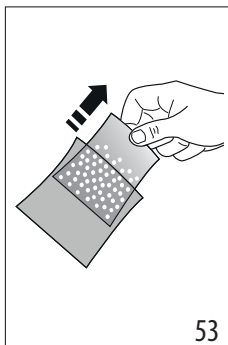

2. Ξεπλύνετε με νερό βρύσης το πακέτο με τα Softballs (εικ. 54).
3. Βυθίστε το σακουλάκι μέσα στο δοχείο νερού (A15) (εικ. 55).

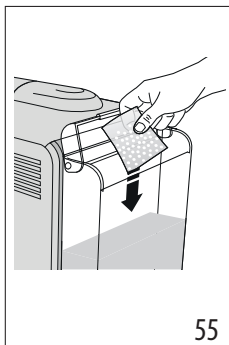

55



56

4. Αντικαθιστάτε το σακουλάκι με τα Softballs κάθε 3 μήνες (εικ. 56).

## 11. ΑΦΑΛΑΤΩΣΗ

### Προσοχή!

- Πριν από τη χρήση, διαβάστε τις οδηγίες και την ετικέτα του αφαλατικού (C5) που αναγράφονται στη συσκευασία του.
- Συνιστάται η αποκλειστική χρήση υγρών καθαρισμού αλάτων De'Longhi. Η χρήση των ακατάλληλων προϊόντων αφαλάτωσης, όπως και η ίδια η αφαλάτωση που δεν εκτελείται τακτικά, μπορεί να δημιουργήσει βλάβες που δεν καλύπτει η εγγύηση του κατασκευαστή.
- Το αφαλατικό υγρό ενδέχεται να προκαλέσει ζημιά στις ευαίσθητες επιφάνειες. Αν το προϊόν αναποδογυρίσει κατά λάθος, στεγνώστε αμέσως.

### Για εκτέλεση αφαλάτωσης

Αφαλατικό	Αφαλατικό De'Longhi
Δοχεία	2 του 1 λίτρου το καθένα
Χρόνος	~40 λεπτά

1. (ΑΝ ΥΠΑΡΧΕΙ, ΑΦΑΙΡΕΣΤΕ ΤΟ ΦΙΛΤΡΟ ΑΠΟΣΚΛΗΡΥΝΣΗΣ ΚΑΙ ΤΑ SOFTBALLS). Ρίξτε στο δοχείο νερού (A15) το αφαλατικό μέχρι το επίπεδο A (αντιστοιχεί σε μια συσκευασία των 100ml), το οποίο είναι τυπωμένο στην εσωτερική πλευρά του δοχείου (εικ. 57).

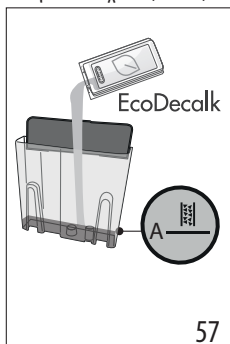

57

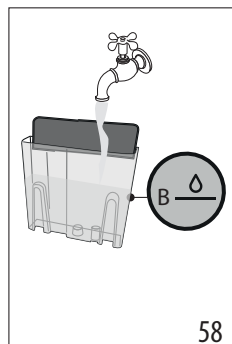



58



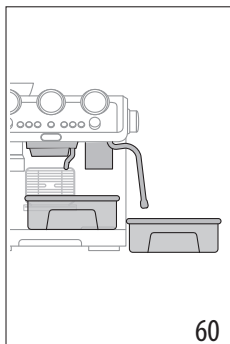
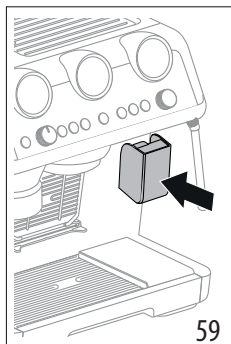

2. Προσθέστε νερό μέχρι να φτάσει στο επίπεδο  B (εικ. 58). Στη συνέχεια ξαναβάλτε το δοχείο νερού στη μηχανή.
3. Εισάγετε το εξάρτημα (C6) στον σύνδεσμο του LatteCrema System (A6) (εικ. 59).



4. Βεβαιωθείτε ότι η θήκη φίλτρου (C1) δεν είναι συνδεδεμένη και τοποθετήστε ένα δοχείο κάτω από τα ακροφύσια καφέ και ζεστού νερού (A7), και κάτω από το ακροφύσιο ατμού (A5) (εικ. 60).
  5. Κρατήστε πατημένο το κουμπί  (B8) έως ότου η αντίστοιχη λυχνία αρχίσει να αναβοσβήνει.
  6. Το πρόγραμμα αφαλάτωσης ξεκινά και το αφαλατικό υγρό βγαίνει από τα ακροφύσια. Το πρόγραμμα αφαλάτωσης εκτελεί αυτόματα μια σειρά από ξεβγάλματα ανά διαστήματα, για να αφαιρέσετε τα υπολείμματα αλάτων από το εσωτερικό της μηχανής του καφέ μέχρι να αδειάσει το δοχείο.
- Η παροχή διακόπτεται και η λυχνία  γίνεται άσπρη. Στη συνέχεια είναι απαραίτητο να προχωρήσετε στον κύκλο ξεβγάλματος:
7. Αδειάστε το δοχείο που χρησιμοποιείται για τη συλλογή του υγρού αφαλάτωσης και τοποθετήστε το ξανά κάτω από τα ακροφύσια.
  8. Αφαιρέστε το δοχείο νερού, αδειάστε το από τυχόν υπολείμματα αφαλατικού διαλύματος, ξεπλύνετε το με νερό βρύσης

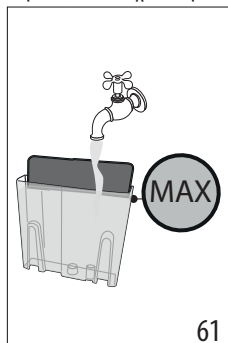

και γεμίστε το με φρέσκο νερό μέχρι το επίπεδο MAX (εικ. 61). Τοποθετήστε ξανά το δοχείο στη θέση του.





9. Κρατήστε πατημένο το κουμπί  έως ότου η αντίστοιχη λυχνία αρχίσει να αναβοσβήνει: το ξεβγάλημα ξεκινά.
10. Μόλις ολοκληρωθεί το ξεβγάλημα, η παροχή σταματά και η συσκευή είναι έτοιμη για χρήση.
11. Αδειάστε τα δοχεία συλλογής του νερού ξεβγάλματος.
12. Αφαιρέστε και αδειάστε το δοχείο συλλογής σταγόνων και στη συνέχεια εισάγετέ το ξανά.
13. Αφαιρέστε και γεμίστε το δοχείο με φρέσκο νερό, και στη συνέχεια τοποθετήστε το ξανά.











Η μηχανή τώρα είναι έτοιμη για χρήση.

#### Σημαντικό:











- Αν επιθυμείτε να εκτελέσετε εκ των προτέρων τον κύκλο αφαλάτωσης, κρατήστε πατημένο το κουμπί  για 3 δευτερόλεπτα.
- Σε περίπτωση που η αφαλάτωση έχει ξεκινήσει κατά λάθος, πατήστε το κουμπί  για 10 δευτερόλεπτα. Το ξεβγάλημα δεν μπορεί να διακοπεί.

## 12. ΕΠΕΞΗΓΗΣΗ ΤΩΝ ΛΥΧΝΙΩΝ

ΛΥΧΝΙΕΣ	ΕΠΕΞΗΓΗΣΗ ΤΩΝ ΛΥΧΝΙΩΝ	ΕΝΕΡΓΕΙΑ
Όλες οι λυχνίες αναβοσβήνουν σύντομα	Έναρξη της μηχανής	Αυτοδιάγνωση
 σταθερή	Είναι η πρώτη εκκίνηση λειτουργίας της μηχανής και πρέπει να γεμίσετε το κύκλωμα νερού	Προχωρήστε σύμφωνα με τις υποδείξεις του κεφ. «3. ΑΡΧΙΚΗ ΛΕΙΤΟΥΡΓΙΑ ΤΗΣ ΣΥΣΚΕΥΗΣ»
 σταθερή	Η λειτουργία εξοικονόμησης ενέργειας είναι ενεργή	Ανατρέξτε στο κεφ. «7. ΜΕΝΟΥ ΡΥΘΙΣΕΙΣ» αν επιθυμείτε να απενεργοποιήσετε τη λειτουργία
		→



ΛΥΧΝΙΕΣ	ΕΠΕΞΗΓΗΣΗ ΤΩΝ ΛΥΧΝΙΩΝ	ΕΝΕΡΓΕΙΑ
 σταθερή	Το δοχείο κόκκων (A1) είναι άδειο	Γεμίστε το δοχείο των κόκκων
 αναβοσβήνει	Θέλετε να προχωρήσετε στην άλεση, αλλά το δοχείο κόκκων (A1) είναι άδειο	Γεμίστε το δοχείο των κόκκων
 ενεργή	Το νερό στο δοχείο (A15) δεν είναι αρκετό ή το δοχείο νερού δεν έχει τοποθετηθεί σωστά	Γεμίστε το δοχείο ή αφαιρέστε και τοποθετήστε ξανά και σωστά το δοχείο
 αναβοσβήνει	Θέλετε να προχωρήσετε στην παρασκευή ενός ροφήματος, αλλά το δοχείο νερού (A15) είναι άδειο	Γεμίστε το δοχείο νερού
 σταθερή	Γενικός συναγερμός	Απευθυνθείτε σε κέντρο τεχνικής υποστήριξης
 σταθερή	Το δοχείο για κόκκους δεν έχει τοποθετηθεί	Τοποθετήστε σωστά το δοχείο για κόκκους (A1) ή επιβεβαιώστε ότι έχει τοποθετηθεί σωστά
 αναβοσβήνει	Ο επιλογέας, στη βάση του δοχείου για κόκκους (A1), δεν είναι στη σωστή θέση	Τοποθετήστε τον επιλογέα σε μία από τις θέσεις άλεσης (μεταξύ 1 και 8) και θυμηθείτε: <ul style="list-style-type: none"> <li>• Να ρυθμίζετε την άλεση ενώ ο μύλος του καφέ βρίσκεται σε λειτουργία</li> <li>• Να ρυθμίζετε ένα επίπεδο τη φορά και να εκτελείτε τουλάχιστον 5 αλέσεις μεταξύ της μιας ρύθμισης και της άλλης</li> </ul>
	Το δοχείο για κόκκους (A1) δεν έχει τοποθετηθεί πλήρως: παρεμβαίνει η διάταξη ασφαλείας	Επαληθεύστε ότι το δοχείο για κόκκους έχει τοποθετηθεί σωστά
 σταθερή	Το LatteCrema System πρέπει να καθαρίζεται μετά από κάθε χρήση	Αφού ολοκληρωθούν οι παρασκευές με βάση το γάλα, προχωρήστε σε αυτόματο καθαρισμό περιστρέφοντας το κουμπί (D5) στο Clean
 σταθερή	Η συσκευή είναι έτοιμη για την παροχή ατμού.	Η συσκευή έχει φτάσει στην κατάλληλη θερμοκρασία για την παροχή ατμού. Για να προχωρήσετε στην παροχή, περιστρέψτε τον διακόπτη ατμού (A4)
 αναβοσβήνει	Η συσκευή είναι αναμμένη και η λειτουργία εξοικονόμησης ενέργειας είναι ενεργή: το κουμπί του ατμού (A4) είναι σε θέση για την παροχή ατμού	Το φως αναβοσβήνει για να δείξει ότι η συσκευή ετοιμάζεται να διανείμει ατμό: η διανομή ξεκινά μόλις η μονάδα είναι στη σωστή θερμοκρασία
	Η συσκευή είναι έτοιμη για την παροχή ατμού	Η συσκευή είναι σε κατάλληλη θερμοκρασία για την παροχή ατμού όταν η λυχνία παραμένει σταθερά αναμμένη
	Η συσκευή παρέχει ατμό	



ΛΥΧΝΙΕΣ	ΕΠΕΞΗΓΗΣΗ ΤΩΝ ΛΥΧΝΙΩΝ	ΕΝΕΡΓΕΙΑ
 σταθερή (πορτοκαλί)	Θα πρέπει να προχωρήσετε σε καθαρισμό των αλάτων	Προχωρήστε σε αφαλάτωση σύμφωνα με τις υποδείξεις του κεφ. «11. ΑΦΑΛΑΤΩΣΗ»
 αναβοσβήνει (πορτοκαλί)	Η μηχανή εκτελεί αφαλάτωση	Προχωρήστε ολοκληρώνοντας την διαδικασία όπως περιγράφεται στο κεφ. «11. ΑΦΑΛΑΤΩΣΗ»
 σταθερή (άσπρη)	Είναι απαραίτητο να προχωρήσετε σε ξέβγαλμα	
 αναβοσβήνει (άσπρη)	Η συσκευή εκτελεί το ξέβγαλμα	
 σταθερή (πορτοκαλί)	Είναι απαραίτητο να προχωρήσετε στον καθαρισμό του ακροφυσίου καφέ	Δείτε παρ. «8.1 Καθαρισμός του ακροφυσίου καφέ»
 αναβοσβήνει (πορτοκαλί)	Η συσκευή εκτελεί τον καθαρισμό του ακροφυσίου καφέ	
 αναβοσβήνει (άσπρη)	Η συσκευή εκτελεί ένα ξέβγαλμα	
 +  αναβοσβήνει	<p>Αν υπάρχει φίλτρο αποσκλήρυνσης, ενδέχεται να έχει εισχωρήσει κάποια φυσαλίδα αέρα στο κύκλωμα, εμποδίζοντας την παροχή</p> <p>Η άλεση είναι πολύ λεπτή και επομένως ο καφές βγαίνει πολύ αργά ή δεν βγαίνει καθόλου.</p> <p>Το φίλτρο καφέ (C2) ή (C3) έχει βουλώσει</p> <p>Το δοχείο (A15) δεν έχει τοποθετηθεί σωστά και οι αντίστοιχες βαλβίδες δεν έχουν ανοίξει</p> <p>Άλατα μέσα στο υδραυλικό κύκλωμα</p>	<p>Πατήστε το κουμπί (B7) που αντιστοιχεί στη λυχνία  : η παροχή ξεκινά και σταματά αυτόματα.</p> <p>Αφαιρέστε το κύπελλο θήκης φίλτρου (C1), επαναλάβετε τις ενέργειες παρασκευής του καφέ λαμβάνοντας υπόψη τις υποδείξεις της παρ. «4.1 Στάδιο 1 - Άλεση (grinding) (εικ. 11)» και «4.2 Στάδιο 2 - Πάτημα (tamping) (εικ. 17)»</p> <p>Ξεβγάλετε τα φίλτρα με νερό βρύσης ή εκτελέστε ένα ξέβγαλμα πατώντας το σχετικό κουμπί (B5).</p> <p>Πιέστε ελαφρώς το δοχείο έτσι ώστε να ανοίξουν οι βαλβίδες του</p> <p>Προχωρήστε σε αφαλάτωση όπως αναφέρει το κεφ. «11. ΑΦΑΛΑΤΩΣΗ»</p>

### 13. ΑΝ ΚΑΤΙ ΔΕΝ ΛΕΙΤΟΥΡΓΕΙ

ΠΡΟΒΛΗΜΑ	ΑΙΤΙΑ	ΕΠΙΛΥΣΗ
Υπάρχει νερό μέσα στον δίσκο συλλογής σταγόνων (A11)	Οφείλεται σε φυσιολογική λειτουργία των εσωτερικών κυκλωμάτων της μηχανής	Αδειάζετε και πλένετε τακτικά τον δίσκο συλλογής σταγόνων (A11)
		→

<b>ΠΡΟΒΛΗΜΑ</b>	<b>ΑΙΤΙΑ</b>	<b>ΕΠΙΛΥΣΗ</b>
Δε βγαίνει πλέον ο καφές εσπρέσο	Έλλειψη νερού στο δοχείο (A15)	Γεμίστε το δοχείο
	Η λυχνία  (B7) ανάβει υποδεικνύοντας ότι το κύκλωμα του καφέ ή το κύκλωμα του ατμού είναι άδειο.	Πατήστε το κουμπί που αντιστοιχεί στη λυχνία  για να γεμίσετε το κύκλωμα.
	Το φίλτρο (C2) ή (C3) είναι βουλωμένο	Ξεπλύνετε τα φίλτρα με νερό βρύσης ή εκτελέστε ένα ξέβγαλμα πατώντας το αντίστοιχο κουμπί (B5)
	Το δοχείο (A15) δεν έχει τοποθετηθεί σωστά και οι βαλβίδες στη βάση του δεν είναι ανοιχτές	Πιέστε ελαφρά το δοχείο έτσι ώστε να ανοίξει τις βαλβίδες στη βάση του
	Άλατα μέσα στο υδραυλικό κύκλωμα	Προχωρήστε σε αφαλάτωση όπως αναφέρει το κεφ. «11. ΑΦΑΛΑΤΩΣΗ»
	Πολύ λεπτή άλεση	Αφαιρέστε το κύπελλο θήκης φίλτρου (C1), επαναλάβετε τις ενέργειες παρασκευής του καφέ λαμβάνοντας υπόψη τις υποδείξεις της παρ. «4.1 Στάδιο 1 - Άλεση (grinding) (εικ. 11)» και «4.2 Στάδιο 2 - Πάτημα (tamping) (εικ. 17)»
Η θήκη του φίλτρου δεν στερεώνεται στη μηχανή	Ο αλεσμένος καφές δεν έχει πατηθεί ή είναι σε υπερβολική ποσότητα	Επαναλάβετε την άλεση με διαφορετικές ρυθμίσεις. Μειώστε την ποσότητα της δόσης: επιβεβαιώστε ότι το φίλτρο (C2) ή (C3) (1 ή 2 φλιτζάνια) είναι σωστό σε σχέση με τη δόση της άλεσης (κουμπί 2x (B3) επιλεγμένο ή όχι)
Ο καφές espresso στάζει από το χείλος της θήκης του φίλτρου (C1) και όχι από τις οπές	Η θήκη φίλτρου δεν έχει τοποθετηθεί καλά	Στερεώστε σωστά τη θήκη φίλτρου και στρέψτε την μέχρι τέλους με δύναμη
	Το στεγανοποιητικό παρέμβυσμα του ακροφυσίου καφέ (A7) έχασε την ελαστικότητά του ή είναι βρώμικο	Αντικαταστήστε το στεγανοποιητικό παρέμβυσμα του ακροφυσίου καφέ σε ένα Κέντρο Υποστήριξης
	Το φίλτρο (C2) ή (C3) είναι βουλωμένο	Ξεβγάλτε τα φίλτρα με νερό βρύσης ή εκτελέστε ένα ξέβγαλμα πατώντας το σχετικό κουμπί (B5)
Ο αφρός του καφέ είναι ανοιχτόχρωμος (κατεβαίνει γρήγορα από το στόμιο)	Είναι απαραίτητο να ελέγξετε εκ νέου τις ρυθμίσεις της συσκευής	Αφαιρέστε το κύπελλο, επαναλάβετε τις διαδικασίες για να κάνετε τον καφέ λαμβάνοντας υπόψη τις υποδείξεις της παρ. «4.1 Στάδιο 1 - Άλεση (grinding) (εικ. 11)» και «4.2 Στάδιο 2 - Πάτημα (tamping) (εικ. 17)»
		→

<b>ΠΡΟΒΛΗΜΑ</b>	<b>ΑΙΤΙΑ</b>	<b>ΕΠΙΛΥΣΗ</b>
Ο αφρός του καφέ είναι σκουρόχρωμος (ο καφές βγαίνει αργά από το στόμιο)	Είναι απαραίτητο να ελέγξετε εκ νέου τις ρυθμίσεις της συσκευής	Αφαιρέστε το κύπελλο θήκης φίλτρου (C1), επαναλάβετε τις ενέργειες παρασκευής του καφέ λαμβάνοντας υπόψη τις υποδείξεις της παρ. «4.1 Στάδιο 1 - Άλεση (grinding) (εικ. 11)» και «4.2 Στάδιο 2 - Πάτημα (tamping) (εικ. 17)»
Δεν σχηματίζεται αφρόγαλα ενώ εκτελείται παρασκευή cappuccino με το LatteCrema System	Το γάλα δεν είναι αρκετά κρύο	Χρησιμοποιήστε πάντα γάλα σε θερμοκρασία ψυγείου
	Ο διακόπτης (D5) δεν είναι στη σωστή θέση	Επαληθεύστε και περιστρέψτε τον διακόπτη στη σωστή θέση (☺ μέγιστος αφρός (max), ☹ μέτριος αφρός (med), ☺ ελάχιστος αφρός (min) )
	Το LatteCrema System είναι βρώμικο	Προχωρήστε σε καθαρισμό σύμφωνα με τις υποδείξεις της παραγράφου «8.6 Καθαρισμός του LatteCrema System»
	Άλατα μέσα στο υδραυλικό κύκλωμα	Προχωρήστε σε αφαλάτωση όπως αναφέρει το κεφ. «11. ΑΦΑΛΑΤΩΣΗ»
Στο τέλος της αφαλάτωσης, η συσκευή χρειάζεται κι άλλο ξεβγάλμα	Κατά τη διάρκεια του κύκλου ξεβγάλματος, το δοχείο έχει γεμίσει μέχρι στη στάθμη MAX	Επαναλάβετε το ξεβγάλμα (δείτε κεφ. «11. ΑΦΑΛΑΤΩΣΗ»)
Η συσκευή δεν αλέθει τον καφέ	Στο εσωτερικό του μύλου του καφέ υπάρχει κάποιο ξένο σώμα	Προχωρήστε στον καθαρισμό των μύλων όπως υποδεικνύεται στην παρ. «8.3 Καθαρισμός των μύλων», βεβαιωθείτε ότι έχετε αφαιρέσει όλους τους κόκκους από το δοχείο κόκκων (A2) πριν το αφαιρέσετε. Προτού επανατοποθετήσετε τον μύλο άλεσης, αναρροφήστε προσεκτικά τυχόν υπολείμματα από την υποδοχή του
	Το δοχείο για κόκκους (A1) δεν είναι σε σωστή θέση	Το δοχείο τοποθετείται σωστά όταν το βέλος ▲ είναι ευθυγραμμισμένο με το σύμβολο ☺ και ακούγεται ένα «κλικ»
→		

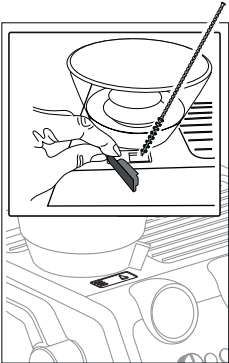
ΠΡΟΒΛΗΜΑ	ΑΙΤΙΑ	ΕΠΙΛΥΣΗ
<p>Αν εάν επιθυμείτε να αλλάξετε ποιότητα καφέ</p>	<p>θα πρέπει να αφαιρέσετε όλους τους κόκκους από τη μηχανή</p>	<ul style="list-style-type: none"> <li>• Αδειάστε το δοχείο για κόκκους (A1) (εκτελώντας αλέσεις εν κενώ ή αναρροφώντας ενδεχομένως τα υπολείμματα των κόκκων).</li> <li>• Συνδέστε το κύπελλο με τη θήκη του φίλτρου (C1) και αλέστε «εν κενώ» για να ελευθερωθεί η διόδος του καφέ: στη συνέχεια συνδέστε τη θήκη του φίλτρου στην έξοδο του μύλου (A18) ευθυγραμμίζοντάς την με την ένδειξη INSERT και περιστρέψτε το κύπελλο προς τα δεξιά (εικ. 22). Η άλεση ξεκινά όταν το κύπελλο φτάσει στη θέση CLOSE και διακόπεται αυτόματα. Επαναλάβετε έως ότου το φίλτρο αδειάσει.</li> <li>• Εισάγετε στο δοχείο (A1) τη νέα ποικιλία κόκκων καφέ</li> <li>• Αν κατά την άλεση δεν επιτυγχάνεται η «τέλεια δόση», προχωρήστε ακριβώς όπως στην πρώτη χρήση</li> </ul>
<p>Μετά την άλεση, το φίλτρο του καφέ (C2) ή (C3) είναι άδειο</p> <p>Μετά την άλεση, η σκόνη του καφέ στο φίλτρο είναι πολύ μεγάλη</p>	<p>Το χωνί του καφέ του μύλου έχει μπουκώσει</p>	<p>Καθαρίστε όπως αναγράφεται στην παρ. «8.5 Καθαρισμός του «Smart tamping station»». Αν το πρόβλημα επιμένει, προσεγγίστε το χωνί ανοίγοντας το ειδικό πορτάκι (A19) και καθαρίστε το χρησιμοποιώντας το βουρτσάκι</p> 
		→

<b>ΠΡΟΒΛΗΜΑ</b>	<b>ΑΙΤΙΑ</b>	<b>ΕΠΙΛΥΣΗ</b>
Μετά την άλεση, η σκόνη του καφέ στο φίλτρο (C2) ή (C3) δεν φτάνει για την «τέλεια δόση»	Το «Smart Tamping Station» χρειάζεται καθαρισμό	Καθαρίστε όπως αναγράφεται στην παρ. «8.5 Καθαρισμός του «Smart tamping station»», και έπειτα επαναλάβετε την άλεση
	Πρέπει να προσαρμόσετε την ποσότητα του αλεσμένου καφέ	Ρυθμίστε την ποσότητα με το ειδικό κουμπί (B2) ακολουθώντας τις ενδείξεις της παρ. «Η «τέλεια δόση»». Αν ο διακόπτης είναι ήδη στη θέση max, προχωρήστε σύμφωνα με τις υποδείξεις στην ενότητα «Εξτρα ρύθμιση της άλεσης»
	Με το χρόνο οι μύλοι φθείρονται	Προχωρήστε σε αντικατάσταση των μύλων άλεσης όπως υποδεικνύεται στην παρ. «8.4 Αντικατάσταση των μύλων»

Før apparatet tas i bruk, les alltid heftet med sikkerhetsadvarsler.

## 1. BESKRIVELSE

### 1.1 Beskrivelse av apparatet - A

- A1. Bønnebeholder
- A2. Lokk på bønnebeholder
- A3. Koppebrett
- A4. Dampbryter
- A5. Damprør
- A6. Kontakt for Lattecrema System
- A7. Kaffeuttak
- A8. Rist for espresso-koppebrett
- A9. Rist for glass- eller muggebrett
- A10. Rist til dryppeskål
- A11. Dryppeskål
- A12. Vannvåindikator for dryppeskål
- A13. Lokk vannbeholder
- A14. Håndtak på vannbeholder
- A15. Vannbeholder
- A16. Tilkobling av strømledning
- A17. Hovedbryter (ON/OFF)
- A18. Utgang kaffekvern (Tamping station)
- A19. Luke som gir tilgang til kaffekverntrakten
- A20. Pressespak

### 1.2 Beskrivelse av kontrollpanel - B

- B1. Bryter ON/Standby
- B2. Bryter for regulering av mengde kvernet kaffe
- B3. "X2"-tast: for bruk av 2-koppfilter
- B4. Kaffetemperaturtast
- B5. Skylltast
- B6. "OK"-tast: for å skille ut drikken / bekrefte valg
- B7. Tast for uttak av varmt vann
- B8. Avkalkingstast
- B9. "My"-tast: brukes til egendefinering av drikkens styrke
- B10. Funksjonsvalg bryter
- B11. Drikke display:

#### Espresso-baserte drikker

- Espresso
- Americano
- Kaffe

#### Melkebaserte drikker

- Cappuccino
- Flat White
- Latte Macchiato

- B12. Lampe "rengjør melk"
- B13. Lampe "mangler kaffebønnebeholder"
- B14. Lampe "generell alarm"
- B15. Manometer
- B16. Lampe "mangler vann"

B17. Lampe "bønnebeholder tom"

B18. Lampe "energisparing"

B19. Display innstillinger og prosess:

- Angir operasjonen som apparatet utfører
- Angir valgt kaffedoseinnstilling
- Angir valgt kaffetemperaturinnstilling

### 1.3 Beskrivelse av tilbehør - C

- C1. Filterkopp
- C2. 1-koppfilter
- C3. 2-koppfilter
- C4. Reagensstrimmel "Total Hardness Test"
- C5. Avkalkingsmiddel
- C6. Tilbehør for avkalking
- C7. Forsyningskabel (avtakbar)
- C8. Spatel
- C9. Tilbehør for rengjøring av kaffeuttak
- C10. Klut
- C11. Softballs (vannavherder)
- C12. Rengjøringsnål for dampdyse

### 1.4 Rengjøringstilbehør medfølger ikke, anbefalt av produsenten

For ytterligere informasjon henvises det til [Delonghi.com](http://Delonghi.com).



#### Rengjøringstablett

(Se "8.1 Rengjøring av kaffeuttaket")

ØEcoMultiClean Renser

EAN: 8004399333307

### 1.5 Beskrivelse av LatteCrema System - D

- D1. Lokk melkebeholder
- D2. Kontakt for melkebeholder
- D3. Utløserknapp for lokk
- D4. Melkedyse (kan reguleres i høyden)
- D5. Skumreguleringsbryter
- D6. Bryterposisjon
- D7. Melkeslange
- D8. Melkebeholder

## 2. KLARGJØRING AV APPARAT

Rengjør i lunkent vann og skånsomt vaskemiddel, og gjør deretter som følger:

1. Sett inn dryppeskålen (A11) komplett med koppebrettrist (A9) og dryppeskålrist (A10) (fig. 1).
2. Trekk ut vannbeholderen (A15) (fig. 2) og fyll den med ferskt og rent vann, og se til at nivåmerkingen med teksten MAX ikke overskrides (fig. 3).
3. Sett deretter inn beholderen igjen.



**OBS!** Apparatet må aldri startes opp uten beholder eller uten at det er vann i beholderen.

**NB:** Vi anbefaler at vannhardheten tilpasses bruksforholdene ved å følge prosedyren i kapittel "7. Programmeringsmeny".

### 3. FØRSTE GANGS OPPSTART AV APPARATET

1. Sett kontakten på strømledningen (C7) inn på baksiden av apparatet (A16) (fig. 4), og sett deretter støpselet inn i stikkontakten. Se til at hovedbryteren (A17), som finnes bak på apparatet er trykket inn i posisjon I (fig. 5).
2. Sett en beholder med kapasitet på minst 100 ml under varmtvannsutaket (samme som kaffeuttaket (A7)) (fig. 6).
3. Trykk på tasten (B7) ved siden av lampen  (fig. 7): tilberedelsen vil starte og stoppe automatisk. Tøm beholderen.

Før man tar maskinen i bruk må de innvendige rørkretsene på maskinen skylles. Gjør som følger:

4. Hekt filterkoppene (C1) komplett med filter på maskinen. For en korrekt fastheking, hold håndtaket til filterkoppene på linje med symbolet INSERT (fig. 8), og drei deretter håndtaket mot høyre, til den står på høyde med posisjonen CLOSE.
5. Sett en beholder under filterkoppene og damputtaksrøret (A5).
6. Trykk på tasten (B5) ved siden av lampen  (fig. 9); tilberedelsen vil starte opp.
7. Når uttaket er ferdig vrir man på dampbryteren (A4) (fig. 10) og slipper ut dam noen sekunder slik at dampkretsen skylles. For et optimalt uttak anbefales det å gjenta denne operasjonen 3 eller 4 ganger. Dette vil gjøre det mulig å fjerne vannet i røret før det slippes ut damp.

Apparatet er nå klart til bruk.

**NB:** Skyllingen av de innvendige kretsene burde utføres også når apparatet ikke har vært i bruk over en lengre periode.

Første gang apparatet brukes må man tilberede 4-5 kaffedrikker før resultatet begynner å bli tilfredsstillende. Vær særlig oppmerksom på kaffemengden som kvernes i filteret ((C2) o (C3)) (se instruksjoner i paragrafen "4.1 Fase 1 - Maling (grinding)" (fig. 11)).

Gjør som vist i kapittel ""Perfekt dose"".

### 4. TILBEREDELSE AV KAFFE

#### 4.1 Fase 1 - Maling (grinding) (fig. 11)

1. Hell bønner i beholderen (A1) (fig. 12). Det anbefales å kun bruke den mengden bønner som er nødvendig for tilberedelsen. På denne måten vil man alltid bruke fersk kaffe.
2. Velg ønsket malegrad (fig. 13). Fabrikkinnstilling er 5 (middels malegrad). Hvis resultatet ikke er tilfredsstillende kan man regulere nivået i henhold til ens egen smak og kaffetypen (regulering må utføres mens kaffekvernen er i funksjon).

3. Sett inn en av kaffefiltrene (C2) eller (C3) i filterholderen (C1) (fig. 14). Hvis det brukes filter for 2 kopper, trykker man på tasten 2X (B3). Med dette valget doubles også mengden espresso.
4. Mengdebryteren (B2) reguleres med utgangspunkt i minste posisjon (fig. 15).

**NB:**



Tallene som vises i displayet (B19) er en referanse som må huskes når man når korrekt nivå i filterholderen.

De samsvarer ikke med malegradinnstillinger, den malte kaffens vekt (gram/oz) eller kvernetider.

Det henvises til paragrafen "B3. "X2"-tast: for bruk av 2-koppfilter" for ytterligere anvisninger.

5. Hekt filterholderen på utgangen for malt kaffe (A18) og rett inn med skriften INSERT: Vri deretter filterkoppene mot høyre (fig. 16). Kverningen starter når filterkoppene når posisjonen CLOSE og avbrytes deretter automatisk.

#### Reguler mengden malt kaffe i filteret.

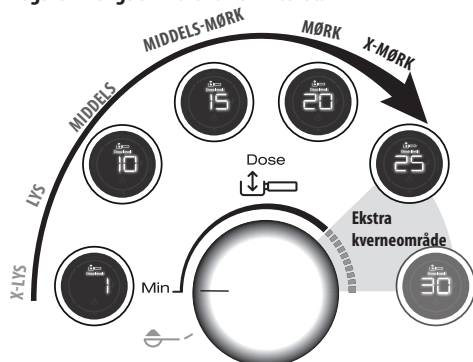

Hver type kaffebønne gir et forskjellig resultat når det males, og reguleringen vil derfor kreve stor presisjon i begynnelsen.

Denne illustrasjonen gir anvisninger om hvordan dosen reguleres, basert på brenningsgraden til kaffen. De må anses som et utgangspunkt, men kan variere avhengig av typen kaffebønner.

1. Still inn dosen for minste posisjon.
2. Man må basere seg på brenningsgraden til kaffen som brukes og vri langsomt på bryteren.

#### 4.2 Fase 2 - Pressing (tamping) (fig. 17)

1. Etter at malingen er ferdig må man senke pressespaken (A20) helt ned (ikke ta ut filterholderen) (fig. 18). Gjenta 2 ganger for et perfekt resultat.
2. Hold pressespaken helt nede når filterholderen tas ut (fig. 19). Sett deretter spaken tilbake i startposisjon.

- Når man har kontrollert at kaffedosen er korrekt (se "Perfekt dose"), kan man hekte filterholderen på kaffeuttaket (A7) (fig. 20).

### "Perfekt dose"

- Kaffefiltrene har et innvendig referansemerke som angir den perfekte dosen.

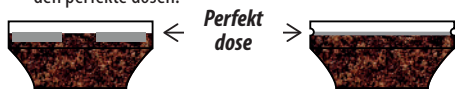

#### Lasermerket

- Lasermerket filter: Den perfekte dosen samsvarer med den øvre lasermerkede linjen.
- Stempelmerket filter: Den perfekte dosen samsvarer med den stempelmerkede linjen.

- Se til at kaffen befinner seg på nivå etter pressing. Det kan være nødvendig å regulere bryteren (B2) flere ganger før man oppnår en perfekt dose.
- Hvis den malte kaffen er for fin eller grov, men dosen befinner seg innenfor perfekt dose, kan man prøve å regulere malegraden slik at den blir enten grovere eller finere (se "4.1 Fase 1 - Maling (grinding) (fig. 11)"). Hvis kaffen er for finmalt (langsom flyt) må den gjøres grovere. Hvis kaffen er for grovmalt (hurtig flyt) må den gjøres finere.
- Vår barista anbefaler:** Ta ut filterholderen mens pressespaken (A20) er senket for å oppnå en perfekt avslutning på kaffedosen.

### 4.3 Fase 3 - Tilberedelse (brewing) (fig. 21)

- Velg ønsket drikk (fig. 22).
- Trykk på OK (B6) for å starte tilberedelsen (fig. 23) (forhåndsbygging og brygging). Tilberedelsen starter opp og avbrytes automatisk.

## 5. TILBEREDELSE AV MELKEDRIKK

### 5.1 Skumme melk (fig. 24)

- Hell den mengden melk som ønskes varmet/skummet ned i melkebeholderen (D8) og husk at den vil øke 2-3 ganger i volum (fig. 25). For et tykkere og mer homogent melkeskum anbefales det å bruke hel kumelk som holder kjøleskapstemperatur (cirka 5°C).

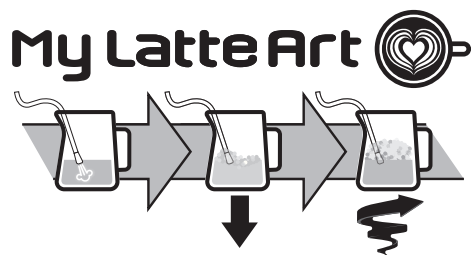

- For å skumme melken holder man damprøret (A5) på melkens overflate slik at luften blandet seg med melken og dampen.
- Hold damprøret på overflaten og vær særlig oppmerksom slik at det ikke kommer inn for mye luft som igjen kan skape store bobler.
- Dypp damprøret ned i melken slik at det skapes en virvel. Når ønsket temperatur er nådd lukker man igjen damprøret og venter til damptilberedelsen avbrytes fullstendig før melkekannen tas ut av maskinen.

### Vår barista anbefaler:

- Fersk melk er å foretrekke.** Bruk alltid melk som holder kjøleskapstemperatur.
- Helmelk garanterer optimale resultater. Resultatet og skummets tekstur varierer avhengig av om det brukes kumelk eller vegetalske melketyper.
- Etter at melken er blitt skummet må man fjerne boblene ved å riste litt på melkekannen.

### Rengjøring av damputtaket:

- Etter hver bruk bør man fjerne melkerester fra damputtaket med en klut (fig. 26). For en mer nøyaktig rengjøring anbefales det å bruke Eco MultiClean. Dette sikrer god hygiene ved å fjerne protein og fett fra melken, og kan brukes til å rengjøre hele maskinen.
- La det skilles ut damp noen sekunder slik at uttaket rengjøres (fig. 10).
- Vent til uttaket kjøles ned. For å opprettholde uttaketseffektivitet over tid må man anvende rengjøringsnålen "" på side 127 for å frigjøre de tre hullene (fig. 27).

### 5.2 Tilberede melkedrikk med LatteCrema System (fig. 28)

- Hell melk som holder kjøleskapstemperatur i melkebeholderen (D8) (5°C) (fig. 29).
- Sett på lokket (D1) (fig. 30).
- Vri skumreguleringsbryteren (D5) til ønsket posisjon (fig. 31).

Posisjonen til skumreguleringsbryter				
CLEAN				INSERT
Rengjøring etter hver bruk	M A X - skum	M E D - skum	MIN-skum	For å sette inn eller ta ut bryteren

- Hekt melkebeholderen til maskinen (fig. 32).
- Tilberede en perfekt dose (se "4.1 Fase 1 - Maling (grinding) (fig. 11)" og "4.2 Fase 2 - Pressing (tamping) (fig. 17)") og sett inn filterholderen.
- Velg ønsket melkedrikk (fig. 33).



Drink	Espresso	Melk	Skum	Mengde (ml)	X2 (ml)
Cappuccino	1	✓	✓	≈150	≈230
Latte Macchiato	1	✓	✗	≈150	≈230
Flat White	1	✓	✓	≈250	≈330

- **Drink med dobbel dose (2x):** Hell melkemengde som er nødvendig for tilberedelsen i beholderen (D8) og vær oppmerksom slik at ikke MAX-nivået overskrides (fig. 25). Hvert hakk tilsvarer ≈100 ml melk.
  - **Fersk melk er å foretrekke.** Bruk alltid melk som holder kjøleskapstemperatur.
7. Trykk på OK (B6) for å starte tilberedelsen (fig. 23). Apparatet vil automatisk tilberede kaffe og melk etter hverandre.

### Rengjøring av Lattecrema System etter hver bruk:



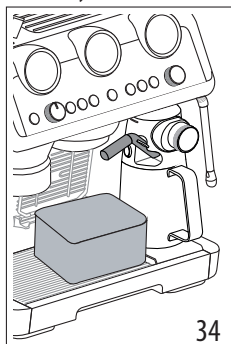

1. La melkebeholderen forbli hekket på maskinen (det er ikke nødvendig å tømme den). Sett en beholder under melkeuttaksrøret (D4) (fig. 34).
2. Vri bryteren (D5) til "Clean" (fig. 35).



3. Rengjøringens starter opp og avbrytes automatisk. OBS! Når rengjøringen er ferdig må man vri bryteren til en av posisjonene for skumregulering.





4. Ta ut melkebeholderen og sett den i kjøleskapet. Det anbefales å bruke den gjenværende melken innen kort tid. For en mer nøyaktig rengjøring anbefales det å bruke Eco MultiClean. Dette sikrer god hygiene ved å fjerne protein og fett fra melken, og kan brukes til å rengjøre hele maskinen.



## 6. KAFFEMENGDEN KAN EGENDEFINERES VED Å TRYKKE PÅ TASTEN (B9)

1. Klargjør maskinen slik at den tilbereder 1 eller 2 kopper av ønsket kaffedrikk. Fest deretter filterholderen (C1) komplett med filter (C2) eller (C3) og malt kaffe. Hvis man ønsker å programmere en melkedrikk må man koble Lattecrema System til maskinen,
  2. Vri på bryteren (B10) for å velge drikken som skal programmeres.
  3. Trykk på tasten . Lampen til tasten OK (B6) vil tennes og lampen i tasten  vil blinke.
  4. Trykk på OK-tasten for å starte tilberedelsen. Lampene i OK-tastene og  blinker.
  5. Når man har nådd ønsket mengde trykker man på OK. Hvis drikken har behov for flere ingredienser må man starte tilberedelsen av denne. Når ønsket mengde er nådd trykker man på OK.
  6. Trykk på tasten  for å lagre. Apparatet er klart for ny bruk og lampen  forblir tent.
- Hvis man ikke ønsker å lagre programmeringen trykker man på en hvilken som helst tast.











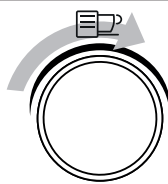











### NB!

- Det er mulig å programmere kaffedrikker, men ikke uttak av damp og varmtvann.
- Programmeringen endrer mengden til drikkene, men ikke til den malte kaffen,
- Drikkene "X2" kan programmeres separat.
- **My LatteArt**  er ikke programmerbar.
- **For å gå tilbake til fabrikkinnstillinger holder man inne tasten  inntil maskinen slår seg av. Den valgte drikken går tilbake til fabrikkinnstillinger.**

Kaffeopskrift	Standardmengde	Programmert mengde
 Espresso	35 ml	fra 25 til 90 ml
 Espresso X2	70 ml	fra 50 til 180 ml
 Coffee	80 ml	fra 50 til 120 ml
 Coffee X2	160 ml	fra 120 til 240 ml

Kaf-feoppskrift	Standard-mengde	Programmert mengde
 Americano	120 ml	<ul style="list-style-type: none"> <li>• espresso: fra 25 til 60 ml</li> <li>• vann: fra 25 til 120 ml</li> </ul>
 Americano X2	240 ml	<ul style="list-style-type: none"> <li>• espresso: fra 50 til 120 ml</li> <li>• vann: fra 50 til 240 ml</li> </ul>

## 7. PROGRAMMERINGSMENY

1. Åpne menyen:		
Hold inne samtidig i 5 sekunder	x2	
2. Velg innstilling som skal programmeres:		
		
Drink	Til knyttet innstilling	Reguleringer
 Espresso	Energisparing:	 →  <b>Aktiv</b>
		 →  <b>Avslått</b>
 Coffee	Autostopp	 → <b>9 minutter</b>
		 → <b>1,5 timer</b>
		 → <b>3 timer</b>
 Cappuccino	Lydsignal	 →  <b>Aktiv</b>
		 →  <b>Avslått</b>
 Latte	Ekstra regulering av kaffekvern	 → <b>Område 1</b>
		 → <b>Område 2</b>
 Flat White	Fabrikkinnst.	Hold inne OK-tasten i 5 sekunder inntil lampen tennes og lyser uavbrutt.
 Americano	Vannhardhet	 → <b>bløtt</b>
		 → <b>middels</b>
		 → <b>hardt/svært hardt</b>
→		

## 3. Lagre de nye innstillingene ved å trykke på ON/Standby (B1)

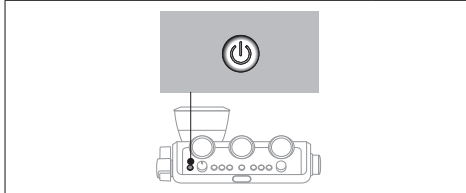











## 8. RENGJØRING AV APPARATET

### OBS!

- Ved rengjøring av maskinen må man ikke bruke løsemidler, skuremidler eller sprit.
- Ikke bruk metallgjenstander til å skrape løs avleiringer eller kafferester, da dette kan lage riper i overflaten til deler av metall eller plast.
- For oppholdsperioder som overgår en uke, anbefales det å foreta en skyllesyklus før maskinen igjen tas i bruk.

### Fare!

- Under rengjøringen må man ikke dyppe maskinen i vann. Det er et elektrisk apparat.
- Før man tar til med rengjøring av eksterne deler på apparatet, må man slå av maskinen og trekke ut støpselet, slik at maskinen kan avkjøles.

					
	×	✓	✓	×	×
	✓	×	×	✓	✓
	×	×	×	✓	✓
	×	×	×	✓	✓
	×	×	✓	✓	×
→					

	×	×	×	✓	✓
	✓	✓	×	✓	✓

### 8.1 Rengjøring av kaffeuttaket

Når lampen tennes (oransje) (B5) må man gå videre til rengjøring av kafferørkretsen. For å foreta en rensesyklus må det anvendes tabletter for rengjøring av kaffemaskiner. For ytterligere informasjon bes man besøke [www.Delonghi.com](http://www.Delonghi.com).

1. Sett inn 1-koppfilter (C2) i filterholderen (C1) (fig. 36).
2. Sett inn rensekoppen i filteret (C9) (fig. 36) og trykk den helt inn.

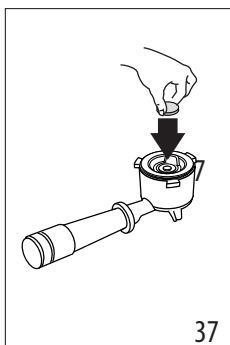
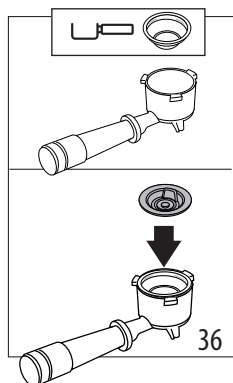

3. Legg tablettene i rensekoppen (fig. 37).
4. Fest filterholderen til kaffeuttaket (A7).
5. Fyll opp vannbeholderen (A15). Se til at dryppeskålen (A11) er tom.
6. Hold tasten inne inntil den tilknyttede lampen begynner å blinke (oransje). Etter noen minutter vil rengjøringen avbrytes automatisk.
  - Fjern filterholderen og rensekoppen.
  - Skyll filterholderen og filteret i rennende vann.
  - Sett tilbake filterholderen og foreta deretter en skylling med tasten (B5). Det anbefales å sette en beholder under filterholderen.
  - Fjern og tøm ut dryppeskålen.

#### NB:

Denne rengjøringsssyklusen kan startes når som helst ved å trykke på tasten (B5) i noen sekunder. For å avbryte operasjonen kan man holde inne knappen i 10 sekunder.

### 8.2 Rengjør rundt posisjonen til bønnebeholderen

1. Se til at bønnebeholderen (A1) er tom. Foreta eventuelt noen malingsyklus uten bønner for å tømme den.
2. Hekt av beholderen ved å vri den mot klokkeretningen og ta den ut av maskinen (fig. 38)

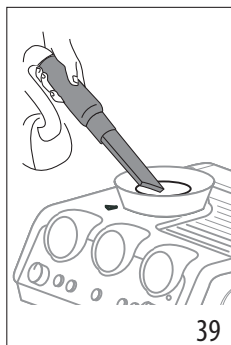
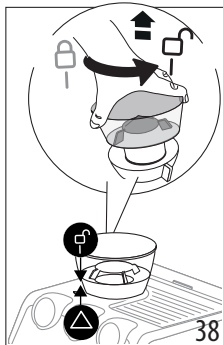

3. Sug opp alle kafferester (fig. 39).
4. Rengjør med en fuktig klut rundt bønnebeholderen og tørk av (fig. 40).

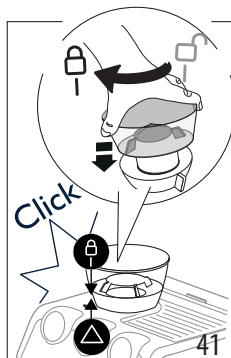
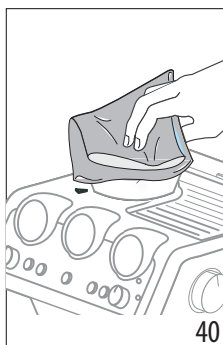

5. Sett beholderen tilbake på plass i kaffekvernen. Beholderen er korrekt satt på plass når pilen er på linje med symbolet og det kan høres et klikk (fig. 41).

### 8.3 Rengjøring av kvernene

Når bønnebeholderen (A1) rengjøres må man huske å rengjøre rundt beholderen og kaffekvernen med en fuktig klut. Man bes henvende seg til et servicesenter for fjerning og bytting av kvernene.

Kvernen kan tas ut hvis den er blokkert av et fremmedlegeme. Hvis dette skulle inntreffe må man fjerne bønnebeholderen og gjøre følgende:

1. Fest filterholderen (C1) og foreta en tom kvernesyklus for å frigjøre kaffekretsen.
2. Slå av apparatet.

3. Vri kaffekvernregulatoren helt rundt mot klokkeretningen, helt til den kommer i posisjon "REMOVE" (fig. 42).

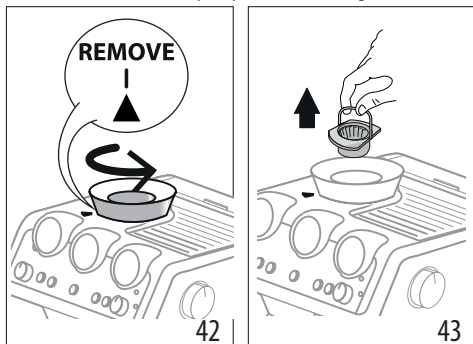

4. Trekk ut den øvre delen av kvernen og hold fast i håndtaket (fig.43).
5. Rengjør kvernen med en børste (fig. 44) og fjern alle kaffesterer med en støvsuger (fig. 39).

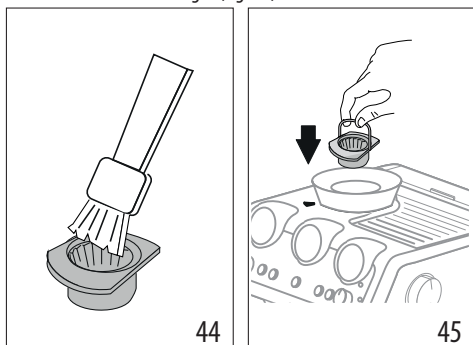

6. Sett kvernen på plass (fig. 45).
7. Vri regulatoren for å velge ønsket malegrad (fig. 13). Kontroller at kvernen er godt satt inn ved å gå i håndtaket. Kvernen er korrekt satt inn hvis den ikke beveger seg.

#### 8.4 Bytte av kaffekvern

Når den oppkvervede kaffemengden reduseres ytterligere bes man henvende seg til et servicesenter for å bytte ut kvernene. Etterpå må man regulere kaffekvernen ved å gå til innstillingsmenyen ("7. Programmeringsmeny") og velge første reguleringsområde. Vri deretter mengdereguleringsbryteren (B2) til posisjon MIN og regulerer dosen som ved første gangs bruk (se "Perfekt dose").

#### 8.5 Rengjøring av "Smart tamping station"

1. Rengjør sonen rundt holderen med en pensel eller børste (fig. 46).
2. Dra spaken (A20) helt i endeposisjon og rengjør pressen med en børste (fig.47). Slipp deretter opp spaken.

3. Bruk den lille børsten (C8) til å rengjøre kaffetrakten (fig. 48).

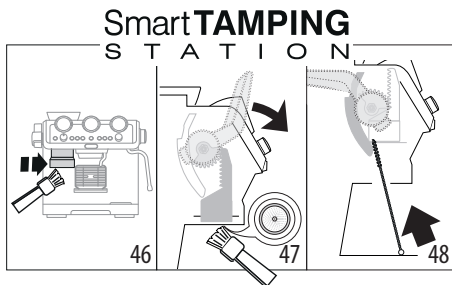

#### 8.6 Rengjøring av LatteCrema System

Vask alle delene og beholderen i oppvaskmaskin, men bruk alltid den øverste skuffen. Hvis man ikke er i besittelse av oppvaskmaskin kan man rengjøre for hånd ved å følge anvisningene på slutten av denne paragrafen.

1. Trykk på knappen (D3) og løft opp melkebeholderlokket (D1).
2. Ta ut melkeuttaket (D4) og melkeslangen((D7) (fig. 49).

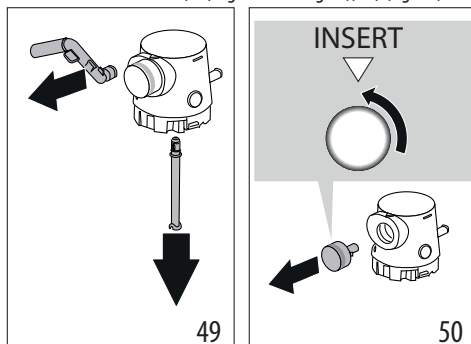

3. Vri bryteren til posisjonen "Insert" og trekk den ut (fig. 50).
4. Vær særlig oppmerksom på fordypningen og kanalen under bryteren (fig. 51) slik at det ikke befinner seg melkerester. Skrap eventuelt ut kanalen med en tannpirker.

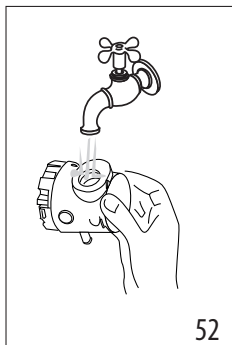
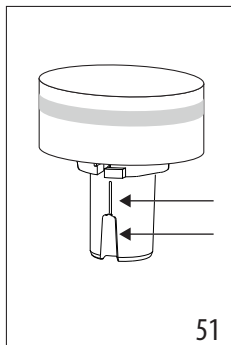

5. Skyll insiden av bryteren for skumregulering med rennende vann (se fig. 52).
6. Se til at alle rørene er rene og ikke viser tegn til tilstoppelse som følge av melkerester.
7. Sett sammen alle komponentene til lokket.
8. Rengjør og skyll melkebeholderen (D8) nøye.
9. Sett på plass lokket på melkebeholderen.

**NB: vask for hånd**

Rengjøring i oppvaskmaskin sikrer en perfekt hygienisering av alle komponentene til melkebeholderen. Hvis komponentene i melkebeholderen skal rengjøres for hånd må de dyppes ned i varmt vann og bli liggende i cirka 30 minutter, før man fortsetter som forklart i punkt 4.

**9. VANNHARDHET**

Avkalkingslampen (B8) vil vises etter et forhåndsbestemt bruksintervall som avhenger av vannets hardhetsgrad. Det er mulig å programmere maskinen etter hvor hardt vannet man bruker faktisk er, og på denne måten endrer man frekvensen for hvor hyppig denne meldingen vises.

1. Ta den medfølgende teststrimmelen "TOTAL HARDNESS TEST" ut av forpakningen (C4).
2. Dypp strimmelen helt ned i et glass med vann i ca. et sekund.
3. Ta strimmelen ut av vannet og rist lett på den. Still inn apparatet som vist i kapittel "7. Programmeringsmeny".

Resultat vannhardhetstest	Tast	Nivå
	x2	1 bløtt vann
		2 middels hardt vann
	OK	3 hardt eller svært hardt vann

4. Still inn apparatet som vist i kapittel "7. Programmeringsmeny".

**10. HVORDAN BRUKE SOFTBALLS**

Softballs (C11) er et innovativt system som forlenger maskinens levetid uten at det påvirker vannkvaliteten, noe som gir en kaffe som er kremete og aromatisk. For en bedre ytelse anbefales det å legge Softballs i bløtt gjenommen natten før de skal brukes.

1. Ta ut pakken med Softballs fra emballasjen (fig. 53).

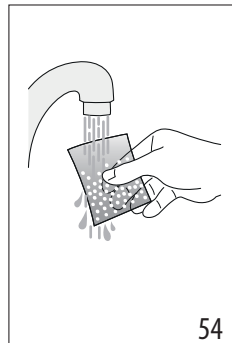
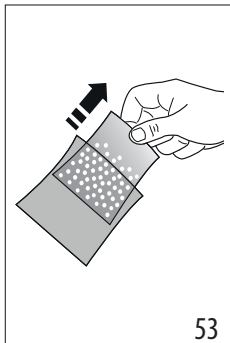

2. Skyll pakken med Softballs rennende vann (fig. 54).
3. Legg posen ned i vannbeholderen (A15) (fig. 55).

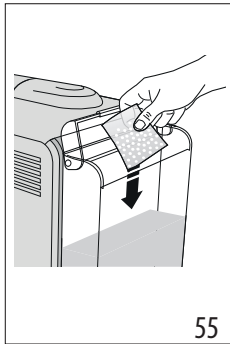

4. Skift ut pakken med Softballs hver 3. måned (fig. 56).

**11. AVKALKING**

**Vær oppmerksom!**

- Før bruk må man lese instruksjonene og merkingen som mer oppgitt på pakken med avkalkningsmiddel (C5).
- Det anbefales å bruke avkalkningsmiddel utelukkende produsert av De'Longhi. Hvis det anvendes upassende avkalkningsmidler, eller hvis avkalkningen utføres feil, kan dette føre til skader som ikke dekkes av produsentens garanti.
- Avkalkningsmiddelet kan skade ømfintlige overflater. Hvis produktet velter ved et uhell må man tørke opp umiddelbart.

For å utføre avkalkning	
Avkalkning- smiddel	De'Longhi avkalkningsmiddel
Beholdere	2 på en liter hver
Tid	~40min

1. (TA UT VANNAVHERDERFILTER OG SOFTBALL HVIS NØDVENDIG). Hell avkalkningsmiddel i vannbeholderen (A15) opp til nivå  A (tilsvare en pakke med 100ml) avmerket på innsiden av tanken (fig. 57).

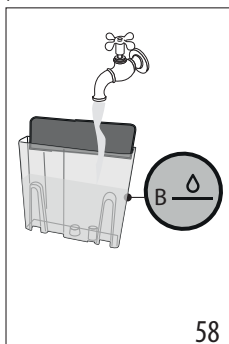
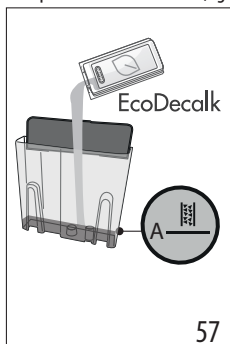

2. Hell på vann opp til nivå  B (fig. 58). Sett deretter beholderen inn i maskinen igjen.
3. Sett inn utstyret (C6) på kontakten til LatteCrema System (A6) (fig. 59).

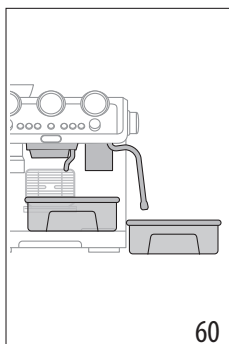
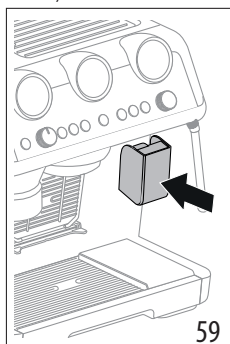

4. Se til at filterholderen (C1) ikke er satt inn og sett deretter en beholder under kaffeuttaket (A7) og damputtaket (A5) (fig. 60).
5. Hold tasten  (B8) inne inntil den tilknyttede lampen begynner å blinke.
6. Avkalkingsprogrammet starter opp og avkalkningsmiddel kommer ut fra uttakene. Avkalkningsprogrammet utfører automatisk en serie skyllesykluser for å fjerne restene av kalk som befinner seg inne i kaffemaskinen inntil beholderen er helt tom.

Tilberedelsen avbrytes og lampen  lyser hvitt. Det er nå nødvendig å foreta en skyllesyklus.

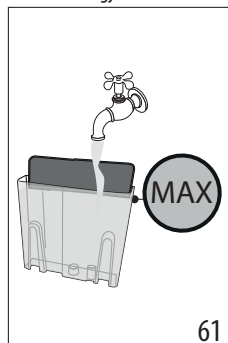

7. Tøm ut den anvendte beholderen og sett den deretter under uttakene.
8. Trekk ut vannbeholderen, tøm den for eventuelle rester etter avkalkningsmiddel, skyll den med vann, og fyll den deretter med friskt vann opp til MAX-nivå (fig. 61). Sett inn beholderen i holderen igjen.



9. Hold tasten  inne inntil den tilknyttede lampen begynner å blinke; skyllingen starter opp.
10. Når skyllingen er ferdig vil tilberedelsen avbrytes og apparatet er klart til bruk.
11. Tøm beholderen som ble brukt til å samle opp skyllevann.
12. Ta ut og tøm dryppeskålen, og sett den deretter tilbake i apparatet.
13. Trekk ut og fyll beholderen med friskt vann før den settes inn igjen.











Apparatet er nå klart til bruk.











**NB!**

- Hvis man ønsker å foreta avkalkingssyklusen med en gang holder man inne tasten  i 3 sekunder.
- Hvis avkalkingen er blitt startet opp ved et uhell må man holde inne tasten  i 10 sekunder. Skyllesyklusen kan ikke avbrytes.





## 12. BESKRIVELSE AV KONTROLLAMPER

VARSELLAMPER	BESKRIVELSE AV KONTROLLAMPENE	OPERASJON
Alle lampene blinker kort	Slå på apparatet	Selvdiagnose
 fast lysende	Det er første gang maskinen slås på, og man må la vannkretsene i maskinen fylle seg opp	Man må gjøre som vist i kap. "3. Første gangs oppstart av apparatet"
 fast lysende	Funksjonen Energisparing er ikke aktiv.	Det henvises til kap. "7. Programmeringsmeny" hvis man ønsker å deaktivere funksjonen
 fast lysende	Kaffebønnebeholderen (A1) er tom	Fyll kaffebønnebeholderen
 blinkende	Man ønsker å male opp kaffe, men bønnebeholderen (A1) er tom	Fyll kaffebønnebeholderen
 på	Det er ikke nok vann i beholderen (A15), eller vannbeholderen er ikke korrekt satt i	Fyll beholderen eller trekk ut og sett inn igjen beholderen
 blinkende	Hvis man ønsker å tilberede en drikk, men bønnebeholderen (A15) er tom.	Fyll opp vannbeholderen
 fast lysende	Generell alarm	Man bes henvende seg til De'Longhi servicesenter
 fast lysende	Kaffebønnebeholderen er ikke satt i	Sett inn bønnebeholderen (A1) eller kontroller at den er korrekt satt inn
 blinkende	Velgeren nederst på bønnebeholderen (A1) er ikke i korrekt posisjon	Sett velgeren i en av maleposisjonene (mellom 1 og 8) og husk følgende: <ul style="list-style-type: none"> <li>• Regulering av malegrad må skje mens kaffekvernene er i funksjon</li> <li>• Kvernen må reguleres ett nivå av gangen, og det må foretas minst fem kvernesykulser mellom hver regulering.</li> </ul>
	Bønnebeholderen (A1) er ikke fullstendig satt inn. Sikkerhetsinnretningen utløses.	Kontroller at bønnebeholderen er korrekt satt inn
 fast lysende	LatteCrema System må rengjøres etter hver bruk	Etter tilberedelse av en melkedrikk går man videre til automatisk rengjøring ved å vri bryteren (D5) til Clean
 fast lysende	Apparatet er klart for å skille ut damp.	Apparatet har nådd temperaturen for å skille ut damp. For å gå videre til uttaket vrir man på dampbryteren (A4)
→		

VARSELLAMPER	BESKRIVELSE AV KONTROLLAMPENE	OPERASJON
 blinkende	Apparatet er påslått og funksjonen Energisparing er aktivert. Dampbryteren (A4) står i posisjon for å skille ut damp.	Lampen blinker for å vise at apparatet er klart for å skille ut damp. Uttaket starter med en gang apparatet har korrekt temperatur.
	Apparatet er klart for å skille ut damp	Apparatet har nådd temperaturen for å skille ut damp når lampen lyser uavbrutt
	Apparatet skiller ut damp	
 Lyser (oransje)	Det må utføres avkalking	Utfør avkalking som illustrert i kap. "11. Avkalking"
 Blinker (oransje)	Apparatet utfører avkalking	Fullført operasjonen som forklart i kap. "11. Avkalking"
 Lyser (hvitt)	Det er nødvendig å foreta en skyllesyklus	
 Blinker (hvitt)	Apparatet utfører skylling	
 Lyser (oransje)	Det er nødvendig å foreta rengjøring av kaffeuttaket	Se par. "8.1 Rengjøring av kaffeuttaket"
 Blinker (oransje)	Apparatet utfører rengjøring av kaffeuttaket	
 Blinker (hvitt)	Apparatet foretar en skylling	
 +  blinker	Hvis avherdingsfilter er satt inn kan det hende det finnes luftbobler i kretsen som hindrer tilberedelsen.	Trykk på tasten (B7) ved siden av lampen  . Tilberedelsen vil starte og stoppe automatisk.
	Kaffen er for finmalt og renner ut for langsomt eller ikke i det hele tatt.	Trekk ut filterkoppen (C1) og gjenta operasjonen for å tilberede kaffe i samsvar med det som er oppgitt i par. "4.1 Fase 1 - Maling (grinding) (fig. 11)" og "4.2 Fase 2 - Pressing (tamping) (fig. 17)"
	Kaffefilteret (C2) eller (C3) er tilstoppet	Skyll filtrene i rennende vann eller foreta en skylling med skylletasten (B5).
	Beholderen (A15) er satt inn feil og ventilene nederst er ikke åpne	Press beholderen forsiktig inn slik at ventilene åpner seg
	Kalk innvendig i den hydrauliske kretsene	Utfør avkalking slik som vist i kap. "11. Avkalking"

### 13. HVIS NOE IKKE FUNGERER

PROBLEM	ÅRSAK	LØSNING
Det er vann i dryppeskålen (A11)	Dette er en normal del av funksjonen til maskinens innvendige kretser	Tøm og rengjør dryppeskålen (A11) regelmessig
Det skiller ikke ut espresso	Mangler vann i beholderen (A15)	Fyll beholderen
	Lampen  (B7) lyser for å vise at kaffekretsen og dampkretsen er tom.	Trykk på tasten ved lampen  for å fylle kretsen.
	Filteret (C2) eller (C3) er tilstoppet	Skyll filtrene i rennende vann eller foreta en skylling med den tilhørende tasten (B5)
	Beholderen (A15) er ikke satt inn korrekt og ventilene nederst er ikke åpne	Press beholderen inn slik at ventilene åpner seg
	Kalk innvendig i den hydrauliske kretsene	Utfør avkalking slik som vist i kap. "11. Avkalking"
	For finmalt	Trekk ut filterkoppene (C1) og gjenta operasjonen for å tilberede kaffe i samsvar med det som er oppgitt i par. "4.1 Fase 1 - Maling (grinding) (fig. 11)" og "4.2 Fase 2 - Pressing (tamping) (fig. 17)"
Filterholderen fester seg ikke til apparatet	Den malte kaffen er ikke blitt presset, eller det er for mye malt kaffe	Gjenta malingen med andre innstillinger. Reduser dosemengden. Kontroller at filteret (C2) eller (C3) (1 eller 2 kopper) er blitt korrekt satt inn for den aktuelle dosen (tast 2x (B3) valgt eller ikke)
Det drypper espresso over kanten på filterholderen (C1) men ikke fra åpningene	Filterholderen er ikke satt inn korrekt	Sett på filterholderen på riktig måte og vri den helt inn
	Pakningen på kaffeuttaket (A7) er blitt elastisk eller er skittent	Skift ut pakningen i kaffeuttaket hos et Servicecenter
	Filteret (C2) eller (C3) er tilstoppet	Skyll filtrene i rennende vann eller foreta en skylling med skylletasten (B5)
Kaffekremem er klar i fargen (renner hurtig fra tuten)	Man må gå over innstillingene til apparatet	Trekk ut filterkoppene, gjenta operasjonen for å tilberede kaffe som er gjengitt i par. "4.1 Fase 1 - Maling (grinding) (fig. 11)" og "4.2 Fase 2 - Pressing (tamping) (fig. 17)"
Kaffekremem er mørk i fargen (renner langsomt fra tuten)	Man må gå over innstillingene til apparatet	Trekk ut filterkoppene (C1) og gjenta operasjonen for å tilberede kaffe i samsvar med det som er oppgitt i par. "4.1 Fase 1 - Maling (grinding) (fig. 11)" og "4.2 Fase 2 - Pressing (tamping) (fig. 17)"
		→

PROBLEM	ÅRSAK	LØSNING
Melkeskum formerer seg ikke når det tilberedes Cappuccino med LatteCrema System	Melken er ikke kald nok	Bruk alltid melk som innehar kjøleskapstemperatur
	Bryteren (D5) befinner seg ikke i korrekt posisjon	Kontroller og vri bryteren til korrekt posisjon ( ☺ max-skum, ☺ med-skum, ☺ min-skum)
	LatteCrema System er skittent	Maskinen må rengjøres som illustrert i paragraf "8.6 Rengjøring av LatteCrema System"
	Kalk innvendig i den hydrauliske kretsene	Utfør avkalking slik som vist i kap. "11. Avkalking"
Når avkalkningen er blitt utført vil apparatet ha behov for en ekstra skyllesyklus	Under denne skyllesyklusen er ikke beholderen fylt opp til MAX-nivå	Gjenta skylling (se kap. "11. Avkalking")
Apparatet maler ikke opp ikke kaffe	Det finnes fremmedlegemer inne i kaffekvernen	Kvernene må rengjøres som forklart i par. "8.3 Rengjøring av kvernene", men påse at alle bønner er fjernet fra kaffe-bønnebeholderen (A2) før den tas ut. Før kvernen settes tilbake på plass må man suge opp alle urenheter rundt denne
	Bønnebeholderen (A1) befinner seg ikke i korrekt posisjon	Beholderen er korrekt satt på plass når pilen ▲ er på linje med symbolet ☺ og det høres et klikk
Hvis man ønsker kan kaffetypen byttes.	Man må fjerne alle kaffebønner i maskinen.	<ul style="list-style-type: none"> <li>• Tøm kaffebønnebeholderen (A1) (kvern opp gjenværende innhold eller bruk en støvsuger til å tømme den).</li> <li>• Hekt på filterkoppene (C1) og foreta en kverning på tomgang for å rense opp kaffekretsen: Hekt filterholderen på utgangen for malt kaffe (A18) og rett inn med skriften INSERT. Vri deretter filterkoppene mot høyre (fig. 22). Kverningen starter når filterkoppene når posisjonen CLOSE og avbrytes deretter automatisk. Gjenta inntil filteret er tomt</li> <li>• Tilsett en nye type kaffebønner i beholderen (A1)</li> <li>• Hvis malegraden ikke når "perfekt dose" gjør man som forklart for første gangs bruk</li> </ul>
		→

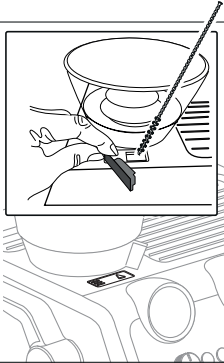
PROBLEM	ÅRSAK	LØSNING
<p>Etter maling er kaffefiltrene (C2) eller (C3) tomme</p> <p>Etter kverningen er kaffefilteret fullt av kaffepulver</p>	<p>Kaffetrakten i kvernen er tilstoppet.</p>	<p>Maskinen må rengjøres som forklart i par. "8.5 Rengjøring av "Smart tamping station"". Hvis problemet vedvarer må man få tilgang til trakten ved å åpne den anviste luen (A19) og deretter løsne den med spatelen</p> 
<p>Etter kverningen når ikke kaffepulveret i filtrene (C2) eller (C3) "perfekt dose"</p>	<p>"Smart Tamping Station" har behov for rengjøring</p> <p>Mengden kvernet kaffe må reguleres</p> <p>Med tiden vil kvernene slites ned</p>	<p>Maskinen må rengjøres som forklart i par. "8.5 Rengjøring av "Smart tamping station"" før man gjentar kverningen</p> <p>Foreta regulering med den anviste betjeningsbryteren (B2) og følg anvisningene i par. " "Perfekt dose"". Hvis bryteren allerede er i max-posisjon gjør man som forklart i delen "Ekstra regulering av kaffekvern"</p> <p>Skift ut disse kvernene som forklart i par. "8.4 Bytte av kaffekvern"</p>

Innan du använder apparaten, läs alltid broschyren med säkerhetsvarningarna.

## 1. BESKRIVNING

### 1.1 Beskrivning av apparaten - A

- A1. Behållare för kaffebönor
- A2. Lock för behållaren för kaffebönor
- A3. Koppbricka
- A4. Ångknapp
- A5. Ångrör
- A6. Anslutning för Lattecrema System
- A7. Kaffedispenser
- A8. Galler koppbricka för espresso
- A9. Galler koppbricka för glas eller mugg
- A10. Droppkarets galler
- A11. Droppkar
- A12. Vattennivåvisare för droppkaret
- A13. Lock vattentank
- A14. Handtag för utdragning av vattenbehållaren
- A15. Vattenbehållare
- A16. Utrymme för matningskabelns kontakt
- A17. Huvudströmbrytare (PÅ/AV)
- A18. Utgång kaffekvarn (Tamping station)
- A19. Lucka för att komma åt kaffekvarnens glidbana
- A20. Spak press

### 1.2 Beskrivning av manöverpanelen - B

- B1. Knapp PÅ/Standby
- B2. Vred för justering av mängd malet kaffe
- B3. Knapp "X2": för att använda filtret för 2 kaffe
- B4. Knapp "kaffetemperatur"
- B5. Knapp "sköljning"
- B6. Knapp "OK": för att dispensera dryck/för att bekräfta
- B7. Knapp "dispensering av varmt vatten"
- B8. Knapp "avkalkning"
- B9. Knapp "My": för att personalisera mängden av dryck
- B10. Valratt funktioner
- B11. Display drycker:

#### Espresso kaffebaserade drycker

- Espresso
- Americano
- Coffee

#### Mjölkbaserade drycker

- Cappuccino
- Flat White
- Latte Macchiato

- B12. Varningslampa "rengöring mjölk"
- B13. Varningslampa "behållare för kaffebönor saknas"
- B14. Varningslampa "allmänt larm"
- B15. Manometer

- B16. Varningslampa "vatten saknas"
- B17. Varningslampa "behållare kaffebönor tom"
- B18. Varningslampa "energibesparing"
- B19. Display inställningar och procedur:

- Anger proceduren som apparaten utför
- Anger inställningen av vald kaffedos
- Anger inställningen av vald kaffedos

### 1.3 Beskrivning av tillbehören - C

- C1. Filterhållare
- C2. Filter 1 kopp
- C3. Filter 2 koppar
- C4. Reaktionssticka "Total Hardness Test"
- C5. Avkalkningsmedel
- C6. Tillbehör för avkalkning
- C7. Strömkabel borttagbar
- C8. Borste
- C9. Tillbehör rengöring av kaffedispenser
- C10. Duk
- C11. Softballs (vattenavhårdare)
- C12. Rengöringsnål för ångrör

### 1.4 Rengöringstillbehör ingår inte, rekommenderas av tillverkaren

För ytterligare informationer, besök [Delonghi.com](http://Delonghi.com).



#### Rengöringspastiller

(Se "8.1 Rengöring av kaffedispensern")



#### Rengöringsmedel

EAN: 8004399333307

### 1.5 Beskrivning av LatteCrema System - D

- D1. Lock för mjölkbehållaren
- D2. Anslutning mjölkbehållare
- D3. Knapp för frisläppning av locket
- D4. Mjölkdispenser (justerbar i höjd)
- D5. Ratt för att justera skummet
- D6. Rattens utrymme
- D7. Mjölk insugningssläng
- D8. Mjölkbehållare

## 2. FÖRBEREDELSE AV APPARATEN

Diska samtliga tillbehör, med ljummet vatten och diskmedel för tallrikar och fortsätt sedan så här:

1. För in droppkaret (A11) komplett med koppbrickans galler (A9) och droppkarets galler (A10) (fig. 1);
2. Dra ur vattentanken (A15) (fig. 2) och fyll med färskt och rent vatten, se till att texten MAX inte övertäcks (fig. 3).

3. För sedan in tanken.

**Observera:** Sätt aldrig apparaten i drift utan vatten i behållaren eller om behållare saknas.

**Observera:** Vi rekommenderar dig att snarast anpassa vattnets hårdhet enligt proceduren som beskrivs i kapitel "7. Inställningsmeny".

### 3. FÖRSTA IBRUKTAGANDET AV MASKINEN

1. Sätt i kontakten till elsladden (C7) i avsett säte (A16) på baksidan av apparaten (fig. 4); och sätt sedan in stickkontakten i eluttaget. Försäkra dig att huvudströmbrytaren (A17), på apparatens baksida är intryckt i läge I (fig. 5);
2. Placera en behållare med minimum kapacitet på 100 ml, under dispensern för varmt vatten (i höjd med kaffedispensern (A7)) (fig. 6);
3. Tryck in knappen (B7) i höjd med indikationslampan (B6) (fig. 7): dispenseringen startar och avbryts automatiskt. Töm behållaren.

Innan du börjar använda maskinen, är det nödvändigt att skölja maskinens interna kretsar. Utför följande:

4. Haka fast filterhållarenheten (C1) komplett med filter vid maskinen: för korrekt fasthakning, rikta in handtaget på filterhållaren med "INSERT" (fig. 8) och vrid greppet mot höger, tills det är inriktat med läget "CLOSE";
5. Placera en behållare under filterkoppens och ångröret (A5);
6. Tryck in knappen (B5) vid varningslampan (B4) (fig. 9): dispenseringen startar;
7. Vid avslutad dispensering, vrid ångvredet (A4) (fig. 10) och dispensera ånga i några sekunder för att skölja ångkretsen: för en optimal dispensering, rekommenderas det att upprepa denna procedur 3 eller 4 gånger. Detta tillåter att eliminera vattnet i röret före dispensering av ånga.

Maskinen är nu klar för användning.

**Observera:** Sköljningen av de interna kretsarna rekommenderas även om apparaten inte används under en längre tid.

Vid den första användningen är det nödvändigt att breda 4-5 kaffe innan maskinen börjar ge ett tillfredsställande resultat: var särskilt uppmärksam på mängden malet kaffe i filtret ((C2) eller (C3)) (se instruktionerna i avsnitt "4.1 Fas 1 - Malning (grinding)" (fig. 11)).

Fortsätt enligt beskrivningen i kapitel "Den perfekta dosen".

### 4. BEREDNING AV KAFFE

#### 4.1 Fas 1 - Malning (grinding) (fig. 11)

1. Håll bönorna i behållaren (A1) (fig. 12). Det rekommenderas att hälla i endast bönorna som krävs för beredningen: på detta sättet använder du alltid färskt kaffe;
2. Välj malningsgrad (fig. 13). Fabriksinställningen är 5 (medium malning). O resultatet inte är tillfredsställande, justera malningsgraden beroende på personlig smak och typen av kaffe (justeringen ska utföras när kaffekvarnen är igång).

3. För in ett av kaffefiltren (C2) eller (C3) i filterhållaren (C1) (fig. 14). Om du använder filtret för 2 koppar, tryck in knappen 2X (B3): med detta val fördubblas även mängden dispenserat espresso.

4. Justera vredet för mängden (B2) med utgång från minimumläget (fig. 15).

**Obs:**

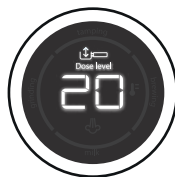

Numren som visas på displayen (B19) är en referens att anteckna när korrekt nivå har uppnåtts i filterhållaren.

De motsvarar inte inställningen av malningen, vikten av det malna kaffet (gr/oz) eller malningstiden.

Se avsnittet "B3. Knapp "X2": för att använda filtret för 2 kaffe" för ytterligare indikationer.

5. Haka fast filterhållaren vid kaffekvarnens utgång (A18) och rikta in texten INSERT: vrid sedan filterhållaren åt höger (fig. 16). Malningen startar när filterhållaren når läget CLOSE och avbryts automatiskt.

#### Justera dosen malet kaffe i filtret

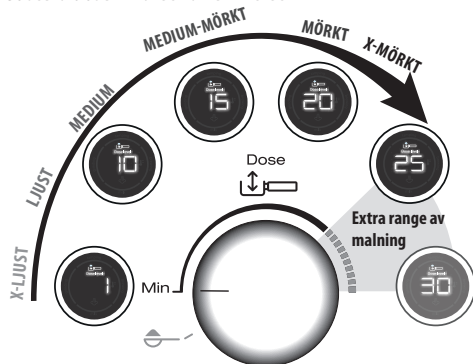

Varje typ av bönor ger ett annorlunda resultat vid malningen och därför kräver justeringen av dosen i början av malningen stor omsorg.

Denna illustration ger indikationer om hur man justerar dosen, på grundval av färgen på rostningen: de ska anses vara en utgångspunkt men kan skifta beroende på sammansättningen av kaffebönorna.

1. Ställ in dosen på minimumläge.
2. Med referens till rostningsfärgen på ditt kaffe, vrid vredet långsamt.

#### 4.2 Fas 2 - Pressning (tamping) (fig. 17)

1. Efter malningen, sänk presspaken (A20) till gränsläget (avlägsna inte filterhållaren) (fig. 18). För ett perfekt resultat, upprepa 2 gånger.

- Håll spaken nedtryckt till gränsläget under avlägsnandet av filterhållaren (fig. 19). För sedan tillbaka spaken till utgångsläget.
- När du kontrollerat att kaffedosen är korrekt (se "Den perfekta dosen"), haka fast filterhållaren på kaffedispensern (A7) (fig. 20).

### Den "perfekta dosen"

- Kaffefiltren har en invändig referens för att identifiera den perfekta dosen.



- Filter med lasermärkning: den perfekta dosen motsvarar märkningens övre linje;
- Filter med upphöjd märkning: den perfekta dosen motsvarar den upphöjda linjen;
- Försäkra dig att kaffet är vid nivå efter pressningen. Set kan vara nödvändigt att justera vredet (B2) flera gånger innan du uppnår den perfekta dosen.
- Om kaffet är över- eller underutvunnet och den interna dosen är perfekt, justera malningsgraden till mera finmålet eller grovmalet (se "4.1 Fas 1 - Malning (grinding) (fig. 11)"). Om kaffet är överutvunnet (alltför långsam dispensering), måste malningsgraden vara grövre. Om kaffet är underutvunnet (alltför snabb dispensering) måste malningsgraden vara finare.
- Bartendern rekommenderar:** Ta ut filterhållaren medan pressspaken (A20) är nedsänkt för att erhålla en perfekt finish av kaffedosen.

### 4.3 Fas 3 - Dispensering (brygning) (fig. 21)

- Välj önskad dryck (fig. 22).
- Tryck in OK (B6) för att starta dispenseringen (fig. 23) (för-brygning och brygning). Kaffedispenseringen avbryts automatiskt.

## 5. FÖRBEREDELSE AV MJÖLKDRYCKER

### 5.1 Skumma mjölken (fig. 24)

- Häll i mjölkbehållaren, (D8) mängden mjölk som du vill värma/skumma, med uppmärksamhet att mjölkens volym ökar 2 till 3 gånger (fig. 25). För att få ett tjockare och jämnare skum, rekommenderas det att använda helmjök vid kylskåpstemperatur (ungefär 5° C).

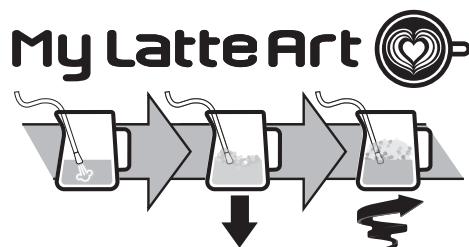

- För att skumma mjölken, placera ångröret (A5) på mjölkens yta: på så sätt blandas luften med mjölken och ångan.
- Håll ångröret på ytan, med uppmärksamhet att inte fånga upp för mycket luft och skapa alltför stora bubblor.
- Sänk ner ångröret under mjölkytan: på så sätt skapas en virvel. När önskad temperatur uppnåtts, stäng ångvredet och vänta tills dispenseringen av ånga avbryts helt innan du avlägsnar mjölkkanan.

### Bartendern rekommenderar:

- Färsk mjölk är bäst.** Använd alltid färsk mjölk vid kylskåpstemperatur.
- Helmjök garanterar utmärkta resultat. Resultatet och skummets kvalitet skiftar beroende på om du använder komjölk eller vegetabiliska drycker.
- Efter att ha skummat mjölken, eliminera bubblorna genom att skaka mjölkkanan.

### Rengöring av ångröret:

- Efter varje användning, avlägsna mjölkrester från ångröret med en duk (fig. 26). För en djup rengöring, rekommenderas det att använda Eco MultiClean: säkerställer hygien genom att avlägsna proteiner och fetter från mjölken och kan användas för att rengöra hela maskinen.
- Dispensera ånga några sekunder för att rengöra dispensern ordentligt (fig. 10).
- Vänta tills dispenseringen svalnar: för att bibehålla dispenserns effektivitet i tiden, använd rengöringsnålen (C12) för att hålla de 3 hålen fria (fig. 27).

### 5.2 Förbered mjölkdryckerna med LatteCrema System (fig. 28)

- Häll mjölk i behållaren (D8) vid kylskåpstemperatur (5° C) (fig. 29).
- Stäng locket (D1) (fig. 30).
- Vrid skumreglaget (D5) till önskat läge (fig. 31).

Position skumreglage				
CLEAN				INSERT
Rengöring efter varje användning	M A X skum	M E D skum	M I N skum	För att dra ut eller föra in vredet

- Haka fast mjölkbehållaren på maskinen (fig. 32).
- Förbered den perfekta dosen (se "4.1 Fas 1 - Malning (grinding) (fig. 11)" och "4.2 Fas 2 - Pressning (tamping) (fig. 17)") och för in filterhållaren.
- Välj önskad mjölkdryck (fig. 33).





Dryck	Espresso	Mjölk	Skum	Mängd (ml)	X2 (ml)
Cappuccino	1	✓	✓	≈150	≈230
Latte Macchiato	1	✓	✗	≈150	≈230
Flat White	1	✓	✓	≈250	≈330

- **Drycker med dubbel dos (2x):** Håll nödvändig mängd mjölk för beredningen i behållaren (D8) med uppmärksamhet att inte överskrida MAX-nivån (fig. 25). Varje hack på behållaren motsvarar ≈100 ml mjölk.
  - **Färsk mjölk är bäst.** Använd alltid färsk mjölk vid kylskåpstemperatur.
- Tryck in OK (B6) för att dispensera (fig. 23). Apparaten dispenserar automatiskt kaffe och mjölk i sekvens.

### Rengöring av Lattecrema System efter varje användning:

- Lämna mjölkbehållaren fasthakad på maskinen (det är inte nödvändigt att tömma den). Placera en behållare under mjölkkröret (D4) (fig. 34).
- Vrid vredet (D5) till "Clean" (fig. 35).

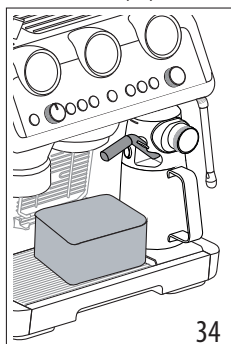





- Rengöringen startar och avbryts automatiskt. Observera: vid avslutad rengöring, vrid vredet till ett av lägena för skumjustering.

- Avlägsna mjölkbehållaren och sätt tillbaka den i kylan: vi rekommenderar att använda den resterande mjölken inom kort.

För en djup rengöring, rekommenderas det att använda Eco MultiClean: säkerställer hygien genom att avlägsna proteiner och fetter från mjölken och kan användas för att rengöra hela maskinen.

## 6. PERSONALISERA MÄNGDEN AV KAFFEDRYCKERNA MED KNAPPEN (B9)

- Förbered maskinen för att dispensera 1 eller 2 koppar av kaffedrycken som du önskar dispensera, innan du hakar fast filterhållaren (C1) komplett med filter (C2) eller (C3) och malet kaffe. Om du önskar programmera en mjölkbase-rad dryck, anslut Lattecrema System till maskinen.
- Vrid vredet (B10) för att välja drycken att programmera.
- Tryck in knappen : varningslampan motsvarande knappen OK (B6) tänds med fast ljus och varningslampan motsvarande knappen  blinkar.
- Tryck in knappen OK för att starta dispensereringen. Varningslamporna motsvarande knapparna OK och  blinkar.
- När önskad mängd uppnåtts, tryck in OK. Om drycken förutser dispenserering av en annan ingrediens, startar dispensereringen av denna: när önskad mängd uppnåtts, tryck in OK.
- Tryck in knappen  för att spara. Apparaten är klar för en ny användning och varningslampan  förblir tänd.

Om du inte vill spara programmeringen, tryck in vilken annan knapp som helst.

### Allmänna anmärkningar:

- Det är möjligt att programmera kaffedrycker, men inte dispenserering av ånga och varmt vatten.
- Programmeringen ändrar mängden av dryckerna, men inte av det malna kaffet.
- Dryckerna "X2" kan programmeras separat.
- **My LatteArt**  kan inte programmeras.
- **För att gå tillbaka till fabriksinställningarna, håll knappen  intryckt tills den släcks. Den valda drycken går tillbaka till den fabriksinställda mängden.**

Kafferecept	Fabrik-sinställd mängd	Programmerbar mängd
 Espresso	35 ml	från 25 till 90 ml
 Espresso X2	70 ml	från 50 till 180 ml

Kafferecept	Fabrik-sinställd mängd	Programmerbar mängd
Coffee	80 ml	från 50 till 120 ml
X2	160 ml	från 120 till 240 ml
Americano	120 ml	<ul style="list-style-type: none"> <li>espresso: från 25 till 60 ml</li> <li>vatten: från 25 till 120 ml</li> </ul>
X2	240 ml	<ul style="list-style-type: none"> <li>espresso: från 50 till 120 ml</li> <li>vatten: från 50 till 240 ml</li> </ul>

## 7. INSTÄLLNINGSMENY

1. Gå in i menyn:		
Tryck in samtidigt i 5 sekunder	x2	
2. Välj inställningen som ska programmeras:		
Dryck	Motsvarande inställning	Justeringar
Espresso	Energisparläge	→ <b>Aktiverad</b>
		→ <b>Avstängd</b>
Coffee	Automatisk avstängning	→ <b>9 minuter</b>
		→ <b>1,5 timmar</b>
		→ <b>3 timmar</b>
Cappuccino	Ljudsign.	→ <b>Aktiverad</b>
		→ <b>Avstängd</b>
Latte	Extra justering av malningen	→ <b>Range 1</b>
		→ <b>Range 2</b>
Flat White	Fabriksvärden	Håll knappen OK intryckt i minst 5 sekunder tills varningslampan förblir tänd med fast ljus
→		

Americano	Vatt. hårdh	→ mjukt
		→ medium
		→ hårt/mycket hårt
<b>3. Spara de nya inställningarna genom att trycka in ON/Standby (B1)</b>		

## 8. RENGÖRING AV APPARATEN

### Varning!

- Använd inte lösningsmedel, abrasiva rengöringsmedel eller alkohol för rengöring av maskinen.
- Använd inte metallföremål för att avlägsna kalkavlagringar och kaffeavlagringar, eftersom dessa skulle kunna repa metall-och plastytorna.
- För perioder av stillastående över en vecka, rekommenderas det, före användning av maskinen, att utföra en sköljning.

### Fara!

- Sänk aldrig ned maskinen i vatten, under rengöringen: det rör sig om en elektrisk apparat.
- Före varje rengöring av apparatens ytterdelar ska du stänga av maskinen, ta ut stickkontakten ur vägguttaget och låta maskinen svalna.

	DISHWASHER SAFE	Eco MultiClean			
	×	✓	✓	×	×
	✓	×	×	✓	✓
	×	×	×	✓	✓
→					

	×	×	×	✓	✓
	×	×	✓	✓	×
	×	×	×	✓	✓
	✓	✓	×	✓	✓

### 8.1 Rengöring av kaffedispensern

När varningslampan tänds (orange) (B5), är det nödvändigt att utföra rengöringen av kaffekretsen. För att utföra rengöringscykeln, köp pastillerna för rengöring av kaffemaskiner. För ytterligare informationer, besök [www.Delonghi.com](http://www.Delonghi.com).

1. För in filtret för 1 kopp (C2) i filterhållaren (C1) (fig. 36).
2. För in rengöringstillbehöret i filtret (C9) (fig. 36) och tryck till botten.

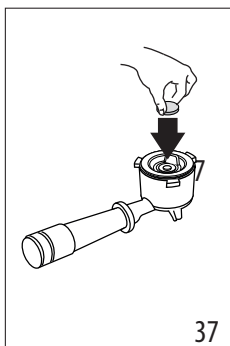
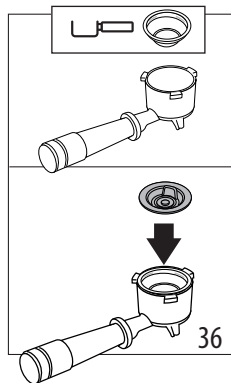

3. Placera rengöringspastillen på tillbehöret (fig. 37).
  4. Fäst filterhållaren på kaffedispensern (A7).
  5. Fyll vattentanken (A15). Försäkra dig att droppkaret (A11) är tomt.
  6. Håll knappen , intryckt tills den relativa varningslampan börjar blinka (orange). Efter några minuter avbryts rengöringen automatiskt.
- Avlägsna filterhållaren och rengöringstillbehöret.
  - Diska filterhållaren och filtret under rinnande vatten.

- Sätt tillbaka filterhållaren och utför en sköljning genom att trycka in knappen (B5): vi rekommenderar att placera en tom behållare under filterbehållaren.
- Avlägsna och töm droppkaret.

#### Observera:

Denna rengöringscykel kan startas när som helst genom att trycka in knappen (B5) i några sekunder. För att radera proceduren, tryck in knappen i 10 sekunder.

### 8.2 Rengör facket för behållaren för kaffeböner

1. Försäkra dig att behållaren för kaffeböner (A1) är tom. Utför eventuellt några malningar utan böner och töm den.
2. Haka av behållaren genom att vrida den moturs och dra ut den ur maskinen (fig. 38)

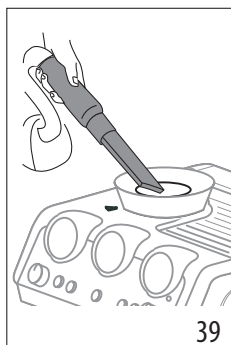
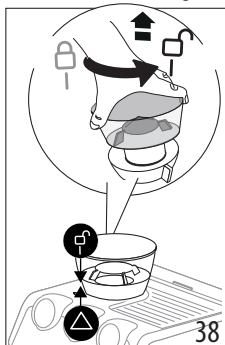

3. Sug upp kafferesterna (fig. 39).
4. Rengör utrymmet för behållaren för kaffeböner med en fuktig trasa och torka (fig. 40);

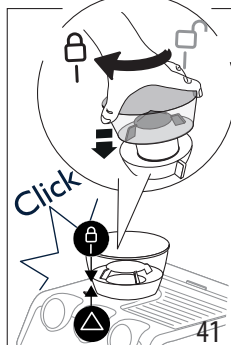
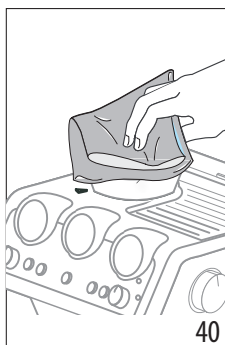

5. Sätt tillbaka behållaren och för in den i kaffekvarnen. Behållaren är korrekt införd när pilen är inriktad med symbolen och du hör ett "klick" (fig. 41).

### 8.3 Rengöring av kvarnarna

När du rengör behållaren för kaffeböner (A1), rengör behållarens utrymme och den övre kvarnen med en fuktig trasa. Kontakta ett service center för att avlägsna och byta ut kvarnarna.

Det är möjligt att avlägsna kvarnen om maskinen skulle vara blockerad av ett främmande föremål. Om detta skulle inträffa, avlägsna behållaren för kaffeböner och gör så här:

1. Haka filterkoppen (C1) och utför en "tom" malning för att befria kaffekanalerna.
2. Stäng av apparaten.
3. Vrid malningsregulatorn moturs, till gränsläget, i läge "RE-MOVE" (fig. 42).

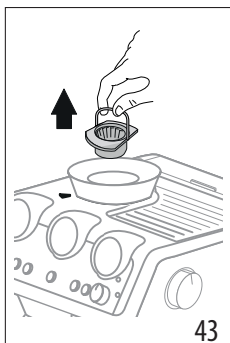
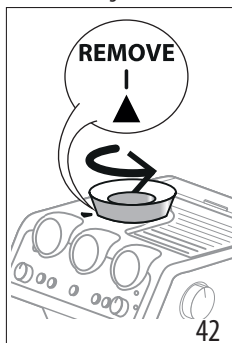

4. Dra ut den övre delen av kvarnen, genom att gripa den i det därför avsedda handtaget (fig.43).
5. Rengör maskinen med en pensel (fig. 44) och sug upp resterna av kaffe med en dammsugare (fig. 39).

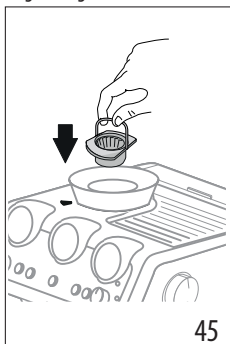
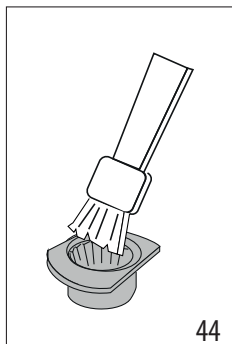

6. För in kvarnen i dess utrymme (fig. 45);
  7. Vrid regulatorn och välj önskad malningsgrad (fig. 13);
- Kontrollera att kvarnen är väl införd, genom att dra i handtaget: kvarnen är korrekt införd om den inte rör sig;

## 8.4 Utbyte av kvarnarna

När mängden malet kaffe minskar ytterligare, kontakta ett service center för att byta ut kvarnarna och justera sedan kaffekvarnen igen genom att gå in i inställningsmenyn ("7. Inställningsmeny") och välja det första området för extra justering av malningen. Vrid sedan ratten för justering av mängden (B2) till läge MIN och justera dosen som vid första användningen (se "Den perfekta dosen").

## 8.5 Rengöring av "Smart tamping station"

1. Rengör fasthållningsområdet med en pensel (fig. 46).
2. Dra spaken (A20) till gränsläget och rengör pressen med en pensel (fig.47), släpp sedan spaken.
3. Rengör med hjälp av skrapan (C8), glidbanan för kaffet (fig. 48).

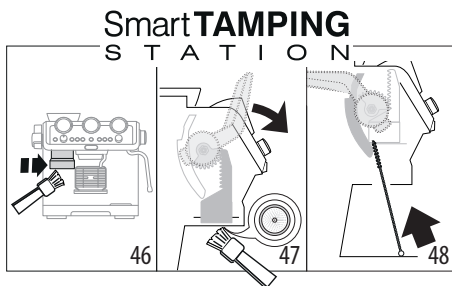

## 8.6 Rengöring av LatteCrema System

Diska alla komponenterna och behållaren i diskmaskin, med uppmärksamhet att placera dem i diskmaskinens övre korg. Om du inte har någon diskmaskin, diska dem för hand som anges i föregående avsnitt.

1. Tryck in knappen (D3) och lyft mjölkbehållarens lock (D1);
2. Dra ut kaffedispensern (D4) och uppsugsröret ((D7) (fig. 49);

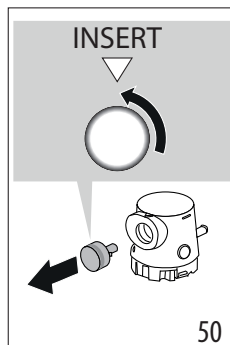
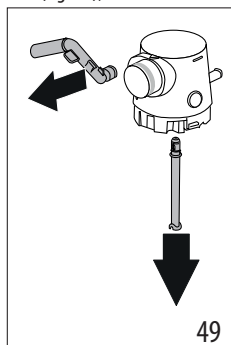

3. Vrid vredet till läge "Insert" och dra ut den (fig. 50);
4. Var särskilt uppmärksam att mjölkrester inte kvarstår i urholkningen och kanalen under vredet (fig. 51): skrapa eventuellt kanalen med en tandpetare;

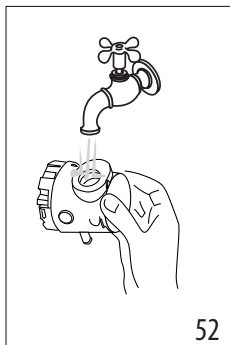
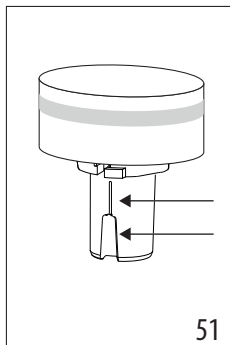

5. Skölj skumreglaget utrymme med rinnande vatten (fig. 52);
6. Kontrollera även att uppsugningsröret och dispenseringsröret inte är igtätända av mjölkrester;
7. Återmontera lockets alla komponenter;
8. Diska och skölj noggrant mjölkbehållaren (D8);
9. Haka fast locket på mjölkbehållaren igen.

**Observera: handdisk**

Maskindisk garanterar perfekt hygien för mjölkbehållarens alla komponenter: i händelse av handdisk, diska mjölkbehållarens alla komponenter noggrant med varmt vatten och sänk ner dem i en behållare med varmt vatten i ungefär 30 minuter innan du fortskrider enligt 4 punkt.

**9. VATTNETS HÅRDHET**

Indikationslampan (B8) avkalkning, tänds efter en förhandsbestämd funktionstid, som beror på vattnets hårdhet. Det är möjligt att programmera maskinen beroende på vattnets verkliga hårdhetsgrad i de olika regionerna, och på så sätt göra proceduren för avkalkning mindre frekvent.

1. Ta ut den medföljande reaktionsstickan "TOTAL HARDNESS TEST" ur förpackningen (C4).
2. För in stickan helt i ett glas vatten i ungefär en sekund.
3. Dra upp remsan ur vatten och skaka lätt. Ställ in apparaten , som anges i kapitlet "7. Inställningsmeny".

Testresultat Hårdhet	Vattnets	Knapp	Nivå
		x2	1 mjukt vatten
			2 medelhårt vatten
		OK	3 hårt eller mycket hårt vatten

4. Ställ in apparaten , som anges i kapitlet "7. Inställningsmeny".

**10. HUR MAN ANVÄNDER SOFTBALLS**

Softballs (C11) är ett innovativt system som förlänger maskinens livstid, utan att förändra vattnets kvalitet och garanterar en dispenserering av krämigt och aromatiskt kaffe. För att optimera effektiviteten, lämna Softballs i vattnet hela natten före användningen.

1. Dar ut Softballs-paketet ur förpackningen (fig. 53).

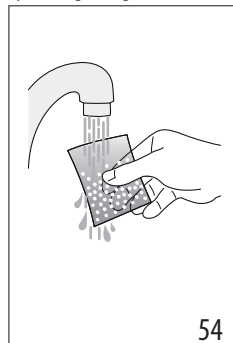
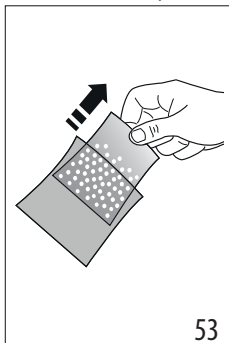

2. Skölj Softballs-paketet med rinnande vatten (fig. 54).
3. Sänk ner påsen i vattentanken (A15) (fig. 55).

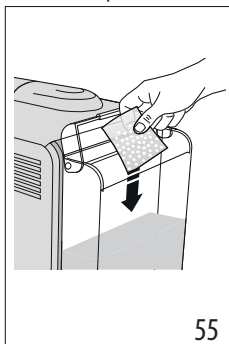

4. Byt ut Softballs-påsen var 3:e månad (fig. 56).

**11. AVKALKNING**

**Varning!**

- Före användningen läs instruktionerna och etiketterna på avkalkningsmedlet (C5), som återges på själva avkalkningsmedlets behållare.
- Vi rekommenderar att använda uteslutande avkalkningsmedel från De'Longhi. Användning av ej lämpliga avkalkningsmedel, liksom ej regelmässigt utförd avkalkning, kan medföra uppkomst av defekter, som inte täcks av tillverkarens garanti.
- Avkalkningsmedlet kan skada de ömtåliga ytorna. Om produkten hålls ut oavsiktligt, torka upp omedelbart.

För att utföra avkalkningen	
Avkalkningsmedel	Avkalkningsmedel De'Longhi
Behållare	2 på 1 liter vardera
Tid	~40min

- (OM NÄRVARANDE, TA UT AVHÄRDNINGSFILTRET OCH SOFTBALLS). Häll avkalkningsmedlet i vattentanken (A15) till nivån A  A (motsvarande en förpackning på 100ml) som är tryckt på tankens insida (fig. 57).

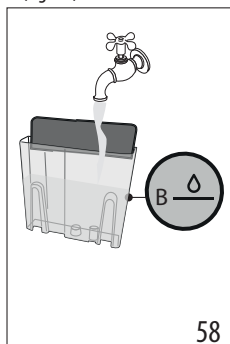
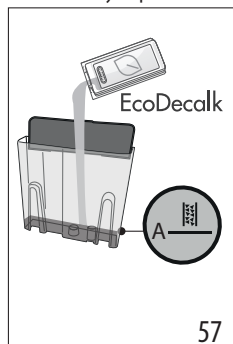

- Tillsätt vatten tills du når nivån  B (fig. 58). För sedan in vattentanken i maskinen igen.
- För in tillbehöret (C6) på anslutningen för LatteCrema System (A6) (fig. 59).

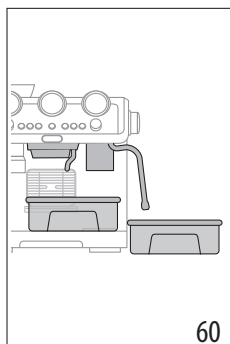
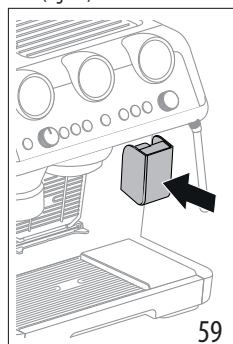

- Försäkra dig att filterhållaren (C1) inte är fasthakad och placera en behållare under dispensarna för kaffe och varmt vatten (A7), och under ångröret (A5) (fig. 60).
- Håll knappen  (B8) intryckt tills den motsvarande varningslampan börjar blinka.
- Avkalkningsprogrammet startar och avkalkningsmedlet kommer ut från dispensarna. Avkalkningsprogrammet utför automatiskt en rad sköljningar med intervaller, för att avlägsna kalkavlagringarna från kaffemaskinens inändöme tills behållaren töms.

Dispenseringen avbryts och varningslampan  blir vit. Det är således nödvändigt att utföra sköljningscykeln:

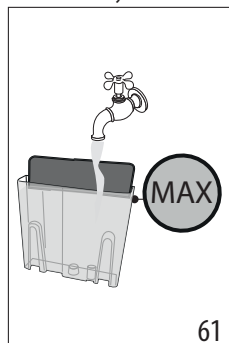

- Töm behållaren som använts för att samla upp avkalkningsvätskan och sätt tillbaka den under dispensarna.
- Dra ut vattentanken, töm den från eventuella rester av avkalkningsmedel, skölj den med rinnande vatten och fyll den med färskt vatten upp till MAX nivån (fig. 61). För sedan in tanken i dess utrymme.













- Håll knappen  intryckt tills motsvarande varningslampan börjar blinka: sköljningen startar.
- När sköljningen har fullbordats, avbryts dispenseringen och apparaten är klar för användning.
- Töm behållarna för uppsamling av sköljvattnet.
- Dra ut och töm droppkaret och för sedan in det igen.
- Dra ut och fyll tanken med färskt vatten och sätt sedan tillbaka den.











Maskinen är nu redo för användning.

#### Allmänna anmärkningar:

- Om du önska tidigarelägga avkalkningscykeln håll knappen  intryckt i 3 sekunder.
- Om avkalkningen skulle ha startats av misstag, tryck in knappen  i 10 sekunder, sköljningen kan inte avbrytas.

## 12. INDIKATIONSLAMPORNAS BETYDELSE



INDIKATIONSLAMPOR	INDIKATIONSLAMPORNAS BETYDELSE	ÅTGÄRD
Alla indikationslamporna blinkar samtidigt	Påslagning av maskinen	Självd diagnos
 fast	Det är den första påslagningen av maskinen och det är nödvändigt att utföra påfyllningen av vattenkretsen	Utför vad som anges i kap. "3. Första ibruktandandet av maskinen"
 fast	Energibesparingen är aktiverad	Se kap. "7. Inställningsmeny" om du önskar inaktivera funktionen
 fast	Behållaren för kaffeböner (A1) är tom	Fyll på behållaren för kaffeböner
 blinkande	Om du vill fortsätta med malningen, men behållaren för kaffeböner (A1) är tom	Fyll på behållaren för kaffeböner
 på	Vattnet i tanken (A15) är inte tillräckligt eller så är inte kaffetanken ordentligt införd	Fyll på tanken eller dra ut och sätt tillbaka tanken korrekt
 blinkande	Du vill bereda en dryck men vattentanken (A15) är tom	Fyll vattenbehållaren
 fast	Allmänt larm	Kontakta ett servis center
 fast	Behållaren för kaffeböner är inte införd	För in behållaren för kaffeböner korrekt (A1) eller kontrollera att den är korrekt införd
 blinkande	Väljaren på basen av behållaren för kaffeböner (A1), är inte i korrekt läge	För tillbaka väljaren till ett av lägena för malning (mellan 1 och 8) och kom ihåg att: <ul style="list-style-type: none"> <li>• Justera malningen medan kaffekvarnen är igång</li> <li>• Justera med en nivå åt gången och utföra minst 5 malningar mellan en justering och den påföljande</li> </ul>
	Behållaren för kaffeböner (A1) är inte helt införd: säkerhetsanordningen utlöses	Kontrollera att behållaren för kaffeböner är korrekt införd
 fast	LatteCrema System måste rengöras efter varje användning	Efter att ha avslutat beredningen av mjölkdrycker utför en automatisk rengöring genom att vrida vredet (D5) till Clean
 fast	Apparaten är klar för dispensering av ånga.	Apparaten har uppnått temperaturen för att dispensera ånga. För att utföra dispensereringen, vrid ångvredet (A4)
		→





INDIKATIONSLAMPOR	INDIKATIONSLAMPORNAS BETYDELSE	ÅTGÄRD
 blinkande	Apparaten är påslagen och energibesparingen är aktiverad: ångvredet (A4) är i läge för att dispensera ånga	Indikationslampan blinkar för att ange att apparaten förbereder sig för att dispensera ånga: dispenseringen startar så snart apparaten nått temperaturen
	Apparaten är klar för dispensering av ånga	Apparaten är vid temperatur för beredning av ånga när varningslampan lyser med fast ljus
	Apparaten dispenserar ånga	
 fast (orange)	Det är nödvändigt att utföra avkalkningen	Utför avkalkningen som illustreras i kap. "11. Avkalkning"
 blinkande (orange)	Apparaten utför avkalkningen	Fortsätt och komplettera proceduren som beskrivs i kap. "11. Avkalkning"
 fast (vitt)	Det är nödvändigt att utföra sköljningen	
 blinkande (vitt)	Apparaten utför sköljningen	
 fast (orange)	Det är nödvändigt att utföra rengöringen av kaffedispensern	Se par. "8.1 Rengöring av kaffedispensern"
 blinkande (orange)	Apparaten utför rengöring av kaffedispensern	
 blinkande (vitt)	Apparaten utför en sköljning	
 +  blinkande	Om avkalkningsfiltret är närvarande, kan en luftbubbla ha kommit in i kretsen och hindra dispenseringen	Tryck in knappen (B7) i höjd med varningslampan  : dispenseringen startar och avbryts automatiskt.
	Malningen är för fin och kaffet kommer därför ut för långsamt eller inte alls.	Dra ut filterhållaren (C1), upprepa procedurerna för att bereda kaffet, med hänsyn till indikationerna i avs. "4.1 Fas 1 - Malning (grinding) (fig. 11)" och "4.2 Fas 2 - Pressning (tamping) (fig. 17)"
	Kaffefiltret (C2) eller (C3) är igensatt	Skölj filtren under rinnande vatten eller utför en sköljning med sköljningsknappen (B5).
	Tanken (A15) är felaktigt införd och de relativa ventilerna är öppna	Tryck lätt på tanken så att ventilerna öppnas
	Kalk på hydraulkretsens insida	Utför avkalkning som i kap. "11. Avkalkning"

### 13. OM NÅGOT INTE FUNGERAR

FEL	ORSAK	LÖSNING
Det finns vatten i droppkaret (A11)	Det är en del av den normala funktionen av maskinens interna kretsar	Töm och rengör regelbundet droppkaret (A11)
		→



FEL	ORSAK	LÖSNING
Det kommer inget mer espressokaffe	För lite vatten i behållaren (A15)	Fyll behållaren
	Indikationslampan  (B7) är tänd för att ange att kaffekretsen eller ångkretsen är tom.	Tryck in knappen som motsvarar varningsslampan  för att fylla kretsen.
	Filtret (C2) eller (C3) är igentäppt	Skölj filtrena under rinnande vatten eller utför en sköljning med den relativa knappen (B5)
	Behållaren (A15) är felaktigt isatt och ventilerna i botten är inte öppna	Tryck lätt på behållaren för att öppna ventilerna i botten
	Kalk på hydraulkretsens insida	Utför avkalkning som i kap. "11. Avkalkning"
	Alltför finmalet	Dra ut filterhållaren (C1), upprepa procedurerna för att bereda kaffet, med hänsyn till indikationerna i avs. "4.1 Fas 1 - Malning (grinding) (fig. 11)" och "4.2 Fas 2 - Pressning (tamping) (fig. 17)"
Filterhållaren hakar inte fast på apparaten	Det malna kaffet har inte pressats eller är överdrivet	Upprepa malningen med annorlunda inställningar. Minska dosen: kontrollera att filtret (C2) eller (C3) (1 eller 2 koppar) är korrekt för dosen som ska malas (knapp 2x (B3) vald eller inte)
Espressokaffet droppar från filterhållarens (C1) kanter istället för från hålen	Filterhållaren är dåligt införd	Haka fast filterhållaren korrekt och vrid den med kraft ända ner i botten
	Kaffedispenserns packning (A7) har förlorat elasticitet eller är smutsig	Byt ut kaffedispenserns packning hos ett service center
	Filtret (C2) eller (C3) är igentäppt	Skölj filtren under rinnande vatten eller utför en sköljning med motsvarande knapp (B5)
Krämen på kaffet är ljus (kaffet rinner snabbt från munstycket)	Det är nödvändigt att se över apparatens inställningar	Dra ut filterhållaren, upprepa procedurerna för att bereda kaffet, med hänsyn till indikationerna i avs. "4.1 Fas 1 - Malning (grinding) (fig. 11)" och "4.2 Fas 2 - Pressning (tamping) (fig. 17)"
Krämen på kaffet är mörk (kaffet rinner långsamt från pipen)	Det är nödvändigt att se över apparatens inställningar	Dra ut filterhållaren (C1), upprepa procedurerna för att bereda kaffet, med hänsyn till indikationerna i avs. "4.1 Fas 1 - Malning (grinding) (fig. 11)" och "4.2 Fas 2 - Pressning (tamping) (fig. 17)"
		→

FEL	ORSAK	LÖSNING
Mjölkskummet bildas inte medan du bereder cappuccino med LatteCrema System	Mjölken är inte tillräckligt kall	Använd alltid mjölk vid kylskåpstemperatur
	Vredet (D5) är inte i korrekt läge	Kontrollera och vrid vredet till rätt läge (  max skum;  med skum;  min skum )
	LatteCrema System är smutsigt	Utför rengöringen som illustreras i avsnitt "8.6 Rengöring av LatteCrema System"
	Kalk på hydraulkretsens insida	Utför avkalkning som i kap. "11. Avkalkning"
Vid avslutad avkalkning kräver apparaten ytterligare en sköljning	Behållaren har inte fyllts till MAX-nivå under sköljningen	Upprepa sköljningen (se kap. "11. Avkalkning")
Apparaten maler inte kaffe	Det finns ett främmande föremål inuti kaffekvarnen	Utför rengöringen av kvarnarna enligt avs. "8.3 Rengöring av kvarnarna", och försäkra dig att du avlägsnat alla bönrorna från behållaren för kaffeböner (A2) innan du drar ut den. Innan du för in kvarnen, sug noggrant ut alla rester från dess utrymme
	Behållaren för kaffeböner (A1) är inte i rätt läge	Behållaren är korrekt införd när pilen ▲ är inriktad med symbolen  och du hör ett "klick"
Om du önskar byta kaffesort	Det är nödvändigt att avlägsna alla kaffebönrorna i maskinen	<ul style="list-style-type: none"> <li>• Töm behållaren för kaffeböner (A1) (genom att utföra tomma malningar eller eventuellt suga upp de kvarstående bönrorna).</li> <li>• Haka fast filterhållaren (C1) och utför en "tom" malning, för att befria kaffekanalerna: haka sedan fast filterhållaren vid kaffekvarnens utgång (A18) rikta in texten INSERT och vrid filterhållaren åt höger (fig. 22). Malningen startar när filterhållaren når läget CLOSE och avbryts automatiskt. Upprepa tills filtret är tomt</li> <li>• För in i behållaren (A1) den nya typen av kaffeböner</li> <li>• Om den "perfekta dosen" inte uppnås vid malningen, upprepa proceduren för första användningen</li> </ul>
		→

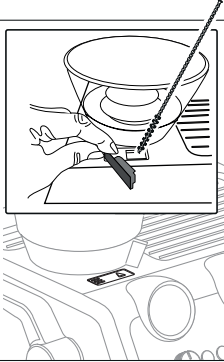
FEL	ORSAK	LÖSNING
<p>Kaffefiltret (C2) eller (C3) är tomt efter malningen</p> <p>Efter malningen är kaffepulvret i filtret för mycket</p>	<p>Kaffekvarnens glidbana är igentäppt</p>	<p>Utför rengöringen enligt avs. "8.5 Rengöring av "Smart tamping station"". Om felet kvarstår, kom åt glidbanan genom att öppna den därför avsedda luckan (A19) och befria den med användning av borsten</p> 
<p>Efter malningen uppnår inte kaffet i filtret (C2) eller (C3) den "perfekta dosen"</p>	<p>"Smart Tamping Station" behöver rengöras</p> <p>Det är nödvändigt att justera mängden malet kaffe</p> <p>Kvarnarna slits med tiden</p>	<p>Utför rengöringen enligt avs. "8.5 Rengöring av "Smart tamping station"", upprepa sedan malningen</p> <p>Justera mängden med det avsedda vredet (B2) genom att följa indikationerna i avs. "Den "perfekta dosen"". Om vredet redan är i läge max, fortsätt som anges i avsnitt "Extra justering av malningen"</p> <p>Utför bytet av kvarnarna enligt indikationerna i avs. "8.4 Utbyte av kvarnarna"</p>

Læs altid sikkerhedsadvarselne inden du bruger maskinen.

## 1. BESKRIVELSE

### 1.1 Beskrivelse af maskinen - A

- A1. Kaffebønnebeholder
- A2. Låg til kaffebønnebeholder
- A3. Kopbakke
- A4. Dampknap
- A5. Dampdyse
- A6. Stik til Lattecrema system
- A7. Kaffeudløb
- A8. Rist til kopbakke til espresso
- A9. Rist til kopbakke til glas eller krus
- A10. Bakkerist
- A11. Drypbakke
- A12. Vandniveaumåler i drypbakke
- A13. Låg til vandbeholder
- A14. Håndtag til udtag af vandbeholder
- A15. Vandbeholder
- A16. Opbevaringssted for strøm kabel
- A17. Hovedafbryder (ON/OFF)
- A18. Udtag til kaffekværn (Tamping station)
- A19. Luge der giver adgang til kaffekværn
- A20. Stempel

### 1.2 Beskrivelse af kontrolpanelet - B

- B1. Knap til ON/Standby
- B2. Knap til regulering af mængde formalet kaffe
- B3. "X2"-knap til brug af filteret 2 kopper kaffe
- B4. "Kaffe-temperatur"-knap
- B5. Knap til "skylning"
- B6. "OK" knap: til udledning af drik/bekræftelse af drik
- B7. Knap til "udledning af varmt vand"
- B8. "Afkalknings"-knap
- B9. "My" knap: til indstilling af foretrukken mængde af drik
- B10. Knap til funktionsvalg
- B11. Visning af drikke;

#### Espressokaffebaserede drikke

- Espresso
- Americano
- Coffee

#### Mælkebaserede drikke

- Cappuccino
  - Flat White
  - Latte Macchiato
- B12. "Mælerengørings"-kontrollampe
  - B13. "Bønnebeholder mangler"-knap
  - B14. Kontrollampe "generel alarm"
  - B15. Manometer
  - B16. Kontrollampe "vandmangel"

B17. "Bønneneholder tom"-kontrollampe

B18. Kontrollampe "energibesparelse"

B19. Visning af indstillinger og proces:

- Angiver den funktion, som enheden er i gang med at udføre
- Angiver indstillingen af den valgte kaffedosis
- Angiver indstillingen på den valgte kaffe

### 1.3 Beskrivelse af tilbehøret - C

- C1. Filterholder
- C2. Filter til 1 kop
- C3. Filter til 2 kopper
- C4. Målestrimmel "Total Hardness Test"
- C5. Afkalkningsmiddel
- C6. Tilbehør til afkalkning
- C7. Aftaglig el-ledning
- C8. Børste
- C9. Tilbehør til rengøring af kaffeudløb
- C10. Klud
- C11. Softballs (blødgøringsmiddel)
- C12. Rengøringsnål til dampstang

### 1.4 Rengøringstilbehør ikke inkluderet, anbefalet af producenten

For mere information, besøg [Delonghi.com](http://Delonghi.com).



#### Rengøringstabletter

(Se "8.1 Rengøring af kaffebryggeren")

 **Afrenser**  
EAN: 8004399333307

### 1.5 Beskrivelse af Lattecrema systemet - D

- D1. Låg til mælkebeholder
- D2. Stik til mælkebeholder
- D3. Knap til frigørelse af låg
- D4. Mælkestuds (justerbar højde)
- D5. Skumregulator
- D6. Regulatorens sæde
- D7. Opsugningsrør til mælk
- D8. Mælkebeholder

## 2. TÆNDING AF MASKINEN

Vask tilbehøret med lunkent vand og opvaskemiddel og fortsæt som følger:

1. Indsæt drypbakken (A11) inklusive kopbakkeristen (A9) og bakkeristen (A10) (fig 1);

2. Tag vandbeholderen ud (A15) (fig. 2) og fyld den op med frisk, rent vand. Pas på, at vandet ikke overstiger MAX-strengen (fig. 3).
3. Genindsæt beholderen.

**Advarsel:** Tænd aldrig for maskinen, hvis der ikke er vand i beholderen, eller hvis beholderen er blevet fjernet.

**Bemærk:** Det anbefales at tilpasse vandhårdhedsgraden snarest muligt ved at følge proceduren, beskrevet i kapitel "7. Menu indstillinger".

### 3. FØRSTE ANVENDELSE AF MASKINEN

1. Sæt strømstikket (C7) i lejet (A16) på bagsiden af maskinen (fig. 4); sæt derefter stikket i stikkontakten. Sørg for, at hovedafbryderen (A17) på bagsiden af maskinen er blevet tændt I (fig. 5);
2. Anbring en beholder med en minimumskapacitet på 100 ml under varmtvandsbeholderen (nær kaffedispenseren (A7)) (fig. 6);
3. Tryk på knappen (B7) der svarer til kontrollampen  (fig. 7): brygningen begynder og afbrydes automatisk. Tøm beholderen.

Inden maskinen tages i brug er det nødvendigt at skylle alle interne kredsløb igennem. Gå frem som følger:

4. Isæt filterholderen (C1) på maskinen: for at sætte den rigtigt i skal håndtaget på filterholderen være lige ud for symbolet "INSERT" (fig. 8) og drej håndtaget mod højre indtil det er lige ud for "CLOSE";
5. Sæt en beholder under filterholderkoppen og dampdysen (A5);
6. Tryk på den knap (B5) der svarer til kontrollampen  (fig. 9): brygningen begynder;
7. Efter brygningen drejes dampknappen (A4) (fig. 10) og dampdysen i et par sekunder for at skylle dampkredsløbet: For optimal dampudløb anbefales det at gentage denne handling 3 eller 4 gange. Dette tillader, at vandet i røret elimineres, før der laves damp.

Nu er maskinen klar til brug.

**Bemærk:** hvis maskinen ikke har været i brug i længere tid anbefales det at skylle det interne kredsløb.

Første gang du bruger maskinen, skal der laves 4-5 kopper kaffe, inden kaffemaskinen begynder at give et tilfredsstillende resultat: vær særligt opmærksom på den doserede mængde formalet kaffe i filtret ((C2) eller (C3)) (se vejledningen i afsnit "4.1 Fase 1 - Maling (grinding) (fig. 11)").

Fortsæt som angivet i kapitel "Den "perfekte dosis"".

### 4. KAFFETILBEREDNING

#### 4.1 Fase 1 - Maling (grinding) (fig. 11)

1. Hæld bønnerne i beholderen (A1) (fig. 12). Det tilrådes kun at bruge de nødvendige bønner til tilberedning: på denne måde bruger du altid frisk kaffe;

2. Vælg malegrad (fig. 13). Fabriksindstillingen er 5 (medium maling). Hvis resultatet ikke er tilfredsstillende, skal niveauet justeres efter personlig smag og typen af kaffe (justeringen skal foretages, mens kaffekværnen kører).
3. Indsæt et af kaffefiltrene (C2) eller (C3) i filterholderen (C1) (fig. 14). Hvis du bruger filteret til 2 kopper, skal du trykke på 2X-knappen (B3): med dette valg fordobles også den leverede mængde espresso.
4. Juster kvantitetsknappen (B2) startende fra minimumspositionen (fig. 15).

**Bemærk venligst:**



Tallene, der vises på displayet (B19), er en henvisning til notering når det korrekte niveau i filterholderen er nået.

De svarer ikke til formalingsindstillingerne, vægten af den malede kaffe (gr/oz) eller formalingstiden.

Se afsnit "B3. "X2"-knap til brug af filteret 2 kopper kaffe" for yderligere information.

5. Sæt filterholderen på kaffekværnens hane (A18) centrert det med skriften INSERT: drej filterholderen mod højre (fig. 16). Formalingen begynder når filterholderen står på CLOSE og den stopper automatisk.

#### Reguler mængden af formalet kaffe i filtret

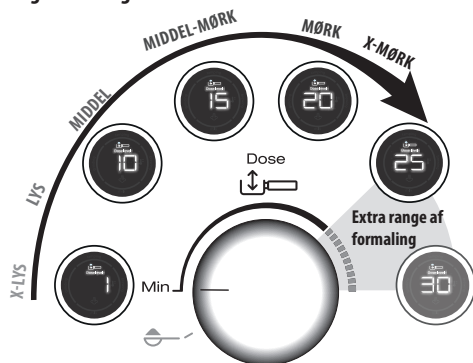

Hver sort af bønner giver forskellige resultater under formaling, og af denne grund kræver dosisjusteringen forsigtighed i starten.

Denne illustration giver indikationer på, hvordan dosis justeres, baseret på ristefarven: det skal betragtes som et udgangspunkt, men det kan variere alt efter kaffebønnernes sammensætning.

1. Indstil dosis fra minimumspositionen.
2. Drej langsomt på knappen med henvisning til din kaffes ristefarve.

## 4.2 Fase 2 - presning (stampning) (fig. 17)

1. Efter formalingen skal presses håndtaget (A20) ned så langt som muligt (tag ikke filterholderen ud) (fig. 18). Gentag 2 gange for at få det bedste resultat.
2. Hold håndtaget så langt nede som muligt, mens du fjerner filterholderen (fig. 19). Sæt derefter håndtaget tilbage i dets oprindelige position.
3. Når du har kontrolleret, at kaffedosis er korrekt (se "Den perfekte dosis"), skal du fastgøre filterholderen til kaffedløbet (A7) (fig. 20).

### Den "perfekte dosis"

- Kaffefiltrene har et indvendigt referencemærke, der viser den perfekte mængde.



- Filtre med lasermærkning: den perfekte mængde svarer til mærkningens øverste linje;
- Filtre med præget mærkning: den perfekte mængde svarer til den frmhævede linje;
- Sørg for, at kaffen er på niveau efter presning. Det kan være nødvendigt at justere knappen flere gange (B2), før du når den perfekte dosis.
- Hvis kaffen over- eller underekstraheres, og dosis er inden for den perfekte dosis, skal du justere graden afformaling finere eller grovere (se "4.1 Fase 1 - Maling (grinding) (fig. 11)"). Hvis kaffen overekstraheres (for langsom brygning), skal formalingen være grovere. Hvis kaffen er underekstraheret (for hurtigt brygning) skal formalingen være finere.
- **Baristaen anbefaler:** Fjern filterholderen, mens pressehåndtaget (A20) er sænket for at opnå en perfekt finish på kaffedosis.

## 4.3 Fase 3 - Brygning (fig. 21)

1. Vælg den ønskede drik (fig. 22).
2. Tryk på OK (B6) for at starte brygning (fig. 23) (præinfusion og infusion). Kaffebrygningen stopper automatisk.

## 5. TILBEREDNING AF MÆLKEDRIKKE

### 5.1 Skum mælken (fig. 24)

1. Hæld den mælkemængde, der skal opvarmes/skummes i mælkebeholderen (D8) under hensyntagen til, at mælkemængden øges 2 eller 3 gange (fig. 25). For at opnå et mere tæt og homogent skum anbefales det at bruge hel kosødmælk ved køleskabstemperatur (ca. 5 °C).

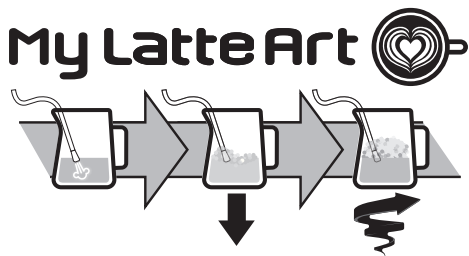

2. For at skumme mælken skal du placere dampdysen (A5) på mælkens overflade. Derved blandes luften med mælken og dampen.
3. Hold dampdysen på overfladen, pas på ikke at opsamle for meget luft og skabe for store bobler.
4. Nedsenk dampdysen under mælkens overflade: dette skaber en hvirvel. Når den ønskede temperatur er nået luk dampknappen og vent på, at damptilførslen stopper helt, før mælkekanden fjernes.

### Baristaen anbefaler:





- **Frisk mælk er bedst.** Brug altid frisk mælk ved køleskabstemperatur.
- Sødsmælk sikrer fremragende resultater. Resultatet og skumets struktur varierer alt efter den anvendte komælk eller vegetabiliske drikkevarer.
- Efter skumning af mælken skal fjernes boblerne ved at ryste mælkekanden.

### Renngøring af dampdysen:

1. Fjern alle mælkerester fra dampdysen efter hver brug med en klud (fig. 26). Til grundig rengøring tilrådes det at bruge Eco MultiClean: det sikrer hygiejne ved at fjerne mælkeproteiner og fedtstoffer og kan bruges til at rengøre hele maskinen.
2. Lav damp i et par sekunder for at rengøre dysen grundigt (fig. 10).
3. Vent til bryggeren er afkølet: for at bevare bryggerens effektivitet, brug da rengøringsnålen ((C12) for at holde de 3 huller frie (fig.27).

### 5.2 Forbered mælkedrikke med LatteCrema System (fig. 28)

1. Hæld i mælk med køleskabstemperatur (D8) imælkebeholderen (5°C) (fig. 29).
2. Luk låget (D1) (fig. 30).
3. Drej skumjusteringsknappen (D5) til den ønskede position (fig. 31).

Skumjusteringsknapposition				
				
CLEAN				INSERT

Ren- gøring efter hver brug	M A X skum	M E D skum	M I N skum	For at udtrække eller indsætte knappen
--------------------------------------	---------------	---------------	---------------	--

- Hægt mælkebeholderen på maskinen (fig. 32).
- Forbered den perfekte dosis (se "4.1 Fase 1 - Maling (grinding) (fig. 11)" e "4.2 Fase 2 - presning (stamping) (fig. 17)"), og isæt filterholderen.
- Vælg den ønskede mælkedrik (fig. 33).

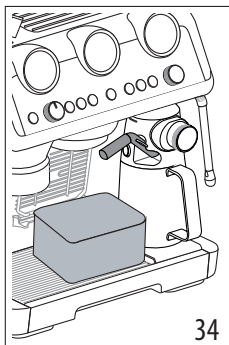
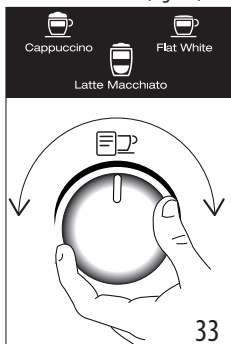

Drikkevarer	Espresso	Mælk	Skum	Mængde (ml)	X2 (ml)
Cappuccino	1	✓	✓	≈150	≈230
Latte Macchiato	1	✓	✗	≈150	≈230
Flat White	1	✓	✓	≈250	≈330

- Dobbeltdosis drikkevarer (2x):** Hæld den krævede mængde mælk tilberedning i beholderen (D8), og pas på ikke at overskride MAX-niveauet (fig. 25). Hvert mærke på beholderen svarer til ≈100 ml mælk.
  - Frisk mælk er bedst.** Brug altid frisk mælk ved køleskabstemperatur.
- Tryk på OK (B6) for at brygge (fig. 23). Maskinen brygger automatisk kaffe og mælk i rækkefølge.

#### Rengøring af Lattecrema-systemet efter hver brug:

- Lad mælkebeholderen sidde fast på maskinen (det er ikke nødvendigt at tømme den). Anbring en beholder under mælkeudløbet (D4) (fig. 34).
- Drej knappen (D5) til "Clean" (fig. 35).

- Rengøring starter og stopper automatisk. Advarsel: Efter rengøring skal du dreje knappen til en af positionerne for skumjustering.
  - Fjern mælkebeholderen og læg den i køleskabet: det tilrådes at bruge den resterende mælk kort tid efter.
- Til grundig rengøring tilrådes det at bruge Eco MultiClean: det sikrer hygiejne ved at fjerne mælkeproteiner og fedtstoffer og kan bruges til at rengøre hele maskinen.







#### 6. INDSTIL MÆNGDE AF VAND I KAFFERNE EFTER EGEN SMAG MED KNAPPEN (my) (B9)

- Forbered maskinen på at udlede 1 eller 2 kopper ønsket kaffedrik indtil filterholderen (C1) er komplet med filter (C2) eller (C3) formalet kaffe. Hvis du vil programmere en mælkebaseret drik, skal Lattecrema-systemet tilsluttes maskinen.
  - Drej på knappen (B10) for at vælge den drik, der skal programmeres.
  - Tryk på knappen (my): kontrollampen, der svarer til OK-knappen (B6), tændes konstant, og kontrollampen, der svarer til knappen (my), blinker.
  - Tryk på OK-knappen for at starte brygningen. Kontrollampene, der svarer til OK, (my) blinker.
  - Når den ønskede mængde er nået tryk på OK. Hvis drikken forudsiger brygningen af en anden ingrediens, begynder brygningen af sidstnævnte: når den ønskede mængde er nået trykkes på OK.
  - Tryk på knappen (my) for at gemme. Maskinen er klar til ny brug, og kontrollampen (my) forbliver tændt.
- Hvis man ikke vil gemme programmeringen trykkes på en hvilken som helst anden knap.











#### Bemærk venligst:















- Man kan programmere drikke med kaffe, men ikke brygning af damp og varmt vand.
- Programmeringen ændrer mængden af drikke, men ikke af den formalede kaffe.
- "X2"-drikkene kan programmeres separat.

- **My LatteArt**  ikke programmerbart.
- **For at vende tilbage til fabriksindstillingerne holdes knappen nede**  **indtil den slukker. Den valgte drik vender tilbage til fabriksindstillingsmængden.**

Kaffeopskrift	Fabrik-indstilling-smængde	Programmerbar mængde
 Espresso	35 ml	fra 25 til 90 ml
 Espresso X2	70 ml	fra 50 til 180 ml
 Coffee	80 ml	fra 50 til 120 ml
 Coffee X2	160 ml	fra 120 til 240 ml
 Americano	120 ml	<ul style="list-style-type: none"> <li>• espresso: fra 25 til 60 ml</li> <li>• vand: fra 25 til 120 ml</li> </ul>
 Americano X2	240 ml	<ul style="list-style-type: none"> <li>• espresso: fra 50 til 120 ml</li> <li>• vand: fra 50 til 240 ml</li> </ul>

## 7. MENU INDSTILLINGER

1. Gå ind i menuen:		
Tryk samtidigt i 5 sekunder	x2	
2. Vælg den indstilling der skal programmeres:		
		
Drikkevarer	Tilsvarende indstilling	Justeringer
 Espresso	Energibesparelse	 →  <b>Aktiv</b>
		 →  <b>Slukket</b>
 Coffee	Auto-sluk	 → <b>9 minutter</b>
		 → <b>1,5 time</b>
		 → <b>3 timer</b>
→		

 Cappuccino	Lydsignal	 →  <b>Aktiv</b>
		 →  <b>Slukket</b>
 Latte	Ekstra regulering af formaling	 → <b>Range 1</b>
		 → <b>Range 2</b>
 Flat White	Nulstil til standard	Hold OK-knappen nede i mindst 5 sekunder, indtil kontrollampen lyser konstant
 Americano	Vandets hårdhedsgrad	 → <b>blødt</b>
		 → <b>medium</b>
		 → <b>hårdt/meget hårdt</b>
<b>3. Gem de nye indstillinger ved at trykke på ON/Standby (B1)</b>		
		
		

## 8. RENGØRING AF MASKINEN













### Advarsel!

- Der må ikke anvendes opløsningsmidler, slibende rengøringsmidler eller sprit til rengøring af kaffemaskinen.
- Anvend ikke metalgenstande til at fjerne kalk eller kaffeaflejringer, da de kan ridse metal- eller plastikoverfladerne.
- I perioder hvor den ikke tages i brug i mere end en uge anbefales det at skylle den, før maskinen tages i brug.

### Fare!

- Dyp aldrig maskinen i vand, når den rengøres: Kaffemaskinen er et elektrisk apparat.
- Inden apparatets udvendige dele rengøres, skal man slukke kaffemaskinen, tage stikket ud af stikkontakten og lade maskinen køle af.





					
	×	✓	✓	×	×
	✓	×	×	✓	✓
	×	×	×	✓	✓
	×	×	×	✓	✓
	×	×	✓	✓	×
	×	×	×	✓	✓
	✓	✓	×	✓	✓

### 8.1 Rengøring af kaffebryggeren

Når kontrollampen  tændes (orange) (B5), er det nødvendigt at rengøre kaffekredsløbet. For at køre rengøringscyklussen skal der købes rengøringstabletter til kaffemaskiner. For mere information, besøg [www.Delonghi.com](http://www.Delonghi.com).

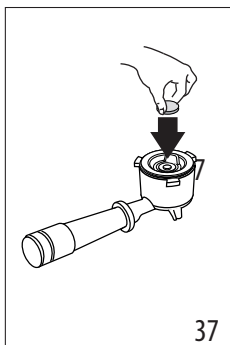
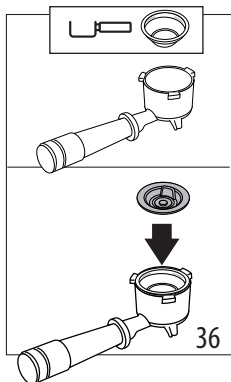
1. Indsæt filter til 1 kop (C2) i filterholderen (C1) (fig. 36).
2. Sæt rengøringsudstyret i filteret (C9) (fig. 36), og tryk det helt ned.



3. Sæt rengøringstabletten på tilbehøret (fig. 37).
4. Fastgør filterholderen til kaffebryggeren (A7).
5. Fyld vandtanken (A15). Sørg for, at drypbakken (A11) er tom.
6. Hold knappen nede , indtil kontrollampen begynder at blinke (orange). Efter et par minutter stopper rengøringscyklussen automatisk.
  - Fjern filterholderen og rengøringstilbehøret.
  - Vask filterholderen og filteret under rindende vand.
  - Sæt filterholderen i igen, og fortsæt med skylning ved at trykke på knappen  (B5): det anbefales at placere en beholder under filterholderen.
  - Fjern og tøm drypbakken.

#### Bemærk:

Denne rengøringscyklus kan startes når som helst ved at trykke på knappen  (B5) i et par sekunder. For at annullere handlingen skal du trykke på knappen i 10 sekunder.

### 8.2 Rengør bønnebeholderens leje

1. Sørg for, at bønnebeholderen (A1) er tom. Forsæt med omvendt med et par tomme malinger for at tømme det.
2. Fjern beholderen ved at dreje den mod uret, og tag den ud af maskinen (fig. 38)

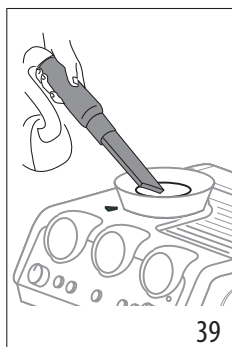
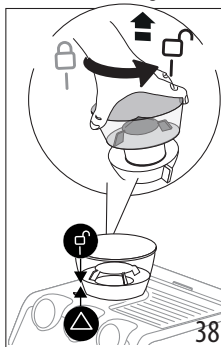

3. Støvsug kafferesterne op (fig. 39).
4. Rengør lejet til bønnebeholderen med en fugtig klud og tør (fig. 40);

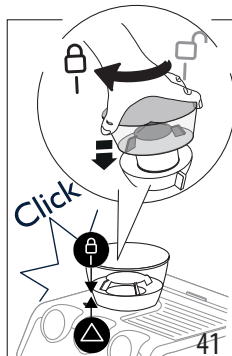
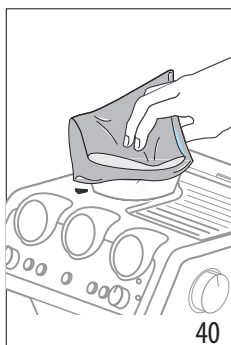

- Genindsæt beholderen ved at sætte den i kaffekværnen. Beholderen er indsat korrekt, når pilen ▲ er justeret med symbolet ☒ og du hører et "klik" (fig. 41).

### 8.3 Rengøring af kaffekværnene

Når du rengør bønnebeholderen (A1), skal du rengøre beholderens leje og den øverste kværn med en fugtig klud. Kontakt et servicecenter for at fjerne og udskifte kværnen.

Kværnen kan fjernes, hvis kværnen er blokeret af et fremmedlegeme. Hvis dette sker, fjern bønnebeholderen og fortsæt som følger:

- Fastgør filterholderkoppen (C1), og udfør en "tom" formaling for at frigøre kaffekanalene.
- Sluk for maskinen.
- Drej formalingsregulatoren helt i bund imod urets retning, til "REMOVE" (fig. 42).

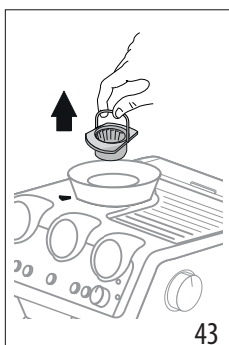
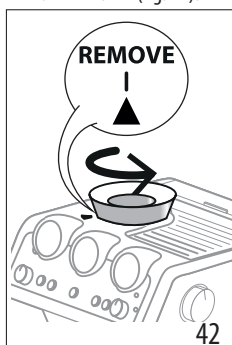

- Fjern den øverste del af kværnen ved at tage den i hånden (fig. 43).
- Rengør kværnen med en pensel (fig. 44) og støvsug kaffesterrene (fig. 39).

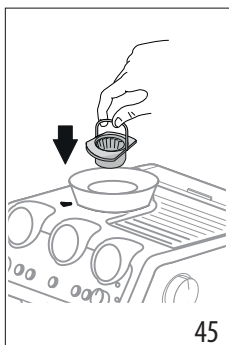
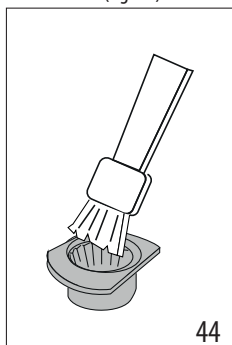

- Genindtæt kværnen i lejet (fig. 45);
- Drej regulatoren alt efter hvilken grad af formaling der ønskes (fig. 13);

Kontroller at kværnen er sat godt i ved at trække i håndtaget: kværnen er isat korrekt hvis ikke den bevæger sig;

### 8.4 Udskiftning af kaffekværnene

Når mængden af formalet kaffe reduceres yderligere, kontakt et servicecenter for at udskifte kværnen: Juster derefter kværnen igen ved at gå til indstillingsmenuen ("7. Menu indstillinger") og vælg det første interval for den ekstra formalingsjustering. Drej derefter mængdejusteringsknappen til (B2) MIN-position, og juster dosis som ved første brug (se "Den "perfekte dosis"").

### 8.5 Rengøring af "Smart tamping station"

- Rengørpåhægtingsstedet med en pensel (fig. 46).
- Træk håndtaget (A20) i bund og rengør presseren med en børste (fig. 47), og slip derefter håndtaget.
- Rengør kaffetragten med den lille børste (C8) (fig. 48).

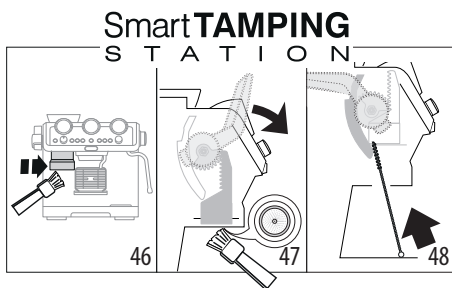

### 8.6 Rengøring af Lattecrema Systemet

Beholderen og alle dele kan tåle maskinopvask, hvis de placeres i opvaskemaskinens øverste kurv. Hvis man ikke har en opvaskemaskine, skal man vaske op i hånden som angivet i note i slutningen af afsnittet.

- Tryk på knappen (D3) og løft låget på mælkebeholderen (D1);
- Fjern mælkedispenseren (D4) og sugeslangen ((D7) (fig. 49);

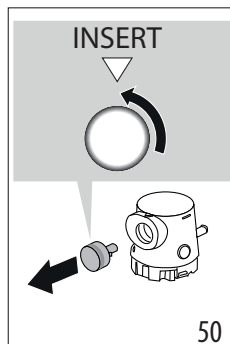
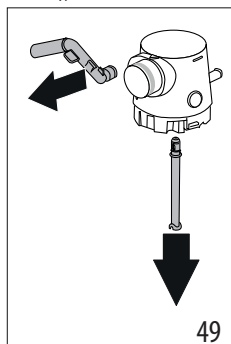

- Drej knappen til "Insert" position, og fjern den (fig. 50);

4. Vær særlig opmærksom på, at der ikke er mælkerester i fordybningen og rillen under knappen (fig. 51): Skrab om nødvendigt rillen med et tandstikker;

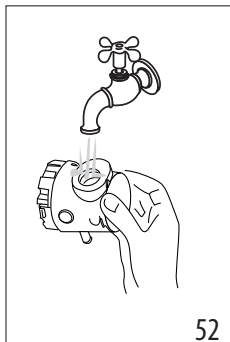
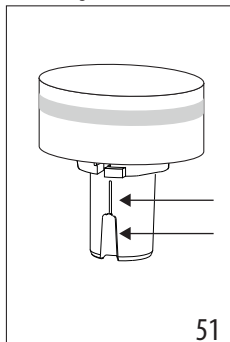

5. Skyl skumregulatorens indvendige leje under rindende vand (fig. 52);  
 6. Kontrollér, at sugerøret og udløbsrøret ikke er tilstoppede af mælkerester;  
 7. Saml derefter alle lågets komponenter igen;  
 8. Vask og skyl mælkebeholderen grundigt (D8);  
 9. Sæt låget fast på mælkebeholderen igen.

**Bemærk: vaskes i hånden**

Vask i opvaskemaskinen sikrer perfekt hygiejne for alle komponenter i mælkebeholderen: i tilfælde af håndvask, vask alle komponenter i mælkebeholderen grundigt med varmt vand og sænk dem ned i en skål varmt vand og lad dem stå i ca. 30 minutter, før man fortsætter som angivet i punkt 4.

**9. VANDETS HÅRDHEDSGRAD**

Kontrollampen (B8), der indikerer afkalkning, tænder efter en forudbestemt periode, som afhænger af vandets hårdhedsgrad. Det er muligt at programmere kaffemaskinen i overensstemmelse med vandets reelle hårdhed i området. På den måde skal afkalkning udføres mindre ofte.

1. Tag den medfølgende teststrimmel "TOTAL HARDNESS TEST" ud af pakningen (C4).
2. Dyp strimlen helt ned i et glas vand i ca. et sekund.
3. Tag strimlen op af vandet, og ryst den let. Indstil maskinen som angivet i kapitel "7. Menu indstillinger".

Resultat af Vandets Hårdhedsgrad	Knap	Niveau
	x2	1 blødt vand
		2 mellemhårdt vand

Resultat af Vandets Hårdhedsgrad	Knap	Niveau
		3 hårt eller meget hårdt vand

4. Indstil maskinen som angivet i kapitel "7. Menu indstillinger".

**10. SÅDAN BRUGES SOFTBALLS**

Softballs (C11) er et innovativt system, der forlænger maskinens levetid uden at ændre vandets kvalitet, hvilket garanterer brygning af en cremet og aromatisk kaffe. For at maksimere effektiviteten skal du efterlade Softballs i vandet natten over inden brug.

1. Fjern Softballs fra emballagen (fig. 53).

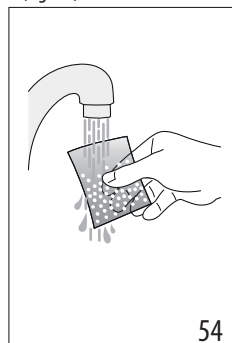
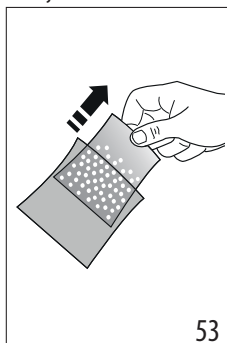

2. Skyl Softballpakken under rindende vand (fig. 54).  
 3. Sænk posen ned i vandtanken (A15) (fig. 55).

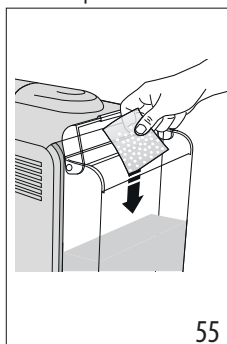

4. Udskift posen med Softballs hver 3. måned (fig. 56).

**11. AFKALKNING**

**Advarsel!**

- Læs instruktionerne og etiketten på afkalkningsmidlets pakning (C5), inden du afkalker maskinen.
- Det anbefales at kun anvende De'Longhi afkalkningsmiddel. Brugen af uegnede afkalkningsmidler samt uregel-

mæssig afkalkning, kan medføre, at der opstår fejl, som ikke dækkes af fabrikantens garanti.

- Afkalkningsmidlet kan beskadige sarte overflader. Hvis produktet, ved et uheld, hældes ud, skal man straks tørre det op.

Sådan afkalker du	
Afkalkningsmiddel	De'Longhi afkalkningsmiddel
Beholdere	2 af hver 1 liter
Tid	~40min

1. (HVIS DE FINDES, FJERN BLØDGØRINGSFILTER OG SOFTBALLS). Hæld afkalkningsmiddel i vandtanken (A15) op til niveau  A (svarende til en 100 ml pakke) markeret på indersiden af tanken (fig. 57).

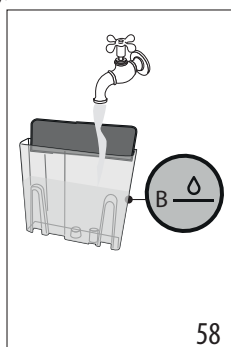
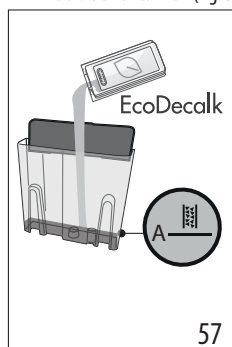

2. Tilsæt vand, indtil det når niveau  B (fig. 58). Sæt derefter vandtanken tilbage i maskinen.
3. Sæt tilbehøret (C6) ind i stikket til LatteCrema System (A6) (fig. 59).

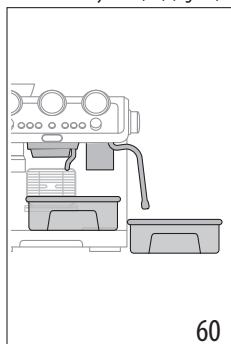
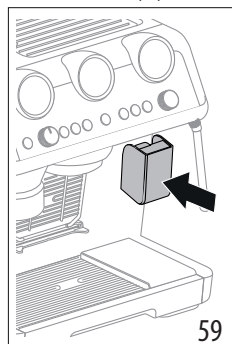



4. Sørg for, at filterholderen (C1) ikke er tilsluttet, og anbring en beholder under kaffe- og varmtvandsudløbene (A7) og under dampdysen (A5) (fig. 60).
5. Hold knappen nede  (B8) indtil den tilsvarende kontrollampe begynder at blinke.

6. Afkalkningsprogrammet starter, og afkalkningsvæsken kommer ud af tudene. Afkalkningsprogrammet udfører automatisk en række skylninger med mellemrum, for at fjerne kalkaflejringer inde i kaffemaskinen indtil tanken er fuldstændigt tømt.

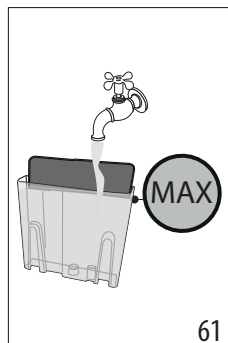

Udløbet afbrydes og kontrollampen  bliver hvid. Det er nu nødvendigt at fortsætte med en skylningscyklus:

7. Tøm beholderen der er brugt til at opsamle afkalkningsmidlet og sæt den under udlejerne.
8. Tag vandbeholderen ud, tøm den for eventuelle rester af afkalkningsmiddel, skyl den med rindende vand og fyld den med rent vand op til MAX niveau (fig. 61). Sæt beholderen på plads.

























9. Hold knappen nede  indtil den tilsvarende kontrollampe begynder at blinke: skylningen går i gang.
10. Når skylningen er udført afbrydes udløbet og maskinen er klar til brug.
11. Tøm beholderen med det opsamlede skyllevand.
12. Tag drypbakken ud og tøm den for skyllevand.
13. Tag beholderen ud og fyld den med rent vand og sæt den tilbage. Nu er maskinen klar til brug.

#### Bemærk venligst:



- Hvis man vil fremskynde afkalkningscyklussen, skal knappen  holdes nede i 3 sekunder.
- Hvis afkalkningen er startet ved en fejltagelse, trykkes på knappen  i 10 sekunder; skylning kan ikke afbrydes.

## 12. KONTROLLAMPERNES BETYDNING

KONTROLLAMPER	KONTROLLAMPERNES BETYDNING	DRIFT
Alle kontrollamperne blinker kort	Tænding af apparatet	Selvdiagnose
 lyser fast	Det er første gang maskinen anvendes og det er nødvendigt at fylde vandkredsløbet	Fortsæt som angivet i kap. "3. Første anvendelse af maskinen"
 lyser fast	Energisparefunktionen er aktiv	Se kap. "7. Menu indstillinger" hvis man vil deaktivere funktionen
 lyser fast	Kaffebønnebeholder (A1) er tom	Fyld kaffebønnebeholder
 blinker	Man ønsker at formale, men bønnebeholderen (A1) er tom	Fyld kaffebønnebeholder
 on	Der er ikke nok vand (A15) i beholderen eller vandbeholderen er ikke ordentligt sat i	Fyld beholderen eller tag den ud og sæt den i korrekt
 blinker	Man ønsker at tilberede en drik, men vandbeholderen (A15) er tom	Fyld vandbeholderen op
 lyser fast	General alarm	Ret henvendelse til servicecenter
 lyser fast	Bønnebeholderen er ikke sat i	Sæt bønnebeholderen i korrekt (A1) eller kontroller at den er korrekt isat
 blinker	Vælgeren på bønnebeholderen (A1) er ikke positioneret korrekt	Sæt vælgeren i en af malepositionerne (mellem 1 og 8), og husk på: <ul style="list-style-type: none"> <li>• Juster formalingen mens kværnen kører</li> <li>• Juster et niveau ad gangen, og lav mindst 5 malinger mellem den ene indstilling og den næste</li> </ul>
	Bønnebeholderen (A1) er ikke helt sat i: sikkerhedsanordningen griber ind	Kontroller, at bønnebeholderen er korrekt isat
 lyser fast	Lattecrema Systemet skal rengøres efter ethvert brug	Når tilberedning af mælkebaserede præparater er afsluttet, fortsæt med automatisk rengøring ved at dreje knappen (D5) til Clean
 lyser fast	Maskinen er klar til at udlede damp.	Maskinen er nået temperaturen til at udlede damp. For at fortsætte med brygningen skal dampknappen drejes (A4)
→		

KONTROLLAMPER	KONTROLLAMPERNES BETYDNING	DRIFT
 blinker	Maskinen er tændt og energisparefunktionen er aktiv: dampknappen (A4) er i position til at udlede damp	Kontrollampen blinker for at advare om at den er på vej til at udlede damp: udledningen begynder så snart maskinen har den rette temperatur
	Maskinen er klar til at udlede damp	Maskinen har den rette temperatur til forberedelse af damp når kontrollampen forbliver tændt
	Maskinen udleder damp	
 Lyser fast (orange)	Det er nødvendigt at udføre afkalkning	Udfør en afkalkning som angivet i kap. "11. Afkalkning"
 blinker (orange)	Maskinen udfører afkalkning	Fortsæt med at afslutte handlingen som beskrevet i kap. "11. Afkalkning"
 Lyser fast (hvid)	Det er nødvendigt at foretage en skylning	
 blinker (hvid)	Maskinen er i gang med at udføre en skylning	
 lyser fast (orange)	Det er nødvendigt at udføre en rengøring af kaffebryggeren	Se afs. "8.1 Rengøring af kaffebryggeren"
 blinker (orange)	Maskinen er i gang med at udføre rengøring af kaffebryggeren	
 blinker (hvid)	Maskinen er i gang med at udføre en skylning	
 +  blinker	Hvis blødgøringsfilteret er til stede, kan en luftboble være kommet ind i kredsløbet, hvilket forhindrer brygning	Tryk på den knap (B7), der svarer til kontrollampen  : brygning starter og stopper automatisk.
	Malegraden er for fin, og kaffen løber for langsomt eller slet ikke ud.	Tag filterholderen ud (C1), gentag handlingen for at lave kaffe imens man husker på anvisningerne i afsn. "4.1 Fase 1 - Maling (grinding) (fig. 11)" og "4.2 Fase 2 - presning (stampning) (fig. 17)"
	Kaffefilteret (C2) eller (C3) er stoppet	Skyl filtrene under rindende vand eller skyl med skylleknappen (B5).
	Tanken (A15) er isat forkert, og dens ventiler er ikke åbne	Tryk let på tanken for at åbne ventilerne
	Kalk inden i det hydrauliske kredsløb	Udfør en afkalkning som angivet i kap. "11. Afkalkning"

### 13. HVIS NOGET IKKE VIRKER

PROBLEM	ÅRSAG	LØSNING
Der er vand i drypbakken (A11)	Det er en del af normal drift af maskinens interne kredsløb	Tøm og rengør drypbakken regelmæssigt (A11)
Der løber ikke længere espressokaffe ud	Der mangler vand i vandbeholderen (A15)	Fyld vandbeholderen op
	Kontrollampen  (B7) er tændt for at angive, at kaffe- eller dampkredsløbet er tomt.	Tryk på knappen ud for kontrollampen  for at fylde kredsløbet.
	Filteret (C2) eller (C3) er tilstoppet	Skyl filterene under rindende vand eller udfør en skylning ved hjælp af knappen (B5)
	Vandbeholderen (A15) sidder ikke rigtigt, og ventilerne på dens bund er ikke åbne	Tryk let på vandbeholderen for at åbne ventilerne på dens bund
	Kalk inden i det hydrauliske kredsløb	Udfør en afkalkning som angivet i kap. "11. Afkalkning"
	Formaling er alt for fin	Tag filterholderen ud (C1), gentag handlingen for at lave kaffe imens man husker på anvisningerne i afsn. "4.1 Fase 1 - Maling (grinding) (fig. 11)" og "4.2 Fase 2 - presning (stampning) (fig. 17)"
Filterholderen er ikke hægtet på maskinen	Den formalede kaffe er ikke blevet presset eller forefindes i overdreven mængde	Gentag formalingen med andre indstillinger. Reducer dosis mængden: Kontroller, at filteret (C2) eller (C3) (1 eller 2 kopper) er korrekt for den dosis, der skal males (2x knap (B3) valgt eller ikke)
Espressokaffen siver ud over filterholderens kanter (C1) i stedet for gennem hullerne	Filterholderen sidder ikke rigtigt	Hægt filterholderen korrekt på og drej den til bunds med bestemtthed
	Kaffebryggerens pakning (A7) har tabt elasticiteten eller er beskidt	Udskift pakningen på kaffebryggeren hos et service center
	Filteret (C2) eller (C3) er tilstoppet	Skyl filterene under rindende vand eller skyl med skylleknappen (B5)
Kaffecremen er lys (espressokaffen løber hurtigt ud af kaffestudsen)	Det er nødvendigt at gennemgå maskinens indstillinger	Tag filterholderen ud, gentag handlingen for at lave kaffe imens man tager anvisningerne i afsn. "4.1 Fase 1 - Maling (grinding) (fig. 11)" og "4.2 Fase 2 - presning (stampning) (fig. 17)"
Kaffecremen er mørk (espressokaffen løber for langsomt ud af kaffestudsen)	Det er nødvendigt at gennemgå maskinens indstillinger	Tag filterholderen ud (C1), gentag handlingen for at lave kaffe imens man husker på anvisningerne i afsn. "4.1 Fase 1 - Maling (grinding) (fig. 11)" og "4.2 Fase 2 - presning (stampning) (fig. 17)"
		→

PROBLEM	ÅRSAG	LØSNING
Mælkeskummet formes ikke imens man laver cappucino med LatteCrema Systemet	Mælken er ikke kold nok	Brug altid køleskabskold mælk
	Håndtaget (D5) er ikke i korrekt position	Kontroller og drej knappen til den rigtige position ( ☺ maks. Skum; ☻ medium skum; ☹ min. Skum )
	LatteCrema-systemet er snavset	Fortsæt med rengøringen som illustreret i afsnittet "8.6 Rengøring af Lattecrema Systemet"
	Kalk inden i det hydrauliske kredsløb	Udfør en afkalkning som angivet i kap. "11. Afkalkning"
Efter afkalkningscyklussens afslutning anmoder maskinen om en yderligere skylning	Under skyllecyclussen er beholderen ikke blevet fyldt til niveauet MAX	Gentag skylningen (se kap. "11. Afkalkning")
Maskinen formaler ikke kaffen	Der er et fremmedlegeme tilstede internt i kaffekværnen	Udfør rengøring som beskrevet i afsn. "8.3 Rengøring af kaffekværnene", sørg for at have fjernet alle kaffebønner fra beholderen (A2) inden den tages af. Inden kværnen genindsættes skal lejet støvsuges for enhver rest
	Bønneholderen (A1) er ikke positioneret korrekt	Beholderen er indsat korrekt, når pilen ▲ er justeret med symbolet ☒, og der høres et "klik"
Hvis man ønsker at skifte kvaliteten af kaffen	Er det nødvendigt at fjerne alle eksisterende kaffebønner i maskinen	<ul style="list-style-type: none"> <li>• Tøm kaffebønne beholderen (A1) (ved at udføre nogle formalinge uden kaffebønner eller ved eventuelt at støvsuge resterende bønner op).</li> <li>• Sæt filterholderen (C1) på og lav en "tom" formaling for at frigøre kaffe-kanalen: sæt filterholderen på hanen til formalet kaffe (A18) ved at centrere den med teksten INSERT og dreje holderen mod venstre (fig. 22). Formalingen begynder når filterholderen står på CLOSE og den stopper automatisk. Gentag indtil filteret er tomt</li> <li>• Sæt det nye sortiment af kaffebønner i beholderen (A1)</li> <li>• Hvis den "perfekte dosis" ikke nås under formaling, fortsættes som ved første brug</li> </ul>
		→

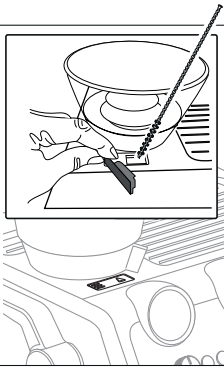

PROBLEM	ÅRSAG	LØSNING
<p>Efter formaling er kaffefilteret (C2) eller (C3) tomt</p> <p>Efter formalingen er der for meget kaffepulver i filtret</p>	<p>Tragten på kaffekværnen er stoppet</p>	<p>Udfør rengøring som beskrevet i afs. "8.5 Rengøring af "Smart tamping station"". Hvis problemet fortsætter, skal du åbne renden ved at åbne lugen (A19) og frigøre den med børsten</p> 
<p>Efter formaling når kaffepulveret i filteret (C2) eller (C3) når ikke den "perfekte dosis"</p>	<p>"Smart Tamping Station" skal rengøres</p> <p>Det er nødvendigt at øge mængden af formalet kaffe</p> <p>Kværnene slides med tiden</p>	<p>Udfør rengøring som beskrevet i afs. "8.5 Rengøring af "Smart tamping station"", gentag derfor formalingen</p> <p>Regulér mængden med den særlige knap (B2) ved at følge anvisninger i afsn. "Den "perfekte dosis"". Hvis knappen allerede er i maks. position fortsættes som angivet i afsnittet "Ekstra regulering af formaling"</p> <p>Udfør udskiftning af kværnene som beskrevet i afsn. "8.4 Udskiftning af kaffekværnene"</p>

Lue aina turvallisuusohjeet sisältävä asiakirja ennen laitteen käyttöä.

## 1. KUVAUUS

### 1.1 Laitteen kuvaus - A

- A1. Kahvipapusailiö
- A2. Kahvipapusailiön kansi
- A3. Kuppialusta
- A4. Höyrynuppi
- A5. Höyryn annosteluputki
- A6. Lattecrema System järjestelmän liitin
- A7. Kahvisuutin
- A8. Espresso-kuppiritilä
- A9. Kuppiritilä laseille tai mukeille
- A10. Alustan ritilä
- A11. Tippa-alusta
- A12. Tippa-alustan veden tason ilmaisin
- A13. Vesisäiliön kansi
- A14. Vesisäiliön irrotuskahva
- A15. Vesisäiliö
- A16. Virtajohtoon liittimen kiinnityskohta
- A17. Virtakatkaisin (ON/OFF)
- A18. Kahvimyllyn ulostulokohta (Tamping station)
- A19. Luukku kahvimyllyn kahvikourua varten
- A20. Tamperin vipu

### 1.2 Ohjauspaneelin kuvaus - B

- B1. ON/Standby-näppäin
- B2. Jauhetun kahvin määrän säätönuppi
- B3. Näppäin "X2": 2 kahvin suodattimen käyttämiseksi
- B4. Kahvin lämpötilan näppäin
- B5. Huuhtelunäppäin
- B6. "OK"-näppäin: juoman annostelu/vahvistus
- B7. Kuumen veden annostelunäppäin
- B8. Kalkinpoistonäppäin
- B9. "My"-näppäin: juomien määrän muokkaus
- B10. Toimintojen valintanuppi
- B11. Juomien näyttö

#### Espresso-kahvipohjaiset juomat

- Espresso
- Americano
- Coffee

#### Maitopohjaiset juomat

- Cappuccino
- Flat White
- Latte Macchiato

- B12. Maitosäiliön puhdistuksen merkkivalo
- B13. Kahvipapusailiön puuttumisen merkkivalo
- B14. Yleinen hälytysmerkkivalo
- B15. Painemittari

- B16. Veden puuttumisen merkkivalo
- B17. Tyhjän kahvipapusailiön merkkivalo
- B18. Energiansäästön merkkivalo"
- B19. Asetusten ja etenemisen näyttö:
  - Näyttää toimenpiteen, joka on meneillään
  - Näyttää valitun kahviannosasetuksen
  - Näyttää valitun kahvin lämpötila-asetuksen

### 1.3 Varusteiden kuvaus - C

- C1. Suodatinkuppipidike
- C2. 1 kupin suodatin
- C3. 2 kupin suodatin
- C4. "Total Hardness Test"-reagenssiliuska
- C5. Kalkinpoistoaine
- C6. Kalkinpoistoväline
- C7. Irrotettava virtajohto
- C8. Puhdistusharja
- C9. Kahvisuuttimen puhdistusväline
- C10. Liina
- C11. Softballs (veden pehmentin)
- C12. Höyrysuuttimen puhdistusneula

### 1.4 Valmistajan suosittelemat puhdistusvarusteet, jotka eivät kuulu toimitukseen

Lue lisää sivulta [Delonghi.com](http://Delonghi.com).



#### Puhdistustabletit

(Katso "8.1 Kahvisuuttimen puhdistus")



#### Puhdistusaine

EAN: 8004399333307

### 1.5 LatteCrema System -järjestelmän kuvaus - D

- D1. Maitosäiliön kansi
- D2. Maitosäiliön liitin
- D3. Kannen lukituksen avauspainike
- D4. Korkeussuunnassa säädettävä maitosuutin
- D5. Vaahdon säätönuppi
- D6. Nupin paikka
- D7. Maidon imuputki
- D8. Maitosäiliö

## 2. KEITTIMEN VALMISTELU

Pese kaikki lisävarusteet haalealla vedellä ja astianpesuaineella ja toimi sitten seuraavasti:

1. Laita tippa-alusta (A11), jossa on kuppiritilä (A9) ja alustan ritilä (A10) (kuva 1).

2. Irrota vesisäiliö (A15) (kuva 2) ja täytä se raikkaalla ja puhtaalla vedellä. Ole tarkkana, ettei MAX-kirjoitus ylitä (kuva 3).
3. Laita säiliö sitten takaisin paikoilleen.

**Varoitus:** Keittintä ei saa koskaan käynnistää, ellei säiliössä ole vettä tai ellei säiliö ole paikoillaan.

**Tärkeää:** Säädä veden kovuus mahdollisimman pian noudattamalla ohjeita, jotka on annettu luvussa ”7. Asetusten valikko”.

### 3. ENNEN KEITTIMEN KÄYTTÖÖNOTTOA

1. Aseta virtajohdon liitin (C7) paikoilleen (A16) keittimen taakse (kuva 4). Laita sitten pistoke pistorasiaan. Varmista, että laitteen takaosassa oleva virtakatkaisin (A17) on painettu asentoon I (kuva 5).
2. Laita kuumavesisuuttimen alle (kahvisuuttimen kohdalle (A7)) astia, jonka tilavuus on vähintään 100 ml (kuva 6).
3. Paina näppäintä (B7) merkkivalon ☞ (kuva 7) kohdalla: annostelu alkaa ja päättyy automaattisesti. Tyhjännä astia.

Ennen kuin keittintä aletaan käyttää, sen sisäpiirit on huuhdeltava. Toimi seuraavasti:

4. Kiinnitä suodattimella varustettu suodatinkuppipidike (C1) keittimeen: sen oikeaan kiinnittymistä varten aseta suodatinkupin kahva kohdakkain symbolin ”INSERT” kanssa (kuva 8) ja käännä kahvaa oikealle, kunnes se asettuu ”CLOSE”-kohtaan;
5. Laita astia suodatinpidikkeen ja höyrysuuttimen alle (A5).
6. Paina näppäintä (B5) merkkivalon ☞ (kuva 9) kohdalla: annostelu alkaa.
7. Kun annostelu on päättynyt, käännä höyrynuppia (A4) (kuva 10) ja annostele höyryä muutaman sekunnin ajan höyrypiirin huuhtelemiseksi: parasta höyryannostelua varten suosituksena on toistaa tämä toimenpide 3–4 kertaa. Näin putkessa oleva vesi voidaan poistaa ennen höyryn annostelua.

Näin keitin on käyttövalmis.

**Tärkeää:** Sisäisten piirien huuhtelua suositellaan tehtäväksi myös silloin, kun keittintä ei käytetä pitkään aikaan.

Ensimmäisellä käyttökerralla tulee valmistaa 4–5 kahvia ennen kuin keittimen valmistama kahvi on hyvää. Kiinnitä huomiota erityisesti: suodattimessa olevaan kahvijauheen määrään ((C2) tai (C3)) (katso ohjeet kappaleesta ”4.1. Vaihe - Jauhatus (grinding) (kuva 11)”).

Toimi noudattamalla ohjeita luvusta ”Täydellinen annos”.

## 4. KAHVIN VALMISTUS

### 4.1 1.Vaihe - Jauhatus (grinding) (kuva 11)

1. Lisää pavut säiliöön (A1) (kuva 12). Suosituksena on, että kahvipapuja lisätään ainoastaan valmistuksessa tarvittava määrä: näin kahvi on aina tuoretta.
2. Valitse jauhatuskarkeus (kuva 13). Oletusasetuksena on 5 (keskihieno jauhatu). Jos tulos ei tyydytä, säädä tasoa

oman makusi ja kahvityypin mukaan (säätö tulee tehdä kahvimyllyn toimiessa).

3. Laita yksi kahvisuodattimista (C2) tai (C3) suodatinpidikkeeseen (C1) (kuva 14). Jos käytät 2 kupin suodatinta, paina näppäintä 2X (B3): kun tämä on valittuna, myös annostellun espresson määrä kaksinkertaistuu.
4. Säädä määrän nuppia (B2) minimiasennosta alkaen (kuva 15).

**Tärkeää:**



Näytössä näkyvät numerot (B19) ovat viite, joka tulee merkitä muistiin, kun suodatinpidikkeen oikeaoppinen taso on saavutettu.

Ne eivät vastaa jauhatusasetuksia, jauhetun kahvin painoa (g/oz) tai jauhatusaikaa.

Katso lisätieto kappaleesta ”B3. Näppäin ”X2”: 2 kahvin suodatintimen käyttämiseksi”.

5. Kiinnitä suodatinpidike kahvimyllyn ulostulokohtaan (A18) kohdistamalla se INSERT-tekstiin ja käännä suodatinkupia (kuva 16) sitten oikealle. Jauhatus alkaa, kun kuppi saavuttaa CLOSE-asennon ja keskeytyy automaattisesti.

### Säädä kahvijauheen määrää suodattimessa

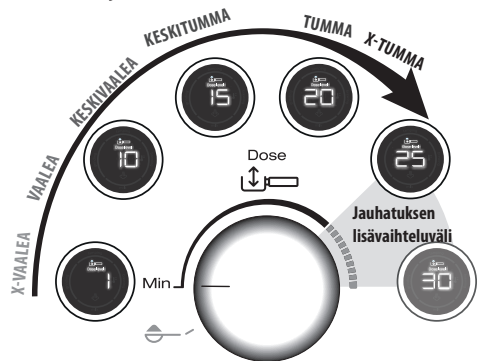

Jokainen kahvipapulaji antaa eri jauhatustuloksen, joten annoksen säätö tulee tehdä tarkoin alussa.

Tässä kuvassa näytetään, miten annos säädetään paahotvärin perusteella: tiedot ovat suuntaa antavia ja voivat vaihdella kahvipapujen koostumuksen perusteella.

1. Aseta annos minimiasennosta.
2. Käännä nuppia hitaasti kahvin paahotvärin perusteella.

### 4.2 2.Vaihe - Tamppaus (tamping) (kuva 17)

1. Kun jauhatu on valmis, laske tamppausvipu (A20) loppuun asti (älä irrota suodatinpidikettä (kuva 18). Täydellistä tulosta varten toista 2 kertaa.

2. Pidä vipua painettuna loppuasennossa suodatinpidikkeen irrotuksen ajan (kuva 19). Tuo vipu sitten alkuasentoon.
3. Kun on tarkistettu, että kahviannos on oikein (katso "Täydellinen annos"), liitä suodatinpidike kahvisuuttimeen (A7) (kuva 20).

### Täydellinen annos

- Kahvisuodattimilla on sisäinen merkintä ihanteellisen annoksen tunnistamiseksi.



- Lasermerkinnällä varustetut suodattimet: täydellinen annos vastaa merkinnän ylintä viivaa;
- Kohomerkinnällä varustetut suodattimet: täydellinen annos vastaa koholla olevaa viivaa;
- Varmista, että kahvi on tasaisesti tamppauksen jälkeen. Nuppia (B2) saatetaan joutua säätämään monta kertaa ennen kuin annos on täydellinen.
- Jos kahvi on yli- tai aliuuttunut ja annos on täydellisen annoksen mukainen, säädä jauhatuskarkeus hienomaksi tai karkeammaksi (katso "4.1 1.Vaihe - Jauhatus (grinding) (kuva 11)"). Jos kahvi on yliuuttunut (annostelu liian hidas), jauhatuksen tulee olla karkeampi. Jos kahvi on aliuuttunut (annostelu liian nopea), jauhatuksen tulee olla hienempi.
- **Baristan vinkit:** Irrota suodatinpidike tamppausvivun (A20) ollessa laskettuna, jotta kahviannoksen viimeistely onnistuisi.

### 4.3 Vaihe 2 - Annostelu (brewing) (kuva 21)

1. Valitse haluamasi juoma (kuva 22).
2. Paina OK (B6) annostelun aloittamiseksi (kuva 23) (esiuttaminen ja uuttaminen). Kahvin annostelu alkaa ja keskeytyy automaattisesti.

## 5. MAITOUJUMIEN VALMISTUS

### 5.1 Vaahdota maito (kuva 24)

1. Lisää maitosäiliöön (D8) lämmitettävän/vaahdotettavan maidon määrä ottaen huomioon, että maidon tilavuus kasvaa 2–3-kertaiseksi (kuva 25). Jotta vaahdotus olisi tiiviimpää ja yhtenäisempää, suosituksena on käyttää täysmaitoa, joka on jääkaappikylmää (5°C).

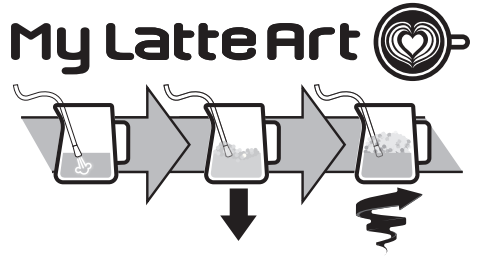

2. Maidon vaahdottamiseksi aseta höyryn annosteluputki (A5) maidon pintaan: näin ilma sekoittuu maitoon ja höyryyn.
3. Pidä höyrystin pinnassa. Ole tarkkana, ettei ota talteen liikaa ilmaa, jolloin kuplat ovat liian suuria.
4. Upota höyrystin maidon pinnan alle. Näin syntyy pyörre. Kun haluttu lämpötila on saavutettu, sulje höyrynuppi uudelleen ja odota, että höyryn annostelu keskeytyy kokonaan ennen kuin otat kahvikannun pois.

### Baristan vinkit:

- **Tuore maito on parasta.** Käytä aina tuoretta ja jääkaappikylmää maitoa.
- Täysmaito takaa erinomaiset tulokset. Vaahdon koostumus ja tulos riippuvat käytetystä lehmänmaidosta ja kasvijuomasta.
- Kun maito on vaahdotettu, poista kuplat ravistelemalla maitokannua.

### Höyrystinpuhdistus:

1. Poista jokaisen käytön jälkeen liinalla maitojäämät höyrystintimasta (kuva 26). Perusteellista puhdistusta varten suosittelaa Eco MultiClean -puhdistusaineen käyttöä. Se poistaa maidon proteiinit ja rasvat, ja sitä voidaan käyttää koko keittimen puhdistukseen.
2. Annostele höyryä muutaman sekunnin ajan puhdistukseksi suuttimen kunnolla (kuva 10).
3. Suuttimen tehokkuuden takaamiseksi ajan kuluessa suosituksena on ostaa puhdistusneula, jonka avulla 3 reikä voidaan pitää puhtaina (kuva 27).

### 5.2 Valmista maitojuomat LatteCrema System -järjestelmän kanssa (kuva 28)

1. Lisää säiliöön (D8) maitoa, joka on jääkaappikylmää (5°C) (kuva 29).
2. Sulje kansi (D1) (kuva 30).
3. Käännä vaahdon säätönuppi (D5) haluamaasi asentoon (kuva 31).

Vaahdon säätönupin asento				

Puhdistus jokaisen käyttökerran jälkeen	Maksimi-vaahto	Keskisuuri vaahto	M I N vaahto	Nupin laittamiseksi tai irrottamiseksi
---	----------------	-------------------	--------------	--

- Liitä maitosäiliö keittimeen (kuva 32).
- Valmistele täydellinen annos (katso "4.1.1. Vaihe - Jauhatus (grinding) (kuva 11)" ja "4.2.2. Vaihe - Tamppaus (tamping) (kuva 17)") laita suodatinpideke.
- Valitse haluamasi maitojuoma (kuva 33).



Juoma	Espresso	Maito	Vaahto	Määrä (ml)	X2 (ml)
Cappuccino	1	✓	✓	≈150	≈230
Latte Macchiato	1	✓	✗	≈150	≈230
Flat White	1	✓	✓	≈250	≈330

- Juomat kaksinkertaisella annoksella (2x):** Lisää säiliöön (D8) valmistuksessa tarvittava määrä maitoa. Ole tarkkana, ettet ylitä MAX-tasoa (kuva 25). Säiliön jokainen viiva vastaa ≈100 ml maitoa.
  - Tuore maito on parasta.** Käytä aina tuoretta ja jääkaappikylmää maitoa.
- Paina OK (B6) annostelua varten (kuva 23). Nyt keitin annostelee automaattisesti kahvia ja maitoa peräkkäin.

### Lattecrema System -järjestelmän puhdistus jokaisen käyttökerran jälkeen:

- Pidä maitosäiliö kiinni keittimessä (sitä ei ole tarpeen tyhjentää). Laita astia maitosuuttimen (D4) alle (kuva 34).
- Käännä nappi (D5) asentoon "Clean" (kuva 35).

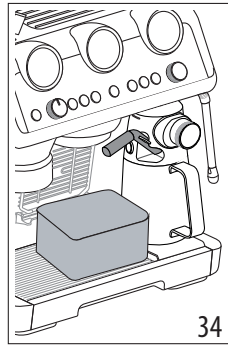

- Puhdistus alkaa ja keskeytyy automaattisesti. Huomio: käännä nappi yhteen vaahdonsäätöasentoon puhdistuksen jälkeen.
  - Poista maitosäiliö ja laita se jääkaappiin. Jäljellä oleva maito tulisi käyttää lyhyen ajan kuluessa.
- Perusteellista puhdistusta varten suositellaan Eco MultiClean -puhdistusaineen käyttöä. Se poistaa maidon proteiinit ja rasvat, ja sitä voidaan käyttää koko keittimen puhdistukseen.

### 6. MUOKKAA KAHVIJUOMIEN PITUUTTA NÄPPÄIMESTÄ (my) (B9)

- Valmistele keitin annostelemaan 1 tai 2 kupillista kahviuomaa, jota tahdotaan annostella, kunnes kiinnitetään suodatinpideke, (C1) jossa on suodatin, (C2) tai (C3) kahvijauhetta. Jos tahdot ohjelmoida maitojuoman, liitä Lattecrema System keittimeen.
- Käännä nappia (B10) valitaksesi ohjelmitavan juoman.
- Paina näppäintä (my): OK-näppäintä vastaava merkivalo (B6) syttyy, ja näppäintä (my) vastaava merkivalo vilkkuu.
- Paina OK-näppäintä annostelun aloittamiseksi. Merkivalot, jotka vastaavat näppäimiä OK ja (my), vilkkuvat.
- Kun määrä on sopiva, paina OK. Jos juomaan kuuluu jonkin muun ainesosan annostelu, tämän annostelu alkaa. Kun haluttu määrä on saavutettu, paina OK.
- Paina näppäintä (my) tallentaaksesi. Keitin on valmis uuteen käyttöön, ja merkivalo (my) palaa.

Jos ohjelmointia ei haluta tallentaa, paina mitä tahansa muuta näppäintä.

#### Tärkeää:

- Kahviuomat voidaan ohjelmoida, mutta ei höyryn ja kuumen veden annostelua.
- Ohjelmointi muokkaa juomamäärää, mutta ei jauhetun kahvin määrää.
- Juomat "X2" voidaan ohjelmoida erikseen.
- My LatteArt** ei ole ohjelmitavissa.

- **Tehdasasetuksiin palaamiseksi pidä painettuna näppäintä (my), kunnes se sammuu.** Valittu juoma palaa oletusarvoon.

Kahvin ohje	Oletusarvoinen määrä	Ohjelmoitava määrä
Espresso	35 ml	25–90 ml
Espresso X2	70 ml	50–180 ml
Coffee	80 ml	50–120 ml
Coffee X2	160 ml	120–240 ml
Americano	120 ml	• espresso: 25–60 ml • vesi: 25–120 ml
Americano X2	240 ml	• espresso: 50–120 ml • vesi: 50–240 ml

## 7. ASETUSTEN VALIKKO

1. Siirry valikkoon:		
Pidä painettuna samanaikaisesti 5 sekunnin ajan	x2	(my)
2. Valitse ohjelmoitava asetus:		
Juoma	V a s t a a v a asetus	Säädöt
Espresso	Energian säästö	➔  Päällä
		➔  Pois päältä
Coffee	Automaattinen sammutus	➔ <b>9 minuuttia</b>
		➔ <b>1,5 tuntia</b>
		(my) ➔ <b>3 tuntia</b>
Cappuccino	Summeri	➔  Päällä
		➔  Pois päältä
		➔

Latte	Jauhatuksen lisäsäätö	➔ <b>Vaihteluväli 1</b>
		➔ <b>Vaihteluväli 2</b>
Flat White	Oletusarvot	Pidä OK-näppäintä painettuna vähintään 5 sekunnin ajan niin kauan kuin merkkivalo palaa yhtäjaksoisesti
Americano	Veden kovuus	➔ <b>pehmeä</b>
		➔ <b>puolikova</b>
		(my) ➔ <b>kova/hyvin kova</b>

## 3. Tallenna uudet asetukset painamalla ON/Stand-by-näppäintä (B1)

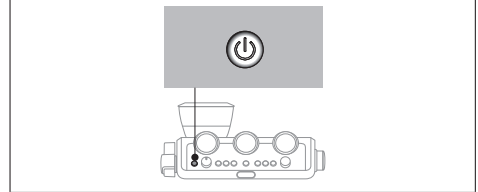

## 8. KEITTIMEN PUHDISTUS











### Varoitus!

- Älä käytä liuotainaineita, hankausaineita tai denaturoitua spritiä keittimen puhdistukseen.
- Älä käytä metallisia välineitä kalkkikerrostumien tai kovettuneen kahvin poistoon, sillä ne saattavat naarmuttaa keittimen metalli- tai muovipintoja.
- Jos käyttö kestää pidempään kuin viikon, ennen keittimen käyttöä suosituksena on huuhdella se.

### Vaara!

- Puhdistuksen aikana keitintä ei saa koskaan upottaa veteen, sillä se on sähkölaite.
- Ennen minkä tahansa keittimeen kuuluvan ulkoisen osan puhdistamista sammuta keitin, irrota pistoke pistorasiasta ja anna keittimen jäähtyä.

	DISHWASHER SAFE	Eco MultiClean			
	×	✓	✓	×	×
					➔

					
	✓	✗	✗	✓	✓
	✗	✗	✗	✓	✓
	✗	✗	✗	✓	✓
	✗	✗	✓	✓	✗
	✗	✗	✗	✓	✓
	✓	✓	✗	✓	✓

### 8.1 Kahvisuuttimen puhdistus

Kun merkivalo  syttyy (oranssi) (B5), kahviipiiri tulee puhdistaa. Puhdistusjaksoa varten osta kahvinkeittimien puhdistustabletteja. Lisätietoja on sivulla Delonghi.com.

1. Laita 1 kupin suodatin (C2) suodatinpidikkeeseen (C1) (kuva 36).
2. Laita suodattimeen puhdistusväline (C9) (kuva 36) ja paina se pohjaan.

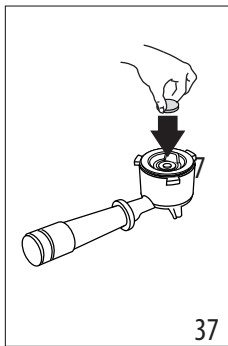
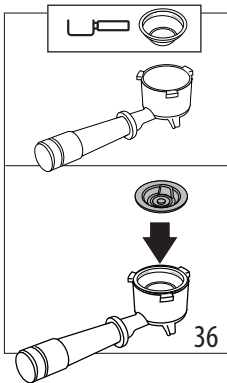

3. Laita puhdistustabletti välineeseen (kuva 37).
4. Kiinnitä suodatinpidike kahvisuuttimeen (A7).
5. Täytä vesisäiliö (A15). Varmista, että tippa-alusta (A11) on tyhjä.

6. Pidä painettuna näppäintä , kunnes vastaava merkivalo alkaa vilkkua (oranssi). Puhdistus keskeytyy automaattisesti muuttaman minuutin kuluttua.

- Irrota suodatinpidike ja puhdistusväline.
- Pese suodatinpidike ja suodatin juoksevan veden alla.
- Laita suodatinpidike takaisin ja jatka huuhtelua painamalla näppäintä  (B5): suosituksena on asettaa astia suodatinpidikkeen alle.
- Poista ja tyhjennä tippa-alusta.

#### Tärkeää:

Tämä puhdistusjakso voidaan käynnistää milloin tahansa painamalla näppäintä  (B5) ja pitämällä sitä painettuna muutaman sekunnin ajan. Toimenpiteen peruuttamiseksi pitää painetta painettuna 10 sekunnin ajan.

### 8.2 Puhdista kahvipapusailiön tila

1. Varmista, että kahvipapusailiö (A1) on tyhjä. Tee tarvittaessa joitakin tyhjäjauhantoja tyhjentääksesi sen.
2. Irrota säiliö kääntämällä sitä vastapäivään ja irrota se keittimestä (kuva 38)

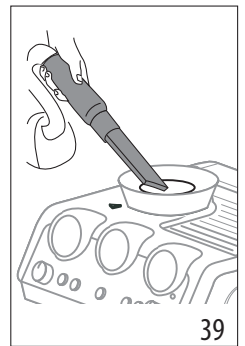
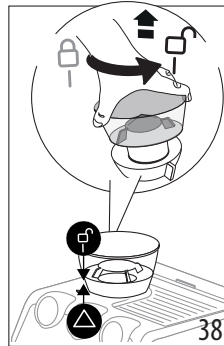

3. Imuroi kahvijäämät pois (kuva 39).
4. Puhdista kostealla liinalla kahvipapusailiön paikka ja kuivaa (kuva 40).

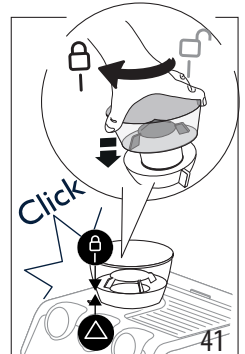
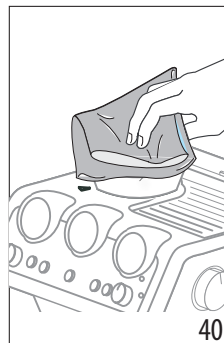

- Laita säiliö takaisin asettamalla se kahvimyllyyn. Säiliö on asetettuna oikeaoppisesti, kun nuoli ▲ on kohdistettuna symboliin ☐ ja kuuluu klik-ääni (kuva 41).

### 8.3 Myllyjen puhdistus

Kun kahvipapusaäiliö (A1) puhdistetaan, puhdista säiliön tila ja ylämylly kostealla liinalla. Käännä huoltokorjaamon puoleen myllyjen irrotusta ja vaihtoa varten.

Mylly voidaan irrottaa, mikäli kahvimylly on jumissa sinne joutuneen vieraan esineen vuoksi. Jos näin tapahtuu, irrota kahvipapusaäiliö ja etene seuraavasti:

- Kiinnitä suodatinkuppipidike (C1) ja suorita tyhjäjauhatus kahvikanavan vapauttamiseksi.
- Sammuta keitin.
- Käännä jauhatuskarkeuden säädin raja-asentoon asti "RE-MOVE"-kohtaan (kuva 42).

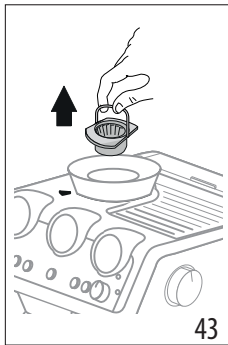
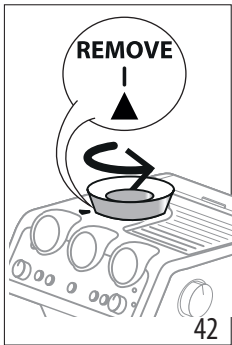

- Irrota myllyn yläosa tarttumalla siihen kahvasta (kuva 43).
- Puhdista mylly sudilla (kuva 44) ja imuroi kahvijäämät pois (kuva 39).

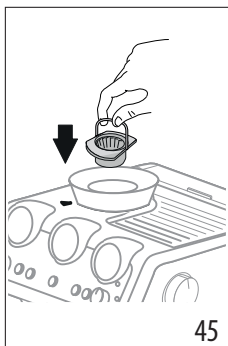
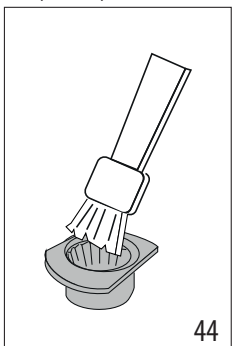

- Laita mylly paikoilleen (kuva 45).
- Käännä säädintä ja valitse haluamasi jauhatuskarkeus (kuva 13).

Tarkista, että mylly on kunnolla paikoillaan, vetämällä sitä kahvasta. Mylly on oikeaoppisesti paikoillaan, jos se ei liiku.

### 8.4 Myllyjen vaihto

Kun jauhettu kahvimäärä vähenee entisestään, käänny huoltokorjaamon puoleen myllyjen vaihtamiseksi. Säädä sitten uudelleen kahvimyllyä siirtymällä asetusvalikkoon ("7. Asetusten valikko") ja valitsemalla jauhatuksen ensimmäisen lisäsäädön vaihteluvälin. Käännä sitten määrän säätönuppi (B2) MIN-asentoon ja säädä annosta samoin kuin ensimmäisellä käyttökerralla (katso "Täydellinen annos").

### 8.5 Puhdistus: "Smart tamping station"

- Puhdista kiinnitysalue sudilla (kuva 46).
- Vedä kahva (A20) loppuasentoon ja puhdista sudilla tamperi (kuva 47) ja vapauta vipu sitten.
- Puhdista kahvikouru puhdistusharjalla (C8)(kuva 48).

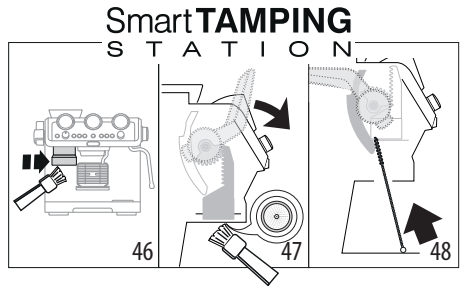

### 8.6 LatteCrema System -järjestelmän puhdistus

Pese astianpesukoneessa kaikki osat ja astia. Aseta ne astianpesukoneen yläkoriin. Jos sinulla ei ole astianpesukonetta, tee pesu käsin kappaleen lopussa annettujen ohjeiden mukaan.

- Paina painiketta (D3) ja nosta maitosaäiliön kansi (D1);
- Irrota maitosuutin (D4) ja imuputki (D7) (kuva 49).

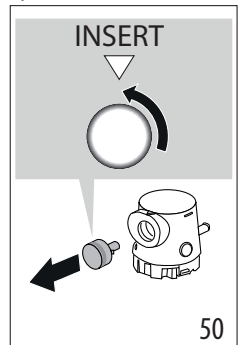
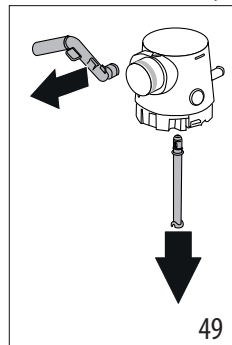

- Käännä nuppi "Insert"-asentoon ja irrota se (kuva 50).
- Ole erityisen tarkkana, että nupin (kuva 51) alla olevaan loveen ja kanavaan ei jäisi maitojäämiä: puhdista kanava tarvittaessa hammastikulla.



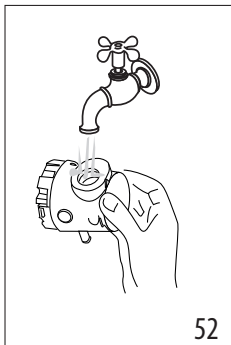
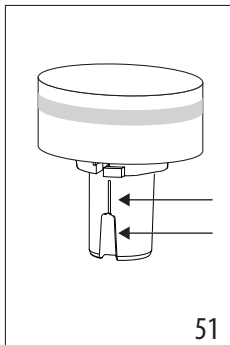

5. Puhdista vaahdon säätönupin sisäosa juoksevilla vedellä (kuva 52).
6. Tarkista myös, etteivät maitojäämät ole tukkineet imuputkea ja suuttimen putkea.
7. Kokoa kaikki kannen osat.
8. Pese ja huuhtele maitosäiliö (D8) huolellisesti.
9. Kiinnitä kansi uudelleen maitosäiliöön.





#### Tärkeää: käsinpesu

Pesu astianpesukoneessa takaa maitosäiliön kaikkien osien täydellisen hygienian. Jos pesu tehdään käsin, pese maitosäiliön kaikki osat huolellisesti kuumalla vedellä, upota ne vesiasiaan ja jätä siihen noin 30 minuutiksi ennen kuin jatkat toimenpiteitä kohdasta 4.

## 9. VEDEN KOVUUS

Kalkinpoiston merkkivalo  (B8) syttyy ennalta määritetyn toiminta-ajan päätteeksi. Aika riippuu veden kovuudesta. Keitin voidaan ohjelmoida myös käyttämäsi veden kovuudelle, jolloin myös kalkinpoistoon liittyvistä toimenpiteistä tulee harvempia.

1. Ota varustuksiin kuuluva reagenssiluska pois pakkauksesta "TOTAL HARDNESS TEST" (C4).
2. Upota se kokonaan vesilasiin noin sekunnin ajaksi.
3. Ota liuska vedestä ja ravista sitä kevyesti. Tee keittimen asetukset noudattamalla ohjeita luvusta "7. Asetusten valikko".

Veden kovuustestin tulos	Näppäin	Kovuusaste
	×2	1 pehmeä vesi
		2 puolikova vesi
	OK	3 kova tai hyvin kova vesi
		

4. Tee keittimen asetukset noudattamalla ohjeita luvusta "7. Asetusten valikko".

## 10. SOFTBALLSIEN KÄYTTÖ

Softballs (C11) on innovatiivinen järjestelmä, joka pidentää keittimen käyttöikää veden laatua muuttamatta. Näin se takaa kermanaisen ja aromaattisen kahvin. Tehokkuuden optimoimiseksi jätä Softballsit veteen kokonaiseksi yöksi ennen käyttöä.

1. Poista Softballs-paketti pakkauksesta (kuva 53).

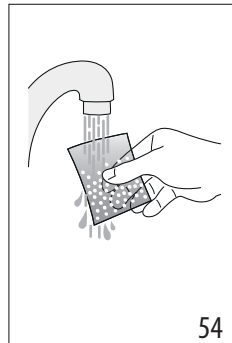
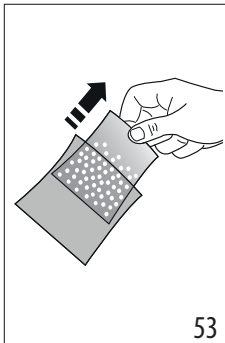

2. Huuhtelee Softballs-paketti juoksevilla vedellä (kuva 54).
3. Upota pussi vesisäiliöön (A15) (kuva 55).

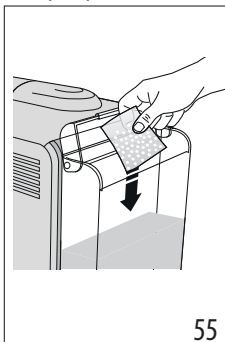

4. Vaihda Softballs-pussi 3 kuukauden välein (kuva 56).

## 11. KALKINPOISTO

### Varoitus!

- Lue huolella kalkinpoistoaine valmistajan antamat käyttöohjeet ja merkinnät ennen käyttöä. (C5)Ne löytyvät kalkinpoistoaineen pakkauksesta.
- Suosittelemme käyttämään ainoastaan De'Longhin kalkinpoistoainetta. Vääränlaisten kalkinpoistoaineiden käyttäminen, tai jos kalkinpoistoa ei suoriteta, voi aiheuttaa vikoja, joita valmistajan takuu ei korvaa.
- Kalkinpoistoaine voi vaurioittaa herkkiä pintoja. Jos tuotetta läikkyä vahingossa, kuivaa heti.

Kalkinpoiston ohjeet	
Kalkinpoistoaine	De'Longhi-kalkinpoistoaine

## Kalkinpoiston ohjeet

Säiliöt 2, joista kunkin tilavuus 1 litraa

Aika n. 40 min

1. (JOS ON, POISTA PEHMENNYSSUODATIN JA SOFTBALLS).

Lisää vesisäiliöön (A15) kalkinpoistainetta tasoon  **A** asti (vastaa 100 ml:n pakkausta). Se on merkitty säiliön sisäpuolelle (kuva 57).

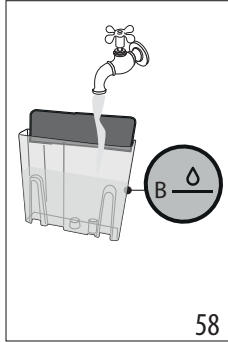
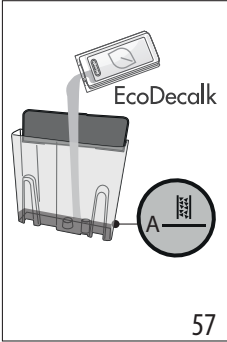

2. Lisää vettä, kunnes saavutat tason  **B** (kuva 58). Laita säiliö sitten takaisin keittimeen.
3. Laita varuste (C6) LatteCrema System -järjestelmän liittimeen (A6) (kuva 59).

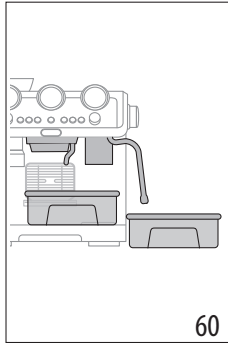
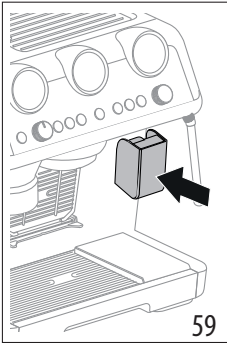

4. Varmista, että suodatinpidike (C1) ei ole kiinnitettynä ja aseta astia kahvi- ja kuumavesisuutintin alle (A7) ja höyrysuutintimen alle (A5) (kuva 60).
5. Pidä painettuna näppäintä  (B8), kunnes vastaava merkkivalo alkaa vilkkua.
6. Kalkinpoisto-ohjelma käynnistyy, ja kalkinpoistonestettä alkaa tulla ulos suuttimista. Kalkinpoisto-ohjelma suorittaa automaattisesti huuhtelujakosarjan kahvinkeittimen sisällä olevan kalkkijäämän poistamiseksi, kunnes säiliö on tyhjä.

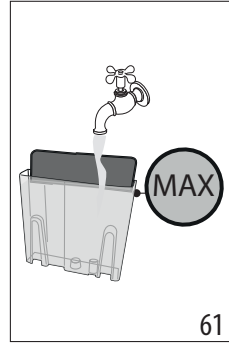

Annostelu keskeytyy, ja merkkivalosta  tulee valkoinen. Huuhtelujakso on tarpeen:

7. Tyhjennä kalkinpoistoainesteen talteenotossa käytetty astia ja aseta se suutintin alle.
8. Irrota vesisäiliö, tyhjennä se mahdollisista kalkinpoistoaineliuoksen jäämistä, huuhtelee se juoksevassa vedessä ja täytä se raiikkaalla vedellä MAX-tasoon asti (kuva 61). Laita säiliö sitten takaisin paikoilleen.

























9. Pidä painettuna näppäintä , kunnes vastaava merkkivalo alkaa vilkkua. Nyt huuhtelu alkaa.
10. Kun huuhtelu on suoritettu, annostelu keskeytyy ja keitin on käyttövalmis.
11. Tyhjennä huuhteluveden keräysastiat.
12. Irrota ja tyhjennä tippa-alusta ja laita se sitten takaisin paikoilleen.
13. Irrota säiliö ja täytä se raiikkaalla vedellä. Aseta takaisin paikoilleen.
- Nyt keitin on käyttövalmis.

### Tärkeää:

- Jos tahdot ennen aikaistaa kalkinpoistojaksoa, pidä painettuna näppäintä  3 sekunnin ajan.
- Jos kalkinpoisto aloitettiin vahingossa, pidä näppäintä  painettuna 10 sekunnin ajan. Huuhtelua ei voida keskeyttää.

## 12. MERKKIVALOJEN SELITYKSET

MERKKIVALOT	MERKKIVALOJEN SELITYKSET	TOIMINTA
Kaikki merkkivalot vilkkuvat lyhyesti	Keittimen käynnistys	Itsemäärittely
 palaa yhtäjaksoisesti	Keitin käynnistetään ensimmäistä kertaa, ja vesipiiri on täytettävä.	Etene noudattamalla ohjeita, jotka on annettu luvussa "3. Ennen keittimen käyttöönottoa"
 palaa yhtäjaksoisesti	Energiansäästötoiminto on päällä	Katso lukua "7. Asetusten valikko", jos tahdot ottaa toiminnon pois päältä
 palaa yhtäjaksoisesti	Kahvipapusaäiliö (A1) on tyhjä	Täytä kahvipapusaäiliö
 vilkkuva	Jauhatusta tahdotaan jatkaa, mutta kahvipapusaäiliö (A1) on tyhjä	Täytä kahvipapusaäiliö
 on	Säiliössä (A15) ei ole riittävästi vettä tai vesisäiliö ei ole kunnolla laitettuna	Täytä säiliö tai irrota säiliö ja laita se oikeaoppisesti jälleen paikoilleen
 vilkkuva	Juoman valmistusta tahdotaan jatkaa, mutta vesisäiliö (A15) on tyhjä	Täytä vesisäiliö
 palaa yhtäjaksoisesti	Yleinen hälytys	Käännä huoltokorjaamon puoleen
 palaa yhtäjaksoisesti	Kahvipapusaäiliö on ei ole paikoillaan	Laita kahvipapusaäiliö (A1) paikoilleen oikeaoppisesti tai tarkista, että se on kunnolla paikoillaan
 vilkkuva	Kahvipapusaäiliön alaosassa oleva valitsin (A1) ei ole oikeaoppisessa asennossa	Vie valitsin yhteen jauhatusasenoista (välillä 1–8) ja muista tehdä seuraavat toimenpiteet: <ul style="list-style-type: none"> <li>Säädä jauhatusta kahvimyllyn toimiessa</li> <li>Säädä yksi taso kerrallaan ja tee vähintään 5 jauhatusta säätöjen välissä</li> </ul>
	Kahvipapusaäiliö (A1) ei ole kokonaan paikoillaan: turvalaite aktivoituu	Tarkista, että kahvipapusaäiliö on kunnolla paikoillaan
 palaa yhtäjaksoisesti	LatteCrema System tulee puhdistaa jokaisen käyttökerran jälkeen	Kun maitojuomat on valmistettu, tee automaattinen puhdistus kääntämällä nappi (D5) Clean-asentoon
 palaa yhtäjaksoisesti	Keitin on valmis annosteamaan höyryä.	Keitin on saavuttanut riittävän lämpötilan höyryn annostelua varten. Annostelun tekemiseksi käännä höyryruppia (A4)
		→

MERKKIVALOT	MERKKIVALOJEN SELITYKSET	TOIMINTA
 vilkkuva	Keitin on päällä ja energiansäästötoiminto on päällä: höyryruppi (A4) on asemissa höyryn annostelua varten	Merkkivalo vilkkuu osoittaen, että keitin valmistautuu höyryn annosteluun. Annostelu alkaa heti kun keitin on oikeassa lämpötilassa
	Keitin on valmis annostelemaan höyryä	Keittimen lämpötila on oikeaoppinen höyryn valmistukseen, kun merkkivalo palaa yhtäjaksoisesti
	Keitin annostelee höyryä	
 palaa yhtäjaksoisesti (oranssi)	Kalkinpoisto on tarpeen	Suorita kalkinpoisto noudattamalla ohjeita, jotka ovat luvussa "11. Kalkinpoisto"
 vilkkuu (oranssi)	Keitin suorittaa kalkinpoistoa	Suorita toimenpide loppuun noudattamalla ohjeita, jotka on annettu luvussa "11. Kalkinpoisto"
 palaa yhtäjaksoisesti (valkoinen)	Huuhtelu on tarpeen	
 vilkkuu (valkoinen)	Keitin suorittaa huuhtelua	
 palaa yhtäjaksoisesti (oranssi)	Kahvisuuttimen puhdistus on tarpeen	Katso kappale "8.1 Kahvisuuttimen puhdistus"
 vilkkuu (oranssi)	Keitin suorittaa kahvisuuttimen puhdistusta	
 vilkkuu (valkoinen)	Keitin suorittaa huuhtelua	
 +  vilkkuu	Jos läsnä on pehmenyysuodatin, piiriin on saattanut päästä ilmakupla, joka estää annostelun	Paina näppäintä (B7) merkkivalon  kohdalla: annostelu alkaa ja lakkaa automaattisesti.
	Kahvi on liian hienoksi jauhettua, ja kahvi valuu tämän vuoksi liian hitaasti tai sitä ei tule ollenkaan.	Irrota suodatinkuppipidike (C1) ja toista kahvin valmistuksen toimenpiteet ottamalla huomioon ohjeet kappaleesta "4.1.1.Vaihe - Jauhatus (grinding) (kuva 11)" ja "4.2.2.Vaihe - Tampaus (tamping) (kuva 17)"
	Kahvinsuodatin (C2) tai (C3) on tukossa	Huuhtele suodatimet juoksevan veden alla tai suorita huuhtelutoiminto huuhtelunäppäimestä (B5).
	Säiliö (A15) on asetettu huonosti paikoilleen, eivätkä sen venttiilit ole auki	Paina säiliötä kevyesti niin, että sen venttiilit avautuvat
	Vesipiirissä on kalkkia	Suorita kalkinpoisto noudattamalla ohjeita, jotka on annettu luvussa "11. Kalkinpoisto"

### 13. JOS ON ONGELMIA

ONGELMA	SYY	RATKAISU
Tippa-alustassa (A11) on vettä	Tämä kuuluu keittimen sisäpiiriin normaaliin toimintaan	Tyhjennä ja puhdista tippa-alusta (A11) säännöllisesti
Espressokahvia ei enää tule	Säiliössä ei ole vettä (A15)	Täytä säiliö
	Merkkivalo  (B7) palaa osoittaen, että kahvi- tai höyrypiiri on tyhjä.	Paina näppäintä merkkivalon  kohdalla piirin täyttämiseksi.
	Suodatin (C2) tai (C3) on tukossa	Huuhtele suodattimet juoksevan veden alla tai suorita huuhtelutoiminto vastaavasta näppäimestä (B5)
	Säiliö (A15) on asetettu huonosti paikoilleen, eivätkö sen pohjassa olevat venttiilit ole auki	Paina säiliötä kevyesti niin, että sen pohjassa olevat venttiilit avautuvat.
	Vesipiirissä on kalkkia	Suorita kalkinpoisto noudattamalla ohjeita, jotka on annettu luvussa "11. Kalkinpoisto"
	Liian hieno jauhatus	Irrota suodatinkuppipidike (C1) ja toista kahvin valmistuksen toimenpiteet ottamalla huomioon ohjeet kappaleesta "4.1 1.Vaihe - Jauhatus (grinding) (kuva 11)" ja "4.2 2.Vaihe - Tamppaus (tamping) (kuva 17)"
Suodatinkuppi ei kiinnity keittimeen	Jauhettua kahvia ei ole tampattu tai sitä on liikaa	Toista jauhatus eri asetuksilla. Vähennä annoksen määrää: tarkista, että suodatin (C2) tai (C3) (1 tai 2 kuppia) on oikea suhteessa jauhatettavaan annokseen (näppäin 2x (B3) valittuna vai ei)
Espresso valuu suodatinkupin reunoista (C1) eikä rei'istä	Suodatinkuppi ei ole kunnolla paikoillaan	Kiinnitä suodatinkuppi oikeaoppisesti ja käännä se loppuun asti voimakkaasti
	Kahvisuuttimen tiiviste (A7) on löystynyt tai likaantunut	Vaihda kahvisuuttimen tiiviste valtuutetussa huoltokeskuksessa
	Suodatin (C2) tai (C3) on tukossa	Huuhtele suodattimet juoksevan veden alla tai suorita huuhtelutoiminto vastaavasta näppäimestä (B5)
Kahvin vaahto on vaaleaa (valuu nopeasti suuttimesta)	Keittimen asetukset tulee tarkistaa	Irrota pidike ja toista kahvinvalmistus-toimenpiteet ottaen huomioon ohjeet kappaleesta "4.1 1.Vaihe - Jauhatus (grinding) (kuva 11)" ja "4.2 2.Vaihe - Tamppaus (tamping) (kuva 17)"
		→

ONGELMA	SYY	RATKAISU
Kahvin vaahto on tummaa (valuu hitaasti suuttimesta)	Keittimen asetukset tulee tarkistaa	Irrrota suodatinkuppipidike (C1) ja toista kahvin valmistuksen toimenpiteet ottaen huomioon ohjeet kappaleesta "4.1 1.Vaihe - Jauhatus (grinding) (kuva 11)" ja "4.2 2.Vaihe - Tamppaus (tamping) (kuva 17)"
Maitovaahtoa ei synny, kun valmistetaan cappuccinoa LatteCrema System -järjestelmällä	Maito ei ole tarpeeksi kylmää	Käytä aina jääkaappikylmää maitoa
	Nuppi (D5) ei ole oikeassa asennossa	Tarkista ja käännä nuppi oikeaan asentoon (☞ maksimivaahto; ☞ keskusuiuri vaahto; ☞ minimivaahto)
	LatteCrema System on likainen	Puhdista noudattamalla ohjeita kappaleesta "8.6 LatteCrema System -järjestelmän puhdistus"
Keitin pyytää toisen huuhtelun kalkinpoiston päätteeksi	Vesipiirissä on kalkkia	Suorita kalkinpoisto noudattamalla ohjeita, jotka on annettu luvussa "11. Kalkinpoisto"
	Säiliötä ei ole täytetty MAX-tasoon asti huuhtelujakson aikana	Toista huuhtelu (katso luku "11. Kalkinpoisto")
Keitin ei jauha kahvia	Kahvimyllyn sisällä on vieras esine	Puhdista myllyt noudattamalla ohjeita, jotka on annettu kappaleessa "8.3 Myllyjen puhdistus". Varmista, että olet poistanut kaikki pavut kahvipapusaaliöstä (A2) ennen sen poistoa. Ennen myllyn laittamista uudelleen paikoilleen imuroi kaikki jäämät sen kohdalta
	Kahvipapusaaliö (A1) ei ole oikeaoppisessa asennossa	Säiliö on asetettuna oikeaoppisesti, kun nuoli ▲ on kohdistettuna symboliin ☞ ja kuuluu klik-ääni
		→

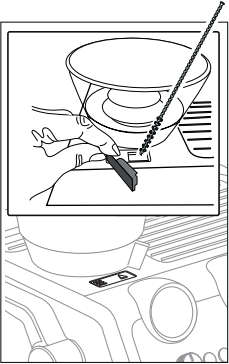
ONGELMA	SYY	RATKAISU
Jos halutaan vaihtaa kahvilaatua	Kaikki keittimessä olevat pavut on poistettava	<ul style="list-style-type: none"> <li>• Tyhjä kahvipapussäiliö (A1) (tekemällä tyhjäjauhatusia tai muroimalla jäljelle jääneet pavut).</li> <li>• Kiinnitä suodatinkuppipidike (C1) ja tee tyhjäjauhatusia kahvikanan vapauttamiseksi. Kiinnitä sitten suodatinkuppipidike kahvimyllyn ulostulokohtaan (A18) ja kohdistu INSERT-kirjoitukseen. Käännä sitten pidikettä oikealle (kuva 22). Jauhatus alkaa, kun kuppi saavuttaa CLOSE-asennon ja keskeytyy automaattisesti. Toista, kunnes suodatin on tyhjä</li> <li>• Laita säiliöön (A1) uusi kahvipaputyyppe</li> <li>• Jos jauhatus ei saavuta täydellistä anosta, toimi samoin kuin ensikäytön kohdalla</li> </ul>
Jauhatusen jälkeen kahvisuodatin (C2) tai (C3) on tyhjä	Kahvimyllyn kahvikouru on tukossa	<p>Puhdista noudattamalla ohjeita, jotka on annettu kappaleessa "8.5 Puhdistus: "Smart tamping station"". Jos ongelma jatkuu, siirry kourun kohdalle avaamalla luukku (A19) ja vapauta se käyttämällä puhdistusharjaa</p> 
Suodattimessa on liikaa kahvijauhetta		

ONGELMA	SYY	RATKAISU
<p>Jauhatuksen jälkeen suodattimessa on kahvijauhetta (C2) tai (C3) ei saavuta täydellistä annosta</p>	<p>"Smart Tamping Station" on puhdistettava</p>	<p>Puhdista noudattamalla ohjeita, jotka on annettu kappaleessa "8.5 Puhdistus: "Smart tamping station"; ja toista sitten jauhatus</p>
	<p>Jauhetun kahvin määrää on säädettävä</p>	<p>Säädä määrää omasta nupista (B2) noudattamalla ohjeita kappaleesta "Täydellinen annos". Jos nuppi on jo max-asennossa, etene noudattamalla ohjeita osiosta "Jauhatuksen lisäsäätö"</p>
	<p>Myllyt kuluvat ajan myötä</p>	<p>Vaihda myllyt noudattamalla ohjeita kappaleesta "8.4 Myllyjen vaihto"</p>



Перед использованием прибора прочитайте предупреждения по технике безопасности.

## 1. ОПИСАНИЕ

### 1.1 Описание прибора — А

- A1. Контейнер для зерен
- A2. Крышка контейнера для зерен
- A3. Подставка для чашек
- A4. Рукоятка подачи пара
- A5. Трубка подачи пара
- A6. Контейнер для Lattecrema System
- A7. Узел подачи кофе
- A8. Решетка подставки для чашек для эспрессо
- A9. Решетка подставки для чашек для стаканов или кружек
- A10. Решетка поддона
- A11. Поддон сбора капель
- A12. Индикатор уровня воды в поддоне для сбора капель
- A13. Крышка бачка для воды
- A14. Рукоятка извлечения бачка для воды
- A15. Бачок для воды
- A16. Гнездо для разъема шнура электропитания
- A17. Главный выключатель (ON/OFF)
- A18. Выход кофемолки (Tamping station)
- A19. Дверца доступа к желобу кофемолки
- A20. Рычаг придавливателя

### 1.2 Описание контрольной панели — В

- V1. Кнопка ON/Standby
- V2. Рукоятка регулировки количества молотого кофе
- V3. Кнопка X2: использование фильтра 2 кофе
- V4. Кнопка «температура кофе»
- V5. Кнопка ополаскивания
- V6. Кнопка ОК: подача напитка/подтверждение
- V7. Кнопка подачи горячей воды
- V8. Кнопка удаления накипи
- V9. Кнопка Mu: индивидуальный подбор объема напитков
- V10. Ручка выбора функций
- V11. Дисплей напитков:

#### Напитки на основе кофе Espresso

- Espresso
- Americano
- Кофе

#### Напитки на основе молока

- Cappuccino
- Flat White
- Latte Macchiato

- V12. Индикатор очистки молока
- V13. Индикатор отсутствия контейнера для зерен
- V14. Индикатор общего предупреждения
- V15. Манометр

- V16. Индикатор отсутствия воды
- V17. Индикатор пустого контейнера для зерен
- V18. Индикатор режима энергосбережения
- V19. Дисплей настроек и процесса:

- показывает действие, выполняемое прибором
- показывает выбранную настройку количества кофе
- Показывает выбранную настройку температуры кофе

### 1.3 Описание принадлежностей — С

- C1. Фильтродержатель
- C2. Фильтр 1 чашки
- C3. Фильтр 2 чашек
- C4. Индикаторная полоска Total Hardness Test
- C5. Средство для удаления накипи
- C6. Приспособление для удаления накипи
- C7. Шнур питания съемный
- C8. Ершик
- C9. Приспособление для очистки узла подачи кофе
- C10. Ткань
- C11. Softballs (умягчитель воды)
- C12. Игла для очистки наконечника пара

### 1.4 Не включенные приспособления для очистки, рекомендованные производителем

Дополнительные сведения см. на сайте [Delonghi.com](http://Delonghi.com).



#### Таблетки для очистки

(см. «8.1 Очистка узла подачи кофе»)

 **Устройство очистки**  
EAN: 8004399333307

### 1.5 Описание LatteCrema System — D

- D1. Крышка контейнера для молока
- D2. Разъем контейнера для молока
- D3. Кнопка отпуска крышки
- D4. Узел подачи молока (регулируется по высоте)
- D5. Ручка регулировки пены
- D6. Гнездо рукоятки
- D7. Трубка всасывания молока
- D8. Контейнер для молока

## 2. ПОДГОТОВКА ПРИБОРА

Теплой водой и средством для посуды вымойте все приспособления и выполните следующее:

1. Установите поддон для сбора капель (A11) в комплекте с решеткой подставки для чашек (A9) и с решеткой поддона (A10) (рис. 1).

- Снимите бачок для воды (A15) (рис. 2) и наполните его свежей чистой водой, не превышая отметку MAX (рис. 3).
- Установите на место бачок для воды.

**Внимание!** Не включайте прибор без воды в бачке или без самого бачка.

**Примечание.** Рекомендуется как можно быстрее отрегулировать жесткость воды путем выполнения процедуры, описанной в главе «7. Меню настроек».

### 3. ПЕРВОЕ ВКЛЮЧЕНИЕ ПРИБОРА

- Установите разъем шнура питания (C7) в специальное гнездо (A16) сзади прибора (рис. 4), затем вставьте вилку в розетку. Убедитесь, что главный выключатель (A17), находящийся сзади прибора, нажат в положении I (рис. 5).
- Поместите под узлом подачи горячей воды (рядом с узлом подачи кофе (A7)) емкость минимальным объемом 100 мл (рис. 6).
- Нажмите кнопку (B7) рядом с индикатором  (рис. 7), подача начнется и остановится автоматически. Слейте емкость.

Перед началом пользования машиной необходимо промыть внутренние контуры. Выполните следующие действия:

- Наденьте фильтродержатель (C1) вместе с фильтром на кофемашину. Чтобы правильно закрепить фильтродержатель, выровняйте его ручку с надписью «INSERT» (рис. 8) и поверните рукоятку вправо до выравнивания с позицией «CLOSE».
- Поместите емкость под фильтродержателем и под трубкой подачи пара (A5).
- Нажмите кнопку (B5) индикатора  (рис. 9), начинается подача.
- Когда подача завершена, поверните рукоятку пара (A4) (рис. 10) и подайте пар в течение нескольких секунд, чтобы ополоснуть контур пара. Для оптимальной подачи пара рекомендуется повторить это действие 3 или 4 раза. Это позволит перед подачей пара удалить воду в трубке.

Теперь прибор готов к работе.

**Примечание.** Промывание внутренних контуров рекомендуется также после длительного простоя прибора.

При первом использовании для получения удовлетворительного результата необходимо приготовить 4–5 чашек кофе. Особое внимание обратите на дозу молотого кофе в фильтре ((C2) или (C3)) (см. инструкции в параграфе «4.1 Этап 1 — Помол (grinding) (рис. 11)»).

Выполните действия, указанные в главе «Идеальное количество».

## 4. ПРИГОТОВЛЕНИЕ КОФЕ

### 4.1 Этап 1 — Помол (grinding) (рис. 11)

- Засыпьте зерна в контейнер (A1) (рис. 12). Рекомендуется засыпать только то количество зерен, которое требуется для приготовления. Таким образом кофе всегда будет использоваться свежим.
- Выберите степень помола (рис. 13). Заводская настройка 5 (средний помол). Если результат неудовлетворительный, отрегулируйте уровень в зависимости от собственного вкуса и от типа кофе (регулировку следует выполнять во время работы кофемолки).
- Поместите один из фильтров кофе (C2) или (C3) в фильтродержатель (C1) (рис. 14). Если используется фильтр для 2 чашек, нажмите кнопку 2X (B3). Благодаря этому вдвое увеличится количество подаваемого эспрессо.
- Отрегулируйте рукоятку количества (B2) начиная с минимального положения (рис. 15).

**Примечание.**

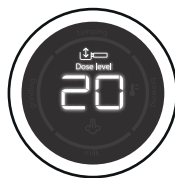

Появившиеся на дисплее (B19) цифры следует записать, как только в фильтродержателе будет достигнут нужный уровень.

Они не соответствуют настройкам помола, весу молотого кофе (г/унция) или времени помола.

Обратитесь к параграфу «B3. Кнопка X2: использование фильтра 2 кофе» за дополнительными указаниями.

- Закрепите фильтродержатель на выходе кофемолки (A18) и выровняйте его по надписи INSERT, затем поверните держатель вправо (рис. 16). Помол начинается, когда держатель достигает положения CLOSE, и прекращается автоматически.

### Регулировка количества молотого кофе в фильтре

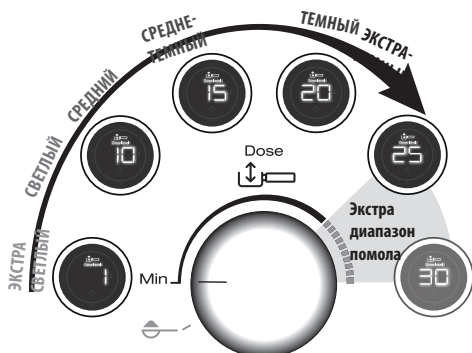

Каждый сорт зерна дает различный результат во время помола, поэтому в начале следует выполнить тщательную регулировку количества.

На изображении даются инструкции по регулировке количества на основе цвета обжарки. Их можно рассматривать как исходные, но они могут отличаться в зависимости от состава кофейных зерен.

1. Настройте количество начиная с минимального положения.
2. Медленно вращайте рукоятку с учетом цвета обжарки ваших кофейных зерен.

#### 4.2 Этап 2 — Прижим (tamping) (рис. 17)

1. После помола опустите рычаг прижима (A20) до упора (не снимайте фильтродержатель) (рис. 18). Для получения отличного результата повторите 2 раза.
2. Во время снятия фильтродержателя удерживайте рычаг опущенным до упора (рис. 19). Затем приведите рычаг в исходное положение.
3. После того, как убедились, что количество кофе правильное (см. «Идеальное количество»), закрепите фильтродержатель на узле подачи кофе (A7) (рис. 20).

#### Идеальное количество

- Фильтры кофе внутри имеют маркировку для определения идеального количества.

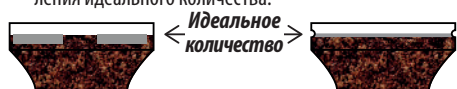

#### Лазерная маркировка

#### Рельефная маркировка

- Фильтры с лазерной маркировкой: идеальное количество соответствует верхней линии маркировки.
- Фильтры с рельефной маркировкой: идеальное количество соответствует линии выпуклости.
- Убедитесь, что кофе после прижима находится на уровне. Может потребоваться несколько раз регулировать рукоятку (B2) до получения идеального количества.
- Если кофе слишком экстрагирован или недоэкстрагирован, а количество находится в диапазоне идеального, отрегулируйте помол на более мелкий или более крупный (см. «4.1 Этап 1 — Помол (grinding) (рис. 11)»). Если экстракция кофе повышена (слишком медленная подача), помол должен быть крупнее. Если экстракция кофе низкая (слишком быстрая подача), помол должен быть мельче.
- **Бариста рекомендует:** Доставайте фильтродержатель, когда рычаг придавливания (A20) опущен, так получается отличный прижим дозы кофе.

#### 4.3 Этап 3 — Подача (brewing) (рис. 21)

1. Выберите желаемый напиток (рис. 22).

2. Нажмите ОК (B6) для начала подачи (рис. 23) (предварительная заварка и заварка). Подача кофе остановится автоматически.

## 5. ПРИГОТОВЛЕНИЕ МОЛОЧНЫХ НАПИТКОВ

### 5.1 Вспеньте молоко (рис. 24)

1. Налейте в контейнер для молока (D8) необходимое количество молока для подогрева/вспенивания. Помните, что объем молока увеличивается в 2 или в 3 раза (рис. 25). Для получения более плотной и однородной пены рекомендуется использовать цельное коровье молоко прохладной температуры (около 5° C).

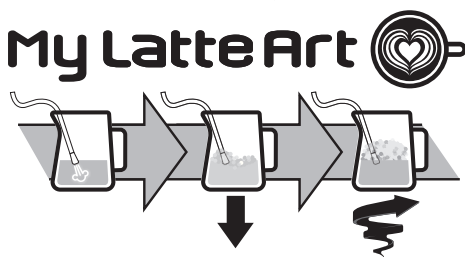

2. Для вспенивания молока опустите трубку подачи пара (A5) на поверхность молока, таким образом воздух смешается с молоком и паром.
3. Удерживайте узел подачи пара на поверхности и следите, чтобы не попадало слишком много воздуха, от этого возникают слишком большие пузыри.
4. Погрузите узел подачи пара ниже поверхности молока, таким образом создается воронка. Когда достигнута нужная температура, закройте рукоятку пара и дождитесь полной остановки подачи пара до того, как убрать графин молока.

#### Бариста рекомендует:

- **Лучше использовать прохладное молоко.** Всегда берите свежее молоко прохладной температуры.
- Цельное молоко обеспечивает отличный результат. Результат и текстура пены зависят от того, используется ли коровье молоко или растительные напитки.
- После вспенивания молока удалите пузыри путем встряхивания графина молока.

#### Очистка узла подачи пара:

1. После каждого использования тряпкой удалите остатки молока с узла подачи пара (рис. 26). Для более тщательной очистки рекомендуется использовать Eco MultiClean. Средство обеспечивает гигиену, поскольку удаляет протеины и жиры молока. Его также можно использовать для очистки всей машины.
2. Подайте пар в течение нескольких секунд, чтобы хорошо очистить узел подачи (рис. 10).

- Дождитесь охлаждения узла подачи. Для поддержания длительной эффективности узла подачи используйте иглу очистки (C12) для освобождения 3 отверстий (рис. 27).

## 5.2 Приготовление молочных напитков с помощью LatteCrema System (рис. 28)

- Налейте в контейнер (D8) молоко прохладной температуры (5°C) (рис. 29).
- Закройте крышку (D1) (рис. 30).
- Поверните рукоятку регулировки пены (D5) в нужное положение (рис. 31).

Положение рукоятки регулировки пены				
 CLEAN				 INSERT
Очистка после каждого использования	Пена MAX	Пена MED	Пена MIN	Снятие или установка рукоятки

- Закрепите контейнер для молока на машине (рис. 32).
- Приготовьте идеальное количество (см. «4.1 Этап 1 — Помол (grinding) (рис. 11)» и «4.2 Этап 2 — Прижим (tamping) (рис. 17)») установите фильдродержатель.
- Выберите желаемый молочный напиток (рис. 33).

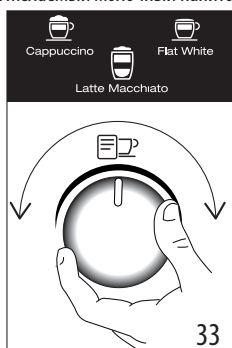

Напиток	Espresso	Молоко	Пена	Объем (мл)	X2 (мл)
Cappuccino	1	✓	✓	≈150	≈230
Latte Macchiato	1	✓	✗	≈150	≈230
Flat White	1	✓	✓	≈250	≈330

- Напитки двойного количества (2x):** Налейте в контейнер (D8) необходимое количество молока для приготовления, не превышайте уровень MAX (рис. 25).

Каждая отметка на контейнере соответствует ≈100 мл молока.

- Лучше использовать прохладное молоко.** Всегда берите свежее молоко прохладной температуры.
- Нажмите ОК (B6) для подачи (рис. 23). Прибор автоматически подает кофе и молоко в последовательности.

## Очистка Lattecrema System после каждого применения:

- Оставьте контейнер для молока закрепленным на машине (не нужно его сливать). Поместите емкость под трубкой подачи молока (D4) (рис. 34).
- Поверните рукоятку (D5) на Clean (рис. 35).

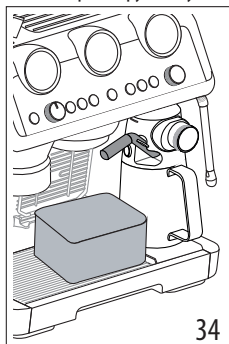



- Очистка начинается и останавливается автоматически. Внимание! После завершения очистки поверните рукоятку в одно из положений регулировки пены.
- Снимите контейнер для молока и поместите его в холодильник. Рекомендуется использовать оставшееся молоко как можно быстрее.

Для более тщательной очистки рекомендуется использовать Eco MultiClean. Средство обеспечивает гигиену, поскольку удаляет протеины и жиры молока. Его также можно использовать для очистки всей машины.

## 6. ИНДИВИДУАЛЬНЫЙ ПОДБОР ОБЪЕМА КОФЕЙНЫХ НАПИТКОВ С ПОМОЩЬЮ КНОПКИ (M9) (B9)

- Подготовьте машину для подачи 1 или 2 чашек желательного кофейного напитка вплоть до установки держателя (C1) с фильтром (C2) или (C3) и молотого кофе. Если требуется запрограммировать молочный напиток, подсоедините систему Lattecrema System к машине.
- Поверните рукоятку (B10) для выбора напитка для программирования.
- Нажмите кнопку (M9), индикатор кнопки ОК (B6) загорится ровным светом, а индикатор кнопки (M9) мигает.

4. Нажмите кнопку ОК для начала подачи. Индикаторы кнопок ОК и  мигают.
  5. После достижения необходимого количества нажмите ОК. Если напиток предусматривает подачу еще одного ингредиента, начинается его подача. После достижения необходимого количества нажмите ОК.
  6. Нажмите кнопку  для сохранения. Прибор готов к новому использованию, индикатор  остается гореть.
- Если вы не хотите сохранить программирование, нажмите любую другую кнопку.

**Примечание.**



- Можно программировать кофейные напитки, но не подачу пара и горячей воды.
- Программирование изменяет количество напитков, а не количество молотого кофе.
- Напитки «X2» можно программировать отдельно.
- **My LatteArt**  не программируется.
- Для возврата к заводским настройкам удерживайте нажатой кнопку  до выключения. Выбранный напиток вернется к заводским параметрам.

Рецепт кофе	Заводское количество	Программируемое количество
 Espresso	35 мл	от 25 до 90 мл
 Espresso X2	70 мл	от 50 до 180 мл
 Coffee	80 мл	от 50 до 120 мл
 Coffee X2	160 мл	от 120 до 240 мл
 Americano	120 мл	<ul style="list-style-type: none"> <li>• эспрессо: от 25 до 60 мл</li> <li>• вода: от 25 до 120 мл</li> </ul>
 Americano X2	240 мл	<ul style="list-style-type: none"> <li>• эспрессо: от 50 до 120 мл</li> <li>• вода: от 50 до 240 мл</li> </ul>

**7. МЕНЮ НАСТРОЕК**

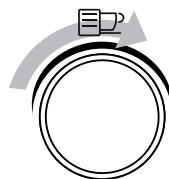
<b>1. Вход в меню:</b>		
нажимайте одновременно в течение 5 секунд	x2	
<b>2. Выбор настройки для программирования:</b>		
→		



Напиток	Соответствующая настройка	Регулировки
 Espresso	Экономия энергии	 →  <b>подключено</b>
		 →  <b>выключено</b>
 Coffee	Автовывключение	 → <b>9 минут</b>
		 → <b>1,5 часа</b>
		 → <b>3 часа</b>
 Cappuccino	Звуковой сигнал	 →  <b>подключено</b>
		 →  <b>выключено</b>
 Latte	Дополнительная регулировка помолы	 → <b>диапазон 1</b>
		 → <b>диапазон 2</b>
 Flat White	Заводские параметры	Удерживайте нажатой в течение 5 секунд кнопку ОК, пока индикатор не будет гореть ровно
 Americano	Жесткость воды	 → <b>мягкая</b>
		 → <b>средней жесткости</b>
		 → <b>жесткая/очень жесткая</b>

**3. Сохраните новые настройки нажатием ON/Standby (B1)**

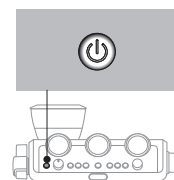













## 8. ОЧИСТКА ПРИБОРА

### Внимание!

- Не используйте для чистки кофемашины растворители, абразивные моющие средства или спирт.
- Не используйте металлические предметы для удаления накипи или отложений кофе, поскольку они могут оцарапать металлические или пластмассовые поверхности.
- В случае простоев свыше одной недели перед повторным использованием машины рекомендуется выполнить ополаскивание.

### Опасно!

- При очистке ни в коем случае не допускайте погружения машины в воду, это электрический прибор.
- Перед любой операцией по очистке внешних частей прибора выключите его, выньте вилку из розетки и дайте ему остыть.

					
	×	✓	✓	×	×
	✓	×	×	✓	✓
	×	×	×	✓	✓
	×	×	×	✓	✓
	×	×	✓	✓	×
	×	×	×	✓	✓
	✓	✓	×	✓	✓



### 8.1 Очистка узла подачи кофе

Когда индикатор  загорается (оранжевый) (B5), необходимо выполнить очистку контура кофе. Для выполнения цикла очистки приобретите таблетки для очистки кофема-

шин. Более подробные сведения см. на веб-сайте [www.Delonghi.com](http://www.Delonghi.com).

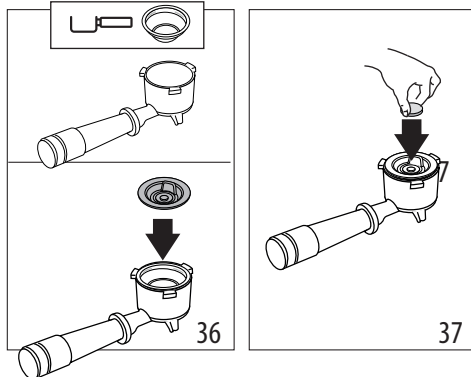
1. Установите фильтр 1 чашки (C2) в фильтродержатель (C1) (рис. 36).
2. Установите в фильтр приспособление для очистки (C9) (рис. 36) и нажмите до упора.



3. Положите таблетку для очистки на приспособление (рис. 37).
  4. Закрепите фильтродержатель к узлу подачи кофе (A7).
  5. Наполните бачок для воды (A15). Убедитесь, что поддон для сбора капель (A11) пуст.
  6. Удерживайте нажатой кнопку , пока соответствующий индикатор не начнет мигать (оранжевый). Через несколько минут очистка автоматически остановится.
- Снимите фильтродержатель и приспособление для очистки.
  - Вымойте фильтродержатель и фильтр под проточной водой.
  - Установите на место фильтродержатель и выполните ополаскивание нажатием кнопки  (B5), рекомендуется установить емкость под фильтродержатель.
  - Снимите и слейте поддон для сбора капель.

### Примечание.

Этот цикл очистки можно запустить в любой момент нажатием кнопки  (B5) на несколько секунд. Для отмены действия удерживайте кнопку 10 секунд.

### 8.2 Очистите место размещения контейнера для зерен

1. Убедитесь, что контейнер для зерен (A1) пуст. При необходимости выполните несколько пустых помолов для его полного опорожнения.
2. Отсоедините контейнер путем его поворота против часовой стрелки и снимите его с машины (рис. 38)

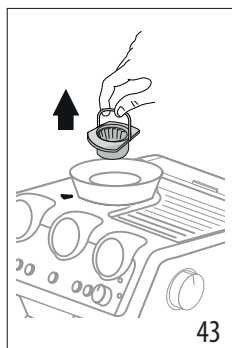
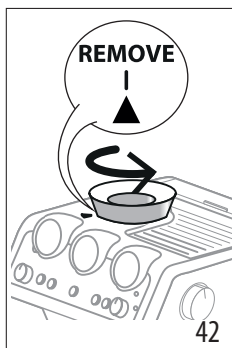
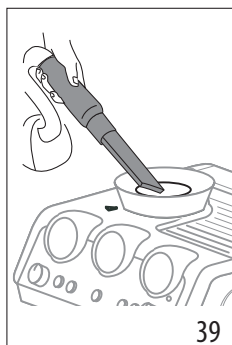
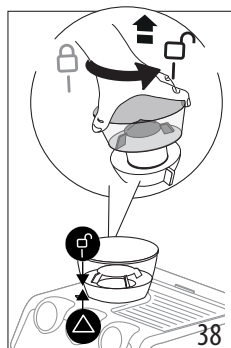

3. Остатки кофе уберите пылесосом (рис. 39).
4. Влажной тряпкой очистите место расположения контейнера для зерен и высушите (рис. 40).

4. Достаньте верхнюю часть жернова за специальную ручку (рис. 43).
5. Очистите жернов кисточкой (рис. 44) и пылесосом уберите кофейные остатки (рис. 39).

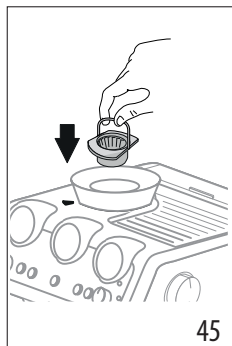
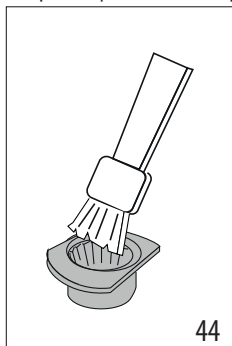
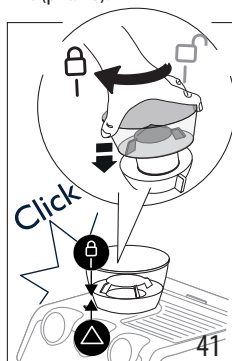
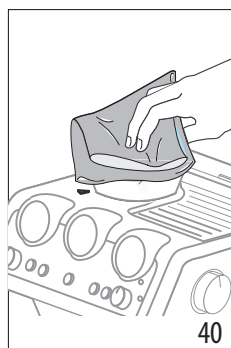

5. Установите контейнер на место в кофемолку. Контейнер правильно установлен, если стрелка ▲ выровнена с символом ☐ и слышится щелчок (рис. 41).

6. Установите жернов в свое гнездо (рис. 45).
7. Поверните регулятор и выберите желаемую степень помола (рис. 13).

Убедитесь, что жернов хорошо посажен, потянув его за ручку: он хорошо установлен, если не двигается.

### 8.3 Очистка жерновов

Когда выполняется очистка контейнера для зерен (A1), очистите место расположения контейнера и верхний жернов с помощью влажной тряпки. Обратитесь в сервисный центр для снятия и замены жерновов.

Можно снять жернов, если кофемолка заблокирована посторонним предметом. Если это произошло, снимите контейнер для зерен и выполните следующее:

1. Закрепите фильтродержатель (C1) и выполните пустой помол для освобождения канала кофе.
2. Выключите прибор.
3. Поверните против часовой стрелки регулятор помола до упора в положение «REMOVE» (рис. 42).

### 8.4 Замена жерновов

Если количество молотого кофе снова уменьшается, обратитесь в сервисный центр для замены жерновов. Затем снова отрегулируйте кофемолку через меню настроек («7. Меню настроек») путем выбора первого диапазона дополнительной регулировки помола. Затем поверните рукоятку регулировки количества (B2) в положение MIN и отрегулируйте количество как при первом использовании (см. «Идеальное количество»).

### 8.5 Очистка Smart tamping station

1. Очистите зону крепления кисточкой (рис. 46).
2. Потяните рычаг (A20) до упора и кисточкой очистите придавливатель (рис. 47), затем отпустите рычаг.
3. С помощью ершика (C8) очистите желоб кофе (рис. 48).

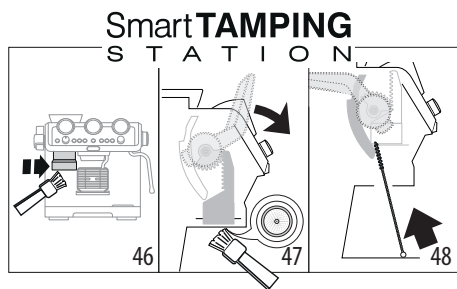

## 8.6 Очистка LatteCrema System

Вымойте в посудомоечной машине все компоненты и контейнер. Для этого разместите их в верхней корзине посудомоечной машины. При отсутствии посудомоечной машины выполните ручную мойку согласно инструкциям в примечании в конце параграфа.

1. Нажмите кнопку (D3) и поднимите крышку контейнера для молока (D1).
2. Снимите узел подачи молока (D4) и трубку всасывания ((D7) (рис. 49).

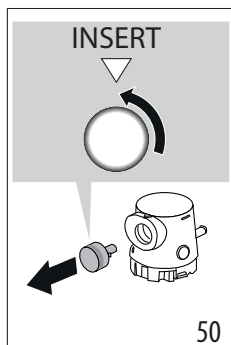
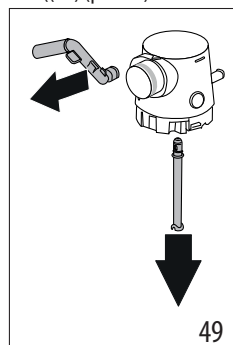

3. Поверните рукоятку в положение «Insert» и извлеките ее (рис. 50).
4. Следите, чтобы в выемке и в канале под рукояткой (рис. 51) не было остатков молока. При необходимости прочистите канал с помощью зубочистки.

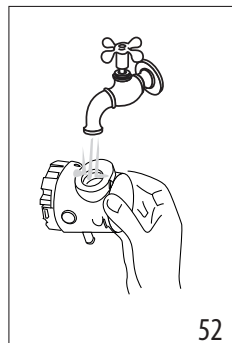
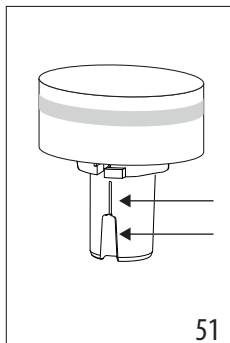

5. Ополосните гнездо для регулятора пены под проточной водой (рис. 52).
6. Убедитесь также, что трубка всасывания молока и трубка подачи не засорены остатками молока.
7. Соберите все компоненты крышки.
8. Промойте и тщательно ополосните контейнер для молока (D8).
9. Установите крышку на контейнер для молока.

### Примечание. Ручная мойка

Мырка в посудомоечной машине гарантирует идеальную гигиену всех компонентов контейнера для молока. При ручной мойке следует тщательно промыть все компоненты контейнера для молока горячей водой и погрузить их в емкость с горячей водой. Оставить на 30 минут, затем выполнить указания из пункта 4.

## 9. ЖЕСТКОСТЬ ВОДЫ

Индикатор [B8] (B8) удаления накипи загорается через определенный период работы, продолжительность которого зависит от жесткости воды. Можно запрограммировать прибор на основании фактической жесткости воды в разных регионах. Таким образом увеличивается интервал проведения операции по удалению накипи.

1. Достаньте из упаковки индикаторную полоску из комплекта поставки TOTAL HARDNESS TEST (C4).
2. Полностью погрузите полоску в стакан воды на одну секунду.
3. Достаньте полоску из воды и отряхните ее. Настройте прибор, как указано в главе «7. Меню настроек».

Результат проверки жесткости воды	Кнопка	Степень
	× 2	1 мягкая вода



Результат проверки жесткости воды	Кнопка	Степень
		2 вода средней жесткости
		3 жесткая или очень жесткая вода

4. Настройте прибор, как указано в главе «7. Меню настроек».

## 10. КАК ПОЛЬЗОВАТЬСЯ SOFTBALLS

Softballs (C11) является инновационной системой, которая продлевает срок службы машины, не влияет на качество воды и обеспечивает подачу ароматного кофе с пышной пенкой. Для наибольшей эффективности оставьте Softballs в воде на всю ночь перед использованием.

1. Достаньте пакет Softballs из упаковки (рис. 53).

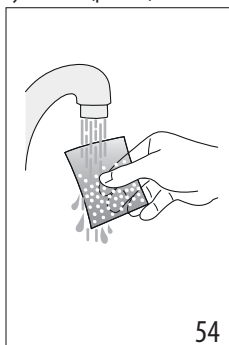
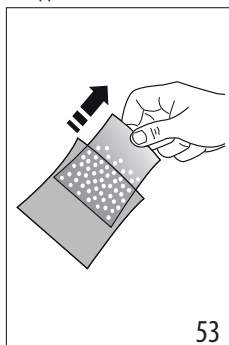

2. Прополощите проточной водой пакет Softballs (рис. 54).

3. Погрузите пакет в бачок для воды (A15) (рис. 55).

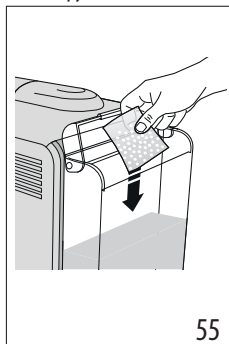

4. Заменяйте пакет Softballs каждые 3 месяца (рис. 56).

## 11. УДАЛЕНИЕ НАКИПИ

### Внимание!

- Перед применением прочитайте инструкции и этикетку средства для удаления накипи (C5) на упаковке средства.
- Рекомендуется использовать только средство для удаления накипи компании De'Longhi. Использование неподходящих средств, а также нерегулярное удаление накипи могут вызвать неисправности, на которые не распространяется гарантия производителя.
- Средство для удаления накипи может повредить чувствительные поверхности. Если продукт случайно опрокинут, немедленно высушите.

### Для удаления накипи

Средство для удаления накипи	Средство для удаления накипи De'Longhi
Емкости	2 по 1 литру каждая
Время	~40 мин

1. (СНИМИТЕ ФИЛЬТР СМЯГЧЕНИЯ ВОДЫ И SOFTBALLS, ЕСЛИ ИМЕЮТСЯ). Залейте в бачок для воды (A15) средство для удаления накипи до уровня А (соответствует упаковке на 100 мл), указанного на внутренней стороне бачка (рис. 57).

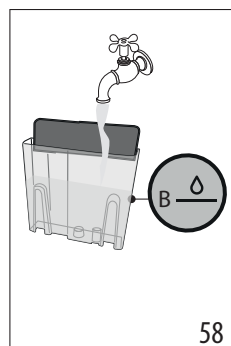
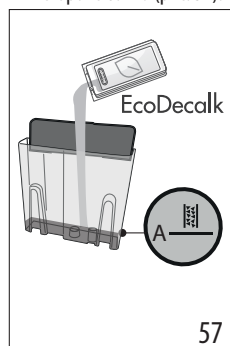

2. Добавьте воду до уровня В (рис. 58). Установите бачок для воды на машину.

3. Подключите принадлежность (C6) к разъему для LatteCreme System (A6) (рис. 59).

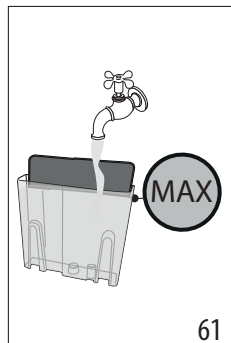
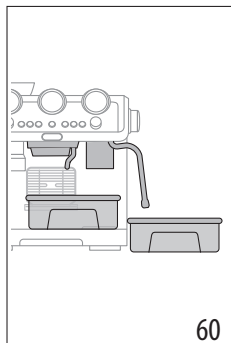
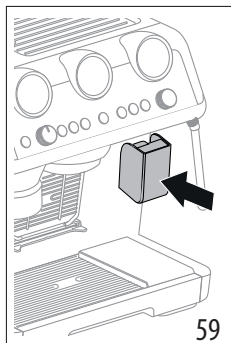

4. Убедитесь, что фильтродержатель (С1) не установлен, поместите емкость под узлы подачи кофе и горячей воды (А7), а также под узел подачи пара (А5) (рис. 60).
5. Удерживайте нажатой кнопку  (В8), пока соответствующий индикатор не начнет мигать.
6. Запускается программа удаления накипи, а жидкость для удаления накипи выходит из узлов подачи. Программа удаления накипи автоматически выполняет ряд ополаскиваний через заданные промежутки для удаления накипи изнутри кофемашины до полного опорожнения бачка для воды.



Подача останавливается, а индикатор  становится белым. Необходимо выполнить цикл ополаскивания:

7. Слейте емкость, использованную для сбора раствора для удаления накипи, и снова поместите ее под узлами подачи.
8. Достаньте бачок для воды, слейте остатки раствора для удаления накипи, промойте его проточной водой и залейте свежую воду до отметки MAX (рис. 61). Установите бачок на место.





9. Удерживайте нажатой кнопку , пока соответствующий индикатор не начнет мигать. Запускается ополаскивание.
10. После завершения ополаскивания подача останавливается, а прибор готов к использованию.
11. Слейте емкости сбора воды ополаскивания.
12. Достаньте и слейте поддон для сбора капель, затем установите его на место.
13. Достаньте бачок для воды и налейте свежую воду, затем поставьте его на место.













Теперь прибор готов к применению.

**Примечание.**







- Если вы хотите выполнить цикл удаления накипи раньше, удерживайте нажатой кнопку  в течение 3 секунд.
- Если удаление накипи запущено по ошибке, удерживайте кнопку  в течение 10 секунд. Ополаскивание нельзя прервать.

## 12. ЗНАЧЕНИЕ СВЕТОВЫХ ИНДИКАТОРОВ



ИНДИКАТОРЫ	ЗНАЧЕНИЕ СВЕТОВЫХ ИНДИКАТОРОВ	ДЕЙСТВИЕ
Все индикаторы быстро мигают	Включение прибора	Самодиагностика
 горит ровно	Это первое включение кофемашины, поэтому необходимо наполнить контур воды.	Выполните действия, указанные в гл. “3. Первое включение прибора”
 горит ровно	Подключена функция энергосбережения.	Обратитесь к гл. “7. Меню настроек”, если хотите отключить функцию
 горит ровно	Контейнер для зерен (А1) пуст	Наполните контейнер для зерен
 мигает	Необходимо выполнить помол, но контейнер для зерен (А1) пуст	Наполните контейнер для зерен
		→

ИНДИКАТОРЫ	ЗНАЧЕНИЕ СВЕТОВЫХ ИНДИКАТОРОВ	ДЕЙСТВИЕ
 оп	Недостаточно воды в бачке (A15) или бачок для воды плохо установлен	Наполните бачок или извлеките его и правильно установите.
 мигает	Необходимо выполнить приготовление напитка, но бачок для воды (A15) пуст	Заполните бачок для воды
 горит ровно	Общее предупреждение	Обратитесь в сервисный центр
 горит ровно	Контейнер для зерен не установлен	Правильно установите контейнер для зерен (A1) или убедитесь, что он правильно установлен
 мигает	Селектор на основании контейнера для зерен (A1) в неправильном положении	Приведите селектор в одно из положений помола (между 1 и 8), помните, что: <ul style="list-style-type: none"> <li>• следует регулировать помол, когда кофемолка находится в работе</li> <li>• следует регулировать на один уровень за раз и выполнить не менее 5 помолов между двумя регулировками</li> </ul>
	Контейнер для зерен (A1) не до конца вставлен, срабатывает предохранительное устройство	Убедитесь, что контейнер для зерен правильно установлен
 горит ровно	LatteCrema System следует очищать после каждого использования	После завершения приготовления молочных напитков выполните автоматическую очистку путем установки рукоятки (D5) на Clean
 горит ровно	Прибор готов к подаче пара.	Прибор достиг температуры для подачи пара. Для начала подачи поверните рукоятку пара (A4)
 мигает	Прибор включен, подключена функция энергосбережения. Рукоятка пара (A4) находится в положении для подачи пара	Индикатор мигает, сообщая, что прибор готовится к подаче пара. Подача начнется, как только прибор нагреется до нужной температуры.
	Прибор готов к подаче пара	Если индикатор горит ровно, прибор нагрелся до температуры, необходимой для подачи пара
	Прибор подает пар	
 горит ровно (оранжевый)	Необходимо выполнить удаление накипи	Выполните удаление накипи, как указано в гл. "11. Удаление накипи"
 мигает (оранжевый)	Прибор выполняет удаление накипи	Завершите действие, как представлено в гл. "11. Удаление накипи"
 горит ровно (белый)	Необходимо выполнить ополаскивание	
 мигает (белый)	Прибор выполняет ополаскивание	



ИНДИКАТОРЫ	ЗНАЧЕНИЕ СВЕТОВЫХ ИНДИКАТОРОВ	ДЕЙСТВИЕ
 горит ровно (оранжевый)	Необходимо выполнить очистку узла подачи кофе	См. пар. "8.1 Очистка узла подачи кофе"
 мигает (оранжевый)	Прибор выполняет очистку узла подачи кофе	
 мигает (белый)	Прибор выполняет ополаскивание	
 +  мигает	Если имеется фильтр для смягчения воды, это означает, что в контур попал пузырек воздуха и препятствует подаче	Нажмите кнопку (B7) соответствующего индикатора  , подача начинается и останавливается автоматически.
	Слишком мелкий помол, кофе выходит медленно или не выходит вообще.	Снимите фильтродержатель (C1), повторите действия по приготовлению кофе с учетом инструкций из пар. "4.1 Этап 1 — Помол (grinding) (рис. 11)" и "4.2 Этап 2 — Прижим (tamping) (рис. 17)"
	Фильтр кофе (C2) или (C3) закупорен	Ополосните фильтры под проточной водой или выполните ополаскивание с помощью кнопки ополаскивания (B5).
	Бачок (A15) плохо установлен, а соответствующие клапаны не открыты	Слегка нажмите на бачок, чтобы открыть клапаны
	Наличие накипи в водяной системе	Выполните удаление накипи, как указано в гл. "11. Удаление накипи"

### 13. ЕСЛИ ИМЕЮТСЯ НЕПОЛАДКИ

ПРОБЛЕМА	ПРИЧИНА	УСТРАНЕНИЕ
Есть вода в поддоне для сбора капель (A11)	Это входит в нормальную работу внутренних контуров машины	Регулярно сливайте и очищайте поддон для сбора капель (A11)
Эспрессо не поступает	Нет воды в бачке (A15)	Заполните бачок
	Индикатор  (B7) горит, что означает, что контур кофе или контур пара пуст	Нажмите кнопку, соответствующую индикатору  , для заполнения контура.
	Фильтр (C2) или (C3) закупорен	Ополосните фильтры под проточной водой или выполните ополаскивание с помощью соответствующей кнопки (B5)
	Неправильно установлен бачок (A15), и клапаны на дне не открыты.	Слегка нажмите на бачок, чтобы открыть клапаны на дне.
	Наличие накипи в водяной системе	Выполните удаление накипи, как указано в гл. "11. Удаление накипи"
	Слишком мелкий помол	Снимите фильтродержатель (C1), повторите действия по приготовлению кофе с учетом инструкций из пар. "4.1 Этап 1 — Помол (grinding) (рис. 11)" и "4.2 Этап 2 — Прижим (tamping) (рис. 17)"
→		

<b>ПРОБЛЕМА</b>	<b>ПРИЧИНА</b>	<b>УСТРАНЕНИЕ</b>
Держатель фильтра не закрепляется на приборе.	Молотый кофе не был придавлен, или его слишком много	Повторите помол с другими настройками. Уменьшите количество дозы. Убедитесь, что фильтр (C2) или (C3) (1 или 2 чашки) правильно подобран в зависимости от дозы для помолы (кнопка 2x (B3) выбрана или нет)
Кофе эспрессо выходит по краям фильтродержателя (C1), а не из отверстий	Держатель фильтра плохо установлен	Правильно закрепите держатель фильтра и поверните его с усилием до упора
	Прокладка узла подачи кофе (A7) потеряла упругость или загрязнена	Замените прокладку узла подачи кофе в сервисном центре
	Фильтр (C2) или (C3) закупорен	Ополосните фильтры под проточной водой или выполните ополаскивание с помощью соответствующей кнопки (B5)
Пенка кофе светлого цвета (кофе быстро выходит из носика).	Необходимо откорректировать настройки прибора	Снимите держатель, повторите действия по приготовлению кофе с учетом инструкций из пар. «4.1 Этап 1 — Помол (grinding) (рис. 11)» и «4.2 Этап 2 — Прижим (tamping) (рис. 17)»
Пенка кофе темного цвета (кофе медленно выходит из носика)	Необходимо откорректировать настройки прибора	Снимите фильтродержатель (C1), повторите действия по приготовлению кофе с учетом инструкций из пар. «4.1 Этап 1 — Помол (grinding) (рис. 11)» и «4.2 Этап 2 — Прижим (tamping) (рис. 17)»
Не образуется молочная пена во время приготовления капучино с помощью LatteCrema System	Недостаточно холодное молоко.	Молоко должно иметь прохладную температуру (как в холодильнике)
	Рукоятка (D5) в неправильном положении	Проверьте и поверните рукоятку в правильное положение (☞ макс. пена; ☞ сред. пена; ☞ мин. пена)
	LatteCrema System загрязнена	Выполните очистку как показано в параграфе «8.6 Очистка LatteCrema System»
	Наличие накипи в водяной системе	Выполните удаление накипи, как указано в гл. «11. Удаление накипи»
После завершения удаления накипи прибор запрашивает еще одно ополаскивание.	Во время цикла ополаскивания бачок не был наполнен до отметки MAX	Повторите ополаскивание (см. гл. «11. Удаление накипи»)
→		

ПРОБЛЕМА	ПРИЧИНА	УСТРАНЕНИЕ
Прибор не выполняет помол кофе	Внутри кофемолки находится посторонний предмет	Выполните очистку жерновов, как указано в пар. "8.3 Очистка жерновов", убедитесь, что из контейнера для зерен удалены все зерна (A2) перед тем, как его достать. Перед установкой жернова на место тщательно уберите все остатки с места его расположения
	Контейнер для зерен (A1) в неправильном положении	Контейнер установлен правильно, если стрелка ▲ выровнена с символом ☐ и слышен щелчок
Если вы хотите поменять сорт кофе	Необходимо удалить все зерна, имеющиеся в машине	<ul style="list-style-type: none"> <li>• Опорожните контейнер для зерен (A1) (с помощью пустых помолов или с помощью удаления оставшихся зерен).</li> <li>• Закрепите фильтродержатель (C1) и выполните помол вхолостую, чтобы освободить канал кофе. Закрепите держатель фильтра на выходе кофемолки (A18), выровняйте по надписи INSERT и поверните вправо держатель (рис. 22). Помол начинается, когда держатель достигает положения CLOSE, и прекращается автоматически. Повторите, пока фильтр не останется пустым</li> <li>• Поместите в контейнер (A1) новый сорт кофейных зерен</li> <li>• Если при помоле не достигается идеальное количество, выполните действия как при первом использовании</li> </ul>
→		

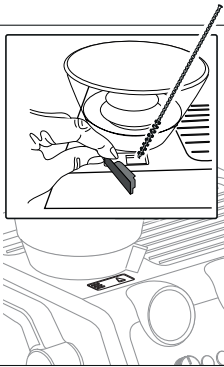
ПРОБЛЕМА	ПРИЧИНА	УСТРАНЕНИЕ
<p>После помола фильтр кофе (C2) или (C3) пуст</p> <p>После помола в фильтре слишком много кофейного порошка</p>	<p>Закупорен желоб кофе кофемолки</p>	<p>Выполните очистку как указано в пар. «8.5 Очистка Smart tamping station». Если проблема не устранена, откройте дверцу (A19) для доступа к желобу и прочистите его ершиком</p> 
<p>После помола кофейный порошок в фильтре (C2) или (C3) не достигает идеального количества</p>	<p>Smart Tamping Station (выход кофемолки) нуждается в очистке</p> <p>Необходимо отрегулировать количество молотого кофе</p> <p>Со временем жернова изнашиваются</p>	<p>Выполните очистку как указано в пар. «8.5 Очистка Smart tamping station», затем повторите помол</p> <p>Отрегулируйте количество при помощи специальной рукоятки (B2) согласно указаниям из пар. «Идеальное количество». Если рукоятка уже в положении макс, выполните действия из раздела «Дополнительная регулировка помола»</p> <p>Выполните замену жерновов, как указано в пар. «8.4 Замена жерновов»</p>

Құрылғыны пайдаланбас бұрын әрқашан қауіпсіздік ережелерін оқып алыңыз.

## 1. СИПАТТАМА

### 1.1 Құрылғының сипаттамасы - А

- A1. Дәндер ыдысы
- A2. Дән ыдысының қақпағы
- A3. Кесе науасы
- A4. Бу тетігі
- A5. Бу түтігі
- A6. Lattecrema жүйесін қосу
- A7. Кофе шүмегі
- A8. Эспрессоға арналған кесе торы
- A9. Шыныаяқтар мен кружкаларға арналған тор
- A10. Тамшы науасының торы
- A11. Тамшы науасы
- A12. Тамшы науасындағы су деңгейінің көрсеткіші
- A13. Су ыдысының қақпағы
- A14. Су ыдысын шығару тұтқасы
- A15. Су ыдысы
- A16. Қуат сымын қосқыш ұяшығы
- A17. Негізгі қосқыш (ON/OFF)
- A18. Кофе тартқыштың шығысы (тығыздау станциясы)
- A19. Кофе тартқыштың кофе бағыттағышы орналасқан бөлігінің қақпағы
- A20. Тығыздағыш тетігі

### 1.2 Басқару тақтасының сипаттамасы - В

- B1. ON/Standby (ҚОСУ/Күту режимі) түймесі
- B2. Кофені мөлшерлеу дөңгелегі
- B3. "X2" түймесі: 2 кофелік сүзгіні пайдалануға арналған
- B4. Кофе температурасының түймесі
- B5. "Белсенді шаю" түймесі
- B6. "OK" түймесі: сусынды құюға/растауға арналған
- B7. Ыстық су түймесі
- B8. "Қақ тазалау" түймесі
- B9. "Му" түймесі: сусын мөлшерін реттеуге арналған
- B10. Сусын таңдау дөңгелегі
- B11. "Сусын таңдалды" шамы:

#### Эспрессо негізіндегі сусындар

- Эспрессо
- Americano
- Кофе

#### Сүт негізіндегі сусындар

- Каппучино
- Флэт уайт
- Латте Макиато
- B12. "Таза сүт" шамы
- B13. "Дән ыдысы жоқ" шамы
- B14. "Жалпы дабыл" шамы
- B15. Қысым манометрі
- B16. "Су жоқ" шамы
- B17. "Дән ыдысы бос" шамы
- B18. "Қуат үнемдеу" шамы
- B19. Жарықдиодты модульдің процесі:
  - Құрылғыда жүріп жатқан жұмысты көрсетеді
  - Мөлшер деңгейін орнату
  - Демдеу температурасын орнату

### 1.3 Керек-жарақтардың сипаттамасы - С

- C1. Сүзгі ұстағыш
- C2. 1 кеселік кофе сүзгісі
- C3. 2 кеселік кофе сүзгісі
- C4. "Су қаттылығын тексеру" көрсеткіш қағазы
- C5. Қақ тазартқыш
- C6. Қақ тазалау керек-жарағы
- C7. Алынбалы қуат сым
- C8. Түтік щеткасы
- C9. Кофе шүмегін тазалау дискісінің керек-жарағы
- C10. Шүберек
- C11. Softballs
- C12. Бу түтігін тазалау инесі

### 1.4 Қосымша тазалау керек-жарақтары

Толығырақ ақпарат алу үшін [Delonghi.com](http://Delonghi.com) сайтына кіріңіз.



#### Тазалау таблеткасы

("8.1 Кофе шүмегін тазалау" бөлімін қараңыз)



#### Тазалағыш

EAN коды: 8004399333307

### 1.5 LatteCrema жүйесінің сипаттамасы - D

- D1. Сүт ыдысының қақпағы
- D2. Сүт ыдысының жалғағышы
- D3. Қақпақты босату түймесі
- D4. Сүт шүмегі (биіктігі реттеледі)
- D5. Көпіршік таңдау тетігі
- D6. Тетік корпусы



- D7. Сүт сору түтігі
- D8. Сүт ыдысы

## 2. ҚҰРЫЛҒЫНЫ ДАЙЫНДАУ

Барлық қосымша құралдарды жылы сумен және ыдыс жуғыш сұйықтықпен жуып, мына әрекеттерді орындаңыз:

- 1. Тамшы науасын (A11) (кесе торы (A9) мен тамшы науасы торы (A10) салынған соң) енгізіңіз (1-сурет);
- 2. Су ыдысын (A15) (2-сурет) шығарыңыз және таза сумен MAX деңгейінен (3-сурет) асырмай толтырыңыз.
- 3. Ыдысты құрылғыдағы орнына салыңыз.

**Маңызды:** Құрылғыны ыдысында су болмағанда немесе ыдыстың өзі болмағанда ешқашан пайдаланбаңыз.

**Есіңізде болсын:** Судың қаттылығын "7. Мәзір параметрлері" бөліміндегі нұсқауларға жүгіне отырып, тез арада реттеңіз.

## 3. ҚҰРЫЛҒЫ ПАРАМЕТРЛЕРІН ОРНАТУ

- 1. Қуат сымның жалғағышын (C7) құрылғының артқы жағындағы ұяшыққа (A16) енгізіңіз (4-сурет); содан кейін розеткаға қуат сымның ашасын қосыңыз. Құрылғының артындағы негізгі қосқыштың (A17) басылғанына және I күйіне орнатылғанына көз жеткізіңіз (5-сурет);
- 2. Сыйымдылығы кемінде 100 мл болатын ыдысты ыстық су шүмегінің (A7) және капучино жасағыштың астына қойыңыз (6-сурет);
- 3.  шамына қатысты түймені (B7) басыңыз (7-сурет). Құйылу автоматты түрде басталып, тоқтайды. Ыдысты босатыңыз.

Құрылғыны пайдаланбас бұрын, ішкі желіні шаюыңыз керек. Мына әрекетті орындаңыз:

- 4. Сүзгісі салынған сүзгі ұстатқышты (C1) құрылғыға бекітіңіз. Дұрыс бекіту үшін, сүзгі ұстатқыштың тұтқасын "INSERT" белгісіне (8-сурет) туралаңыз да, тұтқаны оңға қарай "CLOSE" белгісімен тураланғанша бұраңыз;
- 5. Сүзгі ұстатқыштың және капучино жасағыштың (A5) астына кесе қойыңыз;
- 6.  шамына қатысты түймені (B5) басыңыз. Құю басталады (9-сурет);
- 7. Қую аяқталған кезде бу жүйесін шаю үшін бу дөңгелегін (A4) (10-сурет) бұрап, бірнеше секунд бу шығарыңыз; біз ұсынған оңтайлы бу тиімділігіне қол жеткізу үшін осы әрекетті 3 не 4 рет қайталаңыз. Бұл

сүтті көпіршіту немесе булау алдында бу тұтқасын тазалау үшін қажет

Құрылғы пайдалануға дайын болады.

**Есіңізде болсын:** Құрылғы ұзақ уақыт бойы пайдаланылмаған кезде де ішкі жүйелерді шайған жөн.

Құрылғыны бірінші рет пайдаланған кезде, ол қанағаттанарлық нәтижені 4-5 кесе кофе жасағаннан кейін береді. Сүзгідегі ((C2) немесе (C3)) тартылған кофенің мөлшеріне ерекше назар аударыңыз ("4.1 1-қадам - кофе тарту (11-сурет)" бөліміндегі нұсқауларды көріңіз). "Дәл мөлшер" бөлімінде сипатталғандай жалғастырыңыз.

## 4. КОФЕ ҚҰЮ

### 4.1 1-қадам - кофе тарту (11-сурет)

- 1. Шанаққа дәндерді салыңыз (A1) (12-сурет). Ең жақсы өнім – балғын өнім; өзіңізге қажет мөлшерде ғана салыңыз.
- 2. Ұсақтық деңгейін таңдаңыз (13-сурет). Зауыттық параметр – 5 (орташа ұсақтық). Егер мұндай тарту деңгейі көңіліңізден шықпаса, қалаған деңгейді және кофе түрін талғамыңызға сай таңдаңыз (деңгейді тарту кезінде таңдаңыз).
- 3. Бір (C2) немесе екі мөлшерлік сүзгіні таңдап, (C3) сүзгі ұстағышқа (C1) (14-сурет) орналастырыңыз. Егер екі мөлшерлік сүзгіні пайдалансаңыз, X2 түймесін (B3) басыңыз: Бұл эспрессоның құйылу мөлшерін де екі есеге арттырады.
- 4. Мөлшер деңгейін орнату үшін дөңгелекті (B2) ең аз күйден бастап жоғары қарай реттеңіз. (15-сурет).

**Есіңізде болсын:**

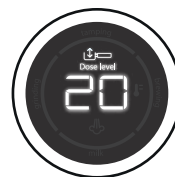

Индикаторда көрсетілген нөмірлер (B19) сүзгі ұстағышындағы кофе мөлшері тиісті деңгейге жеткенін көрсететін бағдарлағыштың рөлін атқарады. Олар кофе тартқыш параметрлерін немесе өлшем бірліктерін (грамм/унция) немесе тарту уақытын білдірмейді.

Ұсыныстарды "Дәл мөлшер" бөлімінен қараңыз.

- 5. Сүзгі ұстағышты кофе тартқыштың шығыс тесігіне (A18) бекітіп, оны "INSERT" жазуына туралаңыз: одан кейін сүзгі ұстағышты оңға қарай бұраңыз (16-сурет). Кофені

тарту сүзгі ұстатқыш CLOSE деңгейіне жеткен кезде басталып, автоматты түрде тоқтайды.

## 4.2 Мөлшерді реттеу



Тарту кезінде әртүрлі сұрыптағы кофе дәндері әртүрлі қасиеттерді көрсетуі мүмкін, сондықтан мөлшер деңгейін тартудың бас жағында орнату маңыздырақ.

Бұл суретте біз мөлшерді реттеудің бірнеше нұсқауларын көрсеттік. Әрине, реттеуді осы қуыру деңгейінің негізде ұсынылған ауқымдар бойынша бастаған жақсырақ болады, бірақ олар кофе дәндерінің қасиеттеріне байланысты аздап әртүрлі болуы мүмкін.

1. Мөлшерді ең төменгі күйден бастап реттеңіз.
2. Кофенің қуырылу деңгейі мен түрін ескере және ауқым көрсеткіштеріне сүйене отырып, тұтқаны ақырын бұраңыз.

## 4.3 2-қадам - тығыздау (17-сурет)

1. Тартудан кейін тетікті (A20) толығымен төмен қарай тартыңыз (сүзгі ұстағышты шығармаңыз) (18-сурет). Мінсіз нәтиже алу үшін осыны екінші рет қайталаңыз.
2. Сүзгі ұстағышты шығару кезінде тетікті төменгі күйде ұстаңыз (19-сурет). Бұл орындалған соң, тетікті бастапқы орнына қайтарыңыз.
3. Мөлшерді тексеріңіз ("Дәл мөлшер" бөлімін қараңыз) және сүзгі ұстағышты қайнату бөлігіне (A7) бекітіңіз (20-сурет).

## "Дәл мөлшер"

- Кофе сүзгілерінің ішіндегі анықтама белгісі мінсіз мөлшерді білдіреді.

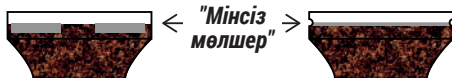

### Лазер белгісі

### Бұдыр белгісі

- Лазер белгісі бар сүзгілер үшін: белгінің жоғарғы сызығы мінсіз мөлшерді білдіреді.
- Бұдыр белгісі бар сүзгілер: бұдырлы сызық мінсіз мөлшерді білдіреді.
- Кофені тығыздаған соң, ол ұсынылған мөлшерге тең болуы керек. Мінсіз мөлшерге қол жеткізгенге дейін, мөлшер дөңгелегін (B2) бірнеше рет реттеу қажет болуы мүмкін.
- Мінсіз мөлшер қалыпты деңгейде болса да кофе шамадан аз не көп шығып жатса, кофе тартқышты майдалау немесе ірілеу параметрге орнатыңыз ("4.1 1-қадам - кофе тарту (11-сурет)" бөлімін қараңыз). Кофе шамадан тыс шықса (тым баяу құйылса), онда ірілеу етіп тарту қажет болғаны. Кофе шамадан аз шықса (тым тез құйылса), онда майдалау етіп тарту қажет болғаны.
- **Бариста кеңесі:** Кофе жасауды жақсылап аяқтау үшін тығыздағыш (A20) әлі де төменде тұрған кезде, кофе сүзгісін шығарып алыңыз.

## 4.4 3-қадам - қайнату (21-сурет)

1. Қалаған сусынды таңдаңыз (22-сурет).
2. Қайнатуды бастау үшін ОК (B6) түймесін басыңыз (23-сурет) (демдеу және алдын ала демдеу). Кофе құю автоматты түрде тоқтатылады.

## 5. СҮТ СУСЫНДАРЫН ЖАСАУ

### 5.1 Қолдап көпірту (24-сурет)

1. Сүт құтысын (D8) таза салқын сүтпен толтырыңыз. Сүт қызғанда көлемі үш есе ұлғаяды (25-сурет). Қоюлау көпіршікке қол жеткізу үшін ең дұрысы – тоңазытқыш температурасындағы (шамамен 5°C) қаймағы алынбаған сиыр сүтін пайдалану

# My Latte Art

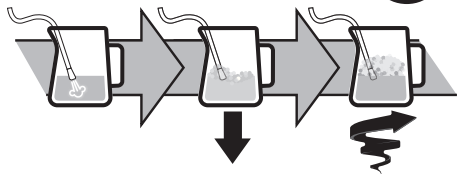

2. Көпіршік жасау үшін саптаманы (A5) сүттің бетіне қойыңыз, сонда сүт пен буды араластырғанда ол ауа жинайды.
3. Бу саптамасын жай ғана сүт бетіне қойыңыз, тым көп ауа кіргізу арқылы көбіктерді үлкейтіп алмаңыз.
4. Бу саптамасын жай ғана сүт астына енгізіңіз: иірілім пайда болатындай етіп араластырыңыз. Қалаған температураға дейін қызған соң, бу тетігін өшіріп, құтыны тек бу толығымен тоқтаған соң алыңыз.

### Бариста кеңестері:

- Ең жақсы өнім – балғын өнім: Әркез жас салқын сүтті пайдаланыңыз.
- Ең жақсы нәтижелер алу үшін қаймағы алынбаған сүтті пайдаланыңыз. Сүт өнімдері мен сүт емес өнімдер текстураланудың оңайлығы бойынша әртүрлі болады (түріне қарай).
- Сүтті көпірткен соң, құтыны айналдыра шайқау арқылы қажет емес көбіктерді жойыңыз.

### Бу түтігін тазалау:

1. Әр пайдаланған сайын, бу түтігінен кез келген сүт қалдығын жұмсақ дымқыл шүберекпен сүртіңіз (26-сурет). Мінсіз тазалау үшін Eco MultiClean пайдалануды ұсынамыз: оны сүт ақуыздары мен майларының қалдықтарын кетіріп, бүкіл құрылғыны тазалау үшін пайдалануға болады.
2. Тереңірек тазалау үшін буды (10-сурет) пайдаланыңыз.
3. Бу түтігінің тиімділігін сақтау үшін оның суығанын күтіп, одан кейін саптаманың 3 тесігін тазалау құралымен (C12) ашыңыз (27-сурет).

## 5.2 LatteCrema жүйесімен сүт сусындарын жасау (28-сурет)

1. Сүт ыдысын (D8) тоңазытқыштағы таза салқын (5°C) сүтпен толтырыңыз (29-сурет).
2. Қақпақты (D1) жабыңыз (30-сурет).
3. Қалаған көбік деңгейін таңдау үшін тетікті (D5) бұраңыз (31-сурет).

### Сүт көпірту тетігінің күйлері:

CLEAN	МАКС. көпіршік	ОПТА көпіршік	МИН. көпіршік	Тетікті шығару немесе енгізу үшін
LatteCrema жүйесін әрбір қолданудан кейін тазалау				

4. Сүт ыдысын бекітіңіз (32-сурет).
5. Мінсіз мөлшерді дайындаңыз ("4.1 1-қадам - кофе тарту (11-сурет)" және "4.3 2-қадам - тығыздау (17-сурет)" бөлімдерін қараңыз) сүзгі ұстағышты орнына бекітіңіз.
6. Қалаған сусынды таңдаңыз (33-сурет).



Сусын	Эспрессо	Сүт	Көпіршік	Мөлшер (мл)	X2 (мл)
Капучино	1	✓	✓	≈150	≈230
Латте Макиато	1	✓	✗	≈150	≈230
Флэт уайт	1	✓	✓	≈250	≈330

- **Екі мөлшерлік сүт сусындары (2x):** Сүт ыдысын (D8) жеткілікті сүт мөлшерімен ыдыста белгіленген MAX деңгейіне дейін толтырыңыз (25-сурет). Ыдыстың бүйіріндегі әрбір белгі шамамен 100 мл сүтке негізделген.

- **Ең жақсы өнім – балғын өнім.** Балғын, салқын және толық кілегейлі сүт ең жақсы нәтижені береді.
7. Қайнатуды бастау үшін ОК (B6) түймесін басыңыз (23-сурет). Құрылғы кофені, содан кейін сүтті автоматты түрде қайнатады.

**LatteCrema жүйесін әрбір қолданудан кейін тазалау:**

1. Сүт ыдысын құрылғыда қалдырыңыз (оны босатудың қажеті жоқ). Көпіршітілген сүт шүмегінің (D4) астына кесені немесе басқа ыдысты қойыңыз (34-сурет).
2. Дөңгелекті (D5) "Clean" (Тазалау) бағытына бұраңыз (35-сурет).

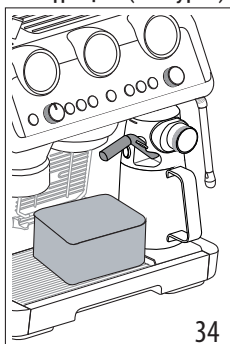

3. Тазалау автоматты түрде басталады және тоқтайды. **Абайлаңыз:** Тазалаудан кейін текті көбік параметріне қайта бұрауды ұмытпаңыз.
4. Сүт ыдысын шығарып алып, тоңазытқышқа салыңыз да, тез арада тұтыныңыз.

Мінсіз тазалау үшін Eco MultiClean пайдалануды ұсынамыз: оны сүт ақуыздары мен майларының қалдықтарын кетіріп, бүкіл құрылғыны тазалау үшін пайдалануға болады.

**6. КОФЕ СУСЫНДАРЫНЫҢ МӨЛШЕРІН**

**☺ ТҮЙМЕСІМЕН РЕТТЕУ (B9)**

1. Сүзгі ұстатқышты (C1) ((C2) немесе (C3) сүзгісі салынған және тартылған кофе салынған) бекіткен соң, құрылғыны жасағыңыз келген кофе сусынының 1 немесе 2 кесесін құюға дайындаңыз. Егер сүт негізіндегі сусын параметрлерін реттегіңіз келсе, Lattecrema жүйесін дайындаңыз және тіркеңіз
2. Бағдарламаланатын сусынды таңдау үшін дөңгелекті (B10) бұраңыз.

3. ☺ түймесін басыңыз: ОК түймесіне (B6) қатысты шам тұрақты жанады және ☺ түймесіне қатысты шам жыпылықтайды.
4. Құрылғыны іске қосу үшін ОК түймесін басыңыз. ОК және ☺ түймелеріне қатысты шамдар жыпылықтайды.
5. Қалаған сусын мөлшері құйылған кезде, ОК түймесін тағы да басыңыз. Егер рецептіде басқа ингредиент болса, ол құйыла бастайды: қалаған мөлшер құйылған кезде, ОК түймесін тағы басыңыз.
6. Жаңа параметрді сақтау үшін ☺ түймесін басыңыз. Құрылғы қайта пайдалануға дайын және ☺ түймесі жанған күйде қалады.

Егер жаңа параметрді сақтағыңыз келмесе, кез келген басқа түймені басыңыз.

**Есіңізде болсын:**

- Кофе сусындарын бағдарламалауға болады, бірақ бу мен ыстық суды бағдарламалауға болмайды.
- Бағдарламалауда сусындардың мөлшерлерін өзгертуге болады, бірақ тартылған кофе мөлшері өзгермейді.
- "X2" сусындарын бөлек бағдарламалауға болады.

**My LatteArt** ☺

- бағдарламаланбайды.
- Әдепкі сусын мөлшерлерін қайта орнату үшін, ☺ түймесін өшкенше басып тұрыңыз. Таңдалған сусын әдепкі мәндерге қайта орнатылады.

Кофе кесесі	Әдепкі мөлшер	Бағдарламаланатын мөлшер
Espresso	35 мл	25-90 мл
X2	70 мл	50-180 мл
Coffee	80 мл	50-120 мл
X2	160 мл	120-240 мл
Americano	120 мл	• эспрессо: 25-60 мл • су: 25-120 мл
X2	240 мл	• Эспрессо: 50-120 мл • су: 50-240 мл

## 7. МЭЗІР ПАРАМЕТРЛЕРІ

7. Реттеу мәзірін ашыңыз		
Екі түймені де 5 секунд басып тұрыңыз	x2	
8. Параметрді таңдаңыз		
		
Сусын	Тиісті параметр	Орнату әдісі
 Espresso	Қуат үнемдеу	 →  Қосу
		 →  Өшіру
 Coffee	Автоматты түрде өшіру	 → 9 минут
		 → 1,5 сағат
		 → 3 сағат
 Cappuccino	Дыбысты сигнал	 →  Қосу
		 →  Өшіру
 Latte	Кофе тартуды қосымша реттеу	 → 1-ші ауқым
		 → 2-ші ауқым
 Flat White	Әдепкі мәндер	Басып тұрыңыз: <b>OK</b> түймесін (5 секунд, жарықдиод тұрақты жанғанша)
 Americano	Су қаттылығы	 → жұмсақ
		 → орташа
		 → қатты/өте қатты
→		

## 9. Жаңа параметрлерді ON/Standby (ҚОСУ/Күту режимі) түймесін (B1) басы арқылы сақтаңыз

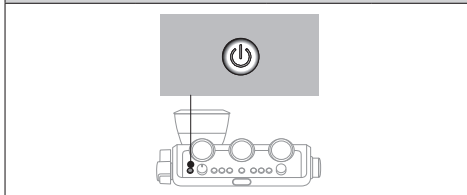







## 8. ТАЗАЛАУ ЖӘНЕ КҮТІП ҰСТАУ









### Маңызды!

- Кофе құрылғысын тазалау үшін еріткіштерді, қырғыш заттарды немесе спиртті пайдаланбаңыз.
- Қоқымдарды және кофе қалдықтарын кетіру үшін металдан жасалған заттарды пайдаланбаңыз, себебі олар құрылғының металл немесе пластмасса бөліктерін сырып тастауы мүмкін.
- Құрылғы бір аптадан астам уақыт бойына қолданылмайтын болса, оны қайтадан қолданбас бұрын шайған жөн.

### Қауіпті!

- Тазалау барысында, кофе жасағышты ешқашан суға батырмаңыз. Бұл – электрлік құрылғы.
- Құрылғының сыртын тазаламас бұрын, оны өшіріп, розеткадан суырыңыз да, суытып қойыңыз.

				
	×	✓	✓	×
	✓	×	×	✓
	×	×	×	✓
→				

					
	×	×	×	✓	✓
	×	×	✓	✓	×
	×	×	×	✓	✓
	✓	✓	×	✓	✓



## 8.1 Кофе шүмегін тазалау

 Шамы жанған (қызғылт-сары) (B5) кезде, кофе жолдары тазалануы керек. Тазалауды жүзеге асыру үшін кофе машиналарын тазалауға арналған таблеткаларды сатып алуыңыз керек. Қосымша ақпаратты Delonghi.com сайтынан қараңыз.

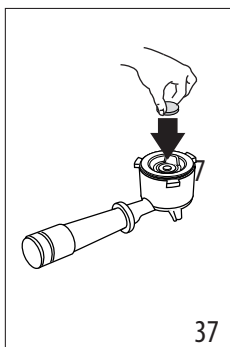
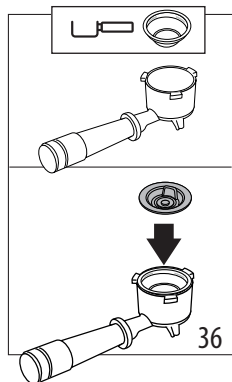
- 1 кесе кофе сүзгісін (C2) сүзгі ұстатқышқа (C1) енгізіңіз (36-сурет).
- Кофе сүзгісіне диск түріндегі арнайы керек-жарақты (C9) (36-сурет) кигізіп, оны түпке дейін басыңыз;



3. Керек-жараққа тазалау таблеткасын (37-сурет) салыңыз.
4. Сүзгі ұстағышты кофе шүмегіне (A7) бекітіңіз.
5. Су ыдысын толтырыңыз (A15). Тамшы науасының (A11) бос екеніне көз жеткізіңіз.

6.  Түймесін тиісті шам жыпылықтағанша (қызғылт-сары) басып тұрыңыз. Бірнеше минуттан соң, тазалау автоматты түрде тоқтайды;
7. Сүзгі ұстағышты және тазалауға арналған дискті шығарып алыңыз;
8. Сүзгі ұстағышты және сүзгіні ағын су астында жуыңыз;
9. Сүзгі ұстағышты тағы да енгізіп,  түймесін (B5) басу арқылы шайыңыз: сүзгі ұстағыштың астына ыдыс қойған жөн;
10. Тамшы науасын алып, босатыңыз.

### Есіңізде болсын:

Бұл процедураны бастау үшін  түймесін (B5) бірнеше секунд басыңыз. Бұл опцияны жою үшін осы түймені 10 секунд басыңыз.

## 8.2 Дән ыдысының корпусын тазалау

1. Дән ыдысының (A1) бос екеніне көз жеткізіңіз. Қажет болса, кофе тартқышты босату үшін оны дәнсіз іске қосыңыз;
2. Дән ыдысын сағат тіліне қарсы бұрау арқылы босатып, құрылғыдан шығарып алыңыз (38-сурет)

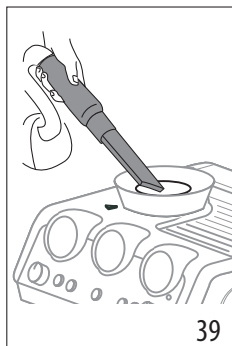
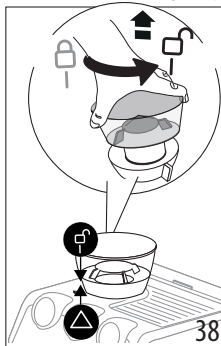

3. Кофе қалдықтарын шаңсорғышпен тазалаңыз (39-сурет).
4. Дән ыдысының корпусын ылғал шүберекпен сүртіп, кептіріңіз (40-сурет);

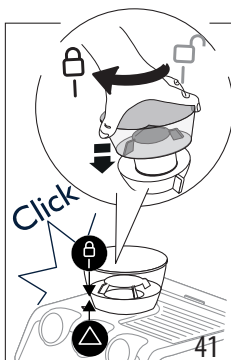
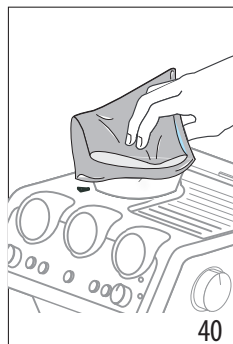

5. Ыдысты кофе тартқыштағы орнына салыңыз. Ыдыс дұрыс жабылуы үшін ▲ көрсеткісі  белгісімен туралануы және "сырт" еткен дыбыс шығуы керек (41-сурет).

### 8.3 Қашауістерді тазалау

Дән ыдысын (A1) тазалап жатқан кезде, ыдыс корпусын және жоғарғы қашауісті дымқыл шүберекпен тазалаңыз. Қашауісті алып, уәкілетті тұтынушыларға қызмет көрсету орталығына ауыстыртуға болады.

Қашауісті бөгде зат қыстырылып, бұғатталып қалған жағдайда да шығарып алуға болады. Мұндай жағдай болса, дән ыдысын шығарып алып, былай тазалаңыз:

1. Сүзгі ұстағышты (C1) бекітіп, кофе тартқышты дән салынбаған күйінде бірнеше рет іске қосыңыз;
2. Құрылғыны өшіріңіз;
3. Ұсақтықты таңдағышты сағат тіліне қарсы бағытта "REMOVE" бағытына барғанша бұраңыз (42-сурет).

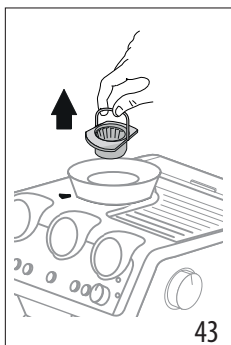
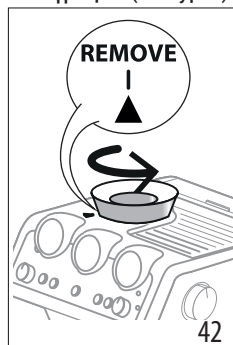

4. Жоғарғы қашауісті тұтқадан ұстап қолмен тартып шығарыңыз (43-сурет).

5. Қашауісті қылшақпен (бірге берілмейді) тазалап(44-сурет), кофе қалдықтарын шаңсорғышпен алып тастаңыз (39-сурет).

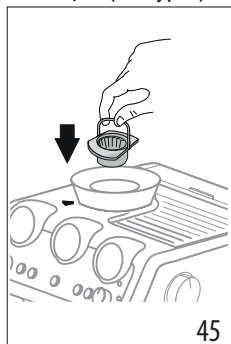
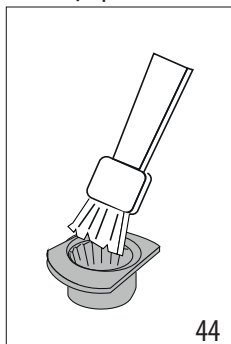

6. Жоғарғы қашауісті орнына салыңыз (45-сурет);

7. Қалаған тарту деңгейін таңдау үшін таңдағышты бұраңыз (13-сурет);

Қашауісті тұтқамен тарту арқылы оны дұрыстап енгізіңіз. Дұрыс енгізілсе, ол қозғалмауы керек.

### 8.4 Қашауістерді ауыстыру

Кофе дәндерінің мөлшері тіпті одан бетер азайса, тұтынушыларды қолдау орталығымен хабарласып, қашауісті ауыстыртыңыз, сосын параметрлер мәзірін ашу ("7. Мәзір параметрлері") және "Тарту ұсақтығын қосымша реттеудің" бірінші деңгейін таңдау арқылы кофе тартқышты тағы реттеңіз. Одан кейін тартылған кофе мөлшерінің дөңгелегін (B2) ең төменгі күйге бұрап, мөлшерді алғашқы қолданған кездегідей орнатыңыз ("Дәл мөлшер" бөлімін қараңыз).

### 8.5 "Ақылды тығыздау станциясын"

#### тазалау

1. Бекіту аймағын щеткамен тазалаңыз (46-сурет).
2. Тетікті (A20) барынша тартып, тығыздағыш цилиндрді щеткамен тазалаңыз (47-сурет). Сосын тетікті босатыңыз.
3. Түтік щетканы (C8) кофе воронкасын тазалау үшін пайдаланыңыз (48-сурет).

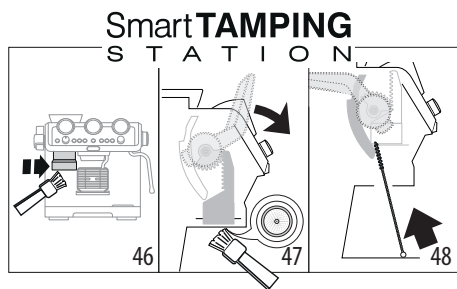

## 8.6 Lattecrema жүйесін тазалау

Барлық компоненттерді жуғыш машинаның жоғарғы себетіне қойып жууға болады. Егер сізде ыдыс жуғыш машина болмаса, осы бөлімнің соңында берілген ескертпеге сай қолмен жуыңыз.

1. Босату түймесін (D3) басыңыз және сүт ыдысының қақпағын (D1) көтеріңіз;
2. Сүт шүмегі (D4) мен сүтті ішке тарту түтігін (D7) алыңыз (49-сурет);

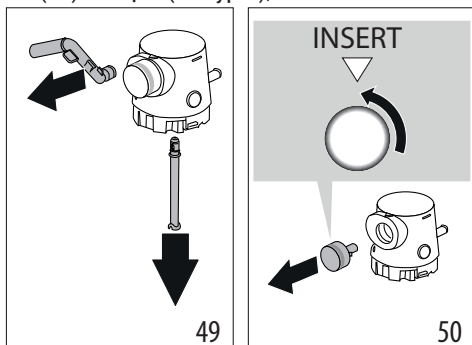

3. Көпіршікті реттеу дөңгелегін (D5) "Insert" позициясына (50-сурет) қарай саға тіліне қарсы бұрып, тартыңыз;
4. Дөңгелектің астындағы бос орында және ойықта сүт қалдықтары қалмасын (51-сурет): қажет болса, ойықты тіс тазартқыш таяқшамен қырғылаңыз;

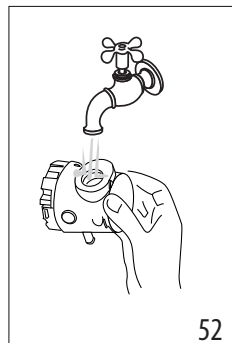
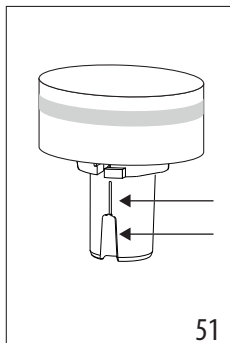

5. Көпіршікті реттеу дөңгелегі орнының ішкі жағын ағынды сумен шайыңыз (52-сурет);
6. Ішке тарту түтігі мен шүмектің сүт қалдықтарымен бітеліп қалмағанын тексеріңіз;
7. Қақпақтың барлық құрамдас бөліктерін қайта құрастырыңыз;
8. Сүт ыдысын мұқият жуыңыз, сосын шайыңыз (D8) ;
9. Қақпақты сүт ыдысына қайта орналастырыңыз.

### Есіңізде болсын: қолмен жуыңыз

Қақпақты ыдыс жуу машинасында жусаңыз, барлық бөлшектер таза жуылады. Қолмен жуған кезде, сүт ыдысының барлық бөлшектерін ыстық сумен мұқият жуып, 4-бөлімде сипатталған нұсқауды орындамас бұрын оларды ыстық су құйылған ыдысқа 30 минутқа салып қойыңыз .

## 9. СУ ҚАТТЫЛЫҒЫ

Қақ тазалау шамы (B8) су қаттылығына сай орнатылған қолдану кезеңінен кейін жанады. Сонымен қатар, бұл құрылғыны әр түрлі аймақтардағы құбыр суының қаттылығына сай бағдарламалауға болады, сондықтан қақ тазалау туралы хабардың көріну жиілігі әр түрлі болады.

1. "TOTAL HARDNESS TEST" (Жалпы қаттылықты тексеру) көрсеткіш қағазын (C4) орамынан шығарыңыз.
2. Қағазды стакандағы суға бір секундқа толығымен батырып алыңыз.
3. Қағазды судан шығарып, жайлап сілкіңіз. Шамамен бір минуттан соң 1, 2, 3 немесе 4 қызыл шаршы судың қаттылығының



деңгейіне қарай көрінеді. Әрбір шаршы бір деңгей болып есептеледі.

Жалпы сынағының нәтижесі	қаттылық	Түйме	Деңгей
		x2	1 жұмсақ су
			2 орташа су
			3 қатты немесе өте қатты су

4. Құрылғы қағын келесі бөлімінде сипатталғандай етіп тазалаңыз:

## 10. SOFTBALLS ҚОЛДАНУ

Softballs (Софтболс) (С11) дегеніміз судың органолептикалық қасиеттерін өзгертпей, құрылғының жарамдылық мерзімін ұзартатын және кофені бірқалыпты қою және хош иісті ететін инновациялық жүйе.

1. Softballs қалташығын бумасынан шығарыңыз (53-сурет).

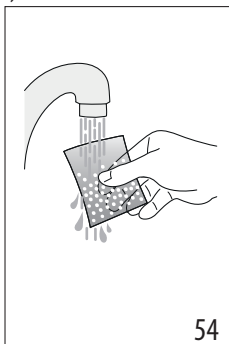
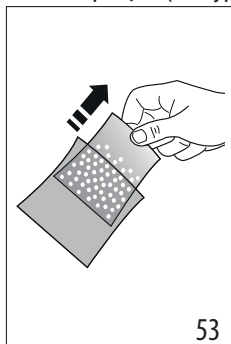

2. Softballs қалташығын кран суымен шайыңыз (54-сурет).

3. Қалташықты су ыдысына батырыңыз (А15) (55-сурет).

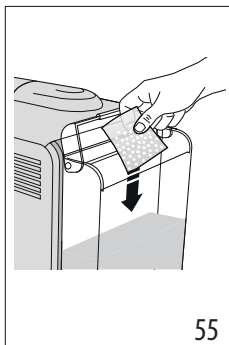

4. Softballs қалташығын 3 ай сайын ауыстырыңыз (56-сурет).

## 11. ҚАҚ ТАЗАЛАУ

### Есіңізде болсын

- Қолданбас бұрын нұсқауларды және қақ тазартқыш қабындағы жапсырманы (С5) оқып шығыңыз.
- Тек De'Longhi қақ тазалағышын ғана пайдалану маңызды болып табылады. Басқа қақ тазалағышты пайдалану және/немесе қақ тазалауды дұрыс орындамау өнім жасаушысының кепілдігінде қаралмаған ақаулықтарға себеп болуы мүмкін.
- Қақ тазалағыш нәзік беттерді зақымдауы мүмкін. Егер бұл өнім байқаусызда төгіліп кетсе, оны дереу құрғатыңыз.

Қақ тазалау	
Қ а қ тазартқыш	De'Longhi қақ тазартқышы
Ыдыстар	2: Ұсынылған сыйымдылық; Әрбірі 1 л
Уақыты	~40 мин

1. (ЕГЕР БОЛСА, SOFTBALLS ҚАЛТАШЫҒЫН ЖӘНЕ СУ ЖҰМСАРТҚЫШ ҚҰРАЛДЫ АЛЫҢЫЗ). Қақ тазалағышты (А15) ыдыс ішіндегі А белгісіне дейін құйыңыз (бір 100 мл қапшыққа тең) (57-сурет).

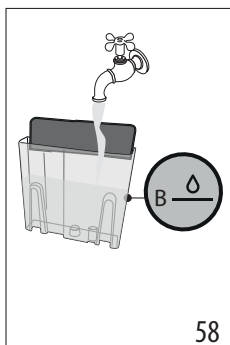
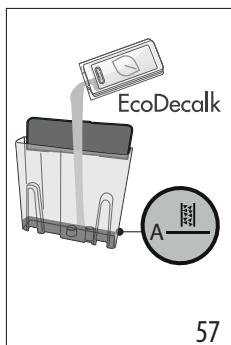

2.  $\Delta$  В деңгейіне дейін су құйыңыз (58-сурет). Сосын су ыдысын құрылғыдағы орнына салыңыз.
3. Арнайы керек-жарақты (С6) Latte Crema жалғағышына (А6) енгізіңіз (59-сурет).

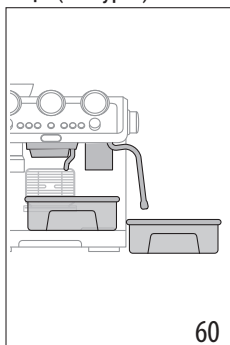
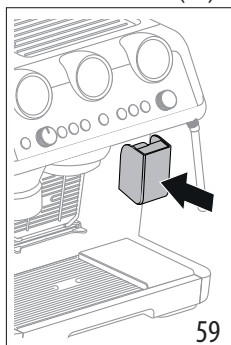

4. Сүзгі ұстағыштың (С1) бекітілмегеніне көз жеткізіп, кофе шүмегінің, ыстық су шүмегінің (А7) астына бос ыдыс қойыңыз, ал бу түтігінің (А5) астына басқа бос ыдысты қойыңыз (60-сурет).
5. Тиісті шам жыпылықтай бастағанша  $\text{||||}$  (В8) түймесін басып тұрыңыз: сонда қақ тазалау басталады.
6. Қақ тазалау бағдарламасы басталады және бу түтігінен және кофе шүмегінен қақ тазалағыш сұйық зат шығады. Қақ тазалау бағдарламасы құрылғының ішіндегі қақты тазалау үшін бірнеше шаю және кідіру әрекеттерін ыдыс босағанша орындайды.

Құйылу тоқтап,  $\text{||||}$  шамы ақ болып жанады. Бұл шаюдың қажеттігін көрсетеді: келесі бетті қараңыз.

7. Қақ тазартқыш ерітіндіні жинау үшін пайдаланылған ыдыстарды босатып, қайта қойыңыз.

8. Су ыдысын шығарып алып, қақ тазалағыш ерітіндінің қалдығын төгіңіз де, ағын су астында шайып, MAX деңгейіне дейін таза сумен толтырыңыз (61-сурет). Су ыдысын корпусқа қайта салыңыз.

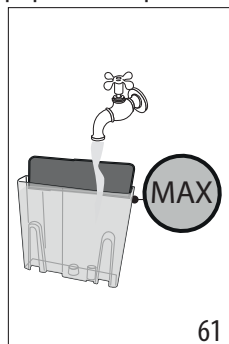

9. Тиісті шам жыпылықтай бастағанша  $\text{||||}$  түймесін басып тұрыңыз: сонда шаю басталады.
  10. Шаю аяқталған кезде, құйылу тоқтайды да, құрылғы қайта пайдалануға дайындалады.
  11. Шаятын суды жинау үшін қолданылатын ыдыстарды босатыңыз.
  12. Тамшы науасын шығарып алып, босатыңыз да, құрылғыға қайта салыңыз.
- Одан кейін құрылғы пайдалануға дайын болады.











#### Есіңізде болсын



- Қақ тазалау циклін бастағыңыз келсе,  $\text{||||}$  3 секунд басып тұрыңыз.
- Қақ тазалауды байқамай бастаған болсаңыз,  $\text{||||}$  түймесін 10 секунд басып тұрыңыз; шаю циклін тоқтату мүмкін емес.

## 12. ШАМДАРДЫҢ ТҮСІНДІРМЕСІ

ШАМДАР	ШАМДАРДЫҢ ТҮСІНДІРМЕСІ	ЖҰМЫС ТҮРІ
Барлық шамдар тез жыпылықтайды	Құрылғы іске қосылуда	Өзін-өзі тексеруде
 жанады	Құрылғы бірінші рет іске қосылуда және су айналу жолдары толтырылуы керек	Келесі бөлімде сипатталғандай жалғастырыңыз: "3. Құрылғы параметрлерін орнату"
 жанады	Қуат үнемдеу функциясы іске қосылған	Бұл функцияны ажыратқыңыз келсе, "7. Мәзір параметрлері" бөлімін қараңыз
 жанады	Дән ыдысы (A1) бос	Дән ыдысын толтырыңыз
 жыпылықтайды	Кофені тарту талап етілуде, бірақ дән ыдысы (A1) бос	Дән ыдысын толтырыңыз
 жанады	Ыдыстағы (A15) су жеткіліксіз немесе ыдыс дұрыс енгізілмеген	Ыдысты толтырыңыз немесе оны шығарып алып, орнына қайтадан дұрыстап салыңыз
 жыпылықтайды	Кофені қайнату талап етілуде, бірақ су ыдысы (A15) бос	Су ыдысын толтыру
 жанады	Жалпы дабыл	Тұтынушыларды қолдау қызметтерімен хабарласыңыз
 жанады	Дән ыдысы салынбаған	Дән ыдысын (A1) құрылғыға дұрыстап салыңыз немесе оның дұрыс салынғанын тексеріңіз
 жыпылықтайды	Ыдыстың түбіндегі таңдағыш дұрыс ораластырылмаған.	Таңдағышты ұсақтан іріге дейінгі 8 деңгей бойымен жылжытыңыз: <ul style="list-style-type: none"> <li>• Кофені тарту кезінде кофе тартқышты әрқашан реттеңіз</li> <li>• Бір мезетте кофені тарту деңгейін реттеңіз және тағы да реттемес бұрын кемінде 5 кофе жасаңыз</li> </ul>
	Кофе дәні ыдысы (A1) толық енгізілмеген: құрылғы қауіпсіздікті сақтау мақсатында жұмыс істемейді	Дән ыдысы орнына толық кигізілгенін тексеріңіз

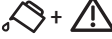

ШАМДАР	ШАМДАРДЫҢ ТҮСІНДІРМЕСІ	ЖҰМЫС ТҮРІ
 жанады	LatteCrema жүйесі әрбір қолданудан кейін тазалануы керек	Барлық сүт сусындары дайын болған кезде, тетікті (D5) Clean (Тазалау) күйіне бұрау арқылы автоматты тазалауды орындаңыз
 жанады	Құрылғы іске қосылды және пайдалануға дайын	Құрылғы бу шығаруға болатын ең қолайлы температураға жетті. Бу шығару үшін, бу дөңгелегін бұраңыз (A4)
 жыпылықтайды	Құрылғы қосулы және қуат үнемдеу функциясы іске қосылды. Бу дөңгелегі (A4) бу шығару күйінде	Құрылғы бу шығаруға дайындалып жатқанын көрсету үшін шам жыпылықтайды. Құрылғы тиісті температураға жеткен кезде құйылу басталады
	Құрылғы пайдалануға дайын болу үшін қызууда	Құрылғы шам тұрақты жанған кезде керекті температурада болады
	Құрылғы бу шығаруда	
 жанады (қызыл-сары)	Қақ тазалау орындалуы тиіс	Құрылғының қағын келесі бөлімінде сипатталғандай етіп тазалаңыз: "11. Қақ тазалау"
 жыпылықтайды (қызыл-сары)	Қақ тазалау орындалуда	Процедураны "11. Қақ тазалау" бөлімінде сипатталғандай етіп орындаңыз
 жанады (ақ)	Қақ тазалаудың шаю циклі орындалуы тиіс	
 жыпылықтайды (ақ)	Қақ тазалаудың шаю циклі орындалуда	
 жанады (қызыл-сары)	Кофе шүмегін тазалау жұмысы орындалуы тиіс	"8.1 Кофе шүмегін тазалау" бөлімін қараңыз
	 жыпылықтайды (қызыл-сары)	
 жыпылықтайды (ақ)	Белсенді шаю орындалуда	
→		

ШАМДАР	ШАМДАРДЫҢ ТҮСІНДІРМЕСІ	ЖҰМЫС ТҮРІ
 жыпылықтайды	Егер су жұмсартқыш сүзгі болса, түтіктерден ауа көбігі шығып, құюға кедергі жасауы мүмкін	Түймені (B7) басыңыз (  шамының). Құйылу автоматты түрде басталып, тоқтайды.
	Тартылған кофе тым майда және кофе өте жай құйылуда немесе мүлдем құйылмауда	Сүзгі ұстағышты (C1) шығарыңыз ("4.1 1-қадам - кофе тарту (11-сурет)" және "4.3 2-қадам - тығыздау (17-сурет)" бөлімдерін қараңыз)
	Құрылғыдағы (C2) немесе (C3) кофе сүзгісі бітеліп қалған	Сүзгілерді мол ағын сумен немесе Active Rinse (Белсенді шаю) функциясымен шайыңыз (B5).
	Ыдыс (A15) дұрыс салынбаған және астыңғы клапандар ашық емес	Астыңғы клапандарды ашу үшін ыдысты жайлап басыңыз
	Су айналу жүйесіне қақ жиналған	Бөлімде сипатталғандай етіп қақтан тазалаңыз "11. Қақ тазалау"

### 13. АҚАУЛЫҚТАРДЫ ЖОЮ

ПРОБЛЕМА	СЕБЕБІ	ШЕШІМІ
Тамшы науасында су бар (A11)	Бұл – ішкі су айналым жолдарында туындайтын қалыпты жағдай	Тамшы науасын тұрақты түрде босатыңыз және тазалаңыз
		→

ПРОБЛЕМА	СЕБЕБІ	ШЕШІМІ
Эспрессо кофесі құйылмайды	Ыдыста су жоқ (A15)	Су ыдысын толтырыңыз
	☞ Шамы (B7) кофе немесе бу айналымы бос екенін көрсету үшін жанады	Жүйені толтыру үшін ☞ шамымен байланысқан түймені басыңыз
	Құрылғыдағы (C2) немесе (C3) кофе сүзгісі бітеліп қалған	Сүзгілерді мол ағын сумен немесе Active Rinse (Белсенді шаю) функциясымен шайыңыз (B5)
	Ыдыс (A15) дұрыс салынбаған және астыңғы клапандар ашық емес	Астыңғы клапандарды ашу үшін ыдысты жайлап басыңыз
	Су айналу жүйесіне қақ жиналған	Бөлімде сипатталғандай етіп қақтан тазалаңыз"11. Қақ тазалау"
	Кофе ұнтағы тым ұсақ	Сүзгі ұстағышын шығарыңыз (C1) және тартуды жаңа параметрлермен қайталаңыз ("4.1 1-қадам - кофе тарту (11-сурет)" және "4.3 2-қадам - тығыздау (17-сурет)" бөлімдерін қараңыз)
Сүзгі ұстағыш құрылғыға бекітілмейді	Тартылған кофе тығыздалмаған немесе тым көп	Сүзгі ұстағышын шығарыңыз (C1) және тартуды жаңа параметрлермен қайталаңыз ("4.1 1-қадам - кофе тарту (11-сурет)" және "4.3 2-қадам - тығыздау (17-сурет)" бөлімдерін қараңыз)
Эспрессо кофесі тесіктердің орнына сүзгі ұстағыштың жиектерінен тамшылайды	Сүзгі ұстағыш дұрыс салынбаған	Сүзгі ұстағышты дұрыс бекітіңіз және жеткен жеріне дейін мықтап бұраңыз
	Эспрессо қайнатқыш бөлігінің толтырмасының созылмалы қасиеті жоғалған немесе ол кірлеген	Эспрессо қайнату бөлігінің тығыздағышын т ұ т ы н у ш ы л а р ғ а қызмет көрсету орнына ауыстыртыңыз
	Құрылғыдағы (C2) немесе (C3) кофе сүзгісі бітелген	Сүзгілерді мол ағын сумен немесе Active Rinse (Белсенді шаю) функциясымен шайыңыз (B5)
→		

ПРОБЛЕМА	СЕБЕБИ	ШЕШІМІ
Кофе кілегейі тым сұйық (шүмектен тым тез ағады)	Құрылғы параметрлерін тексеру қажет	Сүзгі ұстағышын шығарыңыз (C1) және тартуды жаңа параметрлермен қайталаңыз ("4.1 1-қадам - кофе тарту (11-сурет)" және "4.3 2-қадам - тығыздау (17-сурет)" бөлімдерін қараңыз)
Кофе кілегейі тым қоңыр (ол шүмектен тым жай ағады)	Құрылғы параметрлерін тексеру қажет	Сүзгі ұстағышын шығарыңыз (C1) және тартуды жаңа параметрлермен қайталаңыз ("4.1 1-қадам - кофе тарту (11-сурет)" және "4.3 2-қадам - тығыздау (17-сурет)" бөлімдерін қараңыз)
Каппучиноны LatteCrema жүйесімен жасау барысында сүт көпіршігі жасалмайды	Сүт онша салқын емес	Сүтті әрқашан тоңазытқыш т е м п е р а т у р а с ы н д а пайдаланыңыз
	Көбік таңдау дөңгелегі (D5) дұрыс күйде емес	Оны тексеріңіз және көбік таңдау тетігін дұрыс күйге бұраңыз (☺ макс. көбік; ☹ орта көбік; ☹ мин. көбік)
	LatteCrema жүйесі кірлеген	Каппучино жасағышты келесі бөлімде сипатталғандай етіп тазалаңыз "8.6 Lattecrema жүйесін тазалау"
	Су айналу жүйесіне қақ жиналған	Бөлімде сипатталғандай етіп қақтан тазалаңыз "11. Қақ тазалау"
Қақ тазалау соңында құрылғы тағы бір шаюды талап етеді	Шаю циклі барысында су ыдысы MAX деңгейіне дейін толтырылмаған	Шаю процедурасын қайталаңыз ("11. Қақ тазалау" бөлімін қараңыз)
		→

ПРОБЛЕМА	СЕБЕБІ	ШЕШІМІ
Құрылғы кофені тартпайды	Кофе тартқышта ұсақталмайтын қатты бөгде зат бар	Қашаутістерді "8.3 Қашаутістерді тазалау" бөлімінде түсіндірілгендей тазалап, дән ыдысын (A2) оны шығарып алмас бұрын оның ішіндегі дәндердің барлығын алып тастаңыз. Қашаутісті орнына салмас бұрын, барлық қалдықтарды корпуста шаңсорғышпен алып тастаңыз
	Дәні ыдысы (A1) дұрыс орналастырылмаған	Ыдыс дұрыс жабылуы үшін ▲ көрсеткісі  белгісімен туралануы және "сырт" еткен дыбыс шығуы керек.
Егер кофе түрін өзгерткіңіз келсе	Құрылғыда бар барлық дәндерді алып тастауыңыз керек	<ul style="list-style-type: none"> <li>• Дән ыдысын (A1) босатыңыз (қажет болса, кофе тартқышты дәнсіз іске қосыңыз немесе дән қалдықтарын алып тастау үшін шаңсорғышты пайдаланыңыз)</li> <li>• Кофе тартқышты босату үшін сүзгі ұстағышты (C1) бекітіп, кофе тартқышты дән салынбаған күйінде бірнеше рет іске қосыңыз. Сүзгі ұстағышты кофе тартқыштың шүмегіне (A18) "INSERT" жазуына туралау арқылы бекітіп, оңға қарай бұрап қатайтыңыз (22-сурет). Кофені тарту сүзгі ұстатқыш CLOSE деңгейіне жеткен кезде басталып, автоматты түрде тоқтайды. Осы әрекетті сүзгі босағанша қайталаңыз</li> <li>• Дән ыдысына жаңа кофе салыңыз (A1)</li> <li>• Егер тартылған кофе мөлшері мінсіз мөлшерге қол жеткізу үшін жеткіліксіз болса, құрылғыны алғаш қолданған кездегідей параметрге орнатыңыз</li> </ul>
→		

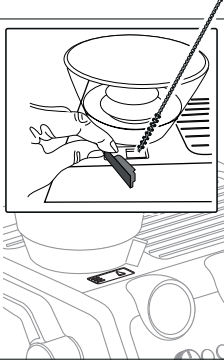

ПРОБЛЕМА	СЕБЕБИ	ШЕШІМІ
<p>Кофені тартқан соң, (C2) немесе (C3) кофе сүзгісі босайды</p> <p>Кофені тығыздаған соң, сүзгіде тым көп кофе қалады</p>	<p>Кофе тартқыштың кофе воронкасы бітеліп қалған</p>	<p>“8.5 “Ақылды тығыздау станциясын” тазалау” бөлімде сипатталғандай етіп тазалаңыз. Егер проблема жойылмаса, бағыттауыш орналасқан бөліктің қақпағын (A19) ашып, щетканы пайдаланып босатыңыз.</p> 
<p>Кофені тартқан соң, (C2) немесе (C3) сүзгісі ішіндегі тартылған кофе “мінсіз мөлшерге” жетпейді</p>	<p>“Ақылды тығыздау станциясы” тазалануы керек</p> <p>Тартылған кофе мөлшері реттелуі қажет</p> <p>Уақыт өте келе қашауістер тозады</p>	<p>“8.5 “Ақылды тығыздау станциясын” тазалау” Бөлімінде сипатталғандай тазалап, кофені тағы тартыңыз</p> <p>Кофе мөлшерін дөңгелекпен (B2) “Дәл мөлшер” бөліміне сүйене отырып реттеңіз. Дөңгелек онсыз да макс. Деңгейде тұрса, екінші ауқымдағы тарту параметрін таңдап, “7. Мәзір параметрлері” бөлімінде көрсетілген нұсқауды орындаңыз.</p> <p>Сондай кезде қашауістерді келесі бөлімде түсіндірілгендей етіп ауыстырыңыз: “8.4 Қашауістерді ауыстыру”</p>

A készülék használata előtt mindig el kell olvasni a biztonságos használatra vonatkozó figyelmeztetéseket tartalmazó füzetet.

## 1. LEÍRÁS

### 1.1 A készülék leírása - A

- A1. Szemes kávé tartó
- A2. Szemes kávé tartó fedele
- A3. Csészetartó
- A4. Gőz szabályozógomb
- A5. Gőz adagoló cső
- A6. Lattecrema System csatlakozó
- A7. Kávé adagoló
- A8. Csészetartó rács espresso kávéhoz
- A9. Csészetartó rács pohárhoz vagy mug csészéhez
- A10. Cseptálcá rács
- A11. Csepegtető tálca
- A12. A cseptálcában lévő víz szintjét mutató piros úszó
- A13. Víz tartály fedél
- A14. Víz tartály kiemelő fogantyú
- A15. Víz tartály
- A16. Tápvezeték csatlakozó
- A17. Főkapcsoló (ON/OFF)
- A18. Kávédaráló kimenet (Tamping station)
- A19. Fedél a kávédaráló csúszdájához
- A20. Kávétömörítő kar

### 1.2 Kezelőfelület leírása - B

- B1. ON/Standby gomb
- B2. Őrölt kávé mennyiségét szabályozó gomb
- B3. „X2” gomb: a 2 kávé szűrő használatához
- B4. „Kávé hőmérséklete” gomb
- B5. „Öblítés” gomb
- B6. „OK” gomb: az ital adagolásához/jóváhagyáshoz
- B7. „Forró víz adagoló” gomb
- B8. „Vízkezdés” gomb
- B9. „My” gomb: az italok hosszúságának egyéni ízlés szerinti beállítása
- B10. Funkcióválasztó gomb
- B11. Italok kijelzője:

#### Espresso kávé alapú italok

- Espresso
- Americano
- Kávé

#### Tej alapú italok

- Cappuccino
  - Flat White
  - Latte Macchiato
- B12. „Tej tisztítás” jelzőfény
  - B13. „Nincs szemes kávé tartó” jelzőfény
  - B14. „Általános riasztás” jelzőfény

- B15. Manométer
- B16. „Nincs víz” jelzőfény
- B17. „Szemes kávé tartó üres” jelzőfény
- B18. „Energiatakarékosság” jelzőfény
- B19. Beállítások és folyamat kijelző:
  - Jelzi a műveletet, amelyet a készülék éppen végez
  - Jelzi a kiválasztott kávé adag beállítását
  - Jelzi a kiválasztott kávé adag hőmérsékletét

### 1.3 A tartozékok leírása - C

- C1. Szűrőrtató egység
- C2. 1 csésze szűrő
- C3. 2 csésze szűrő
- C4. Vízkeménység mérő csik "Total Hardness Test"
- C5. Vízköoldószer
- C6. Tartozék vízköoldáshoz
- C7. Eltávolítható tápkábel
- C8. Tisztító feje
- C9. Kávédagoló tisztító tartozék
- C10. Tisztító kendő
- C11. Softballs (vízlágyító)
- C12. Tisztító tű a gőz fúvókához

### 1.4 A szállítás a tisztító tartozékokat nem tartalmazza, de a gyártó által ajánlottak

További információért látogasson el a [Delonghi.com](http://Delonghi.com) weboldalra.



#### Tisztító tabletták

(Lásd „8.1 A kávédagoló tisztítása”)



#### Tisztító

EAN: 8004399333307

### 1.5 A LatteCrema System leírása - D

- D1. Tejtartó fedele
- D2. Tejtartó csatlakozója
- D3. A fedél kioldó gombja
- D4. Tejadagoló (állítható magasságú)
- D5. Hab szabályozógomb
- D6. Szabályozógomb helye
- D7. Tejfelszívó cső
- D8. Tejtartály

## 2. A KÉSZÜLÉK ELŐKÉSZÍTÉSE

Langyos vízzel és konyhai mosogatószerrel mossa el az összes tartozékot, majd az alábbiak szerint járjon el:

1. Helyezze be a cseptálcát (A11) és a csészetartó rácsot (A9), valamint a cseptálcá rácsot (A10) (1 ábr.);

2. Vegye ki a víztartályt (A15) (2. ábr.) és töltsze fel friss, tiszta vízzel, ügyeljen arra, hogy a víz ne lépje túl a MAX jelzést (3. ábr.).
3. Majd helyezze be a tartályt.

**Figyelem:** *Soha ne indítsa be a készüléket, ha a tartályban nincs víz vagy a tartály nincs a helyén.*

**Megjegyzés:** *Tanácsos minél előbb beállítani a víz keménységét az egyéni igényeknek megfelelően a kézikönyv „7. Beállítások menü” fejezetében leírt eljárást követve.*

### 3. A KÉSZÜLÉK ELSŐ BEINDÍTÁSA

1. Illessze a tápkábel csatlakozóját (C7) a készülék hátulján kialakított helyre (A16) (4. ábr.); majd illessze a villásdugót a csatlakozó aljzatba. Győződjön meg arról, hogy a készülék hátulján lévő főkapcsoló (A17) I állásban van lenyomva (5. ábr.);
2. Helyezzen a forró víz adagoló alá (a kávéadagolóval egyvonalban (A7)) egy legalább 100 ml őrletartalmú edényt (6. ábr.);
3. Nyomja meg a gombot (B7) a jelzőfényrel egy magasságban (6. ábr.) (7. ábr.): kezdetét veszi az adagolás és automatikusan félbeszakad. Ürítse ki a tartót.

A gép használata előtt át kell öblíteni a gép belső hidr. köreit. Az alábbiak szerint járjon el:

4. Akassza a szűrőtartó egységet (C1) a gépre: a helyes akasztáshoz állítsa egy vonalba a szűrőtartó egység karját az „INSERT” szimbólummal (8. ábr.) és forgassa a nyelet jobbra, amíg egy vonalba nem kerül el a „CLOSE” pozícióval;
5. Helyezzen egy edényt a szűrőtartó egység és a gőz adagoló cső alá (A5);
6. Nyomja meg a jelzőfényrel egy magasságban lévő gombot (B5) (9. ábr.): megkezdődik az adagolás;
7. Az adagolás végén forgassa el a gőz szabályozógombot (A4) (10. ábr.) és engedjen ki gőzt pár másodpercig a gőz kór tisztítása érdekében: a gőz megfelelő kiengedéséhez javasoljuk, hogy ismétlje meg ezt a műveletet 3 vagy 4 alkalommal. Ez lehetővé teszi a víz eltávolítását a csőből, mielőtt kiengedné a gőzt.

A készülék készen áll a használatra.

**Megjegyzés:** *A belső körök öblítését a készülék hosszabb leállása után is ajánlott elvégezni.*

Első használatkor 4-5 kávét kell lefőzni, mielőtt a készülék kielégitő eredményt produkálna: különösen figyeljen a szűrőbe tett őrölt kávé adagra ((C2) vagy (C3)) (lásd a „4.1 1. fázis - őrlés (grinding) (11. ábr.)” bekezdésben foglalt utasításokat). A „A „tökéletes adag” fejezetben leírtak szerint járjon el.

## 4. KÁVÉKÉSZÍTÉS

### 4.1 1. fázis - őrlés (grinding) (11. ábr.)

1. Öntse a kávészemeket a tartóba (A1) (12. ábr.). Javasoljuk, hogy mindig csak az elkészítéshez szükséges kávészem-mennyiséget öntse be: így mindig friss kávét használ;

2. Válassza ki az őrlés finomságát (13. ábr.). A gyári beállítás az 5 (közepes finomságú őrlés). Ha az eredmény nem kielégítő, állítsa be a szintet az egyéni ízlésnek és a kávé típusának megfelelően (a beállítást a kávévédaráló működése közben kell elvégezni).
3. Helyezze be az egyik kávészűrőt (C2) vagy (C3) a szűrőtartóba (C1) (14. ábr.). Ha a 2 csészéhez való szűrőt használja, nyomja meg a 2X gombot (B3): ezzel a választással megkettőzi az adagolt espresso mennyiségét is.
4. Forgassa el a mennyiség beállító gombot (B2) a minimum helyzetéről indulva (15. ábr.).

#### Megjegyzés:



A kijelzőn megjelenő számok (B19) feljegyzendő hivatkozások, ha elérte a megfelelő szintet a szűrőtartóban. Nem jelzik az őrlés beállításait, az őrölt kávé súlyját (gr/oz) vagy az őrlés időtartamát.

További információért lásd a „B3. „2X” gomb: a 2 kávé szűrő használatához” bekezdést.

5. Akassza a szűrőtartót a kávévédaráló (A18) kimenetére, egy vonalba állítva az INSERT felirattal: majd forgassa a kart jobbra (16. ábr.). Az őrlés akkor veszi kezdetét, amikor a kar eléri a CLOSE pozíciót és automatikusan félbeszakad.

#### szabályozza a szűrőben lévő őrölt kávé mennyiségét

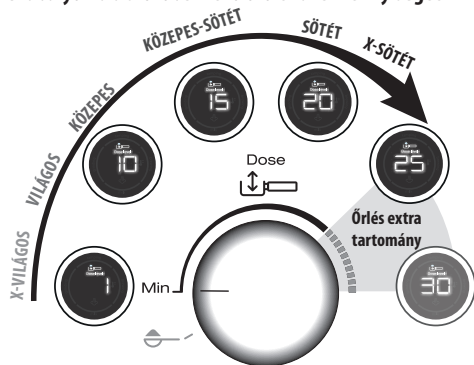

Minden kávészem fajta más-más eredményt ad az őrlés során, ezért különös gonddal kell eljárni az adag első beállításakor. Ez a magyarázat utasításokat ad arra vonatkozóan, hogy hogyan állítsa be az adagot a pörkölés színe alapján: ezt kiindulási pontként kell kezelni, amely változhat a kávészemek összetétele alapján.

1. A minimum pozíciótól kell beállítani az adagot.
2. A kávé pörkölési színének alapján forgassa lassan a gombot.

## 4.2 2. fázis - Tömörítés (tamping) (17. ábr.)

1. Az őrlés után engedje le a tömörítő kart (A20) a végállásig (ne vegye ki a szűrőtartót) (18. ábr.). A tökéletes eredményért ismételje meg 2-szer.
2. Tartsa lent a kart végállásban a szűrőtartó eltávolítása során (19. ábr.). Ezután helyezze vissza a kart az eredeti helyzetébe.
3. Miután ellenőrizte, hogy a kávé adag megfelelő (lásd „A tökéletes adag”), csatlakoztassa a szűrőtartót a kávéadagolóra (A7) (20. ábr.).

### A „tökéletes adag”

- A kávészűrők egy belső jellel rendelkeznek a tökéletes adag jelöléséhez.



- Lézer jelöléssel rendelkező szűrők: a tökéletes adag a jelölés felső vonalának felel meg;
- Domború jelöléssel rendelkező szűrők: a tökéletes adag a jelölés kidomborodó vonalának felel meg;
- Győződjön meg arról, hogy a kávé a tömörítés után egy szintben van. Lehetséges, hogy többször kell beállítani a gombot (B2), mielőtt eléri a tökéletes adagot.
- Ha a kávé túl- vagy alul kivont, és az adag a tökéletes adagombelül van, állítsa finomabbra vagy durvábbra az őrlés mértékét (lásd „4.1 1. fázis - Őrlés (grinding) (11. ábr.)”). Ha a kávé túlzottan kivont (az adagolás túl lassú), az őrlésnek durvábbnak kell lennie. Ha a kávé kevésbé kivont (az adagolás túl gyors), az őrlésnek finomabbnak kell lennie.
- **A barista javaslata:** Akkor húzza ki a szűrőtartót, amikor a tömörítő kar (A20) le van engedve, hogy a kávé adagja tökéletes legyen.

## 4.3 3. fázis - Adagolás (brewing) (21. ábr.)

1. Válassza ki a kívánt italt (22. ábr.).
2. Nyomja meg az OK gombot (B6) az adagolás megkezdéséhez (23. ábra) (előinfúzió és infúzió). A kávé adagolása automatikusan leáll.

## 5. TEJ ALAPÚ ITALOK KÉSZÍTÉSE

### 5.1 A tej habosítása (24. ábr.)

1. Öntse a melegítendő/habosítandó tej mennyiségét a tej-tartályba (D8), figyelembe véve azt, hogy a tej térfogata 2-3-szorosa ná (25. ábr.). Sűrűbb és homogénebb tejhab készítéséhez tanácsos zsíros, hűtőszekrény-hőmérsékletű tehenéj (kb. 5 °C) használni.

## My Latte Art

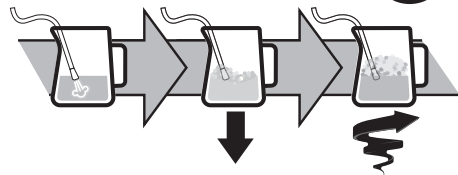

2. A tej habosításához helyezze a gőz adagoló csövet (A5) a tej felületére: ennek során a levegő összekeveredik a tejjel és a gőzzel.
3. Tartsa a gőzfúvókát a felületen, ügyelve arra, hogy ne fogjon egyszerre túl sok levegőt, amely túl nagy buborékokat képez.
4. Merítse a gőz adagolót a tej felszín alá: ezzel örvényt hoz létre. A kívánt hőmérséklet elérése után zárja el a gőz szabályozó gombot és várja meg, amíg a gőz adagolás teljesen leáll, mielőtt kivenné a tejkancsot.

### A barista javaslata:

- **A friss tej a legjobb.** Mindig friss, hűtőszekrény-hőmérsékletű tejet használjon.
- A zsíros tej kiváló eredményeket biztosít. Az eredmény és a hab textúrája a felhasznált tehéntejtől vagy növényi italoktól függően változik.
- A tej habosítása után a tejkancsot rázza távolítsa el a buborékokat.

### A gőz adagoló tisztítása:

1. Minden használat után ruhával távolítsa el a tejaradványokat a gőz adagolóból (26. ábr.). Az alapos tisztításhoz tanácsos az Eco MultiClean-t használni: a tejfehérjék és tejszírok eltávolításával biztosítja a higiéniát, és az egész gép tisztítására használható.
2. Engedjen pár másodpercig gőzt az adagoló megfelelő tisztításához (10. ábr.).
3. Várja meg, amíg az adagoló lehűl: az adagoló hatékonyságának fenntartásához használja a tisztító tüt (C12) a 3 lyuk tisztán tartásához (27. ábr.).

### 5.2 Tejalapú italok készítése a LatteCrema System-mel (28. ábr.)

1. Öntse a tej-tartályba (D8) a hűtőszekrény hőmérsékletű (5 °C) tejet (29. ábr.).
2. Csuksa le a fedelet (D1) (30. ábr.).
3. Forgassa a tejhab szabályozógombot (D5) a kívánt állásba (31. ábr.).

Hab szabályozógomb pozíciója				
CLEAN	MAX hab	MED hab	MIN hab	INSERT
Tisztítás minden egyes használat után				A gomb kivételéhez vagy behelyezéséhez

- Akassza rá a tejtartályt a gépre (32. ábr.).
- Készítse el a tökéletes adagot (lásd „4.1 1. fázis - Őrlés (grinding) (11. ábr.)” és „4.2 2. fázis - Tömörítés (tamping) (17. ábr.)”) és helyezze be a szűrőtartót.
- Válassza ki a kívánt tejalapú italt (33. ábr.).

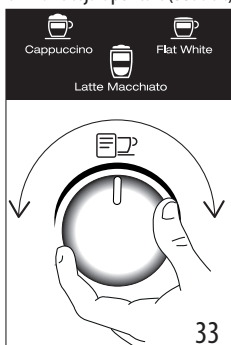

Ital	Espresso	Tej	Hab	Mennyiség (ml)	X2 (ml)
Cappuccino	1	✓	✓	≈150	≈230
Latte Macchiato	1	✓	✗	≈150	≈230
Flat White	1	✓	✓	≈250	≈330

- Dupla adag italok (2x):** Őntse az elkészítéshez szükséges tejmennyiséget a tartályba (D8), ügyelve arra, hogy ne lépje túl a MAX szintet (25. ábr.). A tartályon található minden jel ≈100 ml tejnek felel meg.
  - A friss tej a legjobb.** Mindig friss, hűtőszekrény-hőmérsékletű tejet használjon.
- Nyomja meg az OK gombot (B6) az adagoláshoz (23. ábr.). A készülék automatikusan egymás után adagolja a kávé és a tejet.

#### A Lattecrema System tisztítása minden használat után:

- Hagyja a tejtartályt a géphez rögzítve (nem szükséges kiüríteni). Helyezzen egy edényt a tej adagoló cső (D4) alá (34. ábr.).

- Forgassa el a szabályozógombot (D5) a „Clean” állásba (35. ábr.).

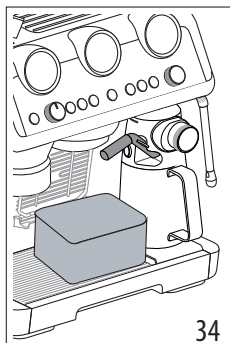

- A tisztítás automatikusan kezdődik el és végződik. Figyelem: a tisztítás végén forgassa a szabályozógombot az egyik tejhab szabályozó állásba.
  - Vegye ki a tejtartályt és tegye hűtőszekrénybe: javasoljuk, hogy a maradék tejet rövid időn belül használja fel.
- Az alapos tisztításhoz tanácsos az Eco MultiClean-t használni: a tejfehérjék és tejszírok eltávolításával biztosítja a higiéniát, és az egész gép tisztítására használható.







#### 6. EGYÉNI ÍZLÉS SZERINT ÁLLÍTSA BE A KÁVÉ ALAPÚ ITALOK HOSSZUSÁGÁT A (B9) GOMBBAL

- Készítse elő a gépet 1 vagy 2 csésze kávé alapú ital készítésére, akassza be a szűrőtartót (C1) a szűrővel (C2) vagy (C3) és darált kávéval. Ha tejalapú italt szeretne programozni, csatlakoztassa a Lattecrema System-et a géphez.
- Forgassa el a gombot (B10) a programozandó ital kiválasztásához.
- Nyomja meg a gombot : az OK gombnak megfelelő jelzőfény (B6) folyamatosan ég, és a gombnak megfelelő jelzőfény villog.
- Az adagolás megkezdéséhez nyomja meg az OK gombot. Az OK és a gomboknak megfelelő fények villognak.
- Miután elérte a kívánt mennyiséget, nyomja meg az OK gombot. Ha az ital más összetevő adagolását is igényli, akkor megkezdődik annak adagolása: ha elérte a kívánt mennyiséget, nyomja meg az OK gombot.
- Nyomja meg a gombot a mentéshez. A készülék készen áll az új használatra, és a jelzőfény folyamatosan világít. Ha nem akarja menteni a programozást, nyomjon meg egy bármely más gombot.









#### Megjegyzés:

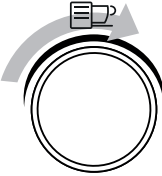











- A kávé alapú italokat lehet programozni, de a gőz és a forró víz adagolást nem.

- A programozás módosítja az italok mennyiségét, de az örölt kávéét nem.
- Az „X2” italok külön-külön is programozhatók.
- A **My LatteArt**  nem programozható.
- A **gyári beállításokhoz való visszatéréshez tartsa nyomva a  gombot egészen addig, amíg ki nem alszik. A kiválasztott ital visszaáll a gyári beállított mennyiségre.**

Kávé recept	Gyári mennyiség	Programozható mennyiség
 Espresso	35 ml	25-től 90 ml-ig
 Espresso X2	70 ml	50-től 180 ml-ig
 Coffee	80 ml	50-től 120 ml-ig
 Coffee X2	160 ml	120-től 240 ml-ig
 Americano	120 ml	• espresso: 25-től 60 ml-ig • víz: 25-től 120 ml-ig
 Americano X2	240 ml	• espresso: 50-től 120 ml-ig • víz: 50-től 240 ml-ig

## 7. BEÁLLÍTÁSOK MENÜ

1. Lépjön a menübe:		
Tartsa nyomva egyidejűleg 5 másodpercig	x2	
2. Válassza ki a programozandó beállítást:		
		
Ital	Megfelelő beállítás	Beállítások
 Espresso	Energiatakarékosság	 <b>Bekapcsolt</b>
		 <b>Kikapcsolt</b>
 Coffee	Automata kikapcsolás	 <b>9 perc</b>
		 <b>1,5 óra</b>
		 <b>3 óra</b>
→		

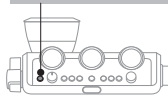
 Cappuccino	Akusztikus hangjelzés	 <b>Bekapcsolt</b>
		 <b>Kikapcsolt</b>
 Latte	A kávédaráló extra beállítása	 <b>Range 1</b>
		 <b>Range 2</b>
 Flat White	Gyári értékek	Legalább 5 másodpercig tartsa lenyomva az OK gombot, amíg a jelzőfény folyamatosan világít
 Americano	Vízkeménység	 <b>lágy</b>
		 <b>közepes</b>
		 <b>kemény/nagyon kemény</b>
3. Az ON/Standby (B1) megnyomásával mentse el az új beállításokat		
 		













## 8. A KÉSZÜLÉK TISZTÍTÁSA

### Figyelem!

- A készülék tisztításához ne használjon oldószereket, súrolószereket vagy alkoholt.
- A kávézacc vagy egyéb lerakódások eltávolításakor nem szabad fémtárgyakat használni, mert ezek megkarcolhatják a gép fém- vagy műanyag felületeit.
- Egy hétnél hosszabb állás esetén javasoljuk, hogy az újbóli használat előtt öblítse ki a gépet.

### Veszély!

- Tisztítás során soha ne merítse a készüléket vízbe: az egy elektromos berendezés.
- A készülék külső tisztításának megkezdése előtt kapcsolja ki a gépet, húzza ki a hálózati csatlakozót, és hagyja a készüléket kihűlni.



					
	×	✓	✓	×	×
	✓	×	×	✓	✓
	×	×	×	✓	✓
	×	×	×	✓	✓
	×	×	✓	✓	×
	×	×	×	✓	✓
	✓	✓	×	✓	✓

## 8.1 A kávéadagoló tisztítása

Amikor a  jelzőlámpa kigyullad (narancssárga) (B5), meg kell tisztítani a kávé kört. A tisztítási ciklus elvégzéséhez vásároljon a kávéfőzőkhöz való tisztító tablettákat. További információért látogasson el a [www.Delonghi.com](http://www.Delonghi.com) oldalra.

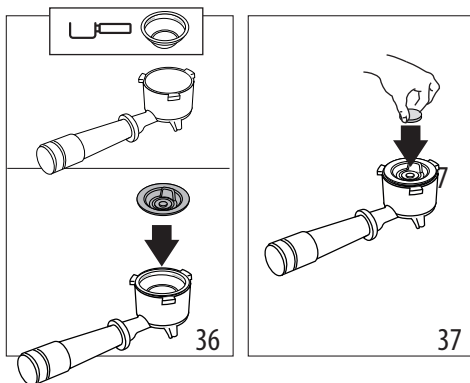
1. Helyezze az 1 csésze szűrőt (C2) a szűrőtartóba (C1) (36. ábr.).
2. Helyezze a tisztító tartozékok (C9) a szűrőbe (36. ábr.) és nyomja le teljesen.



3. Tegye a tisztító tablettát a tartozékra (37. ábr.).
4. Csatlakoztassa a szűrőtartót a kávéadagolóra (A7).
5. Töltse fel a víztartályt (A15). Ellenőrizze, hogy a cseptálcá (A11) üres-e.
6. Tartsa nyomva a  gombot, amíg a vonatkozó jelzőfény villogni nem kezd (narancssárga). Néhány perc múlva a tisztítás automatikusan leáll.
  - Távolítsa el a szűrőtartót és a tisztító tartozékokat.
  - Mossa el a szűrőtartót és a szűrőt folyó víz alatt.
  - Helyezze vissza a szűrőtartót, és folytassa az öblítéssel a  (B5) gomb megnyomásával: ajánlott egy edényt a szűrőtartó alá tenni.
  - Vegye ki és ürítse ki a cseptálcát.

### Megjegyzés:

Ez a tisztítási ciklus bármikor elindítható a  (B5) gomb néhány másodperces lenyomásával. A művelet megszakításához nyomja a gombot 10 másodpercig.

## 8.2 Tisztítsa meg a szemes kávé tartó házát

1. Ellenőrizze, hogy a szemes kávé tartó (A1) üres-e. Ha szükséges, végezzen néhány üres örlést annak kiürítéséhez.
2. Az óramutató járásával ellentétes irányba forgatva oldja ki a tartályt, és vegye ki a gépből (38. ábr.).

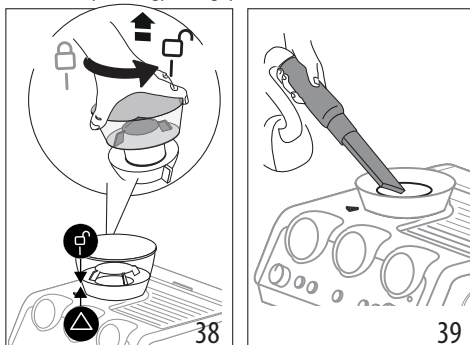

3. A kávé maradványokat szívja fel (39. ábr.).

4. Tisztítsa meg a szemes kávé tartó házát nedves ruhával és szárítsa meg (40. ábr.);

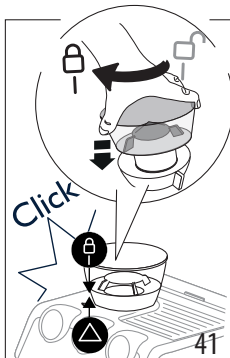
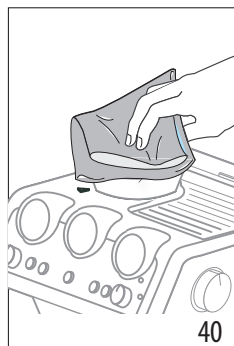

5. Tegye vissza a tartályt a kávédarálóba helyezve. A tartály megfelelően van behelyezve, ha a ▲ nyíl a  szimbólumhoz igazodik, és „kattanást” hall (41. ábr.).

### 8.3 A darálók tisztítása

A szemes kávé tartó (A1) tisztításakor nedves ruhával tisztítsa meg a tartály fészket és a felső darálót. A darálók eltávolításához és cseréjéhez forduljon szervizközpontozhoz.

A daráló eltávolítható, ha a kávédarálót idegen test blokkolja. Ha ez megtörténik, vegye ki a szemes kávé tartót és az alábbiak szerint járjon el:

1. Helyezze vissza a szűrőtartó egységet (C1) és örljön egyet „üresen” a kávécsatorna felszabadításához.
2. Kapcsolja ki a készüléket.
3. Forgassa az órés szabályozóját az óramutató járásával ellenforogó irányba ütközésig, „REMOVE” pozícióba (42. ábr.).

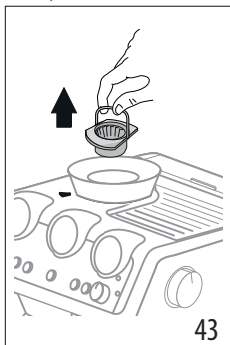
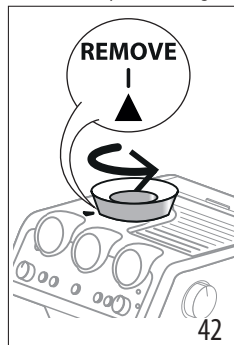

4. Az erre a célra szolgáló fogantyú megfogásával húzza ki a daráló felső részét (43. ábr.).
5. Tisztítsa meg a darálót egy ecsettel (44. ábr.) és szívja el a kávémaradványokat egy porszívóval (39. ábr.).

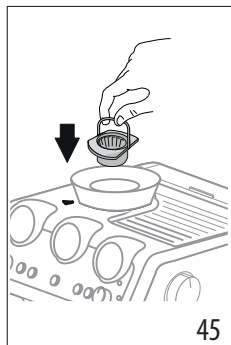
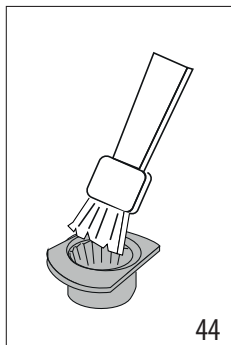

6. Helyezze a darálót a helyére (45. ábr.);
7. Forgassa el a szabályozót, a kívánt órési fok kiválasztásával (13. ábr.);

Ellenőrizze, hogy a daráló megfelelően van-e behelyezve, a fogantyúnál fogva húzza: a daráló megfelelően van behelyezve, ha nem mozog;

### 8.4 Darálók cseréje

Ha az őrlött kávé mennyisége tovább csökken, lépjen kapcsolatba a szervizközponttal a darálók cseréjéhez: majd állítsa be újra a darálót a beállítások menübe („7. Beállítások menü”) lépve és az extra órésbeállítás első tartományának kiválasztásával. Ezután fordítsa a mennyiség beállító gombot (B2) MIN állásba, és állítsa be az adagot az első használathoz hasonlóan (lásd „A, tökéletes adag”).

### 8.5 A „Smart tamping station” tisztítása

1. Tisztítsa meg a csatlakozási területet egy ecsettel (46. ábr.).
2. Húzza meg a kart (A20) a végállásig és tisztítsa meg egy ecsettel a tömörítőt (47. ábr.), majd engedje el a kart.
3. Egy kefével (C8) tisztítsa meg a kávé csúszdát (48. ábr.).

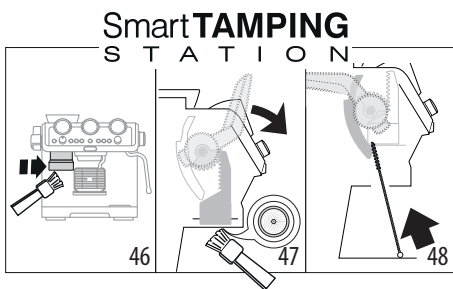

### 8.6 A LatteCrema System tisztítása

Mossa el a mosogatógépben az összes alkatrészt és a tartályt úgy, hogy a mosogatógép felső kosarába teszi őket. Ha nem rendelkezik mosogatógéppel, mossa el őket kézzel a bekezdés végén található megjegyzésben leírtak szerint.



1. Nyomja meg a gombot (D3) és emelje fel a tejtartály fedelét (D1);
2. Húzza ki a tej adagolót (D4) és a tejfelszívó csövet ((D7) (49. ábr.);

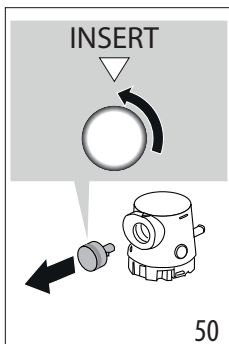
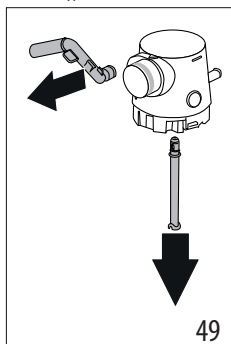

3. Forgassa a gombot az „Insert” állásba és húzza ki (50. ábr.);
4. Különösen ügyeljen arra, hogy a szabályozógomb alatti csatornában és nyílásban (51. ábr.) ne maradjon tej: szükség esetén egy fogpiszkálóval kaparja ki;

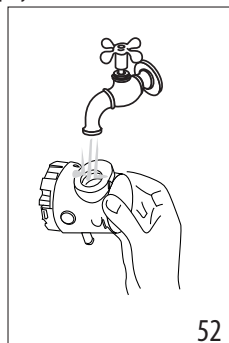
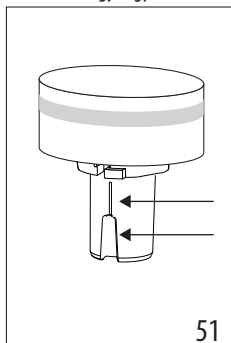

5. Mossa el folyó vízzel a hab szabályozógomb foglalatának belsejét (52. ábr.);
6. Ellenőrizze azt is, hogy a tejfelszívó csőben és a tejadagoló csőben nincsenek tejmaradványok;
7. Szerelje vissza a fedél minden alkatrészét;
8. Mossa el és öblítse el alaposan a tejtartályt (D8) ;
9. Akassza vissza a fedelet a tejtartályra.

### Megjegyzés: kézi mosás

A mosogatógépben történő mosás tökéletes higiéniát garantál a tejtartály minden alkatrészének: kézi mosás esetén mossa el alaposan a tejtartály minden részét forró vízzel, majd áztassa be őket egy lavór forró vízbe körülbelül 30 percig, mielőtt folytatná az 4. pontban leírtak szerint.

## 9. VÍZKEMÉNYSÉG

A [B8] (B8) vízköoldás jelzőfény egy, a víz keménységétől függő, előre beállított időtartam után felgyullad. A készüléket beállít-

hatja a terület vízvezeték hálózatát jellemző valós vízkeménységre, így a készülék ritkábban végez vízköoldást.

1. Vegye ki a csomagolásból a készletben lévő vízkeménység mérő csíkot "TOTAL HARDNESS TEST" (C4).
2. Körülbelül egy másodpercre merítse a csíkot egy pohár vízbe.
3. Vegye ki a csíkot a vízből és enyhén rázza meg. A „7. Beállítások menü” fejezet szerint állítsa be a készüléket.

A vízkeménységi eredménye	teszt	Gomb	Szint
	x 2		1 lágy víz
			2 közepes víz
			3 kemény vagy nagyon kemény víz

4. A „7. Beállítások menü” fejezet szerint állítsa be a készüléket.

## 10. A SOFTBALLS HASZNÁLATA

A Softballs (C11) egy innovatív rendszer, amely meghosszabbítja a gép élettartamát anélkül, hogy megváltoztatná a víz minőségét, és így krémes és aromás kávét biztosít. Hatékonyságuk optimalizálása érdekében hagyja a Softballs-okat egész éjjel vízben ázni, mielőtt felhasználná őket.

1. Vegye ki a Softballs csomagot a csomagolásból (53. ábr.).

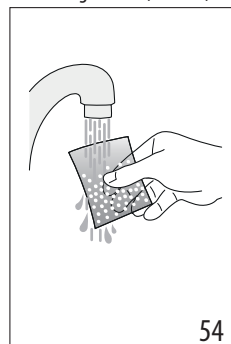
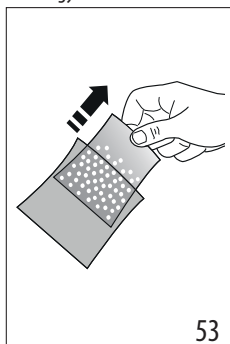

2. Öblítse le folyó víz alatt a Softballs csomagot (54. ábr.).
3. Merítse a csomagot a víztartályba (A15) (55. ábr.).

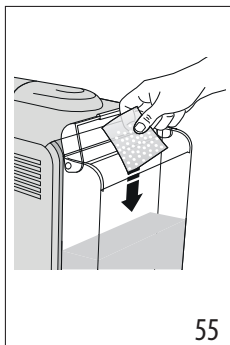

4. 3 havonta cserélje ki a Softballs csomagot (56. ábr.).

## 11. VÍZKŐOLDÁS

### Figyelem!

- Használat előtt olvassa el a vízkőoldószer csomagolásán található utasításokat és a címkét (C5).
- Kizárólag De'Longhi vízkőoldó használatát javasoljuk. Nem megfelelő vízkőoldó használata, valamint a nem szabályosan végzett vízkőoldás olyan károkat okozhat, melyek javítása nem tartozik a gyártó által vállalt garancia körébe.
- A vízkőoldó károsíthatja a kényes felületeket. Ha a termék véletlenül kiömlik, azonnal itassa fel.

A vízkőoldás elvégzéséhez	
Vízkőoldószer	De'Longhi vízkőoldószer
Edények	2 db 1 literes
Idő	~40min

1. (HA VAN, VEGYE KI A VÍZLÁGYÍTÓ SZŰRŐT ÉS A SOFT-BALLS-T). Öntsön a víztartályba (A15) vízkőoldót a tartály belső oldalára vésett A szintig (ez egy 100 ml-es csomagolásnak felel meg) (57. ábr.).

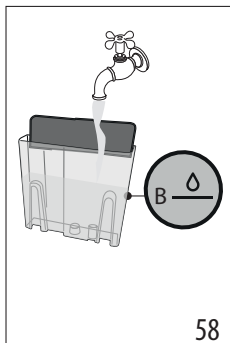
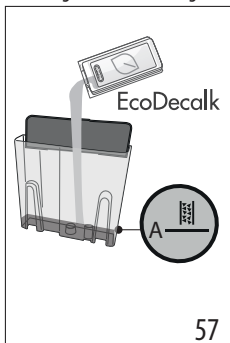

2. Adjon hozzá vizet a B szint eléréséig (58. ábr.). Tegye vissza a víztartályt a gépbe.

3. Helyezze be a tartozékokat (C6) a csatlakozóba a LatteCrema System-hez (A6) (59. ábr.).

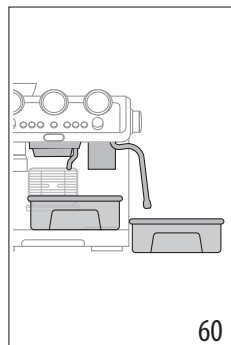
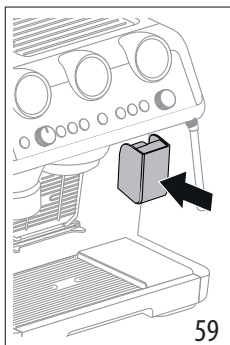

4. Győződjön meg arról, hogy a szűrőtartó (C1) nincs beakasztva és helyezzen egy edényt a kávé és a víz adagoló (A7), valamint a gőz adagoló alá (A5) (60. ábr.).

5. Tartsa nyomva a (B8) gombot, amíg a vonatkozó jelzőfény villogni nem kezd.
6. A vízkőoldó program elindul, és a vízkőoldó folyadék az adagolón keresztül távozik. A vízkőoldó program során a készülék meghatározott időközönként számos átmosást végez, amellyel eltávolítja a kávéfőző készülékben képződött vízkövet és teljesen kiüríti a tartályt.

Az adagolás megszakad és a jelzőfény fehérre vált. El kell végezni az öblítési ciklust:

7. Ürítse ki a vízkőoldó folyadék összegyűjtéséhez használt edényt és tegye az adagoló alá.
8. Vegye ki a víztartályt, öntse ki belőle a vízkőoldó folyadék esetleges maradványait, öblítse ki folyó vízzel és töltsse fel friss vízzel a MAX szint jelzésig (61. ábr.). Tegye vissza a tartályt a helyére.

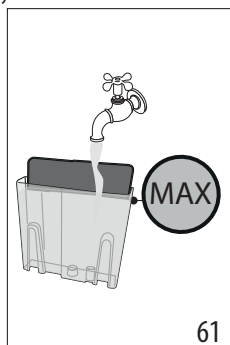



9. Tartsa nyomva a gombot, amíg a vonatkozó jelzőfény villogni nem kezd: az öblítés elindul.











10. Az öblítés végén az adagolás megszakad és a készülék kényszeren áll a használatra.













11. Ürítse ki az öblítővíz összegyűjtésére használt edényeket.  
 12. Emelje ki és ürítse ki a csepptálcát, majd tegye vissza.  
 13. Emelje ki és töltsse fel a tartályt friss vízzel, majd tegye vissza.  
 Ekkor a készülék készen áll a használatra.

**Megjegyzés:**



- Ha előbb kívánja elkezdni a vízköoldó ciklust, tartsa nyomva a  gombot 3 másodpercig.
- Ha a vízköoldást tévedésből indította el, nyomja meg a  gombot 10 másodpercig; az öblítést nem lehet félbeszakítani.

**12. A JELZŐFÉNYEK JELENTÉSE**

JELZŐFÉNYEK	A JELZŐFÉNYEK JELENTÉSE	MŰVELET
Az összes jelzőfény röviden villog	A készülék bekapcsolása	Önellenőrzés
 folyamatosan égő	Ez a gép első beindítása és a hidr. kört fel kell tölteni vízzel	Az alábbi fejezetben leírtak szerint járjon el. "3. A készülék első beindítása"
 folyamatosan égő	Az energiatakarékos funkció aktív	Lásd a "7. Beállítások menü" fejelet a funkció kikapcsolásához
 folyamatosan égő	A szemes kávé tartó (A1) üres	Töltse meg a szemes kávé tartót
 villogó	Kávét kíván darálni, de a szemes kávé tartó (A1) üres	Töltse meg a szemes kávé tartót
 on	A tartályban lévő víz (A15) mennyisége nem elegendő vagy a víztartály nem megfelelően van betéve	Töltse fel a tartályt vagy vegye ki vagy a víztartályt nem jól van betéve
 villogó	Italt kíván készíteni, de a víztartály (A15) üres	Töltse meg a víztartályt
 folyamatosan égő	Általános riasztás	Forduljon egy márkaszervizhez
 folyamatosan égő	A szemes kávé tartó nincs behelyezve	Helyezze be megfelelően a szemes kávé tartót (A1) vagy ellenőrizze, hogy megfelelően van-e behelyezve
 villogó	A szemes kávé tartó (A1) aljánál lévő választókapcsoló nincs a megfelelő állásban	Állítsa a választókapcsolót az egyik órlési pozícióba (1 és 8 között), figyelvén arra, hogy: <ul style="list-style-type: none"> <li>• Az órlést akkor kell beállítani, amikor a kávédaráló működésben van</li> <li>• Egyszerre egy szintet állítson és legalább 5 darálást végezzen, mielőtt másik állásba forgatja</li> </ul>
	A szemes kávé tartó (A1) nincs teljesen behelyezve: bekapcsol a biztonságvédelmi eszköz	Ellenőrizze, hogy a szemes kávé tartó megfelelően legyen behelyezve
 folyamatosan égő	A LatteCrema System-et minden egyes használat után meg kell tisztítani	Miután elvégezte a tejes alapú italok készítését, indítsa el az automata tisztítást a gomb (D5) Clean állásba való forgatásával
		→

JELZŐFÉNYEK	A JELZŐFÉNYEK JELENTÉSE	MŰVELET
 folyamatosan égő	A készülék készen áll a gőz adagolására.	A készülék elérte a gőz adagolásához szükséges hőmérsékletet. Az adagolás megkezdéséhez forgassa el a gőz szabályozógombot (A4)
 villogó	A készülék be van kapcsolva és az energiatakarékosság funkció aktív: a gőz szabályozógomb (A4) gőz adagoló pozícióban áll	A villogó jelzőfényt azt jelzi, hogy a készülék készül a gőz adagolására: az adagolás azonnal megkezdődik, amint a készülék eléri a hőmérsékletet
	A készülék készen áll a gőz adagolására	A készülék hőmérséklete akkor megfelelő a gőz készítéséhez, ha a jelzőfényt folyamatosan kezd el égni
	A készülék gőzt enged ki	
 folyamatosan égő (narancssárga)	El kell végezni a vízköoldást	Végezze el a vízköoldást az alábbi bekezdés szerint. "11. Vízköoldás"
 villogó (narancssárga)	A készülék vízköoldást végez	A műveletet a "11. Vízköoldás" fejezetben leírtak szerint végezze.
 folyamatosan égő (fehér)	El kell végezni az öblítést	
 villogó (fehér)	A készülék öblítést végez	
 folyamatosan égő (narancssárga)	Meg kell tisztítani a kávéadagolót	Lásd a "8.1 A kávéadagoló tisztítása" bekezdést.
 villogó (narancssárga)	A készülék a kávéadagoló tisztítását végzi	
 villogó (fehér)	A készülék egy öblítést végez	
 +  villogó	Ha van vízlágyító szűrő, lehet, hogy légbuborék került a rendszerbe, amely megakadályozza az adagolást	Nyomja meg a (B7) gombot a  jelzőfényrel egy magasságban: kezdetét veszi az adagolás és automatikusan félbeszakad.
	A kávé túl finomra őrölte, így a kávé csak nagyon lassan vagy egyáltalán nem folyik le	Vegye ki a szűrőtartó egységet (C1), ismétlje meg a kávéfőző műveleteket a "4.1 1. fázis - Őrlés (grinding) (11. ábr.)" és "4.2 2. fázis - Tömörítés (tamping) (17. ábr.)" bekezdések figyelembevételével
	A (C2) vagy (C3) kávé szűrő eltömődött	Öblítse el a szűrőket folyó víz alatt vagy az öblítés gombbal (B5) végezzen el egy öblítést.
	A tartály (A15) rosszul van behelyezve és a vonatkozó szelepek nincsenek nyitva	Finoman nyomja meg a tartályt úgy, hogy a szelepek kinyíljanak
	Vízkö van a hidr. rendszerben	Végezze el a vízköoldást a "11. Vízköoldás" fejezetben leírtak szerint.

### 13. HA VALAMI NEM MŰKÖDIK

PROBLÉMA	OK	MEGOLDÁS
Víz van a csepttálcában (A11)	Ez a gép belső köreinek normál működési jelensége	Rendszeresen ürítse ki és tisztítsa meg a csepttálcát (A11)
Nem jön ki több presszókávé	Nincs víz a tartályban (A15)	Töltse fel a tartályt
	A  (B7) jelzőfény világít jelezvén, hogy a kávékör vagy a gőz kör üres.	Nyomja meg a  jelzőfényhez tartozó gombot a hidr. kör feltöltése érdekében.
	A (C2) vagy (C3) szűrő eltömődött	Öblítse el a szűrőket folyó víz alatt vagy a vonatkozó gombbal (B5) végezzen el egy öblítést
	A tartály (A15) rosszul van behelyezve és az alján található szelepek nincsenek nyitva	Finoman nyomja meg a tartályt úgy, hogy az alján lévő szelepek kinyíljanak
	Vízkezelő van a hidr. rendszerben	Végezze el a vízköoldást a "11. Vízköoldás" fejezetben leírtak szerint.
	Túl finomra őrölt kávé	Vegye ki a szűrőtartó egységet (C1), ismétlje meg a kávéfőző műveleteket a "4.1 1. fázis - Őrlés (grinding) (11. ábr.)" és "4.2 2. fázis - Tömörítés (tamping) (17. ábr.)" bekezdések figyelembevételével
A szűrőtartót nem lehet ráakasztani a készülékre	Az őrölt kávé nem lett tömörítve vagy túl sok	Ismétlje meg a kávédarálást eltérő beállításokkal. Csökkentse az adag mennyiségét: ellenőrizze, hogy a (C2) vagy (C3) szűrő (1 vagy 2 csésze) megfelel-e az őrlendő adagnak (2x gomb (B3) ki van-e választva vagy sem)
Az espresso kávé nem a szűrőtartó (C1) lyukain keresztül, hanem a szélén át csepeg	A szűrőtartó rosszul lett behelyezve	Akassza be megfelelően a szűrőtartót, és erővel teljesen csavarja be
	A kávéadagoló (A7) tömítése elvesztette rugalmasságát vagy szennyezett	Cserélje ki a kávéadagoló tömítését egy szakszerviznél
	A (C2) vagy (C3) szűrő eltömődött	Öblítse el a szűrőket folyó víz alatt vagy végezzen egy öblítést a vonatkozó gombbal (B5)
A kávékrém világos színű (a kávé gyorsan folyik le a csőrből)	Meg kell vizsgálni a készülék beállításait	Vegye ki az egységet, ismétlje meg a kávéfőző műveleteket a „4.1 1. fázis - Őrlés (grinding) (11. ábr.)” és „4.2 2. fázis - Tömörítés (tamping) (17. ábr.)” bekezdések figyelembevételével
		→

PROBLÉMA	OK	MEGOLDÁS
A kávékrém sötét színű (a kávé lassan folyik le a csőrből)	Meg kell vizsgálni a készülék beállításait	Vegye ki a szűrőtartó egységet (C1), ismétlje meg a kávéfőző műveleteket a "4.1 1. fázis - Őrlés (grinding) (11. ábr.)" és "4.2 2. fázis - Tömörítés (tamping) (17. ábr.)" bekezdések figyelembevételével
Nem képződik tejhab, miközben cappuccino-t készít a LatteCrema System-mel	A tej nem eléggé hideg	Mindig hűtőszekrény-hőmérsékletű tejet használjon
	A gomb (D5) nincs a megfelelő állásban	Ellenőrizze és forgassa a gombot a megfelelő állásba (☞ max hab; ☞ med hab; ☞ min hab)
	A LatteCrema System szennyezett	Végezze el a tisztítást a „8.6 A LatteCrema System tisztítása” bekezdésben leírtak szerint
	Vízke van a hidr. rendszerben	Végezze el a vízkeoldást a "11. Vízkeoldás" fejezetben leírtak szerint.
A vízkeoldás végeztével a készülék egy újabb öblítést igényel	Az öblítési ciklus közben a tartály nem töltődött fel a MAX szintig	Ismétlje meg az öblítést (lásd a "11. Vízkeoldás" fejezetet)
A készülék nem darál kávé	Idegen test került a kávédaráló belsejébe	Tisztítsa meg a darálókat a "8.3 A daralók tisztítása" bekezdésben leírtak szerint, győződjön meg arról, hogy eltávolította az összes kávészemet a szemes kávé tartóból (A2) annak kivétele előtt. Mielőtt visszatenné a darálót, gondosan távolítsa el minden maradékot a fészkekből
	A szemes kávé tartó (A1) nincs a megfelelő helyzetben	A tartály megfelelően van behelyezve, ha a ▲ nyíl a ☞ szimbólumhoz igazodik, és „kattanást” hall
Amennyiben más minőségű kávé szeretne használni	El kell távolítani a gépben lévő összes kávészemet	<ul style="list-style-type: none"> <li>• Őrítse ki a szemes kávé tartót (A1) (végezen üres járatban őrléseket vagy szükség esetén szívja el a maradék szemeket)</li> <li>• Akassza be a szűrőtartó egységet (C1) és végezzen több őrlést „üres” járatban, hogy szabaddá tegye a kávé csövet: akassza a szűrőtartót a kávédaráló kimenetére (A18) egy vonalra állítva az INSERT felirattal és a szűrőtartót forgassa el jobbra (22 ábr.). Az őrlés akkor veszi kezdetét, amikor a kar eléri a CLOSE pozíciót és automatikusan félbeszakad. Ismétlje meg, amíg a szűrő üres nem lesz</li> <li>• Tegye a tartóba (A1) az új fajtájú szemes kávé</li> <li>• Ha a daraláskor nem éri el a „tökéletes adagot”, járjon el úgy, mint a legelső használatkor</li> </ul>
		→

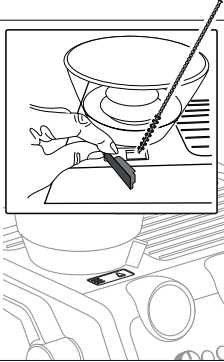
PROBLÉMA	OK	MEGOLDÁS
<p>Az őrlést követően a (C2) vagy (C3) kávé szűrő üres</p> <p>Őrlés után nagy mennyiségű kávépor van a szűrőben</p>	<p>A kávédaráló kávé csúszdája el van tömődve</p>	<p>Végezze el a tisztítást a „8.5 A „Smart tamping station” tisztítása” bekezdésben leírtak szerint. Ha a probléma továbbra is fennáll, nyissa ki a csúszda fedelét (A19) és a tisztító kefével szabadítsa fel a csúszdát</p> 
<p>A darálás után az őrlött kávé a (C2) vagy (C3) szűrőben nem éri el a „tökéletes adagot”</p>	<p>A „Smart Tamping Station”-t meg kell tisztítani</p> <p>Be kell állítani az őrlött kávé mennyiségét</p> <p>Idővel a darálók elkopnak</p>	<p>Végezze el a tisztítást a „8.5 A „Smart tamping station” tisztítása” bekezdésben leírtak szerint. majd ismétlje meg a darálást</p> <p>Szabályozza a mennyiséget az e célt szolgáló szabályozógommbal (B2) a „A „tökéletes adag” bek. utasításait követve. Ha a gomb már a max állásban van, a „A kávédaráló extra beállítása” szakaszban leírtak szerint járjon el</p> <p>Cserélje ki a darálókat a “8.4 Darálók cseréje” bekezdésben leírtak szerint.</p>

Před použitím přístroje si vždy přečtěte příručku s bezpečnostními upozorněními.

## 1. POPIS

### 1.1 Popis přístroje - A

- A1. Zásobník na kávová zrna
- A2. Víko zásobníku na kávová zrna
- A3. Odkládací prostor na šálky
- A4. Otočný knoflík na páru
- A5. Trubička dávkovače páry
- A6. Konektor pro systém Lattecrema
- A7. Dávkovač kávy
- A8. Odkládací mřížka pro šálky na espresso
- A9. Odkládací mřížka pro sklenice nebo hrnky
- A10. Mřížka misky
- A11. Odkapávací miska
- A12. Ukazatel hladiny vody v odkapávací misce
- A13. Víko nádržky na vodu
- A14. Držadlo pro vyjmutí nádržky na vodu
- A15. Nádržka na vodu
- A16. Uložení konektoru napájecího kabelu
- A17. Hlavní vypínač (ON/OFF)
- A18. Výstup mlýnku kávy (Tamping station)
- A19. Dviřka pro přístup ke kartáčku mlýnku na kávu
- A20. Páčka péčovadla

### 1.2 Popis ovládacího panelu - B

- B1. Tlačítko ON/Standby
- B2. Regulační knoflík množství mleté kávy
- B3. Tlačítko "X2": pro použití filtru 2 kávy
- B4. Tlačítko „teplota kávy“
- B5. Tlačítko „vyplachování“
- B6. Tlačítko „OK“: pro výdej nápoje/pro potvrzení
- B7. Tlačítko „výdej horké vody“
- B8. Tlačítko „odvápnění“
- B9. Tlačítko „My“: pro osobní nastavení množství nápojů
- B10. Otočný knoflík volby funkcí
- B11. Displej s nápoji:

#### Nápoje s kávou Espresso

- Espresso
- Americano
- Káva

#### Nápoje s mlékem

- Cappuccino
- Flat White
- Latte Macchiato

- B12. Kontrolka „čištění mléka“
- B13. Kontrolka „chybí zásobník na kávová zrna“
- B14. Kontrolka „všeobecný alarm“
- B15. Tlakoměr

- B16. Kontrolka „nedostatek vody“
- B17. Kontrolka „prázdný zásobník na kávová zrna“
- B18. Kontrolka „úspora energie“
- B19. Displej nastavení a postupu:

- Označuje operaci, kterou přístroj provádí
- Označuje nastavení zvolené dávky kávy
- Označuje nastavení zvolené teploty kávy

### 1.3 Popis příslušenství - C

- C1. Miska držák filtru
- C2. Filtr 1 šálek
- C3. Filtr 2 šálky
- C4. Testovací proužek „Total Hardness Test“
- C5. Odvápňovací přípravek
- C6. Příslušenství pro odvápnění
- C7. Odnímatelný napájecí kabel
- C8. Kartáček
- C9. Příslušenství pro čištění dávkovače kávy
- C10. Hadřík
- C11. Softballs (změkčovač vody)
- C12. Jehla pro čištění parní trysky

### 1.4 Příslušenství k čištění nejsou součástí dodávky, jsou doporučené výrobcem

Další informace najdete na webu Delonghi.com.



#### Čistící tablety

(Viz „8.1 Čištění dávkovače kávy“)

EcoMultiClean Čistič  
EAN: 8004399333307

### 1.5 Popis systému LatteCrema - D

- D1. Víko nádoby na mléko
- D2. Konektor nádoby na mléko
- D3. Tlačítko uvolnění víka
- D4. Dávkovač mléka (nastavitelný na výšku)
- D5. Kolečko pro regulaci pěny
- D6. Uložení kolečka
- D7. Hadička na nasávání mléka
- D8. Nádobka na mléko

## 2. PŘÍPRAVA PŘÍSTROJE

Umyjte veškeré příslušenství teplou vodou a mycím prostředkem, a poté postupujte následovně:

1. Zasuňte tácek na odkapávání (A11) spolu s mřížkou na odkládání šálků (A9) a mřížkou misky (A10) (obr. 1);
2. Vyjměte nádržku na vodu (A15) (obr. 2) a naplňte ji čistou a čistou vodou, přičemž dávejte pozor, abyste nepřekročili nápis MAX (obr. 3).



3. Poté zasuňte zpět nádržku.

**Pozor:** Nikdy neuvádějte do provozu přístroj bez vody v nádrže nebo bez nádržky.

**Poznámka:** Doporučujeme co nejdříve provést nastavení tvrdosti vody podle postupu popsaného v kapitole „7. Menu nastavení“.

### 3. PRVNÍ UVEDENÍ PŘÍSTROJE DO PROVOZU

1. Zasuňte konektor napájecího kabelu (C7) do příslušného umístění (A16) na zadní straně přístroje (obr. 4); poté zasuňte zástrčku do zásuvky. Ubezpečte se, že hlavní vypínač (A17), umístěný na zadní straně přístroje, je stisknutý v poloze I (obr. 5);
2. Umístěte pod dávkovač horké vody (v úrovni dávkovače kávy (A7)) nádobu o minimálním objemu 100 ml (obr. 6);
3. Stisknete tlačítko (B7) v úrovni kontrolky (obr. 7): výdej se zahájí a automaticky přeruší. Nádobu vyprázdněte.

Než začnete přístroj používat, je nutné vypláchnout jeho vnitřní okruhy. Postupujte následovně:

4. Připevněte misku držák filtru (C1) spolu s filtrem k přístroji: pro správné připevnění zarovnejte rukojeť držáku filtru se symbolem "INSERT" (obr. 8) a otočte rukojeť směrem doprava, až do zarovnání s polohou "CLOSE";
5. Umístěte nádobu pod misku držák filtru a trubičku dávkovače páry (A5);
6. Stisknete tlačítko (B5) v úrovni kontrolky (obr. 9): spustí se výdej;
7. Po dokončení výdeje otočte knoflíkem na páru (A4) (obr. 10) a několik vteřin vydávejte páru tak, aby se propláchl parní okruh: pro optimální výdej páry se doporučuje tento postup zopakovat 3 nebo 4krát. To umožní odstranit vodu z trubičky před výdejem páry.

Přístroj je tak připraven k použití.

**Poznámka:** vyplachování vnitřních okruhů je doporučeno také v případě delšího nepoužívání přístroje.

Při prvním použití je nutné připravit 4-5 káv předtím, než přístroj začne podávat uspokojivý výsledek: věnujte zvláštní pozornost dávce mleté kávy ve filtru ((C2) nebo (C3)) (viz pokyny v odstavci „4.1 Fáze 1 - Mletí (grinding) (obr. 11)“).

Postupujte, jak je uvedeno v kapitole „Dokonalá dávka“.

### 4. PŘÍPRAVA KÁVY

#### 4.1 Fáze 1 - Mletí (grinding) (obr. 11)

1. Nasypte zrna do zásobníku (A1) (obr. 12). Doporučujeme nasypat pouze zrna nezbytná pro přípravu: tímto způsobem budete vždy používat čerstvou kávu;
2. Vyberte stupeň mletí (obr. 13). Výchozí tovární nastavení je 5 (střední mletí). Pokud výsledek není uspokojivý, upravte stupeň podle vlastní chuti a druhu kávy (nastavení se provádí, když je mlýnek na kávu v provozu).
3. Vložte jeden z filtrů kávy (C2) nebo (C3) do držáku filtru (C1) (obr. 14). Pokud se používá filtr na 2 šálky, stisknete

tlačítko 2X (B3): tímto výběrem se zdvojnásobí také vydané množství espressa.

4. Proveďte nastavení knoflíku množství (B2) počínaje od minimální polohy (obr. 15).

#### Poznámka:



Čísla zobrazená na displeji (B19) jsou odkazem pro zaznamenání, jakmile je dosaženo správné úrovně v držáku filtru. Neodpovídají nastavení mletí, hmotnosti mleté kávy (g/oz) nebo době mletí.

Pro další pokyny nahlédněte do odstavce „B3. Tlačítko "X2": pro použití filtru 2 kávy“.

5. Zahákněte držák filtru k výstupu mlýnku (A18) zarovnaním s nápisem INSERT: poté otočte misku směrem doprava (obr. 16). Mletí je zahájeno, když se miska dostane do polohy CLOSE a automaticky se zastaví.

#### Nastavení množství mleté kávy ve filtru

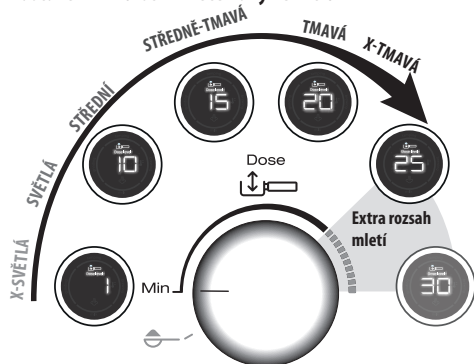

Každý druh zrna dává během mletí jiný výsledek, a proto je při úpravě dávky nutné zpočátku postupovat velmi opatrně. Tento obrázek ukazuje, jak upravit dávku podle barvy pražení: je třeba je považovat za výchozí bod, ale mohou se lišit podle složení kávových zrn.

1. Nastavte dávku z minimální polohy.
2. Podle barvy pražení vaší kávy pomalu otáčejte knoflíkem.

#### 4.2 Fáze 2 - Vážení (tamping) (obr. 17)

1. Po namletí sklopte pěchovací páčku (A20) až na doraz (neodstraňujte držák filtru) (obr. 18). Pro dokonalý výsledek zopakujte 2 krát.
2. Při demontáži držáku filtru držte páčku skloněnou až na doraz (obr. 19). Poté uveďte páčku do výchozí polohy.
3. Po ověření správné dávky kávy (viz „Dokonalá dávka“), zahákněte držák filtru k dávkovači kávy (A7) (obr. 20).

## „Dokonalá dávka“

- Kávéové filtry mají vnitřní referenční značení pro určení dokonalé dávky.



- Filtry s laserovým značením: dokonalá dávka odpovídá horní čáře značení;
- Filtry s reliéfním značením: dokonalá dávka odpovídá reliéfní linii;
- Ujistěte se, že je káva po upěchování zarovnaná. Může být nutná opakovaná regulace knoflíku (B2), než je dosaženo dokonalé dávky.
- Pokud je káva nadměrně nebo nedostatečně extrahována a dávka je v rámci dokonalé dávky, upravte stupeň hrubosti mletí na jemnější nebo hrubší (viz „4.1 Fáze 1 - Mletí (grinding)“ (obr. 11)“). Pokud je káva nadměrně extrahována (výdej příliš pomalý), mletí bude muset být hrubší. Pokud je káva nedostatečně extrahována (výdej příliš rychlý), mletí bude muset být jemnější.
- **Barman doporučuje:** Vyjměte držák filtru, zatímco je páčka pěchovadla (A20) sklopená, abyste dosáhli dokonalého zakončení dávky kávy.

### 4.3 Fáze 3 - Výdej (brewing) (obr. 21)

1. Vyberte požadovaný nápoj (obr. 22).
2. Stiskněte OK (B6) pro zahájení výdeje (obr. 23) (před-spaření a spaření). Výdej kávy se automaticky přeruší.

## 5. PŘÍPRAVA NÁPOJE S MLÉKEM

### 5.1 Napěňte mléko (obr. 24)

1. Nalijte do nádoby na mléko (D8) množství mléka, které se má ohřát/napěnit, přičemž vezměte v úvahu, že se objem mléka zdvojnásobí nebo ztrojnásobí (obr. 25). Pro získání hustší a homogennější pěny se doporučuje používat plnotučné kravské mléko mající teplotu z lednice (zhruba 5 °C).

## My Latte Art

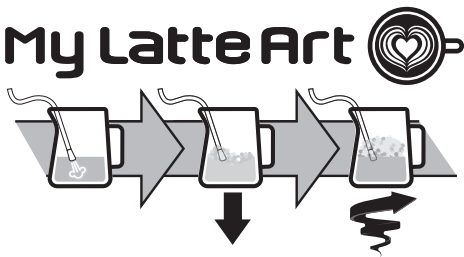

2. Pro napěnění mléka umístěte trubičku dávkovače páry (A5) na povrch mléka: tímto způsobem se vzduch mísí s mlékem a párou.

3. Udržujte dávkovač páry na povrchu, a dávejte pozor, abyste nezachytili příliš mnoho vzduchu vytvořením příliš velkých bublin.
4. Ponořte dávkovač páry pod povrch mléka: tímto způsobem se vytvoří vír. Po dosažení požadované teploty zavřete otočný knoflík na páru a před vyjmutím konvičky na mléko počkajte, až se výdej páry zcela přeruší.

### Barman doporučuje:





- **Lepší je studené mléko.** Používejte vždy studené mléko z lednice.
- Plnotučné mléko zajistí vynikající výsledky. Výsledek a struktura pěny se liší podle použitého kravského mléka nebo rostlinných nápojů.
- Po napěnění mléka odstraňte bubliny protřepáním konvičky na mléko.

### Čištění dávkovače páry:

1. Po každém použití odstraňte zbytky mléka z dávkovače páry hadříkem (obr. 26). Pro hloubkové čištění je vhodné použít Eco MultiClean: zajišťuje hygienu odstraněním mléčných bílkovin a tuků a může být použit k čištění celého přístroje.
2. Vydávejte páru několik sekund, aby se dávkovač dobře vyčistil (obr. 10).
3. Počkejte, až dávkovač vychladne: pro udržení účinnosti dávkovače v průběhu času použijte pro zachování volných 3 otvorů (obr. 27) čistící jehlu (C12).

### 5.2 Příprava nápojů s mlékem se systémem LatteCrema (obr. 28)

1. Nalijte do nádoby (D8) mléko o teplotě z lednice (5 °C) (obr. 29).
2. Zavřete víko (D1) (obr. 30).
3. Otočte kolečko pro regulaci pěny (D5) na požadovanou teplotu (obr. 31).

Poloha kolečka pro regulaci pěny				
 CLEAN				 INSERT
Po každém použití	P ě n a MAX	P ě n a MED	Pěna MIN	Pro vytahování nebo zasunutí kolečka

4. Zahákněte nádobku na mléko ke kávovaru (obr. 32).
5. Připravte dokonalou dávku (viz „4.1 Fáze 1 - Mletí (grinding)“ (obr. 11)“ a „4.2 Fáze 2 - Vážení (tamping)“ (obr. 17)“) a zasuňte držák filtru.
6. Vyberte požadovaný nápoj s mlékem (obr. 33).



Nápoj	Espresso	Mléko	Pěna	Množství (ml)	X2 (ml)
Cappuccino	1	✓	✓	≈150	≈230
Latte Macchiato	1	✓	✗	≈150	≈230
Flat White	1	✓	✓	≈250	≈330

- **Nápoje s dvojitou dávkou (2x):** Nalijte do nádoby (D8) množství mléka potřebné k přípravě, přičemž dávejte pozor, abyste nepřekročili hladinu MAX (obr. 25). Každá značka na nádobce odpovídá ≈100 ml mléka.
  - **Lepší je studené mléko.** Používejte vždy studené mléko z lednice.
7. Stiskněte OK (B6) pro výdej (obr. 23). Přístroj postupně automaticky vydá kávu a mléko.

### Čištění systému Lattecrema po každém použití:

1. Nechte nádobku na mléko zaháknutou k přístroji (není nutné ji vyprázdnovat). Vložte nádobu pod hadičku pro výdej mléka (D4) (obr. 34).
2. Otočte kolečkem (D5) na "Clean" (obr. 35).

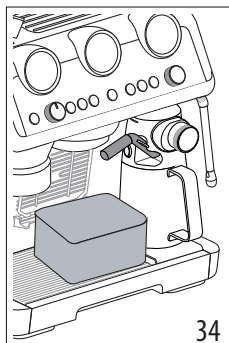

3. Čištění je zahájeno a automaticky se přeruší. Upozornění: po vyčištění otočte kolečko do jedné z poloh pro regulaci pěny.

4. Vyjměte nádobku na mléko a umístěte ji do lednice: zbylé mléko je vhodné použít během krátké doby.

Pro hloubkové čištění je vhodné použít Eco MultiClean: zajišťuje hygienu odstraněním mléčných bílkovin a tuků a může být použit k čištění celého přístroje.

## 6. PŘÍZPŮSOBENÍ MNOŽSTVÍ KÁVOVÝCH NÁPOJŮ TLAČÍTKEM (my) (B9)

1. Připravte přístroj pro výdej 1 nebo 2 šálek požadovaného kávového nápoje až po zaháknutí držáku filtru (C1) vybaveného filtrem (C2) nebo (C3) a mletou kávou. Chcete-li naprogramovat nápoj s mlékem, připojte systém Lattecrema k přístroji.
2. Otočte kolečkem (B10) pro výběr nápoje určeného k naprogramování.
3. Stiskněte tlačítko (my): kontrolka odpovídající tlačítku OK (B6) se rozsvítí a kontrolka odpovídající tlačítku (my) bliká.
4. Stiskněte tlačítko OK pro zahájení výdeje. Kontrolky odpovídající tlačítkům OK a (my) blikají.
5. Jakmile dosáhnete požadovaného množství, stiskněte OK. Pokud nápoj předvidá výdej další přísady, zahájí se výdej druhé přísady: jakmile je dosaženo požadovaného množství, stiskněte OK.
6. Stiskněte tlačítko (my) pro uložení. Přístroj je připraven k novému použití a kontrolka (my) svítí.

Pokud programování uložit nechcete, stiskněte jakékoliv jiné tlačítko.

### Poznámka:

- Je možné naprogramovat nápoje s kávou, ale ne výdej páry a horké vody.
- Programování mění množství nápojů, ale ne mleté kávy.
- Nápoje "X2" lze naprogramovat odděleně.

- **My LatteArt** nelze naprogramovat.
- **Pro návrat k výchozímu nastavení držte stisknuté tlačítko (my) až do vypnutí.** Vybraný nápoj se vrátí na výchozí množství.

Kávový recept	Výchozí množství	Nastavitelné množství
Espresso	35 ml	od 25 do 90 ml
Espresso X2	70 ml	od 50 do 180 ml
Coffee	80 ml	od 50 do 120 ml
Coffee X2	160 ml	od 120 do 240 ml
Americano	120 ml	<ul style="list-style-type: none"> <li>• espresso: od 25 do 60 ml</li> <li>• voda: od 25 do 120 ml</li> </ul>

Kávový recept	Výchozí množství	Nastavitelné množství
X2	240 ml	<ul style="list-style-type: none"> <li>• espresso: od 50 do 120 ml</li> <li>• voda: od 50 do 240 ml</li> </ul>

## 7. MENU NASTAVENÍ

1. Vstupte do menu:		
Stiskněte současně po dobu 5 vteřin	x2	
2. Vyberte nastavení určené k naprogramování:		
Nápoj	Odpovídající nastavení	Regulace
 Espresso	Úspora energie	→ <b>Aktivní</b>
		→ <b>Vypnuto</b>
 Coffee	Automatické vypnutí	→ <b>9 minut</b>
		→ <b>1,5 hodiny</b>
		→ <b>3 hodiny</b>
 Cappuccino	Zvukové hlášení	→ <b>Aktivní</b>
		→ <b>Vypnuto</b>
 Latte	Extra nastavení mletí	→ <b>Rozsah 1</b>
		→ <b>Rozsah 2</b>
 Flat White	Výchozí hodnoty	Držte stisknuté tlačítko OK po dobu nejméně 5 sekund, dokud kontrolka nezůstane rozsvícená
 Americano	Tvrdość vody	→ <b>měkká</b>
		→ <b>středně tvrdá</b>
		→ <b>tvrdá/velmi tvrdá</b>
		→

## 3. Uložte nová nastavení stisknutím ON/Standby (B1)

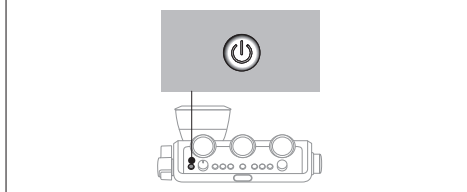

## 8. ČIŠTĚNÍ PŘÍSTROJE

### Pozor!

- Na čištění přístroje nepoužívejte ředidla, abrazivní čisticí prostředky nebo alkohol.
- Na odstraňování vodního kamene nebo kávových usazenin nikdy nepoužívejte kovové předměty, protože by mohlo dojít k poškrábání kovového nebo plastového povrchu.
- Pokud přístroj nepoužíváte déle než týden, doporučuje se před použitím provést vyplachování.

### Nebezpečí!

- Během čištění nedávejte nikdy přístroj do vody: je to elektrické zařízení.
- Před jakoukoli operací čištění vnějších částí přístroj vypněte, vytáhněte zástrčku ze zásuvky elektrického napětí a nechte jej vychladnout.

	×	✓	✓	×	×
	✓	×	×	✓	✓
	×	×	×	✓	✓
	×	×	×	✓	✓
	×	×	✓	✓	×
					→

	×	×	×	✓	✓
	✓	✓	×	✓	✓

### 8.1 Čištění dávkovače kávy

Když se kontrolka (B5), je nutné vyčistit okruh kávy. Chcete-li spustit čistící cyklus, kupte si čistící tablety pro kávovary. Další informace najdete na webu [www.Delonghi.com](http://www.Delonghi.com).

1. Vložte filtr 1 šálek (C2) do držáku filtru (C1) (obr. 36).
2. Vložte do filtru čistící příslušenství (C9) (obr. 36) a zatlačte jej na doraz.

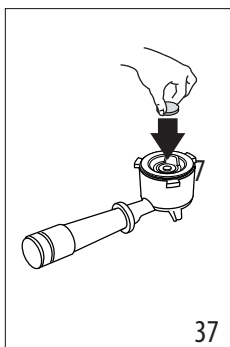
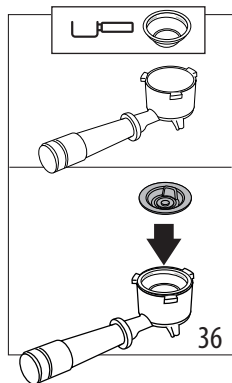

3. Vložte čistící tabletu na příslušenství (obr. 37).
4. Připojte držák filtru k dávkovači kávy (A7).
5. Naplňte nádržku na vodu (A15). Zkontrolujte, zda je odpadávací miska (A11) prázdná.
6. Držte stisknuté tlačítko (B5), dokud příslušná kontrolka nezačne blikat (oranžová). Po několika minutách se čistění automaticky přeruší.
  - Demontujte držák filtru a čistící příslušenství.
  - Umyjte držák filtru a filtr pod tekoucí vodou.
  - Zasuňte zpět držák filtru a proveďte vyplachování stisknutím tlačítka (B5); doporučuje se vložit pod držák filtru nádobu.
  - Vyjměte a vyprázdněte odpadávací misku.

#### Poznámka:

Tento čistící cyklus lze spustit v jakémkoliv okamžiku stisknutím tlačítka (B5) na několik vteřin. Chcete-li operaci zrušit, stiskněte tlačítko na 10 vteřin.

### 8.2 Čištění uložení zásobníku na kávová zrna

1. Ujistěte se, že je zásobník na kávová zrna (A1) prázdný. Případně proveďte několik mletí naprázdno.
2. Vyhákněte zásobník jeho otočením proti směru hodinových ručiček a vyjměte ji z kávovaru (obr. 38)

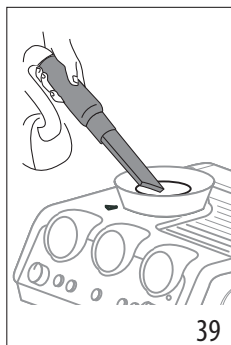
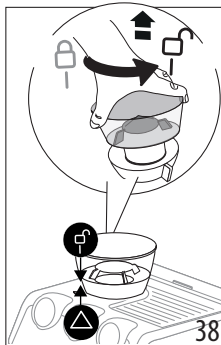

3. Vysajte zbytky kávy (obr. 39).
4. Očistěte uložení zásobníku na kávová zrna vlhkým hadříkem a osušte (obr. 40);

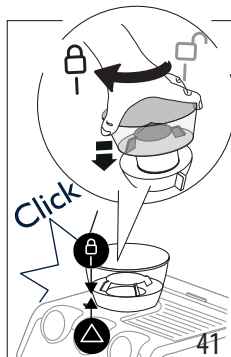
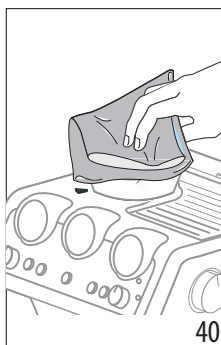

5. Zasuňte zásobník zpět do mlýnku na kávu. Zásobník je zasunut správně, když je šipka ▲ zarovnaná se symbolem a uslyšíte zacvaknutí (obr. 41).

### 8.3 Čištění mlecích kamenů

Při čištění zásobníku na kávová zrna (A1) očistěte uložení nádoby a horní mlecí kámen vlhkým hadříkem. Pro vyjmutí a výměnu mlecích kamenů se obraťte na servisní středisko.

Mlecí kámen lze vyjmout, pokud je zablokován cizím tělesem. Pokud k tomu dojde, vyjměte zásobník na kávová zrna a postupujte následovně:

1. Zahákněte misku držák filtr (C1) a proveďte mletí "naprázdno" pro uvolnění kávového potrubí.
2. Vypněte přístroj.
3. Otočte proti směru hodinových ručiček regulátor mletí až na doraz, do polohy "REMOVE" (obr. 42).

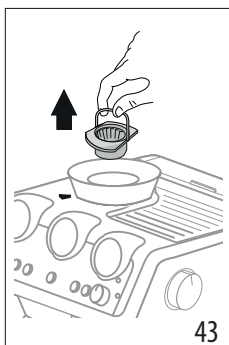
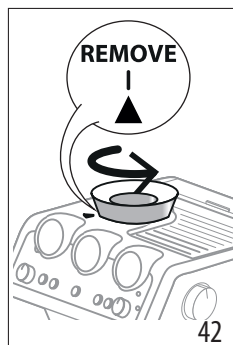

4. Sejměte horní část mlecího kamene uchopením za příslušnou rukojeť (obr. 43).
5. Mlecí kámen vyčistíte štětečkem (obr. 44) a zbytky kávy odsajte vysavačem (obr. 39).

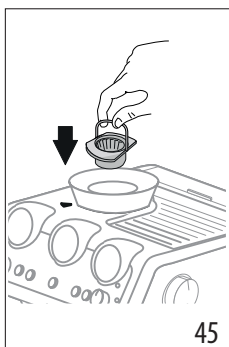
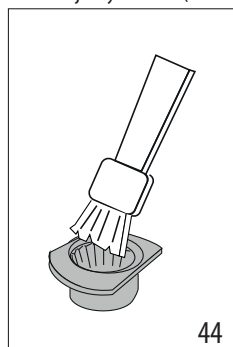

6. Vložte mlecí kámen na své místo (obr. 45);
7. Otočte regulátorem pro zvolení požadovaného stupně hrubosti mletí (obr. 13);

Ověřte, zda je mlecí kámen dobře zasunutý, tím že zatáhnete za jeho rukojeť: mlecí kámen je správně vložený, pokud se nepohne;

#### 8.4 Výměna mlecích kamenů

Když se množství mleté kávy dále sníží, obraťte se na servisní středisko ohledně výměny mlecích kamenů: poté mlýnek znovu seřídte tak, že vstoupíte do menu nastavení („7. Menu nastavení“) a vyberete první rozsah extra regulace mletí. Poté otočte knoflíkem pro regulaci množství (B2) do polohy MIN a upravte dávku jako při prvním použití (viz „Dokonalá dávka“).

#### 8.5 Čištění „Smart tamping station“

1. Vyčistíte oblast zaháknutí kartáčkem (obr. 46).
2. Zatáhnete za páčku (A20) až na doraz a vyčistíte pěchovač kartáčkem (obr. 47), poté páčku uvolníte.
3. Použitím štětečky (C8) vyčistíte skluz kávy (obr. 48).

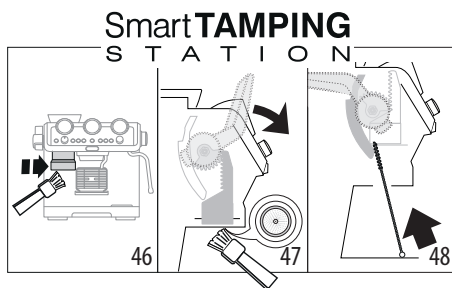

#### 8.6 Čištění systému LatteCrema

Umyjte v myčce na nádobí všechny součásti, musíte je však umístit do horního košíku myčky. Pokud nemáte myčku na nádobí, umyjte vše v ruce, jak je uvedeno v poznámce na konci odstavce.

1. Stiskněte tlačítko (D3) a zvedněte víko nádoby na mléko (D1);
2. Sejměte dávkovač mléka (D4) a hadičku na nasávání ((D7) (obr. 49);

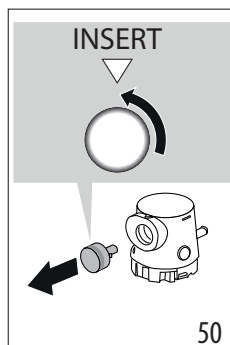
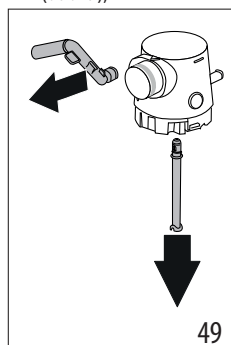

3. Otočte kolečko do polohy „Insert“ a vyjměte jej (obr. 50);
4. Věnujte zvláštní pozornost tomu, aby na drážce a ve žlábků pod kolečkem (obr. 51) nezůstaly žádné zbytky mléka: pokud je to nutné, vyškrábněte drážku párátkem;

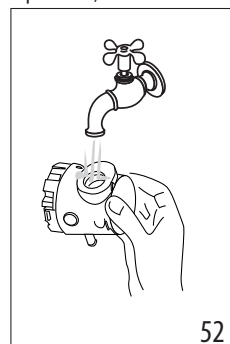
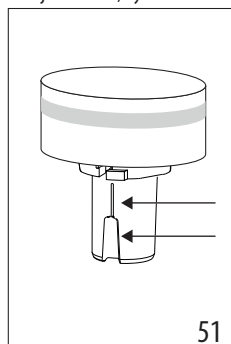

5. Opláchněte vnitřek uložení kolečka pro regulaci pěny pod tekoucí vodou (obr. 52);
6. Ujistěte se, že hadička na nasávání a hadička pro výdej nejsou zaneseny zbytky mléka;
7. Znovu sestavte všechny součásti víka;
8. Důkladně umyjte a vypláchněte nádobku na mléko (D8) ;
9. Znovu nasadte víko na nádobku na mléko.





#### **Poznámka: mytí v ruce**

Mytí v myčce na nádobí zajišťuje dokonalou hygienu všech součástí nádoby na mléko: v případě mytí v ruce důkladně umyjte všechny součásti nádoby na mléko teplou vodou a ponořte je do dřezu s teplou vodou a nechte je ponořené zhruba 30 minut před tím, než budete pokračovat, jak je uvedeno od bodu 4.

## **9. TVRDOST VODY**

Kontrolka  (B8) odvápnění se zapne po předem stanovené době provozu, která závisí na tvrdosti vody. Podle potřeby je možné přístroj naprogramovat podle skutečné tvrdosti vody používané v různých oblastech a snížit tak interval odvápnění.

1. Vyjměte z obalu dodaný testovací proužek "TOTAL HARDNESS TEST" (C4).
2. Přibližně na jednu sekundu ponořte celý proužek do sklenice s vodou.
3. Vytáhněte proužek z vody a lehce jím zatřeptejte. Nastavte přístroj, jak je označeno v kapitole „7. Menu nastavení“.

Výsledek testu tvrdosti vody	Tlačítko	Stupeň
	×2	<b>1</b> měkká voda
		<b>2</b> středně tvrdá voda
	OK	<b>3</b> tvrdá nebo velmi tvrdá voda
		

4. Nastavte přístroj, jak je označeno v kapitole „7. Menu nastavení“.

## **10. JAK POUŽÍVAT SOFTBALLS**

Softballs (C11) je inovativní systém, který prodlužuje životnost přístroje, aniž by měnil kvalitu vody, a zajišťuje výdej krémové a aromatické kávy. Pro optimalizaci účinnosti nechte Softballs před použitím po celou noc ve vodě.

1. Vyjměte sáček se Softballs z obalu (obr. 53).

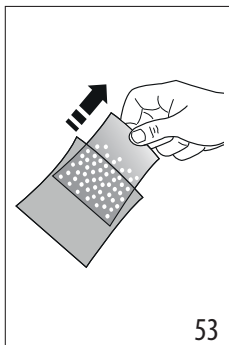

53

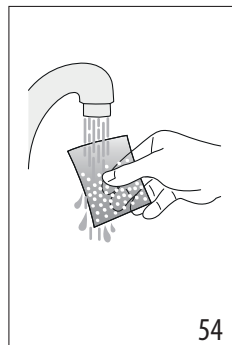

54

2. Propláchněte sáček se Softballs tekoucí vodou (obr. 54).
3. Ponořte sáček do nádržky na vodu (A15) (obr. 55).

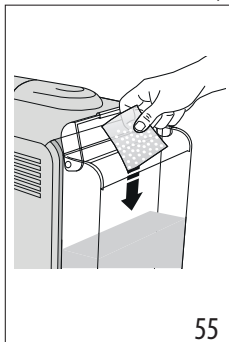

55



56

4. Vyměňte sáček se Softballs každé 3 měsíce (obr. 56).

## **11. ODVÁPNĚNÍ**

### **Pozor!**

- Před použitím si přečtěte pokyny a značení odvápnovacího přípravku (C5), uvedené na jeho obalu.
- Doporučujeme používat výhradně odvápnovací přípravek De'Longhi. Použití nevhodných odvápnovacích přípravků nebo nesprávné provádění odvápnění by mohly vést ke vzniku závad, na které se nevztahuje záruka výrobce.
- Odvápnovací přípravek může poškodit citlivé povrchy. Pokud dojde k náhodnému úniku produktu, okamžitě jej osušte.

<b>Pro provedení odvápnění</b>	
Odvápnovací přípravek	Odvápnovací přípravek De'Longhi
Nádoby	2, každá po 1 litru
Doba	~40min

1. (POKUD JSOU K DISPOZICI, VYJMĚTE ZMĚKČOVACÍ FILTR A SOFTBALLS). Nalijte do nádržky na vodu (A15) odvápnovací

přípravek až do úrovně  **A** (odpovídají jednomu balení 100ml) vytlačené na vnitřní straně nádržky (obr. 57).

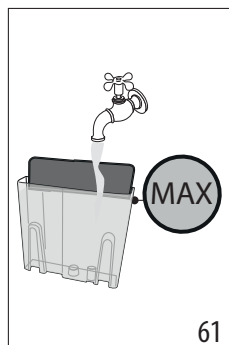
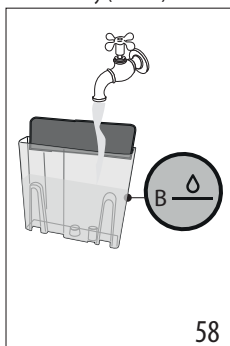
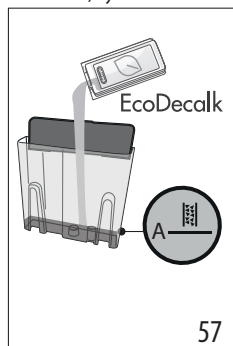

2. Přidejte vodu až k dosažení hladiny  **B** (obr. 58). Zasuňte zpět nádržku na vodu do přístroje.
3. Zasuňte příslušenství (C6) ke konektoru pro systém LatteCrema (A6) (obr. 59).

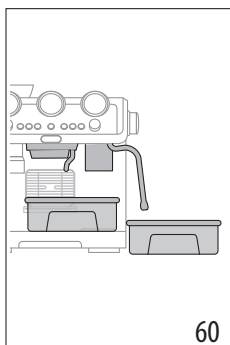
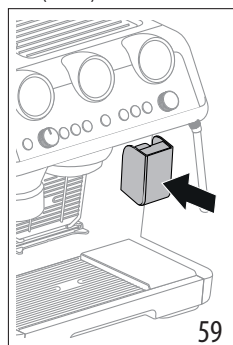



4. Ujistěte se, že držák filtru (C1) není zaháknutý a umístěte nádobu pod dávkovače kávy a horké vody (A7), a pod dávkovač páry (A5) (obr. 60).
5. Držte stisknuté tlačítko  (B8), dokud odpovídající kontrolka nezačne blikat.
6. Spustí se odvápnovací program a z dávkovačů vyteče odvápnovací kapalina. Program odvápnění automaticky provede celou sérii vyplachování s přestávkami, aby se odstranily usazeniny vodního kamene uvnitř kávovaru až do kompletního vyprázdnění nádržky.

Výdej se přeruší a kontrolka  bude bílá. Je proto nutné pokračovat ve vyplachovacím cyklu:

7. Vyprázdněte nádobu použitou ke sběru odvápnovacího roztoku a umístěte ji zpět pod dávkovače.
8. Vyměňte nádržku na vodu, vyprázdněte ji od veškerých zbytků odvápnovacího roztoku, opláchněte ji pod tekoucí vodou a naplňte ji čerstvou vodou až do úrovně MAX (obr. 61). Poté nádržku znovu zasuňte do jejího uložení.















9. Držte stisknuté tlačítko , dokud příslušná kontrolka nezačne blikat: spustí se vyplachování.
10. Po dokončení vyplachování se výdej přeruší a přístroj je připraven k použití.
11. Vyprázdněte sběrné nádoby oplachové vody.
12. Vyměňte a vyprázdněte odkapávací misku a znovu ji zasuňte.
13. Vyměňte a naplňte nádržku čerstvou vodou a znovu ji zasuňte. Nyní je přístroj připraven k použití.

**Poznámka:**









- Pokud chcete urychlit odvápnovací cyklus, podržte stisknuté tlačítko  po dobu 3 sekund.
- Pokud bylo odvápnění spuštěno omylem, stiskněte tlačítko  na 10 vteřin; vyplachování nelze přerušit.





## 12. VÝZNAM KONTROLEK

KONTROLKY	VÝZNAM KONTROLEK	ÚKON
Všechny kontrolky krátce blikají	Zapnutí přístroje	Autodiagnostika
 svítí	Jedná se o první zapnutí přístroje a je nutné provést naplnění vodního okruhu	Postupujte, jak je označeno v kap. „3. První uvedení přístroje do provozu“
 svítí	Funkce úspory energie je aktivní	Pro deaktivaci funkce odkazujeme na kap. „7. Menu nastavení“
 svítí	Zásobník na kávová zrna (A1) je prázdný	Naplňte zásobník na kávová zrna
 bliká	Pokud chcete pokračovat v mletí, ale zásobník na kávová zrna (A1) je prázdný	Naplňte zásobník na kávová zrna
 on	V nádržce (A15) není dostatek vody nebo nádržka na vodu není správně zasunuta	Naplňte nádržku nebo ji vyjměte a znovu zasuňte
 bliká	Chcete-li pokračovat v přípravě nápoje, ale nádržka na vodu (A15) je prázdná	Naplňte nádržku na vodu
 svítí	Všeobecný alarm	Obraťte se na servisní středisko
 svítí	Zásobník na kávová zrna není zasunutý	Zasuňte správně zásobník na kávová zrna (A1) nebo zkontrolujte, zda je správně zasunutý
 bliká	Volič, na spodní straně zásobníku na kávová zrna (A1), není ve správné poloze	Uvedte volič do jedné z poloh mletí (mezi 1 a 8) a nezapomeňte: <ul style="list-style-type: none"> <li>• Regulovat mletí, když je mlýnek na kávu v provozu</li> <li>• Provádět regulaci po jednotlivých stupních a vykonat nejméně 5 mletí mezi jednotlivými nastaveními</li> </ul>
	Zásobník na kávová zrna (A1) není zcela zasunutý: zasáhne bezpečnostní prvek	Zkontrolujte, zda je zásobník na kávová zrna správně zasunutý
 svítí	Systém LatteCrema musí být po každém použití vyčištěn	Po dokončení příprav na bázi mléka pokračujte v automatickém čištění otočením knoflíku (D5) na Clean
 svítí	Přístroj je připraven na výdej páry.	Přístroj dosáhl teploty pro výdej páry. Chcete-li pokračovat ve výdeji, otočte knoflíkem na páru (A4)
 bliká	Přístroj je zapnutý a funkce úspory energie je aktivní: otočný knoflík na páru (A4) je v poloze pro výdej páry	Kontrolka bliká na znamení, že se přístroj připravuje na výdej páry: výdej se zahájí, jakmile přístroj dosáhne správnou teplotu
	Přístroj je připraven na výdej páry	Když kontrolka zůstane rozsvícená, dosáhl přístroj teplotu pro přípravu páry
	Přístroj vydává páru	
 svítí (oranžová)	Je třeba přistoupit k odvápnění	Provedte odvápnění, jak je zobrazeno v kap. „11. Odvápnění“
 bliká (oranžová)	Přístroj provádí odvápnění	Pokračujte a dokončete operaci podle popisu v kap. „11. Odvápnění“



KONTROLKY	VÝZNAM KONTROLEK	ÚKON
 svítí (bílá)	Je nutné pokračovat ve vyplachování	
 bliká (bílá)	Přístroj provádí vyplachování	
 svítí (oranžová)	Je nutné provést čištění dávkovače kávy	Viz odst. „8.1 Čištění dávkovače kávy“
 bliká (oranžová)	Přístroj provádí čištění dávkovače kávy	
 bliká (bílá)	Přístroj provádí odvápnění	
 +  blikají	Je-li přítomen změkčovací filtr, mohla se do okruhu dostat vzduchová bublina, která zabránila výdeji	Stiskněte tlačítko (B7) v úrovni kontrolky  : výdej se spustí a automaticky přeruší.
	Namletí je příliš jemné a káva tedy vytéká pomalu nebo vůbec.	Vyjměte misku držák filtru (C1), zopakujte kroky pro přípravu kávy s odkazem na pokyny v odst. „4.1 Fáze 1 - Mletí (grinding) (obr. 11)“ a „4.2 Fáze 2 - Vážení (tamping) (obr. 17)“
	Kávový filtr (C2) nebo (C3) je ucpaný	Vypláchněte filtry pod tekoucí vodou nebo proveďte vyplachování pomocí tlačítka pro vyplachování (B5).
	Nádržka (A15) je špatně zasunutá a příslušné ventily nejsou otevřené	Lehce nádržku zatlačte tak, aby se otevřely ventily
	Vodní kámen v hydraulickém okruhu	Proveďte odvápnění, viz kap. „11. Odvápnění“

### 13. POKUD NĚCO NEFUNGUJE

PROBLÉM	PŘÍČINA	ŘEŠENÍ
V odkapávací misce (A11) je voda	Jedná se o jev související s běžným provozem vnitřních okruhů přístroje	Pravidelně vyprazdňujte a čistěte odkapávací misku (A11)
Káva espresso nevytéká	Nedostatek vody v nádržce (A15)	Naplňte nádržku
	Kontrolka  (B7) svítí, což znamená, že okruh kávy nebo okruh páry je prázdný.	Stiskněte tlačítko odpovídající kontrolce  pro naplnění okruhu.
	Filtr (C2) nebo (C3) je ucpaný	Vypláchněte filtry pod tekoucí vodou nebo proveďte vyplachování pomocí příslušného tlačítka (B5)
	Nádržka (A15) je špatně zasunutá a ventily na jejím dně nejsou otevřené	Lehce stiskněte nádržku, aby se otevřely ventily na jejím dně
	Vodní kámen v hydraulickém okruhu	Proveďte odvápnění, viz kap. „11. Odvápnění“
	Příliš jemné namletí	Vyjměte misku držák filtru (C1), zopakujte kroky pro přípravu kávy s odkazem na pokyny v odst. „4.1 Fáze 1 - Mletí (grinding) (obr. 11)“ a „4.2 Fáze 2 - Vážení (tamping) (obr. 17)“

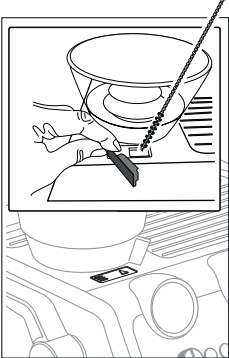

<b>PROBLÉM</b>	<b>PŘÍČINA</b>	<b>ŘEŠENÍ</b>
Držák filtru nelze nasadit k přístroji	Mletá káva nebyla napěchována nebo je jí příliš mnoho	Opakujte mletí s různými nastaveními. Snižte množství dávky: zkontrolujte, zda je filtr (C2) nebo (C3) (1 nebo 2 šálky) správný pro dávku určenou k namletí (tlačítko 2x (B3) zvoleno nebo ne)
Káva espresso vytéká z okrajů držáku filtru (C1) namísto z dírek	Držák filtru je špatně zasunutý	Umístěte správně držák filtru a otočte jím silou až na doraz
	Těsnění dávkovače kávy (A7) ztratilo pružnost nebo je znečištěné	Vyměňte těsnění dávkovače kávy v servisním středisku
	Filtr (C2) nebo (C3) je ucpaný	Vypláchněte filtry pod tekoucí vodou nebo proveďte vyplachování pomocí příslušného tlačítka (B5)
Pěna kávy je světlá (vytéká rychle z hubice)	Je nutné zkontrolovat nastavení přístroje	Vyjměte misku, zopakujte kroky pro přípravu kávy s odkazem na pokyny v odst. „4.1 Fáze 1 - Mletí (grinding) (obr. 11)“ a „4.2 Fáze 2 - Vážení (tamping) (obr. 17)“
Pěna kávy je tmavá (káva vytéká pomalu z hubice)	Je nutné zkontrolovat nastavení přístroje	Vyjměte misku držáku filtru (C1), zopakujte kroky pro přípravu kávy s odkazem na pokyny v odst. „4.1 Fáze 1 - Mletí (grinding) (obr. 11)“ a „4.2 Fáze 2 - Vážení (tamping) (obr. 17)“
Při přípravě cappuccina se systémem LatteCrema se nevytváří pěna	Mléko není dost studené	Používejte vždy mléko mající teplotu z lednice
	Kolečko (D5) není ve správné poloze	Zkontrolujte a otočte kolečko do správné polohy (☞ max pěny; ☞ med pěny; ☞ min pěny)
	Systém LatteCrema je špinavý	Proveďte čištění, jak je znázorněno v odstavci „8.6 Čištění systému LatteCrema“
	Vodní kámen v hydraulickém okruhu	Proveďte odvápnění, viz kap. „11. Odvápnění“
Na konci odvápnění přístroj vyžaduje další vyplachování	Během cyklu vyplachování nebyla nádržka naplněna až po úroveň MAX	Zopakujte vyplachování (viz kap. „11. Odvápnění“)
		→

PROBLÉM	PŘÍČINA	ŘEŠENÍ
Přístroj nemele kávu	<p>Uvnitř mlýnku na kávu je cizí těleso</p>	<p>Provedte čištění mlecích kamenů, jak je označeno v odst. „8.3 Čištění mlecích kamenů“, přičemž se ujistěte, že jste odstranili všechna zrna ze zásobníku na kávová zrna (A2) před jeho vyjmutím. Před opětovným vložením mlecího kamene opatrně vysajte veškeré zbytky z jeho uložení</p>
	<p>Zásobník na kávová zrna (A1) není ve správné poloze</p>	<p>Zásobník je zasunut správně, když je šipka ▲ zarovnaná se symbolem ☞ a je slyšet zacvaknutí</p>
Pokud si přejete změnit kvalitu kávy	<p>Je nutné odstranit všechna zrna nacházející se v kávovaru</p>	<ul style="list-style-type: none"> <li>• Vyprázdněte zásobník na kávová zrna (A1) (provedením mletí naprázdno nebo případně zbylá zrna vysajte).</li> <li>• Připevňte misku držák filtru (C1) a proveďte mletí “naprázdno” pro uvolnění vedení kávy: připevňte držák filtru na výstup mlýnku (A18) a zarovnejte je s nápisem INSERT a otočte misku směrem doprava (obr. 22). Mletí je zahájeno, když se miska dostane do polohy CLOSE a automaticky se zastaví. Opakujte, dokud filtr nezůstane prázdný</li> <li>• Nasypete do zásobníku (A1) nový typ kávových zrn</li> <li>• Pokud během mletí není dosažena „dokonalá dávka“, postupujte jako při prvním použití</li> </ul>
Po mletí je kávový filtr (C2) nebo (C3) prázdný	<p>Skuzl kávy mlýnku je ucpaný</p>	<p>Provedte čištění, jak je označeno v odst. „8.5 Čištění “Smart tamping station”“. Pokud problém přetrvává, přistupte ke žlábků otevřením příslušných dvířek (A19) a uvolněte jej pomocí kartáčku</p> 
Po umletí je ve filtru nadměrné množství kávového prášku		

<b>PROBLÉM</b>	<b>PŘÍČINA</b>	<b>ŘEŠENÍ</b>
Po namletí kávový prášek ve filtru (C2) nebo (C3) nedosáhne „dokonalou dávku“	"Smart Tamping Station" potřebuje vyčistit	Provedte čištění, jak je označeno v odst. „8.5 Čištění“Smart tamping station“, poté mletí zopakujte
	Množství mleté kávy musí být upraveno	Nastavte množství pomocí příslušného knoflíku (B2) podle pokynů v odst. „Dokonalá dávka“. Pokud je knoflík již v poloze max, postupujte podle pokynů v části „Extra nastavení mletí“
	Časem se mlecí kameny opotřebují	Provedte výměnu mlecích kamenů, jak je uvedeno v odst. „8.4 Výměna mlecích kamenů“

Pred použitím zariadenia si vždy prečítajte bezpečnostné upozornenia.

## 1. OPIS

### 1.1 Opis spotrebiča - A

- A1. Zásobník zrnkovej kávy
- A2. Veko zásobníka zrnkovej kávy
- A3. Odkladacia plocha na šálky
- A4. Gombík pary
- A5. Hadička na vydávanie pary
- A6. Konektor pre Lattecrema System
- A7. Vydávač kávy
- A8. Mriežka na šálky na espresso
- A9. Mriežka na poháre alebo hrnčeky
- A10. Mriežka odkvapkávacej misky
- A11. Odkvapkávacia mriežka
- A12. Indikátor hladiny vody v odkvapkávacej miske
- A13. Kryt nádržky na vodu
- A14. Rukoväť na vytiahnutie nádržky na vodu
- A15. Nádržka na vodu
- A16. Úložné miesto konektora napájacieho kábla
- A17. Hlavný vypínač (ON/OFF)
- A18. Výstup kávového mlynčeka (Tamping station)
- A19. Dvierka pre vstup do sklzu kávového mlynčeka
- A20. Páka presovača

### 1.2 Opis ovládacieho panelu - B

- B1. Tlačidlo ON/Standby
- B2. Gombík nastavenia množstva mletej kávy
- B3. Tlačidlo „X2“: pre použitie filtra 2 káv
- B4. Tlačidlo „teplota kávy“
- B5. Tlačidlo „preplachovanie“
- B6. Tlačidlo „OK“: na nastavenie nápoja/potvrdenie
- B7. Tlačidlo „výdaj horúcej vody“
- B8. Tlačidlo „odvápňovanie“
- B9. Tlačidlo „My“: na osobné nastavenie dĺžky nápojov
- B10. Gombík pre voľbu funkcií
- B11. Wyświetlacz napojów:

#### Nápoje na báze kávy Espresso

- Espresso
- Americano
- Káva

#### Nápoje s mliekom

- Cappuccino
- Flat White
- Latte Macchiato

- B12. Kontrolka „čistenie mlieka“
- B13. Kontrolka „chyba zásobník zrnkovej kávy“
- B14. Kontrolka „všeobecný alarm“
- B15. Manometer

- B16. Kontrolka „nedostatok vody“
- B17. Kontrolka „prázdny zásobník zrnkovej kávy“
- B18. Kontrolka „režim úspory energie“
- B19. Displej nastavení a procesu:
  - Signalizuje, že spotrebič dokončuje prácu
  - Signalizuje nastavenie vybratej dávky kávy
  - Signalizuje nastavenie vybratej teploty kávy

### 1.3 Opis príslušenstva - C

- C1. Držiak filtra
- C2. Filter 1 šálky
- C3. Filter 2 šálok
- C4. Reakčný prúžok „Total Hardness Test“
- C5. Odvápňovač
- C6. Príslušenstvo pre odvápňovanie
- C7. Napájací kábel odstrániteľný
- C8. Kefka
- C9. Príslušenstvo na čistenie vydávača kávy
- C10. Handrička
- C11. Softballs (zmäkčovač vody)
- C12. Igła czyszczenia do lancy pary

### 1.4 Príslušenstvo na čistenie nezahnuté, odporúčané výrobcom

Viac informácií nájdete na [Delonghi.com](http://Delonghi.com).



#### Čistiace tablety

(Pozri „8.1 Čistenie vydávača kávy“)

 **Čistič**  
EAN: 8004399333307

### 1.5 Opis LatteCrema System - D

- D1. Kryt nádržky na mlieko
- D2. Konektor nádržky na mlieko
- D3. Tlačidlo uvoľnenia veka
- D4. Vydávač mlieka (s nastaviteľnou výškou)
- D5. Gombík regulácie peny
- D6. Lôžko gombíka
- D7. Nasávacia hadička na mlieko
- D8. Nádržka na mlieko

## 2. PRÍPRAVA SPOTREBIČA

Všetko príslušenstvo umyte vlažnou vodou a prostriedkom na umývanie riadu a postupujte takto:

1. Vložte odkvapkávaciu misku (A11) spolu s mriežkou na šálky (A9) a mriežkou misky (A10) (obr. 1);

2. Vytiahnite nádržku na vodu (A15) (obr. 2) a naplňte ju čerstvou čistou vodou, dbajte na to, aby ste neprekročili značku MAX (obr. 3).

3. Potom vložte nádržku naspäť.

**Pozor:** Spotrebič nikdy neuvádzajte do prevádzky bez vody v zásobníku alebo bez zásobníka.

**Poznámka:** Odporúčame vám čo najskôr vykonať nastavenie tvrdosti vody podľa postupu opísaného v kapitole „7. Menu nastavení“.

### 3. PRVÉ UVEDENIE SPOTREBIČA DO PREVÁDZKY

1. Zasuňte konektor napájacieho kábla (C7) do príslušného miesta (A16) na zadnej strane spotrebiča (obr. 4); potom zasuňte zástrčku do elektrickej zásuvky. Uistite sa, že hlavný vypínač (A17) v zadnej časti spotrebiča je v polohe I (obr. 5);
2. Pod vydávač horúcej vody (v súlade s vydávačom kávy (A7)) položte nádobu s minimálnym objemom 100 ml (obr. 6);
3. Stlačte tlačidlo (B7) vedľa kontrolky  (obr. 7): spustí sa výdaj a zastaví sa automaticky. Vyprázdňte nádobu.

Pred začatím používania spotrebiča je potrebné opláchnuť vnútorné obvody stroja. Postupujte takto:

4. Pripojte držiak filtra (C1) spolu s filtrom k spotrebiču: pre správne pripojenie zarovnajτε rukoväť držiaka filtra s „INSERT“ (obr. 8) a otočte rukoväť doprava, až kým nebude zarovnaná s polohou „CLOSE“;
5. Pod držiak filtra a k hadici vydávača pary položte nádobu (A5);
6. Stlačte tlačidlo (B5) zodpovedajúce kontrolke  (obr. 9): výdaj sa začne;
7. Po dokončení výdaja otočte gombíkom pary (A4) (obr. 10) a niekoľko sekúnd vydávajte paru, aby sa prepláchnol okruh pary: pre optimálny výdaj pary sa odporúča tento úkon zopakovať 3 alebo 4-krát. Tým sa umožní odstrániť vodu v hadici pred výdajom pary.

Spotrebič je teraz pripravený na použitie.

**Poznámka:** prepláchnutie vnútorných okruhov sa odporúča aj po dlhšej dobe nečinnosti spotrebiča.

Pri prvom použití je potrebné pripraviť 4-5 káv, až potom spotrebič začne dávať uspokojivý výsledok: osobitnú pozornosť venujte dávke mletej kávy vo filtru ((C2) alebo (C3)) (pozri pokyny v odseku „4.1 Fáza 1 - Mletie (grinding) (obr. 11)“).

Postupujte podľa pokynov v kapitole „„Perfektná dávka““.

## 4. PRÍPRAVA KÁVY

### 4.1 Fáza 1 - Mletie (grinding) (obr. 11)

1. Nasypťte zrnká do zásobníka (A1) (obr. 12). Odporúča sa nasypať iba toľko zrníek, koľko je potrebných na prípravu: takto sa vždy použije čerstvá káva;
2. Zvoľte stupeň mletia (obr. 13). Nastavenie z výroby je 5 (stredné mletie). Ak by výsledok nebol uspokojivý, nastavte úroveň podľa osobnej chuti a podľa typu kávy (nastavenie sa vykonáva počas prevádzky kávového mlynčeka).

3. Vložte jeden z kávových filtrov (C2) alebo (C3) do držiaka filtra (C1) (obr. 14). Ak sa použije filter na 2 šálky, stlačte tlačidlo 2X (B3): touto voľbou sa zdvojnásobí aj vydaný počet kávy espresso.
4. Nastavte gombík množstva (B2) začínajúc od minimálnej polohy (obr. 15).

#### Poznámka:



Čísla zobrazené na displeji (B19) sú referenciou, ktorú si poznamenajte, keď dosiahnete správnu úroveň v držiaku filtra.

Nezodpovedajú nastaveniam mletia, hmotnosti namletej kávy (g/oz), ani dobe mletia.

Odkazujeme na odsek „B3. Tlačidlo „X2“: pre použitie filtra 2 káv“ pre ďalšie údaje.

5. Upevnite držiak filtra na výstup z kávového mlynčeka (A18) a zarovnajτε ho s nápisom INSERT: potom otočte držiak doprava (obr. 16). Mletie sa spustí, keď sa držiak dostane do polohy CLOSE, a automaticky sa zastaví.

### Nastavenie množstva mletej kávy vo filtru

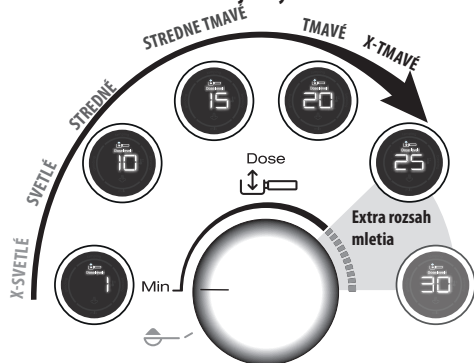

Každý typ zrníek dá počas mletia iný výsledok a z tohto dôvodu sa na začiatku nastavenia dávky vyžaduje mimoriadna pozornosť. Táto ilustrácia poskytuje informácie o tom, ako nastaviť dávku, na základe farby praženia: musí sa brať do úvahy východiskový bod, ale môže sa meniť na základe zloženia zrníek kávy.

1. Dávku nastavujte z minimálnej polohy.
2. Odkazujúc na farbu praženia vašej kávy, gombíkom pomaly otáčajte.

### 4.2 Fáza 2 - Presovanie (tamping) (obr. 17)

1. Po namletí znížte presovaciu páku (A20) až na doraz (neodoberte držiak filtra) (obr. 18). Pre dokonalý výsledok zopakujte 2-krát.
2. Páku držte zníženú až na doraz počas odoberania držiaka filtra (obr. 19). Potom páku uveďte do počiatočnej polohy.

- Po overení, či dávka kávy je správna (pozri „Perfektná dávka“), pripojte držiak kávy k vydávaču kávy (A7) (obr. 20).

### „Perfektná dávka“

- Filtre kávy majú vnútorné označenie na identifikáciu perfektnej dávky.



Laserové označenie

Reliéfové označenie

- Filtre s laserovým označením: perfektná dávka zodpovedá hornej čiare označenia;
- Filtre s reliéfovým označením: perfektná dávka zodpovedá čiare v reliéfe;
- Uistite sa, či káva je po presovaní správne zarovnaná. Mohlo by byť potrebné viackrát nastaviť gombík (B2), kým sa nedostanete k perfektnej dávke.
- Ak je káva pre-alebo podextrahovaná a dávka je v rámci perfektnej dávky, nastavte jemnejší alebo hrubší stupeň mletia (pozri „4.1 Fáza 1 - Mletie (grinding) (obr. 11)“). Ak je káva preextrahovaná (príliš pomalý výdaj), mletie bude musieť byť hrubšie. Ak je káva podextrahovaná (príliš rýchly výdaj), mletie bude musieť byť jemnejšie.
- Barista odporúča:** Vytiahnite držiak filtra, kým je páka presovača (A20) znížená, aby ste dosiahli perfektnú povrchovú úpravu dávky kávy.

### 4.3 Fáza 3 - Výdaj (brewing) (obr. 21)

- Zvoľte požadovaný nápoj (obr. 22).
- Stlačte OK (B6) pre spustenie výdaja (obr. 23) (predvylúhovanie a vylúhovanie). Výdaj sa zastaví automaticky.

## 5. PRÍPRAVA NÁPOJOV S MLIEKOM

### 5.1 Napeňte mlieko (obr. 24)

- Do nádržky na mlieko (D8) nalejte množstvo mlieka, ktoré chcete zohriať/napeňiť, pričom berte do úvahy, že objem mlieka sa zdvoji- až strojnásobí (obr. 25). Aby ste získali hustejšiu a homogénnejšiu penu, odporúča sa používať plnotučné kravské mlieko s teplotou z chladničky (približne 5 °C).

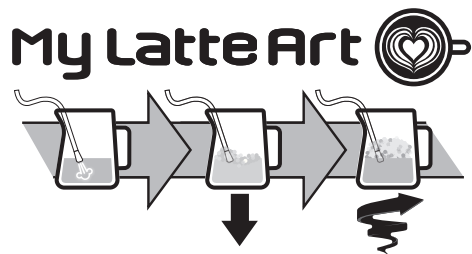

- Pre napenenie mlieka priložte hadičku vydávača pary (A5) na povrch mlieka: tým sa vzduch vmieša do mlieka a do pary.
- Vydávač pary ponechajte na povrchu, pričom dávajte pozor, aby ste nezachytili príliš veľa vzduchu, čím by sa vytvorili príliš veľké bubliny.
- Vydávač pary ponorte pod povrch mlieka: takto sa vytvorí vír. Po dosiahnutí požadovanej teploty zatvorte gombík pary a počkajte, kým sa výdaj pary úplne neskončí, až potom odoberte kanvicu na mlieko.

### Barista odporúča:

- Čerstvé mlieko je najlepšie.** Vždy používajte čerstvé mlieko s teplotou, ktorú má v chladničke.
- Plnotučné mlieko zaisťuje najlepšie výsledky. Výsledok a textúra peny sa menia podľa použitého kravského mlieka alebo rastlinných nápojov.
- Po napnení mlieka odstráňte bubliny potrasením kanvice na mlieko.

### Čistenie vydávača pary:

- Po každom použití handričkou odstráňte zvyšky mlieka z vydávača pary (obr. 26). V prípade hĺbkového čistenia sa odporúča použiť Eco MultiClean: zabezpečí hygienu odstránením mliečnej bielkoviny a tukov a môže sa použiť na vyčistenie celého spotrebiča.
- Niekoľko sekúnd vydávajte paru na dobré vyčistenie vydávača (obr. 10).
- Poczekajte na ostygnutie dozovníka: aby zagwarantovať skutočnosť dozovníka, užijte igly do czyszczenia (C12), aby 3 otwory były wolne (rys. 27).

### 5.2 Príprava nápojov s mliekom s LatteCrema System (obr. 28)

- Do nádržky na mlieko (D8) nalejte mlieko s teplotou, ktorú má v chladničke (5 °C) (obr. 29).
- Zatvorte veko (D1) (obr. 30).
- Gombík regulácie peny (D5) otočte do požadovanej polohy (obr. 31).

Poloha gombíka regulácie peny				
CLEAN				INSERT
Čistenie po každom použití	Pena MAX	Pena STRED	Pena MIN	Na vytiahnutie alebo zasunutie gombíka

- Nádržku na mlieko pripevnite k spotrebiču (obr. 32).
- Príprava perfektnej dávky (pozri „4.1 Fáza 1 - Mletie (grinding) (obr. 11)“ a „4.2 Fáza 2 - Presovanie (tamping) (obr. 17)“) a zasunutie držiaka filtra.



6. Zvoľte požadovaný nápoj s mliekom (obr. 33).



Nápoj	Espresso	Mlieko	Pena	Množstvo (ml)	X2 (ml)
Cappuccino	1	✓	✓	≈150	≈230
Latte Macchiato	1	✓	✗	≈150	≈230
Flat White	1	✓	✓	≈250	≈330

- **Nápoje s dvojitou dávkou (2x):** Do nádržky (D8) nalejte množstvo mlieka potrebné na prípravu, pričom dajte pozor, aby ste nepresiahli rysku MAX (obr. 25). Každý zárez na nádržke zodpovedá ≈100 ml mlieka.
  - **Čerstvé mlieko je najlepšie.** Vždy používajte čerstvé mlieko s teplotou, ktorú má v chladničke.
7. Stlačte OK (B6) pre výdaj (obr. 23). Spotrebič automaticky postupne vydá kávu a mlieko.

### Čistenie Lattecrema System po každom použití:

1. Nádržku na mlieko nechajte pripojenú k spotrebiču (nie je potrebné ju vyprázdniť). Podložte nádobu pod hadičku výdaja mlieka (D4) (obr. 34).
2. Gombík (D5) otočte na „Clean“ (obr. 35).

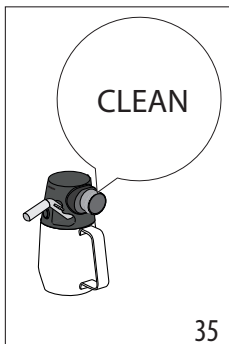
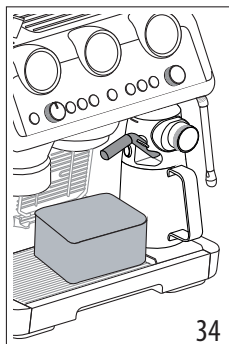

3. Čistenie sa začne a automaticky sa preruší. Pozor: po dokončení čistenia otočte gombík do jednej z polôh regulácie peny.

4. Odoberte nádržku na mlieko a odložte ju do chladničky: odporúča sa v krátkom čase použiť zvyšné mlieko.

V prípade hĺbkového čistenia sa odporúča použiť Eco MultiClean: zabezpečí hygienu odstránením mliečnej bielkoviny a tukov a môže sa použiť na vyčistenie celého spotrebiča.

## 6. PRISPÔBOBENIE DĹŽKY KÁVOVÝCH NÁPOJOV POMOCOU TLAČIDLA (my) (B9)

1. Pripravte spotrebič na výdaj 1 alebo 2 šálok kávového nápoja, ktorý chcete pripraviť, a to až do bodu pripojenia držiaka filtra (C1) spolu s filtrom (C2) alebo (C3) a mletou kávou. Ak chcete naprogramovať nápoj s mliekom, pripojte Lattecrema System k spotrebiču.
  2. Otočte gombík (B10) pre voľbu nápoja na naprogramovanie.
  3. Stlačte tlačidlo (my): kontrolka zodpovedajúca tlačidlu OK (B6) sa zapne napevno a kontrolka zodpovedajúca tlačidlu (my) bliká.
  4. Stlačte tlačidlo na spustenie výdaja. Kontrolky zodpovedajúce tlačidlám OK a (my) blikajú.
  5. Po dosiahnutí požadovaného množstva stlačte OK. Ak si nápoj vyžaduje výdaj ďalšej ingrediencie, najprv sa začne jej výdaj: po dosiahnutí požadovaného množstva stlačte OK.
  6. Stlačte tlačidlo (my) pre uloženie. Spotrebič je pripravený na nové použitie a kontrolka (my) zostane zapnutá.
- Ak nechcete uložiť naprogramovanie, stlačte ľubovoľné iné tlačidlo.

### Poznámka:

- *Môžu sa naprogramovať kávové nápoje, ale nie výdaj pary a horúcej vody.*
- *Naprogramovaním sa zmenia množstvá nápojov, ale nie namletej kávy.*
- *Nápoje „X2“ sa môžu naprogramovať samostatne.*
- **My LatteArt**  nie je programovateľný.
- **Pre návrat na nastavenia z výroby podržte stlačené tlačidlo (my) až do vypnutia. Zvolený nápoj sa vráti na množstvo z výroby.**

Kávový recept	Množstvo z výroby	Naprogramovateľné množstvo
 Espresso	35 ml	od 25 do 90 ml
 Espresso X2	70 ml	od 50 do 180 ml
 Coffee	80 ml	od 50 do 120 ml
 Coffee X2	160 ml	od 120 do 240 ml

Kávový recept	Množstvo z výroby	Naprogramovateľné množstvo
Americano	120 ml	<ul style="list-style-type: none"> <li>espresso: od 25 do 60ml</li> <li>voda: od 25 do 120 ml</li> </ul>
X2	240 ml	<ul style="list-style-type: none"> <li>espresso: od 50 do 120 ml</li> <li>voda: od 50 do 240 ml</li> </ul>

## 7. MENU NASTAVENÍ

1. Vstúpte do menu:		
Súčasne stlačte na 5 sekúnd	x2	
2. Zvoľte nastavenie na naprogramovanie:		
Nápoj	Zodpovedajúce nastavenie	Regulácie
Espresso	Úspora energie	→ <b>Aktivna</b>
		→ <b>Vypnutá</b>
Coffee	Automatické vypnutie	→ <b>9 minút</b>
		→ <b>1,5 hodiny</b>
		→ <b>3 hodiny</b>
Cappuccino	Signálny tón	→ <b>Aktivna</b>
		→ <b>Vypnutá</b>
Latte	Nastavenie extra mletia	→ <b>Rozsah 1</b>
		→ <b>Rozsah 2</b>
Flat White	Hodnoty z výroby	Podržte stlačené aspoň na 5 sekúnd tlačidlo OK, kým kontrolka nezostane zapnutá napevno
→		

Americano	Tvrdosť vody	→ <b>mäkká</b>
		→ <b>stredne tvrdá</b>
		→ <b>tvrdá/velmi tvrdá</b>
3. Nové nastavenia uložte stlačením ON/Standby (B1)		

## 8. ČISTENIE SPOTREBIČA

### Pozor!

- Na čistenie spotrebiča nepoužívajte rozpúšťadlá, drsné čistiace prostriedky, ani alkohol.
- Na odstraňovanie vodného kameňa alebo kávových usadenín nikdy nepoužívajte kovové predmety, pretože by tak mohlo dôjsť k poškrabaniu kovového alebo plastového povrchu.
- V prípade obdobia nepoužívania dlhších ako jeden týždeň sa odporúča, pred použitím spotrebiča, vykonať preplachovanie.

### Nebezpečenstvo!

- Počas čistenia nikdy neponárajte spotrebič do vody, je to elektrické zariadenie.
- Pred akýmkoľvek čistením vonkajších častí spotrebiča spotrebič najskôr vypnite, odpojte zástrčku od zásuvky a nechajte ho vychladnúť.

	×	✓	✓	×	×
	✓	×	×	✓	✓
	×	×	×	✓	✓
→					

	×	×	×	✓
	×	×	✓	×
	×	×	×	✓
	✓	✓	×	✓

### 8.1 Čistenie vydávača kávy

Keď sa kontrolka zapne (oranžová) (B5), je potrebné vykonať čistenie okruhu kávy. Pre vykonanie cyklu čistenia si kúpte tablety na čistenie kávovaru. Viac informácií nájdete na [www.Delonghi.com](http://www.Delonghi.com).

1. Vložte filter 1 šálky (C2) do držiaka filtra (C1) (obr. 36).
2. Do filtra vložte čistiace príslušenstvo (C9) (obr. 36) a zatlačte ho až na doraz.

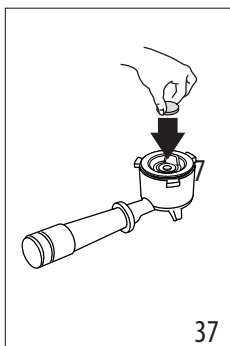
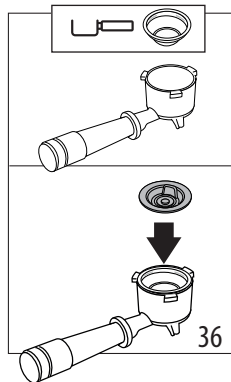

3. Na príslušenstvo položte tabletu na čistenie (obr. 37).
  4. Držiak filtra pripievňte k vydávaču kávy (A7).
  5. Naplňte nádržku na vodu (A15). Uistite sa, či odkvapkávacia miska (A11) je prázdna.
  6. Podržte stlačené tlačidlo , kým príslušná kontrolka nezačne blikať (oranžová). Po niekoľkých minútach sa čistenie automaticky preruší.
- Vyberte držiak filtra a čistiace príslušenstvo.
  - Držiak filtra a filter umyte pod tečúcou vodou.

- Znovu založte držiak filtra a vykonajte preplachovanie stlačením tlačidla (B5); odporúča sa pod držiak filtra položiť nádobu.
- Odoberte a vyprázdnite odkvapkávaciu misku.

#### Poznámka:

Tento cyklus čistenia sa môže spustiť kedykoľvek stlačením tlačidla (B5) na niekoľko sekúnd. Úkon zrušíte stlačením tlačidla na 10 sekúnd.

### 8.2 Vyčistite uloženie zásobníka zrnkovej kávy

1. Uistite sa, či zásobník zrnkovej kávy (A1) je prázdny. Eventuálne vykonajte niekoľko mletí naprázdno, aby ste ho vyprázdnili.
2. Odpojte zásobník otáčaním proti smeru otáčania hodinových ručičiek a vytiahnite ho zo spotrebiča (obr. 38)

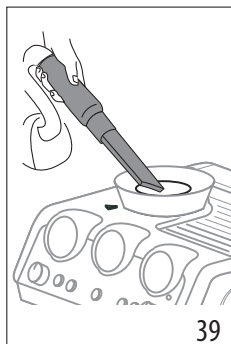
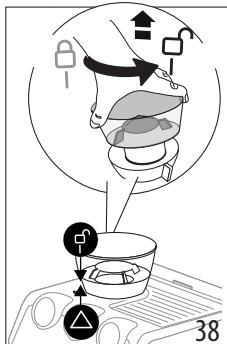

3. Zvyšky kávy povysávajújte (obr. 39).
4. Vlhkou handričkou vyčistite lôžko zásobníka zrnkovej kávy a osušte (obr. 40);

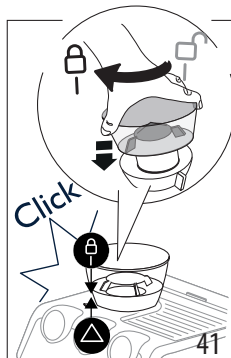
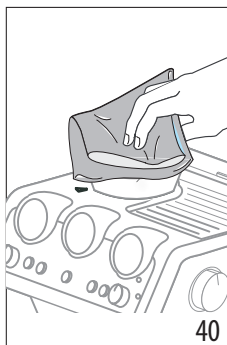

5. Zásobník znovuzaložte vložením do kávového mlynčeka. Zásobník je založený správne, keď šípka ▲ je zarovnaná so symbolom ☐ a budete počuť „zakliknutie“ (obr. 41).

### 8.3 Čistenie mlynčekov

Keď čistíte zásobník zrnkovej kávy (A1), vyčistite lôžko zásobníka a hornú mlynček vlhkou handričkou. Pre odobratie a výmenu mlynčekov sa obráťte na asistenčné centrum.

Je možné odobrať mlynček v prípade, ak by kávový mlynček bol zablokovaný cudzím telesom. Ak by k tomuto došlo, odoberte zásobník zrnkovej kávy a postupujte nasledujúcim spôsobom:

1. Pripevnite držiak filtra (C1) a vykonajte mletie „naprázdno“, aby sa uvoľnilo vedenie pre kávu.
2. Spotrebič vypnite.
3. Regulátor mletia otočte v smere doľava úplne na doraz do polohy „REMOVE“ (obr. 42).

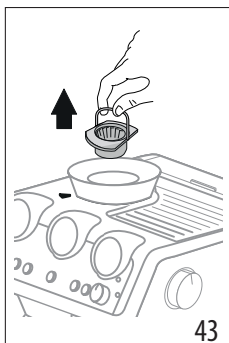
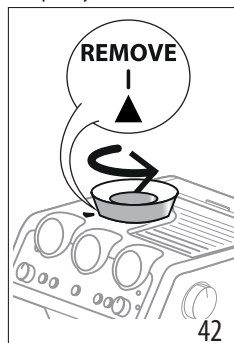

4. Vytiahnite hornú časť mlynčeka, pričom ju chyťte za príslušnú rukoväť (obr. 43).
5. Mlynček vyčistíte štetcom (obr. 44) a vysávačom povysávajúce zvyšky kávy (obr. 39).

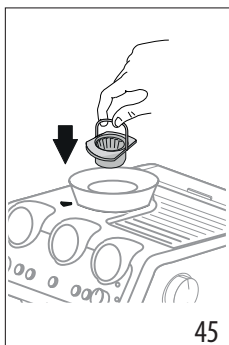
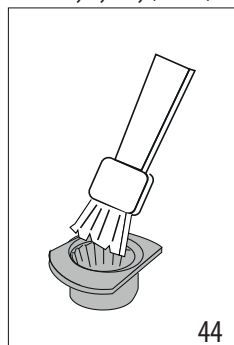

6. mlynček uložte na jeho miesto (obr. 45);
7. otočte gombík a vyberte požadovaný stupeň mletia (obr. 13);

potiahnutím za rukoväť overte, či je mlynček dobre zasunutý: je správne vložený, ak sa nehýbe;

#### 8.4 Výmena mlynčekov

Keď sa množstvo namletej kávy ešte zníži, obráťte sa na asistenčné centrum za účelom výmeny mlynčekov: potom kávový mlynček znovu nastavte po vstupe do menu nastavení („7. Menu nastavení“) a zvolte prvý rozsah extra nastavenia mletia. Potom otočte gombík nastavenia množstva (B2) do polohy MIN a nastavte dávku ako pri prvom použití (pozri „Perfektná dávka“).

#### 8.5 Čistenie „Smart tamping station“

1. Vyčistite oblasť uchytania štetcom (obr. 46).
2. Potiahnite páku (A20) až na doraz a štetec vyčistite presovač (obr. 47), potom páku uvoľnite.
3. Pomocou kefy (C8) vyčistíte sklz kávy (obr. 48).

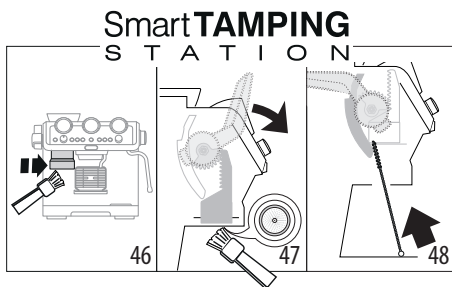

#### 8.6 Čistenie LatteCrema System

V umývačke riadu umyte všetky komponenty a nádržku, umiestnite ich však na horný košík umývačky. Ak nemáte umývačku, umyte ich ručne podľa postupu uvedeného v poznámke na konci odseku.

1. Stlačte tlačidlo (D3) a zdvihnite veko nádržky na mlieko (D1);
2. jemne vytiahnite vydávač mlieka (D4) a nasávaciu hadičku ((D7) (obr. 49);

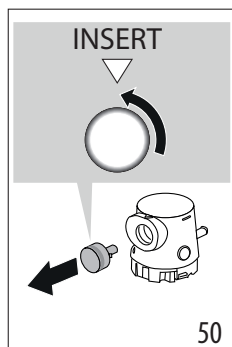
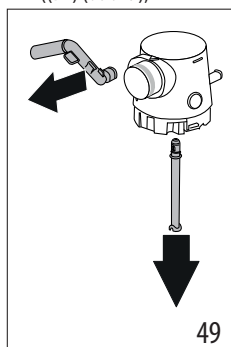

3. Gombík otočte do polohy „Insert“ a vytiahnite ho (obr. 50);
4. Venujte osobitnú pozornosť tomu, aby na drážke a kanáliku nachádzajúcom sa pod gombíkom (obr. 51) nezostali zvyšky mlieka: eventuálne vyškrabte kanálik špáradlom;

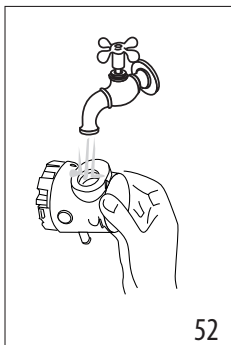
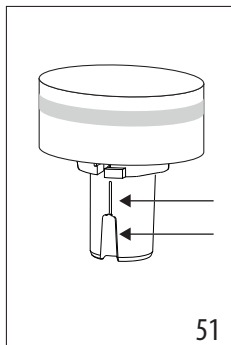

- Opláchnite vnútro umiestnenia gombíka regulácie peny pod tečúcou vodou (obr. 52).
- Skontrolujte, či nasávací hadička na mlieko a hadička na výdaj neostali upchané zvyškami mlieka;
- Zložte späť všetky diely veka;
- Nádržku na mlieko starostlivo umyte a vypláchnite (D8) ;
- k nádržke na mlieko pripevnite veko.

**Poznámka: ručné umývanie**

Umývanie v umývačke riadu zaistí perfektnú hygienu všetkých komponentov nádržky na mlieko: v prípade ručného umývania dôkladne umyte všetky komponenty nádržky na mlieko horúcou vodou a ponorte ich do vaničky alebo misy s horúcou vodou a nechajte ich tam približne 30 minút, potom postupujte podľa pokynov uvedených v bode 4.

**9. TVRDOŠŤ VODY**

Kontrolka odvápnenia (B8) sa zapne po stanovenej dobe použitia, ktorá závisí od tvrdosti vody. Spotrebič môžete naprogramovať v závislosti od skutočnej tvrdosti vody používanej v rôznych regiónoch a znížiť tak frekvenciu odvápnovania.

- Vytiahnite z obalu testovací prúžok „TOTAL HARDNESS TEST“ (C4).
- Úplne ponorte prúžok do pohára vody asi na jednu sekundu.
- Vytiahnite prúžok z vody a zľahka ním zatrasť. Spotrebič nastavte podľa pokynov uvedených v kapitole „7. Menu nastavení“.

Výsledok testu tvrdosti vody	Tlačidlo	Úroveň
	x2	1 sladká voda
		2 stredne tvrdá voda
	OK	3 tvrdá alebo veľmi tvrdá voda

- Spotrebič nastavte podľa pokynov uvedených v kapitole „7. Menu nastavení“.

**10. AKO POUŽÍVAŤ SOFTBALLS**

Softballs (C11) je inovatívny systém, ktorý predlžuje životnosť spotrebiča bez zmeny vlastností vody, pričom sa garantuje výdaj krémovej a aromatickej kávy. Pre optimalizáciu účinnosti nechajte Softballs vo vode na celú noc pred použitím.

- Balík Softballs vyťahnite z obalu (obr. 53).

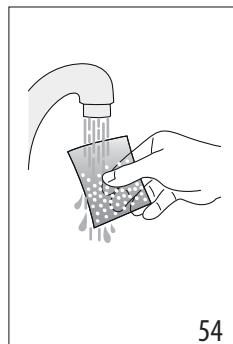
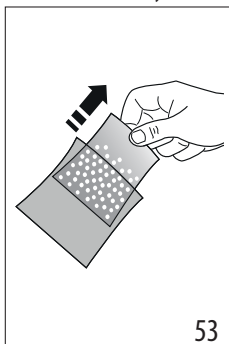

- Balík Softballs prepláchnite pod tečúcou vodou (obr. 54).
- Vrecko ponorte do nádržky na vodu (A15) (obr. 55).

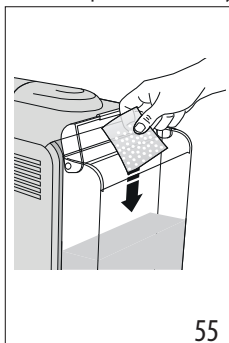

- Vrecko Softballs vymeňte každé 3 mesiace (obr. 56).

**11. ODVÁPŇOVANIE**

**Pozor!**

- Pre použitím si prečítajte pokyny a štítko na obale prípravku na odvápnenie (C5).
- Odporúča sa používať výhradne odvápnovacie prípravky rovnako ako nesprávne vykonané odvápnovanie môžu viesť k ťažkostiam, na ktoré sa nevzťahuje záruka výrobcu.
- Odvápňovač môže poškodiť jemné plochy. Ak sa prípravok náhodne prevráti, okamžite osušte.

Pre vykonanie odvápnovania	
Odvápňovač	Odvápňovač De'Longhi

Pre vykonanie odvápnovania	
Nádoby	2 s objemom 1 liter každá
Čas	~40 min

1. (AK SA NACHÁDZA, ODOBERTE ZMÄKČOVACÍ FILTER A SOFTBALLS). Do nádrčky na vodu (A15) nalejte odvápnovač až po rysku **A** (zodpovedá 100 ml baleniu) vytlačenú na vnútornej strane nádrčky (obr. 57).

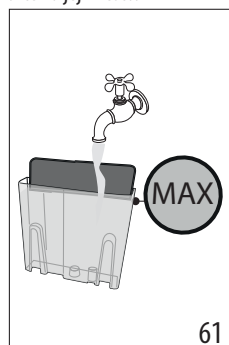
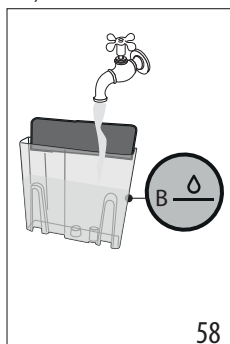
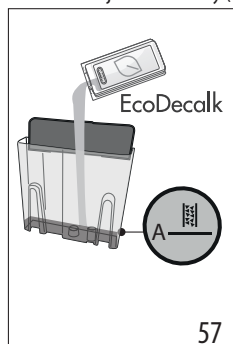

2. Pridávajte vodu, kým nedosiahnete rysku **B** (obr. 58). Potom nádrčku na vodu znovu zasuňte do spotrebiča.
3. Pripojte príslušenstvo (C6) ku konektoru pre LatteCrema System (A6) (obr. 59).

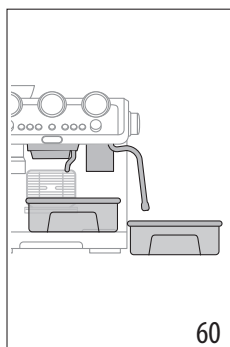
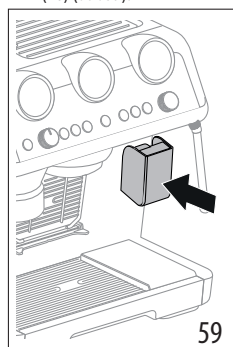

4. Uistite sa, či držiak filtra (C1) nie je pripevnený a pod vydávacie kávy a horúcej vody (A7) a pod vydávacie pary (A5) umiestnite nádobu (obr. 60).
5. Podržte stlačené tlačidlo **(B8)**, kým zodpovedajúca kontrolka nezačne blikať.
6. Program odvápnovania sa spustí a odvápnovacia tekutina vytečká z vydáváčov. Program odvápnovania automaticky vykonáva celú sériu preplachovaní s prestávkami, aby sa odstránili usadeniny vodného kameňa vnútri kávovaru, až do vyprázdnenia nádrže.

Výdaj sa preruší a kontrolka **(B8)** zmení farbu na bielu. Potom je potrebné vykonať preplachovací cyklus:











7. Vyprázdňte nádobu, ktorú ste používali na zber odvápnovacej tekutiny, a umiestnite ju pod vydávacie.
8. Vyberte nádrčku na vodu, vyprázdňte z nej všetky zvyšky odvápnovacieho roztoku, opláchnite ju tečúcou vodou a naplňte ju čerstvou vodou až do úrovne MAX (obr. 61). Potom nádrčku vložte na jej miesto.











9. Podržte stlačené tlačidlo **(B8)**, kým zodpovedajúca kontrolka nezačne blikať; preplachovanie sa spustí.
10. Po dokončení preplachovania sa výdaj preruší a spotrebič je pripravený na použitie.
11. Vyprázdňte oplachovú vodu zo zberných nádob.
12. Vyberte a vyprázdňte odkvapkávaciu misku a potom ju znova vložte.
13. Vyberte a naplňte nádrčku čerstvou vodou a znovu ju vložte. Spotrebič je tak pripravený na použitie.

#### Poznámka:

- Ak chcete anticipovať odvápnovací cyklus, podržte tlačidlo **(B8)** stlačené na 3 sekundy.
- V prípade, ak sa odvápnovanie spustilo omylom, stlačte tlačidlo **(B8)** na 10 sekúnd; preplachovanie sa nemôže prerušiť.

## 12. VÝZNAM KONTROLIEK



KONTROLKY	VÝZNAM KONTROLIEK	ÚKON
Všetky kontrolky krátko zablikajú	Zapnutie spotrebiča	Automatická diagnostika
 pevná	Je to prvé zapnutie spotrebiča a je potrebné naplniť vodný okruh	Postupujte podľa pokynov v kap. „3. Prvé uvedenie spotrebiča do prevádzky“
 pevná	Funkcia úspory energie je aktívna	Odkazujeme na kap. „7. Menu nastavení“, ak chcete deaktivovať funkciu
 pevná	Zásobník zrnkovej kávy (A1) je prázdny	Naplňte zásobník zrnkovej kávy
 bliká	Chcete vykonať mletie, ale zásobník zrnkovej kávy (A1) je prázdny	Naplňte zásobník zrnkovej kávy
 on	Hladina vody v nádržke (A15) nie je dostatočná alebo nádržka na vodu nie je vložená správne	Naplňte nádržku alebo vyberte a znova správne vložte nádržku
 bliká	Chcete vykonať prípravu nápoja, ale nádržka na vodu (A15) je prázdna	Nádržku naplňte vodou
 pevná	Všeobecný alarm	Obráťte sa na asistenčné centrum
 pevná	Zásobník zrnkovej kávy nie je založený	Zásobník zrnkovej kávy založte správne (A1) alebo overte, či je správne založený
 bliká	Volič, v základe zásobníka zrnkovej kávy (A1), nie je v správnej polohe	Volič uveďte do jednej z polôh mletia (medzi 1 a 8), nezabudnite: <ul style="list-style-type: none"> <li>Mletie nastavte, kým je kávový mlynček v prevádzke</li> <li>Nastavte zakaždým o jednu úroveň a urobte aspoň 5 mletí medzi jedným a druhým nastavením</li> </ul>
	Zásobník zrnkovej kávy (A1) nie je úplne založený: zásah bezpečnostného zariadenia	Overte, či zásobník zrnkovej kávy je správne založený
 pevná	LatteCrema System musíte vyčistiť po každom použití	Po dokončení príprav s mliekom vykonajte automatické čistenie otočením gombíka (D5) na Clean
 pevná	Spotrebič je pripravený na výdaj pary.	Spotrebič dosiahol teplotu na výdaj pary. Ak chcete vykonať výdaj, otočte rukoväť pary (A4)
→		

KONTROLKY	VÝZNAM KONTROLIEK	ÚKON
 bliká	Spotrebič je zapnutý a funkcia úspory energie je aktívna: gombík pary (A4) je v polohe výdaja pary	Kontrolka bliká, čo znamená, že spotrebič sa pripravuje na výdaj pary: výdaj sa spustí, akonáhle spotrebič dosiahne príslušnú teplotu
	Spotrebič je pripravený na výdaj pary	Spotrebič dosiahol príslušnú teplotu na prípravu pary, keď kontrolka zostane pevná
	Spotrebič vydáva paru	
 pevná (oranžová)	Je potrebné vykonať odvápnovanie	Vykonajte odvápnenie podľa pokynov v kap. „11. Odvápnovanie“
 blikajúca (oranžová)	Spotrebič vykonáva odvápnovanie	Pokračujte v dokončení operácie podľa pokynov v kap. „11. Odvápnovanie“
 pevná (biela)	Je potrebné vykonať preplachovanie	
 blikajúca (biela)	Spotrebič vykonáva preplachovanie	
 pevná (oranžová)	Je potrebné vykonať čistenie vydávača kávy	Pozri ods. „8.1 Čistenie vydávača kávy“
 blikajúca (oranžová)	Spotrebič vykonáva čistenie vydávača kávy	
 blikajúca (biela)	Spotrebič vykonáva preplachovanie	
 +  blikajúca	Ak je v spotrebiči zmäčkový filter, do okruhu by sa mohla dostať vzduchová bublina, ktorá bráni výdaju	Stlačte tlačidlo (B7) vedľa kontrolky  : spustí sa výdaj a zastaví sa automaticky.
	Kávový mlynček melie príliš jemne, a preto káva vyteká veľmi pomaly alebo nevyteká vôbec.	Vyberte držiak filtra (C1), zopakujte operácie prípravy kávy, riadte sa pritom pokynmi v ods. „4.1 Fáza 1 - Mletie (grinding) (obr. 11)“ a „4.2 Fáza 2 - Presovanie (tamping) (obr. 17)“
	Kávový filter (C2) alebo (C3) je upchatý	Filtre prepláchnite pod tečúcou vodou alebo vykonajte preplachovanie tlačidlom preplachovania (B5).
	Nádržka (A15) je nesprávne vložená a príslušné ventily nie sú otvorené	Jemne stlačte nádržku tak, aby sa ventily otvorili
	Vodný kameň vnútri hydraulického obvodu	Vykonajte odvápnenie podľa kapitoly „11. Odvápnovanie“

### 13. AK NIČO NEFUNGUJE

PROBLÉM	PRÍČINA	RIEŠENIE
V odkvapkávacej miske je voda (A11)	Tvorí súčasť normálnej prevádzky z vnútorných okruhov spotrebiča	Odkvapkávaciu misku pravidelne vyprázdňte a vyčistíte (A11)
		→



PROBLÉM	PRÍČINA	RIEŠENIE
Nevyteká káva espresso	Nedostatok vody v zásobníku (A15)	Nádržku naplňte
	Kontrolka  (B7) svieti, čím signalizuje, že okruh kávy alebo okruh pary je prázdny.	Stlačte tlačidlo zodpovedajúce kontrolke  pre doplnenie okruhu.
	Filter (C2) alebo (C3) je upchatý	Filtre prepláchnite pod tečúcou vodou alebo vykonajte preplachovanie príslušným tlačidlom (B5)
	Nádržka (A15) je nesprávne vložená a ventily na jej spodnej časti nie sú otvorené	Jemne stlačte nádržku tak, aby sa ventily na jej spodnej časti otvorili.
	Vodný kameň vnútri hydraulického obvodu	Vykonajte odvápnenie podľa kapitoly „11. Odváňovanie“
	Mletie príliš jemné	Vyberte držiak filtra (C1), zopakujte operácie prípravy kávy, riadte sa pritom pokynmi v ods. „4.1 Fáza 1 - Mletie (grinding) (obr. 11)“ a „4.2 Fáza 2 - Presovanie (tamping) (obr. 17)“
Držiak filtra sa neuchytí na spotrebič	Namletá káva nebola stlačená presovačom alebo je v nadmernom množstve	Zopakujte mletie s inými nastaveniami. Znížte množstvo dávky: overte, či filter (C2) alebo (C3) (1 alebo 2 šálok) je správny vzhľadom k dávke na pomletie (tlačidlo 2x (B3) zvolené alebo nezvolené)
Káva espresso kvapká z okrajov držiaka filtra (C1) namiesto z otvorov	Držiak filtra je vložený nesprávne	Upevnite držiak filtra správne a silne ho zatočte až na doraz
	Tesnenie vydávača kávy (A7) stratilo pružnosť alebo je špinavé	Vymeňte tesnenie vydávača kávy v asistenčnom centre
	Filter (C2) alebo (C3) je upchatý	Filtre prepláchnite pod tečúcou vodou alebo vykonajte preplachovanie zodpovedajúcim tlačidlom (B5)
Pena v káve je svetlá (káva vychádza rýchlo z ústia)	Je potrebné prehodnotiť nastavenia spotrebiča	Vyberte držiak, zopakujte operácie prípravy kávy, riadte sa pritom pokynmi v ods. „4.1 Fáza 1 - Mletie (grinding) (obr. 11)“ a „4.2 Fáza 2 - Presovanie (tamping) (obr. 17)“
Pena v káve je tmavá (káva pomaly vychádza z ústia)	Je potrebné prehodnotiť nastavenia spotrebiča	Vyberte držiak filtra (C1), zopakujte operácie prípravy kávy, riadte sa pritom pokynmi v ods. „4.1 Fáza 1 - Mletie (grinding) (obr. 11)“ a „4.2 Fáza 2 - Presovanie (tamping) (obr. 17)“
		→

PROBLÉM	PRÍČINA	RIEŠENIE
Nevytvára sa mliečna pena, kým sa pripravuje cappuccino s LatteCrema System	Mlieko nie je dostatočne studené	Vždy používajte mlieko s teplotou, ktorú má v chladničke.
	Gombík (D5) nie je v správnej polohe	Overte a otočte gombík do správnej polohy ( ☺ max. pena; ☻ stred. pena; ☹ min. pena )
	LatteCrema System je špinavý	Vykonajte čistenie podľa zobrazenia v odseku „8.6 Čistenie LatteCrema System“
	Vodný kameň vnútri hydraulického obvodu	Vykonajte odvápnenie podľa kapitoly „11. Odvápnovanie“
Po dokončení odvápnovania si spotrebič vyžaduje ďalšie preplachovanie.	Počas cyklu preplachovania nebola nádržka naplnená až po rysku MAX.	Preplachovanie zopakujte (pozri kap. „11. Odvápnovanie“)
Spotrebič nemelie kávu	Vnútri kávového mlynčeka sa nachádza cudzie teleso	Vykonajte čistenie mlynčekov podľa pokynov v ods. „8.3 Čistenie mlynčekov“ a uistite sa, že ste z neho pred odstránením zásobníka zrnkovej kávy (A2) odstránili všetky zrnká kávy. Skôr ako znovu vložíte mlynček, dôkladne povysávajte všetky zvyšky z jeho lôžka
	Zásobník zrnkovej kávy (A1) nie je v správnej polohe	Zásobník je založený správne, keď šípka ▲ je zarovnaná so symbolom ☺ a budete počuť „zakliknutie“
Ak si prajete zmeniť kvalitu kávy	Je potrebné odstrániť všetky zrnká kávy nachádzajúce sa v kávovare	<ul style="list-style-type: none"> <li>• Vyprázdnite zásobník zrnkovej kávy (A1) (vykonaním mletí naprázdno alebo prípadne vysatím zvyšných zrn).</li> <li>• Pripojte držiak filtra (C1) a vykonajte mletie „naprázdno“, aby sa uvoľnilo vedenie pre kávu: potom odpojte držiak filtra k výstupu kávového mlynčeka (A18), zarovnaj ho s nápisom INSERT a otočte držiak doprava (obr. 22). Mletie sa spustí, keď sa držiak dostane do polohy CLOSE, a automaticky sa zastaví. Opakujte, dokým filter nezostane prázdny</li> <li>• Do zásobníka (A1) nasypť novú odrodu zrnkovej kávy</li> <li>• Ak sa pri mletí nedosiahne „perfektná dávka“, postupujte ako pri prvom použití</li> </ul>
		→

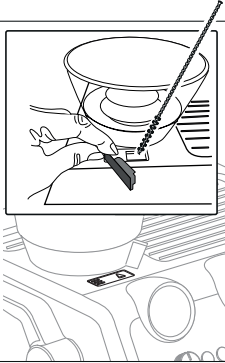
PROBLÉM	PRÍČINA	RIEŠENIE
<p>Po mletí je kávový filter (C2) alebo (C3) prázdny</p> <p>Po zomletí je množstvo kávy vo filtri prebytočné</p>	<p>Sklz kávy na kávovom mlynčeku je upchatý</p>	<p>Vykonajte čistenie podľa pokynov v ods. „8.5 Čistenie „Smart tamping station““. Ak problém pretrváva, dostaňte sa k sklzu otvorením príslušných dvierok (A19) a uvoľnite ho pomocou kefy</p> 
<p>Po mletí kávový prášok vo filtri (C2) alebo (C3) nedosahuje „perfektnú dávku“</p>	<p>Je potrebné vyčistiť „Smart Tamping Station“</p> <p>Je potrebné nastaviť množstvo mletej kávy</p> <p>Používaním sa mlynčeky opotrebojú</p>	<p>Vykonajte čistenie podľa pokynov v ods. „8.5 Čistenie „Smart tamping station““, potom zopakujte mletie</p> <p>Nastavte množstvo príslušným gombíkom (B2) podľa pokynov uvedených v ods. „„Perfektná dávka““. Ak gombík je už v polohe max, postupujte podľa pokynov uvedených v oddiele „Nastavenie extra mletia“</p> <p>Vykonajte výmenu mlynčekov podľa pokynov uvedených v ods. „8.4 Výmena mlynčekov“</p>

Przed rozpoczęciem użytkowania, należy uważnie przeczytać broszurę, w której wskazano ostrzeżenia dotyczące bezpieczeństwa.

## 1. OPIS

### 1.1 Opis urządzenia - A

- A1. Pojemnik na ziarna
- A2. Pokrywa pojemnika na ziarna
- A3. Podstawa na filiżanki
- A4. Pokrętko pary
- A5. Rurka wytwarzania pary
- A6. Łącznik do Lattecrema System
- A7. Dozownik kawy
- A8. Kratka na filiżanki espresso
- A9. Kratka na filiżanki - szklanki lub kubki
- A10. Kratka tacki
- A11. Tacka na skropliny
- A12. Wskaźnik poziomu wody w tacce na skropliny
- A13. Pokrywa zbiornika na wodę
- A14. Uchwyt wyjmowania zbiornika na wodę
- A15. Zbiornik na wodę
- A16. Gniazdo łącznika kabla zasilającego
- A17. Wyłącznik główny (ON/OFF)
- A18. Wylot młynka (Tamping station)
- A19. Otwór dostępu do prowadnika młynka do kawy
- A20. Dźwignia praski

### 1.2 Opis panelu sterowania - B

- B1. Przycisk ON/Standby
- B2. Pokrętko regulacji ilości zmielonej kawy
- B3. Przycisk „X2”: do użycia filtra a 2 kawy
- B4. Przycisk „temperatura kawy”
- B5. Przycisk „płukania”
- B6. Przycisk „OK”: przygotowanie napoju/potwierdzenie
- B7. Przycisk „wytwarzanie gorącej wody”
- B8. Przycisk „odkamenianie”
- B9. Przycisk „My”: personalizacja ilości napojów
- B10. Pokrętko wyboru funkcji
- B11. Wyświetlacz napojów

#### Napój na bazie kawy Espresso

- Espresso
- Americano
- Kawa

#### Napoje mleczne

- Cappuccino
- Flat White
- Latte Macchiato

- B12. Kontrolka „czyszczenie poj. na mleko”
- B13. Kontrolka „brak pojemnika na ziarna”
- B14. Kontrolka „ogólny alarm”

- B15. Manometr
- B16. Kontrolka „brak wody”
- B17. Kontrolka „pusty pojemnik na ziarna”
- B18. Kontrolka „oszczędność energetyczna”
- B19. Wyświetlacz ustawień i procesu:
  - Wskazuje czynność, wykonywaną przez urządzenie
  - Wskazuje ustawienie wybranej dawki kawy
  - Wskazuje ustawienie wybranej temperatura kawy

### 1.3 Opis akcesoriów - C

- C1. Łyżka uchwytu na filtr
- C2. Filtr na 1 filiżankę
- C3. Filtr na 2 filiżanki
- C4. Pasek kontrolny twardości wody „Total Hardness Test”
- C5. Odkamieniacz
- C6. Akcesorium do odkamieniania
- C7. Odłączany kabel zasilający
- C8. Wycior
- C9. Element czyszczenia dozownika kawy
- C10. Szmata
- C11. Softballs (zmiękczacze wody)
- C12. Igła czyszczenia do lancy pary

### 1.4 Akcesoria do czyszczenia nie dołączone, zalecane przez producenta

Więcej informacji na stronie [Delonghi.com](http://Delonghi.com).



#### Tabletki czyszczące

(Patrz „8.1 Czyszczenie dozownika kawy”)

 **Środek czyszczący**  
EAN: 8004399333307

### 1.5 Opis LatteCrema System - D

- D1. Pokrywa pojemnika na mleko
- D2. Złącze pojemnika na mleko
- D3. Przycisk zwalniania pokrywy
- D4. Dysza mleka (z regulowaną wysokością)
- D5. Pokrętko regulacji pianki
- D6. Gniazdo pokrętkła
- D7. Rurka zanurzana w mleku
- D8. Pojemnik na mleko

## 2. PRZYGOTOWANIE URZĄDZENIA

Wszystkie akcesoria umyć w letniej wodzie z płynem do naczyń, następnie:

1. Włożyć tackę na skropliny (A11) wraz z kratką na filiżanki (A9) i kratką tacki (A10) (rys. 1);

- Wyjąć zbiornik na wodę (A15) (rys. 2) i napełnić go zimną i czystą wodą, uważając aby nie przekroczyć napisu MAX (rys. 3).
- Ponownie włożyć zbiornik na miejsce.

**Uwaga:** *Nigdy nie włączaj urządzenia bez zbiornika lub, gdy nie ma w nim wody.*

**Zwróć uwagę:** *Zaleca się jak najszybsze ustawienie twardości wody zgodnie z procedurą opisaną w rozdziale „7. Menu ustawień”.*

### 3. PIERWSZE WŁĄCZENIE URZĄDZENIA

- Włóż łącznik kabla zasilającego (C7) do odpowiedniego gniazda (A16) znajdującego się z tyłu urządzenia (rys. 4); następnie włożyć wtyczkę do gniazdka. Upewnij się, że wyłącznik główny (A17), znajdujący się z tyłu urządzenia, jest wciśnięty na pozycji I (rys. 5);
- Pod dyszą gorącej wody (w pobliżu dozownika kawy (A7)) ustawić pojemnik o minimalnej pojemności 100 ml (rys. 6);
- Wcisnąć przycisk (B7) obok kontrolki  (rys. 7): rozpocznie się wytwarzanie wody, które zostanie przerwane automatycznie. Opróżnić pojemnik.

Przed rozpoczęciem użytkowania ekspresu, należy przepłukać jego wewnętrzne obwody. Należy postępować następująco:

- Zaczepić łyżkę uchwyty na filtr (C1) wraz z filtrem w ekspresie: w celu prawidłowego zaczepienia, wyrównać rączkę łyżki z symbolem „INSERT” (rys. 8) i przekręcić uchwyt w prawo, aż do ustawienia na pozycji „CLOSE”;
- Umieścić pojemnik pod łyżką uchwyty na filtr i rurką wytwarzania pary (A5);
- Wcisnąć przycisk (B5) obok kontrolki  (rys. 9): rozpoczyna się wytwarzanie;
- Po zakończeniu wytwarzania, przekręcić pokrętko pary (A4) (rys. 10) i przez kilka sekund wytwarzać parę, aby wypłukać obwód pary: dla idealnego wytwarzania pary, zaleca się 3 lub 4 krotnie powtórzenie takiej czynności. Umieścić wodę z rurki przed wytworzeniem pary.

Urządzenie jest gotowe do użycia.

**Zwróć uwagę:** *plukanie wewnętrznych obwodów jest zalecane również w przypadku długiego okresu niestosowania urządzenia.*

Przy pierwszym użyciu należy zaparzyć 4-5 kaw celem uzyskania zadowalającego efektu: zwrócić szczególną uwagę na dawkę kawy mielonej w filtrze ((C2) lub (C3)) (patrz instrukcję w paragrafie „4.1 Etap 1 - Mielenie (grinding) (rys. 11)”).

Postępować jak wskazano w rozdziale „Idealna dawka”.

## 4. PRZYGOTOWANIE KAWY

### 4.1 Etap 1 - Mielenie (grinding) (rys. 11)

- Wsypanie ziarna do pojemnika (A1) (rys. 12). Zaleca się wsypanie tylko niezbędnej ilości ziarna do przygotowania wybranego napoju: w ten sposób stosuje się zawsze świeżą kawę;

- Wybrać stopień zmielenia (rys. 13). Ustawienie fabryczne wynosi 5 (średni stopień zmielenia). Jeżeli wynik nie będzie zadowalający, wyregulować poziom na podstawie osobistego smaku i rodzaju kawy (regulacji należy dokonać podczas działania młynka).
- Włożyć jeden z filtrów kawy (C2) lub (C3) do uchwyty na filtr (C1) (rys. 14). Jeżeli używa się filtra na 2 filiżanki, wcisnąć przycisk 2X (B3): takim wyborem podwaja się również ilość zaparzonej espresso.
- Wyregulować pokrętko ilości (B2) poczynając od minimalnej pozycji (rys. 15).

**Zwróć uwagę:**



Po osiągnięciu prawidłowego poziomu w uchwycie na filtr, zanotować cyfry wskazywane na wyświetlaczu (B19).

Nie odpowiadają ustawieniom mielenia, wagi zmielonej kawy (gr/oz) lub czasowi mielenia.

Skonsultować paragraf „B3. Przycisk „X2”: do użycia filtra a 2 kawy” w celu uzyskania dodatkowych wskazówek.

- Zaczepić uchwyt na filtr na wylocie młynka do kawy (A18) wyrównując go z napisem INSERT: następnie przekręcić łyżkę w prawo (rys. 16). Mielenie rozpocznie się, gdy łyżka znajdzie się na pozycji CLOSE i zostanie przerwane automatycznie.

### Wyregulować ilość kawy mielonej w filtrze

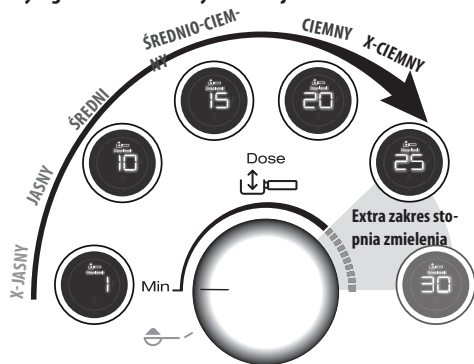

Każdy rodzaj ziaren daje inny rezultat podczas mielenia i z tego powodu, na początku regulacji dawki jest wymagana szczególna uwaga.

Ilustracja przedstawia wskazówki na temat sposobu regulacji dawki, w zależności od koloru palenia: należy je zastosować jako punkty wyjściowy, ale mogą się zmieniać w zależności od składu ziaren kawy.

- Ustawić dawkę na minimalnej pozycji.
- Odnosząc się do koloru palenia stosowanej kawy, powoli obrócić pokrętko.

## 4.2 Etap 2 - Ubijanie (tamping) (rys. 17)

1. Po zmieleniu obniżyć do końca dźwignię ubijania (A20) (nie wyjmować uchwytu na filtr) (fig. 18). Powtórzyć 2 razy dla uzyskania idealnego rezultatu.
2. Podczas wyjmowania uchwytu na filtr, utrzymywać dźwignię obniżoną do ogranicznika (fig. 19). Następnie ustawić dźwignię na pozycji wyjściowej.
3. Po upewnieniu się że dawka kawy jest prawidłowa (patrz „Idealna dawka”), zaczeplić uchwyt filtra na dozowniku kawy (A7) (rys. 20).

### „Idealna dawka”

- Filtry kawy posiadają wewnętrzne oznaczenie, określające idealną dawkę.



- Filtry z oznaczeniem laserowym: idealna dawka odpowiada górnej linii oznaczenia;
- Filtry z oznaczeniem wypukłym: idealna dawka odpowiada wypukłej linii;
- Upewnić się, że po ubiciu kawa znajduje się na poziomie. Przed uzyskaniem idealnej dawki, może się okazać konieczne kilkukrotne wyregulowanie pokrętle (B2).
- Jeżeli ekstrakcja kawy jest zbyt słaba lub zbyt mocna, a dawka znajduje się w zakresie idealnej dawki, wyregulować drobniejszy lub grubszy stopień zmielenia (patrz „4.1 Etap 1 - Mielenie (grinding) (rys. 11)”). Jeżeli ekstrakcja kawy jest zbyt mocna (wytwarzanie zbyt wolne), stopień zmielenia musi być grubszy. Jeżeli ekstrakcja kawy jest zbyt słaba (wytwarzanie zbyt szybkie), stopień zmielenia musi być drobniejszy.
- **Barman radzi:** Wyjąć uchwyt na filtr gdy dźwignia praski (A20) jest opuszczona w celu uzyskania idealnego wykończenia dawki kawy.

## 4.3 Etap 3 - Parzenie (brewing) (fig. 21)

1. Wybrać żądany napój (rys. 22).
2. Wcisnąć OK (B6), aby rozpocząć parzenie (rys. 23) (wstępne parzenie i parzenie). Wytwarzanie kawy zostanie przerwane automatycznie.

## 5. PRZYGOTOWYWANIE NAPOJÓW MLECZNYCH

### 5.1 Spienianie mleka (rys. 24)

1. Włączyć do pojemnika na mleko (D8) odpowiednią ilość, którą chce się podgrzać/spienić, pamiętając, że objętość mleka zwiększy się 2 lub 3 krotnie (rys. 25). Aby uzyskać bardziej gęstą i obfitą piankę, powinno się używać krowiego mleka z lodówki (około 5° C).

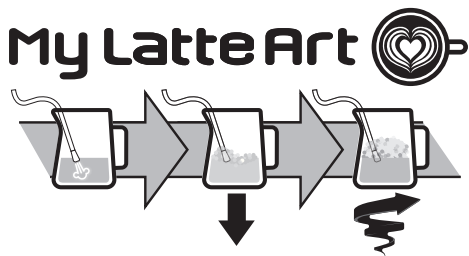

2. W celu spienienia mleka, umieścić rurkę wytwarzania pary (A5) na jego powierzchni: w ten sposób powietrze wymieszane z mlekiem i parą.
3. Utrzymywać dyszę pary a powierzchni, pamiętając aby nie wychwytywać zbyt dużo powietrza, które wytworzy duże pęcherzyki.
4. Zanurzyć dyszę pary pod powierzchnią mleka: w ten sposób wytworzy się wir. Po osiągnięciu żądanej temperatury, zamknąć pokrętko pary i przed wyjęciem dzbanka z mlekiem poczekać, aż wytwarzanie pary zostanie całkowicie przerwane.

### Barman radzi:



- **Zimne mleko jest lepsze.** Zawsze używać zimnego mleka prosto z lodówki.
- **Tłuste mleko gwarantuje idealny rezultat.** Rezultat i struktura pianki są zależne od rodzaju zastosowanego mleka krowiego lub napojów roślinnych.
- Po spienieniu mleka, usunąć pęcherzyki potrząsając dzbankiem z mlekiem.

### Czyszczenie dyszy pary:

1. Po każdym użyciu, usunąć resztki mleka z dyszy pary (rys. 26) za pomocą szmatki. W celu dogłębnego wyczyszczenia, zaleca się zastosowanie Eco MultiClean: gwarantuje higienę, usuwając białka i tłuszcze z mleka i można go stosować do czyszczenia całego ekspresu.
2. W celu dokładnego wyczyszczenia dyszy (rys. 10) wytworzyć przez kilka sekund parę.
3. Poczekać na ostygnięcie dozownika: aby zagwarantować skuteczność dozownika, użyć igły do czyszczenia ((C12), aby 3 otwory były wolne (rys. 27).

### 5.2 Przygotować napój mleczny za pomocą LatteCrema System (rys. 28)

1. Włączyć do pojemnika (D8) mleko z lodówki (5°C) (rys. 29).
2. Zamknąć pokrywkę (D1) (rys. 30).
3. Przekręcić pokrętko regulacji pianki (D5) na żądaną pozycję (rys. 31).

Ustawić pokrętkę regulacji pianki				
<input type="checkbox"/> CLEAN	<input type="checkbox"/> 	<input type="checkbox"/> 	<input type="checkbox"/> 	<input type="checkbox"/> INSERT
Czyszczenie po każdym użyciu	Pianka MAKS.	Pianka ŚRED.	Pianka MIN.	Do wyjęcia lub włożenia pokrętki

- Zamocować pojemnik na mleko w ekspresie (rys. 32).
- Przygotować idealną dawkę (patrz „4.1 Etap 1 - Mielenie (grinding) (rys. 11)“ i „4.2 Etap 2 - Ubijanie (tamping) (rys. 17)“) i włożyć uchwyt na filtr.
- Wybrać żądany napój mleczny (rys. 33).

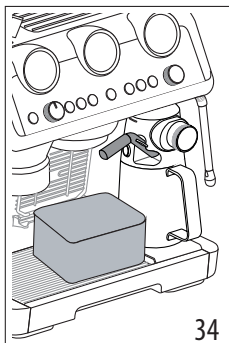
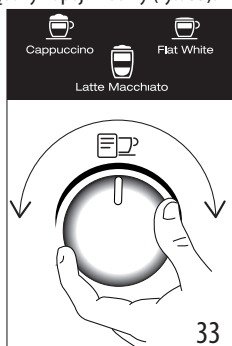





- Czyszczenie rozpoczyna się i kończy automatycznie. Uwaga: po zakończeniu czyszczenia, przekręcić pokrętkę na jedną z pozycji regulacji pianki.

- Wyjąć pojemnik na mleko i umieścić go w lodówce: zaleca się zużycie pozostałego mleka w krótkim czasie.

W celu dogłębnego wyczyszczenia, zaleca się zastosowanie Eco MultiClean: gwarantuje higienę, usuwając białka i tłuszcze z mleka i można go stosować do czyszczenia całego ekspresu.

## 6. SPERSONALIZOWAĆ ILOŚĆ NAPOJU NA BAZIE KAWY, UŻYWAJĄC PRZYCIŚKU (B9)

- Przygotować urządzenie do wytworzenia 1 lub 2 filiżanek napoju na bazie kawy, aż do zaczepienia uchwytu na filtr (C1) wraz z filtrem (C2) lub (C3) i kawą mieloną. Jeżeli chce się zaprogramować napój mleczny, podłączyć Lattecrema System do ekspresu.
- Przekręcić pokrętkę (B10) w celu wybrania napoju do zaprogramowania.
- Wcisnąć przycisk : kontrolka odpowiadająca przyciskowi OK (B6) włączy się na stałe, a kontrolka odpowiadająca przyciskowi  będzie migać.
- Wcisnąć przycisk OK, aby rozpocząć przygotowywanie. Kontrolki odpowiadające przyciskom OK i  będą migać.
- Po osiągnięciu żądanej ilości, wcisnąć OK. Jeżeli napój przewiduje kolejny składnik, rozpoczyna się jego wytwarzanie: po osiągnięciu żądanej ilości, wcisnąć OK.
- Wcisnąć przycisk , aby zapisać. Urządzenie jest gotowe do ponownego użycia i kontrolka  pozostaje włączona. Jeżeli nie chce się zapisać programowania, wcisnąć dowolny przycisk.

### Zwróć uwagę:

- Można zaprogramować napoje z kawą, ale nie da się zaprogramować wytwarzania pary i gorącej wody.
- Programowanie zmienia ilości napojów, ale nie ilość zmielonej kawy.
- Napoje „X2” można programować oddzielnie.

Napój	Espresso	Mleko	Pianka	Ilość (ml)	X2 (ml)
Cappuccino	1	✓	✓	≈150	≈230
Latte Macchiato	1	✓	✗	≈150	≈230
Flat White	1	✓	✓	≈250	≈330

- Napoje z podwójną dawką (2x):** Włączyć do pojemnika (D8) niezbędną ilość mleka, uważając aby nie przekroczyć poziomu MAKS. (rys. 25). Każdy znacznik na pojemniku odpowiada ≈100 ml mleka.
  - Zimne mleko jest lepsze.** Zawsze używać zimnego mleka prosto z lodówki.
- Wcisnąć OK (B6) aby wytworzyć (rys. 23). Urządzenie automatycznie wytworzy kolejno kawę i mleko.

### Czyszczenie Lattecrema System po każdym użyciu:

- Pozostawić pojemnik na mleko zamocowany w ekspresie (nie jest konieczne jego opróżnienie). Ustawić pojemnik pod rurką wytwarzania mleka (D4) (rys. 34).
- Przekręcić pokrętkę (D5) na „Clean” (rys. 35).

- Nie da się zaprogramować **My LatteArt**.
- Aby powrócić do ustawień fabrycznych, przytrzymać wciśnięty przycisk **(my)**, dopóki nie wyłączy się. Wybrany napój powróci do ustawień fabrycznych.

Kawa	Ilość ust. fabrycznie	Ilość możliwa do zaprogramowania
Espresso	35 ml	od 25 do 90 ml
Espresso X2	70 ml	od 50 do 180 ml
Coffee	80 ml	od 50 do 120 ml
Coffee X2	160 ml	od 120 do 240 ml
Americano	120 ml	<ul style="list-style-type: none"> <li>• espresso: od 25 do 60 ml</li> <li>• woda: od 25 do 120 ml</li> </ul>
Americano X2	240 ml	<ul style="list-style-type: none"> <li>• espresso: od 50 do 120 ml</li> <li>• woda: od 50 do 240 ml</li> </ul>

## 7. MENU USTAWIENÍ

1. Wejść do menu:		
Równocześnie wcisnąć na 5 sekund	x2	<b>(my)</b>
2. Wybrać ustawienie do zaprogramowania:		
Napój	Odpowiadające ustawienie	Regulacje
Espresso	Oszczędność energetyczna	➔  Aktywne
		➔  Wyłączone
Coffee	Auto wyłączenie	➔ 9 minut
		➔ 1,5 godz.
		<b>(my)</b> ➔ 3 godz.
Cappuccino	Sygnał dźwiękowy	➔  Aktywny
		➔  Wyłączony
➔		

Latte	Dodatkowa regulacja stopnia zmielenia	➔ Zakres 1 ➔ Zakres 2
Flat White	Ustawienia fabryczne	Przytrzymać wciśnięty przycisk OK przez przynajmniej 5 sekund, dopóki kontrolka nie będzie włączona
Americano	Twardość wody	➔ miękka
		➔ średnia
		<b>(my)</b> ➔ twarda/bardzo twarda
<b>3. Zapisać nowe ustawienia wciskając ON/Standby (B1)</b>		

## 8. CZYSZCZENIE URZĄDZENIA

### Uwaga!

- Do czyszczenia urządzenia nie używać rozpuszczalników, ściernych środków czyszczących lub alkoholu.
- Do usuwania kamienia osadowego lub osadów z kawy nie należy używać metalowych przedmiotów, mogłyby one zarysować metalowe lub plastikowe powierzchnie.
- W przypadku nieużytkowania przez okres dłuższy niż jeden tydzień zaleca się, przed ponownym użyciem ekspresu, przeprowadzenie płukania.

### Niebezpieczeństwo!

- Podczas mycia nigdy nie zanurzać urządzenia w wodzie: jest to urządzenie elektryczne.
- Przed przystąpieniem do czyszczenia części zewnętrznych wyłączyć urządzenie, wyjąć wtyczkę z gniazdka prądu i poczekać, aż urządzenie wystygnie.

	×	✓	✓	×	×
➔					



	✓	✗	✗	✓	✓
	✗	✗	✗	✓	✓
	✗	✗	✗	✓	✓
	✗	✗	✓	✓	✗
	✗	✗	✗	✓	✓
	✓	✓	✗	✓	✓

### 8.1 Czyszczenie dozownika kawy

Gdy włączy się kontrolka (pomarańczowa) (B5), konieczne jest wykonanie czyszczenia obwodu kawy. W celu przeprowadzenia cyklu czyszczenia, należy zakupić specjalne tabletki do czyszczenia ekspresu do kawy. Więcej informacji na [www.DeLonghi.com](http://www.DeLonghi.com).

1. Włożyć filtr na 1 filiżankę (C2) do uchwytu na filtr (C1) (rys. 36).
2. Włożyć do filtra element czyszczący (C9) (rys. 36) i dopchnąć do dna.

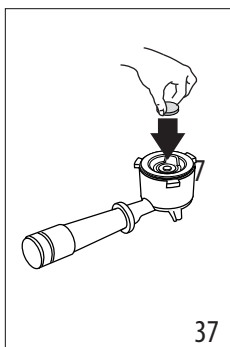
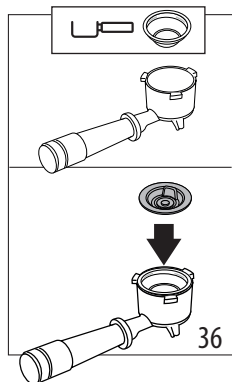

3. Umieścić tabletkę w elemencie (rys. 37).
4. Zamocować uchwyt na filtr w dozowniku kawy (A7).

5. Napęścić zbiornik wodą (A15). Upewnić się że tacka na skropliny (A11) jest pusta.
6. Przytrzymać wciśnięty przycisk , dopóki odpowiednia kontrolka nie zacznie migać (pomarańczowa). Po kilku minutach, czyszczenie kończy się automatycznie.
  - Wyjąć uchwyt na filtr i element czyszczący.
  - Umyć uchwyt na filtr i filtr pod bieżącą wodą.
  - Założyć uchwyt na filtr i przeprowadzić płukanie, wciskając przycisk (B5): pod uchwytym na filtr zaleca się ustawienie pojemnika.
  - Wyjąć i opróżnić tackę na skropliny.

### Zwróć uwagę:

Taki cykl czyszczenia można uaktywnić w każdej chwili, wciskając przycisk (B5) przez kilka sekund. Aby anulować czynność, wcisnąć przycisk przez 10 sekund.

### 8.2 Wyczyścić gniazdo pojemnika na ziarna

1. Upewnić się, że pojemnik na ziarna (A1) jest pusty. Ewentualnie wykonać kilka procesów mielenia bez ziaren, aby go opróżnić.
2. Odczepić pojemnik, przekręcając go w lewo i wyjąć z ekspresu (rys. 38)

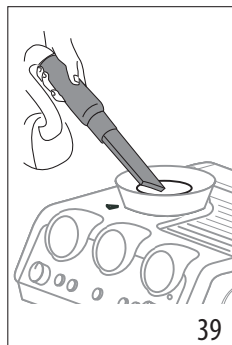
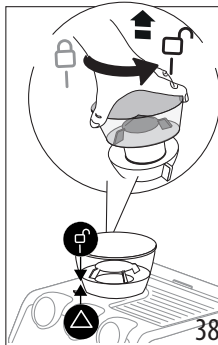

3. Usunąć wszelkie resztki kawy (rys. 39);
4. Wyczyścić wilgotną szmatką gniazdo pojemnika na ziarna i wytrzeć na sucho (rys. 40);

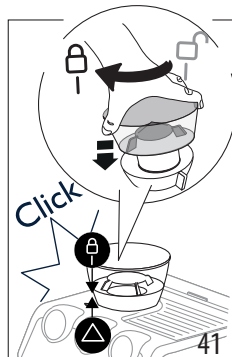
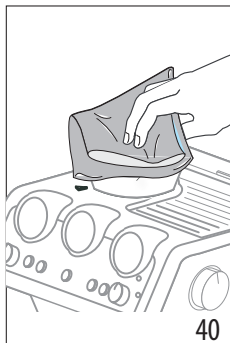

5. Umieścić pojemnik, wkładając go do młynka. Pojemnik jest włożony prawidłowo, gdy strzałka ▲ będzie wyrównana z symbolem □ i usłyszysz się „kliknięcie” (rys. 41).

### 8.3 Czyszczenie żaren

Podczas czyszczenia pojemnika na ziarna (A1), wyczyścić jego gniazdo i górne żarno wilgotną szmatką. Zwrócić się do centrum serwisowego w celu usunięcia lub wymiany żaren.

Można wyjąć żarno, jeżeli młynek zostanie zablokowany przez obce ciało. Jeżeli tak się stanie, wyjąć pojemnik na ziarna i postępować następująco:

1. Zaczepić tyżkę uchwytu na filtr (C1) i wykonać jeden proces mielenia bez ziaren, w celu uwolnienia przewodu kawy.
2. Wyłączyć urządzenie.
3. Przekręcić regulator zmielenia w kierunku przeciwnym do kierunku ruchu wskazówek zegara, aż do ogranicznika, na pozycję „REMOVE” (rys. 42).

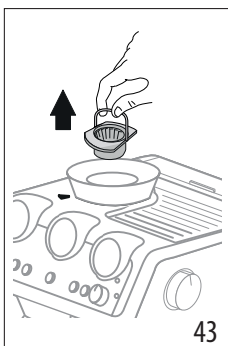
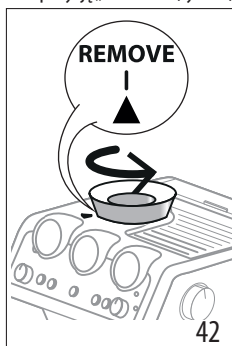

4. Wyjąć górną część żarna, chwytając za odpowiedni uchwyt (rys.43).
5. Wyczyścić żarno pędzelkiem (rys. 44) i usunąć resztki kawy za używając odkurzacza (rys. 39).

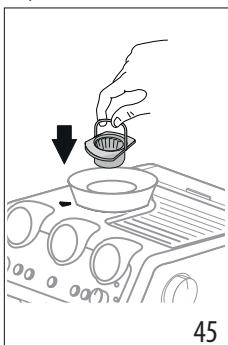
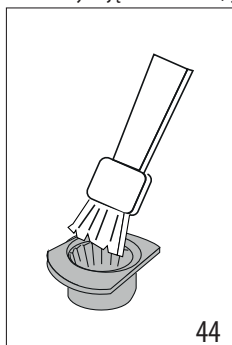

6. Włożyć żarno do gniazda (rys. 45);
7. Przekręcić regulator wybierając żądany stopień zmielenia (rys. 13);

Sprawdzić, czy żarno jest dobrze włożone, pociągając za uchwyty: żarno jest prawidłowo włożone, jeżeli jest nieruchome;

### 8.4 Wymiana żaren

Gdy ilość zmielonej kawy zmniejszy się, zwrócić się do centrum serwisowego w celu wymiany żaren: ponownie wyregulować młynek wchodząc do menu ustawień („7. Menu ustawień”) i wybierając pierwszy zakres regulacji extra zmielenia. Następnie przekręcić pokrętkę regulacji ilości (B2) na pozycję MIN i wyregulować dawkę, jak w przypadku pierwszego użycia (patrz „Idealna dawka”).

### 8.5 Czyszczenie „Smart tamping station”

1. Wyczyścić strefę zaczepienia za pomocą pędzelka (rys. 46).
2. Pociągnąć dźwignię (A20) do końca i wyczyścić praskę pędzelkiem (fig.47), następnie puścić dźwignię.
3. Za pomocą wycioru (C8) wyczyścić przewodnik kawy (rys. 48).

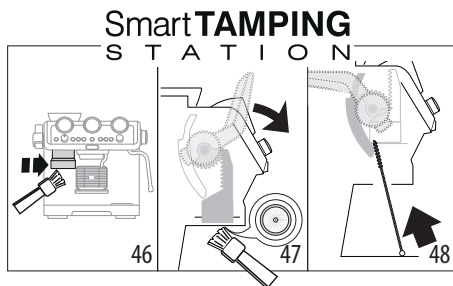

### 8.6 Czyszczenie LatteCrema System

Umyć wszystkie elementy i pojemnik w zmywarce do naczyń, umieszczając je w górnym koszu. Jeżeli nie posiada się zmywarki do naczyń, umyć elementy ręcznie, jak wskazano na końcu paragrafu.

1. Wcisnąć przycisk (D3) i podnieść pokrywkę pojemnika na mleko (D1);
2. Wyciągnąć dyszę mleka (D4) i rurkę zanurzaną w mleku ((D7) (rys. 49);

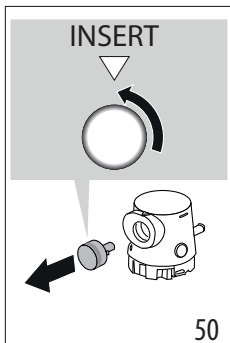
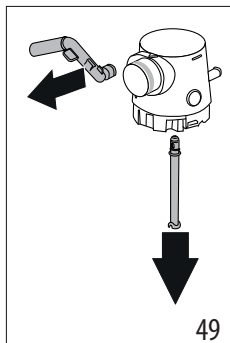

- Przekręcić pokrętło na pozycję „Insert” i wyciągnąć je (rys. 50);
- Zachować szczególną ostrożność, aby w nacięciu i w kanaliku pod pokrętłem (rys. 51) zachować szczególną ostrożność, aby w nacięciu i w kanaliku pod pokrętłem: ewentualnie wyczyścić kanalik za pomocą wykałaczki;

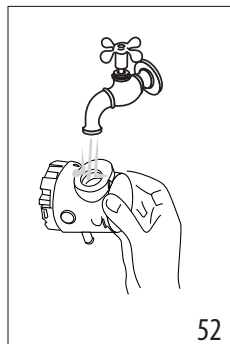
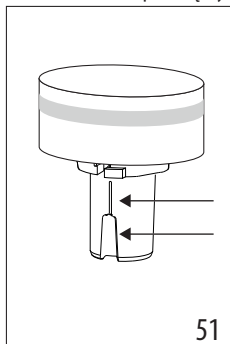

- Wyplukać wewnątrz gniazda na pokrętło regulacji pianki pod bieżącą wodą (rys. 52);
- Sprawdzić również, czy rurka zanurzana w mleku i rurka do wytwarzania mleka nie są zatkane resztkami mleka;
- Zmontować wszystkie komponenty pokrywki;
- Umyć i dokładnie wypłukać pojemnik na mleko (D8) ;
- Założyć pokrywkę na pojemniku na mleko.

#### Zwróć Uwagę: mycie ręczne

Mycie w zmywarce do naczyń zapewnia idealną higienę wszystkich elementów pojemnika na mleko: w przypadku ręcznego mycia, należy dokładnie umyć wszystkie elementy pojemnika na mleko w gorącej wodzie, zanurzyć je w misce z wodą i pozostawić na 30 minut, przed przystąpieniem do czynności wskazanych w punkcie 4.

## 9. TWARDOŚĆ WODY

Kontrolka  (B8) odkamieniania włącza się po ustalonym wcześniej okresie działania, który zależy od twardości wody. Można zaprogramować ekspres na podstawie twardości wody z

sieci wodociągowej różnych regionów, zmniejszając w ten sposób częstotliwość wykonywania odkamieniania.

- Wyjąć z opakowania dołączony do urządzenia pasek kontrolny „TOTAL HARDNESS TEST” (C4).
- Całkowicie zanurzyć pasek w szklance wody z kranu na około jedną sekundę.
- Wyjąć pasek z wody i lekko nim potrząsnąć. Ustawić urządzenie, jak wskazano w rozdziale „7. Menu ustawień”.

Wynik Testu Twardości wody	Przycisk	Poziom
	×2	<b>1</b> słodka woda
		<b>2</b> woda średniej twardości
	OK	<b>3</b> woda twarda lub bardzo twarda

- Ustawić urządzenie, jak wskazano w rozdziale „7. Menu ustawień”.

## 10. JAK UŻYWAĆ SOFTBALLS

Softballs (C11) jest nowoczesnym system, który wydłuża żywotność urządzenia, nie wpływając na jakość wody i gwarantując parzenie kremowej i aromatycznej kawy. Aby zoptymalizować skuteczność działania, przed użyciem pozostawić Softballs na całą noc w wodzie.

- Wyjąć pakiet Softballs z opakowania (rys. 53).

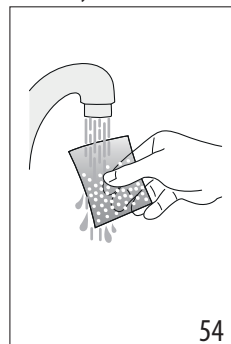
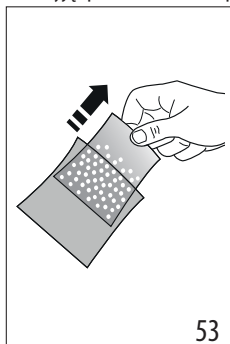

- Wyplukać pakiet Softballs pod bieżącą wodą (rys. 54).
- Zanurzyć woreczek w zbiorniku na wodę (A15) (rys. 55).

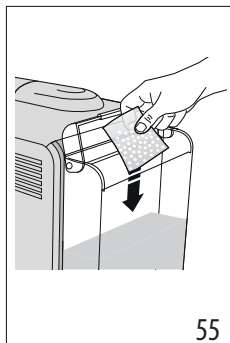

4. Wymieniać woreczek Softballs co 3 miesiące (rys. 56).

## 11. ODKAMNIENIE

### Uwaga!

- Przed użyciem, przeczytaj instrukcję i etykietę odkamieniacza (C5), znajdujące się na jego opakowaniu.
- Zaleca się stosowanie wyłącznie odkamieniacza firmy De'Longhi. Użycie nieodpowiednich odkamieniaczy, jak również nieregularnie wykonywane odkamienianie może doprowadzić do usterek, których gwarancja producenta nie obejmuje.
- Odkamieniacz może uszkodzić delikatne powierzchnie. W razie przypadkowego rozlania, należy go natychmiast wytrzeć.

Aby przeprowadzić odkamienianie	
Odkamieniacz	Odkamieniacz De'Longhi
Pojemniki	2 o pojemności 1 litra każdy
Czas	~40min

1. (JEŻELI OBECNE, WYJĄĆ FILTR ZMIĘKZAJĄCY I SOFTBALLS). Włąć do zbiornika na wodę (A15) odkamieniacz, do poziomu  A (opakowanie 100 ml), zaznaczonego wewnątrz zbiornika (rys. 57).

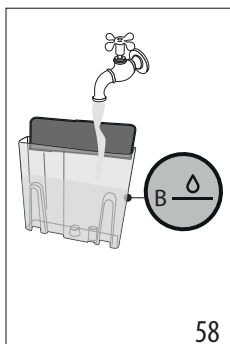
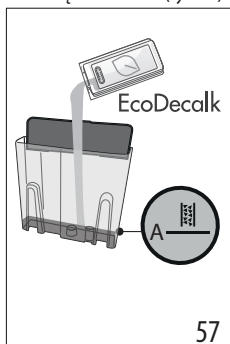

2. Dolać wodę do poziomu  B (rys. 58). Ponownie włożyć zbiornik na wodę do urządzenia.
3. Włożyć akcesorium (C6) do łącznika LatteCrema System (A6) (rys. 59).

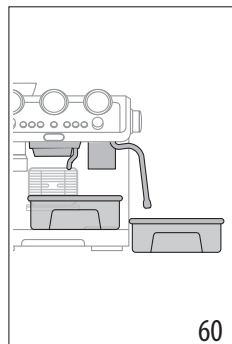
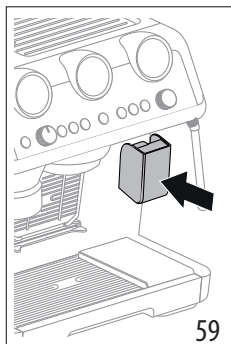

4. Upewnić się, że uchwyt na filtr (C1) nie jest zaczepony i umieścić pojemnik pod dozownikiem kawy i dyszą gorącej wody (A7) oraz pod dyszą pary (A5) (fig. 60).
5. Przytrzymać wciśnięty przycisk  (B8) dopóki odpowiednia kontrolka nie zacznie migać.
6. Uruchomi się program odkamieniania i z dysz wypłynie woda. Program odkamieniający wykonuje automatycznie całą serię płukań, w celu usunięcia kamienia z ekspresu, aż do opróżnienia zbiornika.

Wytwarzanie zostanie przerwane, a kontrolka  stanie się biała. W tym momencie należy przeprowadzić cykl płukania:

7. Opróżnić zbiornik użyty do zebrania płynu odkamieniającego i ponownie umieścić go pod dyszami.
8. Wyjąć zbiornik na wodę, opróżnić go z ewentualnych resztek roztworu odkamieniającego, wypłukać go i napełnić świeżą wodą do poziomu MAX (rys. 61). Ponownie włożyć zbiornik na miejsce.

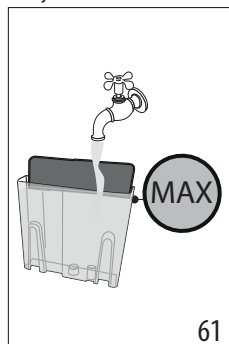



9. Przytrzymać wciśnięty przycisk  dopóki odpowiednia kontrolka nie zacznie migać: płukanie uaktywni się.











10. Po zakończeniu płukania, wytwarzanie zostanie przerwane i urządzenie będzie gotowe do użytku.
11. Opróżnić pojemniki użyte do zebrania wody z płukania.
12. Wyjąć i opróżnić tackę na skropliny, ponownie ją założyć na miejsce.
13. Wyjąć i napełnić świeżą wodą zbiornik; ponownie go włożyć na miejsce.

Urządzenie jest gotowe do użycia.













**Zwróć uwagę:**

- Jeżeli chce się wykonać cykl odkamieniania wcześniej, wcisnąć przycisk  przez 3 sekundy.
- Jeżeli odkamienienie zostało uaktywnione przez przypadek, wcisnąć przycisk  przez 10 sekund; płukanie nie może być przerwane.



## 12. ZNACZENIE KONTROLEK

KONTROLKI	ZNACZENIE KONTROLEK	CZYNNOŚĆ
Wszystkie kontrolki migają krótko	Włączanie urządzenia	Autodiagnostyka
 stała	Nastąpiło pierwsze włączenie urządzenia i konieczne jest napełnienie obwodu wodą	Postępować jak wskazano w rozdz. „3. Pierwsze włączenie urządzenia”
 stała	Funkcja oszczędności energetycznej jest aktywna	Skonsultować rozdz. „7. Menu ustawień” jeżeli chce się wyłączyć funkcję
 stała	Pojemnik na ziarna (A1) jest pusty	Napełnić pojemnik ziarnami
 migająca	Chce się wykonać mielenie, ale pojemnik na ziarna (A1) jest pusty	Napełnić pojemnik ziarnami
 on	Niewystarczająca ilość wody w zbiorniku (A15) lub zbiornik na wodę jest nieprawidłowo założony	Napełnić zbiornik lub wyjąć go i ponownie, prawidłowo włożyć
 migająca	Chce się przygotować napój, ale zbiornik na wodę (A15) jest pusty	Napełnić zbiornik wodą
 stała	Alarm ogólny	Zwrócić się do centrum serwisowego
 stała	Nie jest włożony pojemnik na ziarna	Prawidłowo włożyć pojemnik na ziarna (A1) lub sprawdzić, czy jest prawidłowo włożony
 migająca	Przełącznik, umieszczony się u podstawy pojemnik na ziarna (A1), nie znajduje się na prawidłowej pozycji	Ustawić przełącznik na jednej z pozycji mielenia (od 1 do 8), pamiętając, że należy: <ul style="list-style-type: none"> <li>• Wyregulować stopień mielenia podczas działania młynka</li> <li>• Regulować po jednym poziomie na raz i wykonać przynajmniej 5 cykli mielenia pomiędzy jedną regulacją a kolejną</li> </ul>
	Pojemnik na ziarna (A1) nie jest całkowicie włożony: interweniuje urządzenie bezpieczeństwa	Sprawdzić, czy pojemnik na ziarna jest prawidłowo włożony
 stała	LatteCrema System musi być czyszczony po każdym użyciu	Po zakończeniu przygotowywania napojów mlecznych, przeprowadzić automatyczne czyszczenie, przekręcając pokrętko (D5) na Clean



KONTROLKI	ZNACZENIE KONTROLEK	CZYNNOŚĆ
 stała	Urządzenie jest gotowe do wytworzenia pary.	Urządzenie osiągnęło temperaturę do wytwarzania pary. Przystąpić do wytwarzania, przekręcić pokrętkę pary (A4)
 migająca	Urządzenie jest włączone i funkcja oszczędności energetycznej jest aktywna: pokrętkę pary (A4) na pozycji wytwarzania pary	Kontrolka miga wskazując, że urządzenie przygotowuje się do wytworzenia pary: wytwarzanie zacznie się, jak tylko urządzenie osiągnie temperaturę
	Urządzenie jest gotowe do wytworzenia pary	Urządzenie osiągnęło temperaturę odpowiednią do wytworzenia pary, gdy kontrolka jest włączona na stałe
	Urządzenie wytwarza parę	
 stała (pomarańczowa)	Należy przeprowadzić odkamienianie	Przeprowadzić odkamienianie, jak wskazano w rozdz. „11. Odkamienianie”
 migająca (pomarańczowa)	Urządzenie przeprowadza odkamienianie	Postępować jak opisano w rozdz. „11. Odkamienianie”
 stała (biała)	Należy przeprowadzić płukanie	
 migająca (biała)	Urządzenie przeprowadza cykl płukania	
 Stała (pomarańczowa)	Należy przeprowadzić czyszczenie dozownika kawy	Patrz par. „8.1 Czyszczenie dozownika kawy”
 migająca (pomarańczowa)	Urządzenie przeprowadza czyszczenie dozownika kawy	
 migająca (biała)	Urządzenie przeprowadza cykl płukania	
 +  migające	jeżeli urządzenie posiada filtr zmiękczający mogło nastąpić uwolnienie pęcherzyka powietrza do obwodu, uniemożliwiający wytwarzanie	Wcisnąć przycisk (B7) obok kontrolki  : rozpocznie się wytwarzanie, następnie zostanie automatycznie przerwane.
	Ziarna są zbyt drobno zmielone i dlatego kawa wypływa zbyt wolno i nie do końca	Wyjąć łyżkę uchwytu na filtr (C1), powtórzyć czynności w celu przygotowania kawy, uwzględniając wskazówki z par. „4.1 Etap 1 - Mielenie (grinding) (rys. 11)” i „4.2 Etap 2 - Ubijanie (tamping) (rys. 17)”
	Filtr kawy (C2) lub (C3) jest zatkany	Wypłukać filtry pod bieżącą wodą lub przeprowadzić płukanie za pomocą przycisku płukania (B5).
	Zbiornik (A15) jest włożony nieprawidłowo i jego zawory są zamknięte	Lekko docisnąć zbiornik, aby otworzyć zawory
	Kamień wewnątrz obwodu hydraulicznego	Przeprowadzić odkamienianie, jak wskazano w rozdz. „11. Odkamienianie”

### 13. NIEPRAWIDŁOWOŚCI

PROBLEM	PRZYCZYNA	ROZWIĄZANIE
W tacce na skropliny (A11) znajduje się woda	Jest to normalne działanie wewnętrznych obwodów urządzenia	Regularnie opróżniać i czyścić tacka na skropliny (A11)
Kawa espresso nie wypływa	Brak wody w zbiorniku (A15)	Napełnić zbiornik
	Kontrolka  (B7) jest włączona, wskazując, że obwód kawy lub obwód pary jest pusty.	Wcisnąć przycisk odpowiadający kontrolce  w celu napełnienia obwodu.
	Filtr (C2) lub (C3) jest zatkany	Wypłukać filtry pod bieżącą wodą lub przeprowadzić płukanie za pomocą przycisku płukania (B5)
	Zbiornik (A15) jest źle umieszczony i zawory znajdujące się na dnie są zamknięte	Delikatnie docisnąć zbiornik, aby otworzyć znajdujące się na dnie zawory
	Kamień wewnątrz obwodu hydraulicznego	Przeprowadzić odkamienianie, jak wskazano w rozdz. „11. Odkamienianie”
	Ziarna są zbyt drobno zmielone	Wyjąć łyżkę uchwytu na filtr (C1), powtórzyć czynności w celu przygotowania kawy, uwzględniając wskazówki z par. „4.1 Etap 1 - Mielenie (grinding) (rys. 11)” i „4.2 Etap 2 - Ubijanie (tamping) (rys. 17)”
Nie można zaczepić uchwytu na filtr na urządzeniu	Kawa mielona nie została ubita lub jest jej za dużo	Powtórzyć mielenie z innymi ustawieniami. Zmniejszyć ilość dawki: sprawdzić, czy filtr (C2) lub (C3) (1 lub 2 filizanki) jest prawidłowo do mielonej dawki (przycisk 2x (B3) wybrany czy nie)
Kawa espresso kapie z brzegów uchwytu na filtr (C1) zamiast z otworów	Uchwyt na filtr jest źle założony	Prawidłowo założyć uchwyt na filtr i przekręcić do oporu
	Uszczelka dozownika kawy (A7) straciła elastyczność lub jest brudna	Wymienić uszczelkę dozownika kawy w Autoryzowanym Centrum Serwisowym
	Filtr (C2) lub (C3) jest zatkany	Wypłukać filtry pod bieżącą wodą lub przeprowadzić płukanie za pomocą odpowiedniego przycisku (B5)
Pianka na kawie jest jasna (kawa wypływa z otworu szybko)	Należy sprawdzić ustawienia urządzenia	Wyjąć łyżkę, powtórzyć czynności do przygotowania kawy, uwzględniając wskazówki z par. „4.1 Etap 1 - Mielenie (grinding) (rys. 11)” i „4.2 Etap 2 - Ubijanie (tamping) (rys. 17)”
		→

PROBLEM	PRZYCZYNA	ROZWIĄZANIE
Pianka na kawie jest ciemna (kawa wypływa z otworu powoli)	Należy sprawdzić ustawienia urządzenia	Wyjąć łyżkę uchwytu na filtr (C1), powtórzyć czynności w celu przygotowania kawy, uwzględniając wskazówki z par. „4.1 Etap 1 - Mielenie (grinding) (rys. 11)” i „4.2 Etap 2 - Ubijanie (tamping) (rys. 17)”
Podczas przygotowania kawy cappuccino za pomocą LatteCrema System nie tworzy się pianka na mleku	Mleko nie jest wystarczająco zimne	Zawsze używać mleka z lodówki
	Pokrętko (D5) nie znajduje się na prawidłowej pozycji	Sprawdzić i przekręcić pokrętko na właściwą pozycję (☞ maks. pianka; ☞ śred. pianka; ☞ min. pianka)
	LatteCrema System jest brudny	Przeprowadzić czyszczeni jak wskazano w paragrafie „8.6 Czyszczenie LatteCrema System”
Kamień wewnątrz obwodu hydraulicznego	Przeprowadzić odkamienianie, jak wskazano w rozdz. „11. Odkamienianie”	
Po zakończeniu odkamieniania, urządzenie wymaga kolejnego płukania	Podczas cyklu płukania, zbiornik nie został napełniony do poziomu MAX	Powtórzyć płukanie (patrz rozdz. „11. Odkamienianie”)
Urządzenie nie mieli kawy	Wewnątrz młynka do kawy znajduje się obce ciało	Wyczyszczyć żarna jak wskazano w par. „8.3 Czyszczenie żaren”, upewniając się o usunięciu wszystkich ziaren z pojemnika na ziarna (A2) przed jego wyjęciem. Przed ponownym włożeniem żarna, usunąć wszelkie resztki z jego gniazda
	Pojemnik na ziarna (A1) nie znajduje się na prawidłowej pozycji	Pojemnik jest włożony prawidłowo, gdy strzałka ▲ będzie wyrównana z symbolem ☞ i usłyszysz się „kliknięcie”
Jeżeli chce się zmienić ilość kawy	Należy usunąć wszystkie ziarna z urządzenia	<ul style="list-style-type: none"> <li>• Opróżnić pojemnik na ziarna (A1) (wykonując mielenie bez kawy lub usuwając pozostające ziarna).</li> <li>• Zaczepić łyżkę uchwytu na filtr (C1) i włączyć mielenie bez kawy, aby opróżnić przewód kawy: następnie zaczepić uchwyt na filtr na wylocie młynka (A18) wyrównując go z napisem IN-SERT i przekręcić łyżkę w prawo (rys. 22). Mielenie rozpocznie się, gdy łyżka znajdzie się na pozycji CLOSE i zostanie przerwane automatycznie. Powtarzać, dopóki filtr nie będzie pusty.</li> <li>• Wsypać do pojemnika (A1) nowy rodzaj ziaren kawy</li> <li>• Jeżeli po zmieleniu nie osiągnie się „idealnej dawki”, postępować jak w przypadku pierwszego użycia</li> </ul>



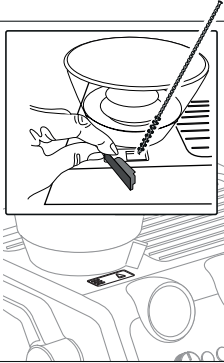

PROBLEM	PRZYCZYNA	ROZWIĄZANIE
<p>Po zmieleniu, filtr kawy (C2) lub (C3) jest pusty</p> <p>Po zmieleniu, w filtrze jest zbyt dużo kawy</p>	<p>Prowadnik kawy w młynku jest zatkany</p>	<p>Wyczyścić jak wskazano w par. „8.5 Czyszczenie „Smart tamping station””. Jeżeli problem trwa, przejść do prowadnika otwierając otwór (A19) i uwolnić go za pomocą wycioru</p> 
<p>Po zmieleniu, kawa w filtrze (C2) lub (C3) nie osiąga „idealnej dawki”</p>	<p>„Smart Tamping Station” wymaga wyczyszczenia</p> <p>Należy wyregulować ilość zmielonej kawy</p> <p>Z czasem żarna ulegają zużyciu</p>	<p>Wyczyścić jak wskazano w par. „8.5 Czyszczenie „Smart tamping station””, następnie powtórzyć mielenie</p> <p>Wyregulować ilość za pomocą odpowiedniego pokrętki (B2), stosując się do wskazówek z par. „„Idealna dawka””. Jeżeli pokrętło znajduje się już na pozycji maks., postępować jak wskazano w sekcji „Dodatkowa regulacja stopnia zmielenia”</p> <p>Wymienić żarna je jak wskazano w par. „8.4 Wymiana żaren”</p>

Înainte de a utiliza aparatul, citiți întotdeauna dosarul cu instrucțiunile de siguranță.

## 1. DESCRIERE

### 1.1 Descrierea aparatului - A

- A1. Recipient pentru boabe
- A2. Capac recipient boabe
- A3. Raft de așezat cești
- A4. Buton abur
- A5. Duză de distribuire a aburului
- A6. Conector pentru sistemul Lattecrema
- A7. Distribuitor cafea
- A8. Grătar suport cești pentru espresso
- A9. Grătar suport cești pentru pahare sau căni
- A10. Grătar tavă
- A11. Tăviță de colectare a picăturilor
- A12. Indicator nivel apă pentru tava de picurare
- A13. Capac rezervor apă
- A14. Mâner scoatere rezervor de apă
- A15. Rezervor de apă
- A16. Spațiu conector cablu alimentare
- A17. Întrerupător general (ON/OFF)
- A18. Ieșire râșniță de cafea (Tamping station)
- A19. Ușiță pentru accesul la ștuțul aparatului de cafea
- A20. Manetă de presare

### 1.2 Descrierea panoului de control - B

- B1. Tastă ON/Standby
- B2. Mâner pentru reglarea cantității de cafea măcinată
- B3. Tastă „X2”: pentru a utiliza filtrul cu 2 cafele
- B4. Tastă „temperatură cafea”
- B5. Tastă pentru „clătire”
- B6. Tastă "OK": pentru a distribui băutura/pentru a confirma
- B7. Tastă „distribuție apă caldă”
- B8. Tastă „decalcifiere”
- B9. Tastă "My": pentru personalizarea lungimii băuturilor
- B10. Mâner pentru selectare funcții
- B11. Afișaj băuturi:

#### Băuturi pe bază de cafea Espresso

- Espresso
- Americano
- Cafea

#### Băuturi pe bază de lapte

- Cappuccino
- Flat White
- Latte Macchiato

- B12. Indicator „curățare lapte”
- B13. Indicator „lipsă rezervor boabe”
- B14. Indicator „alarmă generică”
- B15. Manometru

- B16. Indicator „lipsă apă”
- B17. Indicator „rezervor boabe gol”
- B18. Indicator luminos de „economisire a energiei”
- B19. Afișare setări și proces:

- Indică operațiunea pe care o efectuează aparatul
- Indică setarea dozei de cafea selectată
- Indică setarea temperaturii cafelei selectate

### 1.3 Descrierea accesoriilor - C

- C1. Manetă cupă suport de filtru
- C2. Filtru 1 ceașcă
- C3. Filtru 2 cești
- C4. Bandă reactivă pentru testarea durezzații apei „Total Hardness Test”
- C5. Decalcifiant
- C6. Accesoriu pentru decalcifiere
- C7. Cablu de alimentare detașabil
- C8. Perie
- C9. Accesoriu pentru curățarea dozatorului de cafea
- C10. Cărpă
- C11. Softballs (dedurizator de apă)
- C12. Ac de curățare pentru duza de abur

### 1.4 Accesoriile de curățare neincluse, recomandate de producător

Pentru mai multe informații, vizitați [Delonghi.com](http://Delonghi.com).



#### Pastile pentru curățare

(A se vedea „8.1 Curățarea dozatorului de cafea”)



#### Dispozitiv de curățare

EAN: 8004399333307

### 1.5 Descrierea sistemului LatteCrema - D

- D1. Capac recipient pentru lapte
- D2. Conector recipient pentru lapte
- D3. Buton de eliberare a capacului
- D4. Duză lapte (cu înălțime reglabilă)
- D5. Buton de reglare a spumei
- D6. Locaș buton
- D7. Duză de preluare lapte
- D8. Recipient pentru lapte

## 2. PREGĂTIREA APARATULUI

Spălați toate accesoriile cu apă caldă și detergent pentru vase, apoi procedați după cum urmează:

1. Introduceți tava de colectare picături (A11) împreună cu grătarul pentru cești (A9) și grătarul pentru tavă (A10) (fig. 1);

2. Scoateți rezervorul pentru apă (A15) (fig. 2) și umpleți-l cu apă proaspătă și curată, având grijă să nu depășiți semnul MAX (fig. 3).
3. Apoi reintroduceți rezervorul.

**Atenție:** Nu utilizați niciodată aparatul fără apă în rezervor sau fără rezervor.

**Rețineți:** Vă recomandăm să personalizați cât mai curând duritatea apei, urmând procedura descrisă în capitolul „7. Meniu setări”.

### 3. PRIMA PUNERE ÎN FUNCȚIUNE A APARATULUI

1. Introduceți conectorul cablului de alimentare (C7) în locul special amenajat (A16) pe spatele aparatului (fig. 4); apoi introduceți ștecărul în priză. Asigurați-vă că întrerupătorul general, (A17) care se află în partea posterioară a aparatului, a fost apăsat în poziția I (fig. 5);
2. Așezați sub dozatorul de apă fierbinte (în corespondență cu dozatorul de cafea (A7)) un recipient cu o capacitate minimă de 100 ml (fig. 6);
3. Apăsăți tasta (B7) din dreptul indicatorului luminos (fig. 7): curgerea începe și apoi se întrerupe automat. Goliți recipientul.

Înainte de a începe să utilizați aparatul, este necesar să clătiți circuitele interne ale aparatului. Procedați în felul următor:

4. Cuplați maneta cupă suport de filtru (C1) la aparat: pentru o cuplare corectă, aliniați mânerul manetei cupă suport de filtru la simbolul “INSERT” (fig. 8) și rotiți mânerul spre dreapta, până când va fi aliniat la poziția “CLOSE”;
5. Puneți un recipient sub cupa suportului filtrului și a duzei de distribuire a aburului (A5);
6. Apăsăți tasta (B5) corespunzătoare indicatorului luminos (fig. 9): începe distribuirea;
7. După distribuire, rotiți butonul pentru abur (A4) (fig. 10) și distribuiți aburul câteva secunde pentru a clăti circuitul de abur: pentru o livrare optimă a aburului, se recomandă repetarea acestei operațiuni de 3 sau 4 ori. Acest lucru permite eliminarea apei din duză înainte de distribuirea aburului.

Apoi, aparatul este gata de utilizare.

**Rețineți:** limpezirea circuitelor interne este recomandată și în cazul neutilizării îndelungate a aparatului.

La prima utilizare, va trebui să preparați 4-5 cafele, până când aparatul va începe să dea cele mai bune rezultate: accordați o atenție deosebită dozei de cafea măcinată din filtru ((C2) sau (C3)) (consultați instrucțiunile din paragraful „4.1 Faza 1 - Măcinare (grinding) (fig. 11)”).

Procedați conform indicațiilor din capitolul „Doza perfectă”.

### 4. PREPARAREA CAFELEI

#### 4.1 Faza 1 - Măcinare (grinding) (fig. 11)

1. Vărsați boabele în recipient (A1) (fig. 12). Se recomandă să adăugați numai boabele necesare pentru preparare: în acest fel veți folosi întotdeauna cafea proaspătă;

2. Selectați gradul de măcinare (fig. 13). Setarea din fabrică este 5 (măcinare medie). Dacă rezultatul nu este satisfăcător, reglați nivelul în funcție de gustul personal și de tipul de cafea (reglarea trebuie făcută în timp ce rășnița de cafea funcționează).
3. Introduceți unul dintre filtrele de cafea (C2) sau (C3) în suportul filtrului (C1) (fig. 14). Dacă utilizați filtrul pentru 2 cești, apăsați tasta 2X (B3): cu această selecție, se dublează, de asemenea, cantitatea de espresso livrată.
4. Reglați mânerul pentru cantitate (B2) plecând de la poziția minimă (fig. 15).

#### Rețineți:



Numerele indicate pe afișaj (B19) sunt o referință de remarcă odată ce nivelul corect din suportul filtrului a fost atins.

Nu corespund cu setările de măcinare, greutatea cafelei măcinate (gr/oz) sau timpul de măcinare.

Consultați paragraful „B3. Tasta „X2”: pentru a utiliza filtrul cu 2 cafele” pentru informații suplimentare.

5. Cuplați suportul filtrului la orificiul de ieșire al rășniței, (A18), aliniați-l la mesajul INSERT: apoi, rotiți cupa spre dreapta (fig. 16). Măcinarea începe când cupa ajunge în poziția CLOSE și se întrerupe automat.

#### Reglați cantitatea de cafea măcinată în filtru

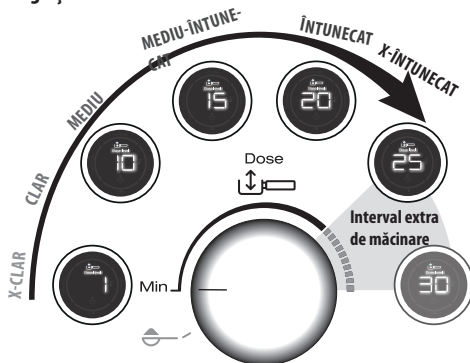

Fiecare varietate de boabe dă un rezultat diferit în timpul măcinării și, din acest motiv, la început, ajustarea dozei necesită foarte multă atenție.

Această ilustrație oferă indicații despre modul de ajustare a dozei, pe baza culorii de prăjire: acestea trebuie considerate un punct de plecare, dar pot varia în funcție de compoziția boabelor de cafea.

1. Setăți doza din poziția minimă.
2. Făcând referire la culoarea boabelor prăjite, rotiți încet mânerul.

## 4.2 Faza 2 - Presare (tamping) (fig. 17)

1. După măcinare, coborâți maneta de presare (A20) până la capăt (nu scoateți suportul filtrului) (fig. 18). Pentru un rezultat perfect, repetați de 2 ori.
2. Țineți maneta coborâtă până la sfârșit în timpul îndepărtării suportului filtrului (fig. 19). Apoi readuceți maneta în poziția sa inițială.
3. După ce ați verificat dacă doza de cafea este corectă (a se vedea „Doza perfectă”), atașați suportul filtrului la dozatorul de cafea (A7) (fig. 20).

### „Doza perfectă”

- Filtrule de cafea au o referință internă pentru a identifica doza perfectă.



- Filtrule cu marcaj laser: doza perfectă corespunde liniei superioare a marcajului;
- Filtrule cu marcaj în relief: doza perfectă corespunde liniei în relief;
- Asigurați-vă că după apăsare, cafeaua se încadrează în nivel. Poate fi necesar să reglați mânerul (B2) de mai multe ori înainte de a ajunge la doza perfectă.
- În cazul în care cafeaua este supra sau sub-extrasă și doza se încadrează în doza perfectă, reglați gradul de măcinare mai fin sau mai grosier (a se vedea „4.1 Faza 1 - Măcinare (grinding) (fig. 11)”). În cazul în care cafeaua este supra-extrasă (livrarea este prea lentă), măcinarea trebuie să fie mai grosieră. În cazul în care cafeaua este sub-extrasă (livrarea este prea rapidă), măcinarea va trebui să fie mai fină.
- **Barmanul recomandă:** Să îndepărtați suportul filtrului în timp ce maneta de presare (A20) este coborâtă pentru a obține o finisare perfectă a dozei de cafea.

## 4.3 Faza 3 - Distribuire (brewing) (fig. 21)

1. Selectați băutura dorită (fig. 22).
2. Apăsăți OK (B6) pentru a începe distribuirea (fig. 23) (pre-infuzie și infuzie). Distribuirea cafelei se oprește automat.

## 5. PREGĂTIREA BĂUTURILOR DIN LAPTE

### 5.1 Spumați laptele (fig. 24)

1. Se toarnă cantitatea de lapte care trebuie încălzită / spumată în recipientul pentru lapte (D8), ținând cont că volumul de lapte va crește de 2 sau 3 ori (fig. 25). Pentru a obține o spumă mai densă și mai omogenă, se recomandă

utilizarea laptelui integral de vacă la temperatura frigiderului (aproximativ 5 °C).

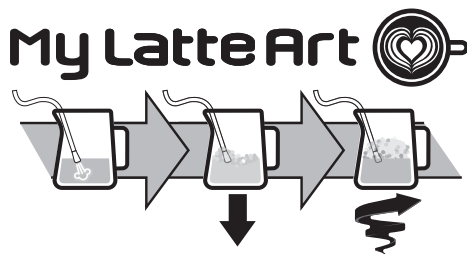

2. Pentru a spuma laptele, așezați duza de distribuire a aburului (A5) pe suprafața laptelui: procedând astfel, aerul se amestecă cu laptele și aburul.
3. Păstrați distribuitorul de abur pe suprafață, având grijă să nu captați prea mult aer, creând bule prea mari.
4. Scufundați distribuitorul de abur sub suprafața laptelui: în acest mod se creează un vârtej. Odată ce temperatura dorită este atinsă, închideți mânerul pentru abur și așteptați ca distribuirea aburului să se oprească complet înainte de a scoate ibricul de lapte.

### Barmanul recomandă:





- **Laptele proaspăt este cel mai bun.** Utilizați întotdeauna lapte proaspăt la temperatura frigiderului.
- Laptele integral asigură rezultate excelente. Rezultatul și textura spumei variază în funcție de laptele de vacă sau băuturile vegetale utilizate.
- După spumarea laptelui, îndepărtați bulele agitând ibricul de lapte.

### Curățarea dozatorului de abur:

1. După fiecare utilizare, îndepărtați cu o cârpă orice reziduuri de lapte din dozatorul de abur (fig. 26). Pentru o curățare în profunzime se recomandă să utilizați Eco MultiClean: asigură igiena prin îndepărtarea proteinelor și a grăsimilor din lapte și poate fi utilizat pentru curățarea întregului aparat.
2. Distribuți abur câteva secunde pentru a curăța bine dozatorul (fig. 10).
3. Așteptați ca distribuitorul să se răcească: pentru a menține eficiența dozatorului în timp, utilizați acul de curățare (C12) pentru a păstra cele 3 orificii libere (fig. 27).

## 5.2 Pregătiți băuturile din lapte cu sistemul LatteCrema (fig. 28)

1. Vărsați în recipient (D8) lapte la temperatura frigiderului (5 °C) (fig. 29).
2. Închideți capacul (D1) (fig. 30).
3. Rotiți butonul de reglare a spumei (D5) în poziția dorită (fig. 31).



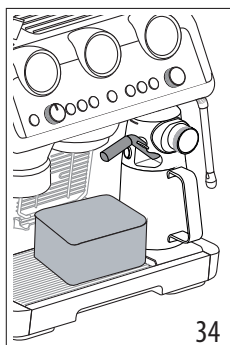
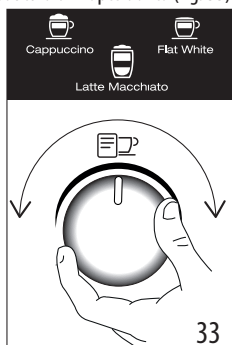

Poziția mânerului de reglare a spumei				
 CLEAN	 S p u m ă MAX	 S p u m ă MED	 S p u m ă MIN	 INSERT
Curățare după fiecare utilizare				Pentru a extrage sau a introduce mânerul

- Agățați recipientul pentru lapte la mașină (fig. 32).
- Pregătiți doza perfectă (a se vedea „4.1 Faza 1 - Măcinare (grinding) (fig. 11)” și „4.2 Faza 2 - Presare (tamping) (fig. 17)”) și introduceți suportul filtrului.
- Selectați băutura din lapte dorită (fig. 33).



- Ciclul de curățare începe și apoi se întrerupe automat. Atenție: după curățare, rotiți mânerul într-una din pozițiile de reglare a spumei.
  - Scoateți recipientul pentru lapte și puneți-l în frigider: se recomandă să folosiți laptele rămas în scurt timp.
- Pentru o curățare în profunzime se recomandă să utilizați Eco MultiClean: asigură igiena prin îndepărtarea proteinelor și a grăsimilor din lapte și poate fi utilizat pentru curățarea întregului aparat.

## 6. PERSONALIZAȚI LUNGIMEA BĂUTURILOR PE BAZĂ DE CAFEĂ PRIN FOLOSIREA TASTEI (B9)

- Pregătiți aparatul să distribuie 1 sau 2 cești de băutură pe bază de cafea, în funcție de câte doriți, până când fixați complet suportul filtrului (C1) de filtru (C2) sau (C3) și cafeaua măcinată. Dacă doriți să programați o băutură pe bază de lapte, conectați sistemul Lattecrema la aparat.
- Rotiți mânerul (B10) pentru a selecta băutura care urmează să fie programată.
- Apăsăți tasta : lumina corespunzătoare tastei OK (B6) se aprinde constant și lumina corespunzătoare tastei  clipește.
- Apăsăți tasta OK pentru a începe distribuirea. Luminile corespunzătoare tastelor OK și  clipește.
- Odată ce ați atins cantitatea dorită, apăsați OK. Dacă băutura necesită distribuirea unui alt ingredient, începe distribuirea acestuia din urmă: odată atinsă cantitatea dorită, apăsați OK.
- Apăsăți tasta  pentru a salva. Aparatul este gata pentru o nouă utilizare, iar indicatorul luminos  rămâne aprins. Dacă nu doriți să salvați programarea, apăsați orice altă tastă.

### Rețineți:

- Puteți programa băuturile pe bază de cafea, dar nu cu distribuire de abur și apă fierbinte.







Băutură	Espresso	Lapte	Spumă	Cantitate (ml)	X2 (ml)
Cappuccino	1	✓	✓	≈150	≈230
Latte Macchiato	1	✓	✗	≈150	≈230
Flat White	1	✓	✓	≈250	≈330

- Băuturi cu doză dublă (2x):** Turnați cantitatea de lapte necesară pentru preparare în recipientul (D8), având grijă să nu se depășească nivelul MAX (fig. 25). Fiecare semn de pe recipient corespunde cu ≈100 ml de lapte.
  - Laptele proaspăt este cel mai bun.** Utilizați întotdeauna lapte proaspăt la temperatura frigiderului.
- Apăsăți OK (B6) pentru distribuire (fig. 23). Aparatul prepară automat cafea și lapte în ordine.









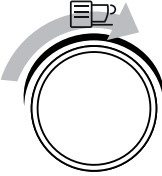

### Curățarea sistemului Lattecrema după fiecare utilizare:















- Lăsați recipientul pentru lapte atașat la mașină (nu este necesar să-l goliți). Așezați un recipient sub duza de distribuire a laptelui (D4) (fig. 34).
- Rotiți mânerul (D5) pe „Clean” (fig. 35).

- Programarea modifică toate cantitățile de băuturi, dar nu și de cafea măcinată.
- Băuturile „X2” pot fi programate separat.
- **My LatteArt**  nu este programabil.
- Pentru a reveni la setările din fabrică, țineți apăsată tasta  până când se stinge. Băutura selectată revine la cantitatea din fabrică.

Rețetă de cafea	Cantitate din fabrică	Cantitate programabilă
 Espresso	35 ml	de la 25 la 90 ml
 Espresso X2	70 ml	de la 50 la 180 ml
 Coffee	80 ml	de la 50 la 120 ml
 Coffee X2	160 ml	de la 120 la 240 ml
 Americano	120 ml	• espresso: de la 25 la 60 ml • apă: de la 25 la 120 ml
 Americano X2	240 ml	• espresso: de la 50 la 120 ml • apă: de la 50 la 240 ml

## 7. MENU SETĂRI

1. Intrați în meniu:		
Apăsați simultan timp de 5 secunde	x2	
2. Selectați modul de setare de programat:		
		
Băutură	Setare corespunzătoare	Ajustări
 Espresso	Consum redus de energie	 ➔  Activ
		 ➔  Oprit
 Coffee	Oprire automată	 ➔ 9 minute
		 ➔ 1,5 ore
		 ➔ 3 ore
➔		

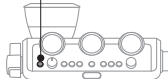
 Cappuccino	Avizare acustică	 ➔  Activ
		 ➔  Oprit
 Latte	Reglare suplimentară a măcinării	 ➔ Interval 1
		 ➔ Interval 2
 Flat White	Valori din fabrică	Țineți apăsat butonul OK timp de cel puțin 5 secunde, până când lumina rămâne aprinsă constant
 Americano	Duritate apă	 ➔ dulce
		 ➔ medie
		 ➔ dură/foarte dură
3. Salvați noile setări apăsând ON/Standby (B1)		
 		













## 8. CURĂȚAREA APARATULUI

### Atenție!

- Pentru curățarea aparatul nu folosiți solvenți, detergenți abrazivi sau alcool.
- Nu utilizați obiecte metalice pentru a îndepărta depunerile de calcar sau de cafea, deoarece ar putea zgâria suprafețele din metal sau din plastic.
- Pentru perioade de neutilizare mai lungi de o săptămână, se recomandă clătirea acestuia înainte de a utiliza aparatul.

### Pericol!

- În timpul operațiunilor de curățare, nu introduceți niciodată aparatul în apă: este un aparat electric.
- Înainte de orice operațiune de curățare a părților externe ale aparatului, opriți aparatul, scoateți ștecherul din priză de curent și lăsați-l să se răcească.



					
	×	✓	✓	×	×
	✓	×	×	✓	✓
	×	×	×	✓	✓
	×	×	×	✓	✓
	×	×	✓	✓	×
	×	×	×	✓	✓
	✓	✓	×	✓	✓

### 8.1 Curățarea dozatorului de cafea

Când lumina  se aprinde (portocalie) (B5), este necesar să curățați circuitul de cafea. Pentru a rula ciclul de curățare, cumpărați pastile pentru curățarea aparatelor de cafea. Pentru mai multe informații, vizitați [www.Delonghi.com](http://www.Delonghi.com).

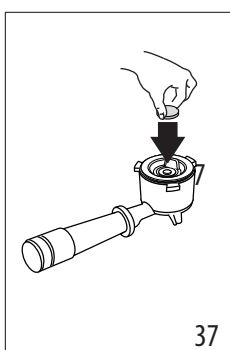
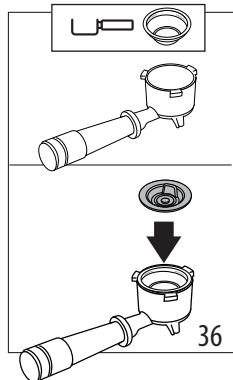
1. Introduceți filtrul de 1 ceașcă (C2) în suportul filtrului (C1) (fig. 36).
2. Introduceți accesoriul de curățare (C9) în filtru (fig. 36) și apăsați-l complet.



3. Puneți pastila de curățat pe accesoriu (fig. 37).
4. Atașați suportul filtrului la dozatorul de cafea (A7).
5. Umpleți rezervorul de apă (A15). Asigurați-vă că tava de scurgere (A11) este goală.
6. Mențineți apăsată tasta  până când lumina corespunzătoare începe să clipească (portocaliu). După câteva minute, curățarea se oprește automat.
  - Scoateți suportul filtrului și accesoriul de curățare.
  - Spălați suportul filtrului și filtrul cu apă de la robinet.
  - Reintroduceți suportul filtrului și continuați cu clătirea apăsați tasta  (B5): se recomandă să amplasați un recipient sub suportul filtrului.
  - Scoateți și goliți tava de scurgere.

#### Rețineți:

Acest ciclu de curățare poate fi pornit în orice moment prin apăsarea tastei  (B5) timp de câteva secunde. Pentru a anula operațiunea, apăsați butonul timp de 10 secunde.

### 8.2 Curățați carcasa recipientului pentru boabe

1. Asigurați-vă că recipientul pentru boabe (A1) este gol. Dacă este necesar, continuați cu unele măcinări în gol pentru a-l goli.
2. Desprindeți recipientul rotindu-l în sens invers acelor de ceasornic și scoateți-l din aparat (fig. 38)

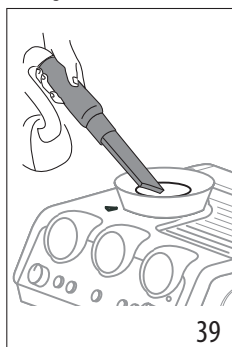
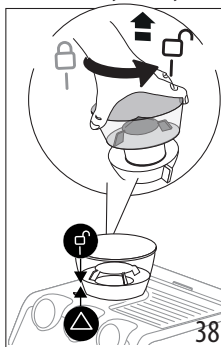

3. Aspirăți resturile de cafea (fig. 39).
4. Curățați locul recipientului pentru boabe cu o cârpă umedă și uscați (fig. 40);

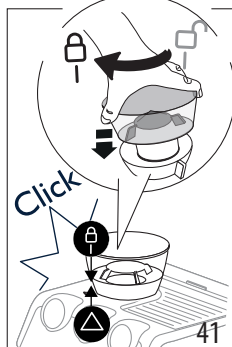
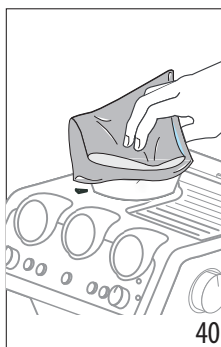

5. Repoziționați recipientul, introducându-l în rășnița de cafea. Recipientul este introdus corect când săgeata ▲ este aliniată cu simbolul ☞ și se aude un „clac” (fig. 41).

### 8.3 Curățarea rășnițelor

Când curățați recipientul pentru boabe (A1), curățați locașul recipientului și lama de măcinare superioară cu o cârpă umedă. Contactați un centru de service pentru a îndepărta și înlocui rășnițele. Lama de măcinare poate fi îndepărtată dacă rășnița este blocată de un corp străin. Dacă se întâmplă acest lucru, scoateți recipientul pentru boabe și procedați după cum urmează:

1. Atașați cupa suportului de filtru (C1) și măcinați „in gol” pentru a elibera conducta de cafea.
2. Închideți aparatul.
3. Rotiți butonul de reglare măcinare în sens invers acelor de ceasornic până la capăt, în poziția „REMOVE” (fig. 42).

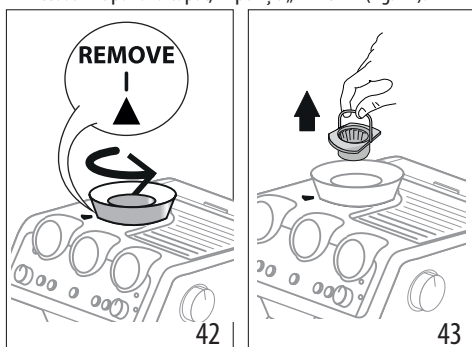

4. Scoateți partea superioară a lamei de măcinare, apucând-o de mâner (fig. 43).
5. Curățați lama de măcinare cu o pensulă (fig. 44) și aspirați resturile de cafea, cu un aspirator (fig. 39).

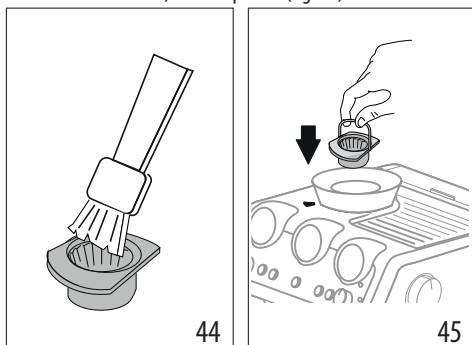

6. introduceți lama de măcinare în locașul său (fig. 45);
  7. rotiți regulatorul selectând gradul de măcinare dorit (fig. 13);
- verificați ca lama de măcinare să fie bine introdusă, trăgând-o de mâner: aceasta este introdusă corect dacă nu se mișcă;

### 8.4 Înlocuirea lamelor de măcinare

Când cantitatea de cafea măcinată continuă să se reducă, contactați un centru de service pentru a înlocui lamele de măcinare: apoi reglați din nou rășnița intrând în meniul de setări („7. Meniu setări”) și selectând primul interval de reglare suplimentar al măcinării. Apoi, rotiți butonul de reglare a cantității (B2) în poziția MIN și reglați doza ca la prima utilizare (vezi „Doza perfectă”).

### 8.5 Curățarea „Smart tamping station”

1. Curățați zona de fixare cu o pensulă (fig. 46).
2. Trageți maneta (A20) până la capăt și curățați maneta de presare cu o perie (fig. 47), apoi eliberați maneta.
3. Cu ajutorul periei (C8) curățați ștuțul de cafea (fig. 48).

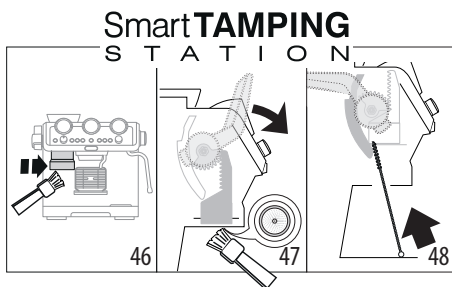

### 8.6 Curățarea sistemului LatteCrema

Spălați toate componentele și recipientul în mașina de spălat vase, dar rețineți că trebuie așezate în sertarul din partea de sus al mașinii de spălat vase. Dacă nu dețineți o mașină de spălat vase, le puteți spăla manual, urmând instrucțiunile din cuprinsul notei de la finalul paragrafului.

1. Apăsăți butonul (D3) și ridicați capacul recipientului de lapte (D1);
2. Scoateți dozatorul de lapte (D4) și duza de preluare ((D7) (fig. 49);

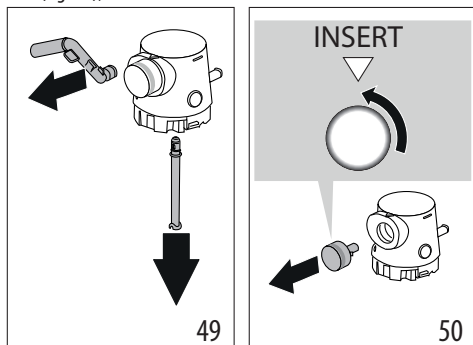



3. Rotiți mânerul în poziția „Insert” și scoateți-l (fig. 50);
4. Fiți foarte atenți să nu existe reziduuri de lapte în locașul și canalul situate sub mâner (fig. 51): dacă este necesar, răzuțiți canalul cu o scobitoare;

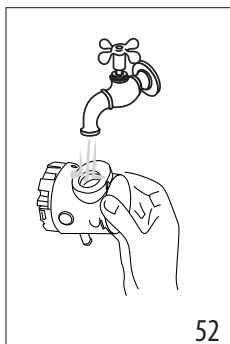
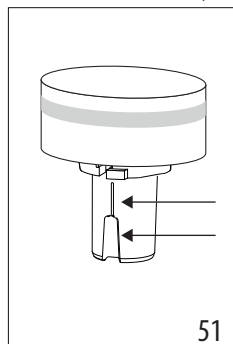

5. Clătiți interiorul locașului but. de regl. a spumei sub jet de apă (fig. 52);
6. Verificați dacă duza de preluare și cea de distribuire a laptelei nu sunt înfundate cu resturi de lapte;
7. Asamblați la loc toate componentele capacului;
8. Spălați cu atenție și clătiți recipientul pentru lapte (D8) ;
9. Prindeți la loc capacul pe recipientul pentru lapte.

### Rețineți: spălare la mână

Spălarea în mașina de spălat vase asigură o perfectă igienizare a tuturor componentelor recipientului pentru lapte: în cazul spălării la mână, spălați foarte bine toate componentele recipientului pentru lapte cu apă caldă, apoi scufundați-le într-un bol cu apă caldă și lăsați-le aproximativ 30 de minute, înainte de a acționa conform instrucțiunilor de la punctul 4.

## 9. DURITATE APĂ

Indicatorul luminos [B8] (B8) de decalcifiere se aprinde după o anumită perioadă de funcționare prestabilă, care depinde de duritatea apei. Este posibilă programarea aparatului în funcție de duritatea reală a apei folosită în diferite regiuni, efectuând astfel, mai rar, operațiunea de decalcifiere.

1. Scoateți din ambalaj banda reactivă furnizată “TOTAL HARDNESS TEST” (C4).
2. Introduceți complet banda într-un pahar cu apă, timp de aproximativ o secundă.
3. Scoateți banda din apă și scuturați-o ușor. Configurați aparatul, astfel cum este indicat în capitolul „7. Meniu setări”.

Rezultatul testului de duritate a apei	Tastă	Nivel
	× 2	1 apă dulce

Rezultatul testului de duritate a apei	Tastă	Nivel
		2 apă medie
	OK	3 apă dură sau foarte dură

4. Configurați aparatul, astfel cum este indicat în capitolul „7. Meniu setări”.

## 10. CUM SĂ UTILIZAȚI SOFTBALLS

Softballs (C11) este un sistem inovator care prelungeste durata de viață a mașinii, fără modificarea calității apei, asigurând distribuția unei cafele cremoase și aromate. Pentru a optimiza eficiența, lăsați Softballs în apă toată noaptea înainte de utilizare.

1. Scoateți pachetul de Softballs din ambalaj (fig. 53).

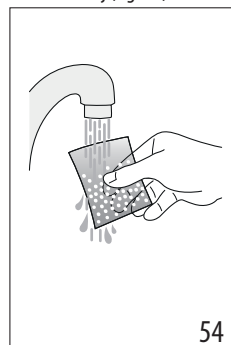
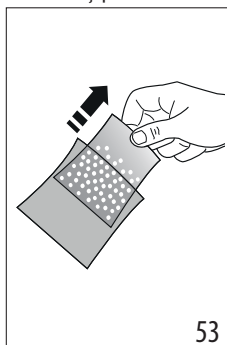

2. Clătiți cu apă de la robinet pachetul de Softballs (fig. 54).
3. Introduceți punga în rezervorul de apă (A15) (fig. 55).

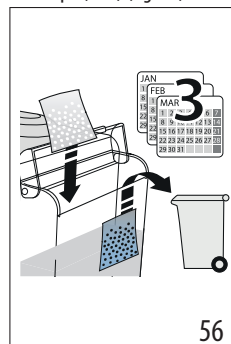
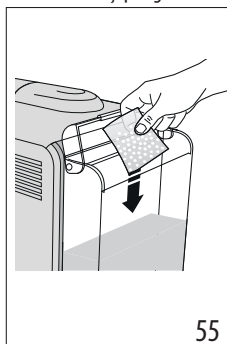

4. Înclocuiți punga de Softballs la fiecare 3 luni (fig. 56).

## 11. DECALCFIERE

### Atenție!

- Înainte de utilizare, citiți instrucțiunile și eticheta produsului de decalcfiere (C5), aflate pe ambalajul acestuia.
- Se recomandă să utilizați numai decalcfiant De'Longhi. Utilizarea unor decalcfianți necorespunzători, precum și o decalcfiere care nu este efectuată cu regularitate, poate duce la apariția unor defecțiuni ce nu sunt acoperite de garanția producătorului.
- Decalcfiantul poate deteriora suprafețele delicate. În caz de vărsare accidentală a produsului, ștergeți-l imediat.

### Pentru a efectua ciclul de decalcfiere

Decalcfiant	Decalcfiant De'Longhi
Recipiente	2 de 1 litru fiecare
Timp	~ 40min

1. (DACĂ ESTE PREZENT, ÎNDEPĂRTAȚI FILTRUL DE DEDURIZARE ȘI SOFTBALLS). Vărsați în rezervorul de apă (A15) decalcfiantul până la nivelul  A (corespunzător unui pachet de 100 ml) marcat în interiorul rezervorului (fig. 57).

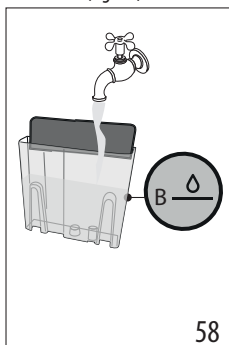
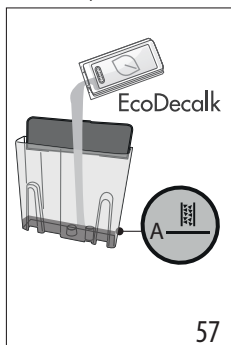

2. Adăugați apă până la atingerea nivelului  B (fig. 58). Apoi puneți rezervorul de apă înapoi în mașină.
3. Introduceți accesoriul (C6) în conectorul sistemului LatteCrema (A6) (fig. 59).

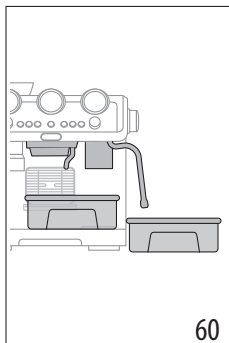
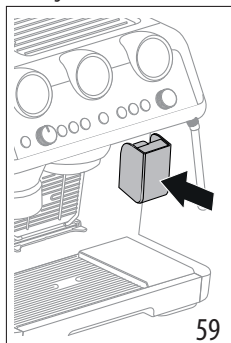

4. Asigurați-vă că suportul filtrului (C1) nu este agățat și așezați un recipient sub dozatoarele de cafea și apă caldă (A7) și sub distribuitorul de vapori (A5) (fig. 60).
5. Mențineți apăsată tasta  (B8) până când lumina corespunzătoare începe să clipească.
6. Programul de decalcfiere începe și lichidul de decalcfiere iese din distribuitor. Programul de decalcfiere execută automat o serie de clătiri la intervale de timp, pentru a îndepărta reziduurile de calcar din interiorul aparatului de preparat cafea până la golirea completă a rezervorului.

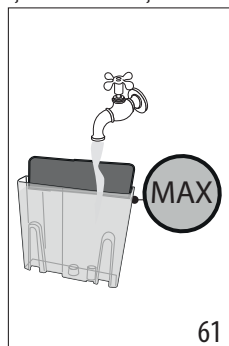

Distribuirea se oprește și lumina  devine albă. Prin urmare, este necesar să continuați cu ciclul de clătire:

7. Goliți recipientul folosit pentru colectarea lichidului de decalcfiere și plasați-l sub dozatoare.
8. Scoateți rezervorul de apă, goliți-l de eventuale reziduuri de soluție de decalcfiere, clătiți-l cu apă curentă și umpleți-l cu apă proaspătă până la nivelul MAX (fig. 61). Apoi reintroduceți rezervorul în locașul său.

























9. Țineți apăsată tasta  până când lumina corespunzătoare începe să clipească: începe clătirea.
  10. Odată ce clătirea este completă, distribuția se oprește și aparatul este gata de utilizare.
  11. Goliți recipientele pentru colectarea apei de clătire.
  12. Scoateți și goliți tava pentru colectarea picăturilor, apoi reintroduceți-o.
  13. Scoateți și umpleți rezervorul cu apă proaspătă, apoi reintroduceți-l.
- Acum aparatul este gata de utilizare.

### Rețineți:

- Dacă doriți să anticipați ciclul de decalcfiere, țineți apăsată tasta  timp de 3 secunde.
- Dacă decalcfierea a fost pornită din greșeală, țineți apăsată tasta  timp de 10 secunde; clătirea nu poate fi întreruptă.



## 12. SEMNIFICAȚIA INDICATOARELOR LUMINOASE

INDICATOARE LUMINOASE	SEMNIFICAȚIA INDICATOARELOR LUMINOASE	Operațiune
Toate indicatoarele clipeșc scurt	Pornirea aparatului	Diagnosticare automată
 fixă	Este prima pornire a aparatului și este necesară umplerea circuitului de apă	Procedați astfel cum este indicat în cap. „3. Prima punere în funcțiune a aparatului”
 fixă	Funcția de economisire a energiei este activă	Consultați cap.„7. Meniu setări” dacă doriți să dezactivați funcția
 fixă	Recipientul pentru boabe (A1) este gol	Reumpleți recipientul pentru boabe
 intermitentă	Doriți să continuați cu măcinarea, dar recipientul pentru boabe (A1) este gol	Reumpleți recipientul pentru boabe
 on	Nu există suficientă apă în rezervorul (A15) sau rezervorul de apă nu este bine introdus	Reumpleți rezervorul sau scoateți-l și reintroduceți-l în mod corect
 intermitentă	Doriți să continuați cu pregătirea unei băuturi, dar rezervorul de apă (A15) este gol	Umpleți rezervorul cu apă
 fixă	Alarmă generală	Adresați-vă unui centru de asistență
 fixă	Recipientul pentru boabe nu este introdus	Introduceți corect recipientul pentru boabe (A1) sau verificați dacă este introdus corect
 intermitentă	Selectorul de la baza recipientului pentru boabe (A1) nu este în poziția corectă	Întoarceți selectorul într-una din pozițiile de măcinare (între 1 și 8), amintindu-vă că: <ul style="list-style-type: none"> <li>• Reglați măcinarea în timp ce râșnița de cafea este în funcțiune</li> <li>• Reglați un nivel pe rând și faceți cel puțin 5 măcinări între o reglare și următoarea</li> </ul>
	Recipientul pentru boabe (A1) nu este complet introdus: intervine dispozitivul de siguranță	Verificați dacă recipientul pentru boabe este introdus corect
 fixă	Sistemul LatteCrema trebuie curățat după fiecare utilizare	După terminarea preparatelor pe bază de lapte, continuați cu această curățare automată prin rotirea mânerului (D5) pe Clean
 fixă	Aparatul este gata să distribuie abur.	Aparatul a atins temperatura pentru a distribui abur. Pentru a continua distribuirea, rotiți butonul pentru abur (A4)
		→

INDICATOARE LUMINOASE	SEMNIIFICAȚIA INDICATOARELOR LUMINOASE	OPERAȚIUNE
 intermitentă	Aparatul este pornit, iar funcția de economisire a energiei este activă: butonul de abur (A4) este în poziția de distribuire a aburului	Indicatorul clipește pentru a indica faptul că aparatul se pregătește să distribuie abur: distribuirea începe imediat ce aparatul este în stare de funcționare
	Aparatul este gata să distribuie abur	Aparatul este la temperatura de preparare a aburului atunci când lumina rămâne fixă
	Aparatul distribuie abur	
 fixă (portocalie)	Este necesar să continuați procesul de decalcifiere	Efectuați decalcifierea după cum este ilustrat în cap.,11. Decalcifiere”
 intermitentă (portocalie)	Aparatul efectuează operația de decalcifiere	Continuați prin terminarea operațiunii așa cum este descris în cap.,11. Decalcifiere”
 fixă (albă)	Este necesar să continuați cu clătirea	
 intermitentă (albă)	Aparatul efectuează clătirea	
 fixă (portocalie)	Este necesar să continuați să curățați dozatorul de cafea	A se vedea par.,8.1 Curățarea dozatorului de cafea”
	Aparatul curăță dozatorul de cafea	
 intermitentă (portocalie)	Aparatul efectuează o clătire	
 intermitentă (albă)		
 +  intermitentă	Dacă filtrul de dedurizare este prezent, este posibil ca o bulă de aer să fi intrat în circuit, împiedicând distribuirea	Apăsăți tasta (B7) corespunzătoare lumini  : distribuția începe și se oprește automat.
	Măcinarea este prea fină, iar din acest motiv cafeaua curge foarte lent sau nu curge toată.	Scoateți cupa suportului de filtru (C1), repetați operațiunile de preparare a cafelei, ținând cont de indicațiile de la par.,4.1 Faza 1 - Măcinare (grinding) (fig. 11)” și „4.2 Faza 2 - Presare (tamping) (fig. 17)”
	Filtrul de cafea (C2) sau (C3) este înfundat	Clătiți filtrele cu apă curentă sau clătiți cu tasta de clătire (B5).
	Rezervorul (A15) nu este introdus corect și supapele corespunzătoare nu sunt deschise	Apăsăți ușor rezervorul pentru a deschide supapele
	Calcar în interiorul circuitului de apă	Executați decalcifierea conform cap. „11. Decalcifiere”.

### 13. DACĂ CEVA NU FUNCȚIONEAZĂ

PROBLEMĂ	CAUZĂ	SOLUȚIE
Există apă în tava de colectare a picăturilor (A11)	Face parte din funcționarea normală a circuitelor interne ale mașinii	Goliți și curățați tava de colectare a picăturilor (A11) în mod regulat
		→

<b>PROBLEMĂ</b>	<b>CAUZĂ</b>	<b>SOLUȚIE</b>
Nu mai iese cafeaua espresso	Lipsa apei în rezervor (A15)	Umpleți rezervorul
	Indicatorul luminos  (B7) se aprinde, indicând faptul că circuitul de cafea sau cel de abur este gol.	Apăsăți tasta din dreptul indicatorului luminos  pentru a umple circuitul.
	Filtrul (C2) sau (C3) este blocat	Clățiți filtrele cu apă curentă sau clățiți cu tasta de clătire (B5)
	Rezervorul (A15) nu este bine introdus și supapele din partea de jos nu sunt deschise	Apăsăți ușor rezervorul, astfel încât să se deschidă supapele din partea de jos
	Calcar în interiorul circuitului de apă	Executați decalcifierea conform cap. „11. Decalcifiere”.
	Măcinarea este prea fină	Scoateți cupa suportului de filtru (C1), repetați operațiunile de preparare a cafelei, ținând cont de indicațiile de la par. „4.1 Faza 1 - Măcinare (grinding) (fig. 11)” și „4.2 Faza 2 - Presare (tamping) (fig. 17)”
Suportul de filtru nu se atașează la aparat	Cafeaua măcinată nu a fost presată sau este prea multă	Repețiți măcinarea cu diferite setări. Reduceți cantitatea dozei: verificați dacă filtrul (C2) sau (C3) (1 sau 2 cești) este corect pentru doza care trebuie măcinată (butonul 2x (B3) este selectat sau nu)
Cafeaua espresso se scurge de pe marginea suportului de filtru (C1) în loc să se scurgă din orificii	Suportul de filtru nu este bine introdus	Introduceți corect suportul de filtru și rotiți-l cu putere până la capăt
	Garnitura dozatorului de cafea (A7) și-a pierdut elasticitatea sau este murdară	Înlocuiți garnitura dozatorului de cafea la un centru de service
	Filtrul (C2) sau (C3) este blocat	Clățiți filtrele cu apă curentă sau clățiți cu tasta de clătire (B5)
Crema cafelei este deschisă la culoare (coboară prea repede din duză)	Este necesar să revizuiți setările aparatului	Scoateți cupa, repetați operațiunile de preparare a cafelei, ținând cont de indicațiile din par. „4.1 Faza 1 - Măcinare (grinding) (fig. 11)” și „4.2 Faza 2 - Presare (tamping) (fig. 17)”
Crema cafelei are o culoare închisă (cafeaua curge lent din duză)	Este necesar să revizuiți setările aparatului	Scoateți cupa suportului de filtru (C1), repetați operațiunile de preparare a cafelei, ținând cont de indicațiile de la par. „4.1 Faza 1 - Măcinare (grinding) (fig. 11)” și „4.2 Faza 2 - Presare (tamping) (fig. 17)”
		→

PROBLEMĂ	CAUZĂ	SOLUȚIE
Nu se formează spuma de lapte în timp ce preparați cappuccino cu sistemul LatteCrema	Laptele nu este suficient de rece	Folosiți întotdeauna numai lapte de la frigider
	Mănerul (D5) nu se află în poziție corectă	Verificați și rotiți mânerul în poziția corectă (☞ spumă max; ☞ spumă med; ☞ spumă min)
	Sistemul LatteCrema este murdar	Continuați să curățați astfel cum este ilustrat în paragraful „8.6 Curățarea sistemului LatteCrema”
	Calcar în interiorul circuitului de apă	Executați decalcifierea conform cap. „11. Decalcifiere”.
La terminarea decalcifierii, aparatul va avea nevoie de o nouă clătire	În timpul ciclului de clătire, rezervorul nu a fost umplut până la nivelul MAX	Repețiți clătirea (a se vedea cap. „11. Decalcifiere”)
Aparatul nu macină cafeaua	Există un corp străin în râșnița de cafea	Continuați să curățați moriștile astfel cum este indicat în par. „8.3 Curățarea râșnițelor”, asigurându-vă că ați îndepărtat toate boabele din recipientul pentru boabe (A2) înainte de a-l scoate. Înainte de a reintroduce râșnița, aspirați cu grijă orice reziduu din locaș
	Recipientul pentru boabe (A1) nu se află în poziție corectă	Recipientul este introdus corect când săgeata ▲ este aliniată cu simbolul ☞ și se aude un „clac”
Dacă se dorește modificarea calității cafelei	Este necesară îndepărtarea tuturor boabelor prezente în aparat	<ul style="list-style-type: none"> <li>• Goliți recipientul pentru boabe (A1) (efectuând cicluri de măcinare în gol sau, eventual, aspirând boabele rămase).</li> <li>• Fixați cupa pentru suportul filtrului (C1) și efectuați o măcinare „în gol” pentru a elibera tubul de cafea: fixați apoi suportul filtrului la orificiul de ieșire al râșniței, (A18), aliniindu-l cu mesajul INSERT și răsucind cupa spre dreapta (fig. 22). Măcinarea începe când cupa ajunge în poziția CLOSE și se întrerupe automat. Repetați până când filtrul rămâne gol</li> <li>• Introduceți noua varietate de boabe de cafea în recipientul (A1)</li> <li>• Dacă „doza perfectă” nu este atinsă în timpul măcinării, procedați ca la prima utilizare</li> </ul>
		→

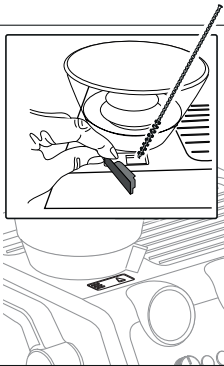
PROBLEMĂ	CAUZĂ	SOLUȚIE
<p>După măcinare, filtrul de cafea (C2) sau (C3) este gol</p> <p>După măcinare, pulberea de cafea din filtru este superabundentă</p>	<p>Ștuțul de cafea al râșniței este înfundat</p>	<p>Continuați să curățați astfel cum este indicat în par. „8.5 Curățarea „Smart tamping station””. Dacă problema persistă, accesați ștuțul deschizând ușița (A19) și eliberând-o folosind peria</p> 
<p>După măcinare, pudra de cafea din filtrul (C2) sau (C3) nu atinge „doza perfectă”</p>	<p>Este necesară curățarea "Smart Tamping Station"</p> <p>Este necesară reglarea cantității de cafea măcinată</p> <p>În timp, lamele de măcinare se uzează</p>	<p>Continuați să curățați astfel cum este indicat în par. „8.5 Curățarea „Smart tamping station””, apoi repetați măcinarea</p> <p>Reglați cantitatea, folosind butonul rotativ aferent (B2) și urmând instrucțiunile din par. „Doza perfectă”. Dacă mânerul este deja în poziția maximă, procedați conform indicațiilor din secțiunea „Reglare suplimentară a măcinării”</p> <p>Înlocuiți lamele de măcinare, urmând indicațiile din par. „8.4 Înlocuirea lamelor de măcinare”</p>

المشكلة	السبب	الحل
إن كنت ترغب في تغيير جودة القهوة	يلزم إزالة جميع حبوب البن الموجودة في الماكينة	<ul style="list-style-type: none"> <li>• أفرغ حاوية حبوب القهوة (A1) عن طريق الطحن الفارغ أو ربما شطف الحبوب المتبقية)</li> <li>• ثبت كأس حامل المرشح (C1) ونفذ عملية طحن "على الفارغ" من أجل تحرير مسار القهوة: ثم ثبت حامل المرشح في مخرج مطحنة القهوة (A18) بمحاذاة الكتابة INSERT (إدخال) ولف الكأس تجاه اليمين (الشكل 22). تبدأ عملية الطحن عندما يصل الكوب إلى الوضع "غلق" CLOSE وتتوقف تلقائيًا. كرر العملية حتى يصبح المرشح فارغًا. أدخل في الحاوية (A1) نوعية حبوب القهوة الجديدة</li> <li>• غذا لم يتم الوصول إلى الكمية المثالية عند الطحن، قم بإجراء الاستخدام الأول للماكينة</li> </ul>
بعد عملية الطحن مرشح القهوة (C2) أو (C3) فارغ	يكون مسار البن في ماكينة طحن البن مسدود	<p>قم بتنظيفه كما هو مبين في الفقرة «8.5 تنظيف Smart tamping station». إذا ما استمرت المشكلة ادخل إلى المنزلق عبر فتح المنفذ الصغير (A19) المعد خصيصًا لذلك ثم حرره باستخدام فرشاة التنظيف</p> 
بعد عملية الطحن مسحوق القهوة في المرشح (C2) أو (C3) لا يصل إلى الكمية المثالية	يحتاج "خزان الطحن الذي" للتنظيف	<p>قم بتنظيفه كما هو مبين في الفقرة «8.5 تنظيف Smart tamping station»، ثم كرر عملية الطحن</p>
	يلزم ضبط كمية البن المطحون	<p>اضبط الكمية بواسطة مقبض مخصص (B2) مع اتباع الإرشادات الموجودة في الفقرة. «الكمية المثالية». إذا كان المقبض بالفعل في وضعية الحد الأقصى MAX، قم بما هو محدد في القسم «ضبط إضافي للطحن»</p>
	بمضي الوقت تتهاك شفرات المطحنة	<p>اشرع في استبدال رجلي المطحنة كما هو مبين في الفقرة «8.4 استبدال المطاحن»</p>



المشكلة	السبب	الحل
حامل المرشح غير مثبت جيدًا في الجهاز	لم يتم الضغط على القهوة المطحونة أو كمية القهوة مفرطة	كرر عملية الطحن بإعدادات ضبط مختلفة. قلل كمية القهوة: تحقق من أن المرشح (C2) أو (C3) (1 أو 2 فنجان) مناسب من حيث الكمية المراد طحنها (الزر (B3) 2x مختار أمر لا)
القهوة الإسبرشو تتقطر من على جوانب حامل المرشح (C1) بدلًا من الثقوب	حامل المرشح مركب بشكل خاطئ	ثبّت حامل المرشح بالشكل الصحيح ثم لفّه بقوّة حتّى النهاية
	حشوة إحكام غلق موزع سكب القهوة (A7) فقدت مرونتها أو متسخة	استبدل حشوة إحكام غلق موزع سكب القهوة لدى أحد مراكز الصيانة والدعم الفني
	المرشح (C2) أو (C3) مسدود	اشطف المرشحات تحت ماء جارٍ أو قم بإجراء عملية شطف باستخدام الزر المخصص لذلك (B5)
كريمة القهوة فاتحة اللون (تدقق بشكل سريع من الصنبور)	يجب بالضرورة مراجعة إعدادات ضبط الجهاز	استخرج الكوب، وكرر العمليات لعمل القهوة مع اتباع التعليمات الواردة في الفقرة. «4.1 المرحلة 1 - الطحن (grinding) (الشكل 11)» و «4.2 المرحلة 2 - الضغط (tamping) (الشكل 17)»
كريمة القهوة داكنة اللون (القهوة تتدقق بشكل بطئ من الصنبور)	يجب بالضرورة مراجعة إعدادات ضبط الجهاز	استخرج كأس حامل المرشح (C1)، وكرر عمليات إعداد القهوة مع اتباع التعليمات الواردة في الفقرة. «4.1 المرحلة 1 - الطحن (grinding) (الشكل 11)» و «4.2 المرحلة 2 - الضغط (tamping) (الشكل 17)»
لا تتكوّن رغوة الحليب أثناء إعداد الكابتشينو عبر LatteCrema System	الحليب ليس باردًا بالشكل الكافي	استعمل دائمًا حليّتا بدرجة حرارة التلّاجة
	المقبض (D5) ليس موجودًا في الوضعية الصحيحة	افحص ولف المقبض في الوضعية الصحيحة (  الحد الأقصى للرغوة؛  الحد المتوسط للرغوة؛  الحد الأدنى للرغوة )
	LatteCrema System متسخ	ابدأ في عملية التنظيف كما هو موضح في الفقرة «8.6 تنظيف LatteCrema System»
	تكون ترسبات كلسية في الدائرة المائية	قم بتنفيذ إزالة الترسبات الكلسية على النحو الوارد في فصل. «11. التخلص من الترسبات»
بمجرد انتهاء عملية إزالة الترسبات الكلسية، سيقوم الجهاز بدورة الشطف الثالثة	أثناء دورتي الشطف، لا يكون خزان الماء ممتلئًا بالماء حتى المستوى الأقصى MAX	كرر عملية الشطف (انظر الفصل «11. التخلص من الترسبات»)
الجهاز لا يطحن القهوة	هناك جسم غريب داخل مطحنة القهوة	ابدأ في عملية الطحن كما هو مُحدّد في الفقرة. «8.3 تنظيف رجي المطحنة»، مع التحقق من إزالة جميع الحبوب من وعاء الحبوب (A2) قبل استخراجها. قبل إعادة إدخال رجي الطحن قم بشطف اية بقايا بعناية من مكان الرجي
	حاوية حبوب القهوة (A1) غير موجودة في الوضعية الصحيحة	تصح الحاوية موضوعة بالشكل الصحيح في مكانها عندما يكون السهم ▲ مضبوط المحاذاة مع الرمز  وعند سماع صوت "نقرة"



المؤشرات	معنى المؤشرات	العملية
	ثابتة الإضاءة (باللون الأبيض)	يصبح من الضروري إجراء عملية الشطف
	تومض (باللون الأبيض)	ينفذ الجهاز عملية الشطف حالياً
	ثابتة الإضاءة (باللون البرتقالي)	يجب بالضرورة إجراء عملية تنظيف لموزع سكب القهوة
	تومض (باللون البرتقالي)	الجهاز يقوم الآن بتنظيف موزع سكب القهوة
	تومض (باللون الأبيض)	يقوم الجهاز بعملية شطف حالياً
	وامضة	في حالة وجود مرشح منقى تحلية المياه يمكن أن تدخل فقاعة هواء في دائرة التشغيل الأمر الذي يمنع عملية السكب
		استخرج كأس حامل المرشح (C1)، وكرر عمليات إعداد القهوة مع اتباع التعليمات الواردة في الفقرة. «4.1 المرحلة 1 - الطحن (grinding) (الشكل 11)» و «4.2 المرحلة 2 - الضغط (tamping) (الشكل 17)»
		اشطف المرشحات تحت ماء جارٍ أو قمر بإجراء عملية شطف باستخدام زر الشطف (B5).
		تم تركيب الخزان (A15) بشكل خاطئ والصمامات الخاصة به غير مفتوحة
		تكون ترسبات كلسية في الدائرة المائية فصل. «11. التخلص من الترسبات»

### 13. إذا حدث وتعرض شيء ما للعطل

المشكلة	السبب	الحل
هناك ماء في حوض تجميع القطرات (A11)	إنه جزء من التشغيل الطبيعي للدوائر الداخلية في الماكينة	قمر بتفريغ وتنظيف حوض تجميع القطرات (A11)
لم تعد تخرج القهوة الإسبرسو	ربما بسبب قلة الماء في الخزان (A15)	املاً خزان الماء
	المؤشر  (B7) مضاء للإشارة إلى أن دائرة القهوة أو دائرة البخار فارغة.	اضغط على المفتاح المطابق للضوء  لملء الدائرة.
	المرشح (C2) أو (C3) مسدود	اشطف المرشحات تحت ماء جارٍ أو قمر بإجراء عملية شطف باستخدام الزر الخاص بذلك (B5)
	تم تركيب الخزان (A15) بشكل خاطئ و الصمامات في القاع غير مفتوحة	اضغط بلطف على الخزان حتى يتم فتح الصمام الذي في القاع
	تكون ترسبات كلسية في الدائرة المائية	قمر بتنفيذ إزالة الترسبات الكلسية على النحو الوارد في فصل. «11. التخلص من الترسبات»
	الطحن المفرطة النعومة	استخرج كأس حامل المرشح (C1)، وكرر عمليات إعداد القهوة مع اتباع التعليمات الواردة في الفقرة. «4.1 المرحلة 1 - الطحن (grinding) (الشكل 11)» و «4.2 المرحلة 2 - الضغط (tamping) (الشكل 17)»



المؤشرات	معنى المؤشرات	العملية
تومض جميع المؤشرات قليلاً	تشغيل الجهاز	فحص ذاتي
 ثابتة الإضاءة	إنها أول مرة لتشغيل الماكينة ويلزم الشروع في ملء دائرة الماء	اتبع التعليمات الواردة في الفقرة. «3. استعمال الجهاز لأول مرة»
 ثابتة الإضاءة	وظيفة توفير الطاقة نشطة	ارجع إلى الفصل «7. قائمة إعدادات الضبط» عند الرغبة في إيقاف تفعيل هذه الخاصية
 ثابتة الإضاءة	وعاء حبوب القهوة (A1) فارغ	قم بملء وعاء الحبوب
 وامضة	هناك رغبة في مواصلة عملية الطحن ولكن حاوية حبوب القهوة (A1) فارغة	قم بملء وعاء الحبوب
 on (تعمل)	الماء الموجود في الخزان (A15) غير كافي أو خزان الماء غير مدخل بالشكل الجيد	أعد ملء الخزان أو اسحب الخزان وأدخله بشكل صحيح
 وامضة	هناك رغبة في مواصلة إعداد مشروب ولكن خزان الماء (A15) فارغ	املاً الخزان بالماء
 ثابتة الإضاءة	الإنذار العام	توجه إلى مركز الدعم الفني
 ثابتة الإضاءة	حاوية حبوب القهوة غير مدخلة	أدخل حاوية حبوب القهوة (A1) بالشكل الصحيح أو تحقق من أنها مدخلة بالشكل الصحيح
 وامضة	المحدد، وفقاً لحاوية حبوب القهوة (A1)، ليس في الوضعية الصحيحة	أعد ضبط المحدد في إحدى وضعيات الطحن (بين 1 و8) مع الحرص والانتباه لما يلي: ضبط الطحن أثناء عمل مطحنة القهوة ضبط مستوى واحد في المرة الواحدة ثم إجراء 5 مرات طحن على الأقل بين كل عملية ضبط وأخرى
 كامل: تدخل جهاز الأمان والسلامة	حاوية حبوب القهوة (A1) غير مدخلة بشكل كامل: تدخل جهاز الأمان والسلامة	تحقق من أن حاوية حبوب القهوة مدخلة بالشكل الصحيح
 ثابتة الإضاءة	يجب ضبط LatteCrema System بعد كل استعمال	بعد الانتهاء من إعداد مشروبات الحليب ابدأ عملية التنظيف الأوتوماتيكي عبر لف المقبض (D5) على Clean
 ثابتة الإضاءة	أصبح الجهاز جاهزاً لسكب البخار.	وصل الجهاز إلى درجة الحرارة المحددة لسكب البخار. لبدء عملية السكب قم بلف مقبض البخار (A4)
 وامضة	الجهاز مشغل ووظيفة توفير الطاقة نشطة: مقبض البخار في وضع (A4) إخراج البخار	يومض المؤشر ليشير إلى أن الجهاز يستعد لإخراج مقبض البخار في وضع (A4) إخراج البخار الحرارة المناسبة
 وامضة	أصبح الجهاز جاهزاً لسكب البخار	الجهاز يكون قد وصل إلى درجة حرارة إعداد البخار عندما يوحد المؤشر الضوئي بإضاءة ثابتة
	الجهاز يقوم بسكب البخار	
 ثابتة الإضاءة (باللون البرتقالي)	يلزم الشروع في عملية إزالة الترسبات الكلسية	قم بتنفيذ عملية إزالة الترسبات الجيرية كما هو موضح في الفصل «11. التخلص من الترسبات»
 تومض (باللون البرتقالي)	ينفذ الجهاز عملية إزالة الترسبات الكلسية	قم باستكمال العملية كما هو موضح في الفقرة. «11. التخلص من الترسبات»

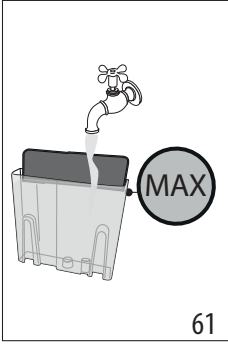

61

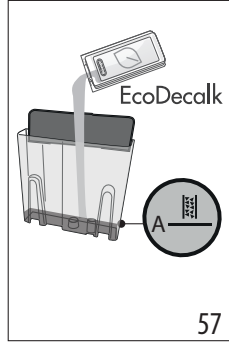

57

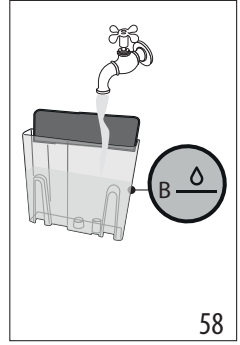

58

- 10. استمر في الضغط على الزر [B] حتى يبدأ المؤشر الضوئي الخاص بذلك في الوميض: تبدأ عملية الشطف.
- 11. بعد اكتمال عملية الشطف، ستوقف عملية السكب وسيصبح الجهاز جاهزًا للاستخدام.
- 12. قمر بتفريغ وعاء تجميع ماء الشطف.
- 13. استخرج وفرغ صينية تجميع القطرات، ثم أعد تركيبها.
- 14. استخرج وأملأ الخزان بالماء البارد، ثم أعد إدراجه.
- 15. الآن أصبحت الماكينة جاهزة للاستعمال.

انتبه جيدًا:

- 1. عند الرغبة في تقديم دورة إزالة الترسبات الجيرية عن موعدها، استمر في الضغط على الزر [B] لمدة 3 ثوانٍ.
- 2. في حالة بدء عملية إزالة الترسبات الجيرية عن طريق الخطأ، اضغط على الزر [B] لمدة 10 ثوانٍ؛ لا يمكن إيقاف عملية الشطف.

- 2. اضع الماء حتى الوصول إلى المستوى B (الشكل 58). ثم أعد إدخال الخزان في موضعه على الماكينة.
- 3. أدخل الملحق التشغيلي (C6) في موصل (A6) (LatteCrema System) (الشكل 59).

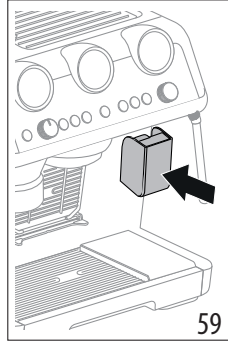

59

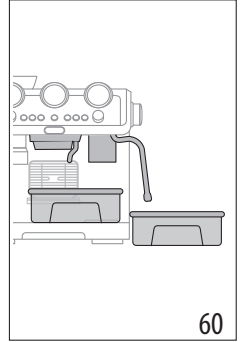

60

- 4. تحقق من أن حامل المرشح (C1) ليس مثبت تعشيقًا وضع وعاء تحت موزعات سكب القهوة والماء الساخن (A7) وتحت موزع سكب البخار (A5) (الشكل 60).
- 5. استمر في الضغط على الزر [B] حتى يبدأ المؤشر الضوئي الخاص بذلك في الوميض.
- 6. سيبدأ برنامج إزالة الترسبات الجيرية وسيخرج سائل مزيل الترسبات الجيرية من موزعات السكب. يقوم برنامج إزالة الترسبات الكلسية تلقائيًا بسلسلة من الشطف على فترات، بغرض إزالة البقايا الكلسية من داخل ماكينة إعداد القهوة حتى يتم إفراغ الخزان تمامًا.
- 7. تتوقف عملية السكب ويصبح المؤشر الضوئي [B] أبيض اللون. يصبح بالتالي من الضروري إجراء دورة شطف:
- 8. قمر بتفريغ الوعاء المستخدم من أجل تجميع سائل إزالة الترسبات ووضعه تحت الموزعات.
- 9. أزل خزان الماء، وفرّغه من البقايا المحتملة من سائل إزالة الترسبات الكلسية، واشطفه بالماء الجاري، وأعد ملئه بماء بارد حتى مستوى MAX (الشكل 61). ثم أعد إدخال الخزان في موضعه.

6. يجب التأكد من أن أنبوب السحب وأنبوب السكب ليسا مسدودين من آثار الحليب؛
7. أعد تجميع كامل مكونات الغطاء من جديد؛
8. اغسل ثم جفف حاوية الحليب (D8) جيدًا؛
9. أعد تثبيت الغطاء على وعاء الحليب.

#### ملحوظة هامة: الغسيل اليدوي

يضمن الغسيل في غسالة الأطباق النظافة التامة لجميع مكونات وعاء الحليب: في حالة الغسيل اليدوي، اغسل بعناية جميع مكونات وعاء الحليب بالماء الساخن واغمرها في حوض ماء ساخن واتركها لمدة 30 دقيقة تقريبًا، قبل المتابعة على النحو الموضح في النقطة 4.

#### 9. عسر الماء

يُضاء المؤشر الضوئي (B8) لإزالة الترسبات بعد فترة محددة من التشغيل الذي يعتمد على عسر المياه. يمكن برمجة الماكينة وفقًا للمستوى الحقيقي لعسر الماء المستخدم في المناطق المختلفة، الأمر الذي سيقفل من وتيرة القيام بعملية إزالة الترسبات الكلسية.

1. أزل الشريط التفاعلي الوارد مع الجهاز مع العبوة الخاصة به "إجمالي عسر الماء" (C4) TOTAL HARDNESS TEST.
2. اغمر الشريط تمامًا في كوب من الماء لمدة ثانية تقريبًا.
3. أخرج الشريط بعد ذلك من الماء ثمّ هزّه قليلًا. اضبط إعدادات الجهاز كما هو موضح في الفصل «7. قائمة إعدادات الضبط».

مستوى	الزر	نتيجة اختبار عسر الماء
1 ماء عذب	x2	
2 مياه متوسطة العسر		
3 ماء عسير أو عسير جدًا		

اضبط إعدادات الجهاز كما هو موضح في الفصل «7. قائمة إعدادات الضبط».

#### 10. كيفية استخدام SOFTBALLS

(C11) Softballs هو نظام مبتكر يظيل من العمر التشغيلي للماكينة دون أن يؤثر سلبيًا على كمية المياه مما يضمن عملية سكب القهوة كريمية ومشفعة بالنكهة. لتحسين الكفاءة التشغيلية اترك Softballs في الماء طوال الليلة السابقة للاستخدام.

1. أخرج علبة Softballs من التغليف (الشكل 53).

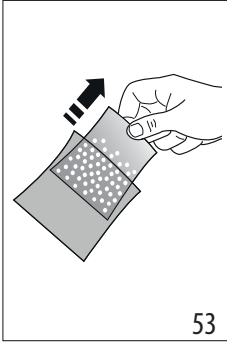

53

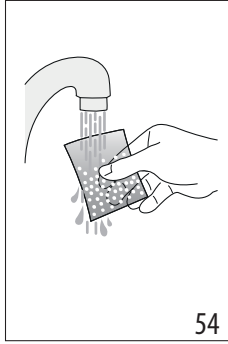

54

2. اشطفْ علبة Softballs بماء جارٍ (الشكل 54).
3. اغمس الكيس في خزان الماء (A15) (الشكل 55).

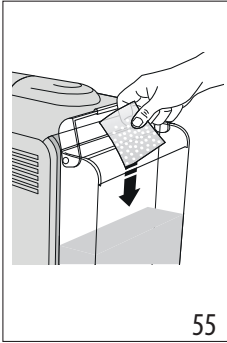

55

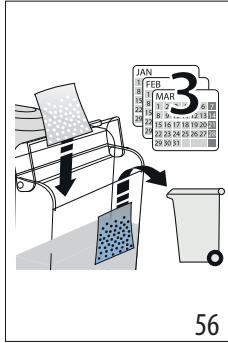

56

4. استبدل كيس Softballs كل 3 أشهر (الشكل 56).

#### 11. التخلص من الترسبات

انتبه!

قبل البدء في استخدام مزيل الترسبات الجيرية (C5)، يجب قراءة التعليمات والإرشادات الخاصة به والواردة على علبة هذا المزيل نفسه. من المستحسن استخدام فقط وحصريًا مزيل الترسبات الكلسية De'Longhi. تجدر الإشارة هنا إلى أن استخدام أي مزيل للترسبات الجيرية آخر غير مناسب، فضلًا عن عدم إزالة الترسبات الجيرية بشكل منتظم، يؤدي كل هذا إلى حدوث عيوب لا يغطيها الضمان الخاص بجهة التصنيع.

يمكن أن يسبب مزيل الترسبات تلف الأسطح الحساسة. في حالة انسكاب المنتج عن طريق الخطأ، فحفظه على الفور.

من أجل تنفيذ غزالة الترسبات الكلسية	
مزيل الترسبات الجيرية	مزيل الترسبات الكلسية ديلونجي
الحاويات	سعة 2 لتر لكل حاوية
الزمن	~40 دقيقة

1. (حال توافره، انزع مرشح تنقية الماء و SOFTBALLS). اسكب في خزان الماء (A15) مزيل الترسبات الجيرية حتى المستوى A (ما يقابل علبة سعة 100 مل) المطبوع على الجانب الداخلي من الخزان (الشكل 57).

## Smart TAMPING STATION

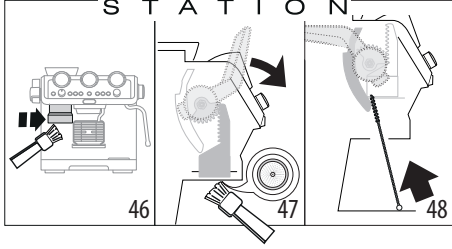

### 8.6 تنظيف LatteCrema System

اغسل جميع المكونات والوعاء في غسالة الأطباق، لكن بواسطة وضعها في السلة العلوية لغسالة الأطباق. إذا لم تتوفر غسالة الأطباق، فقم بالغسيل اليدوي على النحو المشار إليه في الملاحظة الواردة في نهاية الفقرة.

1. اضغط على الزر (D3) و ارفع غطاء حاوية الحليب (D1)؛
2. أخرج موزع سكب الحليب (C3) وأنبوب الشفط (D7) (الشكل 49)؛

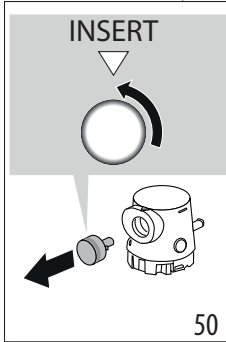
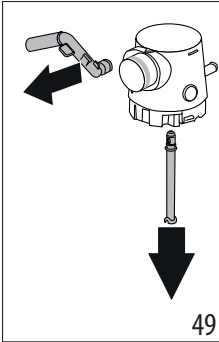

3. قم بلف المقبض في وضع "Insert" (إدخال) ثم اسحب (الشكل 50)؛
4. انتبه واحرص جيدًا على عدم بقاء أية رواسب أو بقايا للحليب على الثقب وعلى المجرى الواقع تحت المقبض (شكل 51)؛ وعند وجود بقايا أو رواسب استخدم عود تخليل الأسنان في تنظيف هذا المجرى؛

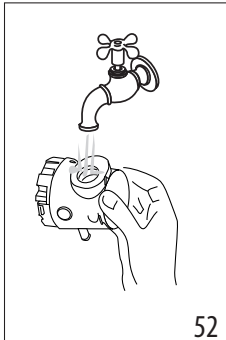
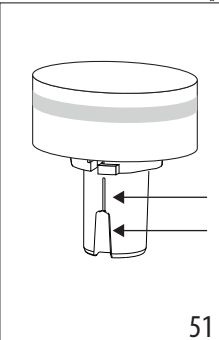

5. اشطف الجزء الداخلي من مكان مقبض ضبط الرغوة بالماء الجاري (شكل 52)؛

2. أطفئ الجهاز.

3. قم بلف مقبض ضبط الطحن في عكس اتجاه عقارب الساعة حتى نهاية المسار، في وضع "REMOVE" (إزالة) (الشكل 42).

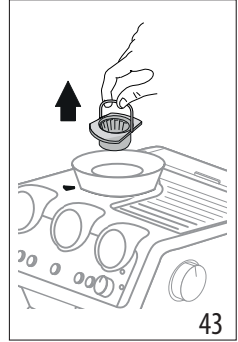
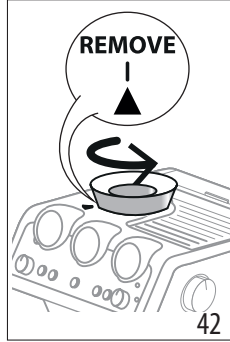

4. أخرج الجزء العلوي من رحي الطحن مع التثبيت باستخدام المقبض المعد خصيصًا لذلك (الشكل 43).
5. نظف المطحنة بفرشاة (الشكل 44)، واشطف بقايا البن بالمكنسة الكهربائية (الشكل 39).

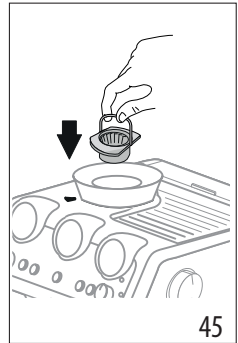
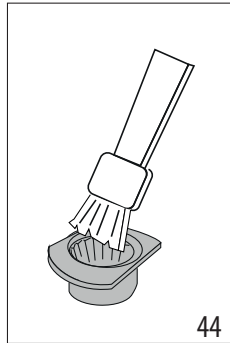

6. أدخل رحي المطحنة في مبيته (الشكل 45)؛
7. أدر مقبض ضبط لاختيار درجة الطحن المرغوبة (الشكل 13)؛ تحقق من أن رحي المطحنة مركبة جيدًا، من خلال سحبها من المقبض؛ إذا لم تتحرك الرحي، فهي مركبة بشكل صحيح؛

### 8.4 استبدال المطاحن

عند انخفاض كمية القهوة المطحونة توجه إلى أحد مراكز الصيانة والدعم الفني المعتمدة لاستبدال رحي الطحن: ثم اضبط من جديد مطحنة القهوة عبر الدخول إلى قائمة إعدادات الضبط (7. قائمة إعدادات الضبط) وتحديد النطاق الأول للضبـط "extra" لمطحنة القهوة. قم بعد ذلك بلف مقبض ضبط الكمية (B2) في وضعية الحد الأدنى MIN ثم اضبط الكمية كمره الاستخدام الأولى (انظر «الكمية المثالية»).

### 8.5 تنظيف "Smart tamping station"

1. قم بتنظيف منطقة الربط بفرشاة (الشكل 46).
2. اسحب الذراع (A20) حتى حاجز نهاية مساره ثم قم بتنظيف ضاغط القهوة بفرشاة (الشكل 47) ثم قم بتحرير هذا الذراع.
3. باستخدام منظم الأبواب (C8)، قم بتنظيف مسار البن (الشكل 48).

## انتبه جيدًا:

يمكن بدء عملية التنظيف هذه في أية لحظة بالضغط على الزر (B5) لبضع ثوان. لإلغاء هذه العملية اضغط على الزر لمدة 10 ثوان.

### 8.2 قم بتنظيف مكان وضع حاوية حبوب القهوة

- تحقق من أن حاوية حبوب القهوة (A1) فارغة. قم إن أمكن بإجراء بعض عمليات الطحن والحاوية فارغة لتفريغها.
- قم بفك تعشيق الحاوية عبر لفها في عكس اتجاه عقارب الساعة ثم أخرجها من الماكينة (الشكل 38)

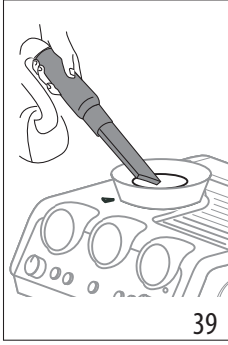
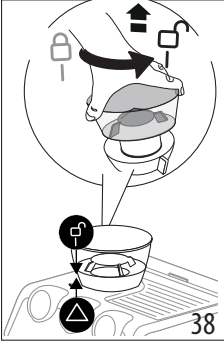

3. اشطف بقايا القهوة (الشكل 39).

- استخدم قطعة قماش رطبة لتنظيف مكان حاوية حبوب القهوة ثم قم بالتجفيف (الشكل 40):

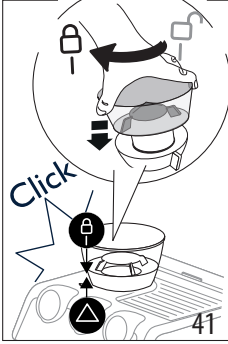
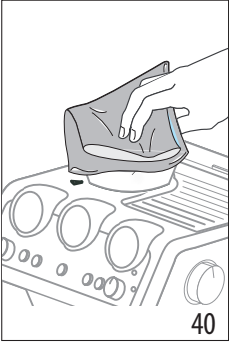

- أعد وضع الحاوية في مطحنة القهوة. تصبح الحاوية موضوعة بالشكل الصحيح في مكانها عندما يكون السهم ▲ مضبوط المحاذاة مع الزمر 🔒 وعند سماع صوت "نقرة" (الشكل 41).

### 8.3 تنظيف رحي المطحنة

عند تنظيف حاوية حبوب القهوة (A1)، قم أيضًا بتنظيف مكان الحاوية ورحي المطحنة العلوي باستخدام قطعة قماش رطبة. توجه إلى أحد مراكز الدعم الفني المعتمدة لإزالة واستبدال رحي الطحن.

يمكن إزالة رحي الطحن عند توقف مطحنة القهوة عن العمل جراء وجود جسم غريب. وفي حالة حدوث ذلك قم بإزالة حاوية حبوب القهوة وقرم بما يلي:

- قم تعشيقًا بثبتي كأس حامل المرشح (C1) ثم قم بإجراء عملية طحن "على الفارغ" لتحرير أنبوب القهوة.

×	✓	✓	×	×	
✓	✓	×	×	×	
✓	✓	×	✓	✓	

### 8.1 تنظيف موزع سكب القهوة

عندما يوكد المؤشر الضوئي (B5) (باللون البرتقالي) (B5)، فإنه يصبح من الضروري البدء في تنظيف دائرة إعداد القهوة. لإجراء عملية النظافة قم بشراء أقراص تنظيف ماكينات إعداد القهوة. لمزيد من المعلومات حول ذلك، قم بزيارة الموقع الإلكتروني [www.Delonghi.com](http://www.Delonghi.com).

- أدخل المرشح 1 فنجان (C2) في حامل المرشح (C1) (الشكل 36).
- ادخل حلقق التنظيف (C9) في المرشح (الشكل 36) ثم اضغط عليه بالكامل.

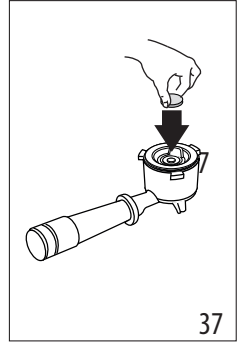
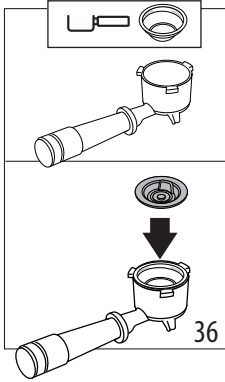





3. ضع قرص التنظيف على الملحق التشغيلي (الشكل 37).

- قم بتوصيل حامل المرشح بموزع سكب القهوة (A7).
- أعد ملء خزان الماء (A15). تحقق من أن حوض تجميع القطرات (A11) فارغ.

استمر في الضغط على الزر (B5) حتى يبدأ المؤشر الضوئي الخاص بذلك في الوميض (باللون البرتقالي). بعد بضعة دقائق، تتوقف عملية التنظيف بشكل تلقائي.

- قم بإزالة حامل المرشح وملحق التنظيف.
- اغسل حامل المرشح والمرشح تحت تيار ماء جار.
- أعد إدخال حامل المرشح ثم ابدأ في عملية الشطف بالضغط على الزر (B5): يُصبح موضع حاوية تحت حامل المرشح.
- قم بإزالة وتفريغ حوض تجميع القطرات.

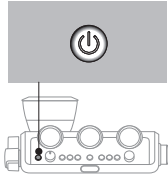
 ← غير عسر	عسر الماء	 Americano
 ← متوسط		
 ← عسر/عسر جدًا		
<b>3. احفظ إعدادات الضبط الجديدة بالضغط على ON/Standby (B1)</b>		
		

### 8. تنظيف الجهاز

انتبه!









لتنظيف الماكينة، لا تستعمل مذيبات أو منظفات مُسببة للتآكل أو الكحول.

لا تستخدم الأشياء المعدنية في إزالة القشور الترسبية ولا رواسب وبقايا القهوة لأنها يمكن أن تتسبب في خدش الأسطح المعدنية أو البلاستيكية في الماكينة.

عند عدم استعمال الماكينة لمدة تزيد عن أسبوع يُصح، قبل استخدام الماكينة من جديد، بعمل دورة شطف.











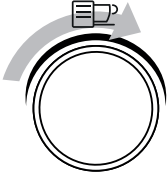



خطر!

أثناء التنظيف، لا تعمر الماكينة أبدًا في الماء: إنها جهاز كهربائي. قبل الشروع في أي عملية تنظيف للأجزاء الخارجية للجهاز، أولاً الماكينة، افصل القابس من مصدر التيار الكهربائي ثم اترك الماكينة حتى تبرد.

					
	×	×✓	×	×	
	✓	✓×	✓	✓	
	✓	✓	×	×	
	✓	✓	×	×	

وصفة إعداد القهوة	الكمية الافتراضية المصنوعة في المصنع	الكمية القابلة للبرمجة
 X2 Americano	240 مل	• الإسبريسو: من 50 إلى 120 مل الماء: من 50 إلى 240 مل

### 7. قائمة إعدادات الضبط

ادخل في القائمة:		
 my	x2	اضغط في نفس الوقت لمدة 5 ثوان
2. اختر إعدادات الضبط المراد برمجتها:		
		
المشروب	إعدادات الضبط المقابلة	إعدادات الضبط
 Espresso	وظيفة ترشيد استهلاك الطاقة	 ← مفعل
		 ← مطفأ
 Coffee	الإيقاف الأوتوماتيكي للتشغيل	 ← 9 دقائق
		 ← 1,5 ساعة
		 ← 3 ساعات
 Cappuccino	تنبيه صوتي	 ← مفعل
		 ← مطفأ
 Latte	ضبط إضافي للطنحن	 ← النطاق 1
		 ← النطاق 2
 Flat White	قيمر المصنع	استمر في الضغط على الزر OK لمدة 5 ثوان حتى يصبح المؤشر الضوئي موقدًا بإضاءة ثابتة
		×



- ستبدأ عملية التنظيف وتتوقف بشكل تلقائي. انتبه: عقب الانتهاء من عملية التنظيف قم بلف المقبض على إحدى وضعيات ضبط الرغوة.
- قم بإزالة حاوية الحليب ثم ضعها في التلاجة؛ يُوصى باستخدام الحليب المتبقي في غضون مدة قصيرة.
- لإجراء عملية تنظيف عميقة يُصح باستخدام Eco MultiClean؛ إنه يضمن النظافة المطلوبة حيث يزيل بروتينات ودهون الحليب ويمكن استخدامه لتنظيف الماكينة بأكملها.

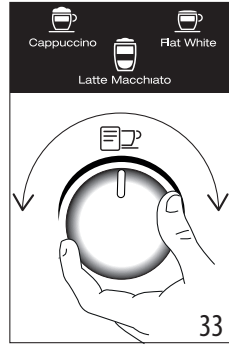

## 6. قم بتخصيص طول مشروبات القهوة بالزر (my) (B9)

1. قم بإعداد الماكينة لإخراج فنجان أو فنجانين من مشروب القهوة المراد إخراجه، حتى تعشيق حامل المرشح (C1) المزود بالمرشح (C2) أو (C3) والبن المطحون. عند الرغبة في برمجة مشروب ما فاقم في إعداده على الحليب، قم بتوصيل LatteCrema System بالماكينة.
2. قم بلف المقبض (B10) لاختيار المشروب المراد برمجته.
- اضغط على الزر (my) : المؤشر الضوئي المقابل للزر (B6) OK سيوقد بإضاءة ثابتة والمؤشر المقابل للزر (my) سيومض.
4. اضغط على الزر OK لبدء عملية السكب. لمبات التنبيه المقابلة للأزره OK و (my) ستومض.
5. بعد الحصول على الكمية المطلوبة، اضغط OK. إذا كان المشروب يحتاج إلى سكب مكوّن آخر فإنه سيبدأ سكب هذا المكوّن؛ بعد الوصول إلى الكمية المطلوبة، اضغط OK.
6. اضغط على الزر (my) للحفاظ. الجهاز أصبح جاهزاً للاستخدام من جديد والمؤشر الضوئي (my) سيبقى موقداً.

عند الرغبة في عدم حفظ البرنامج اضغط على أي زر آخر.

### انتبه جيداً:

- يمكن برمجة المشروبات مع القهوة ولكن ليس عملية سكب البخار والماء الساخن.
- تقوم عملية البرمجة بتعديل كميات المشروبات ولكن ليس كميات القهوة المطحونة.
- يمكن برمجة المشروبات "X2" بشكل منفصل.

My LatteArt (heart icon) غير قابل للبرمجة.

للمرجعة إلى إعدادات ضبط المصنع، استمر في الضغط على الزر (my) حتى تتطفئ الماكينة. يعود المشروب المختار إلى الكمية الافتراضية المضبوطة في المصنع.

وصفة وإعداد القهوة	الكمية الافتراضية المضبوطة في المصنع	الكمية القابلة للبرمجة
Espresso	35 مل	من 25 إلى 90 مل
X2 Espresso	70 مل	من 50 إلى 180 مل
Coffee	80 مل	من 50 إلى 120 مل
X2 Coffee	160 مل	من 120 إلى 240 مل
Americano	120 مل	الإسبريسو: من 25 إلى 60 مل الماء: من 25 إلى 120 مل

المشروب	Espresso (إسبريسو)	Latte (حليب)	Schiuma (رغوة)	الكمية (مل)	X2 (مل)
Cappuccino (كابوتشينو)	✓ 1	✓		150	230
Latte Macchiato (حليب بالقهوة)	1	✓	×	150	230
FLAT WHITE (حليب خفيف)	✓ 1	✓		250	330

7. المشرروبات مزودة الكمية (2x): اسكب في الحاوية (D8) كمية الحليب الضرورية للإعداد مع توخي الحذر حتى لا تتجاوز الحد الأقصى MAX (الشكل 25). كل حز تحديد على الحاوية يعادل 100 مل من الحليب.
- الحليب الطازج أفضل. استعمل دائماً حليباً طازجاً بدرجة حرارة التلاجة.
7. اضغط على (B6) OK لبدء عملية السكب (الشكل 23). يقوم الجهاز أوتوماتيكياً بسكب القهوة والحليب بالتسلسل.

### تنظيف Lattecrema System بعد كل استخدام:

- اترك حاوية الحليب مثبتة في الماكينة (من غير الضروري تفريغها). ضع وعاءً تحت أنبوب سكب الحليب (D4) (الشكل 34).
- 2. قم بلف المقبض (D5) على "Clean" (الشكل 35).

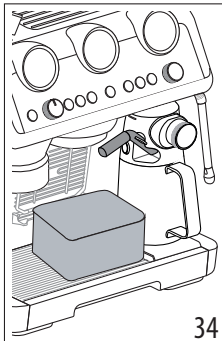

2. حافظ على إبقاء الذراع منزلاً حتى حازن نهاية مساره أثناء إزالة حامل المرشح (الشكل 19)، أبدأ بعد ذلك ذراع الضغط إلى وضعية البداية.
3. بعد التحقق من أن كمية القهوة صحيحة (انظر «الكمية المثالية»)، قم بتعشيق حامل المرشح في موزع سكب القهوة (A7) (الشكل 20).

### "الكمية المثالية"

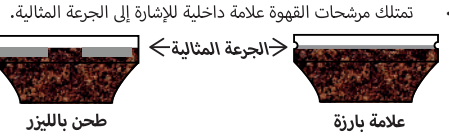

- المرشحات ذات العلامة المنفذة بالليزر: تتوافق الجرعة المثالية مع الخط العلوي للعلامة؛
- المرشحات ذات العلامة البارزة: تتوافق الجرعة المثالية مع الخط البارز؛

تحقق من أن القهوة في المستوى المطلوب بعد عملية الضغط. قد يصبح من الضروري ضبط المقبض (B2) لأكثر من مرة قبل الوصول إلى الكمية المثالية. إذا كانت القهوة تحت/فوق مستوى السحب المحدد والكمية في الداخل مثالية فإنه يجب ضبط درجة الطحن لجعلها أكثر نعومة أو أكثر كثافة (انظر «4.1 المرحلة 1 - الطحن (grinding)» (الشكل 11)). إذا كانت القهوة فوق مستوى السحب (عملية السكب تتم ببطء مفرط) فإن عملية الطحن ينبغي أن تكون أكثر كثافة. إذا كانت القهوة تحت مستوى السحب (عملية السكب تتم بسرعة مفرط) فإن عملية الطحن ينبغي أن تكون أكثر نعومة.

**يوصى عامل البار بما يلي:** أخرج حامل المرشح بينما يكون ذراع ضغط القهوة (A20) منزل للحصول على الشكل المثالي لكمية القهوة.

### 4.3 المرحلة 3 - التوزيع (brewing) (الشكل 21)

1. اختر المشروب المرغوب فيه (الشكل 22).
2. اضغط على (B6) OK لبدء عملية السكب (الشكل 23) (ما قبل النقع وعملية النقع). تتوقف عملية سكب القهوة بشكل تلقائي.

### 5. إعداد مشروبات الحليب

#### 5.1 قمر بترغية الحليب (الشكل 24)

- اسكب في حاوية الحليب (D8) كمية الحليب المراد تسخينها/ترغيتها من الأخذ في الاعتبار أن حجم الحليب سيزداد 2 أو 3 مرات (الشكل 25). للحصول على رغوة حليب أكثر كثافة وتجانساً، فإنه يُصح استخدام حليب بقر وبدرجة حرارة التلاجة (تقريباً 5 درجات مئوية).

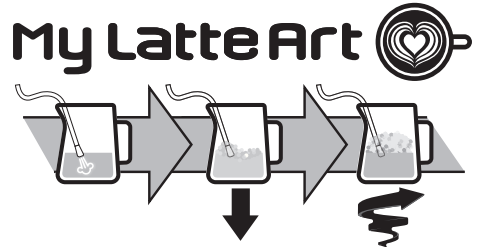

2. لترغية الحليب قمر بسند أنبوب موزع سكب البخار (A5) على سطح الحليب؛ بهذه الطريقة سيمتزج الهواء مع الحليب والبخار.

3. ابق على موزع سكب البخار على السطح مع ضرورة الانتباه حتى لا تحجز كمية مفرطة من الهواء مما قد يكون فقاعات هوائية مفرطة الكبر.
4. اغمس موزع سكب البخار تحت سطح الحليب؛ بهذه الطريقة ستحصل على قمة بارزة. بعد الوصول إلى درجة الحرارة المطلوبة أبدأ غلق مقبض البخار ثم انتظر حتى يتوقف سكب البخار بشكل كامل قبل إزالة وعاء الحليب.

### يوصى عامل البار بما يلي:

- الحليب الطازج أفضل. استعمل دائماً حليباً طازجاً بدرجة حرارة التلاجة.
- الحليب الكامل الدسم يضمن الحصول على نتائج مثالية. شكل وقوام الرغوة يختلفان باختلاف الحليب البقري أو المشروبات النباتية المستخدمة.
- بعد الانتهاء من ترغية الحليب، قمر بإزالة الفقاعات عبر تحريك وعاء الحليب.

### تنظيف موزع سكب البخار:

1. بعد كل استخدام، قمر بإزالة بقايا الحليب من موزع سكب البخار باستخدام قطعة فماش (الشكل 26). لإجراء عملية تنظيف عميقة يُصح باستخدام Eco MultiClean؛ إنه يضمن النظافة المطلوبة حيث يزيل بروتينات ودهون الحليب ويمكن استخدامه لتنظيف الماكينة بأكملها.
2. اسكب البخار لبضع ثوانٍ لتنظيف موزع السكب جيداً (الشكل 10).
3. انتظر حتى يبرد الموزع؛ للحفاظ على كفاءة الموزع مع مرور الوقت، استخدم إبرة التنظيف (C12) للمحافظة على الثقوب الثلاثة غير مسدودة (شكل 27).

### 5.2 قمر بإعداد مشروبات الحليب باستخدام LatteCrema

#### System (الشكل 28)

- اسكب في حاوية (D8) الحليب بدرجة حرارة التلاجة (5 درجات مئوية) (الشكل 29).
- 2. أغلق الغطاء (D1) (الشكل 30).
- لف مقبض ضبط الرغوة (D5) واضبطه على الوضعية التي ترغب في استخدامها (الشكل 31).

مكان مقبض ضبط الرغوة				
■ CLEAN	■ الحده الأدنى للرغوة MIN	■ لحد المتوسط للرغوة MED	■ لحد القصوى للرغوة MAX	■ INSERT
إخراج المقبض أو إدخاله				التنظيف بعد كل استخدام

- قمر بتعشيق حاوية الحليب في الماكينة (الشكل 32).
- 5. قمر بإعداد الكمية المثالية (انظر «4.1 المرحلة 1 - الطحن (grinding)» (الشكل 11)) و «4.2 المرحلة 2 - الضغط (tamping)» (الشكل 17)) ثم أدخل حامل المرشح.
- 6. اختر مشروب الحليب المرغوب فيه (الشكل 33).

## 2. إعداد الماكينة

- اغسل جميع الملحقات بماء فاتر ومنظف أطباق، ثم اتبع الخطوات التالية:
- أدخل صينية تجميع القطرات (A11) كاملة مع شبكة حمل الفناجين (A9) وشبكة الحوض (A10) (الشكل 1)؛
  - أزل خزان الماء (A15) (الشكل 2) وأعد ملئه بماء بارد ونظف مع الانتباه إلى عدم تجاوز الكتابة MAX (الشكل 3).
  - ثم أعد إدخال الخزان.
- تنبيه: لا تشغل مطلقًا الجهاز بدون صب الماء أولاً في الخزان أو بدون وجود خزان. انتبه جيدًا: اعمل بأسرع وقت ممكن على ضبط وتخصيص قير عسر الماء باتباع إجراء «برمجة عسر الماء» الموصوفة في الفصل «7. قائمة إعدادات الضغط».

## 3. استعمال الجهاز لأول مرة

- أدخل موصل كابل التغذية (C7) في الموضع المخصص له (A16) خلف الجهاز (الشكل 4)؛ ثم أدخل القابس في مأخذ التيار. تحقق من الضغط على قاطع التيار العام (A17)، الموجود خلف الجهاز في الوضع 1 (الشكل 5)؛
  - ضع حاوية الحد الأدنى لسعتها 100 ملمر تحت موزع سكب الماء الساخن (في مقابل موزع سكب القهوة (A7)) (الشكل 6)؛
  - اضغط الزر (B7) بمحاذاة مؤشر (A9) (الشكل 7)؛ يبدأ صرف القهوة ويتوقف تلقائيًا. قمر بإفراغ الحاوية.
- قبل البدء في استخدام الماكينة، يلزم شطف الدوائر الداخلية للماكينة. اتبع الخطوات التالية:

- قمر بتثبيت كوب حامل المرشح مزودًا بمرشح (C1) بالماكينة: من أجل الحصول على التثبيت الصحيح، قمر بمحاذاة مقبض كوب حامل المرشح مع الرمز "INSERT" (الشكل 8) وأدر المقبض نحو اليمين، حتى محاذاة الوضع "CLOSE"؛
- ضع حاوية تحت كأس حامل المرشح وأنبوب سكب البخار (A5)؛
- اضغط على الزر (B5) بمحاذاة مؤشر (A9) (الشكل 9)؛ ستبدأ عملية السكب؛
- عقب الانتهاء من عملية السكب قمر بلف مقبض البخار (A4) (الشكل 10) ثم اسكب البخار لبضع ثوان بحيث تشطف دائرة البخار؛ للحصول على عملية سكب مثالية للبخار يُصح بتكرار هذه العملية 3 أو 4 مرات. يسم ذلك بإزالة الماء في الأنبوب قبل سكب البخار.

هكذا صار الجهاز في وضعية الاستعداد للاستخدام. انتبه جيدًا: تُعد عملية شطف دواخل الماكينة ضرورية للغاية أيضًا في حالة إطالة مدة استعمال الجهاز.

عند الاستخدام لأول مرة من الضروري إعداد 4-5 فناجين من القهوة قبل أن يبدأ الجهاز في إعطاء نتائج مرضية؛ يجب إيلاء اهتمام خاص لكمية القهوة المطحونة في المرشح (C2) أو (C3) ((انظر التعليمات الواردة في الفقرة «4.1 المرحلة 1 - الطحن (grinding) (الشكل 11)»)). تابع كما هو موضح في الفصل «الكمية المثالية».

## 4. قمر بإعداد القهوة

### 4.1 المرحلة 1 - الطحن (grinding) (الشكل 11)

- اسكب حبوب القهوة في حاوية الحبوب (A1) (الشكل 12). يُنصح بسكب فقط حبوب القهوة الضرورية لعملية الإعداد؛ بهذه الطريقة ستحصل دائمًا على قهوة طازجة؛
- حدد درجة الطحن (الشكل 13). درجة ضبط المصنع هي 5 (طحن متوسط). إذا لم تكن نتيجة الطحن مرضية بالنسبة لك، قمر بضبط

مستوى الطحن وفقًا لذوقك ونوع القهوة (يجب إجراء عملية الضبط أثناء عمل مطحنة القهوة).

- أدخل أحد مرشحات القهوة (C2) أو (C3) في حامل المرشح (C1) (الشكل 14). عند استخدام المرشح لفنجانين، اضغط على الزر (B3) (2X)؛ ستقوم من خلال هذا الاختيار بمضاعفة كمية الإسبريسو المسكوبة.
- اضبط مقبض تحديد الكمية (B2) بدءًا من وضعية الحد الأدنى (الشكل 15).

### انتبه جيدًا:

- الأرقام الظاهرة على الشاشة (B19) هي عبارة عن مرجعية يُسترشد بها عند الوصول إلى المستوى الصحيح في حامل المرشح. لا تتوافق مع إعدادات ضبط الطحن ولا وزن القهوة المطحونة (جرام/أونصة) ولا مدة عملية الطحن.
- يُرجى العودة إلى الفقرة «B3. الزر «X2»؛ لاستخدام المرشح 2 للقهوة» للحصول على مزيد من المعلومات التفصيلية.
- ثبت حامل المرشح بمخرج مطحنة البن (A18) بمحاذاة الكتابة "أدخل" INSERT؛ ثم قمر بلف الكوب في اتجاه اليمين (الشكل 16). تبدأ عملية الطحن عندما يصل الكوب إلى الوضع "غلق" CLOSE وتتوقف تلقائيًا.

### اضبط كمية البن المطحون في المرشح

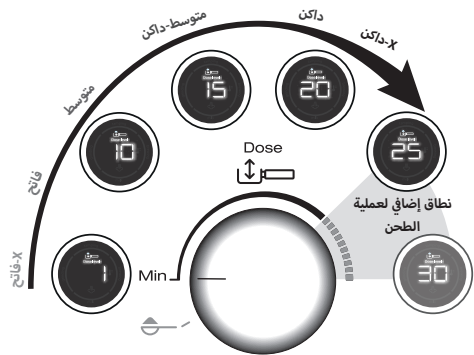

أي تغيير في نوع حبوب القهوة يعطي نتيجة مختلفة أثناء عملية الطحن ولذلك تحتاج عملية ضبط الكمية في البداية إلى انتباه ودقة كبيرين. يقدم هذا الرسم التوضيحي بعض الإرشادات حول كيفية ضبط الكمية وهذه الإرشادات قائمة على لون التحميص؛ ينبغي اعتبارها نقاط إرشادية كدبابة ولكن قد تختلف وفقًا لتكوين حبوب القهوة.

- اضبط الكمية من الحد الأدنى.
- مع الاسترشاد بلون تحميص القهوة الخاصة بك، قمر بلف المقبض ببطء.

### 4.2 المرحلة 2 - الضغط (tamping) (الشكل 17)

- بعد انتهاء عملية الطحن، أزل ذراع ضغط القهوة (A20) حتى نهاية حاجز المسار (لا تقم بإزالة حامل المرشح) (الشكل 18). للحصول على نتيجة مثالية، كرر هذه العملية لمرتين.

قبل استخدام الجهاز اقرأ دائماً ملف تحذيرات الأمان.

## 1. الوصف

### 1.1 وصف الجهاز - A

- A1. وعاء الجيوب
- A2. غطاء وعاء الجيوب
- A3. حامل فناجين القهوة
- A4. مقبض البخار
- A5. أنبوب توزيع البخار
- A6. موصل Lattecrema System
- A7. مؤرّع سكب القهوة
- A8. شبكة حمل فناجين الإسبرسو
- A9. شبكة حمل الأكوأب أو الأقداح
- A10. شبكة الحوض
- A11. حوض تجميع القطرات
- A1. مؤرّش مستوى الماء في حوض تجميع القطرات
- A13. غطاء خزّان الماء
- A14. مقبض استخراج خزان الماء
- A15. خزّان الماء
- A16. مكان موصل كابل التيار الكهربائي
- A17. قاطع التيار العمومي (تشغيل/إيقاف "ON/OFF")
- A18. مخرج مطحنة البن (Tamping station)
- A19. منفذ صغير للدخول إلى منزلق مطحنة القهوة
- A20. ذراع الضغط

### 1.2 وصف لوحة التحكم - B

- B1. زر التشغيل/الاستعداد
- B2. مقبض ضبط كمية القهوة المطحونة
- B3. الزر "X2": لاستخدام المرشح 2 للقهوة
- B4. زر "درجة الحرارة حرارة القهوة"
- B5. زر "الشطف"
- B6. زر "OK": لإخراج المشروب/للتأكيد
- B7. زر "سكب الماء الساخن"
- B8. زر "إزالة الترسبات الجيرية"
- B9. زر "My": من أجل تخصيص طول المشروبات
- B10. مقبض اختيار الوظائف
- B11. شاشة المشروبات:

#### مشروبات قهوة الإسبريسو

- Espresso (إسبريسو)
- قهوة أمريكية
- Coffee

#### مشروبات الحليب

- Cappuccino (كابوتشينو)
- FLAT WHITE (حليب خفيف)
- Latte Macchiato (حليب بالقهوة)

B12. مؤرّش "نظافة الحليب"

B13. مؤرّش "نقص حاوية جيوب القهوة"

B14. مؤرّش "الإنذار العام"

B15. مقياس الضغط

B16. مؤرّش "نقص الماء"

B17. مؤرّش "حاوية جيوب القهوة فارغ"

B18. مؤرّش "توفير الطاقة"

B19. شاشة إعدادات الضبط والمعالجة:

- تشير إلى العملية التي يوم الجهاز بها في هذا الوقت
- تشير إلى ضبط كمية القهوة المختارة
- تشير إلى ضبط درجة حرارة القهوة المختارة

### 1.3 وصف الملحقات التشغيلية - C

- C1. كأس حامل المرشّح
- C2. مرشح 1 فنجان
- C3. مرشح 2 فنجان
- C4. شريط الاختبار «Total Hardness Test» (قسوة المياه)
- C5. مزيل الترسبات الجيرية
- C6. ملحق تشغيلي لإزالة الترسبات الجيرية
- C7. كابل تغذية قابل للإزالة
- C8. فرشاة تنظيف
- C9. ملحق تنظيف مؤرّع سكب القهوة
- C10. قطعة قماش
- C1. Softballs (منقّي مزيل للترسبات الجيرية في المياه)
- C12. إبرة تنظيف أداة ضخ البخار

### 1. الملحقات التشغيلية الخاصة بالتنظيف لا تأتي مع الجهاز

#### وهي موصى عليها من قبل الشركة المصنّعة

للحصول على مزيد من المعلومات حول ذلك، قم بزيارة [Delonghi.com](http://Delonghi.com).

#### قرص تنظيف

(انظر «8.1 تنظيف موزع سكب القهوة»)



#### منظف

EAN: 8004399333307

EcoMultiClean

### 1.5 وصف D - LatteCrema System

- D1. غطاء وعاء الحليب
- D2. موصل حاوية الحليب
- D3. زر تحرير الخطأ
- D4. موزع الحليب (ارتفاعه قابل للضبط)
- D5. مقبض تنظيم الرغوة
- D6. مكان المقبض
- D7. أنبوب شفط الحليب
- D8. وعاء الحليب