

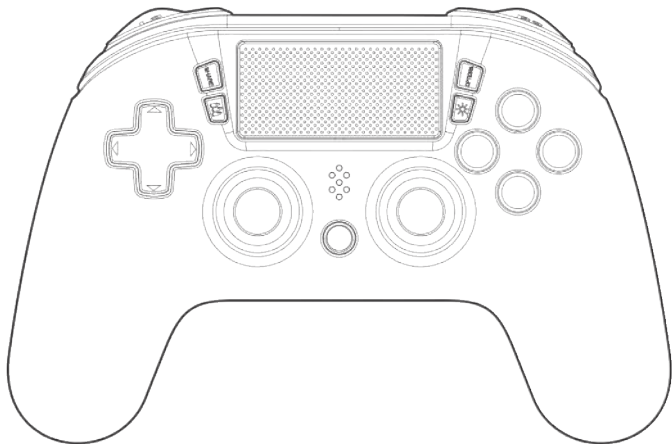

SB922565 • GAMEPAD RGB 4™



Quick start guide • Guide de démarrage rapide
Guía rápida • Schnellstartanleitung • Guida rapida

Recharge

Recharger • Recarga

Aufladen • Ricarica

1.

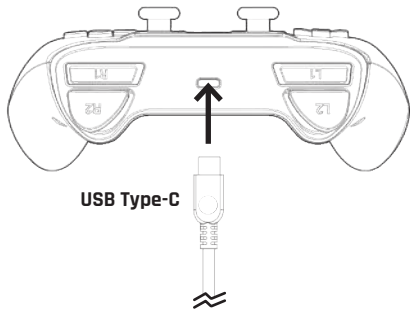

2.

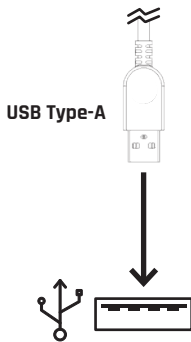

Switching on

Mise en marche • Encendido

Anschalten • Accensione

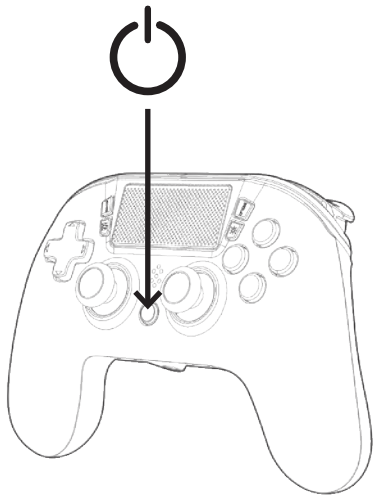

Connecting

Connexion · Conexión

Verbinden · Collegamento

1.

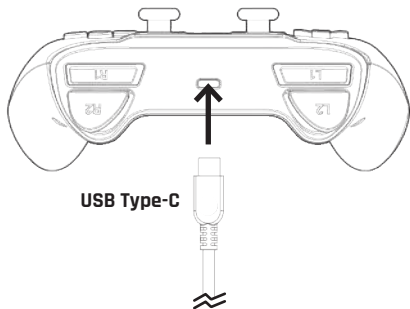

2.

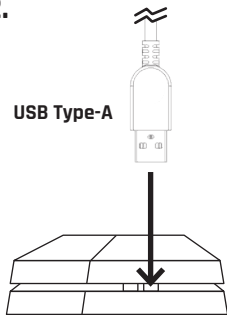

3.

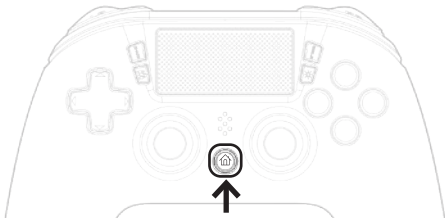

RGB lighting modes

Modes d'éclairage RGB • Modos de iluminación RGB

RGB-Beleuchtungsmodi • Modalità di illuminazione RGB

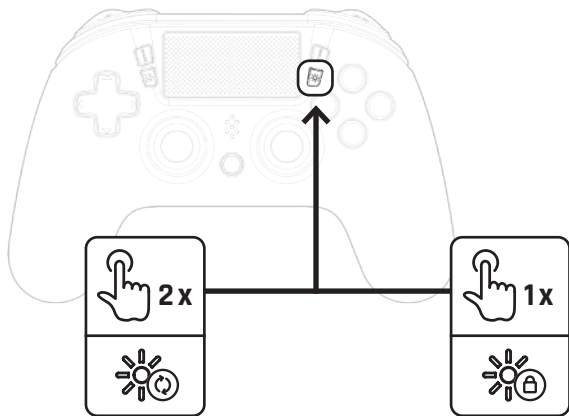

Macro mode

Mode macro · Modo macro

Makro-Modus · Modalità Macro

1.

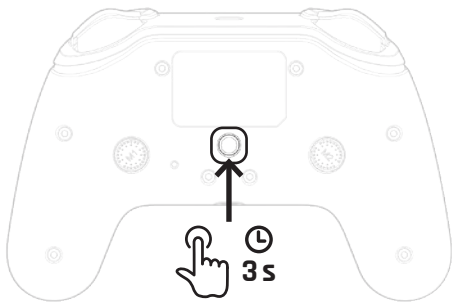

2.



3.

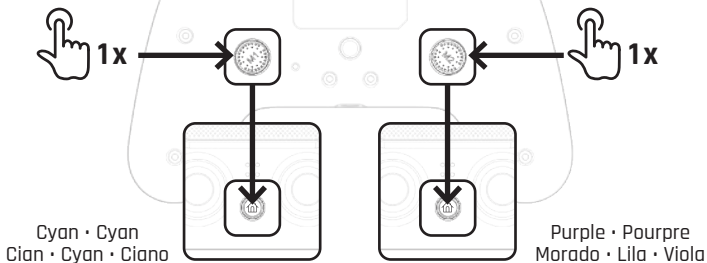

4. Enter macro (1-16 keys)

Saisir une macro (1-16 touches) · Introducir macro (1-16 teclas)
Makro eingeben (1-16 Tasten) · Immissione macro (1-16 tasti)

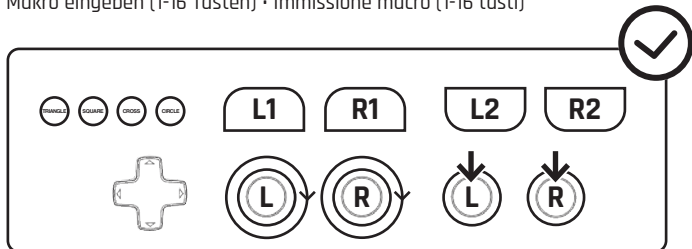

5.

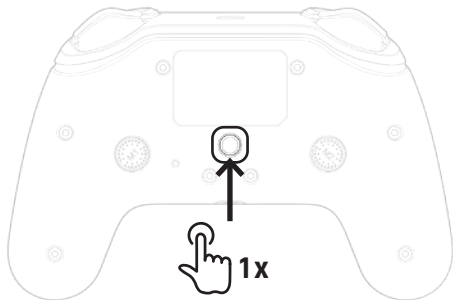

Reset macro

Réinitialiser la macro • Restablecer macro
Makro zurücksetzen • Azzeramento macro

1.

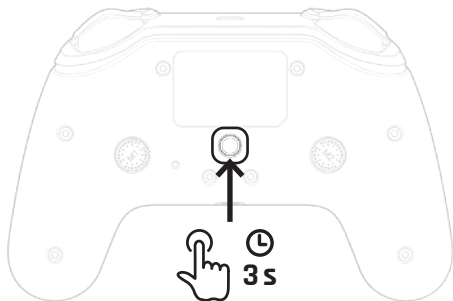

2.

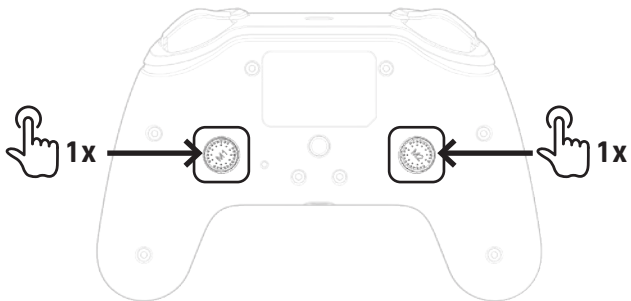

3.

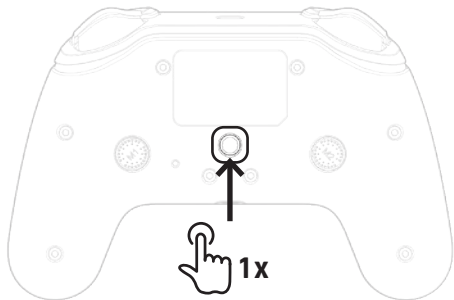

Turbo modes (Standard/Auto-Fire)

Modes turbo (Standard/Automatique) · Modos turbo (Estándar/Automático)

Turbo-Modi (Standard/Automatisch) · Modalità Turbo (Standard/Automático)

Standard

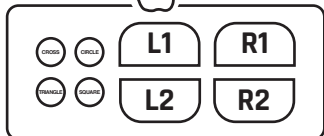

(Hold to activate Turbo · Maintenir pour activer le Turbo · Mantener pulsado para activar Turbo · Halten, um Turbo zu aktivieren · Tenere premuto per attivare il Turbo)

Auto-Fire



(Push to activate/deactivate Turbo · Pousser pour activer/désactiver le Turbo · Pulsar para activar/desactivar Turbo · Drücken zum Aktivieren/Deaktivieren des Turbos · Premere per attivare/disattivare il Turbo)

Adjust Turbo speed (global)

Régler la vitesse du turbo (global) · Ajustar velocidad Turbo (global)

Turbo-Geschwindigkeit einstellen (global) · Regolare la velocità del turbo (globale)

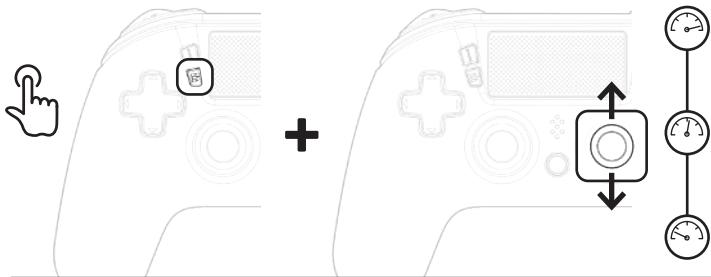

Reset turbo mode

Réinitialiser la mode turbo · Restablecer modo turbo

Turbo-Modus zurücksetzen · Azzeramento modalità Turbo

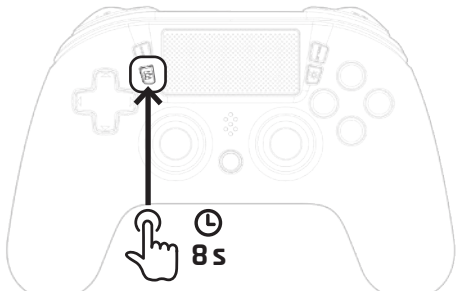

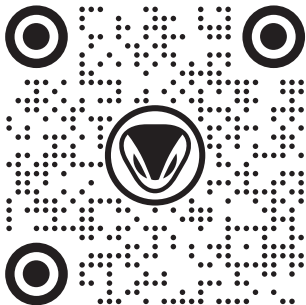

Manufacturer/APAC Import:

snakebyte Asia Ltd · Unit 907-908 · Lu Plaza · 2 Wing Yip Street · Kwun Tong · Kowloon · Hong Kong

North/Latin America Import:

snakebyte USA Inc. · 8799 Balboa Ave #265 · San Diego · CA 92123 · USA

UK Import:

snakebyte UK Ltd · 59 High Street · Newport · Shropshire · TF10 7AU · UK

EU Import:

snakebyte Distribution GmbH · Konrad-Zuse-Str. 13 · 58239 Schwerte · Germany

Australia/New Zealand Import:

Directed Electronics Australia Pty Ltd · 115-119 Link Road · Melbourne Airport VIC · 3045 · Australia

All rights reserved. This document may not in whole or in part be reproduced, stored in a retrieval system, transmitted in any form or by any means, electronic, mechanical, photocopying, recording, or otherwise, or reduced to any electronic medium or machine-readable form without prior consent, in writing, from snakebyte distribution GmbH. snakebyte is a registered trademark of snakebyte distribution GmbH. Sony, PlayStation® and PS4™ are registered trademark of Sony Computer Entertainment. This product is not designed, manufactured, approved, sponsored, or endorsed by Sony. snakebyte is a registered trademark of snakebyte distribution GmbH. All trademarks are the properties of their respective owners.

Made in China · Fabriqué en Chine · Fabricado en China

© 2024 snakebyte · Version 09/2024

Email: support@snakebyte.com | Website: www.snakebyte.com