



# Friends

42677



1



LEGO® Builder



LEGO.com/sustainable-packaging



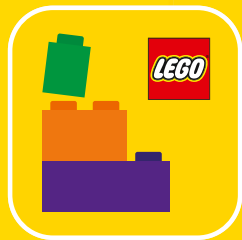

Q LEGO® Builder

# BUILDER



Apple and the Apple logo are trademarks of Apple Inc., registered in the U.S. and other countries and regions. App Store is a service mark of Apple Inc. Google Play and the Google Play logo are trademarks of Google LLC. Tencent and the Tencent logo are trademarks of Tencent Inc.

Q [LEGO.com/devicecheck](https://LEGO.com/devicecheck)

EN Ask parents' permission before going online | DE Eltern um Erlaubnis bitten, bevor du online gehst | FR Demande l'autorisation d'un parent avant d'aller en ligne | IT Chiedi il permesso ai tuoi genitori prima di andare online | ES Pídeles permiso a tus papás antes de conectarte a Internet | PT pede autorização aos pais antes de acederes online | ZH 上网前应先征得父母的同意 | PL Poproś rodziców o zgodę, zanim wejdiesz do Internetu | CS Než půjdeš na internet, požádej rodiče o svolení | SK Skôr než pôjdeš na internet, vypýtaj si povolenie od rodičov | HU Kérj szülői engedélyt, mielőtt online csatlakoznál! | UA Запитуйте дозволу батьків, перш ніж користуватися інтернетом | RO Cere permisiunea părinților înainte de a te conecta online | BG Поискайте разрешение от родител, преди да влезете онлайн | LV Pirms došanās tiešsaistē palūdz atļauju vecākiem | ET Enne Interneti kasutamist küsi vanematelt luba | LT Prieš prisijungdami prie interneto, atsklauskite tėvų



# Aliya

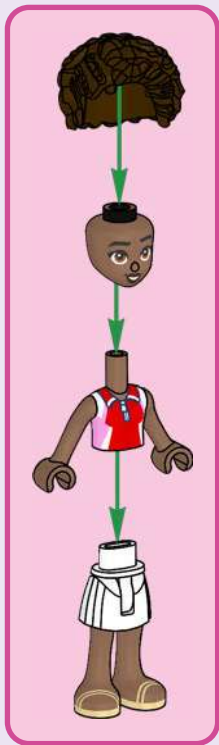

**Aira**



**Frenchie**





1x



1x

1



2



3



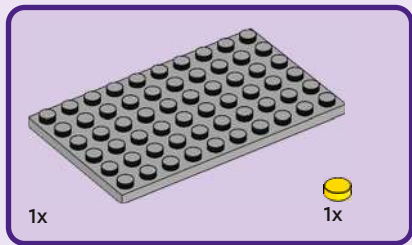

1

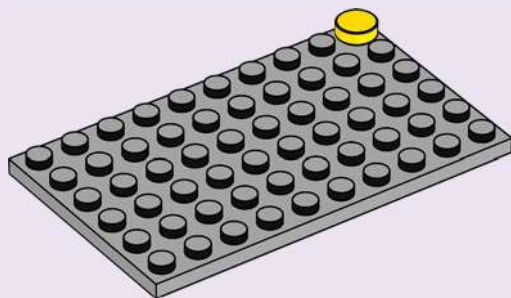

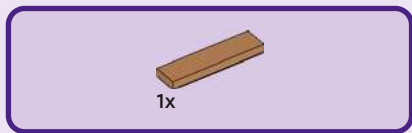

2

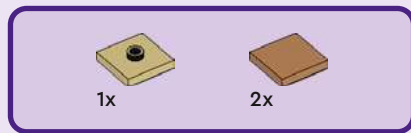
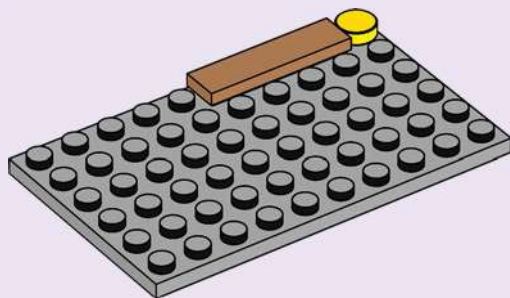

3

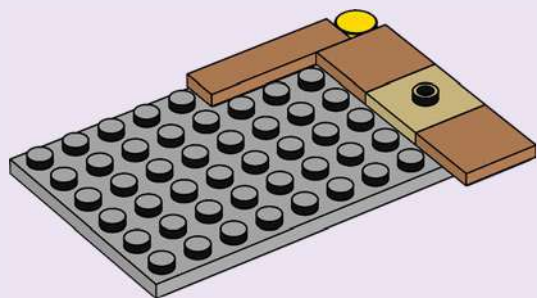

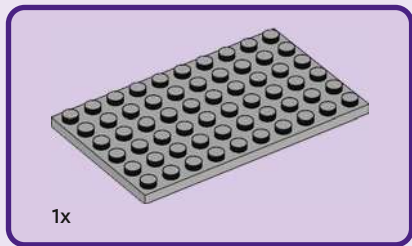

4

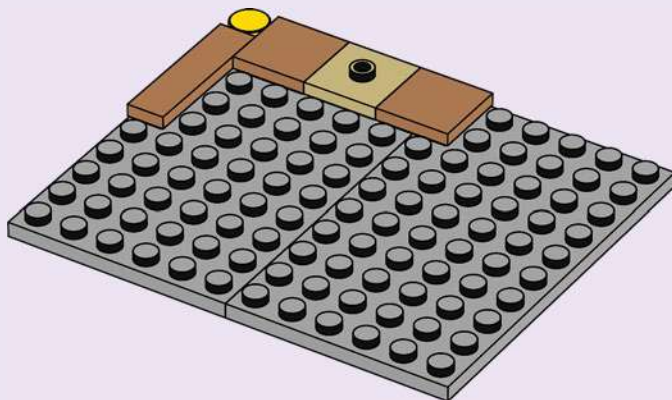



2x



1x

5

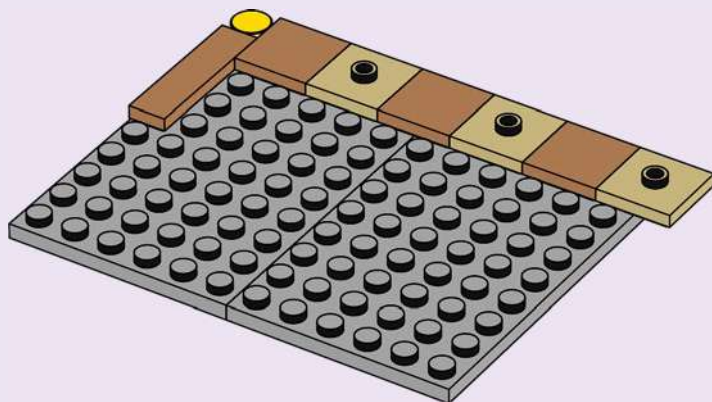

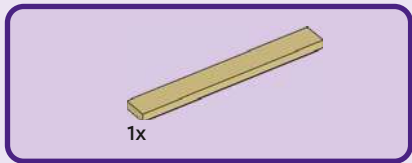

6

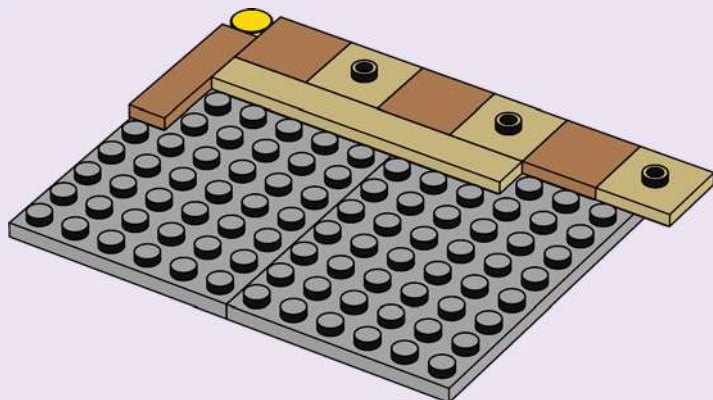



2x



2x

7

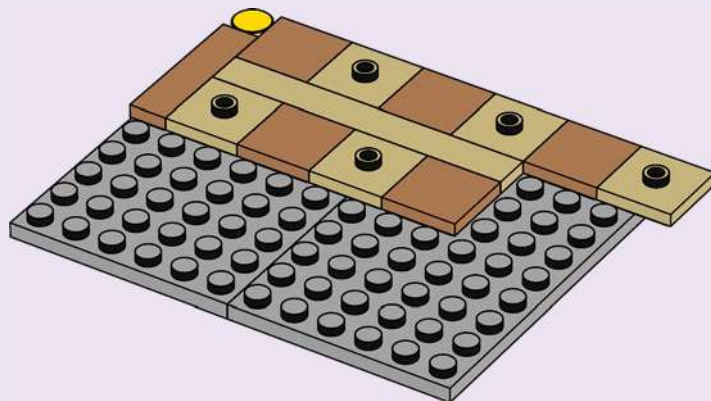

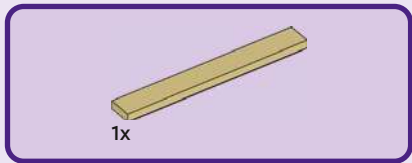

8

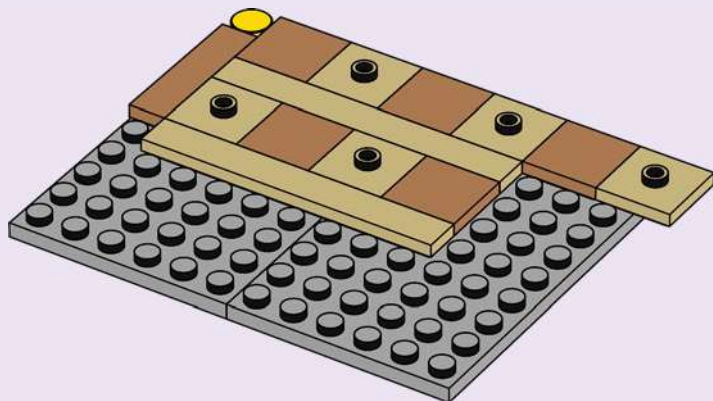



2x



2x

9

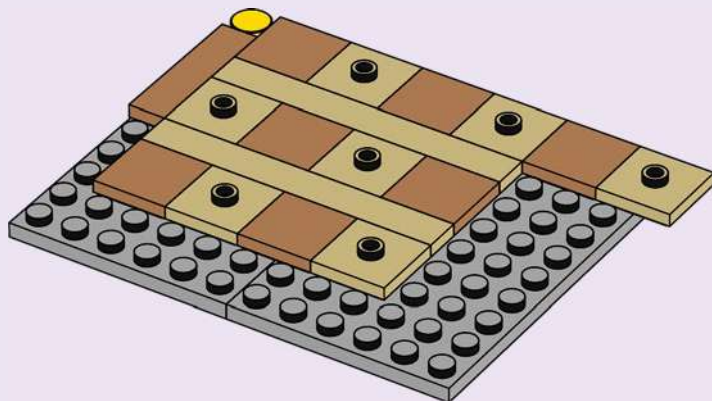

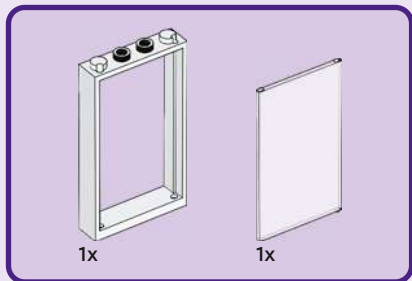

10

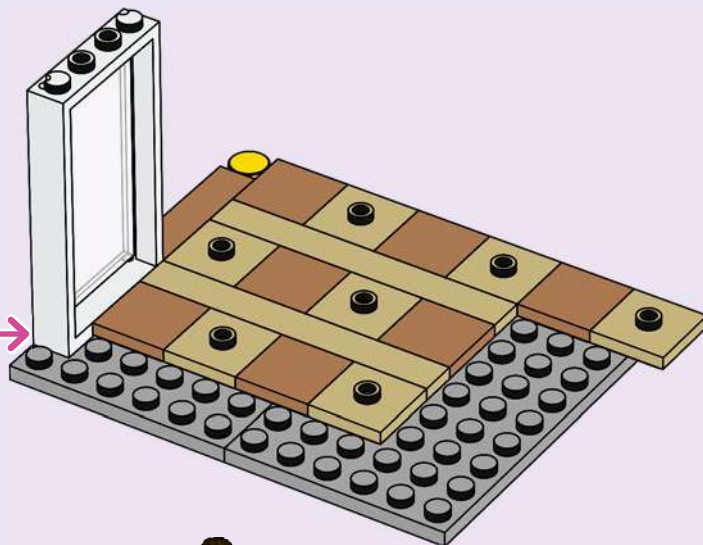
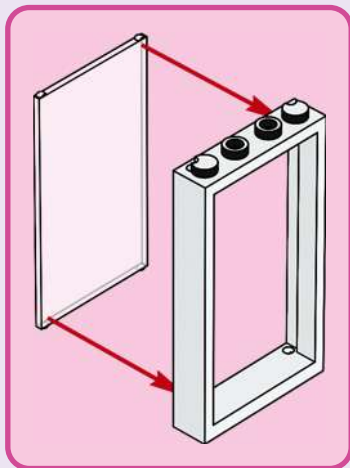



2x

11

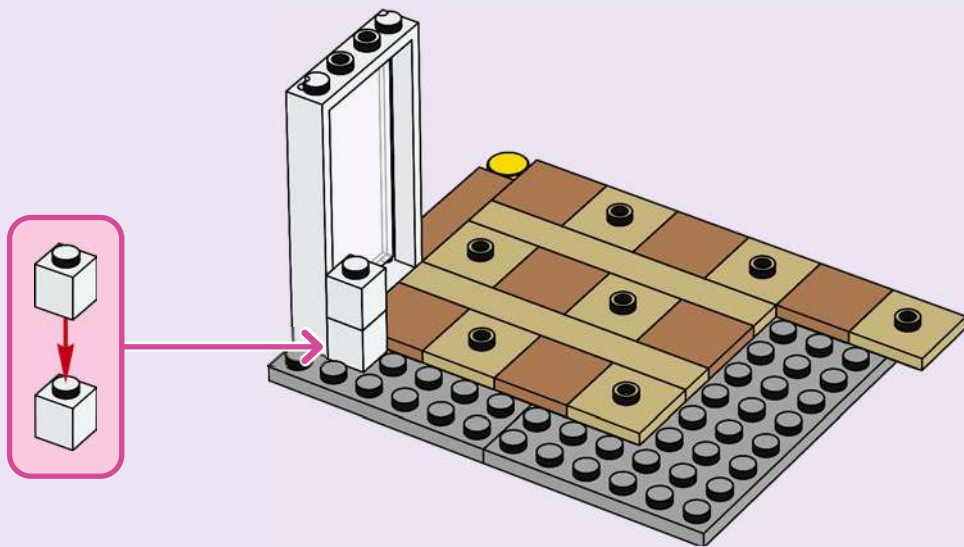



1x

12

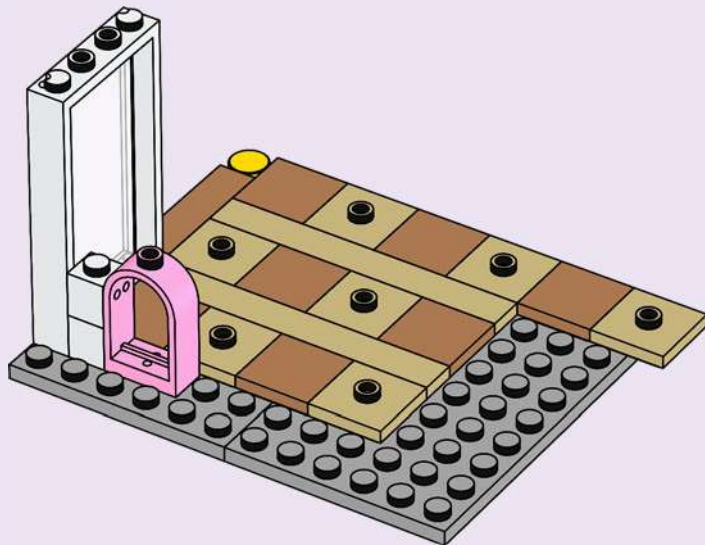



2x

13

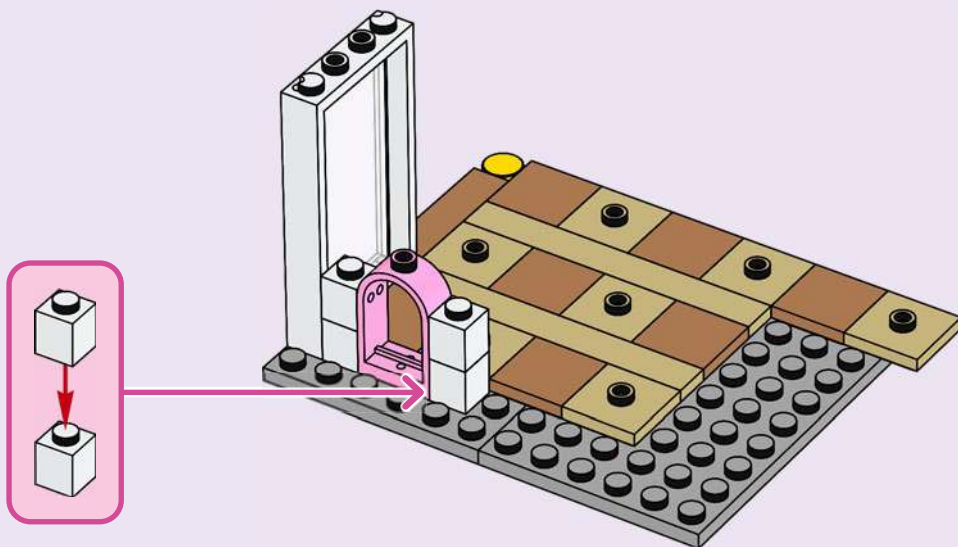



1x

14

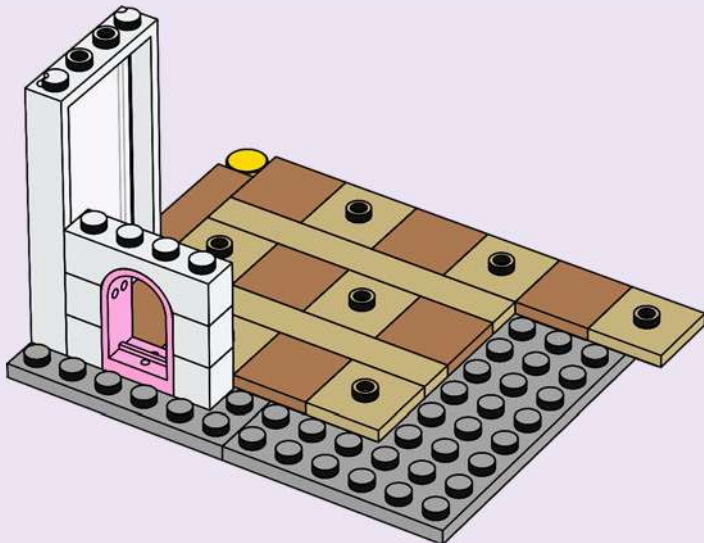

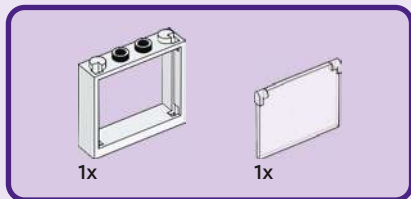

15

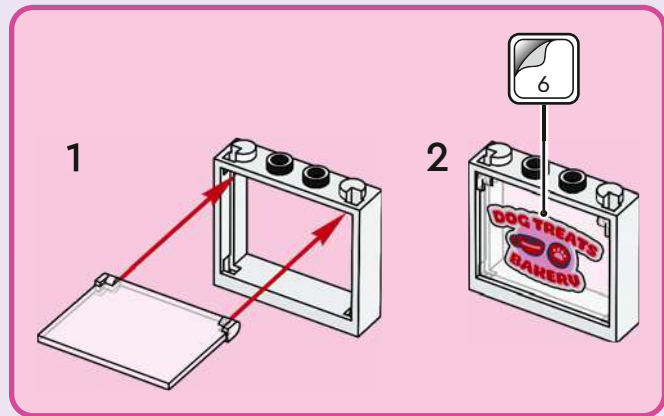
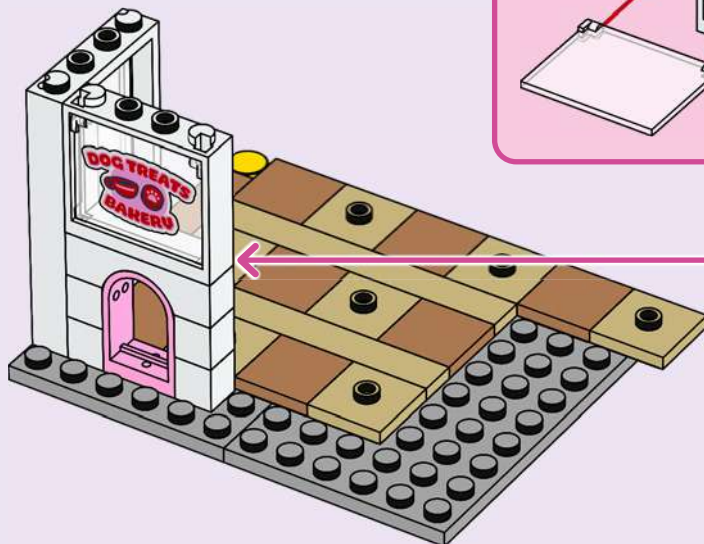

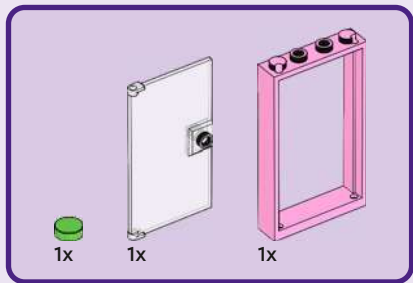

16

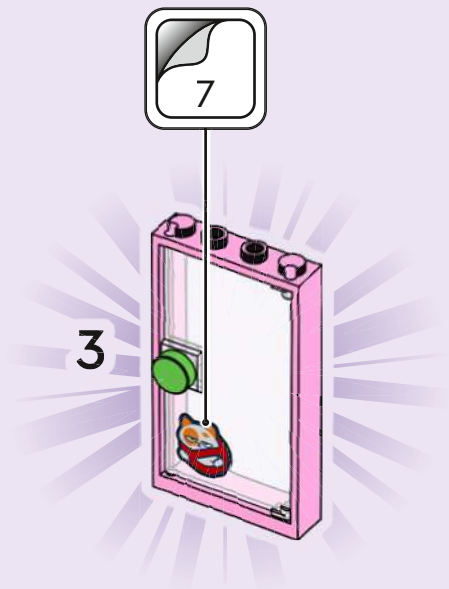
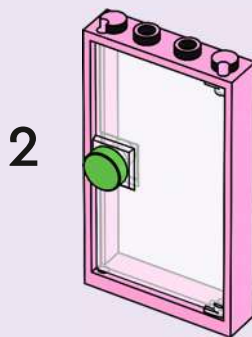
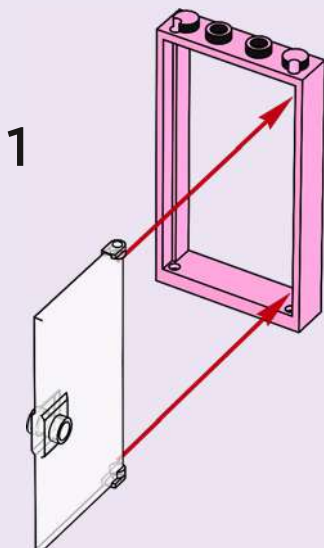

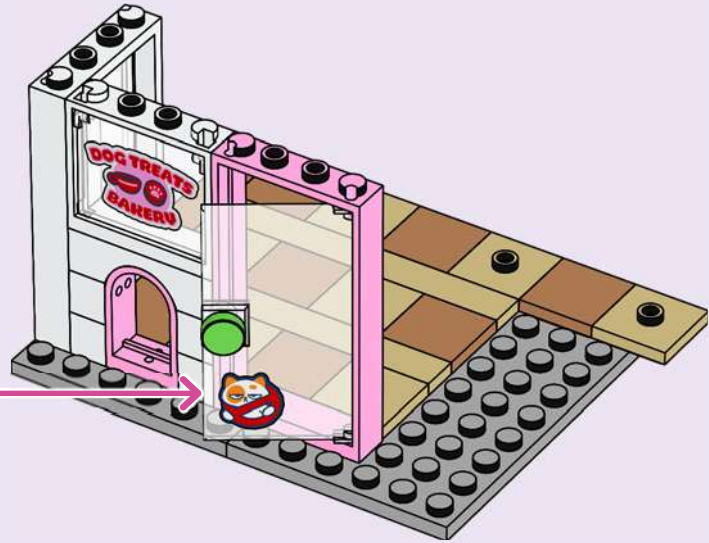



1x



1x

17

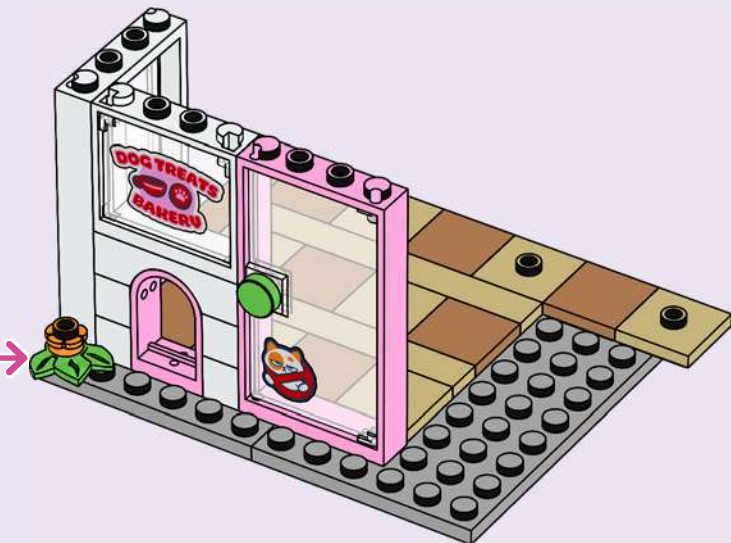
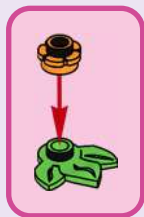

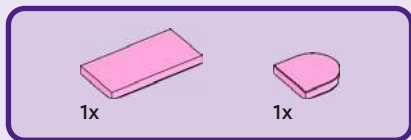

18

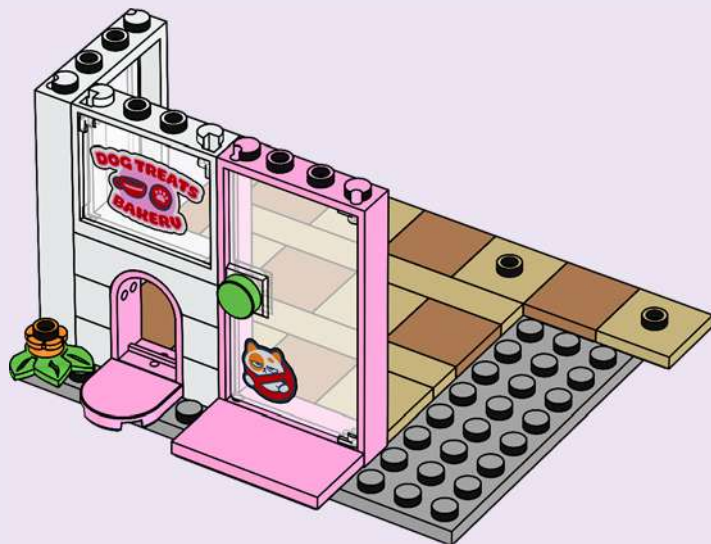



19





2x



1x

20



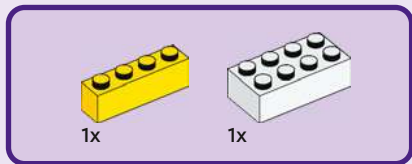

21



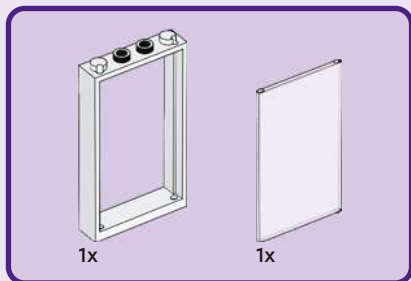

22

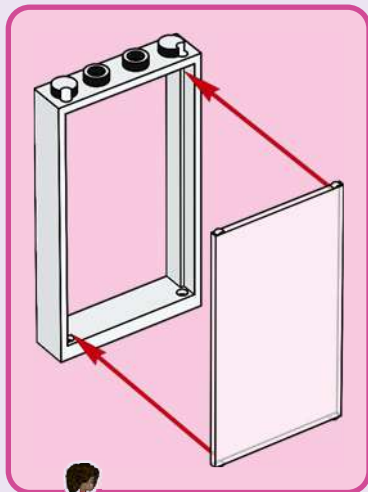

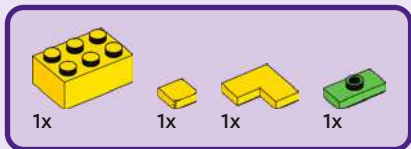

23

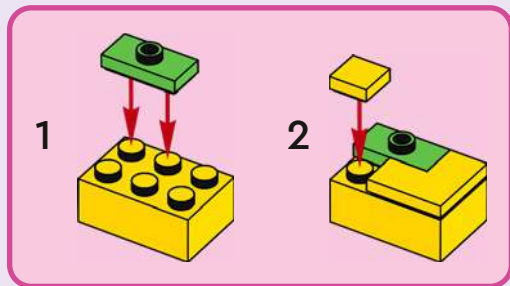

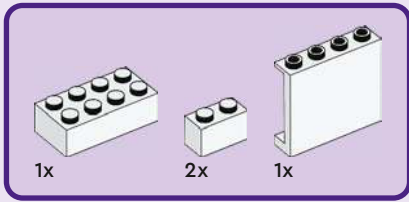

24

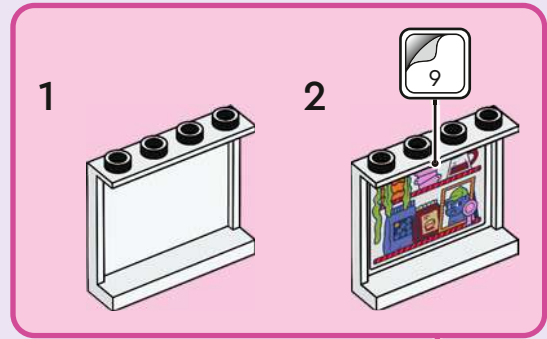

1



2

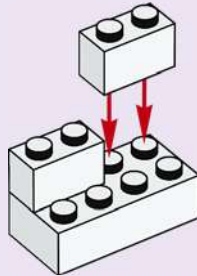

3



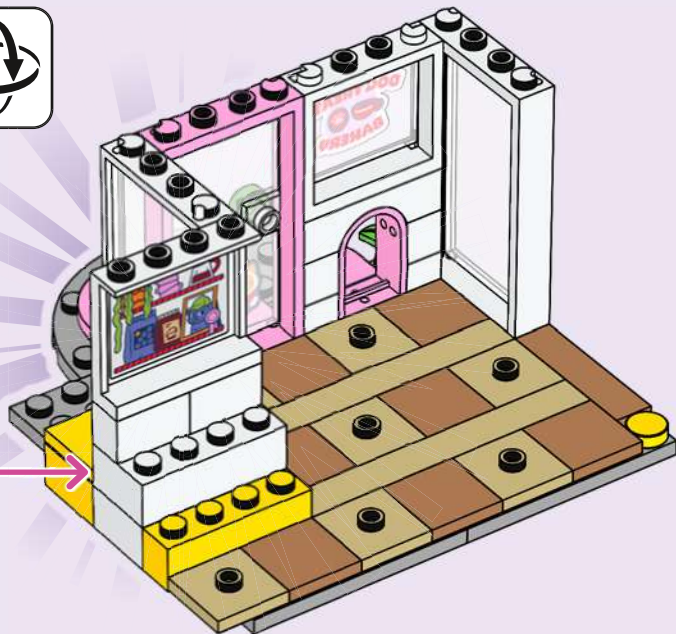



1x

25

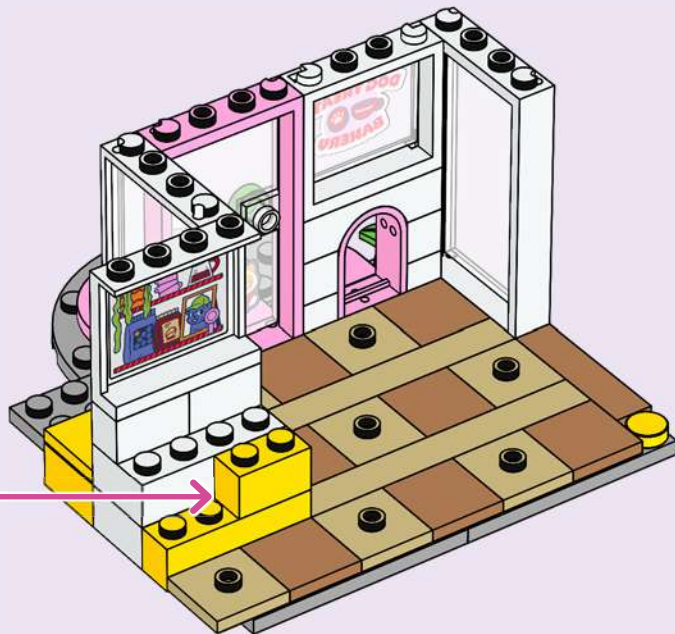

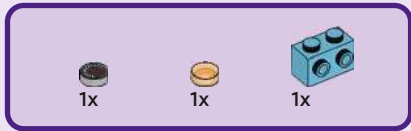

26

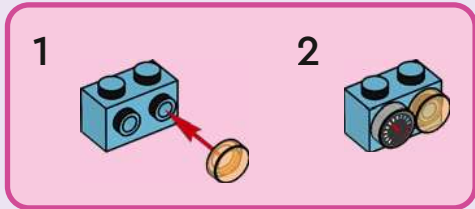
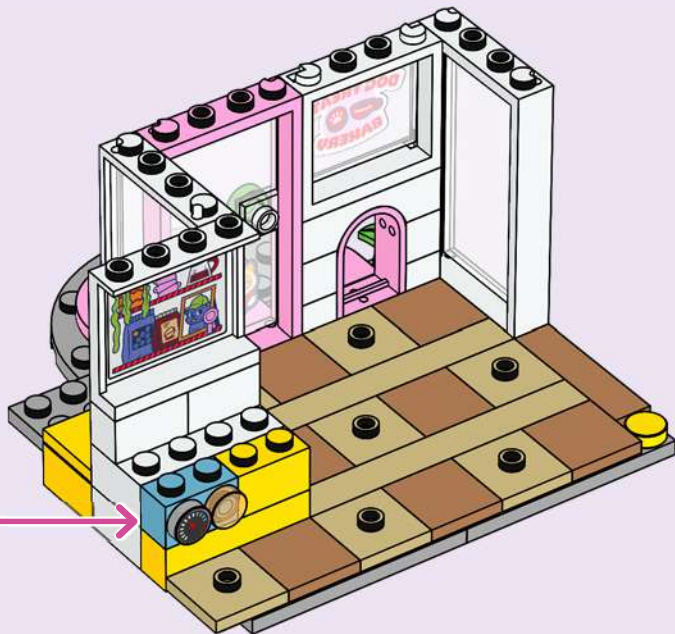



1x

27

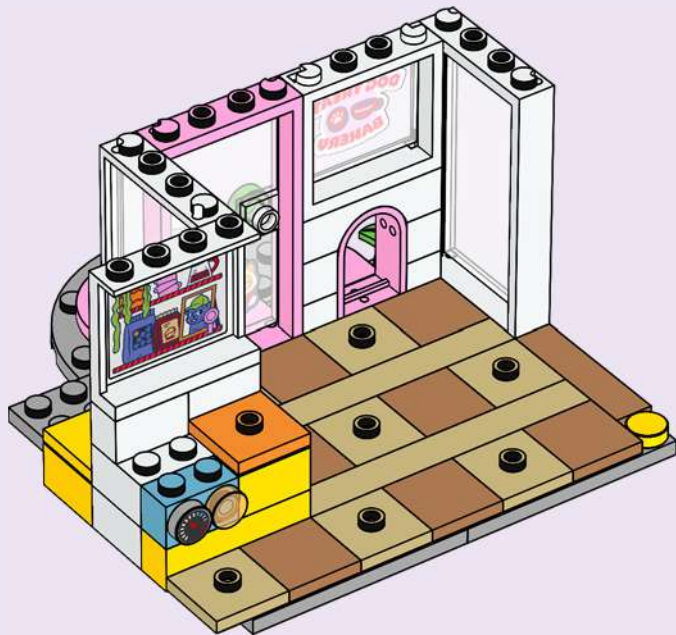



1x



1x

28

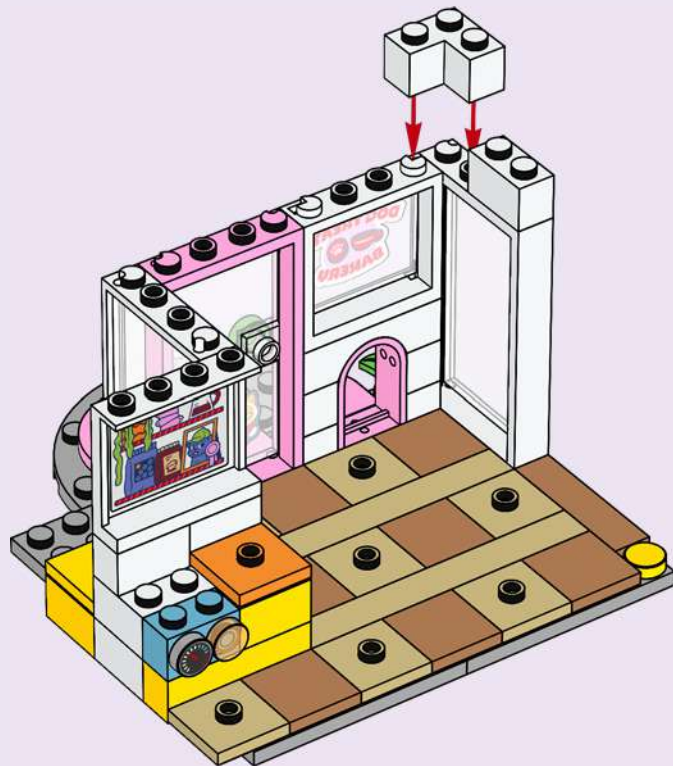



2x



1x

29

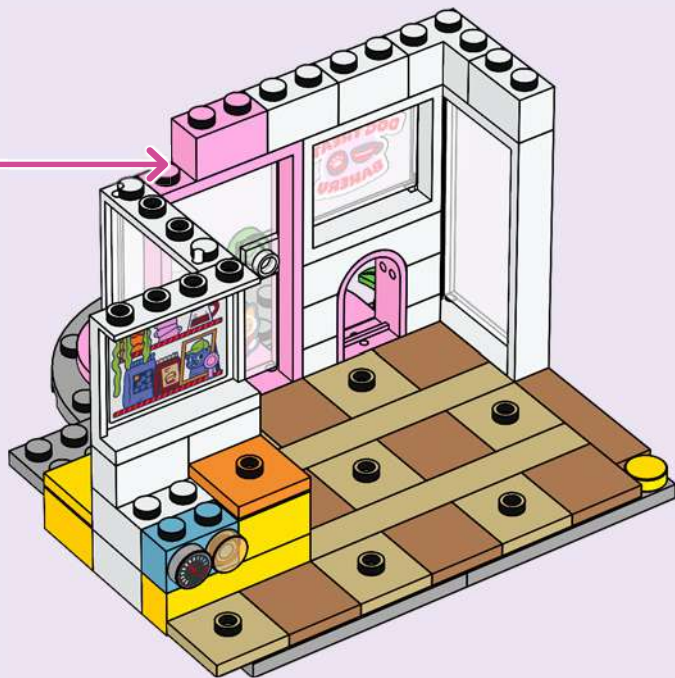
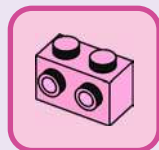



2x



1x

30



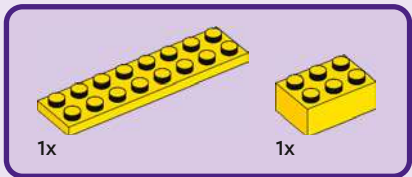
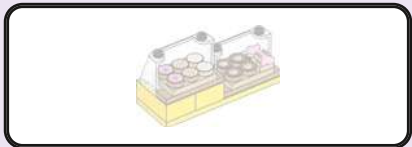

31

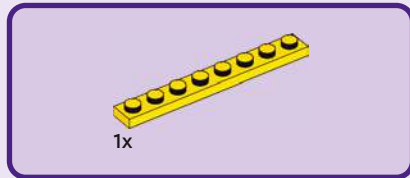
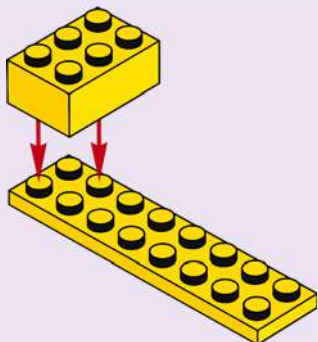

32

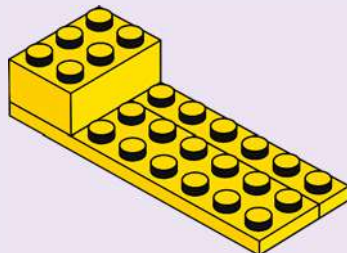



1x

33

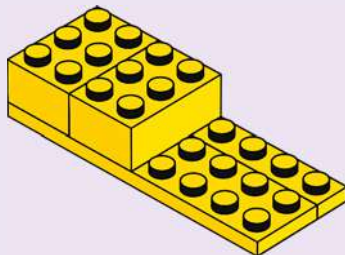



34

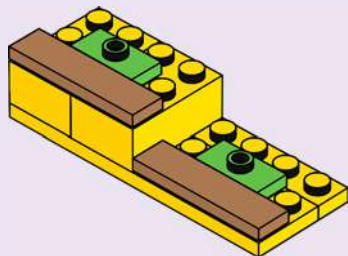

35

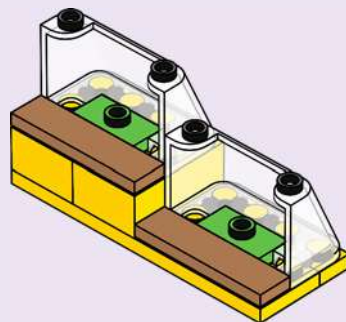



36

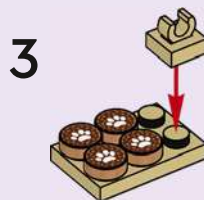
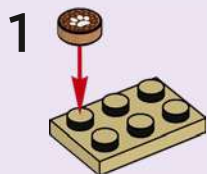





37



38





1x

39





1x

40







# Friends

42677



2



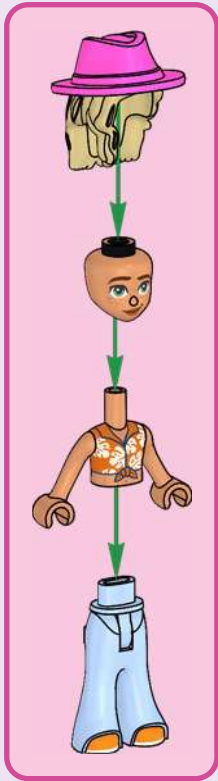

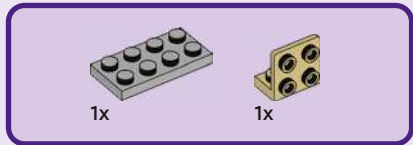

1

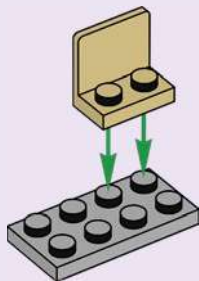

2

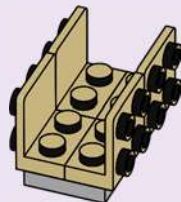



3

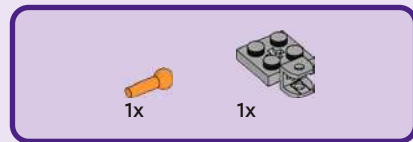
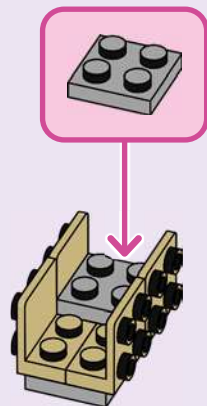

4

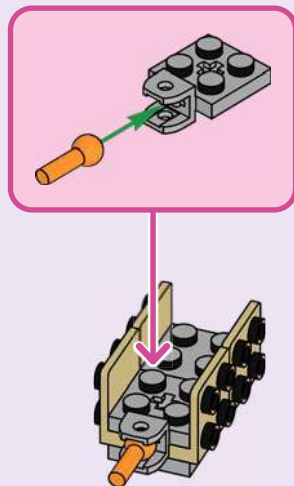



2x



1x

5

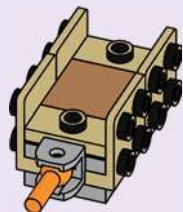

2x

6

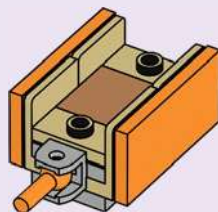



2x



2x

7

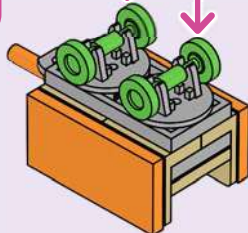
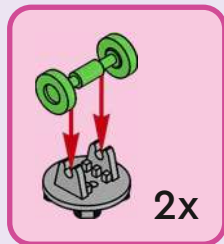

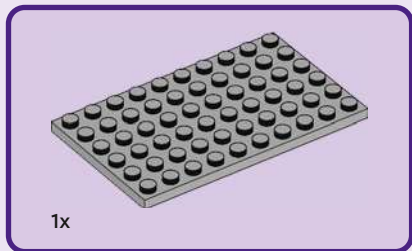

41





42



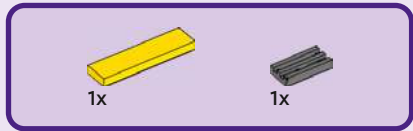

43





2x

44



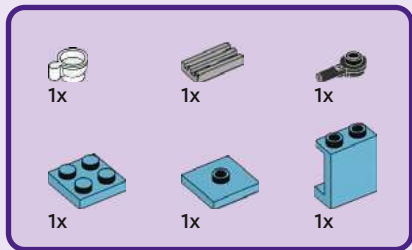

45

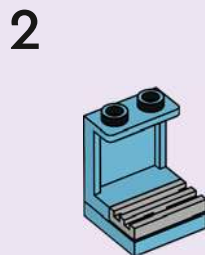
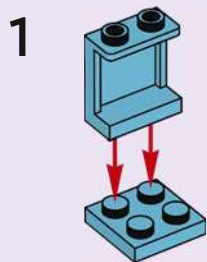

4



5

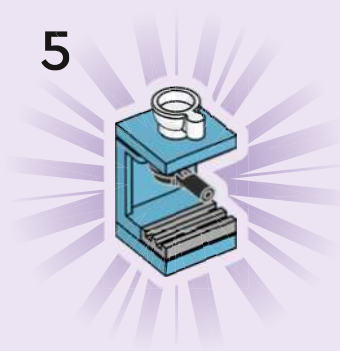

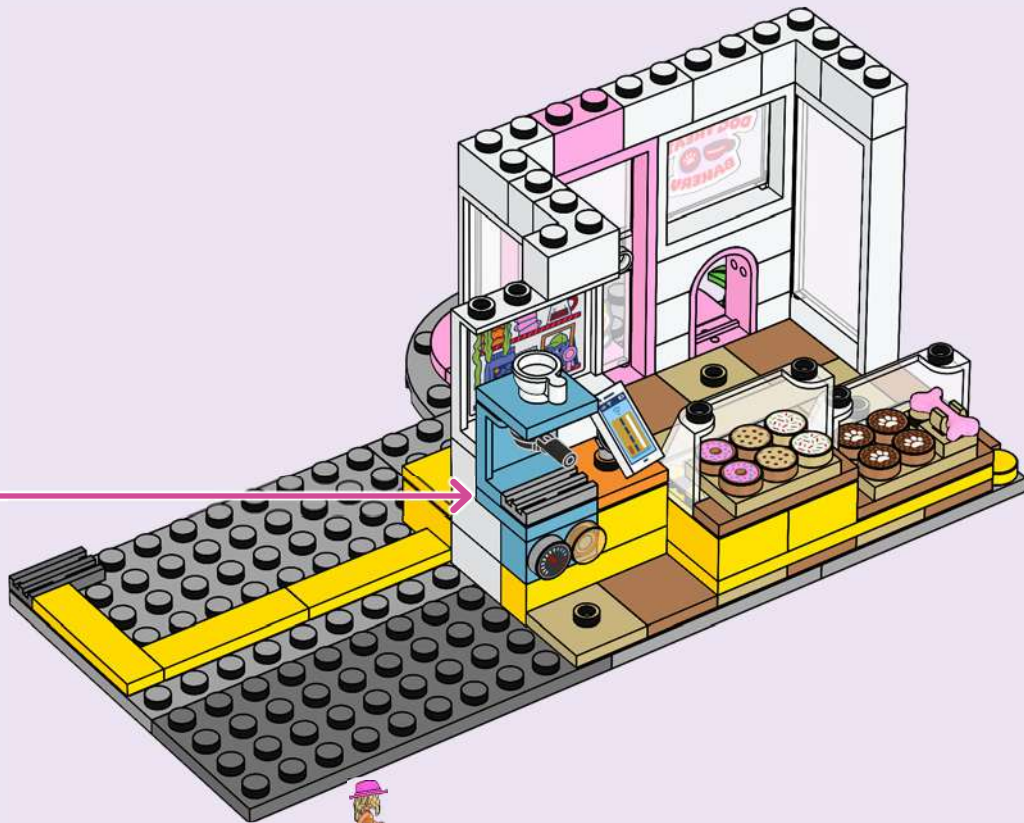

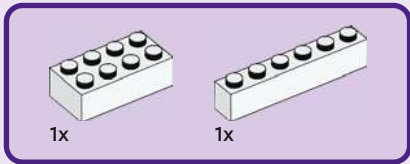

46

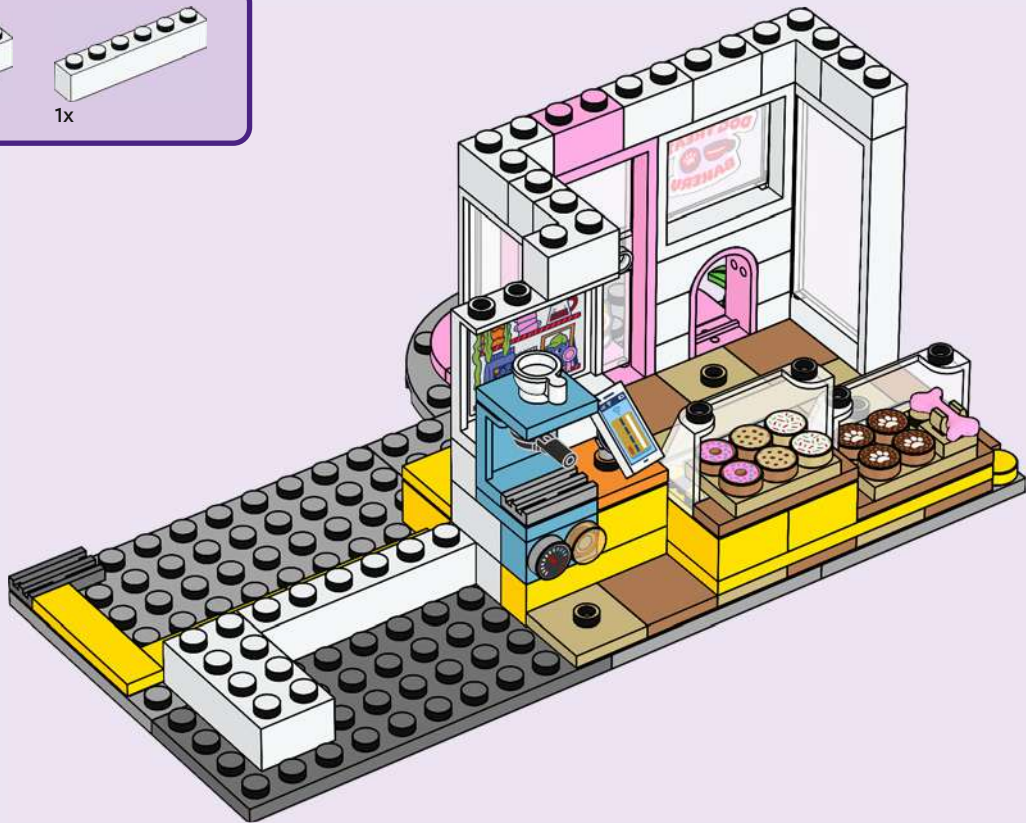



4x

47



4x

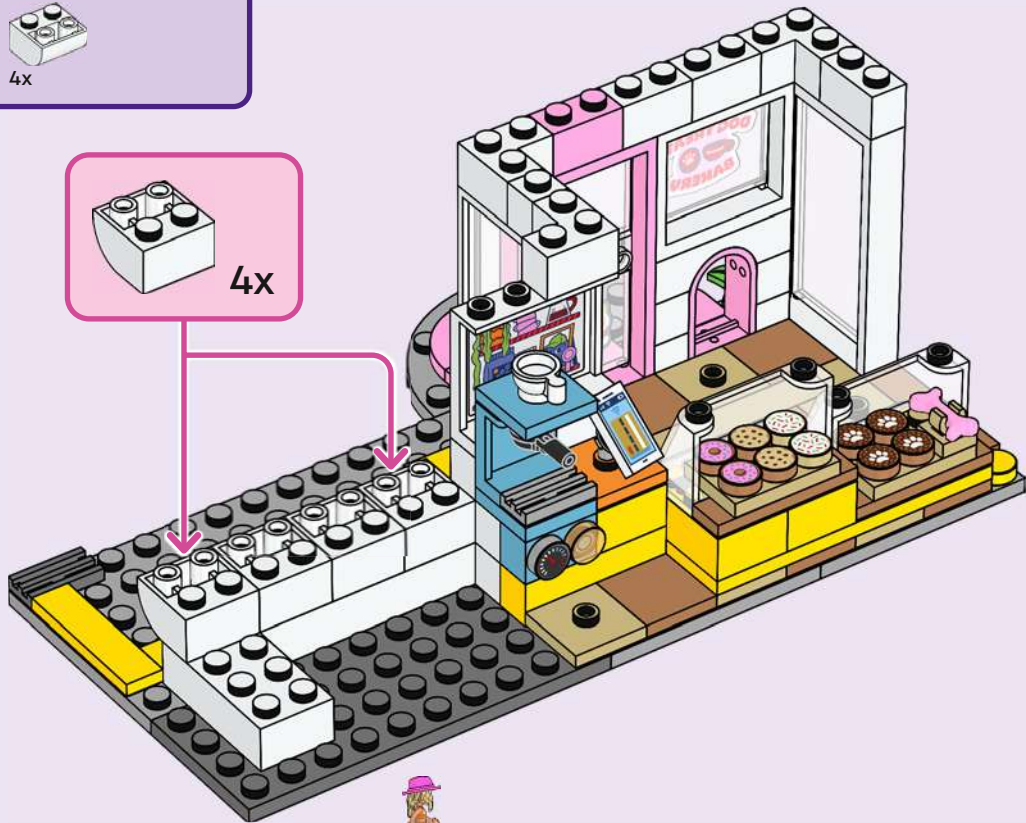

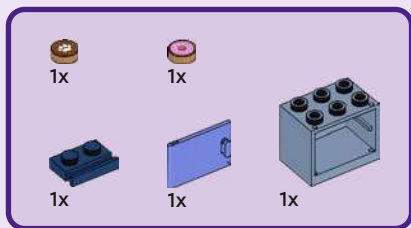

48

1

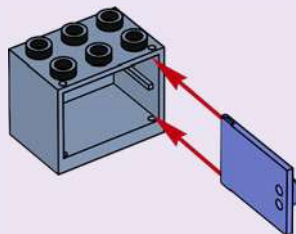

2

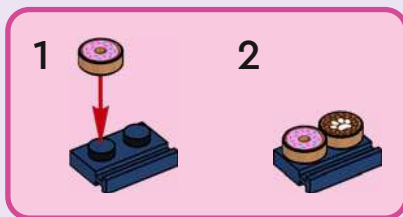
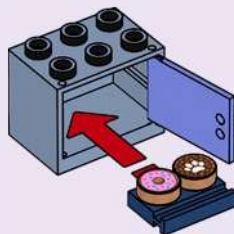

3

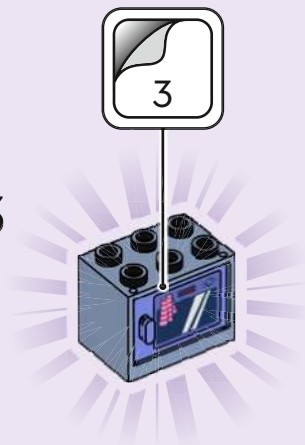

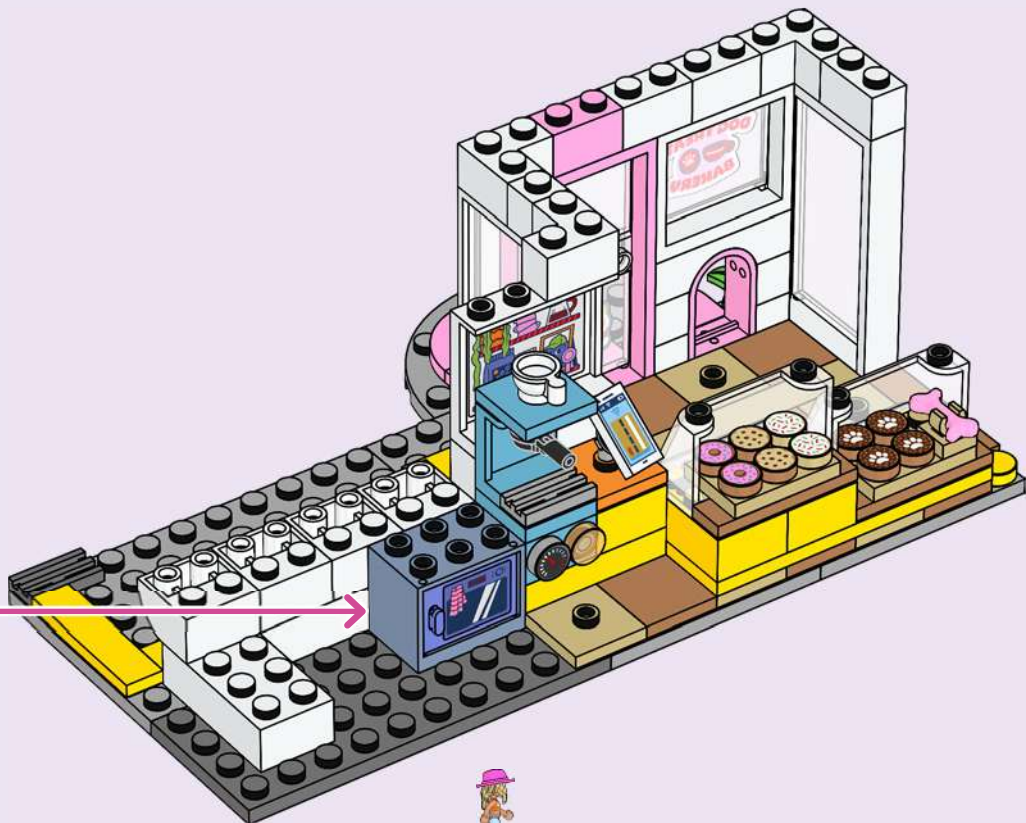

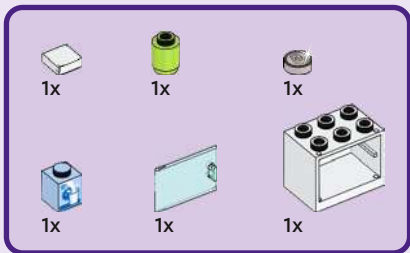

49

1

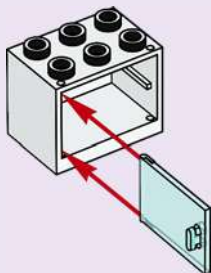

2

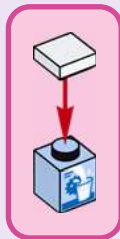

3

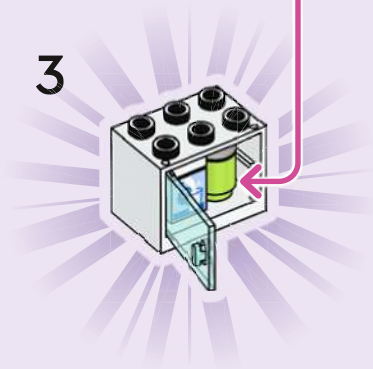

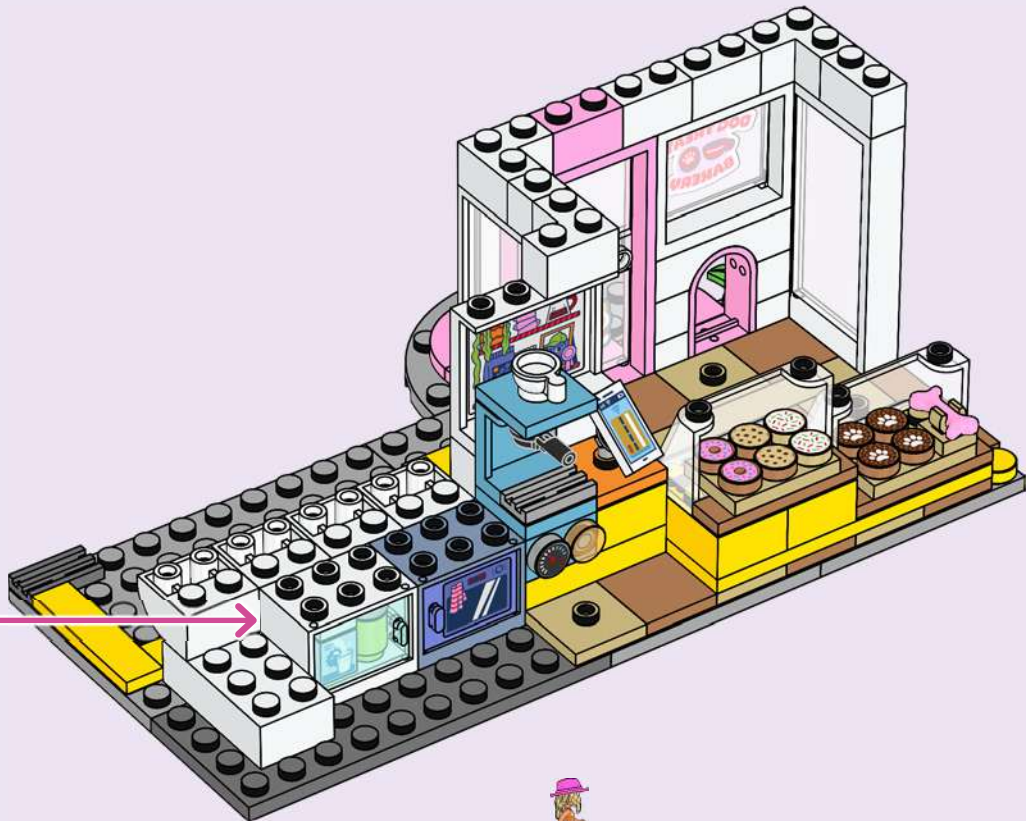



1x

50

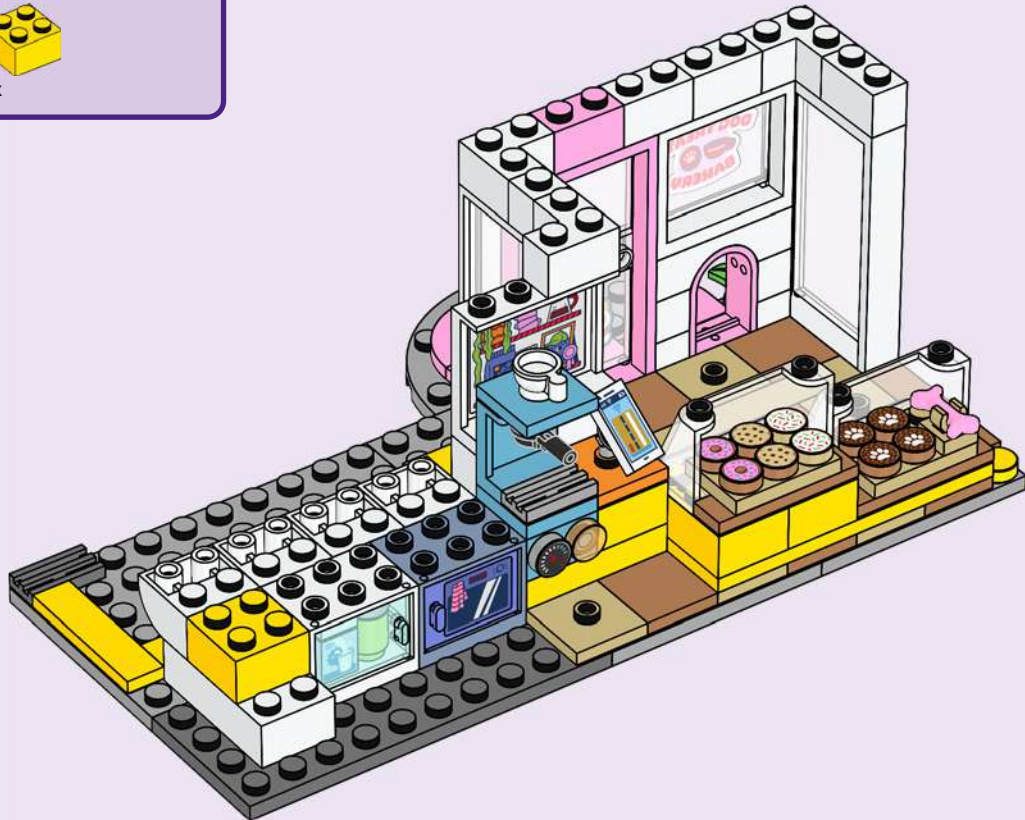



1x



2x

51





2x

52

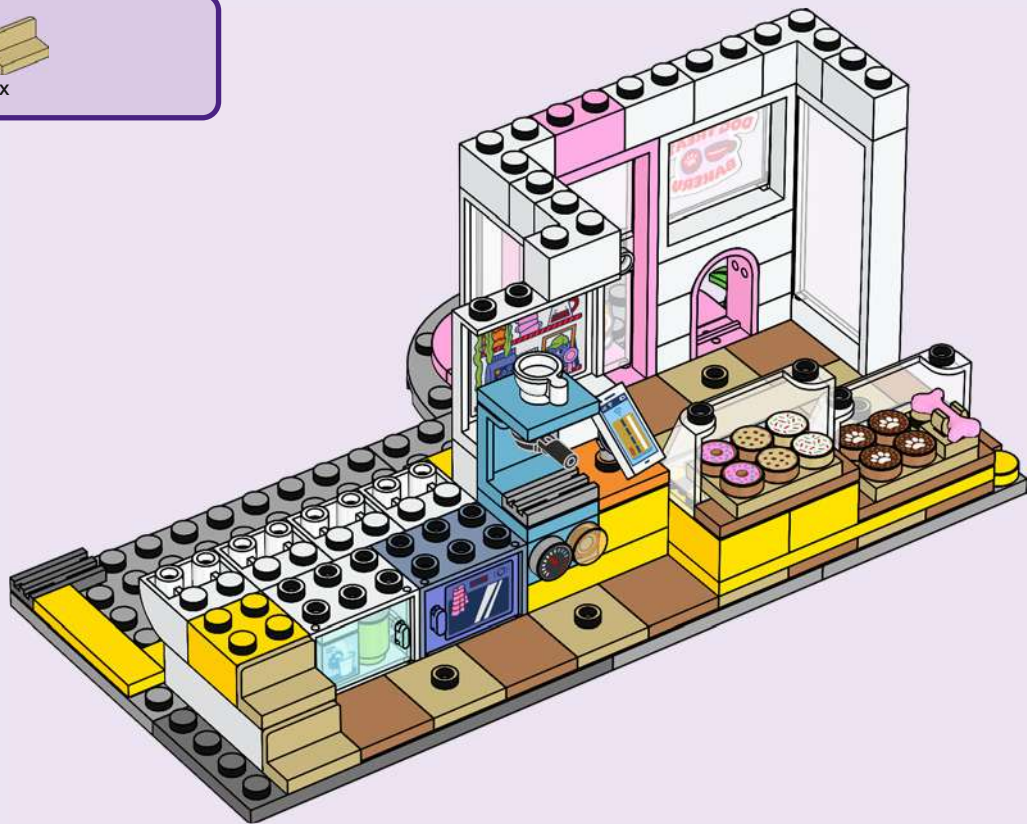



2x

53

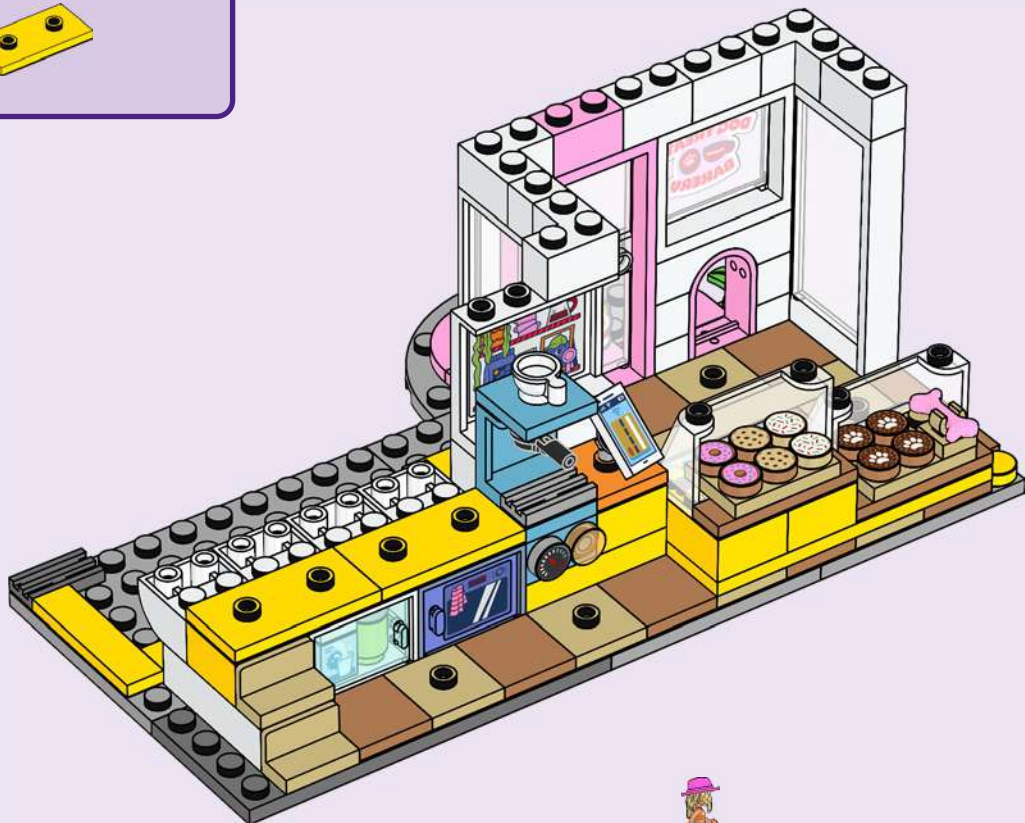

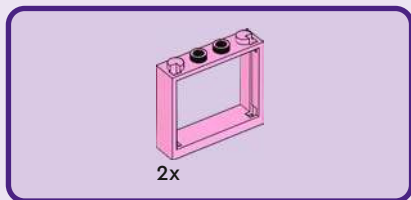

54

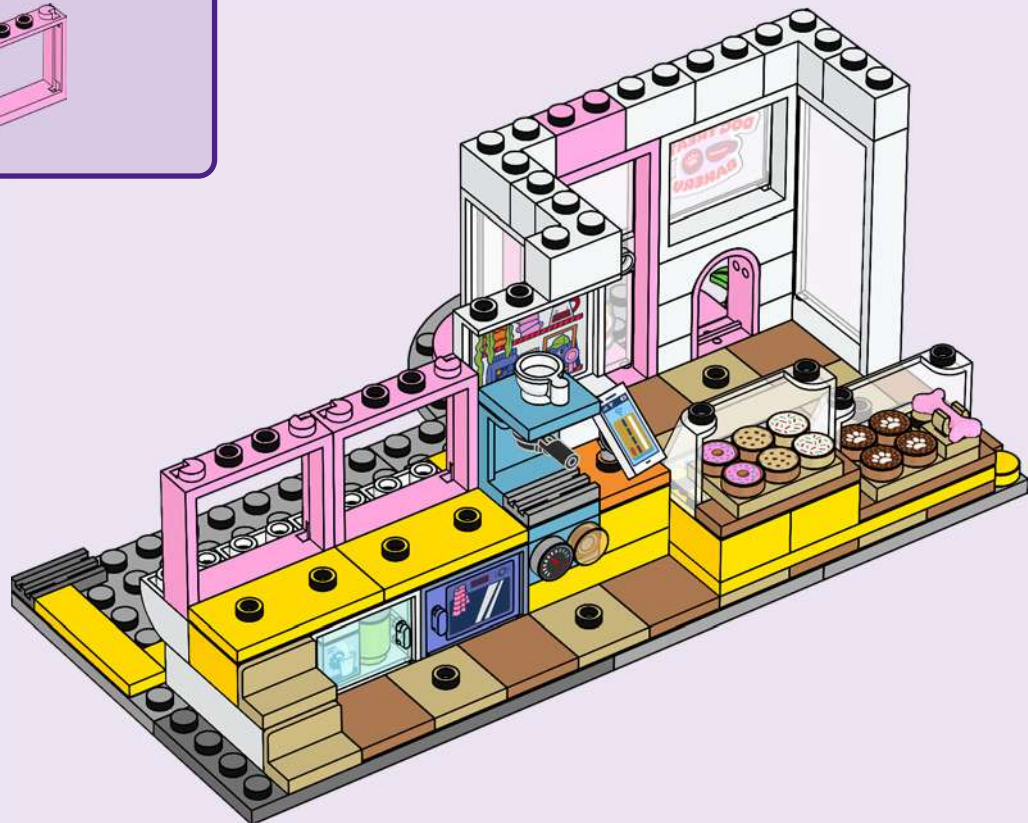



1x

55

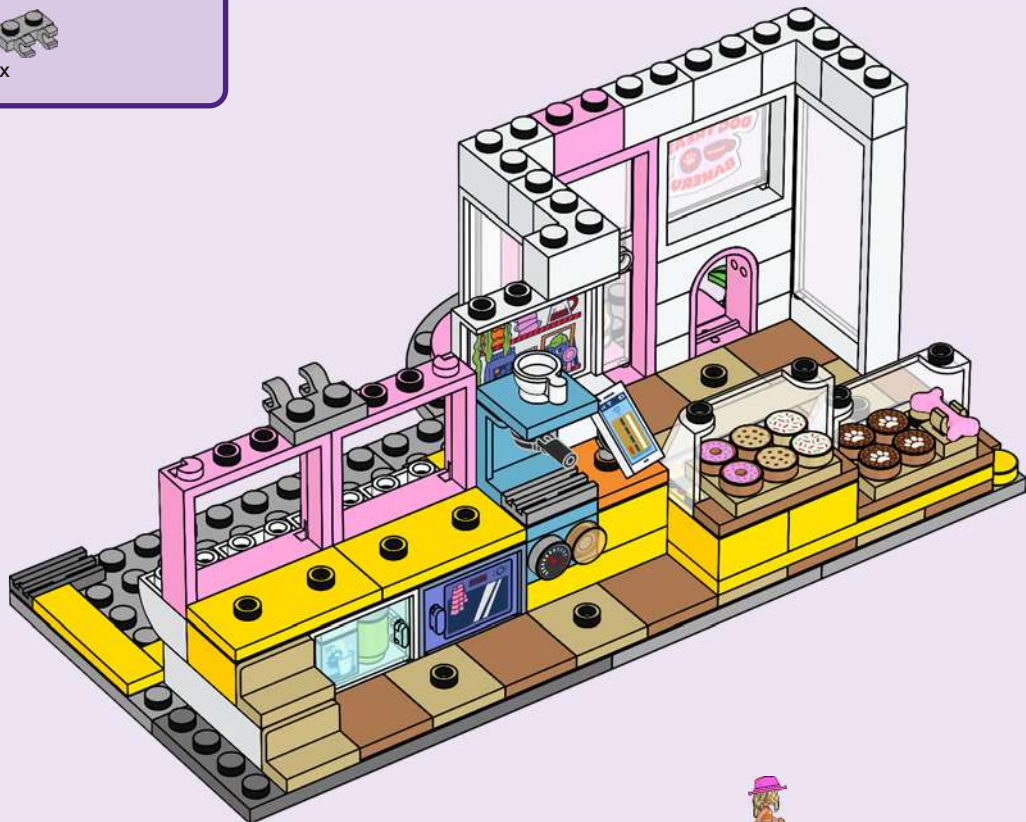



1x



1x

56

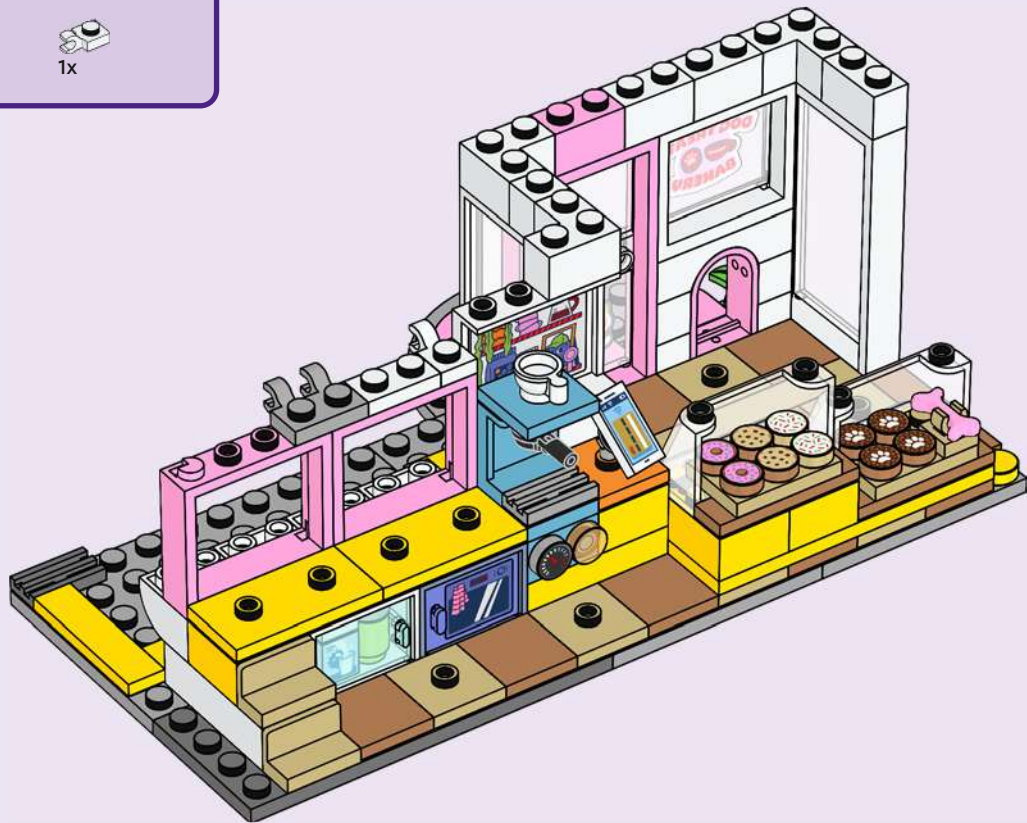



1x



1x

57



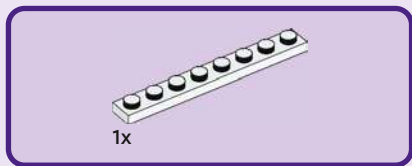

58

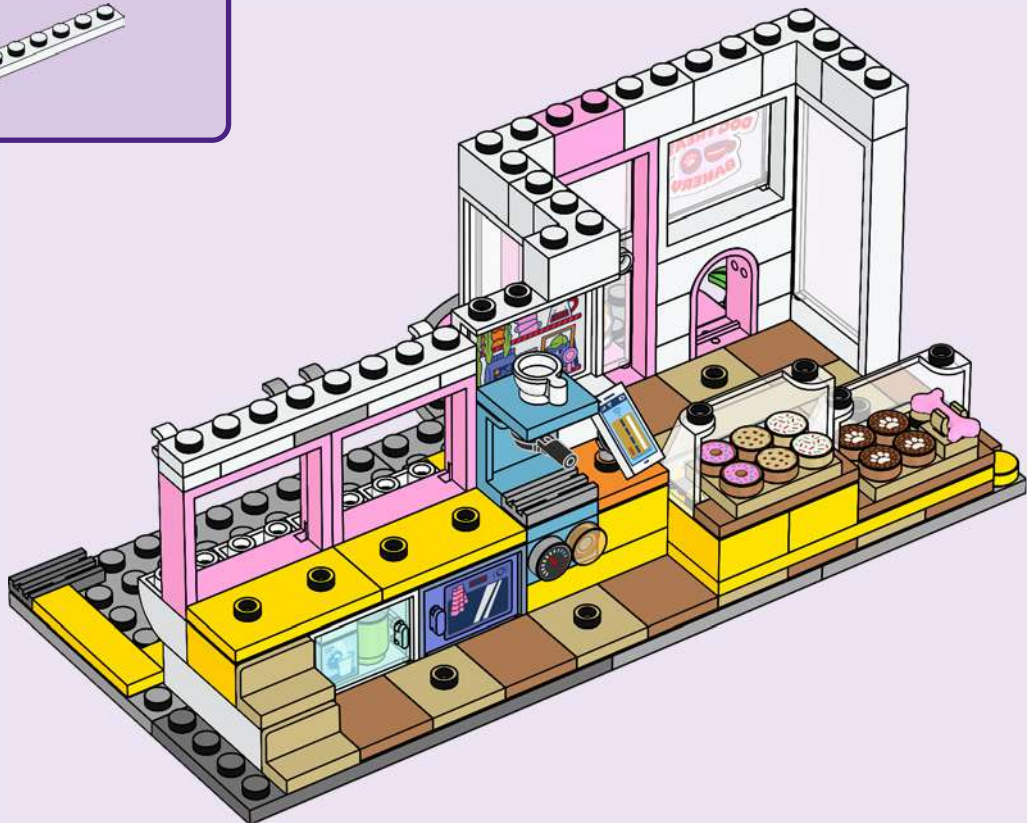



4x

59



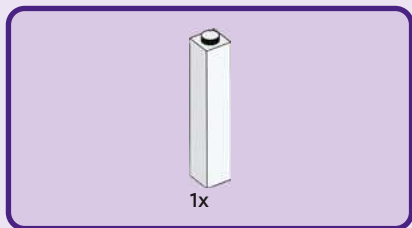

60

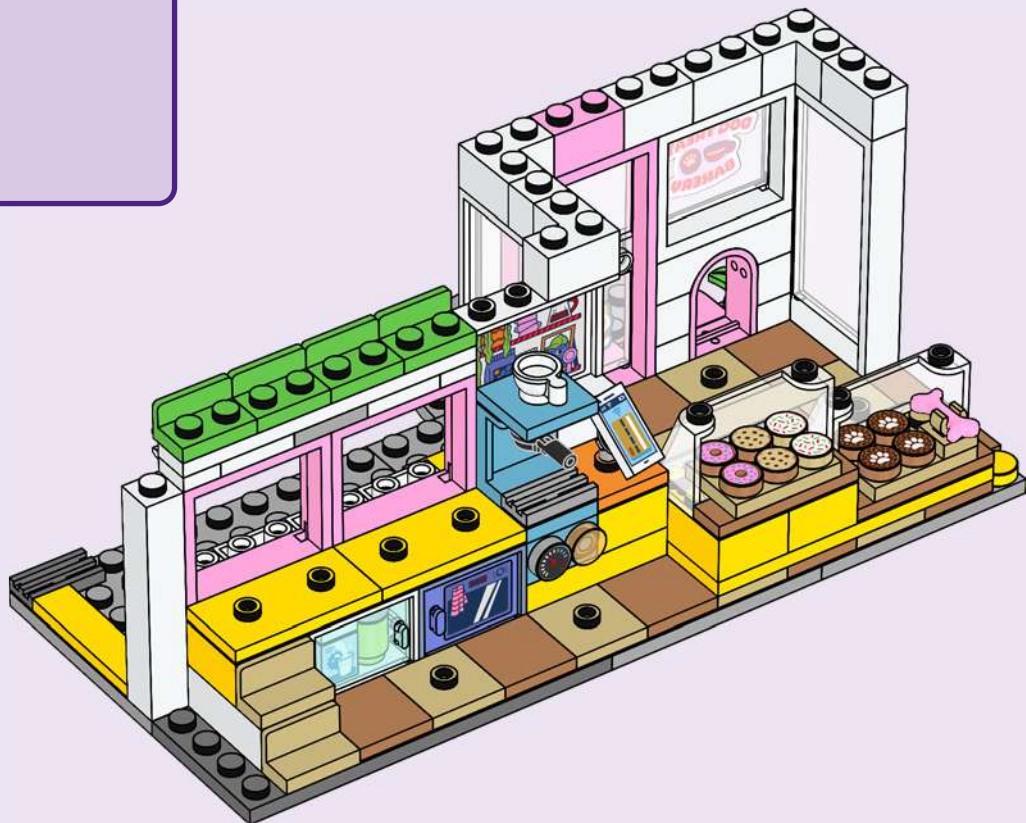



1x

61



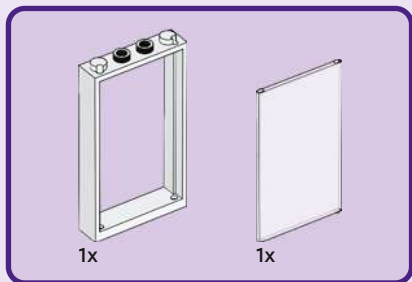

62

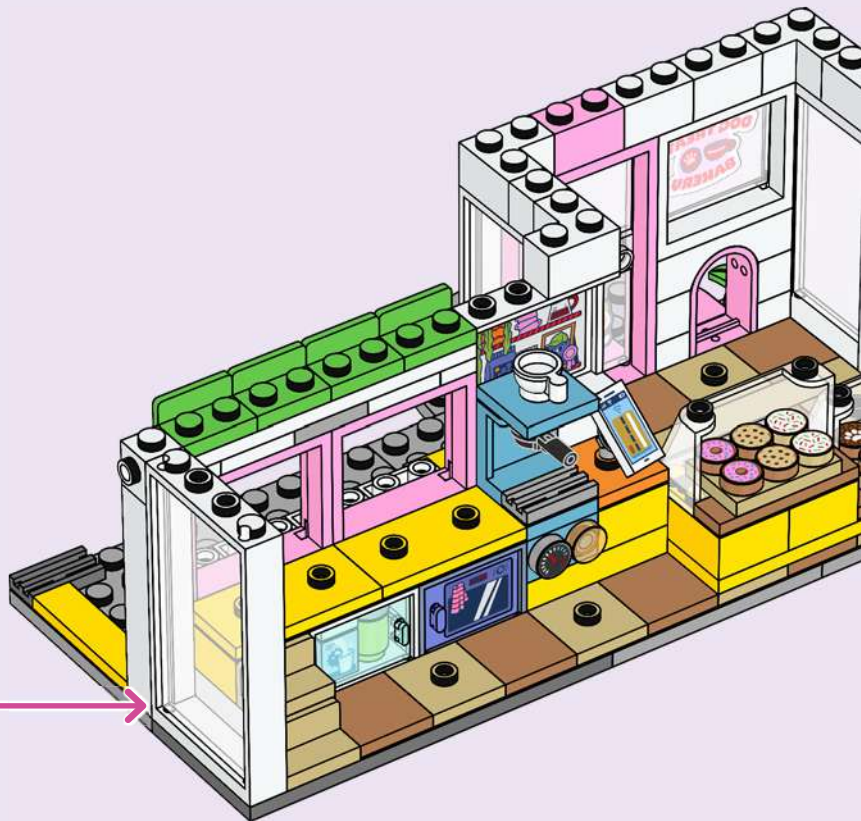
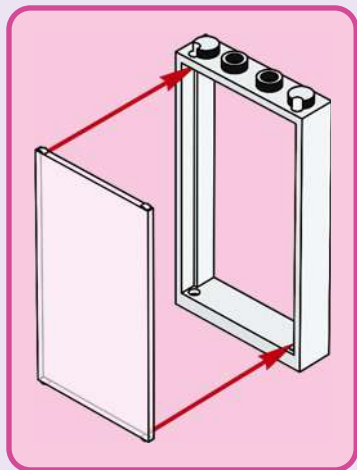



2x



1x

63

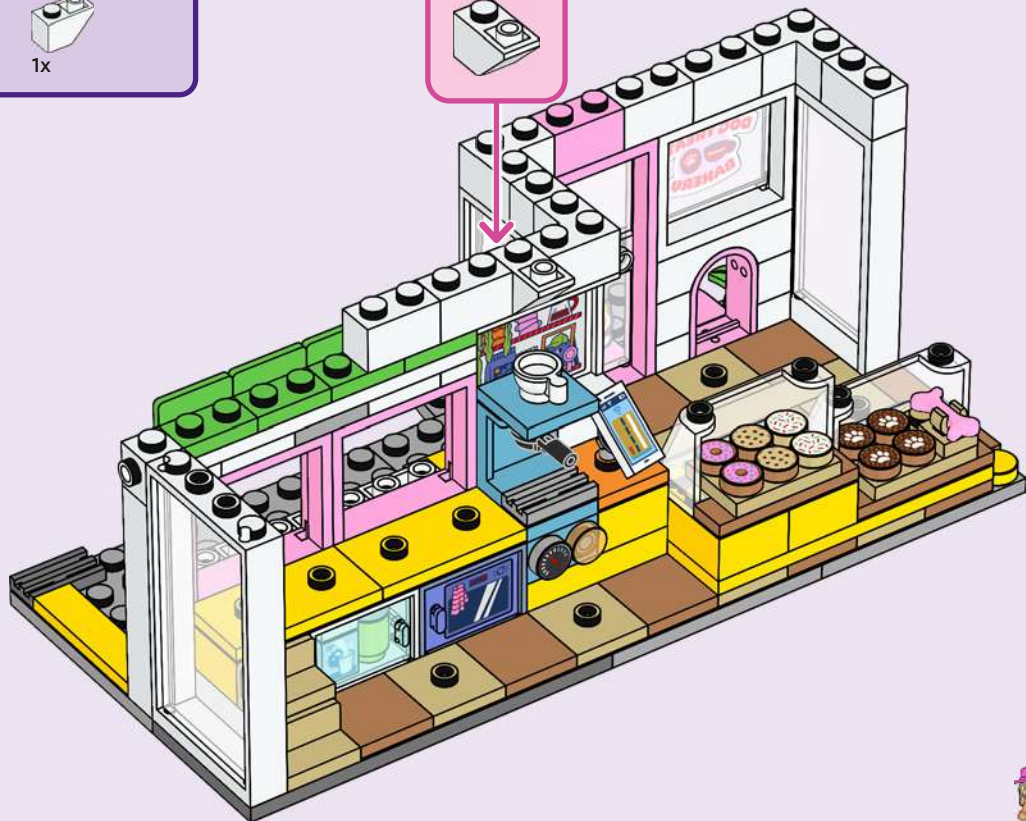



1x



1x



1x

64





1x



1x

65

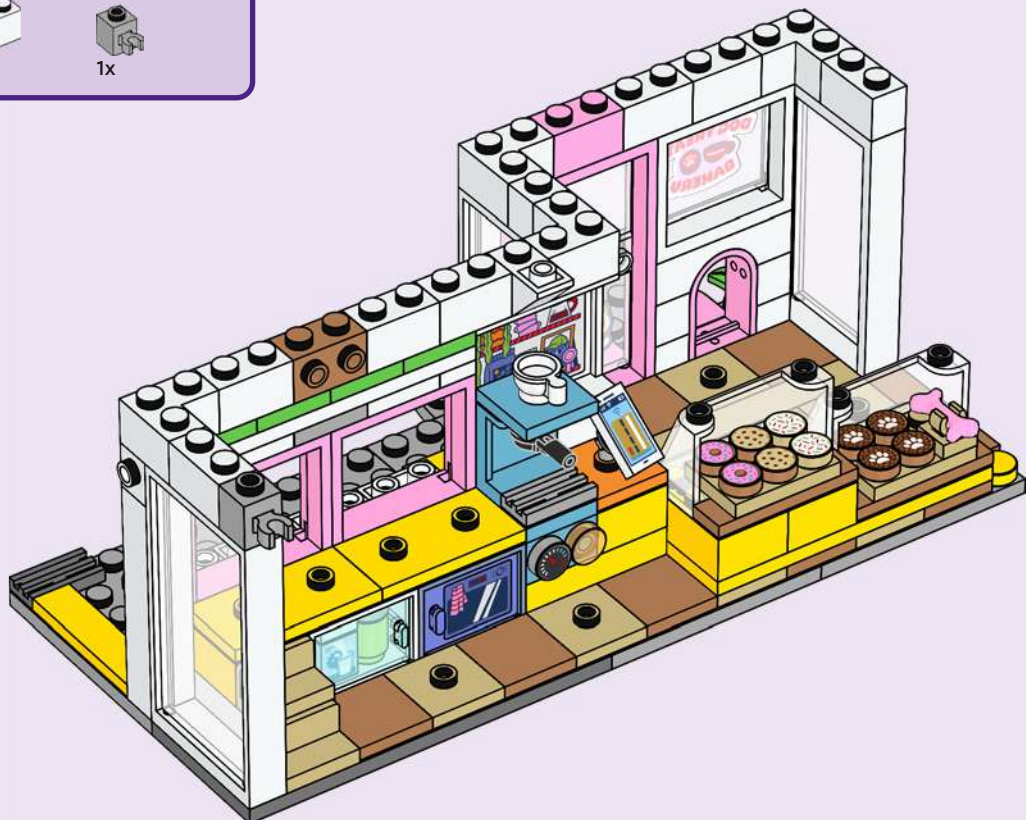



1x

66





1x

67

1

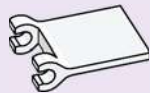

2



3

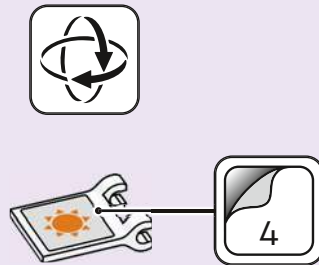

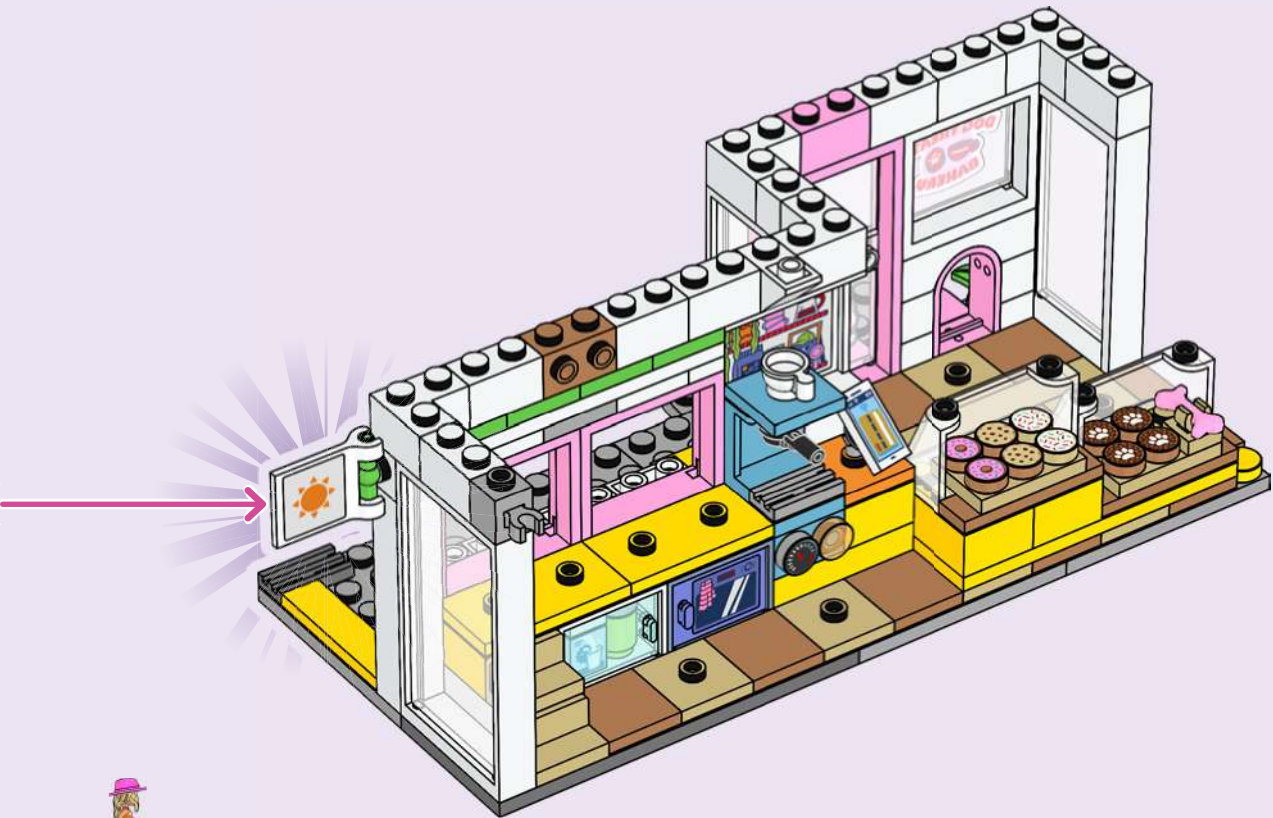



1x

68

1



2

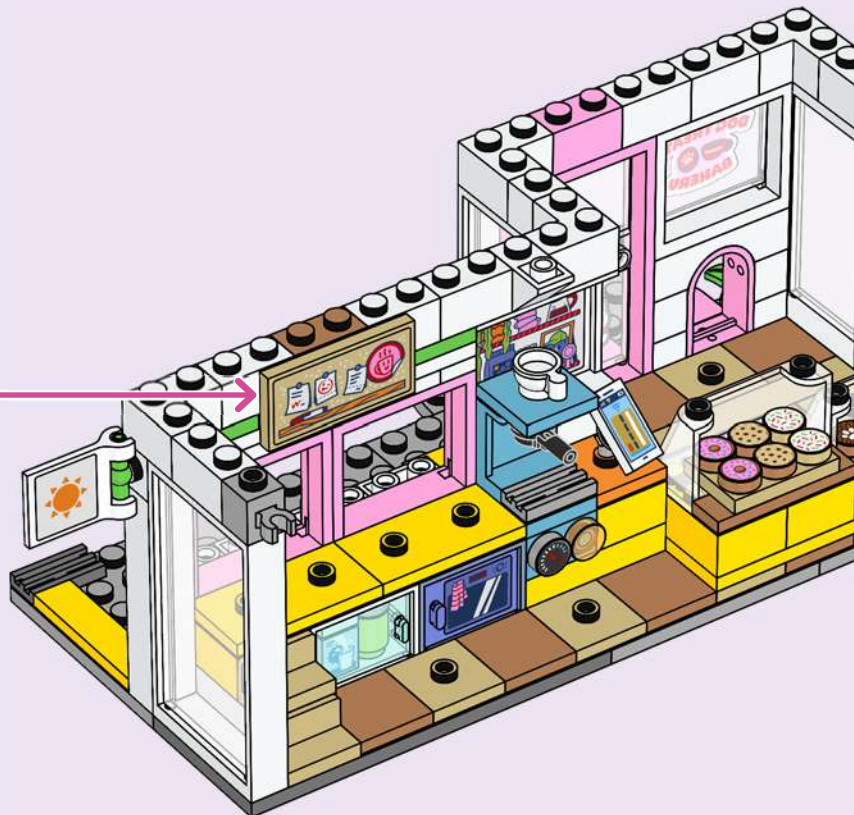



1x

69

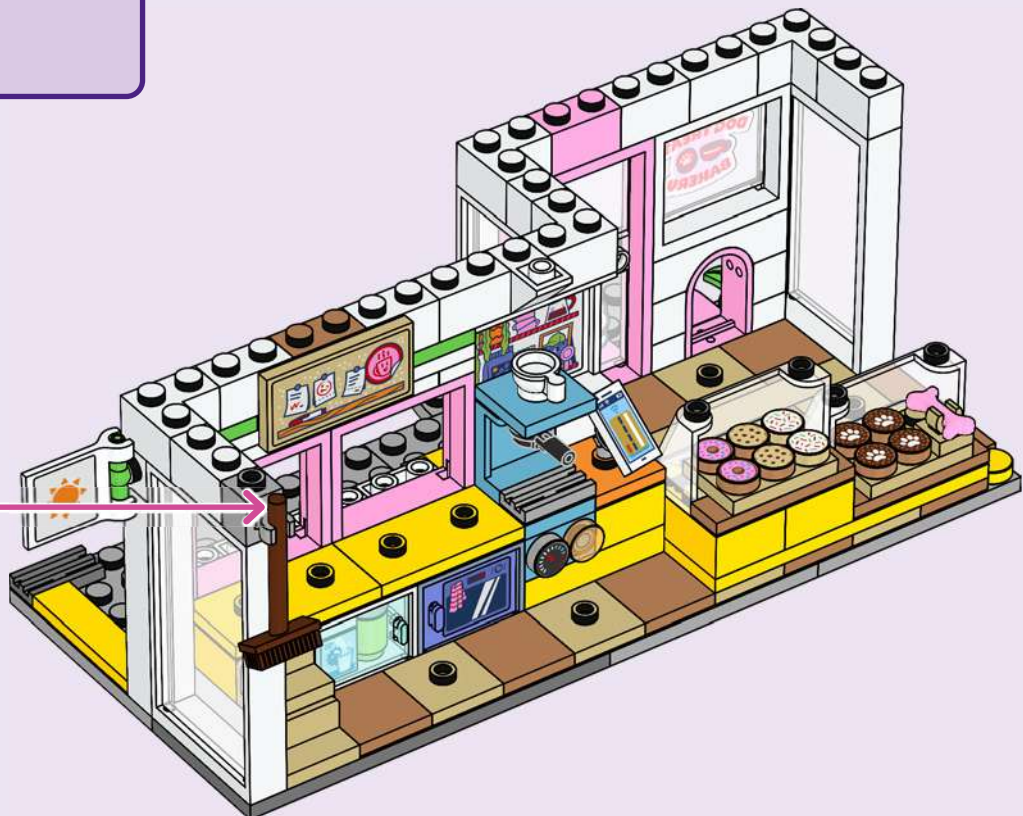



1x



2x

70

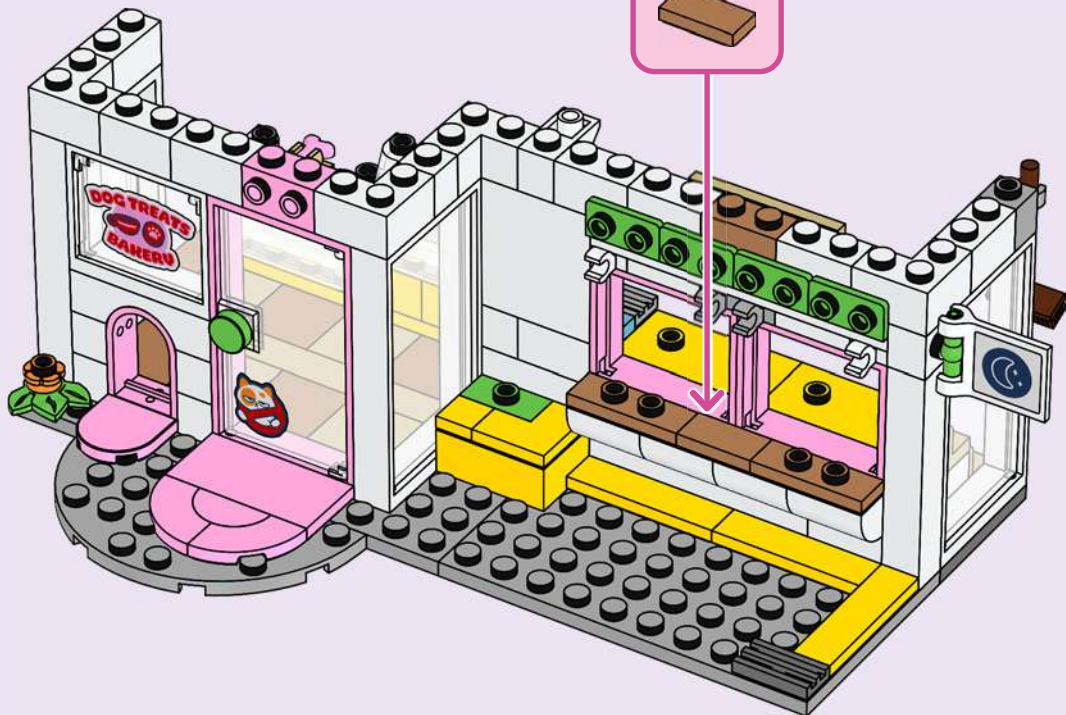



2x

71

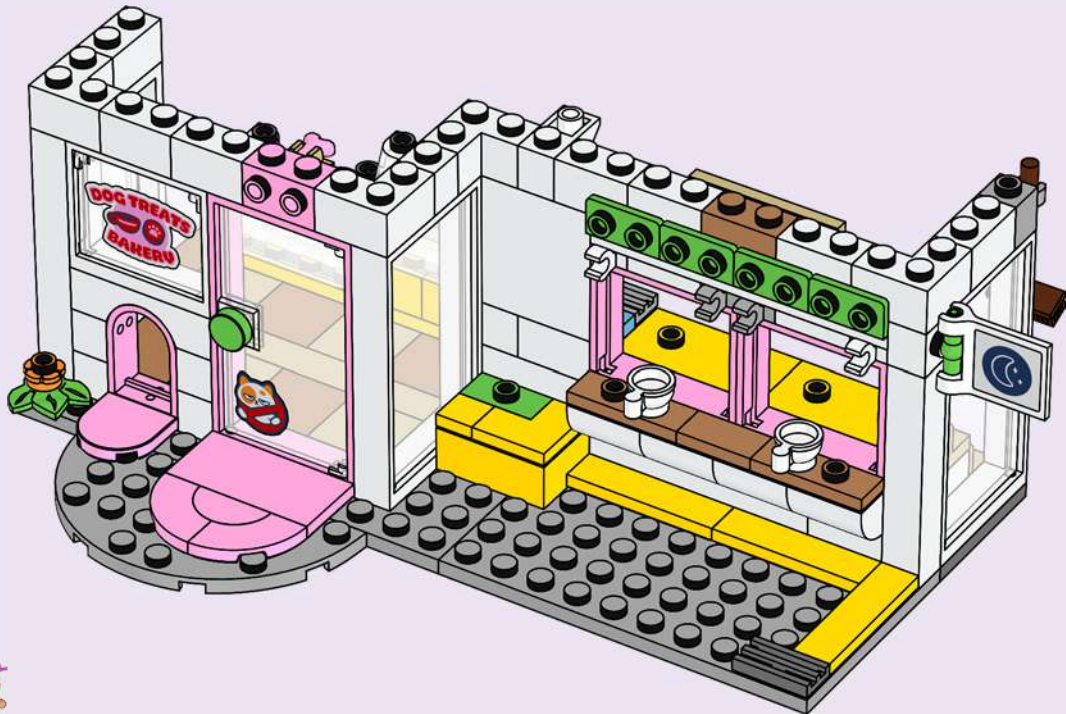

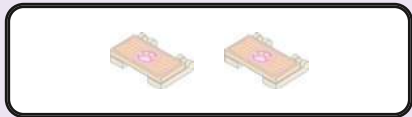

72

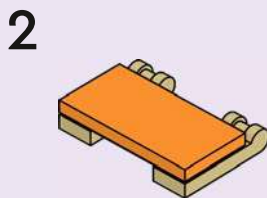
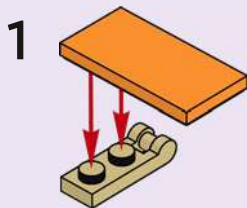

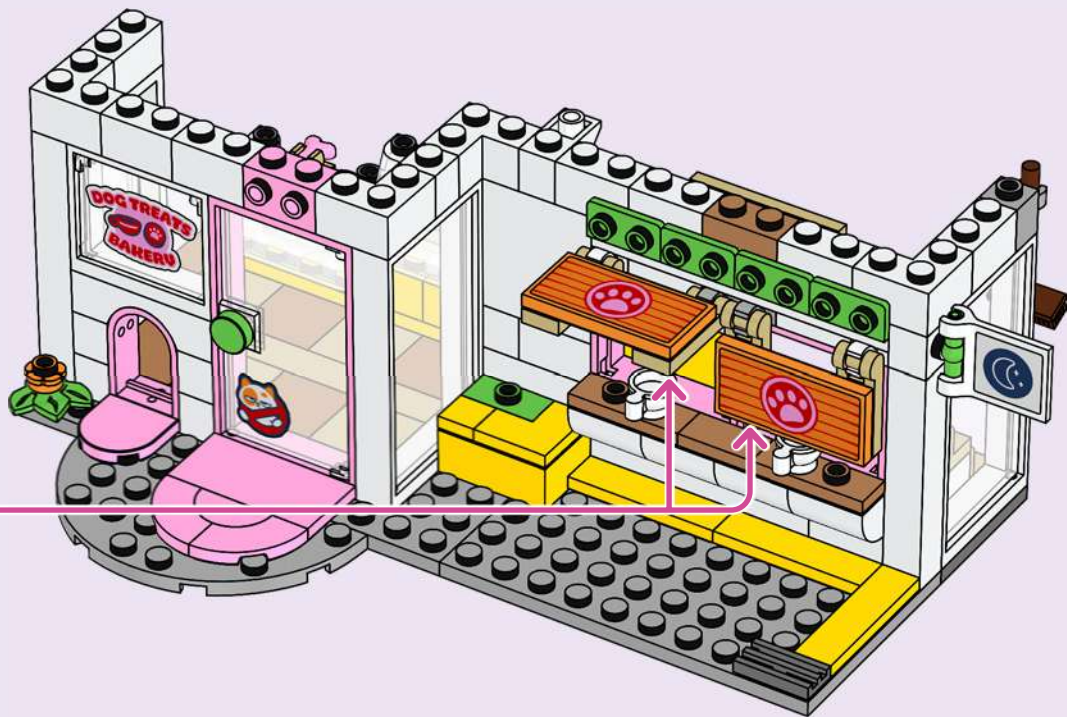



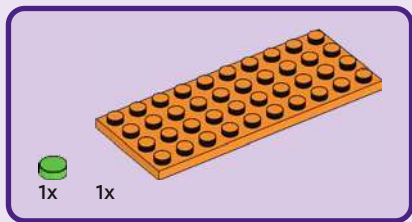

73

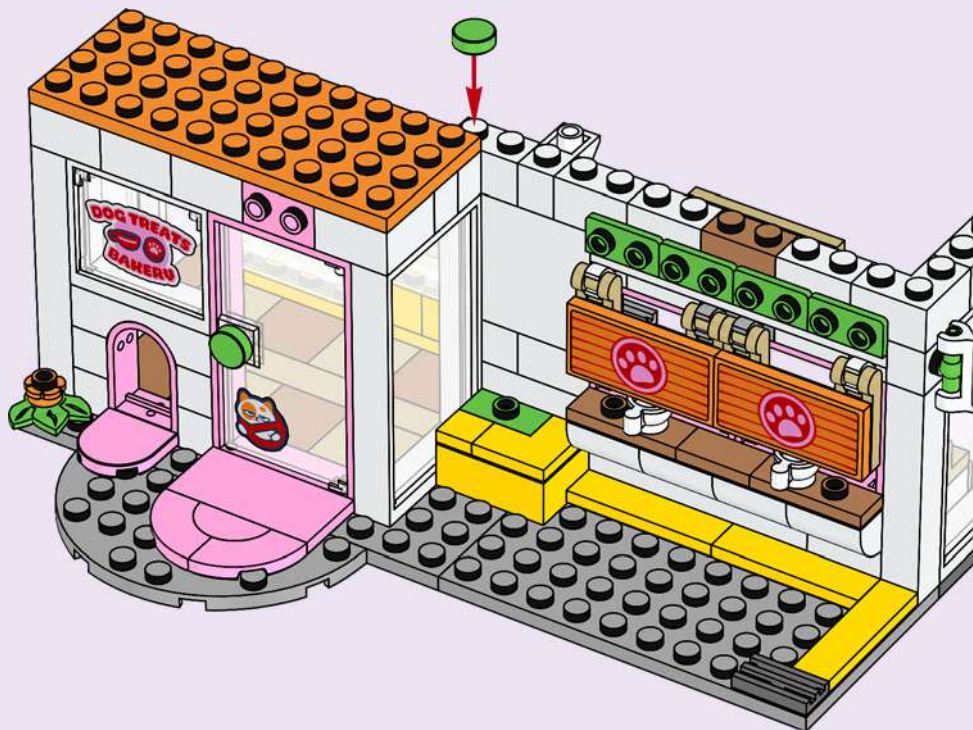

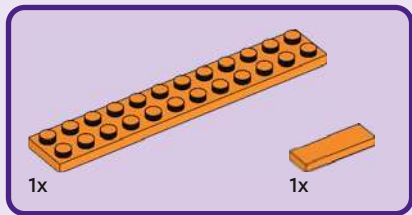

74





1x

75

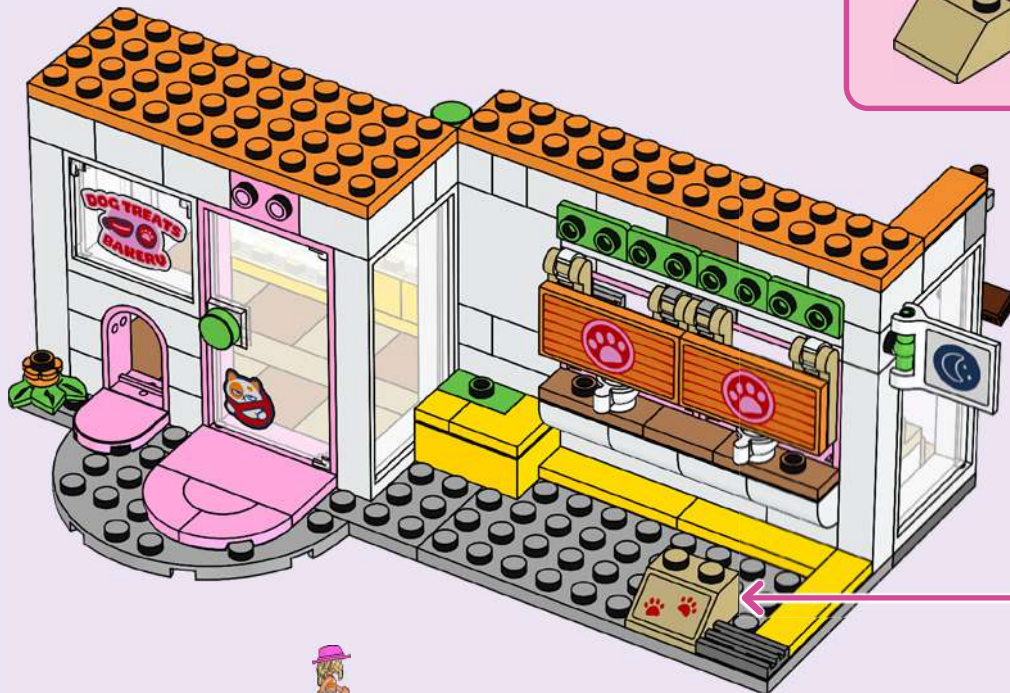

1

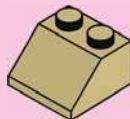

2





1x

76

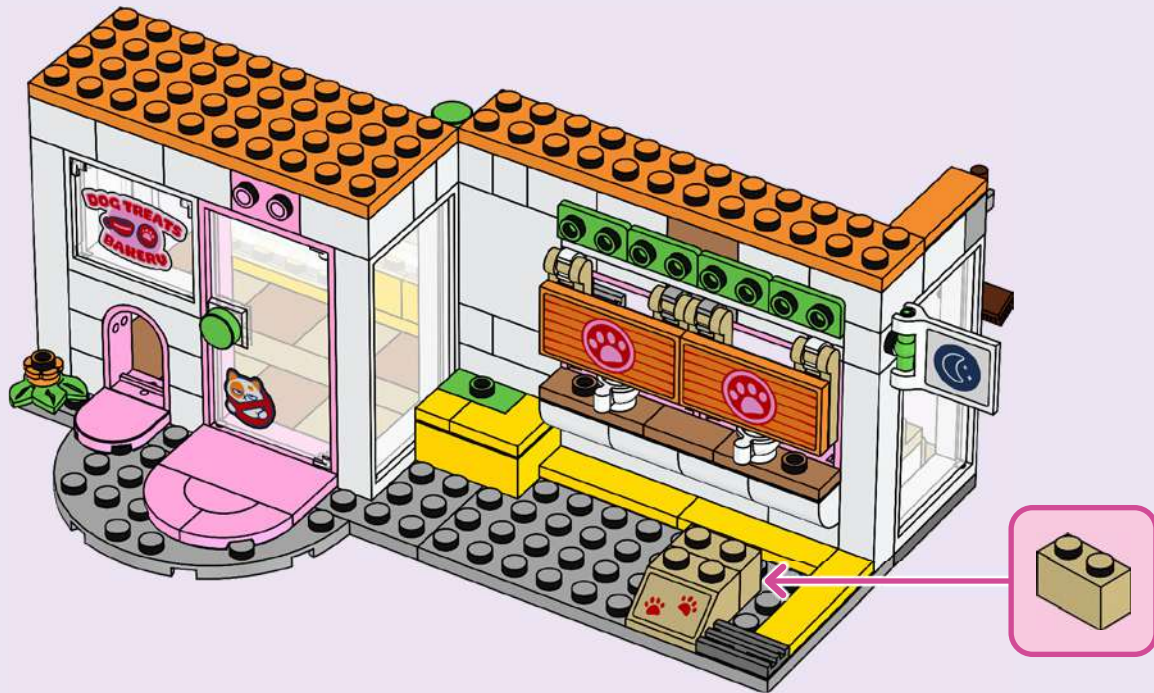



2x

77

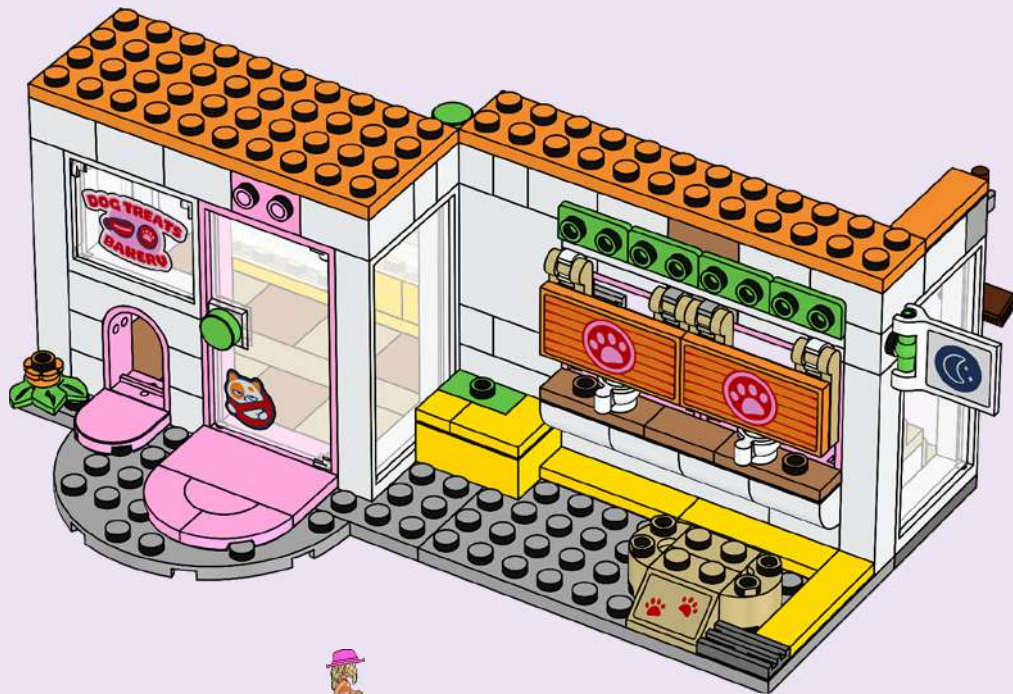



1x

78

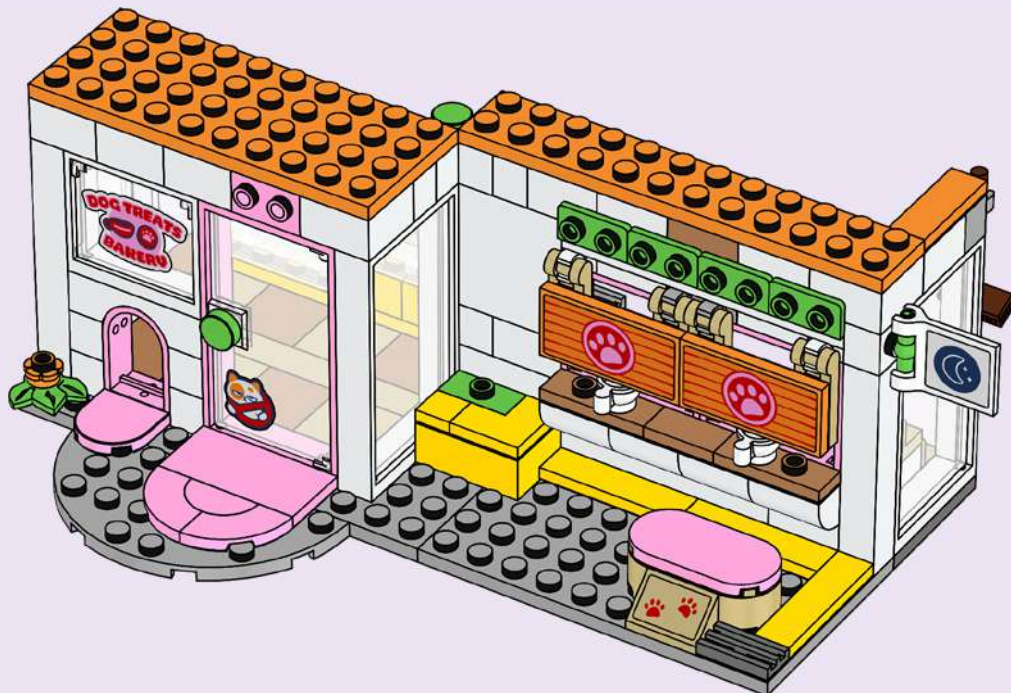



1x



1x

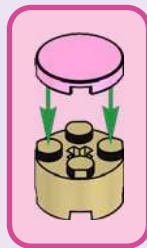

79





80

1

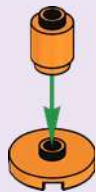

2



3



4







1x

81



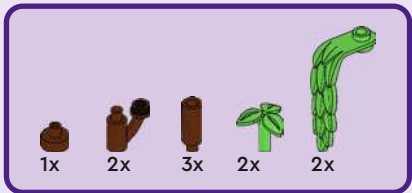
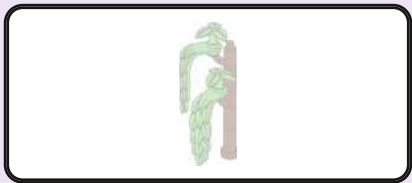

82

1



2



3



4



5



6



7

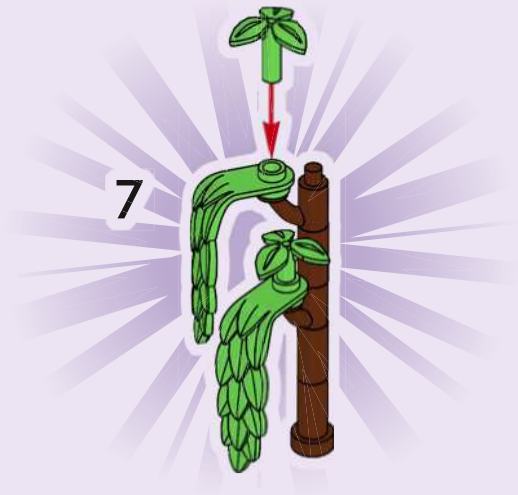





1x



1x

83



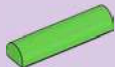

3x

84



3x

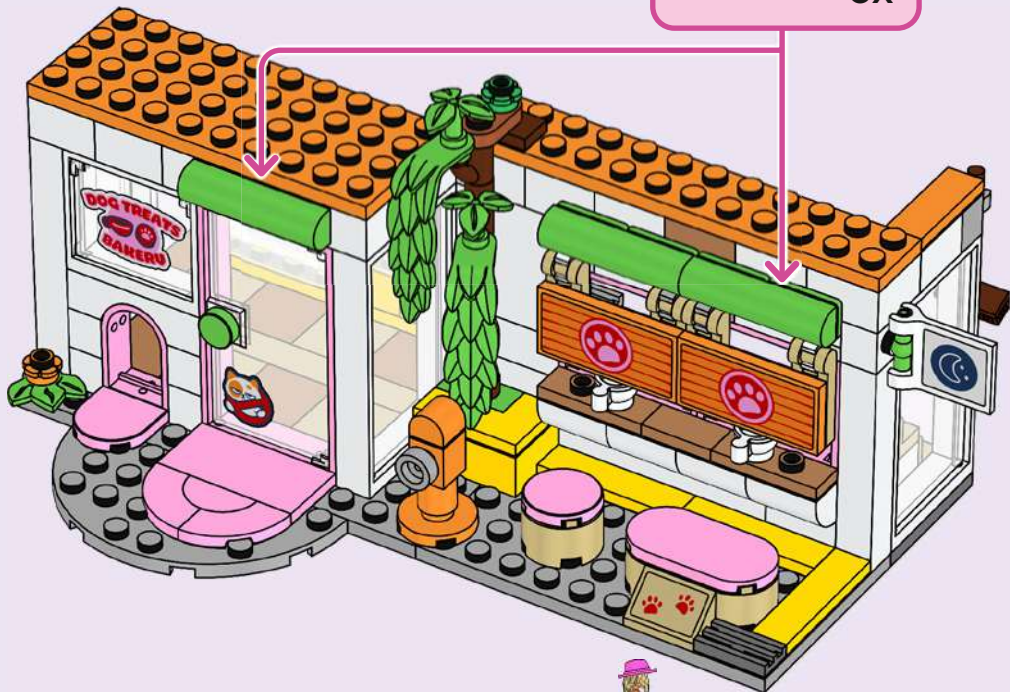



2x

85





4x

86





2x

87





4x

88



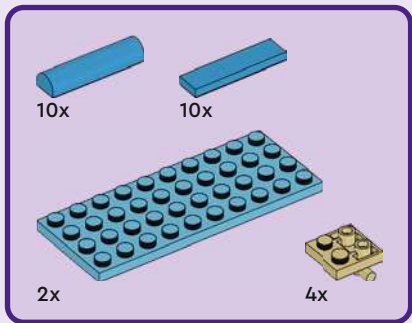
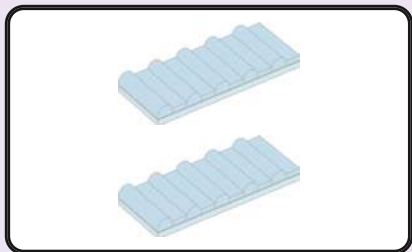

89

1

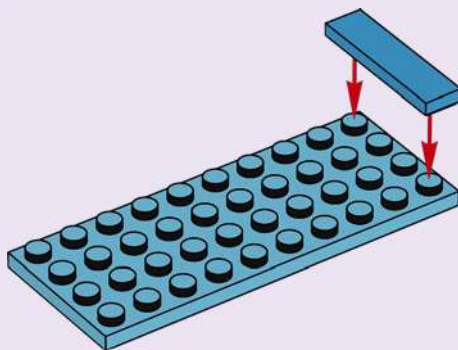

2

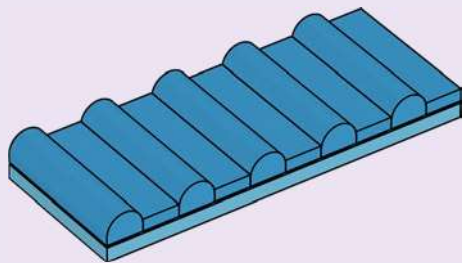

3

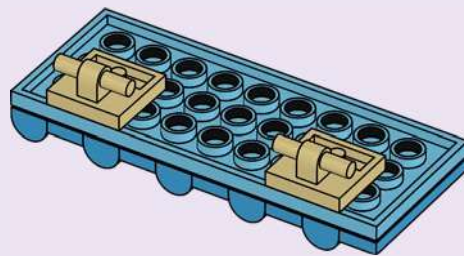

2x



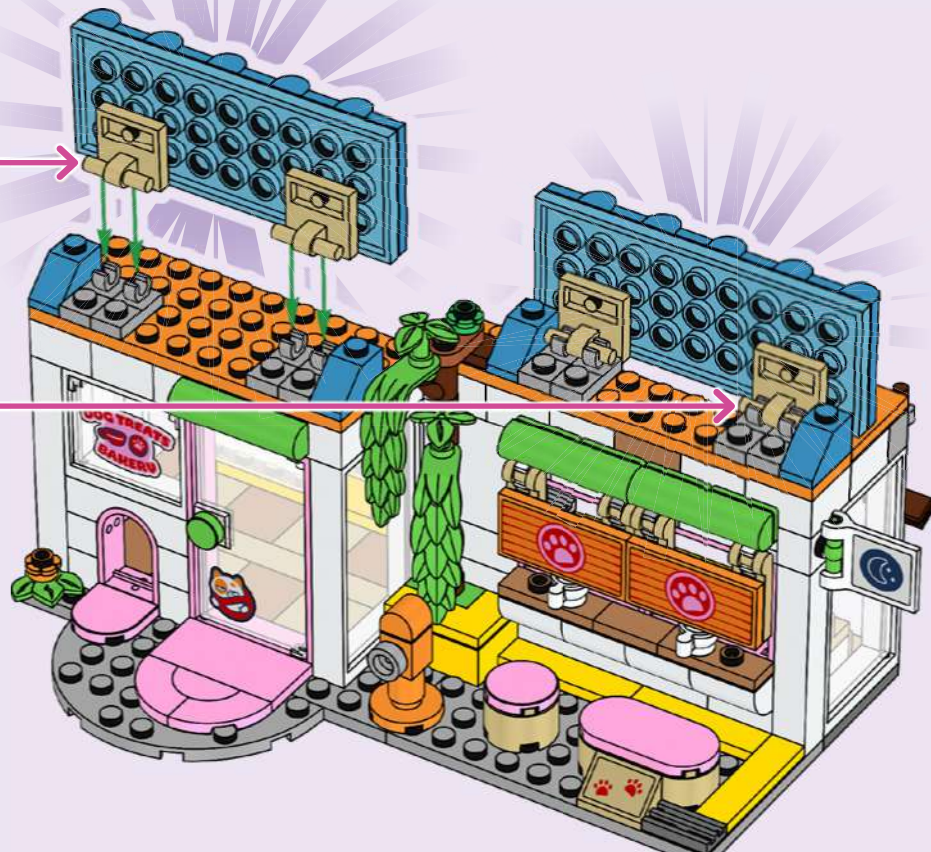

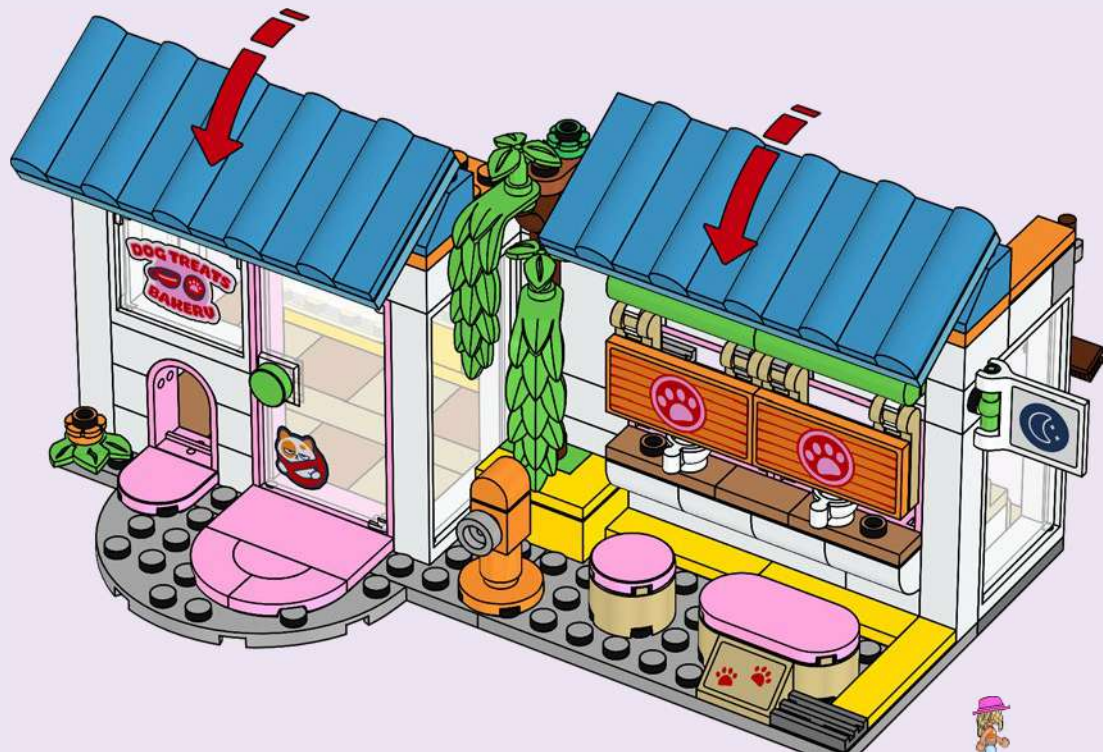

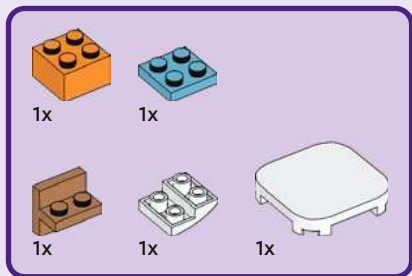

91

1

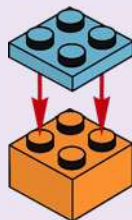

2

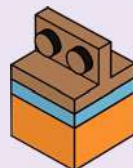



3



4

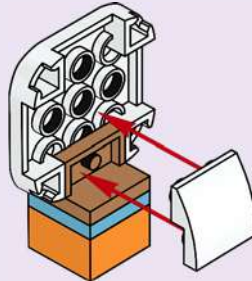







# Friends

Watch  
series  
online



Watch series online / Schau dir die Serie online an / Regarde la série en ligne / Guarda la serie online / Mira la serie en Internet / Assistir à série online / 在线观看 / Oglădaj serial w internecie / Sleduj serial online / Pozri si serial online / Nézd a sorozatot online / Дивіться серіал онлайн / Vizionează serialul online / Глядайте серіала онлайн / Skaties seriālu tiešsaistē / Vaata sarja veebist / Žiūrėk serialą internetu



**LEGO**

**Friends**

42687

42684



42652

42695

42688

**LEGO**

**Friends**



42684



42689



























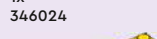

































42699



42685



42695

 3x 6235083	 1x 366501	 1x 6517953	 1x 4530590	 1x 6360078	 8x 4565387	 1x 307024	 1x 346024	 1x 6182261
 1x 307001	 9x 300401	 1x 6365487	 1x 4530590	 2x 6092587	 1x 6594880	 1x 300424	 2x 6334178	 2x 6334178
 1x 4558952	 1x 6542281	 1x 6156667	 3x 6262945	 2x 6351413	 1x 4114322	 1x 6308099	 1x 303424	 2x 6235080
 5x 300501	 4x 6556066	 1x 4619665	 1x 6531022	 2x 6146221	 2x 4118790	 1x 300324	 1x 6196548	 2x 6235080
 1x 245301	 1x 6210385	 1x 365901	 1x 6531022	 1x 4125220	 1x 6122047	 3x 300224	 1x 6581531	 2x 6586531
 1x 6581552	 4x 235701	 3x 300101	 1x 300901	 1x 4109995	 2x 4544139	 3x 243124	 2x 6353793	 3x 6554604
 2x 6347293	 1x 6594888	 3x 300101	 1x 346001	 4x 6174925	 4x 6481602	 2x 6424448	 1x 6527026	 1x 6416470
 2x 302301	 1x 6589140	 1x 4558208	 2x 6361753	 4x 6211975	 1x 6284577	 1x 301024	 3x 6314378	 1x 6369194



3x  
6581671



1x  
6514142



1x  
6514119



2x  
6581801



1x  
6514073



1x  
6278436



1x  
6220715



1x  
6214234



1x  
6431334



1x  
6474196



1x  
6109909



1x  
6061676



1x  
6126063



1x  
4620693



1x  
4153825



4x  
4648853



1x  
6382505



1x  
6313826



2x  
6509777



1x  
4212454



1x  
6404592



1x  
6363600



1x  
6514197



3x  
6422088



1x  
6186673



2x  
6433717



1x  
6092590



1x  
4211157



1x  
6329581



1x  
6510189



1x  
6258831



1x  
4211350



1x  
6345426



8x  
6326078



2x  
6152344



1x  
6337268



1x  
4211397



1x  
6273227



1x  
4211395



1x  
6353796



3x  
4211405



1x  
4210631



1x  
4211122



1x  
6575292



1x  
6575290



1x  
6587197



1x  
6595602



1x  
6542399



1x  
6092768



1x  
6353192



1x  
6590633



2x  
6331809



1x  
6552654



1x  
6585449



1x  
6106713



2x  
6590635



1x  
6590634



1x  
6409768



3x  
6329593



5x  
6287856



2x  
6287854



1x  
6021997



1x  
6411587



2x  
6292145



10x  
6102990



1x  
6313599



3x  
6102998



1x  
6322904



4x  
6036851



10x  
6592837



10x  
6205089



1x  
6348142



1x  
6369854



1x  
6126090



2x  
4625032

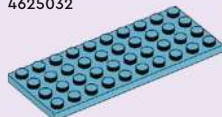

2x  
6423262



1x  
6416663



1x  
6581584



1x  
6585067



 [LEGO.com/service](https://www.LEGO.com/service)

YOU COULD **WIN**



Scan this QR code or go to **LEGO.COM/PRODUCTFEEDBACK** and give us your short feedback about this LEGO® set for a chance to win a cool LEGO prize.

Terms and Conditions apply\*

**EN: YOU COULD WIN.** Terms and Conditions apply\* **DE: Du könntest GEWINNEN.** Es gelten die Teilnahmebedingungen\* **FR: Tu pourrais GAGNER.** Des conditions s'appliquent\* **IT: Potresti VINCERE tu.** Termini e condizioni sono applicabili\* **ES: Puedes GANAR.** Aplican términos y condiciones\* **PT: PODERÁ GANHAR.** Aplicam-se Termos e Condições\* **ZH: 轻松获奖.** 条款和条件适用\* **PL: Szansa na WYGRANĄ.** Obowiązuje regulamin\* **CS: Máte šanci VYHRÁT.** Platí všeobecné smluvní podmínky\* **SK: Máte šancu VYHRAŤ.** Platia všeobecné zmluvné podmienky\* **HU: TE IS NYERHETSZ.** Felhasználási feltételek érvényesek\* **UA: ВИ МОЖЕТЕ ВИГРАТИ.** Застосовуються загальні положення та умови\* **RO: Ai putea CÂȘTIGA.** Se aplică termeni și condiții\* **BG: Можете да СПЕЧЕЛИТЕ.** Има определени правила и условия\* **LV: Tu vari LAIMĒT.** Ir spēkā noteikumi un nosacījumi.\* **ET: Sul on võimalus VÕITA.** Kehtivad tingimused\* **LT: Jūs galite LAIMĖTI.** Taikomos sąlygos\*

\*[LEGO.com/productfeedback-terms](https://www.lego.com/productfeedback-terms)

