



**MARVEL**

76334







LEGO® Builder



[LEGO.com/sustainable-packaging](https://LEGO.com/sustainable-packaging)



 **FR**  
**DONNEZ**  
OU  
**RECYCLEZ**

 OU  OU 

ASSOCIATION    MAGASIN    DÉCHÈTERIE

Adresses sur [quefairedemesdechets.fr](https://quefairedemesdechets.fr)

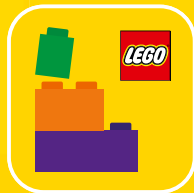

LEGO® Builder

# BUILDER



Apple and the Apple logo are trademarks of Apple Inc., registered in the U.S. and other countries and regions. App Store is a service mark of Apple Inc. Google Play and the Google Play logo are trademarks of Google LLC. Tencent and the Tencent logo are trademarks of Tencent Inc.

[LEGO.com/devicecheck](https://LEGO.com/devicecheck)

**EN** Ask parents' permission before going online | **DE** Eltern um Erlaubnis bitten, bevor du online gehst | **FR** Demande l'autorisation d'un parent avant d'aller en ligne | **IT** Chiedi il permesso ai tuoi genitori prima di andare online | **ES** Pídeles permiso a tus papás antes de conectarte a Internet | **PT** Pede autorização aos pais antes de acederes online | **ZH** 上网前应先征得父母的同意 | **PL** Poproś rodziców o zgodę, zanim wejdiesz do Internetu | **CS** Než půjdeš na internet, požádej rodiče o svolení | **SK** Skôr než pôjdeš na internet, vypýtaj si povolenie od rodičov | **HU** Kérj szülői engedélyt, mielőtt online csatlakoznál! | **UA** Запитуйте дозволу батьків, перш ніж користуватися інтернетом | **RO** Cere permisiunea părinților înainte de a te conecta online | **BG** Поискайте разрешение от родител, преди да влезете онлайн | **LV** Pirms došanās tiešsaistē palūdz atļauju vecākiem | **ET** Enne Interneti kasutamist küsi vanematelt luba | **LT** Prieš prisijungdami prie interneto, atsi klauskite tėvų

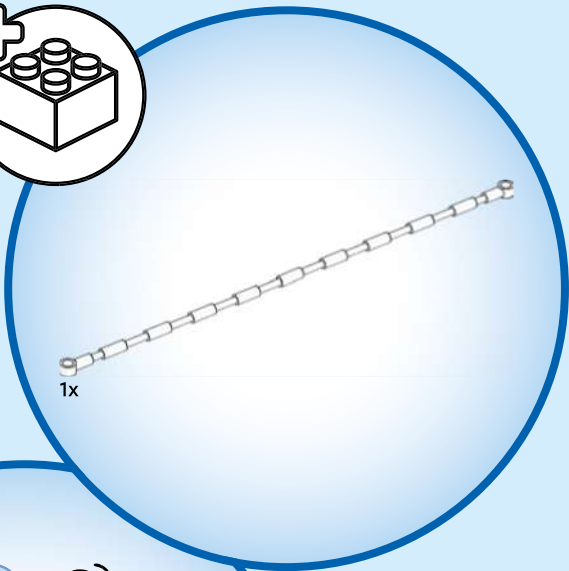
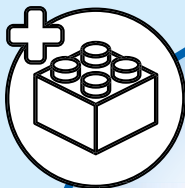

1x



1

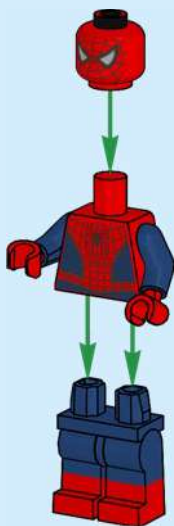

2

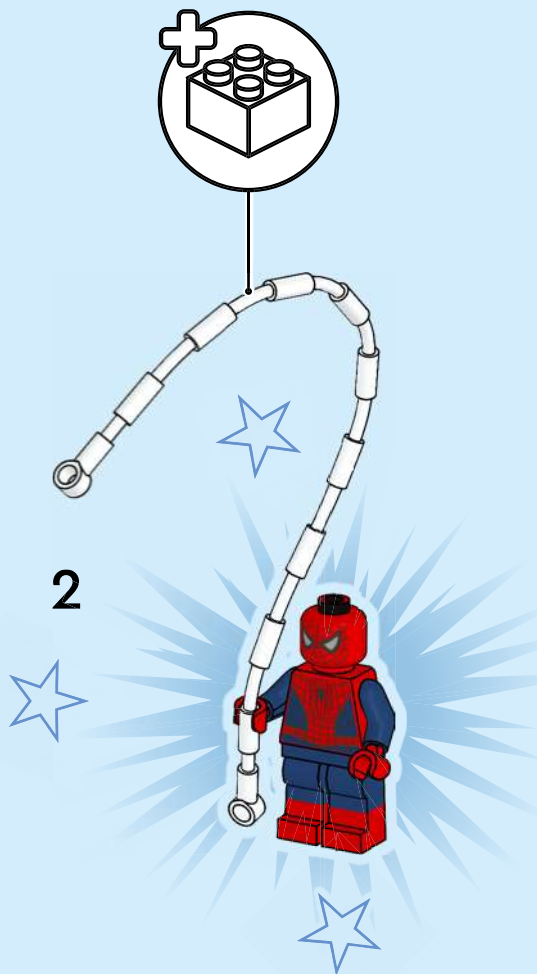



1

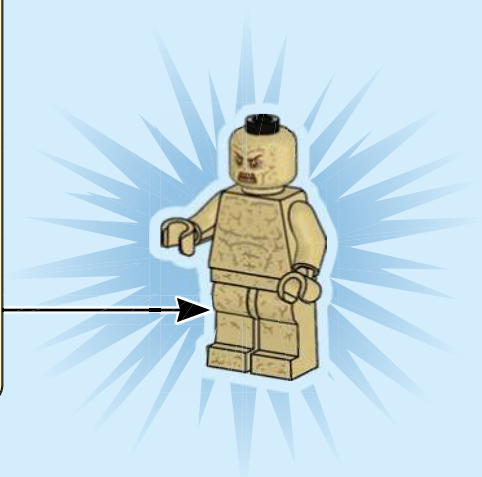
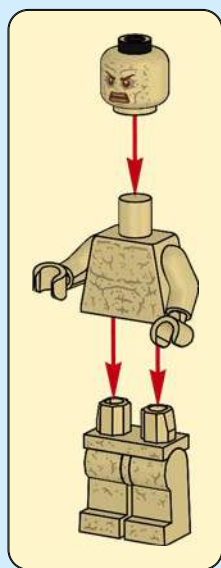



2

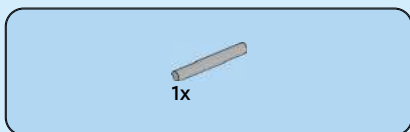
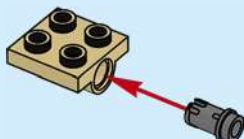

3





1x

4

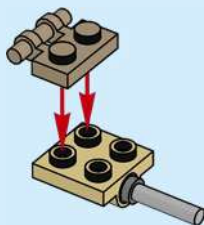

1x

5





1x

6



1x

7

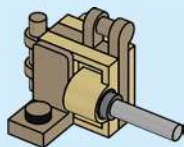



4x

8

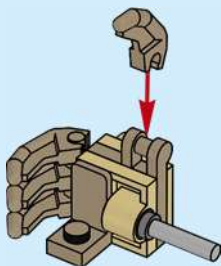



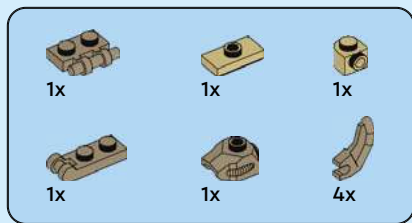

11

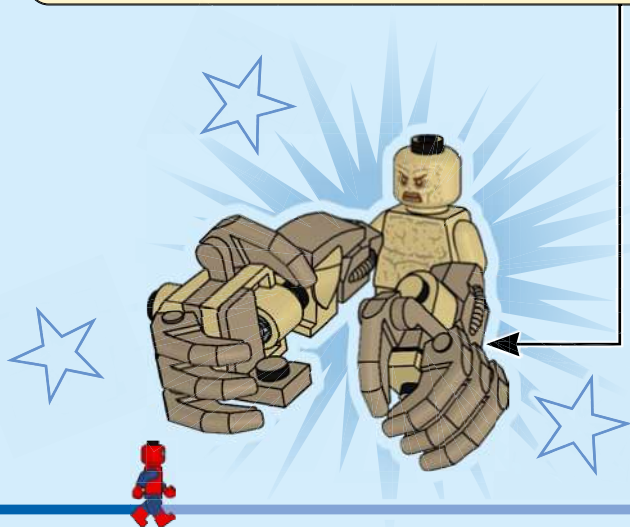
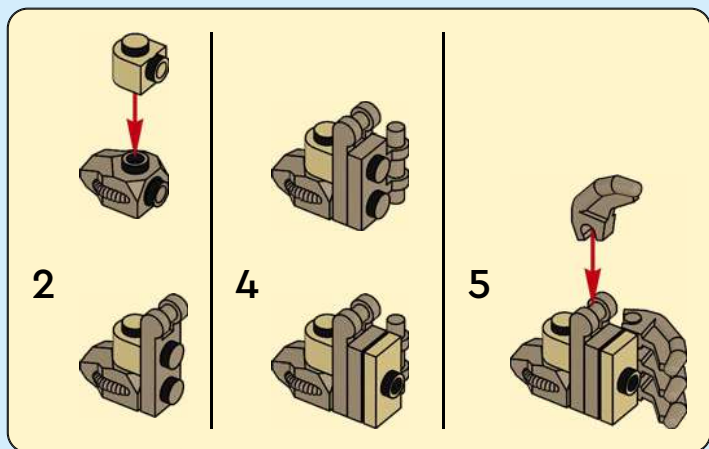

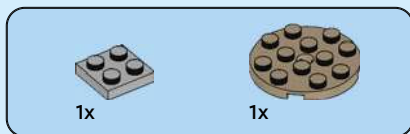

1

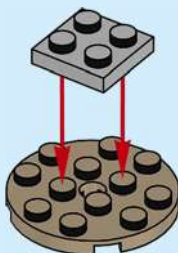

2



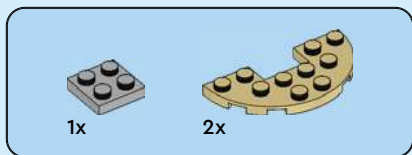

3

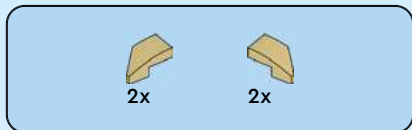
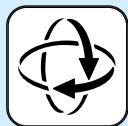

4

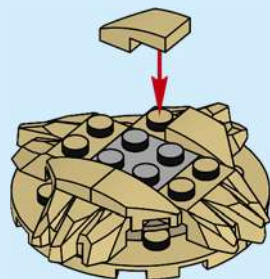
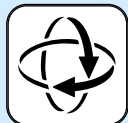



1x

5

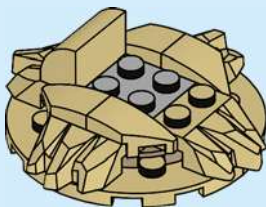

2x

6

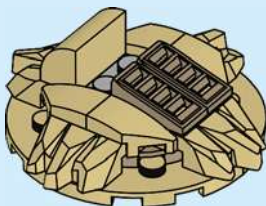



1x



1x

7

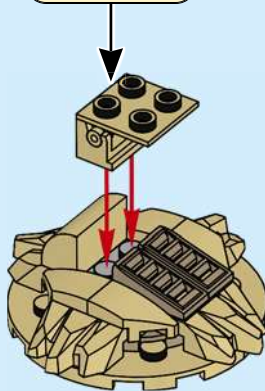
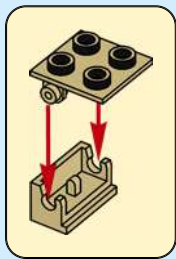

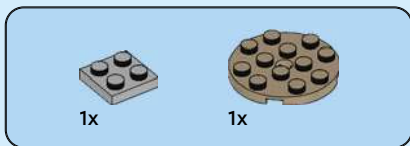

8

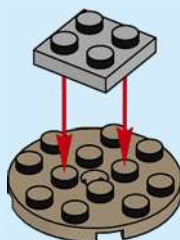

9

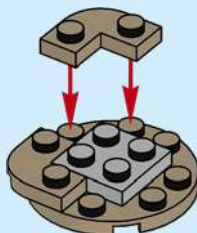

2x



2x

# 10

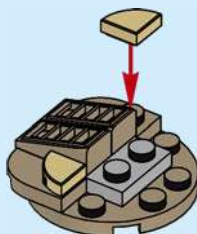

1x



1x

# 11

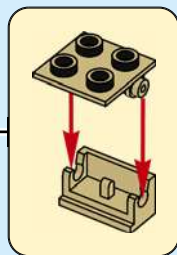



1x

12



13

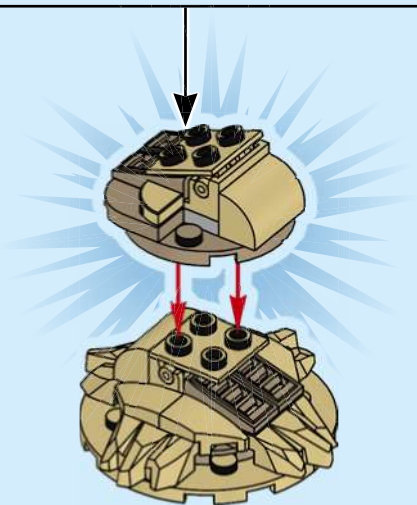



2x

14



2x

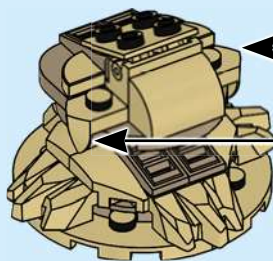

1x



1x

15

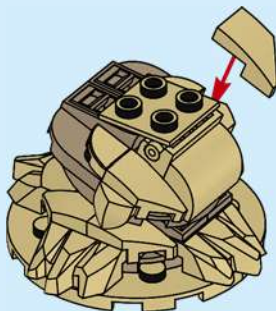



1x



1x

# 16



4x

# 17





2x

18

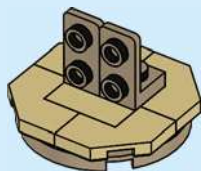

2x

19

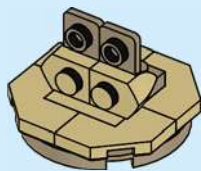



1x

20



21

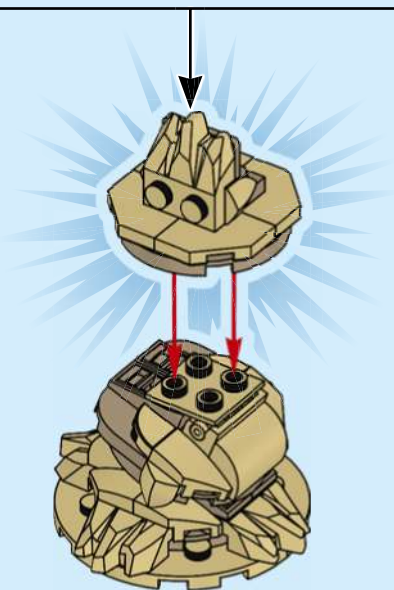





1

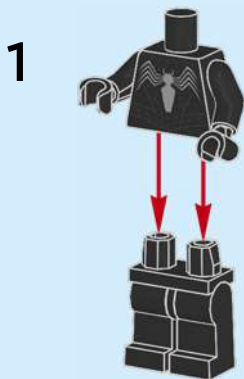

2





2

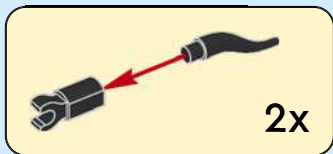
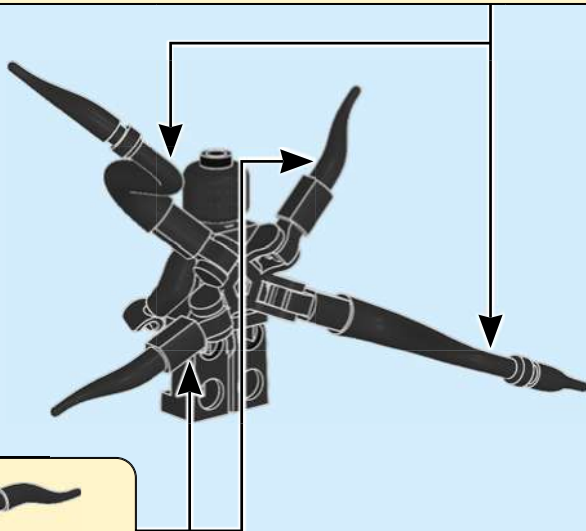
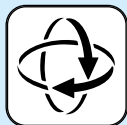
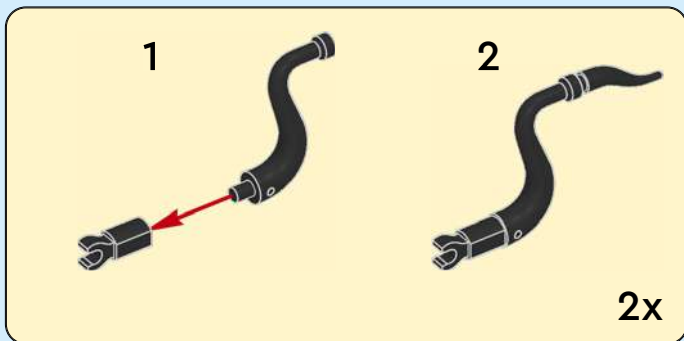

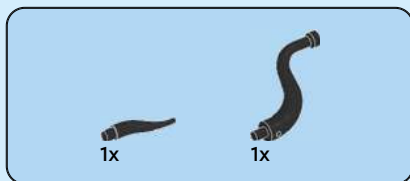

3

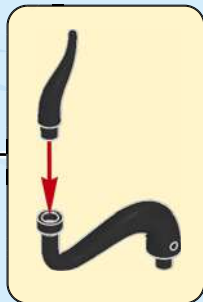
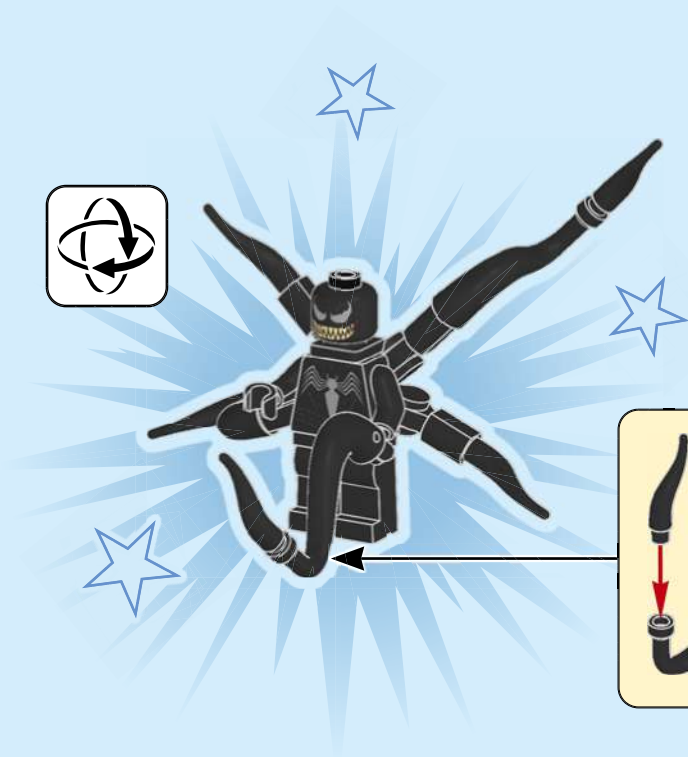



1

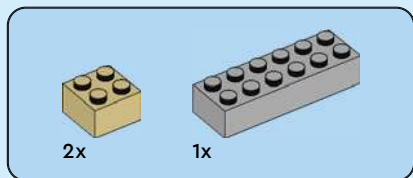

2

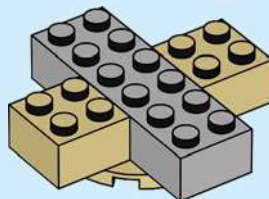



4x

3

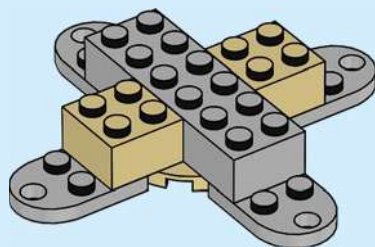

2x

4

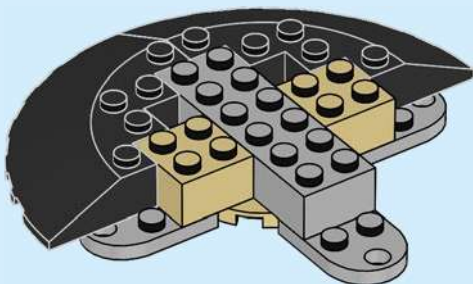

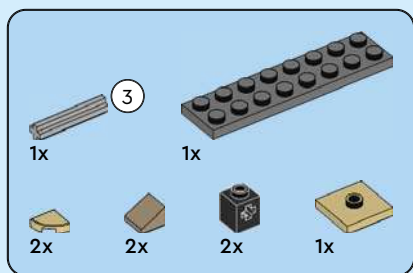

5

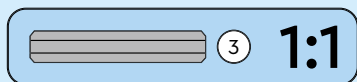
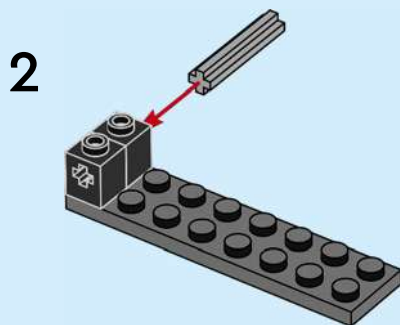
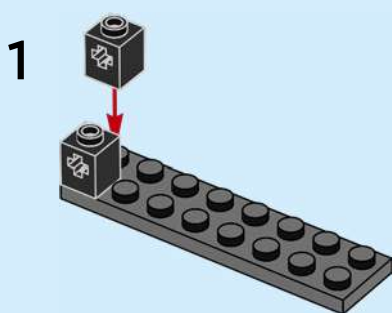

3

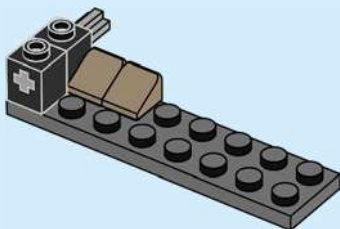

4

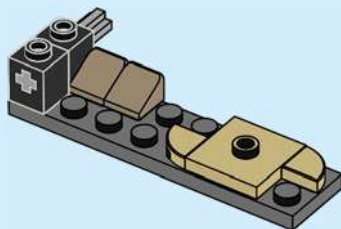

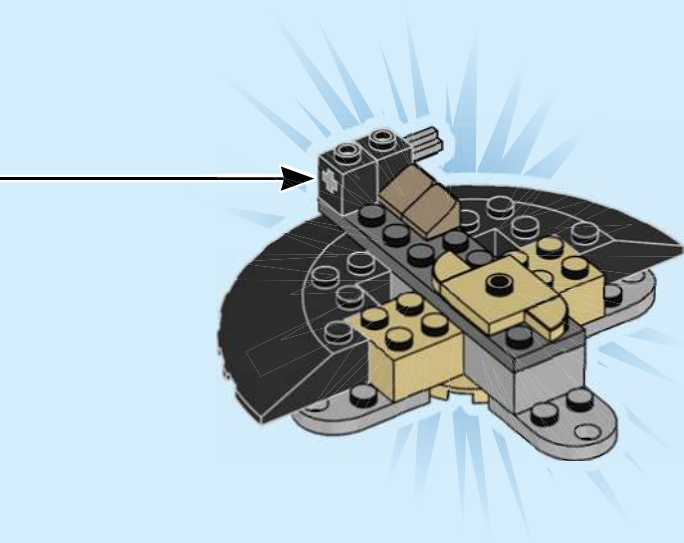

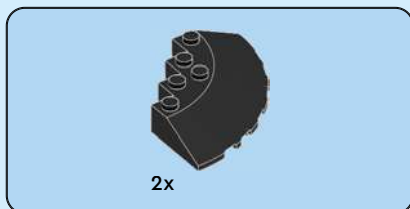

6

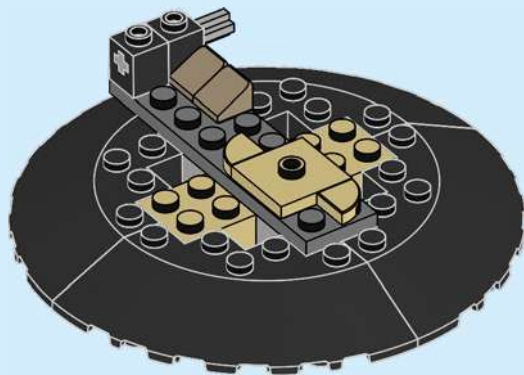



2x

7

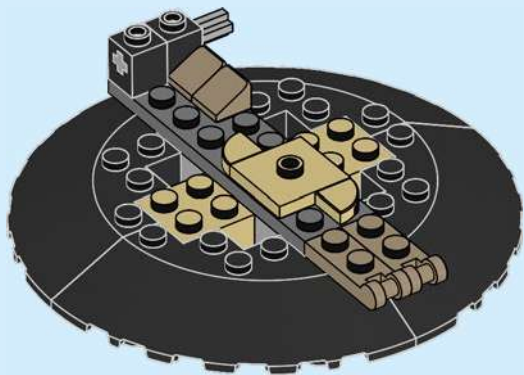



2x

8

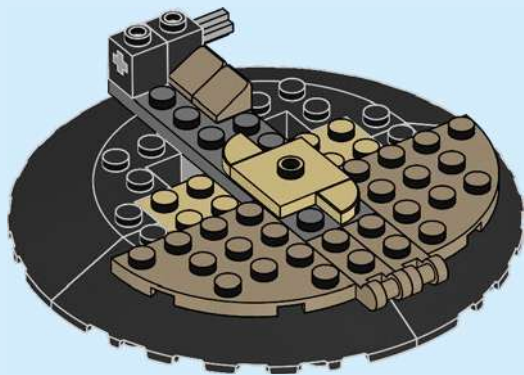

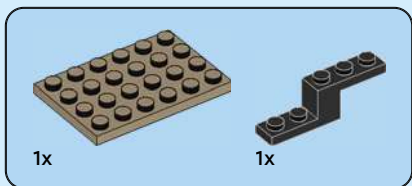

9

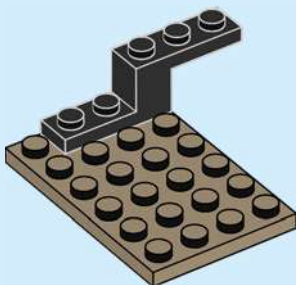

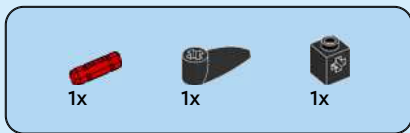

# 10

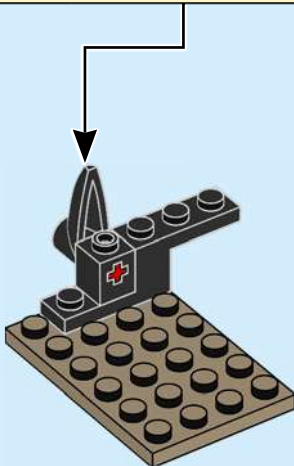
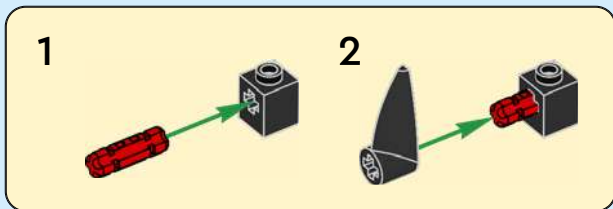



1x

# 11



1x



1x

# 12







1x



1x

# 15

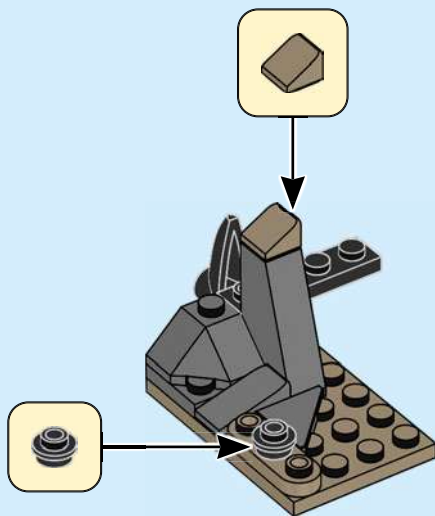

16

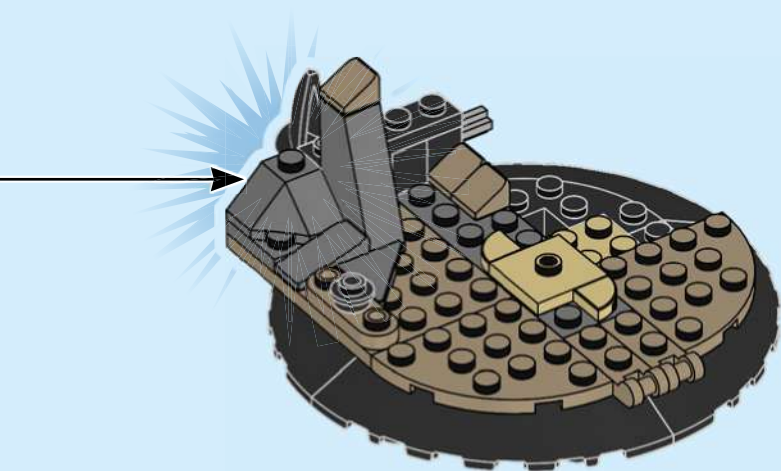

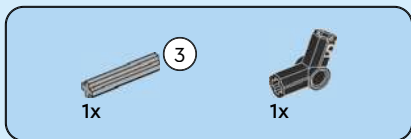

17

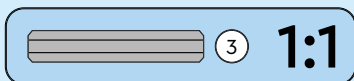
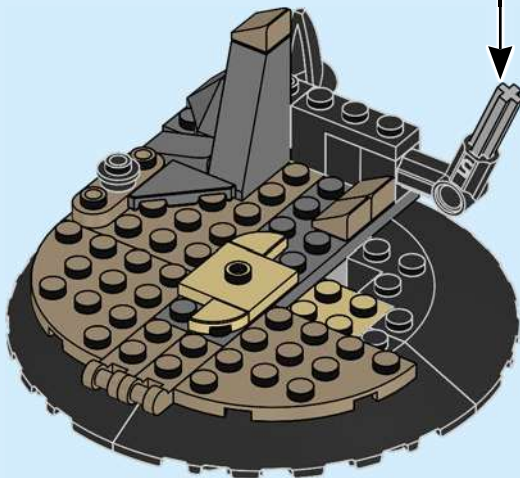
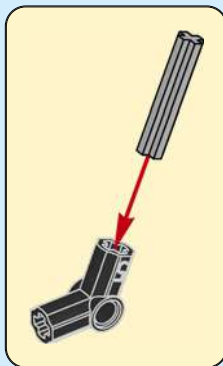

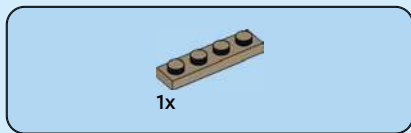

18

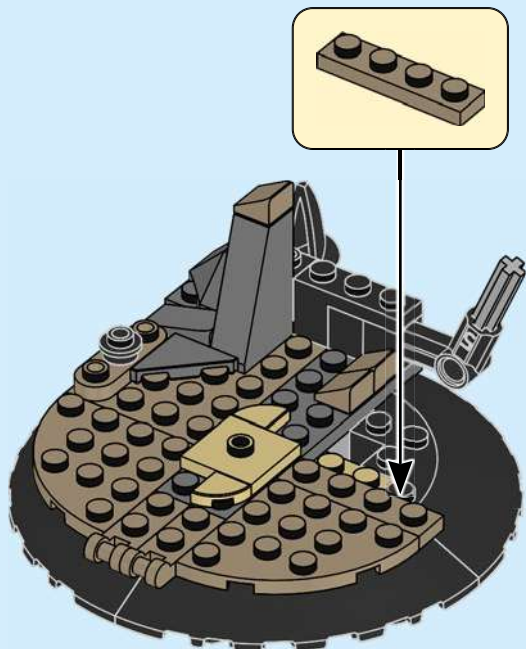

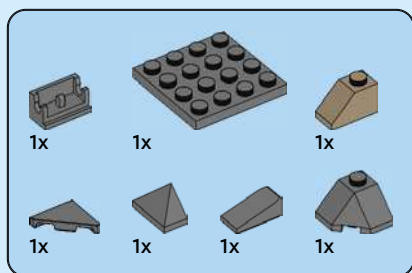

19

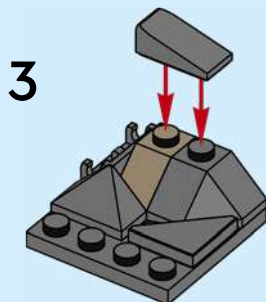
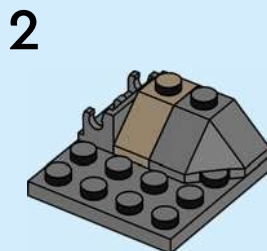
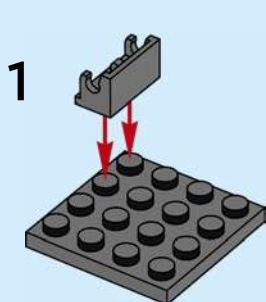

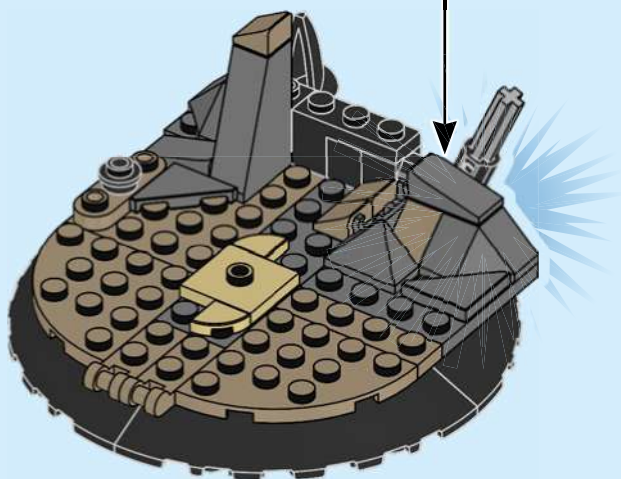

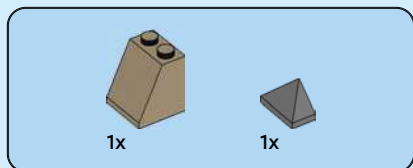

20

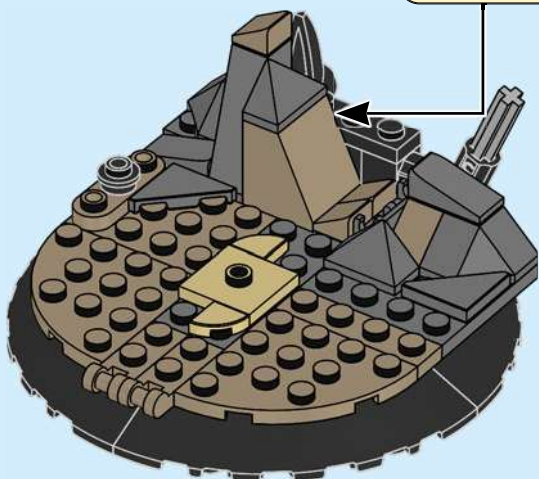
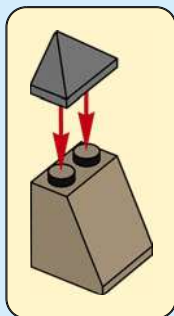



1x

21

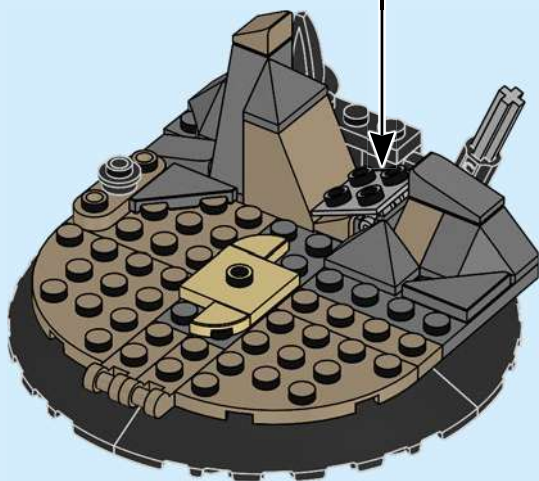

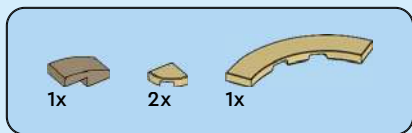

22

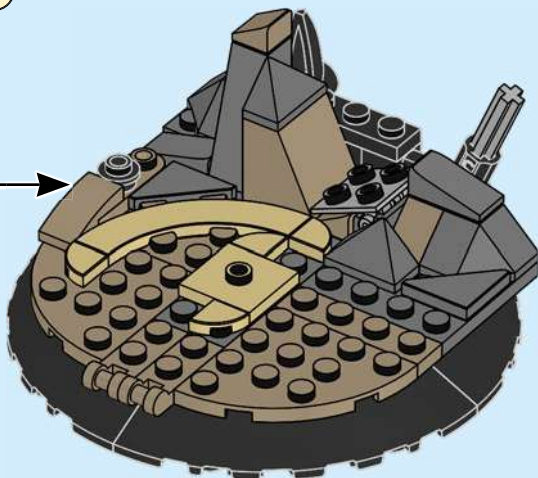



1x



1x



1x

# 23

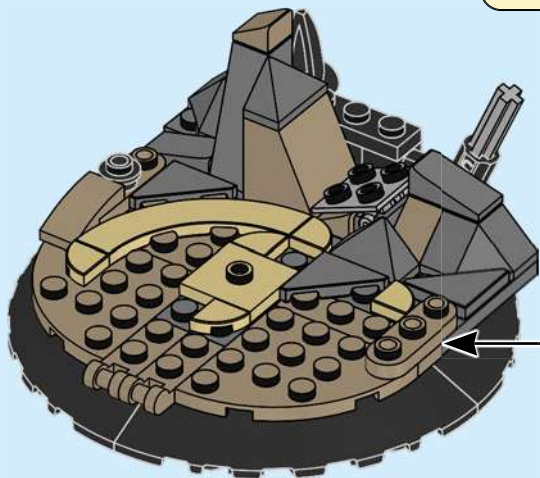

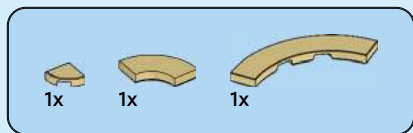

24

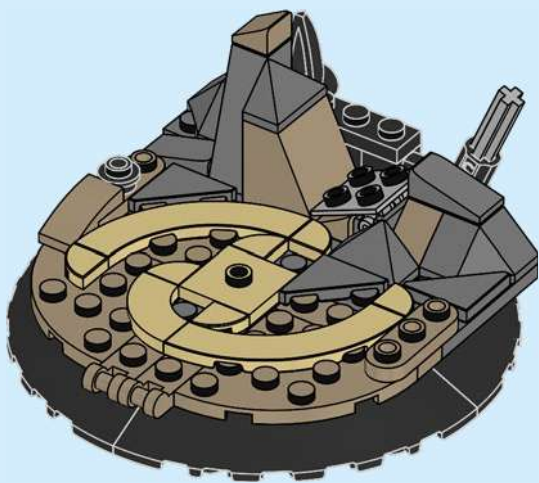



3x

25

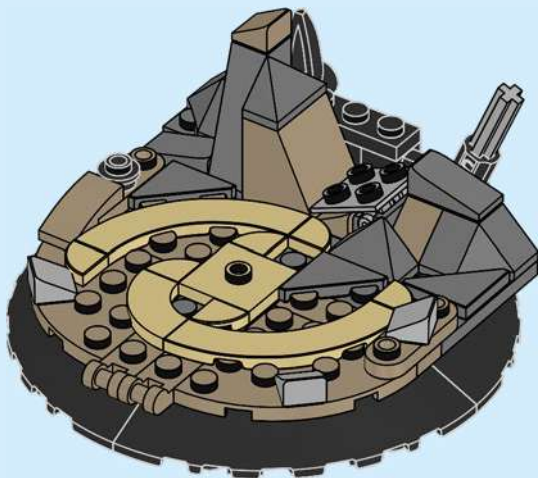

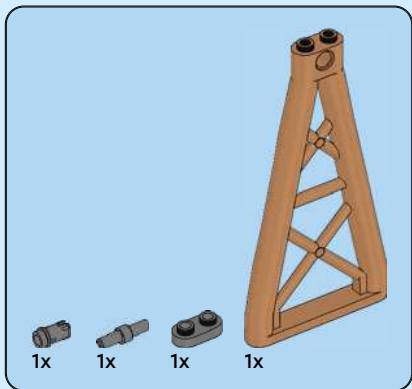

26

1

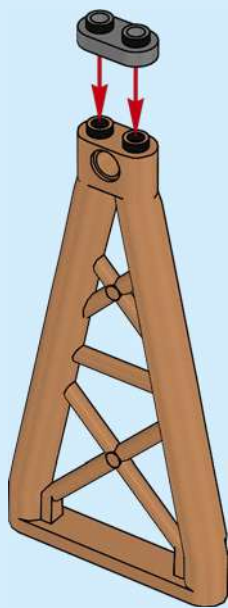

2

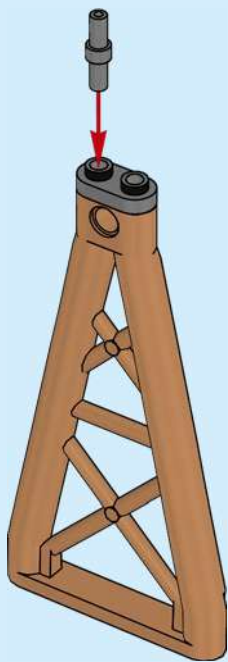

3

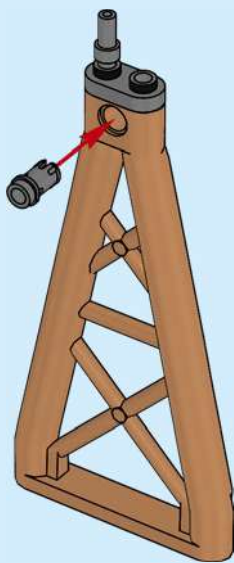

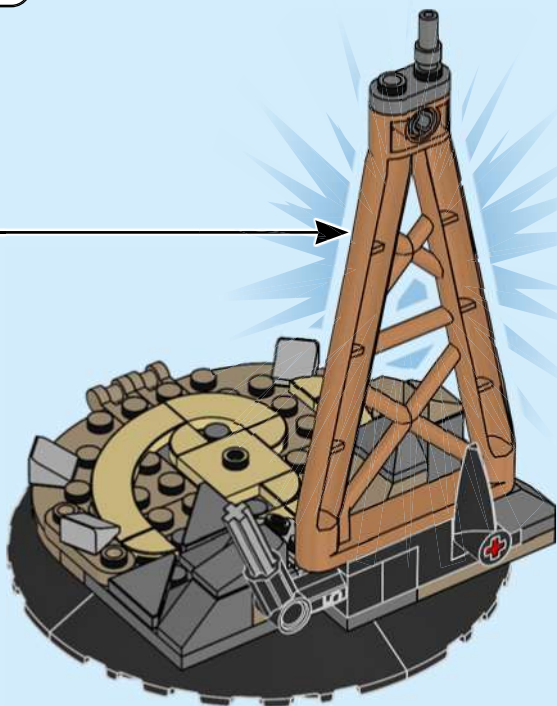
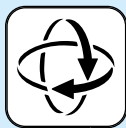

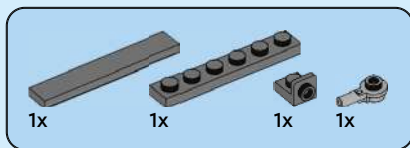

27

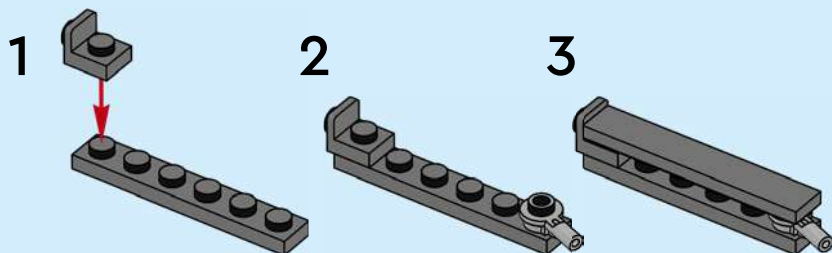

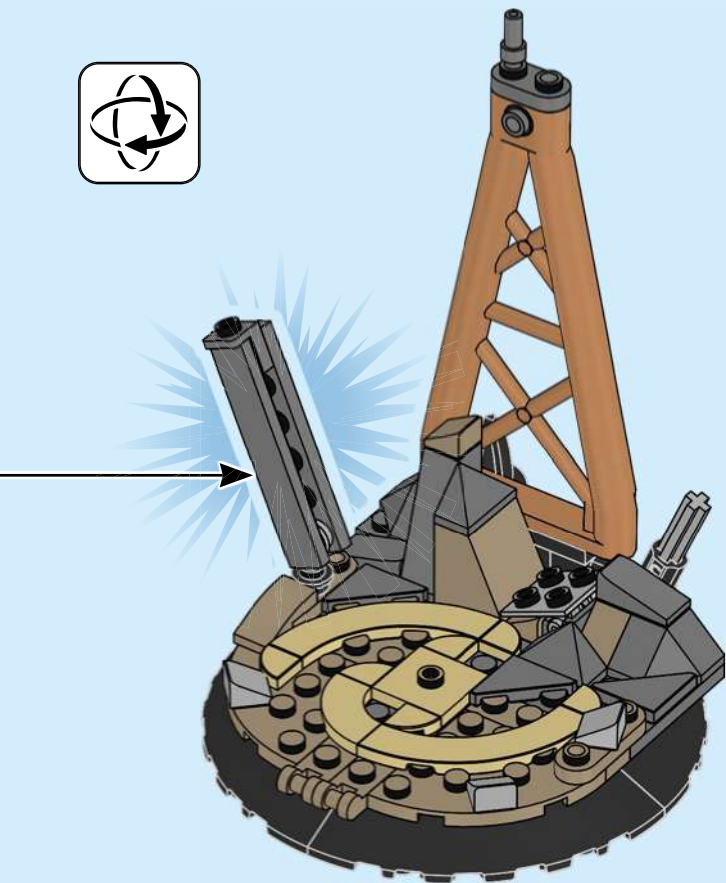

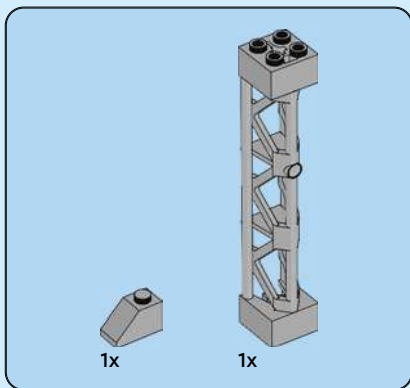
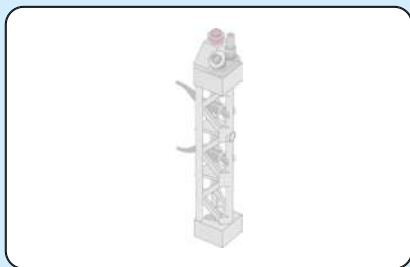

28

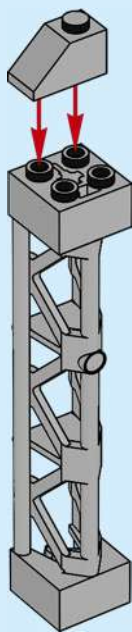



1x

29

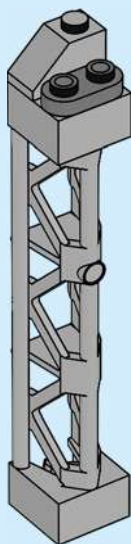



1x



1x



1x

# 30

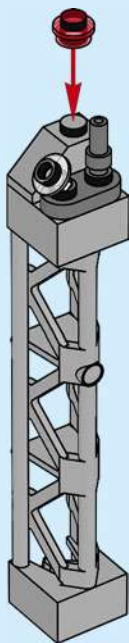



2x



2x

# 31

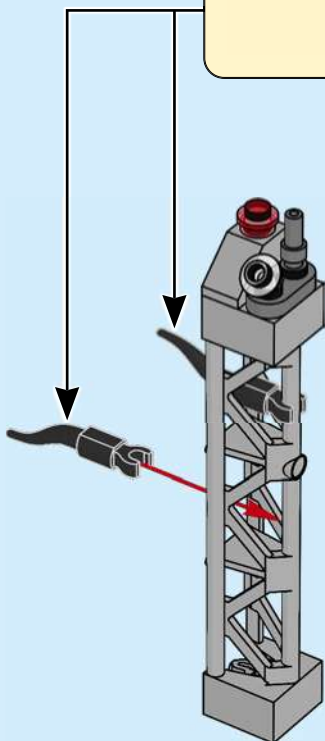
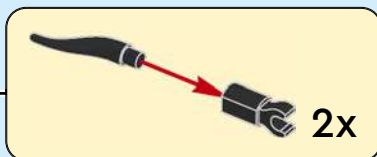

32

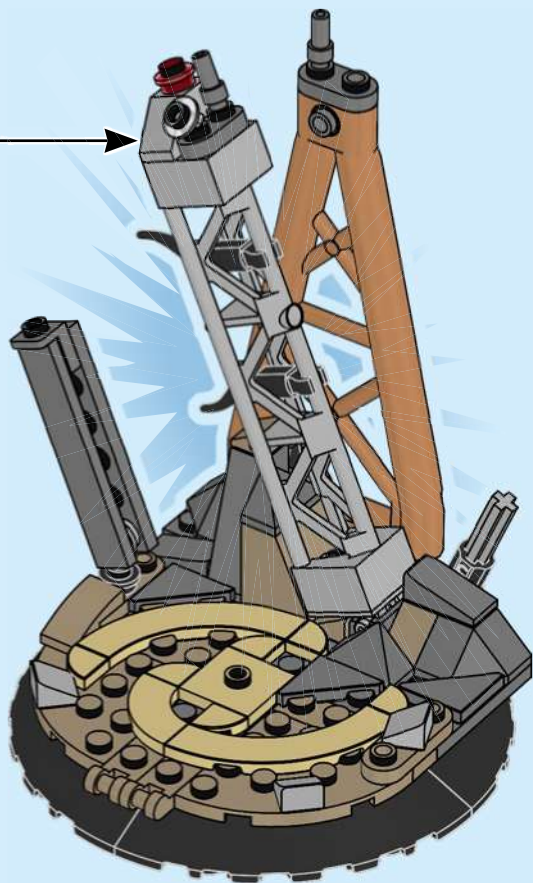

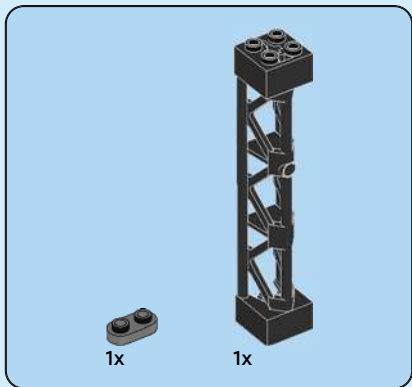
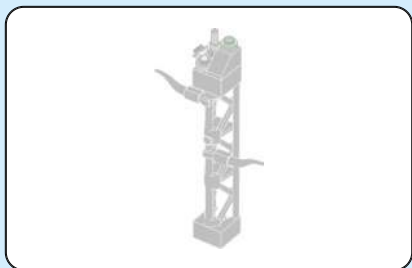

33





1x



1x

# 34





1x



1x

# 35



2x

2x

# 36

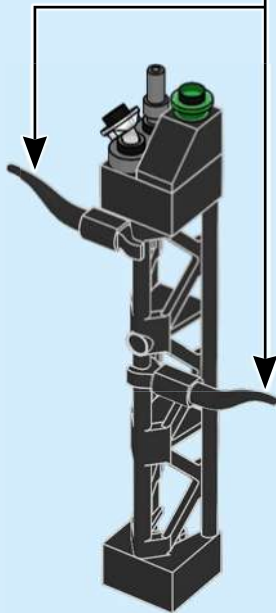
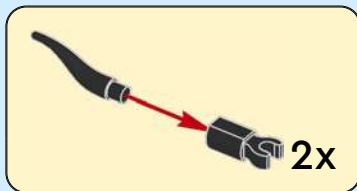

37

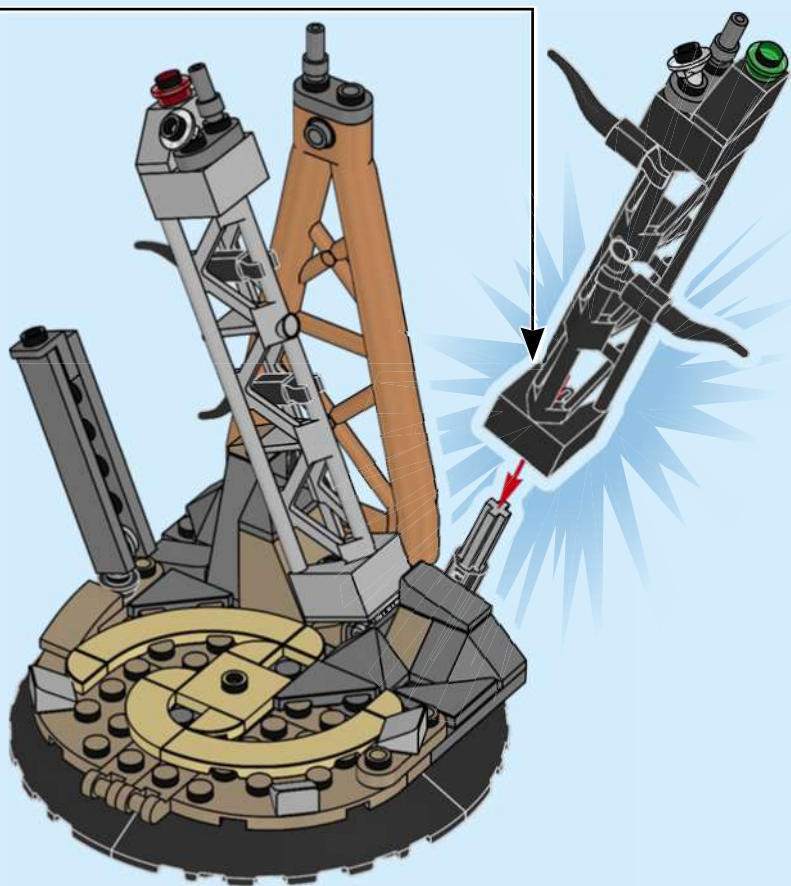

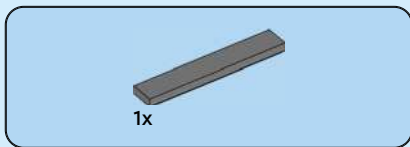

38

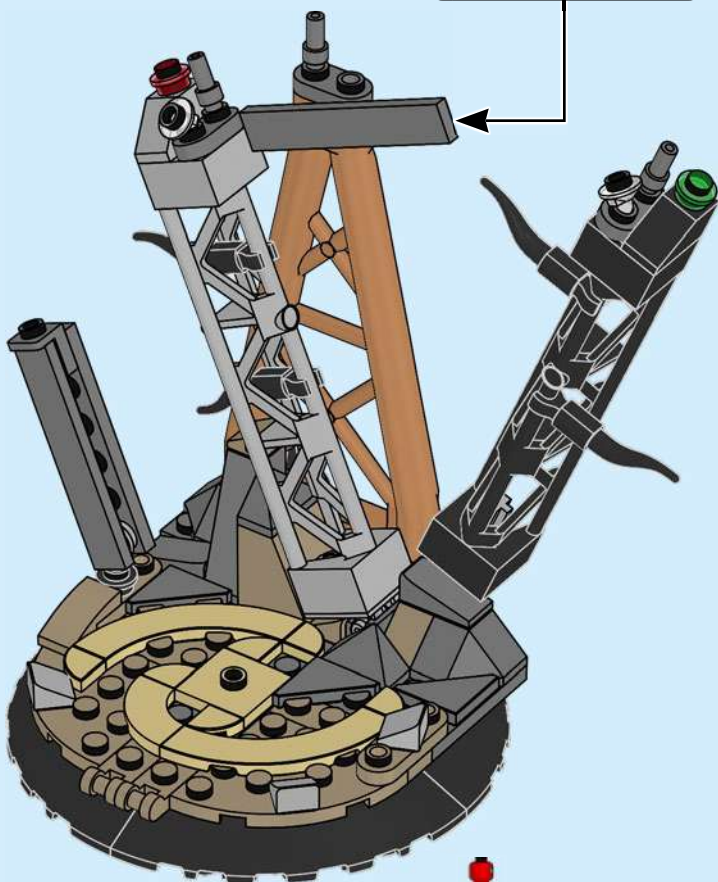
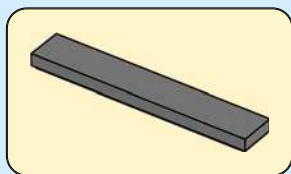

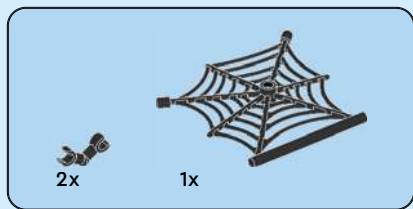

# 39



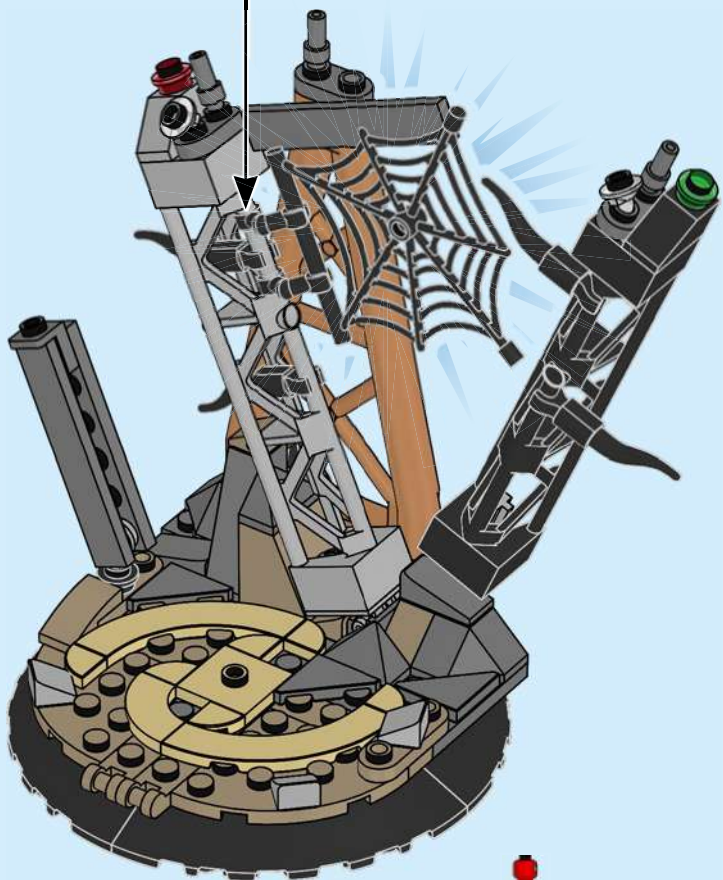

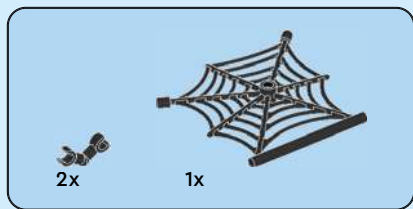

40



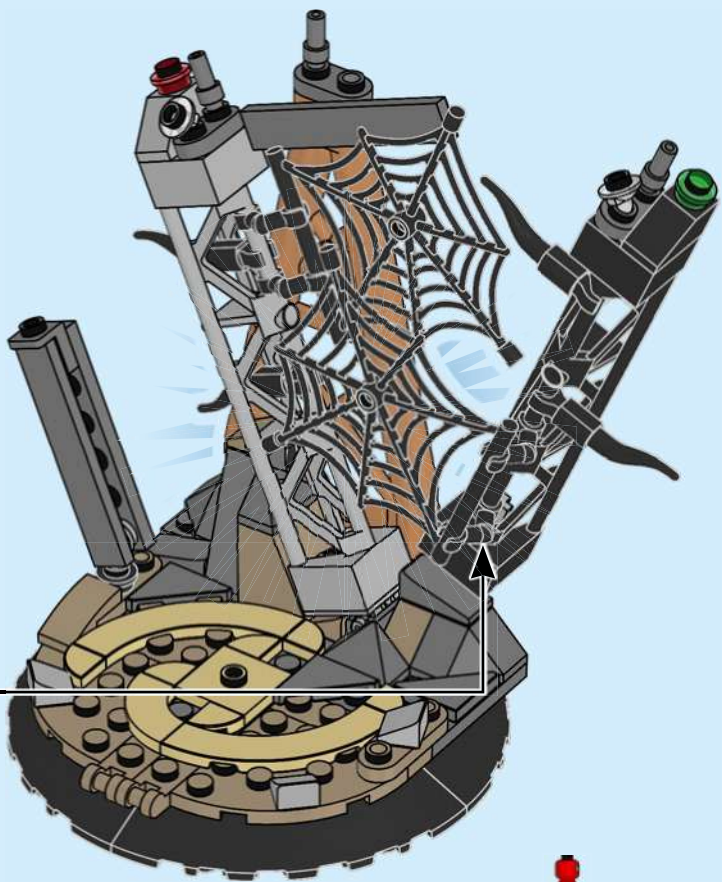

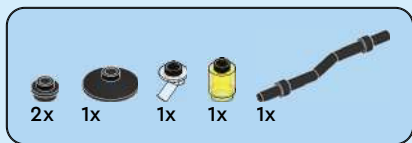

# 41

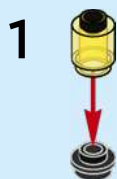

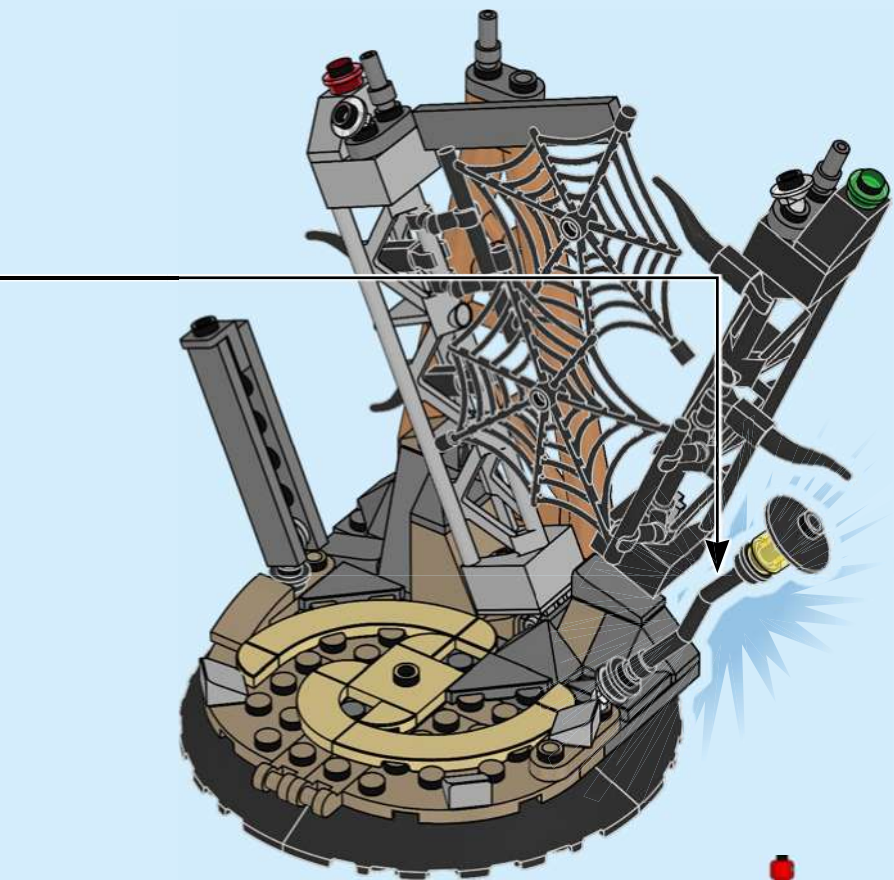



1x



1x



1x

# 42

1



2

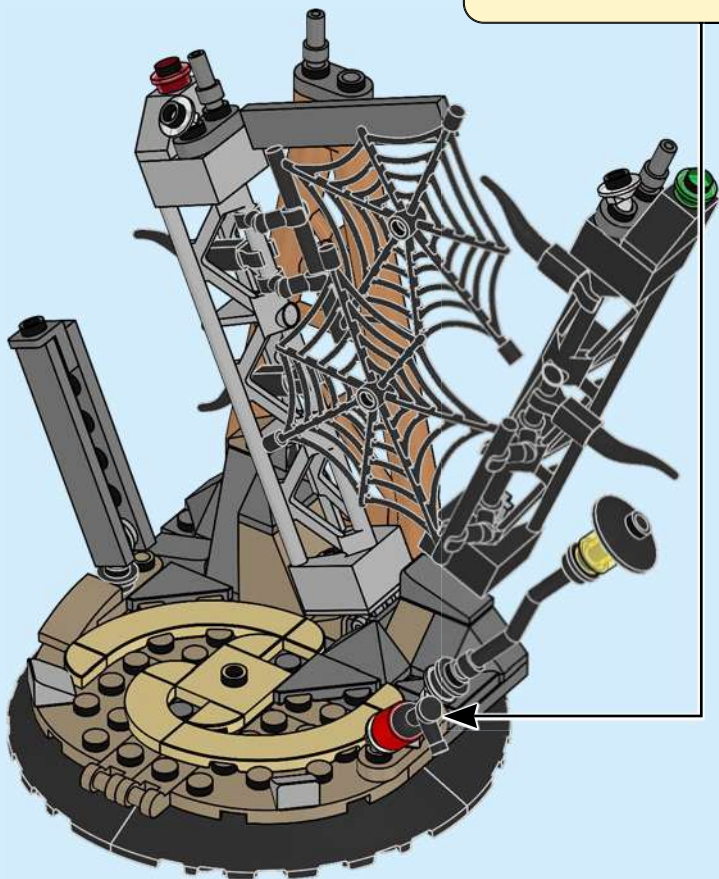

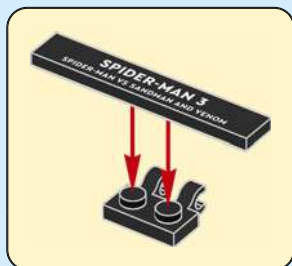
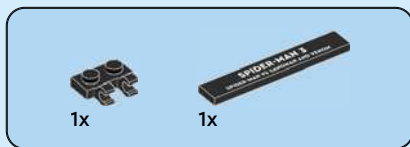

# 43

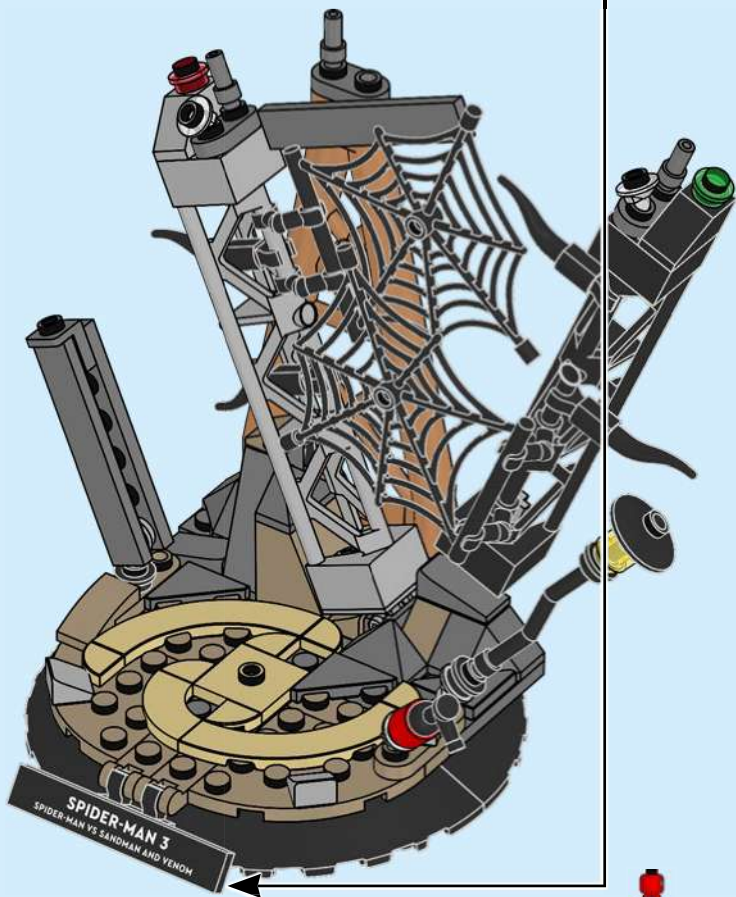



**LEGO****MARVEL****76343****76334****EPIC  
MOMENT  
COLLECTION**

Epic Moment Collection · Sammlung „Epische Momente“ ·  
Collection Moments épiques · Collezione Momento Epico ·  
Colección Momentos Legendarios · Coleção Momentos Épicos ·  
史诗时刻系列 · Kolekcja epickich scen filmowych · Kolekcje  
velkolepých momentů · Kolekcja veľkolepých momentov ·  
Fantasztikus pillanatok gyűjteménye · Колекція епічних  
моментів · Colectia de momente memorabile · Колекция  
„Епични моменти“ · Legendáro mirkľu kolekcija · Eepiliste  
hetkede kolleksioon · Nepamirštamu akimirku kolekcija

The LEGO logo is displayed in its characteristic white font with a yellow outline, set against a red square background. The background of the entire advertisement features a large, detailed LEGO Iron Man figure in the foreground, and a collage of various Marvel characters in the background, including Iron Man, Spider-Man, and others, rendered in a light, sketch-like style.The MARVEL logo is shown in a bold, white, sans-serif font, centered within a red rectangular box.

# START YOUR **EPIC MOMENT COLLECTION**

Start your Epic Moment Collection · Starte deine Sammlung epischer Momente · Commencez votre collection Moments épiques · Avvia la tua Collezione Momento Epico · Inicia tu Colección Momentos Legendarios · Dê Início à Coleção de Momentos Épicas · 开始你的史诗时刻系列 · Zakożte si swoj kolekcj epickich scen filmowych · Zakożte si kolekcji velkolepch moment · Zakożte si kolekciju velkolepch momentov · Gyjts fantasztikus pillanatokat! · Zapochnite svoju kolekciju epičnih moment · Īncere-ťi Colecia de momente memorabile · Zapochnete svojata kolekcija „Epicni momenti” · Sc savu Legendro mirkl kolekciju · Alusta oma eepiliste hetkede kollektiisooni · Pradkite rinkti nepamirtam akimirk kolekcij

MARVEL STUDIOS

THE  
INFINITY  
SAGA



AVENGERS: AGE OF ULTRON  
HULK VS ULTRON VS THE HULK

EPIC  
MOMENT  
COLLECTION

**LEGO**

**MARVEL**



76336



76335



76342



76338



76337



MARVEL

SPIDER-MAN

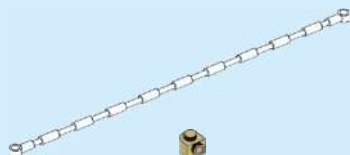

1x  
6409728



1x  
6584364



8x  
6145570



1x  
4118793



5x  
6143058



3x  
6299935



3x  
6299936



1x  
6584366



1x  
6092587



2x  
6391523



2x  
6174919



5x  
6480280



1x  
6454934



2x  
4114306



1x  
4565387



1x  
6226565



1x  
6221467



4x  
6265572



1x  
6302263



1x  
6055783



2x  
6487881



1x  
6597132



1x  
6302268



2x  
6458175



2x  
6099893



1x  
306221



1x  
6448795



1x  
4142865



1x  
6457827



8x  
6315887



3x  
6168646



1x  
6584362



1x  
459926



3x  
6344819



4x  
6326681



1x  
474026



1x  
9339



1x  
4121966



1x  
6271346



1x  
6310268



1x  
6420716



3x  
6382249



1x  
6288220



9x  
6312496



1x  
6470981



1x  
6597115



4x  
6605464



1x  
6484901



1x  
6537964



1x  
6584367



2x  
6588277



4x  
6510188



1x  
6514051



1x  
6514236



1x  
6514057



3x  
6040126



8x  
6496672



3x  
6530972



2x  
6588279



1x  
4530678

2x  
6101254

4x  
6446789

2x  
6210495

2x  
6449564

2x  
6456637

4x  
6135607

1x  
4616593

1x  
4626904

3x  
6232138

2x  
4570451

1x  
6167894

1x  
6458400

3x  
4521921

1x  
6227897

1x  
4211614

1x  
6093527

3x  
4211397

2x  
4211815

1x  
4211881

1x  
6186292

4x  
4211419

1x  
4211795

2x  
6395635

1x  
6225494

3x  
6350724

3x  
6221607

2x  
6076203

1x  
4211066

2x  
6533800

1x  
4221745

3x  
6262025

1x  
4210635

2x  
6227909

2x  
4210651

1x  
4211056

1x  
4243831

1x  
4210997

1x  
6468917

3

 [LEGO.com/service](https://www.LEGO.com/service)



YOU COULD

WIN



Scan this QR code or go to [LEGO.COM/PRODUCTFEEDBACK](https://LEGO.COM/PRODUCTFEEDBACK) and give us your short feedback about this LEGO® set for a chance to win a cool LEGO prize.

Terms and Conditions apply\*



**EN: YOU COULD WIN.** Terms and Conditions apply\* **DE: Du könntest GEWINNEN.** Es gelten die Teilnahmebedingungen\* **FR: Tu pourrais GAGNER.** Des conditions s'appliquent\* **IT: Potresti VINCERE tu.** Termini e condizioni sono applicabili\* **ES: Puedes GANAR.** Aplican términos y condiciones\* **PT: PODERÁ GANHAR.** Aplicam-se Termos e Condições\* **ZH: 轻松获奖.** 条款和条件适用\* **PL: Szansa na WYGRANAŃ.** Obowiązuje regulamin\* **CS: Máte šanci VYHRÁT.** Platí všeobecné smluvní podmínky\* **SK: Máte šancu VYHRÁŤ.** Platia všeobecné zmluvné podmienky\* **HU: TE IS NYERHETSZ.** Felhasználási feltételek érvényesek\* **UA: ВИ МОЖЕТЕ ВИГРАТИ.** Застосовуються загальні положення та умови\* **RO: Ai putea CÂȘTIGA.** Se aplică termeni și condiții\* **BG: Можете да СПЕЧЕЛИТЕ.** Има определени правила и условия\* **LV: Tu vari LAIMĒT.** Ir spēkā noteikumi un nosacījumi.\* **ET: Sul on võimalus VÕITA.** Kehtivad tingimused\* **LT: Jūs galite LAIMĖTI.** Taikomos sąlygos\*

\*[LEGO.com/productfeedback-terms](https://LEGO.com/productfeedback-terms)

LEGO and the LEGO logo are trademarks of the LEGO Group.

©2026 The LEGO Group.

© MARVEL © 2026 CPII



6619842