

MIST

MEXEN

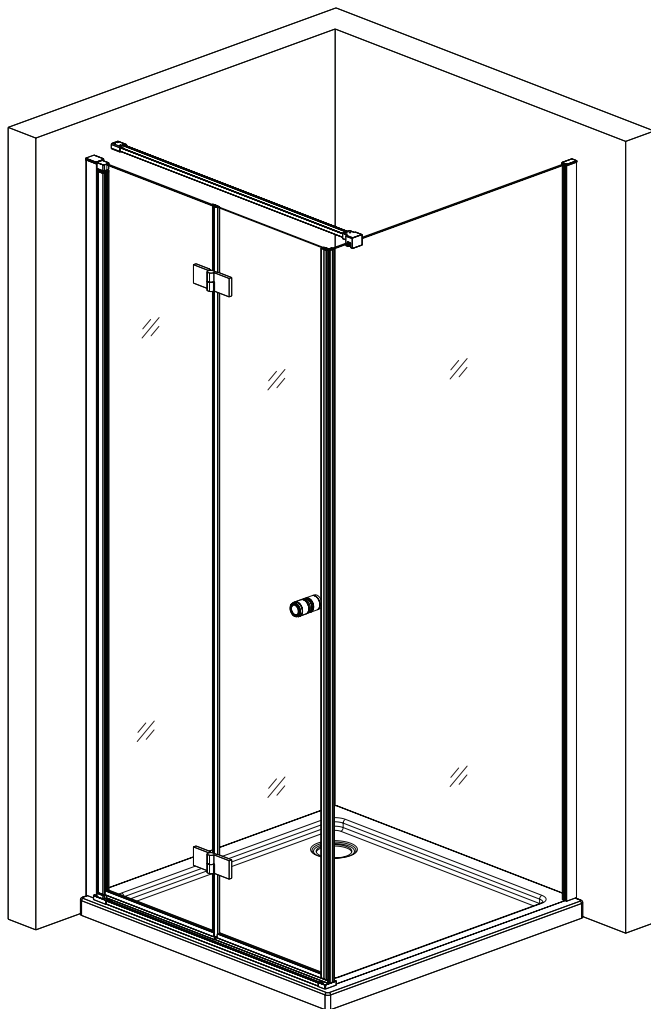





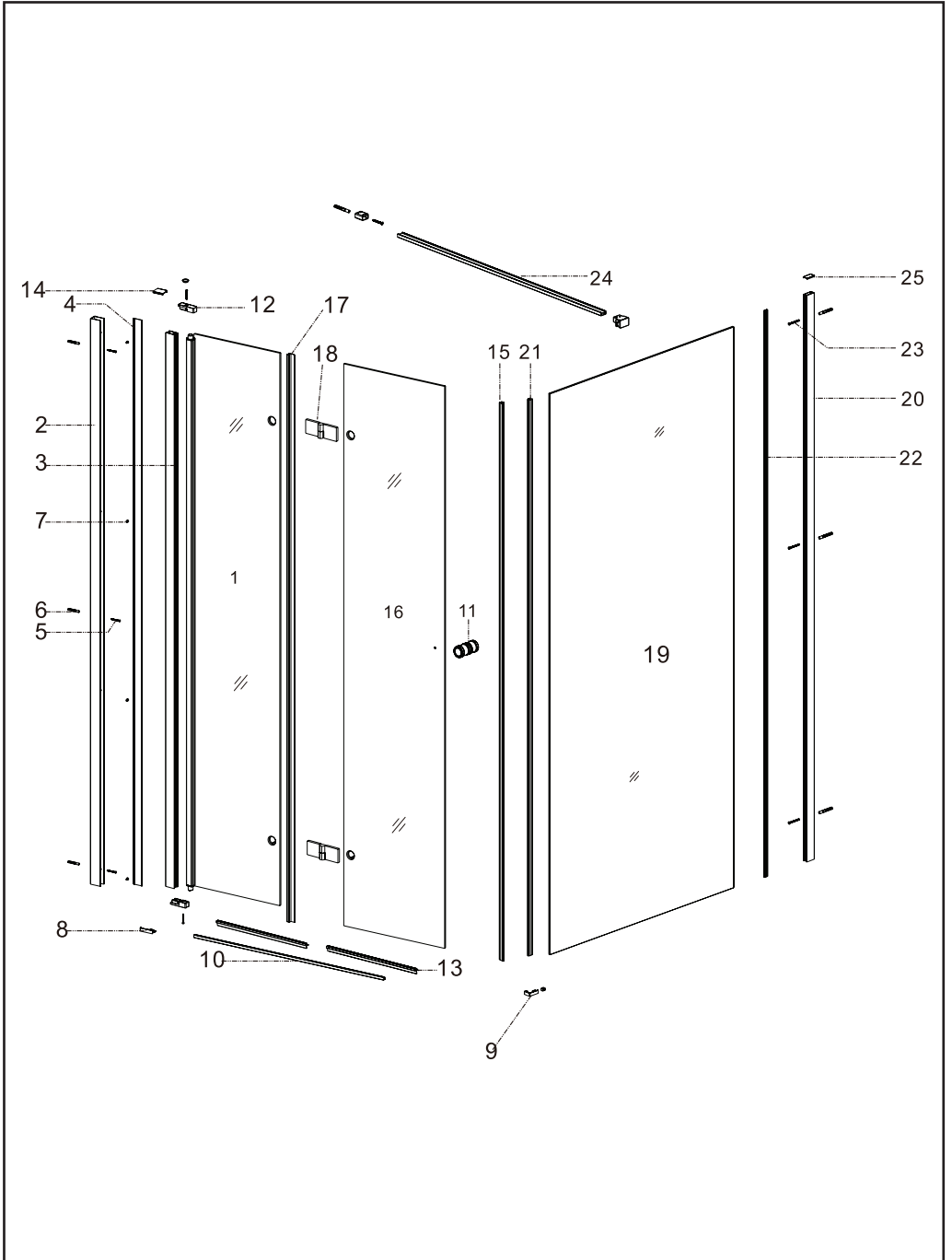

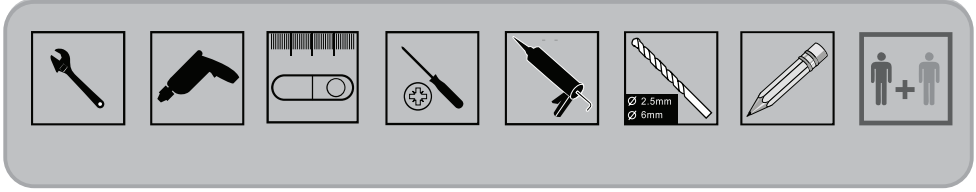



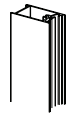
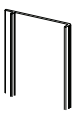

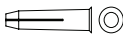









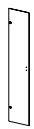

KABINA PRYSZNICOWA



[PL] Instrukcja montażu [EN] Assembly Instructions [DE] Montageanleitung [FR] Instructions de montage [IT] Istruzioni di montaggio [ES] Instrucciones de montaje [NL] Montage-instructies [RU] Инструкция по монтажу [SV] Monteringsanvisning [NO] Monteringsanvisning [DA] Monteringsvejledning [FI] Asennusohje [CS] Montážní návod [PT] Instruções de montagem [HU] Szerelési útmutató [RO] Instrucțiuni de montaj [EL] Οδηγίες συναρμολόγησης [SK] Návod na montáž [UK] Інструкція з монтажу [HR] Upute za montažu [LT] Montavimo instrukcija [BG] Инструкция за монтаж [SL] Navodila za montažo [LV] Montāžas instrukcija [ET] Paigaldusjuhend [SR] Упутство за монтажу [IS] Samsetningarleiðbeiningar [SQ] Udhëzime për montim [MK] Инструкции за монтажа [MT] Istruzzjonijiet għall-assemblaġġ

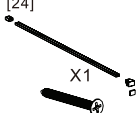



<p>[1]</p>  <p>X1</p>	<p>[2]</p>  <p>X1</p>	<p>[3]</p>  <p>X1</p>	<p>[4]</p>  <p>X1</p>	<p>[5]</p>  <p>ST3.5X32</p> <p>X8</p>	
<p>[6]</p>  <p>X6</p>	<p>[7]</p>  <p>ST3.5X9.5</p> <p>X4</p>	<p>[8]</p>  <p>X1 X1</p>	<p>[9]</p>  <p>X1 X1</p>	<p>[10]</p>  <p>X1</p>	<p>[11]</p>  <p>X1</p>
<p>[12]</p>  <p>X1</p>  <p>X2</p>	<p>[13]</p>  <p>X2</p>	<p>[14]</p>  <p>X1 X1</p>	<p>[15]</p>  <p>X1</p>	<p>[16]</p>  <p>X1</p>	<p>[17]</p>  <p>X1</p>
<p>[18]</p>  <p>X2</p>	<p>[19]</p>  <p>X1</p>	<p>[20]</p>  <p>X1</p>	<p>[21]</p>  <p>X1</p>	<p>[22]</p>  <p>X1</p>	<p>[23]</p>  <p>ST3.5X40</p> <p>X3</p>
<p>[24]</p>  <p>X1</p>  <p>ST3.5X32</p> <p>X1</p>	<p>[25]</p>  <p>X1</p>	<p>[26]</p>  <p>X3</p>	<p>[27]</p>  <p>X1</p>		

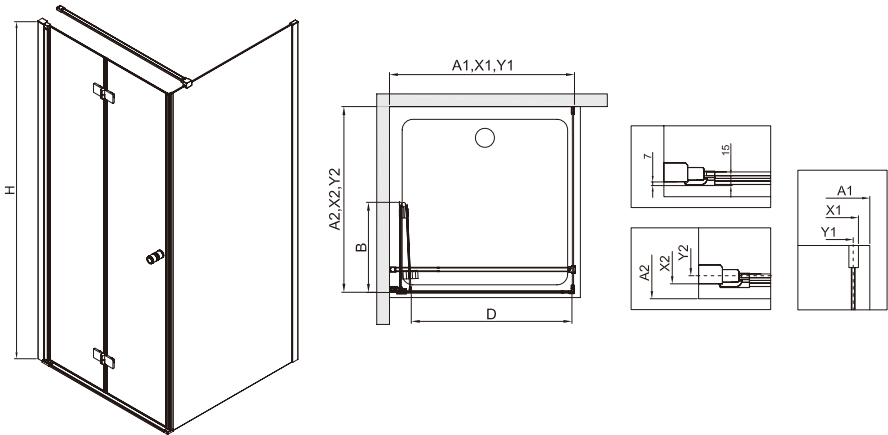

Sidewall	A2	X2	Y2	H
S 70	700	675-690	663-678	2000
S 75	750	725-740	713-728	2000
S 80	800	775-790	763-778	2000
S 85	850	825-840	813-828	2000
S 90	900	875-890	863-878	2000
S 95	950	925-940	913-928	2000
S 100	1000	975-990	963-978	2000
S 110	1100	1075-1090	1063-1078	2000
S 120	1200	1175-1190	1163-1178	2000

Model	A1	X1	Y1	B	D	H
60	600	570-585	563-578	251	246	2000
65	650	620-635	613-628	276	271	2000
70	700	670-685	663-678	301	296	2000
75	750	720-735	713-728	326	321	2000
80	800	770-785	763-778	351	346	2000
85	850	820-835	813-828	376	371	2000
90	900	870-885	863-878	401	396	2000
95	950	920-935	913-928	426	421	2000
100	1000	970-985	963-978	451	446	2000
105	1050	1020-1035	1013-1028	476	471	2000
110	1100	1070-1085	1063-1078	501	496	2000
115	1150	1120-1135	1113-1128	526	521	2000
120	1200	1170-1185	1163-1178	551	546	2000

