

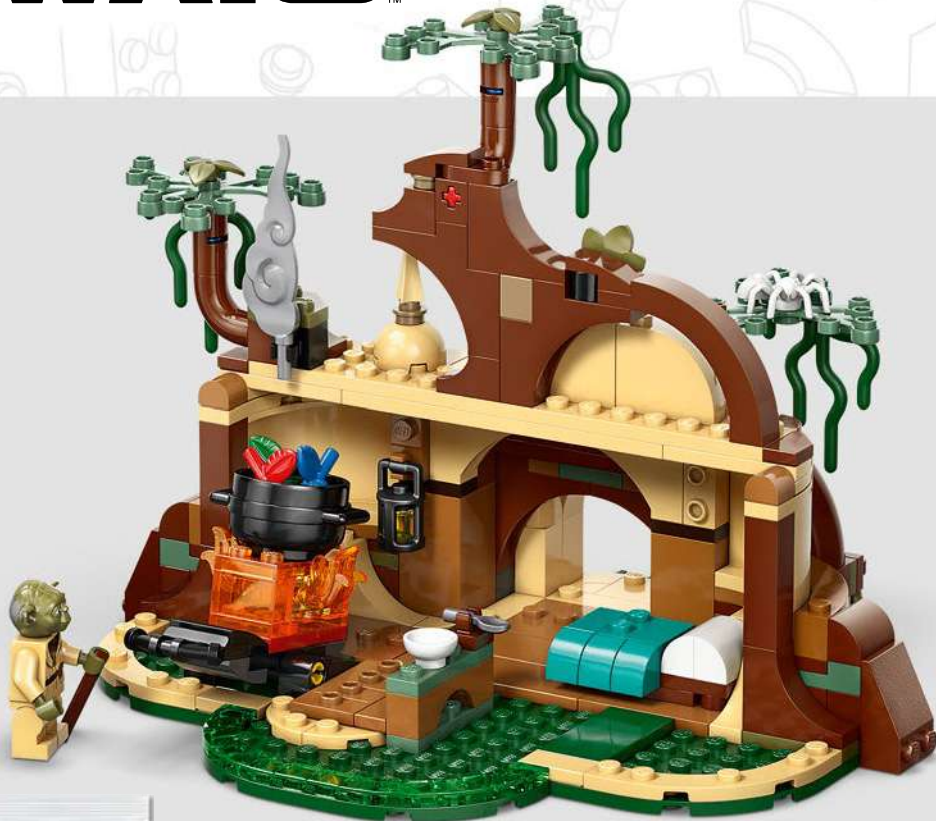

# STAR WARS™

75422



1

2



LEGO® Builder



LEGO.com/sustainable-packaging



FR

**DONNEZ**  
OU  
**RECYCLEZ**



OU



OU



ASSOCIATION

MAGASIN

DÉCHÈTERIE

Adresses sur [quefairedemesdechets.fr](http://quefairedemesdechets.fr)



🔍 LEGO® Builder

# BUILDER



Apple and the Apple logo are trademarks of Apple Inc., registered in the U.S. and other countries and regions. App Store is a service mark of Apple Inc. Google Play and the Google Play logo are trademarks of Google LLC. Tencent and the Tencent logo are trademarks of Tencent Inc.

🔍 [LEGO.com/devicecheck](https://lego.com/devicecheck)

**EN** Ask parents' permission before going online | **DE** Eltern um Erlaubnis bitten, bevor du online gehst | **FR** Demande l'autorisation d'un parent avant d'aller en ligne | **IT** Chiedi il permesso ai tuoi genitori prima di andare online | **ES** Pídeles permiso a tus papás antes de conectarte a Internet | **PT** Peça autorização aos pais antes de acederes online | **ZH** 上网前应先征得父母的同意 | **PL** Poproś rodziców o zgodę, zanim wejdiesz do Internetu | **CS** Než půjdeš na internet, požádej rodiče o svolení | **SK** Skôr než pôjdeš na internet, vypýtaj si povolenie od rodičov | **HU** Kérj szülői engedélyt, mielőtt online csatlakoznál! | **UA** Запитуйте дозволу батьків, перш ніж користуватися інтернетом | **RO** Cere permisiunea părinților înainte de a te conecta online | **BG** Поискайте разрешение от родител, преди да влезете онлайн | **LV** Pirms došanās tiešsaistē palūdz atļauju vecākiem | **ET** Enne Interneti kasutamist küsi vanematelt luba | **LT** Prieš prisijungdami prie interneto, atsiklauskite tėvų

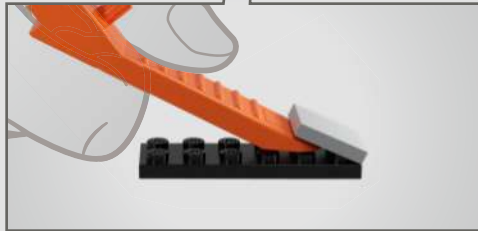
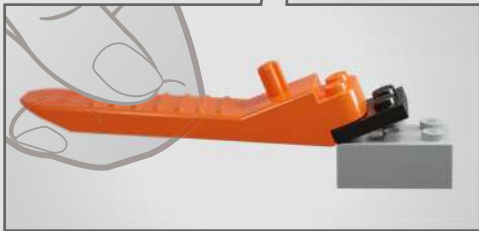
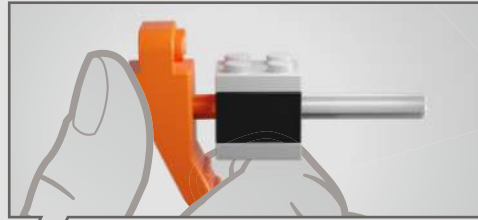
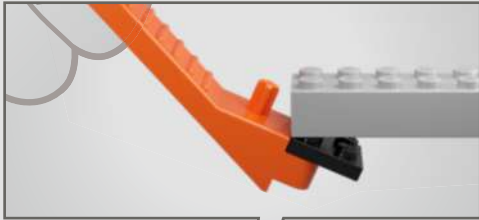

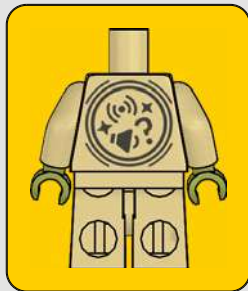
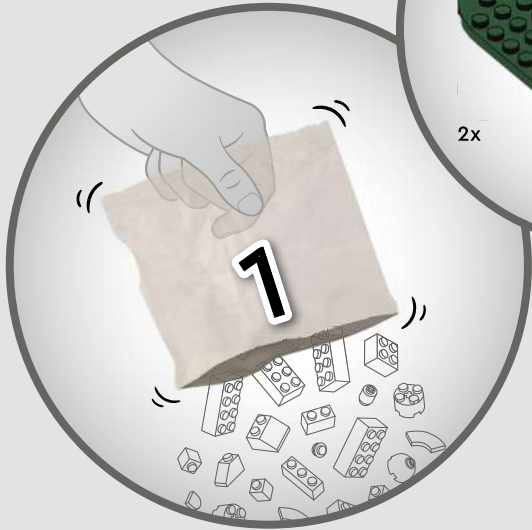
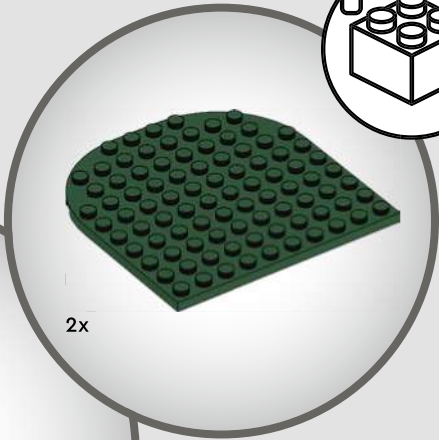
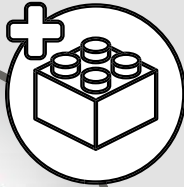

1

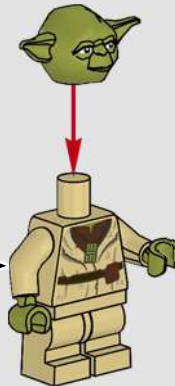

2



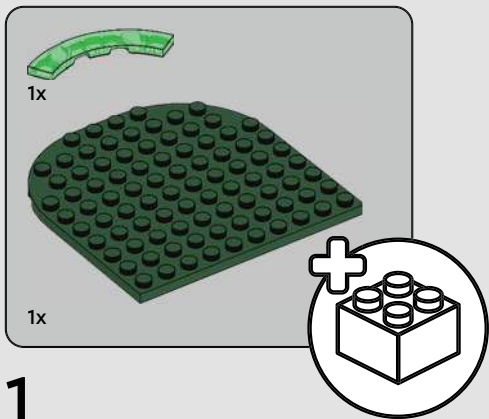

1

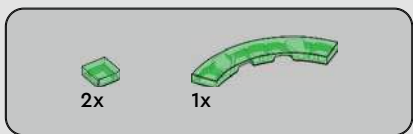
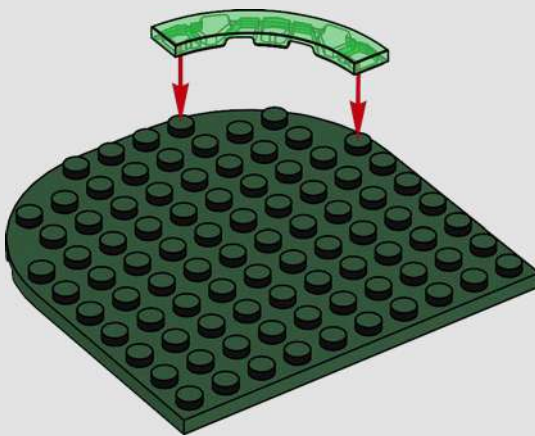

2

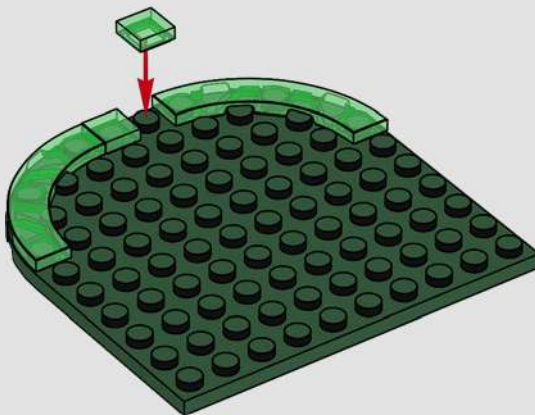



3

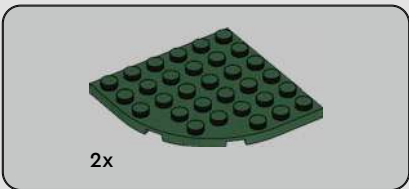
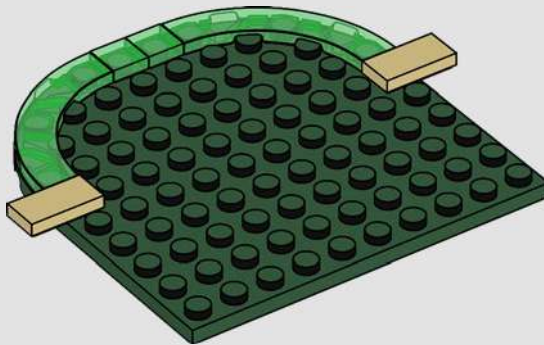

4

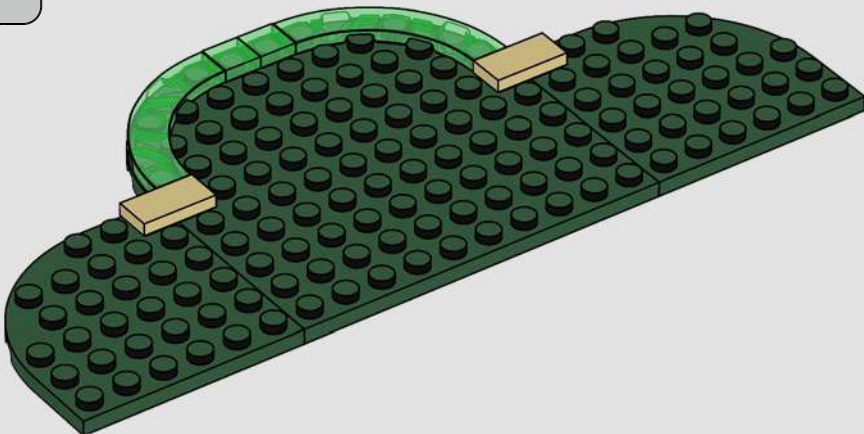

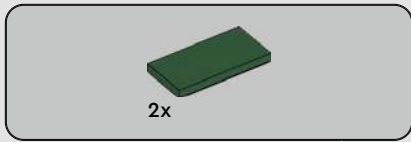

5

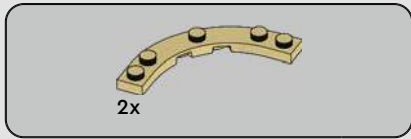
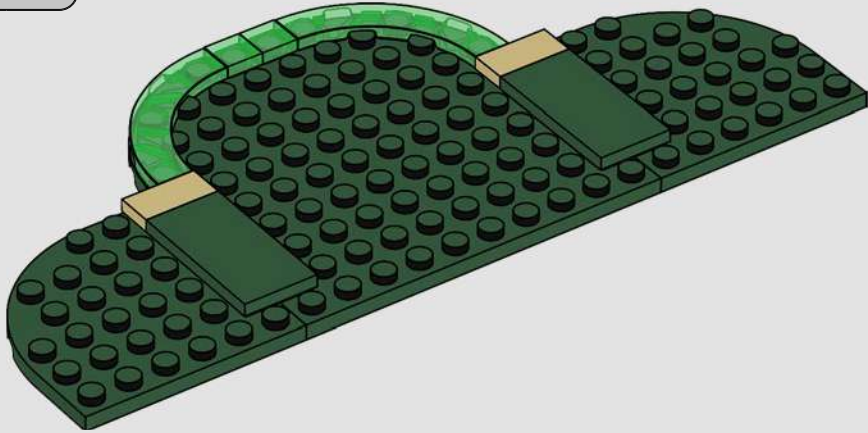

6

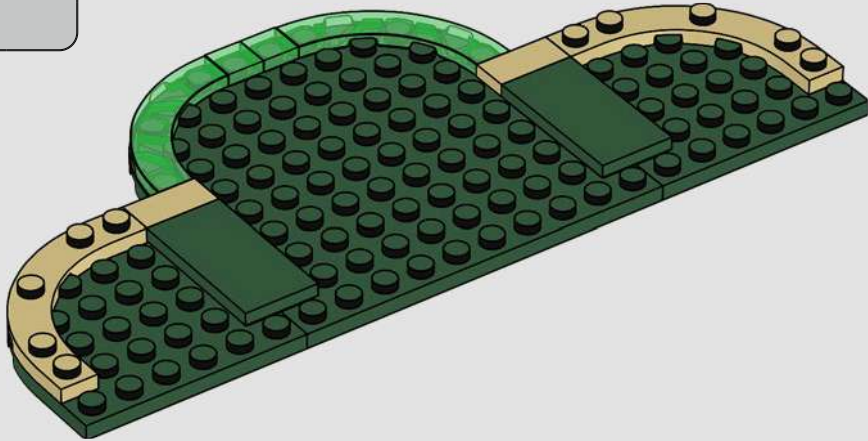

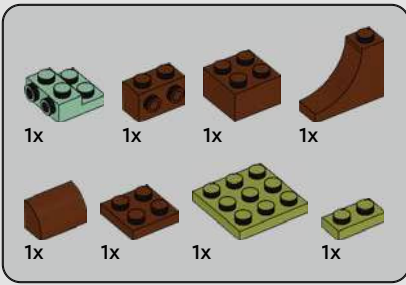

7

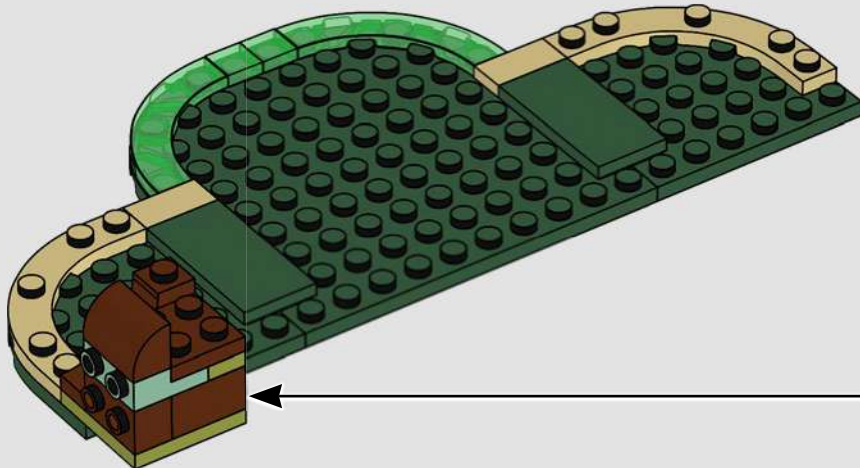
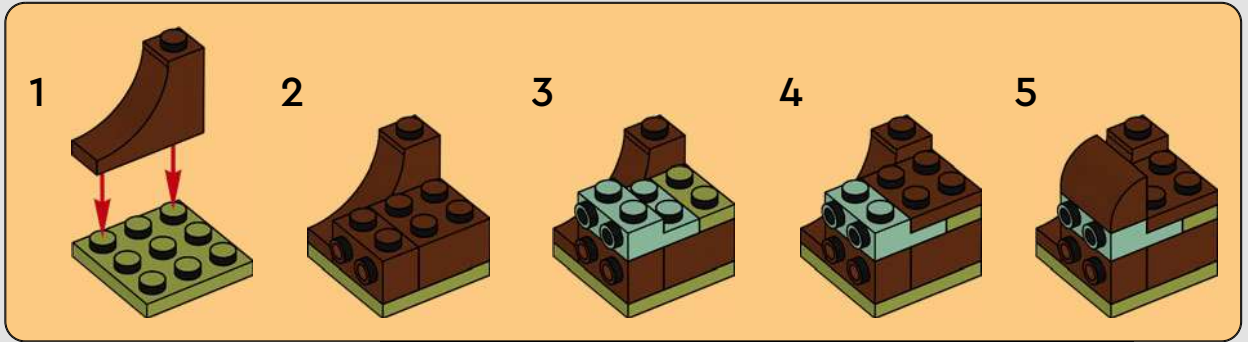



8

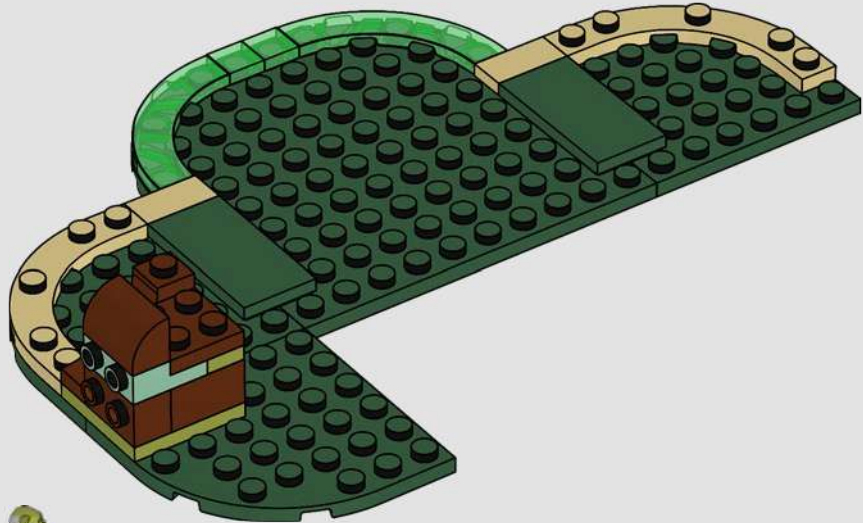

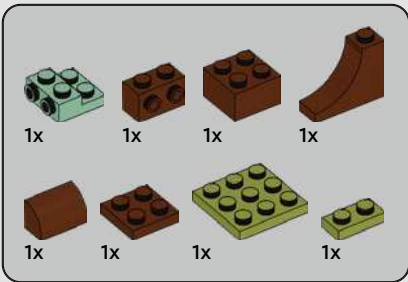

9

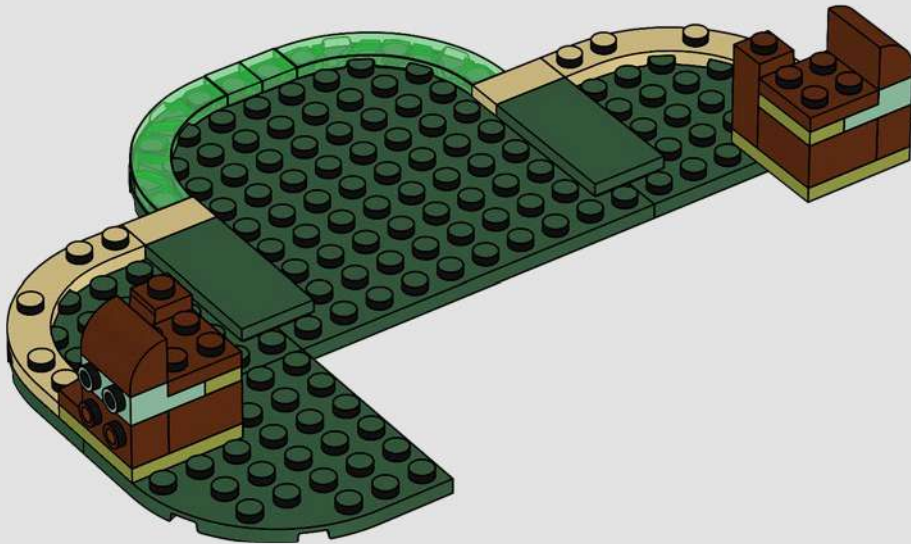
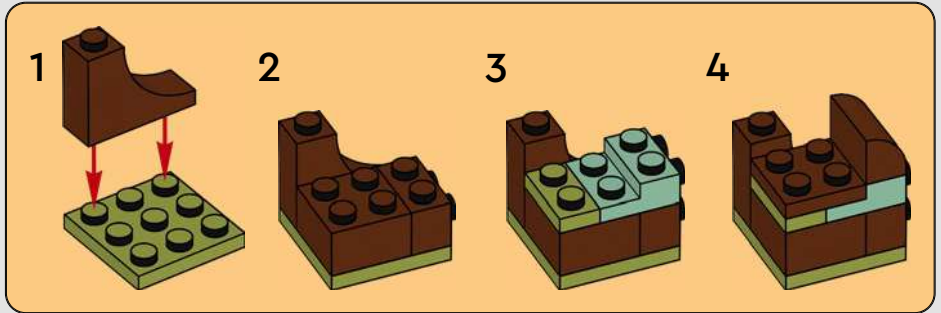

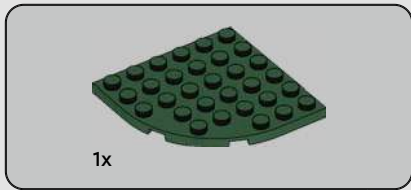

10

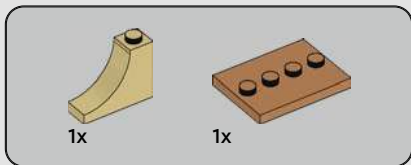
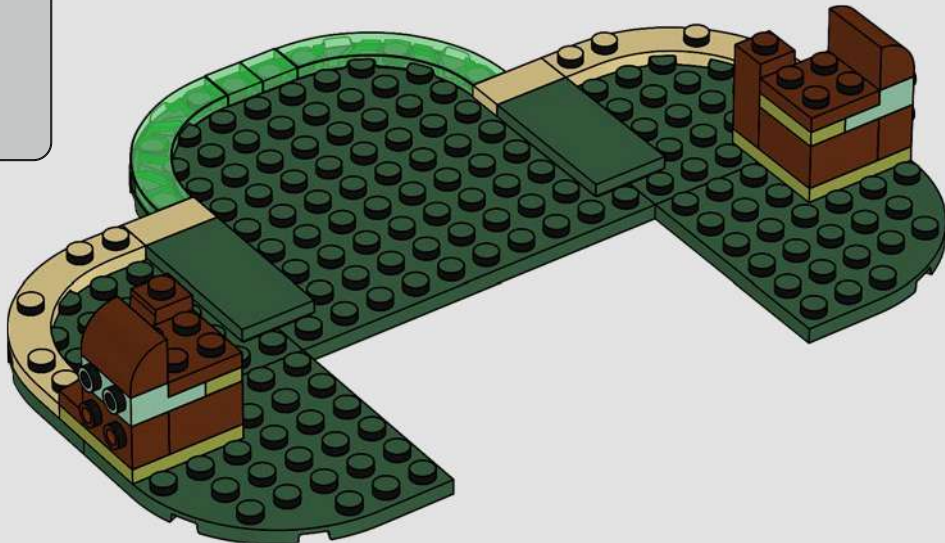

11



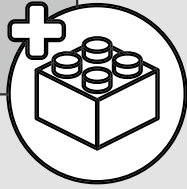
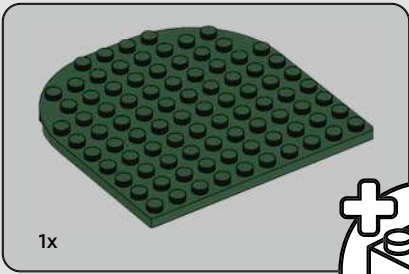

12



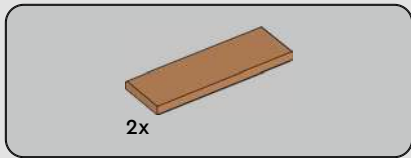

13

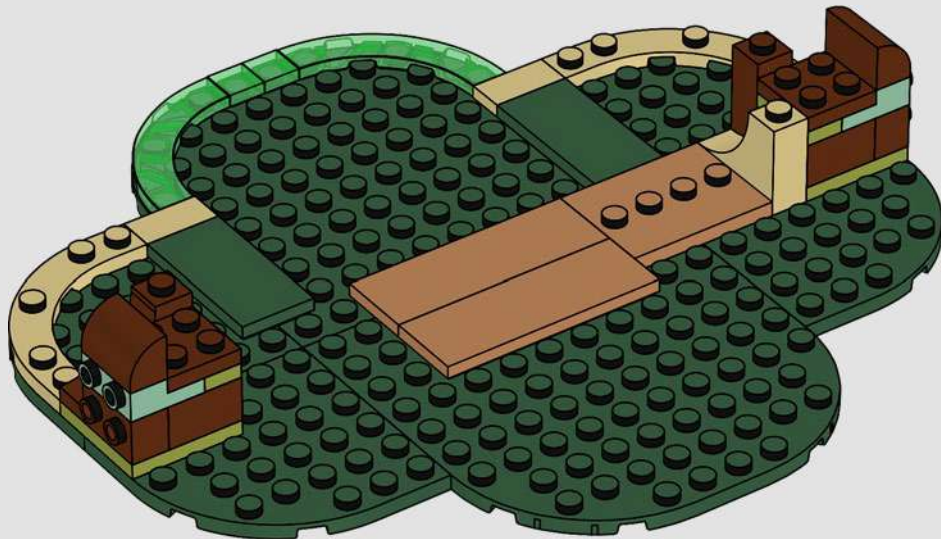

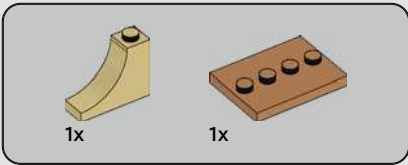

14

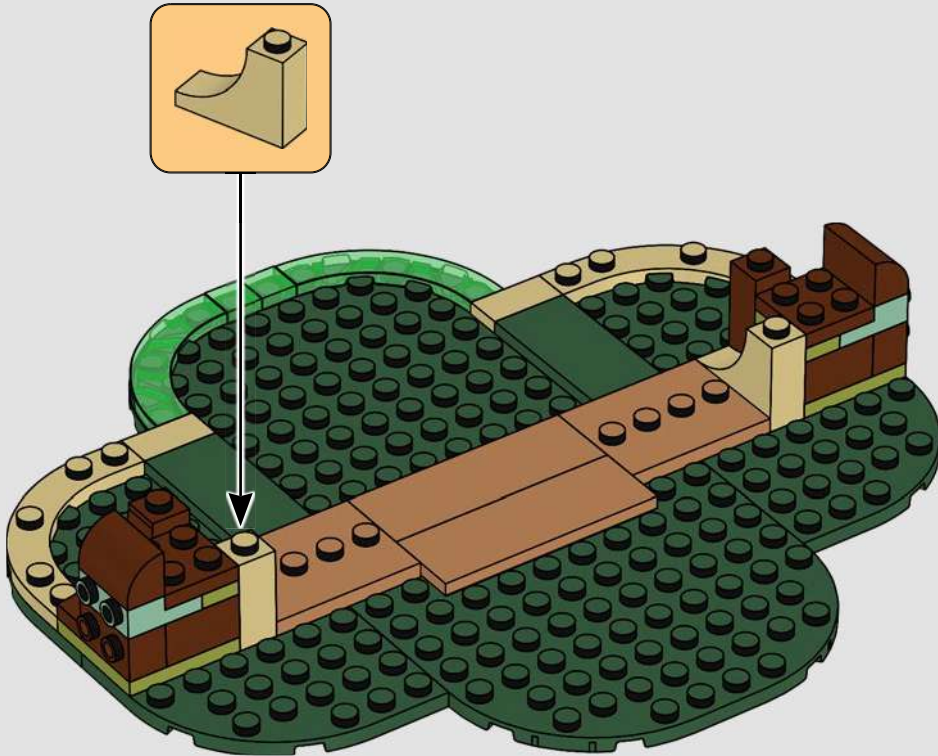

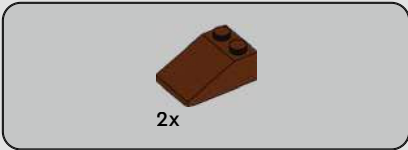

15

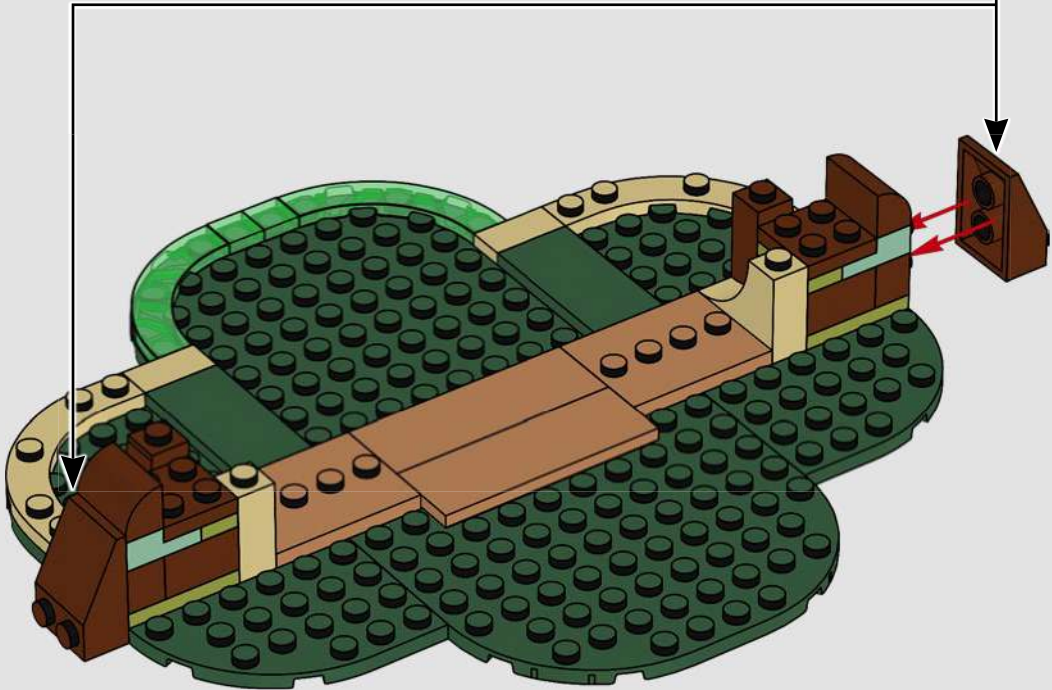

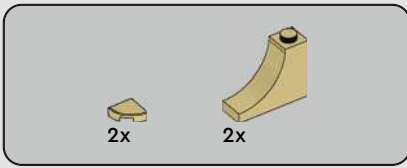

16

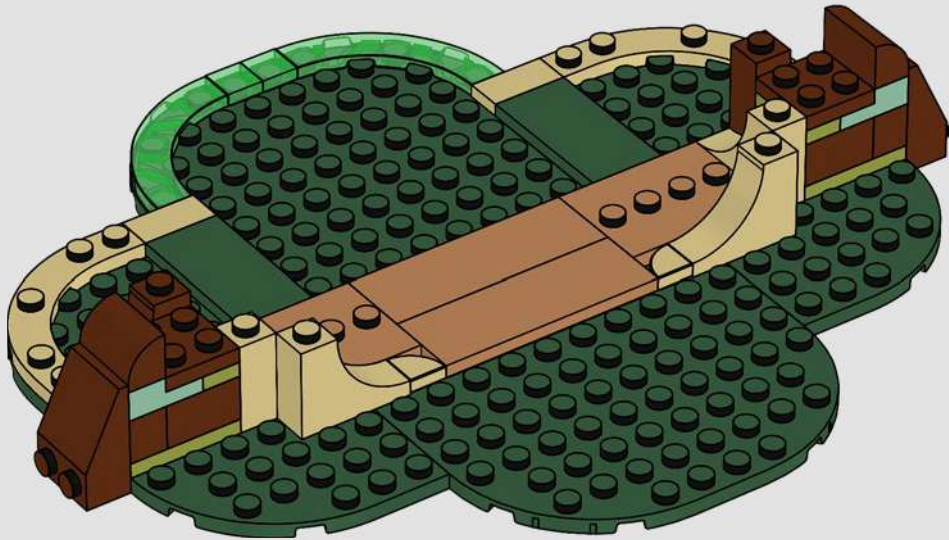

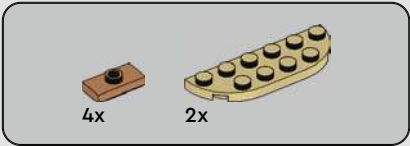

17

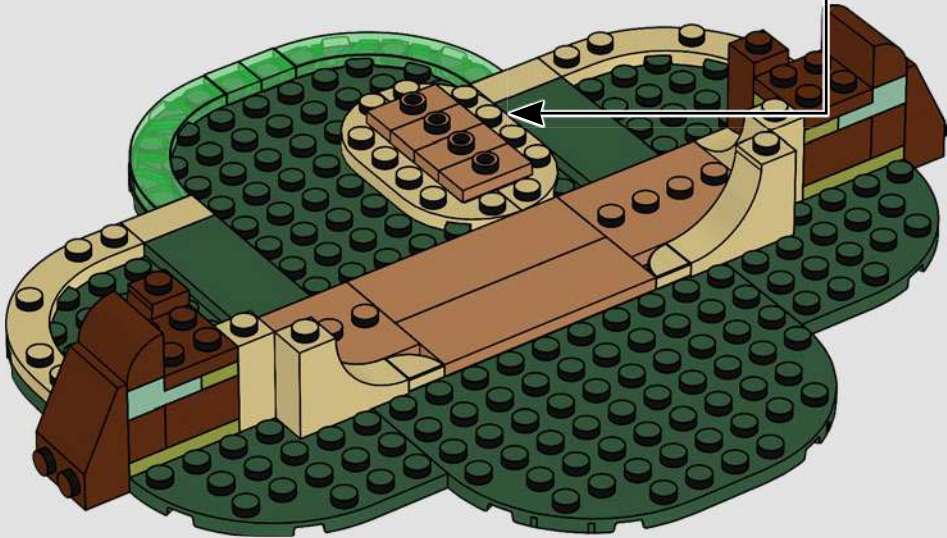
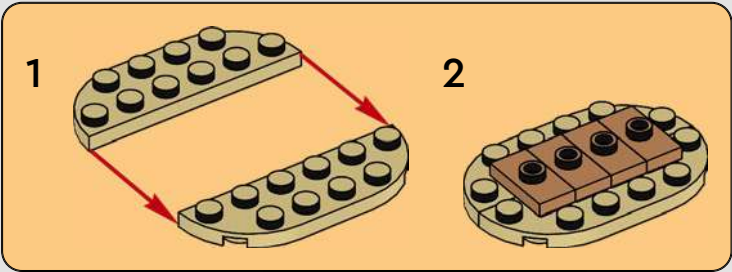

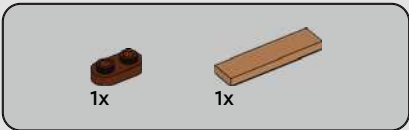

18

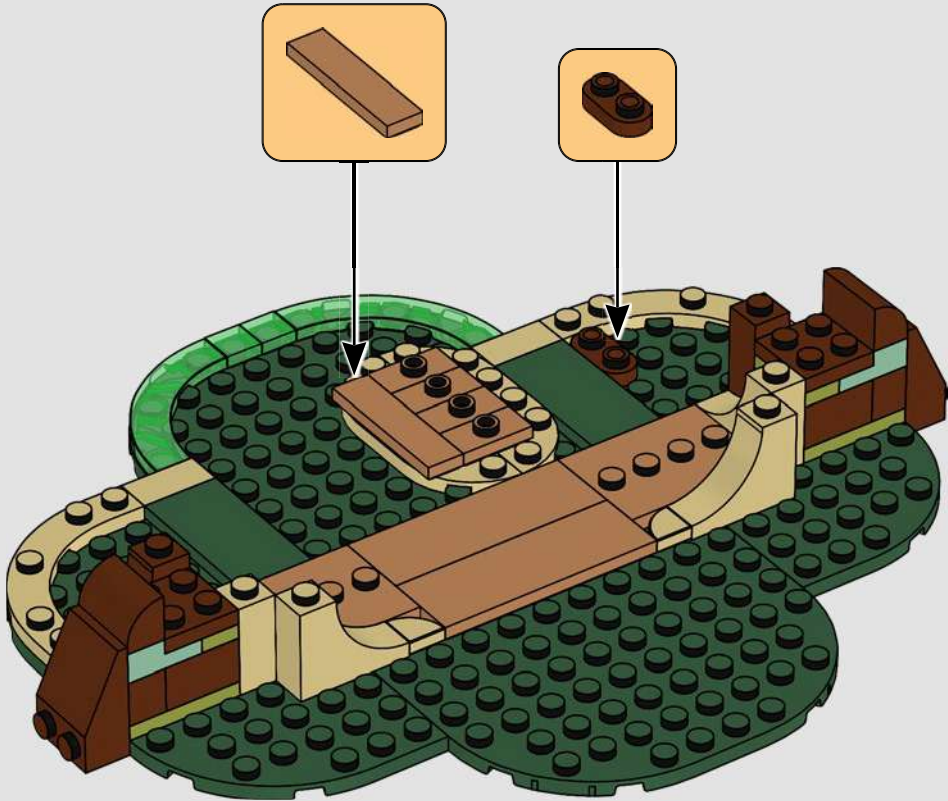



2x

19

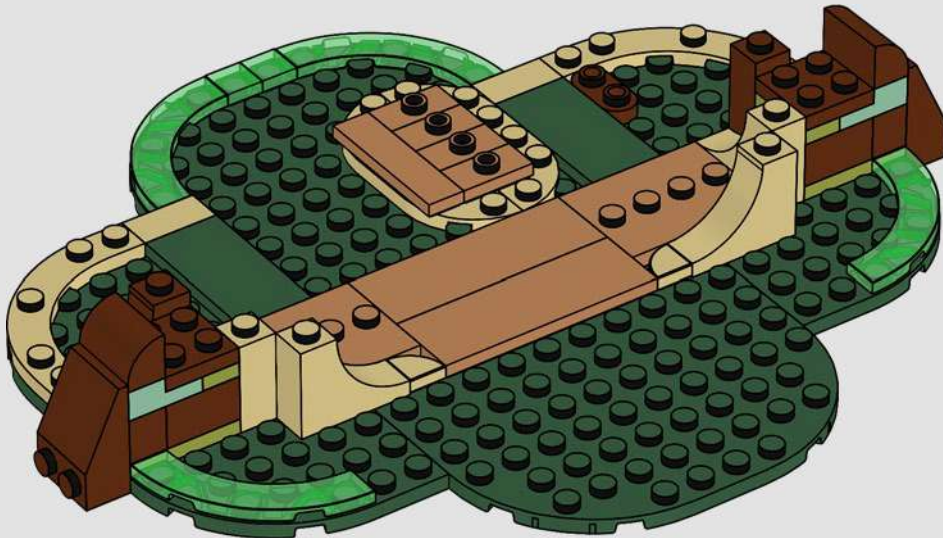

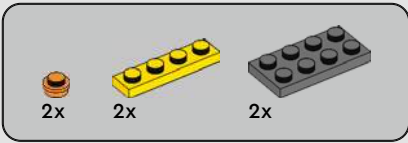

20



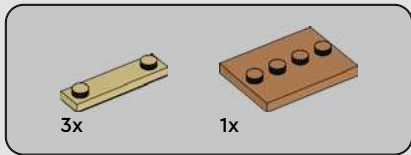

21

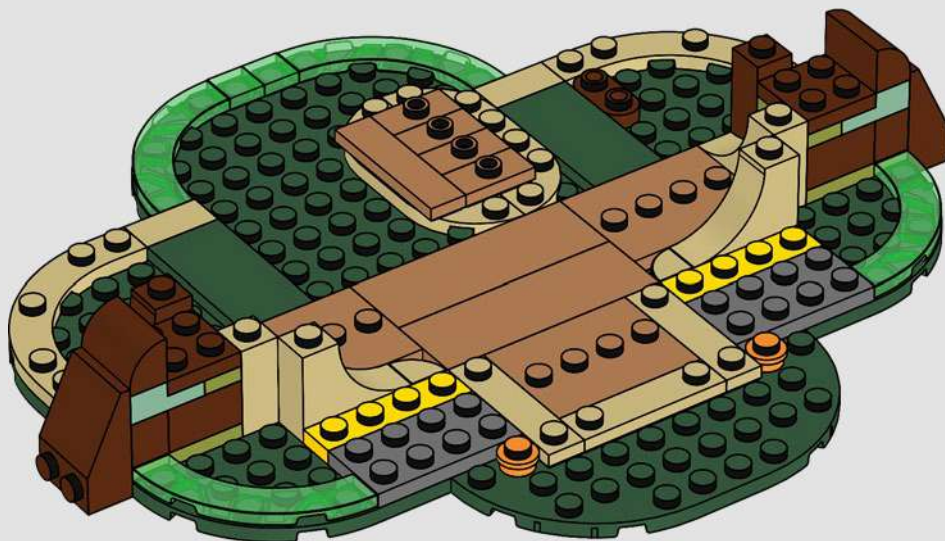

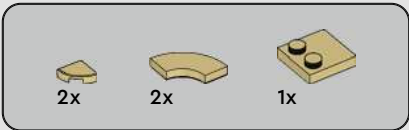

22

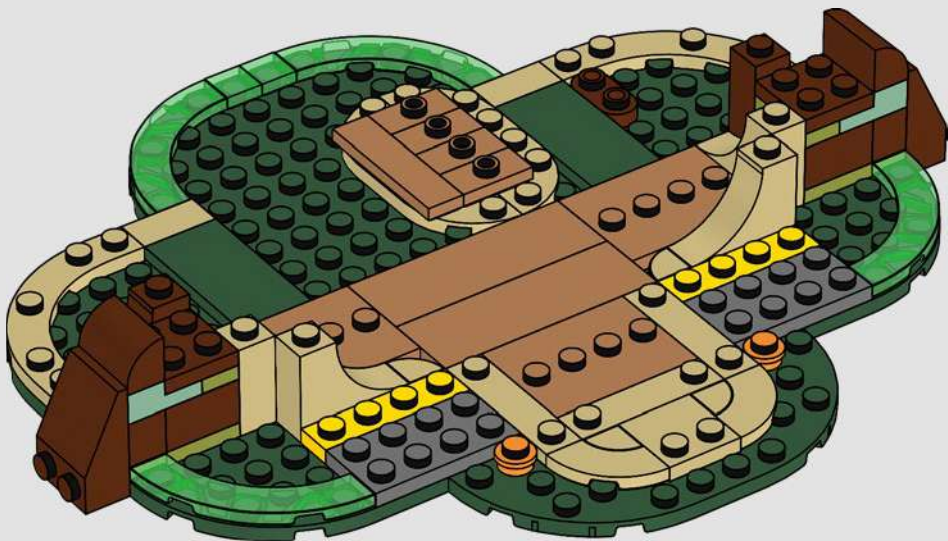

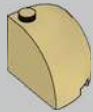

2x

23

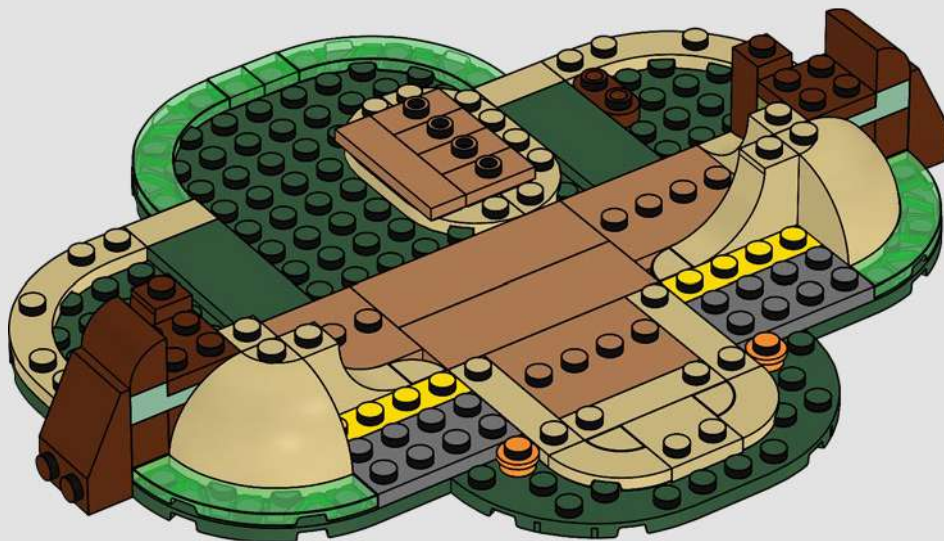



2x



2x

24





2x



2x

# 25





2x

26



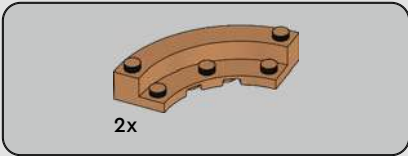

27



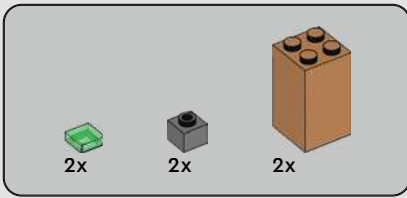

28

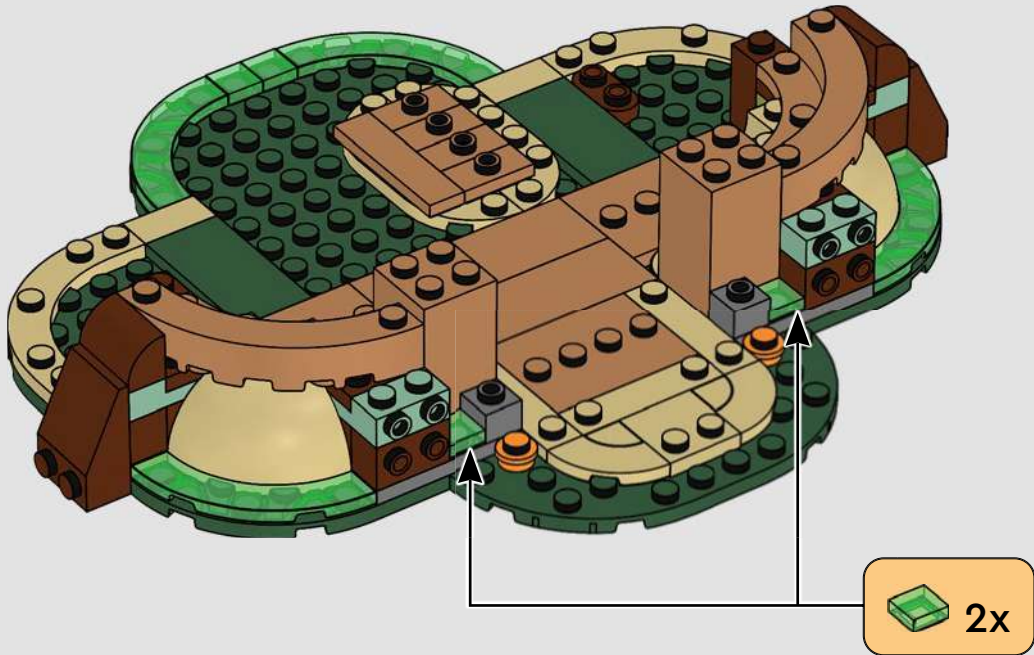

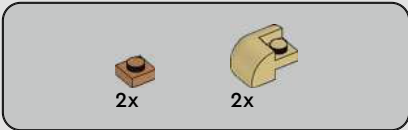

29

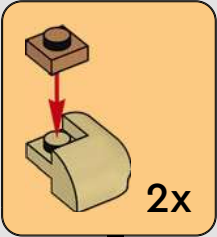

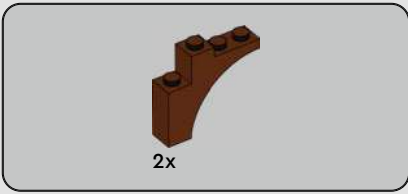

30

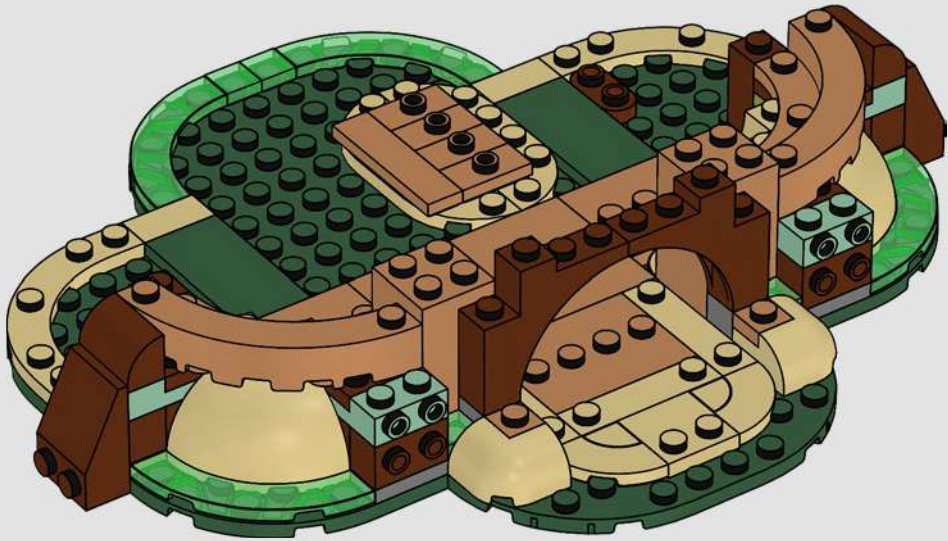

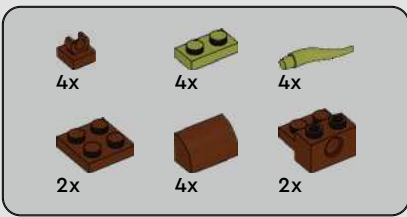

# 31

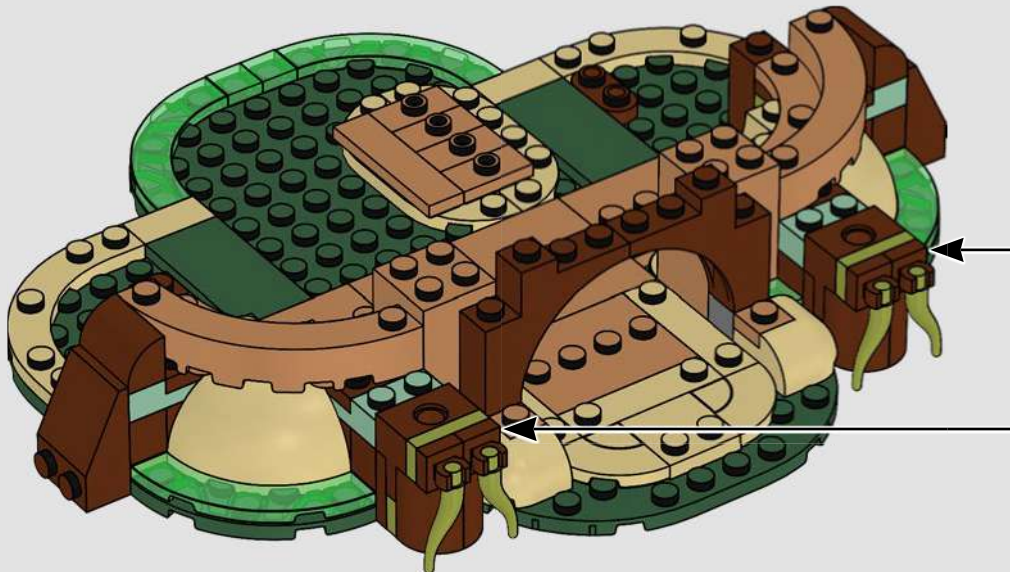
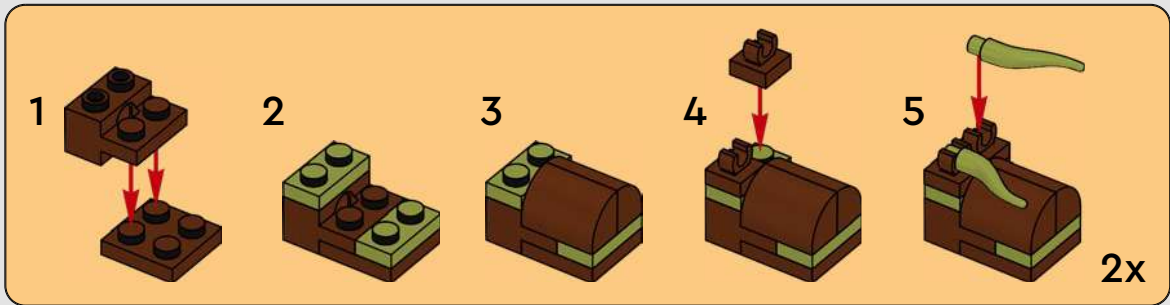



32

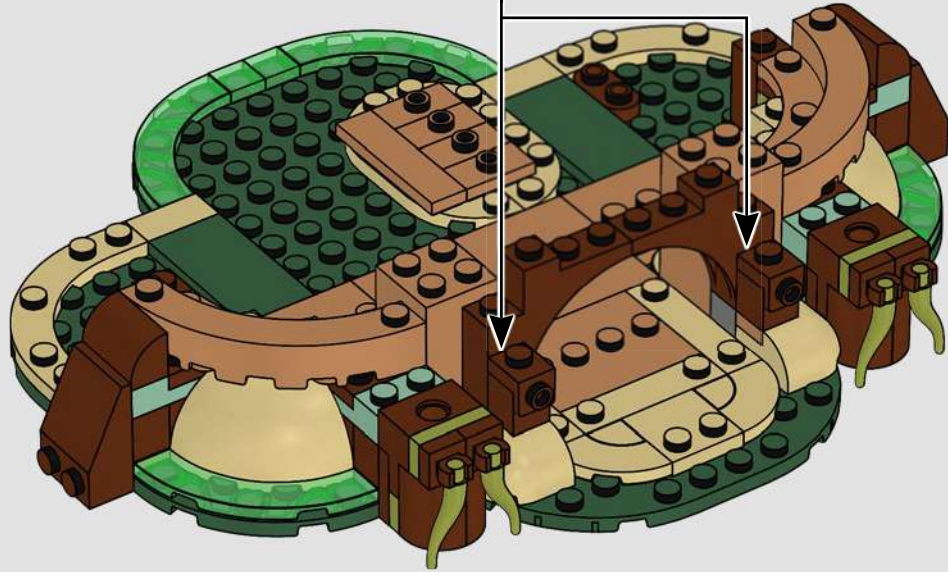
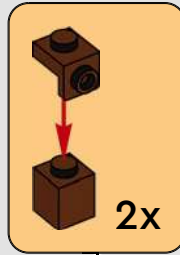



1x



1x

33

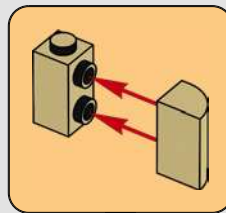



1x



1x

34

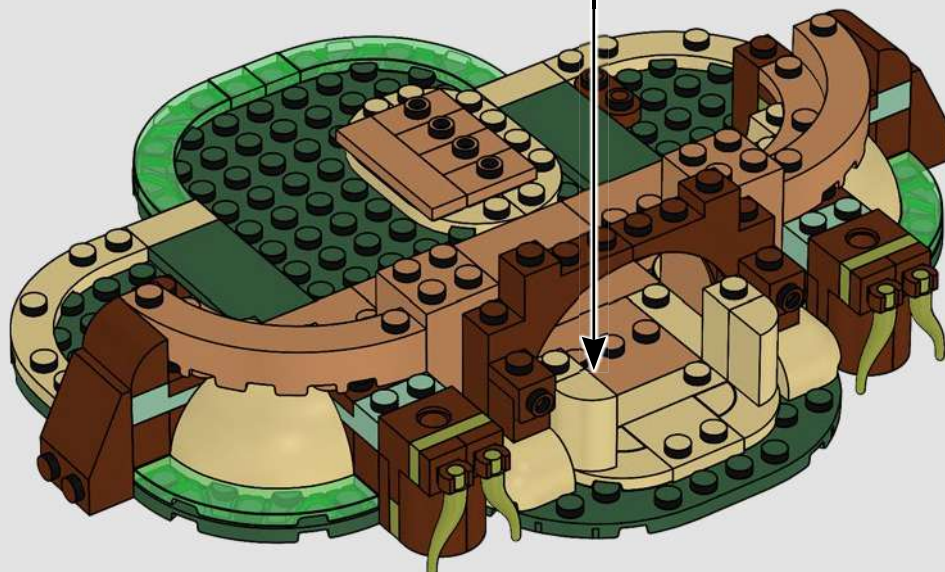
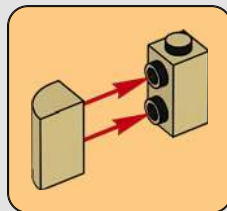



2x

35





2x

36





2x

37





38

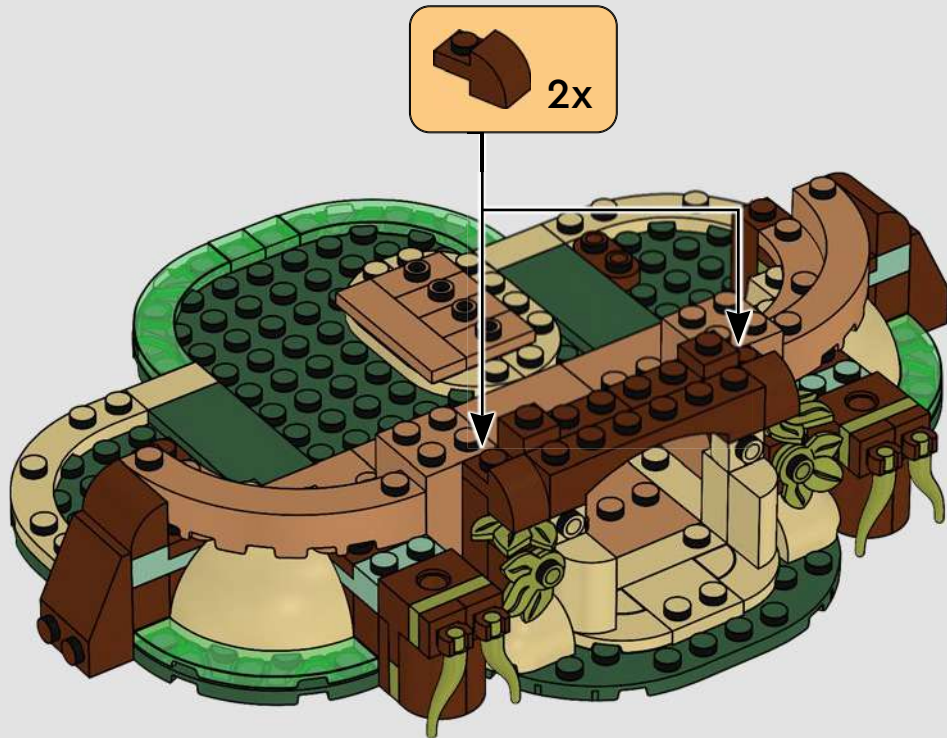



1x

39





2x

40

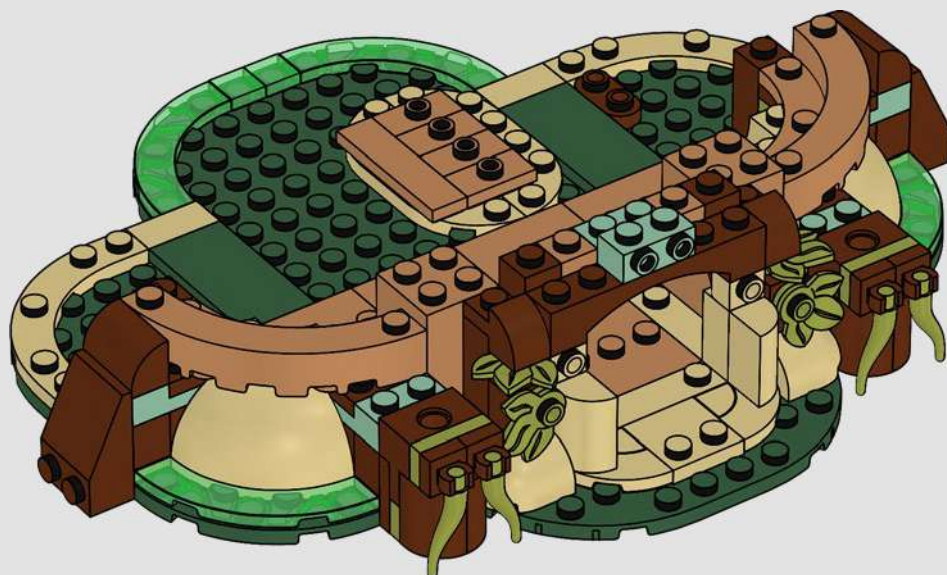



1x

41

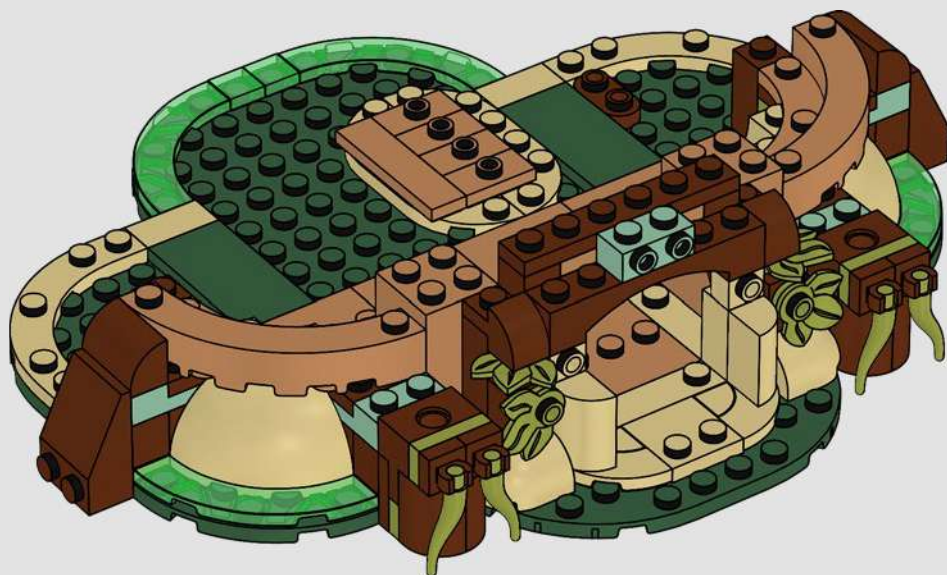



2x



1x

42

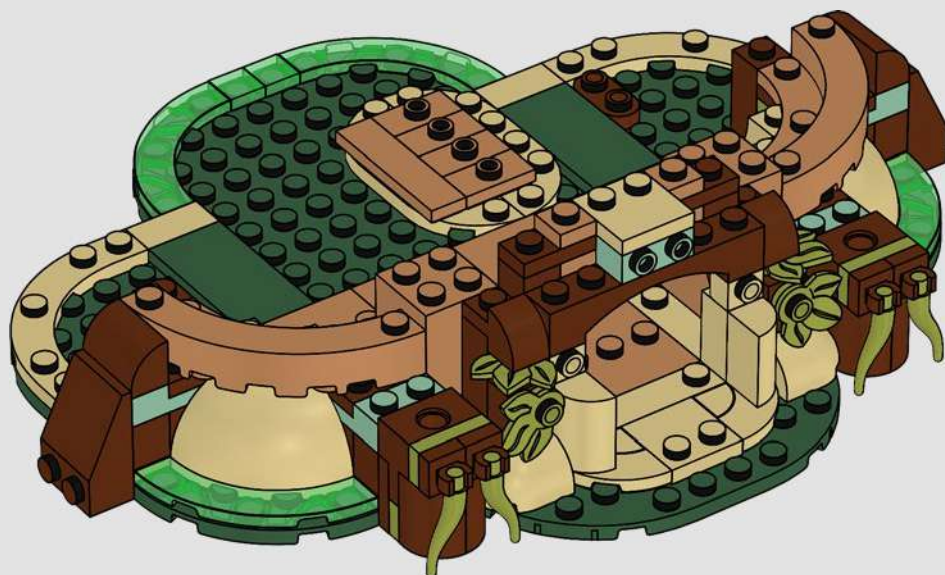



2x

43

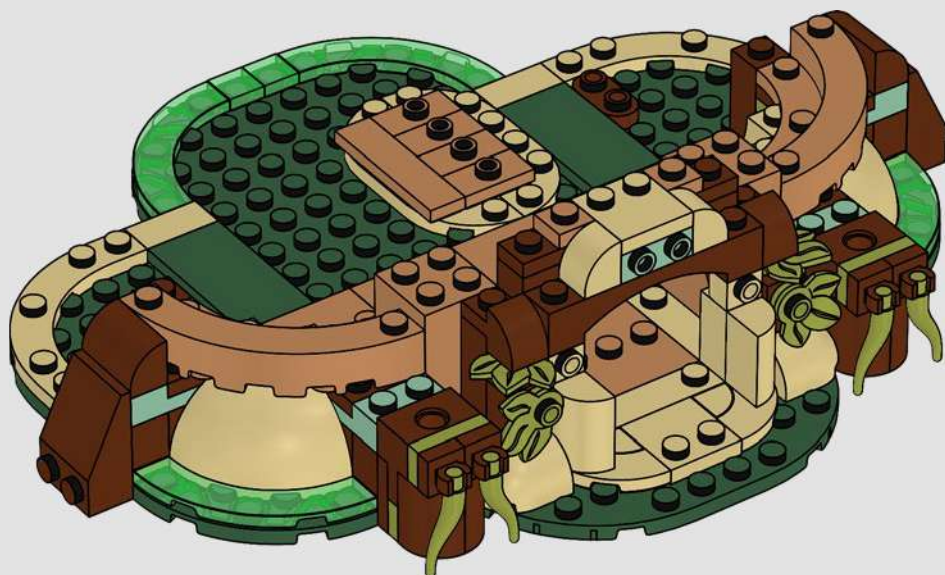



44

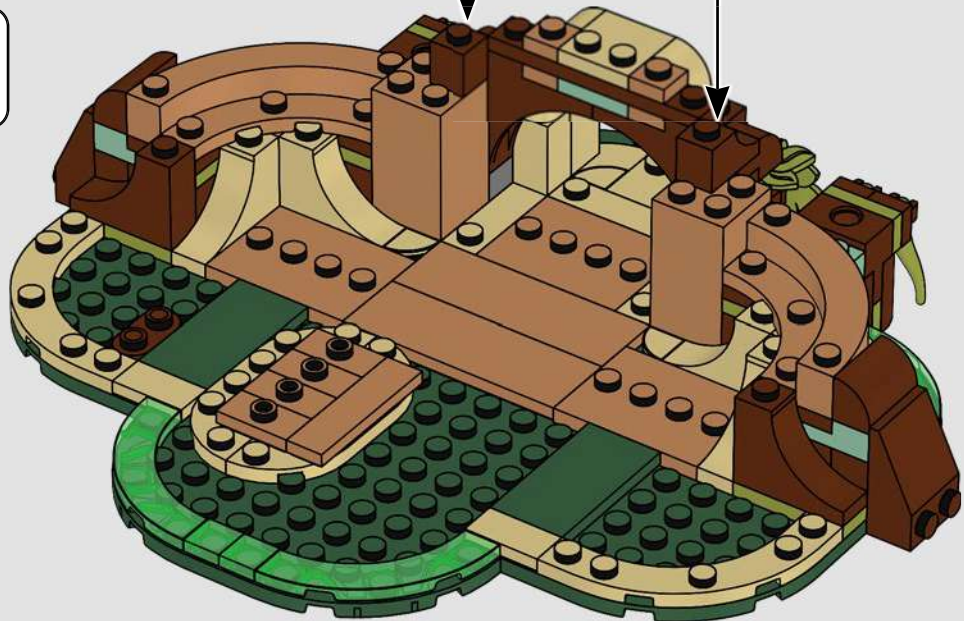



2x

45

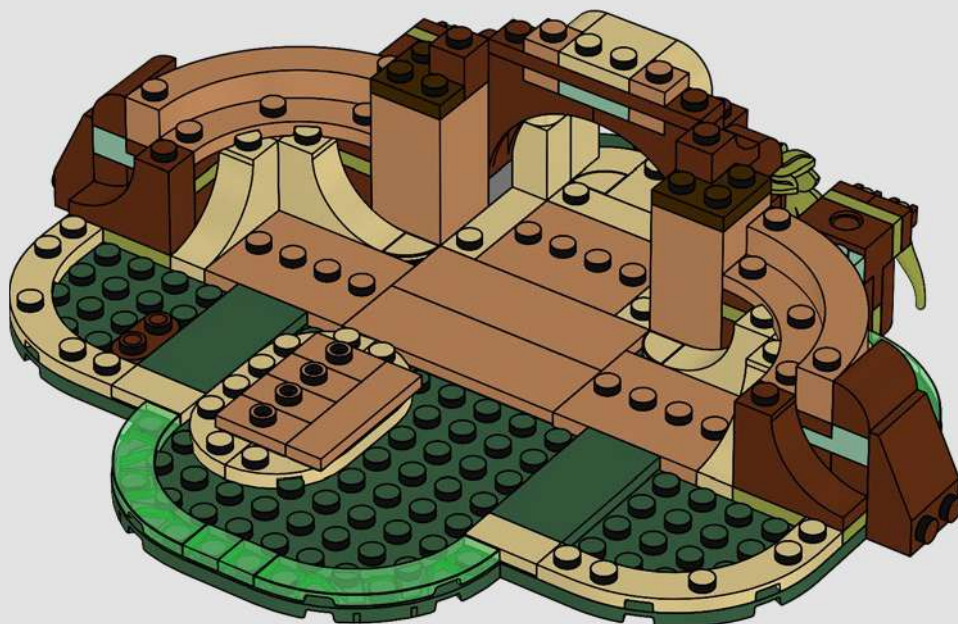

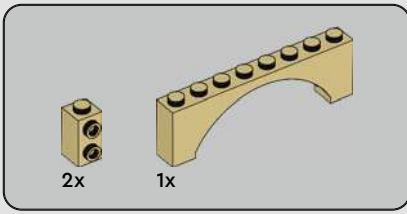

46

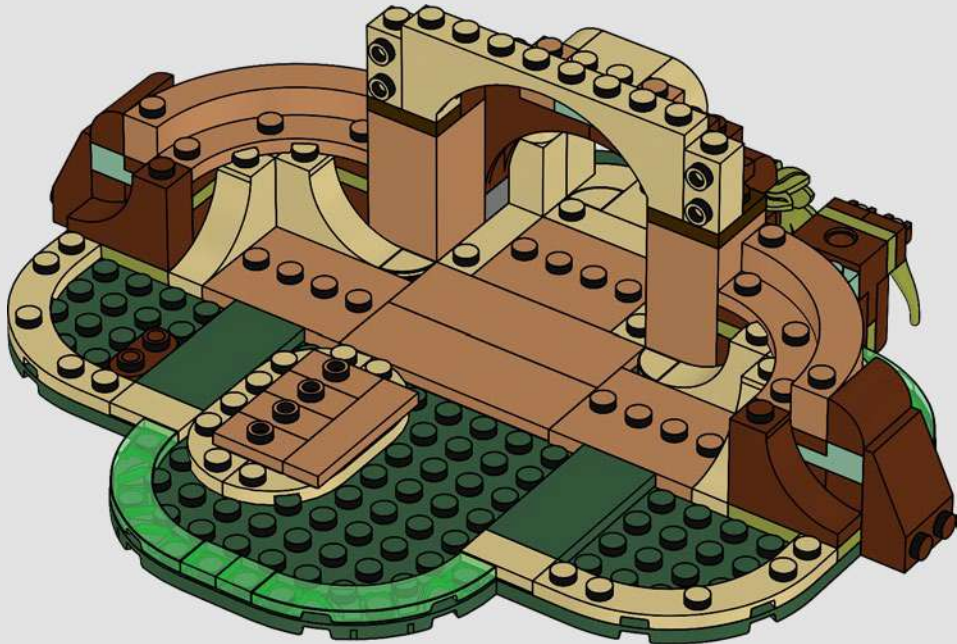

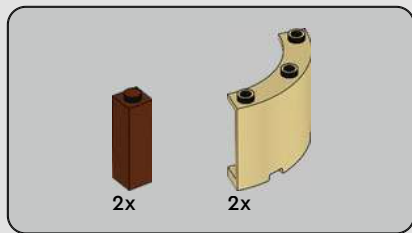

47

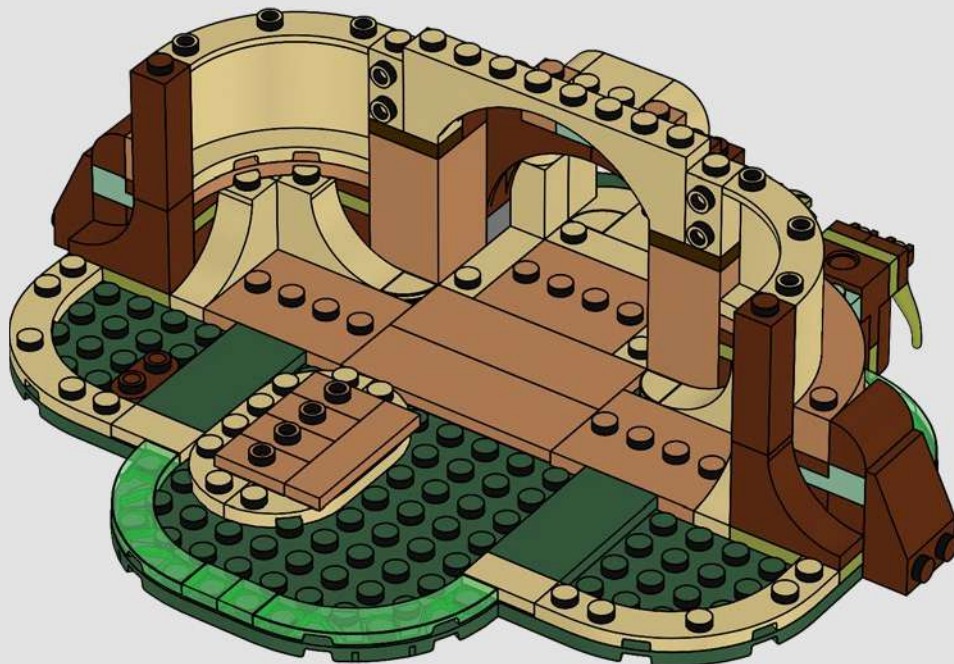

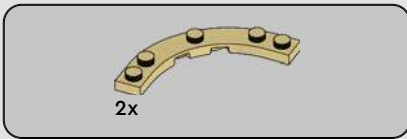

48

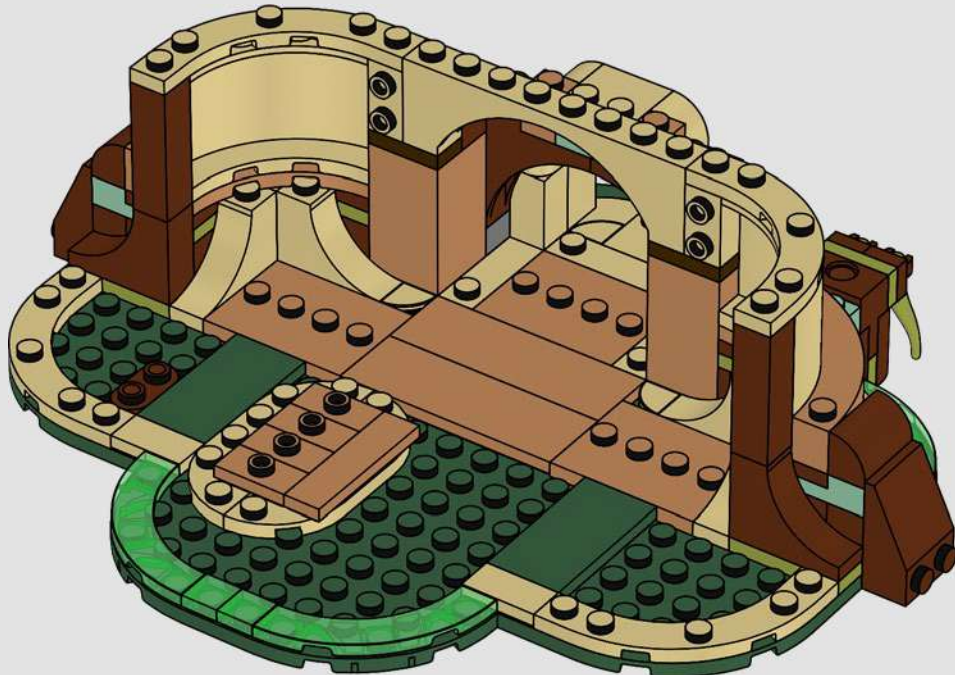

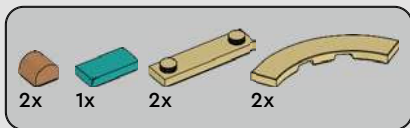

49

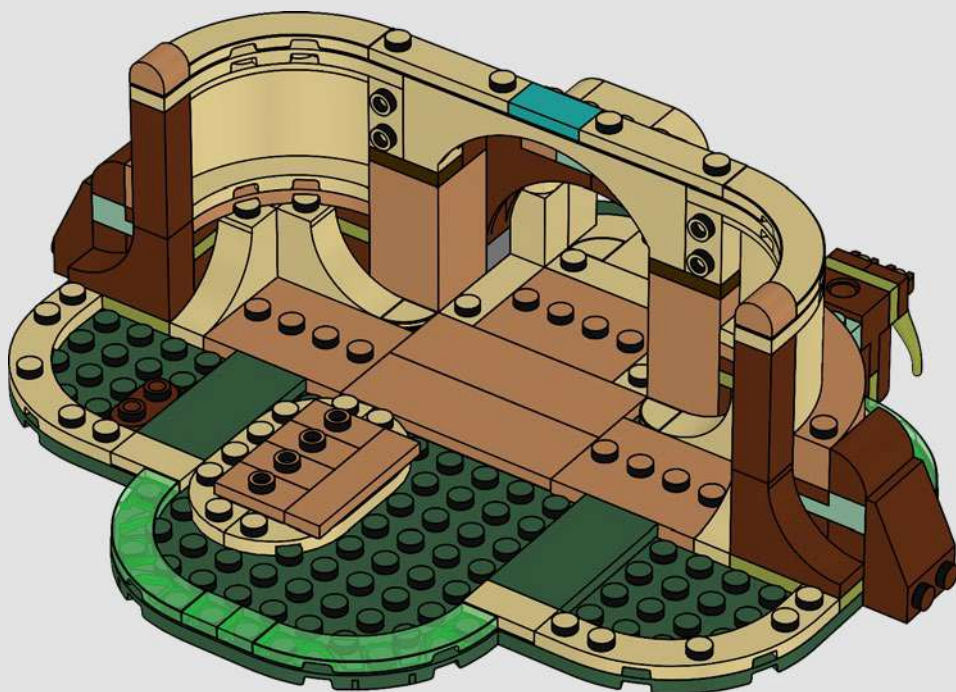



50

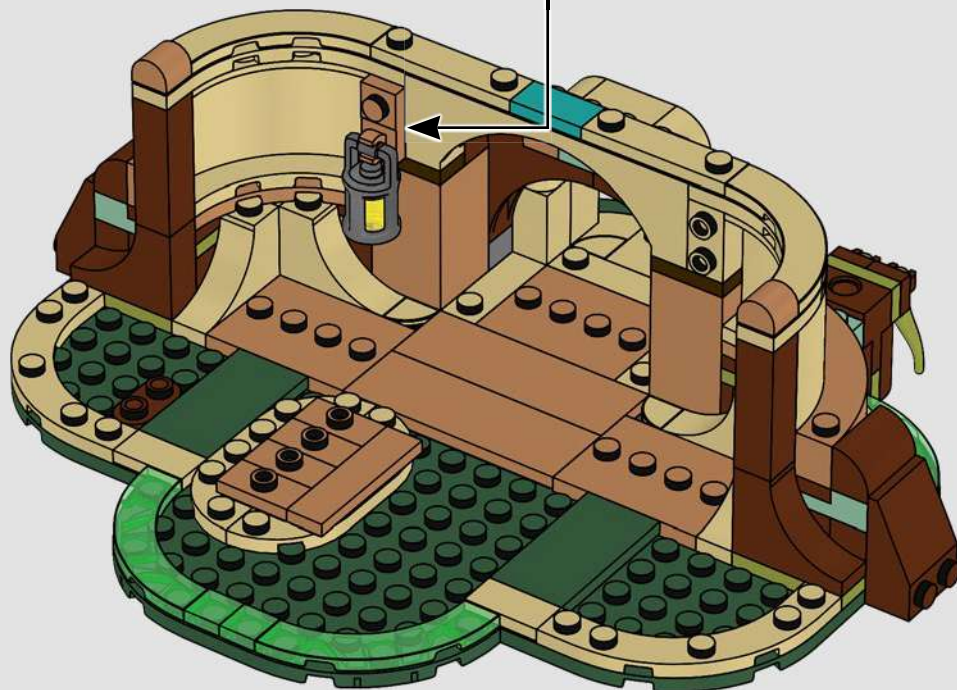
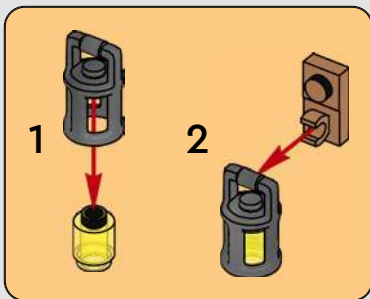

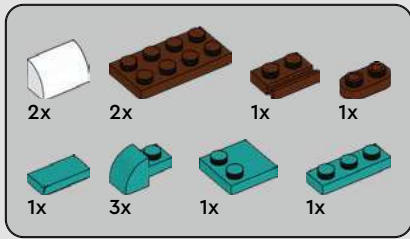

51

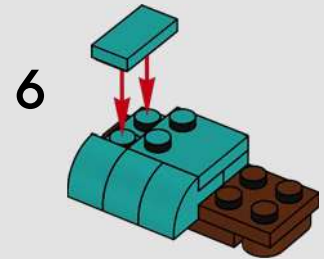
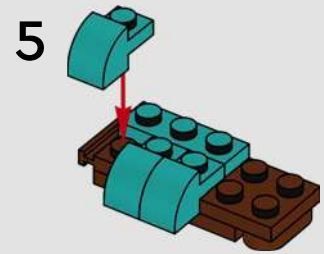
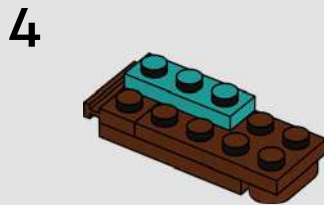
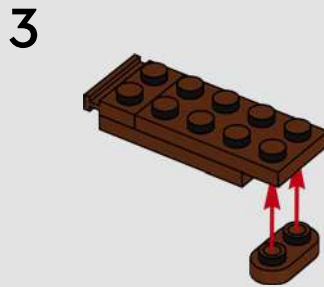
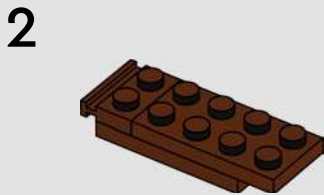
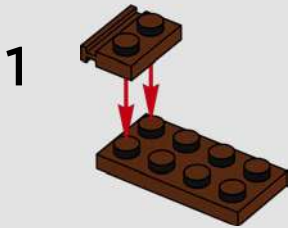

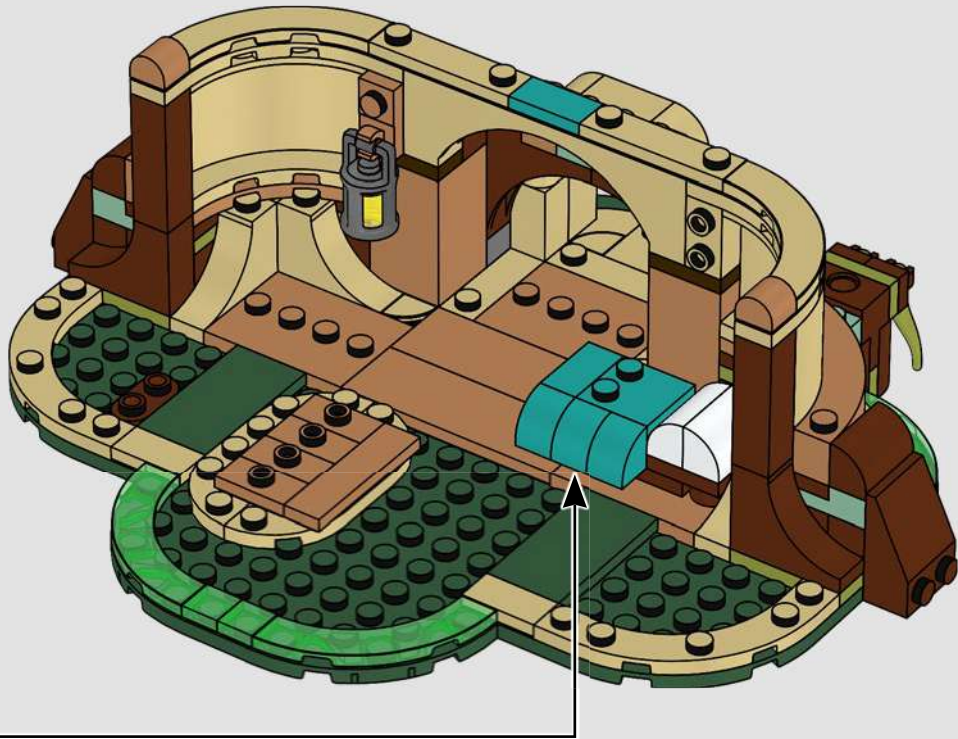

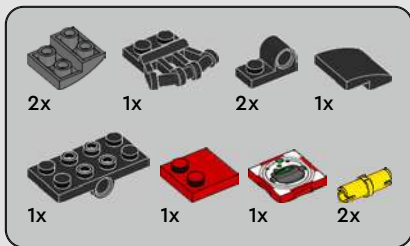

# 52

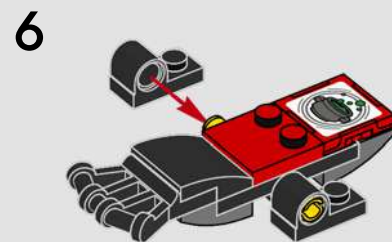
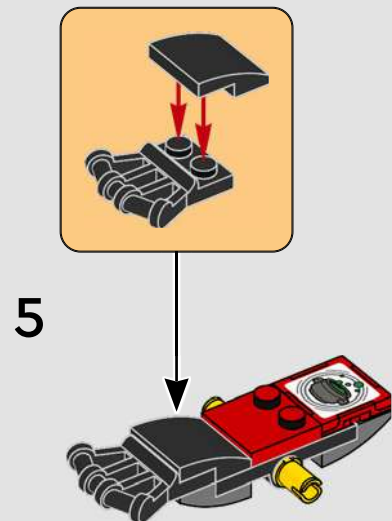
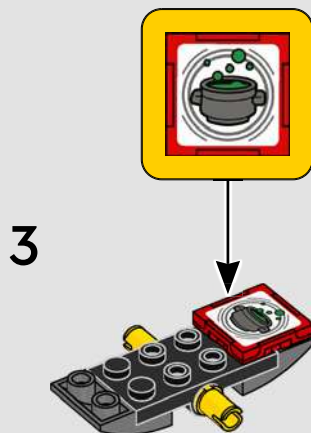
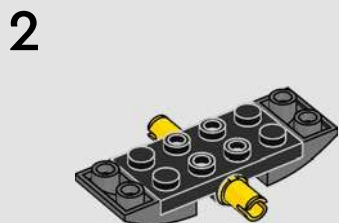
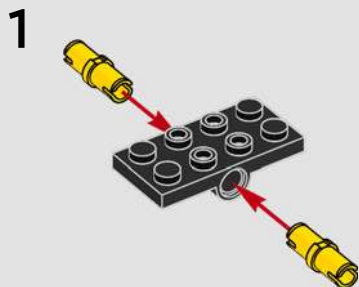

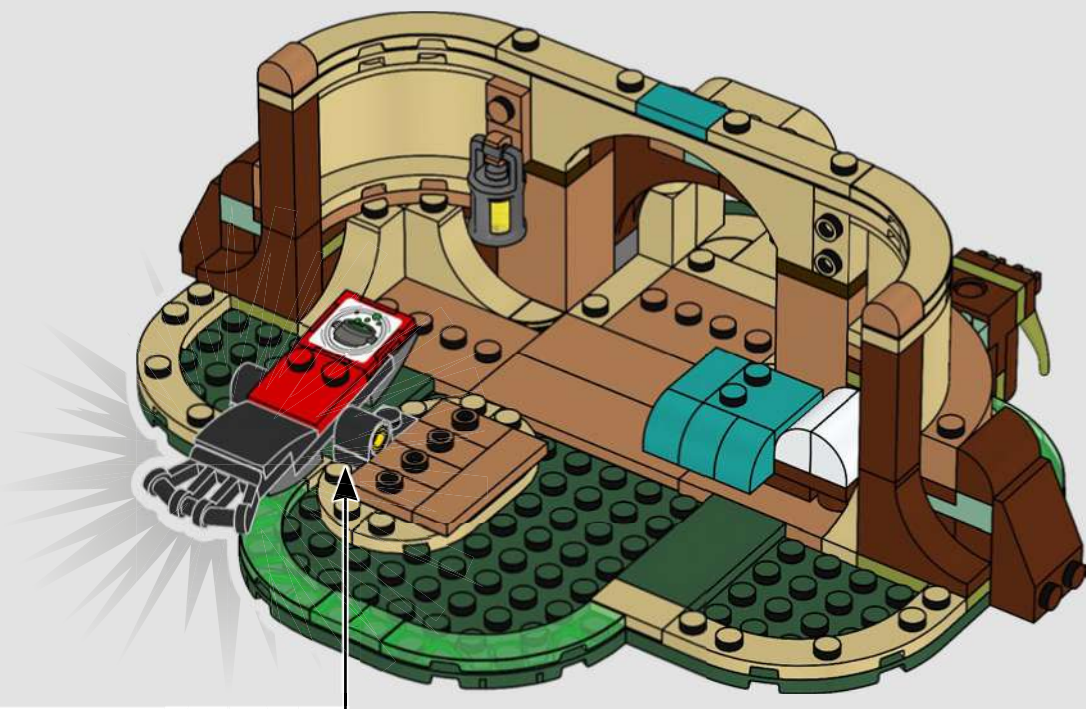



1x

53

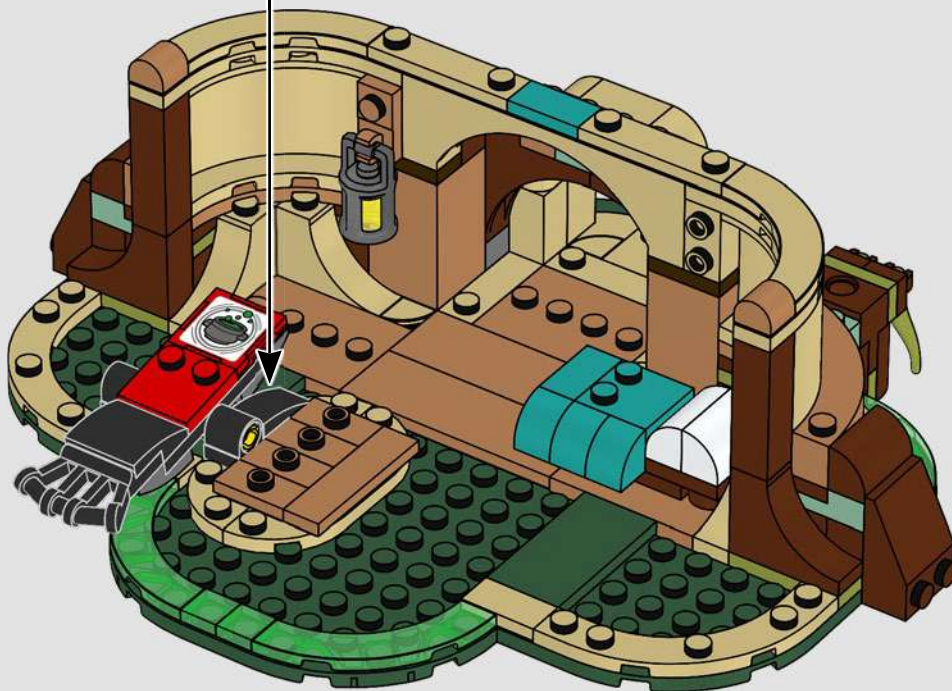

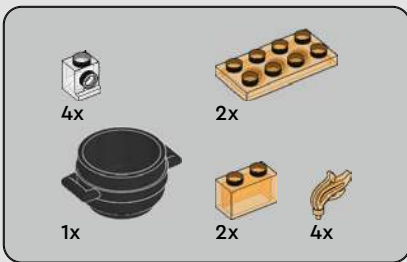

54

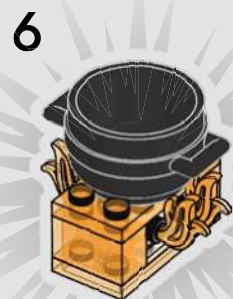
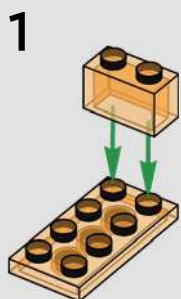

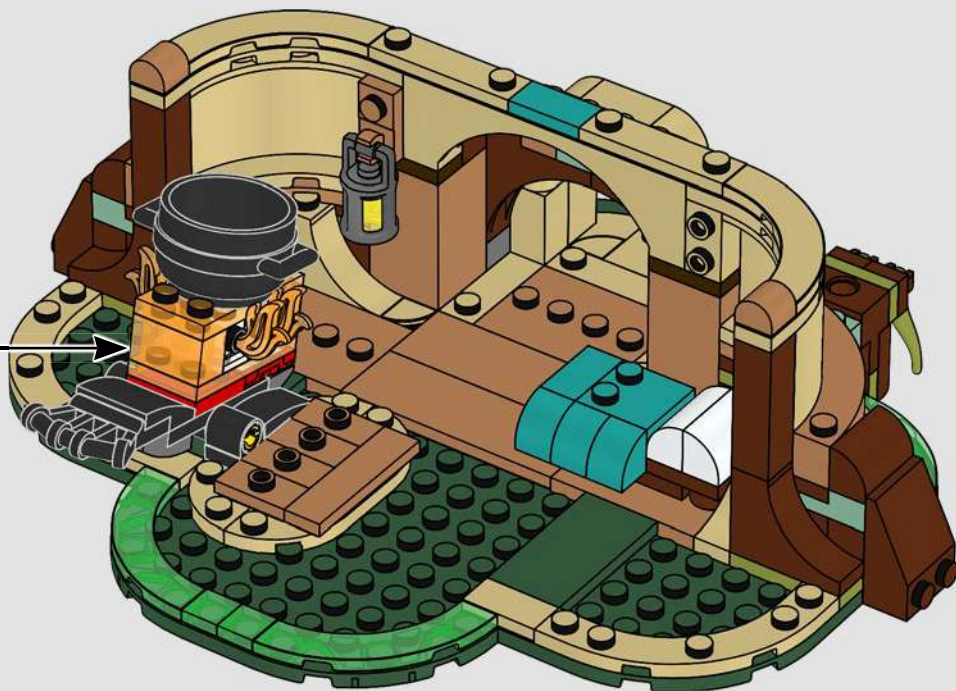

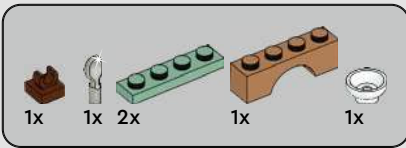

55

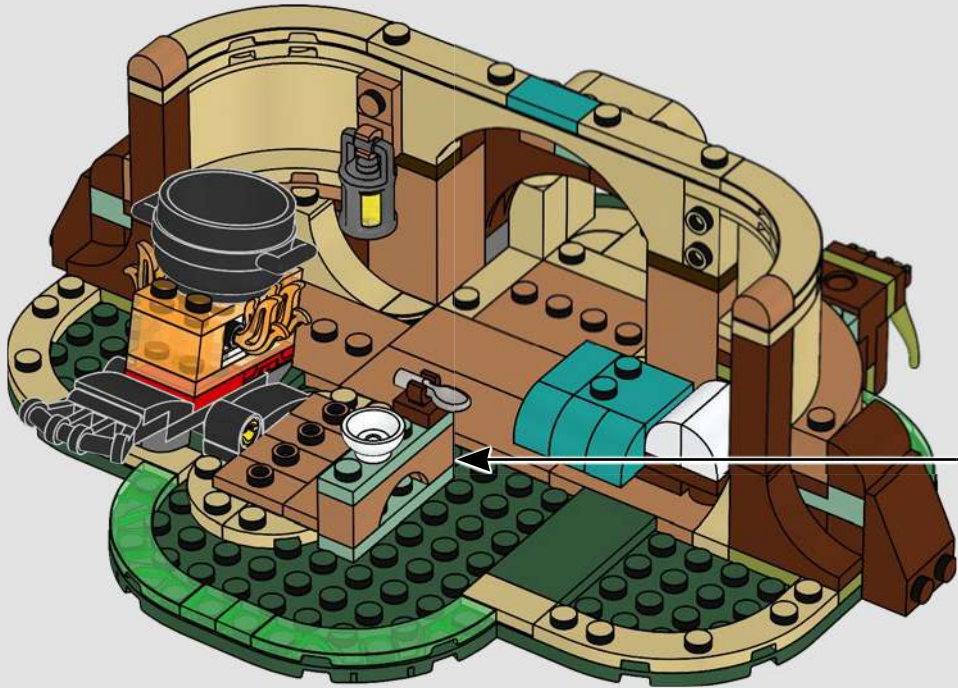
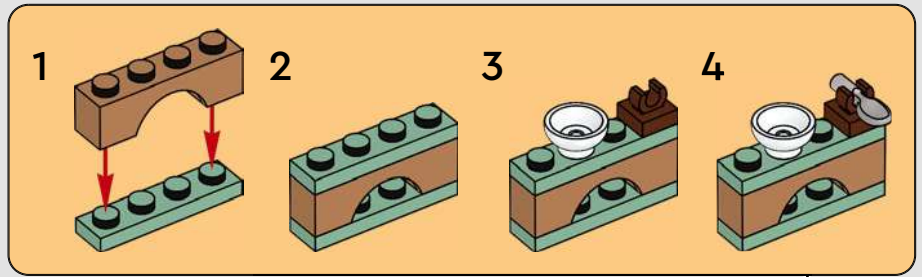



56

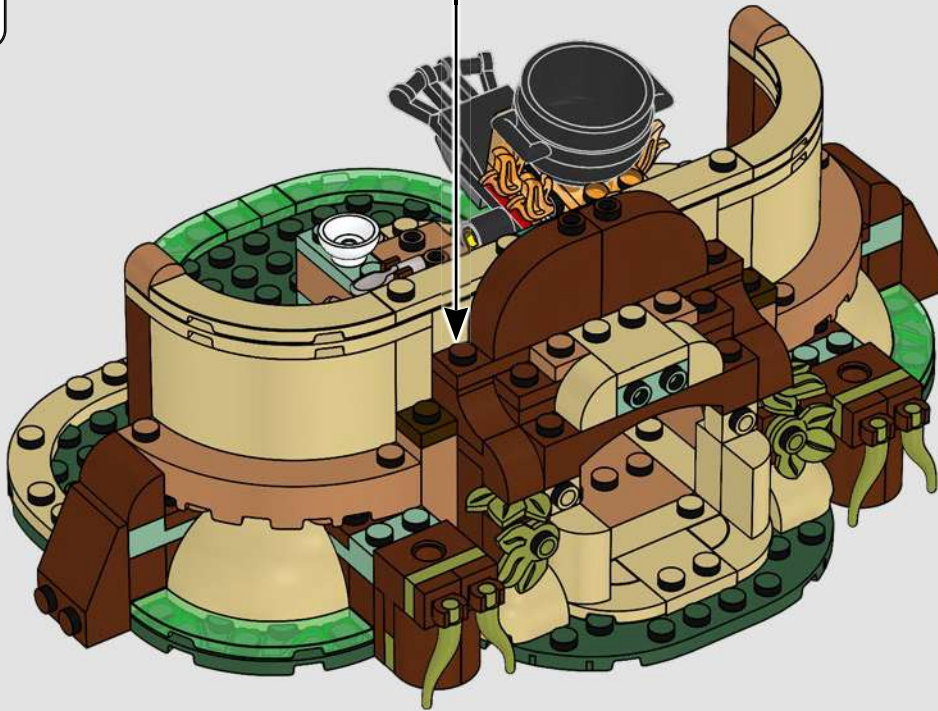
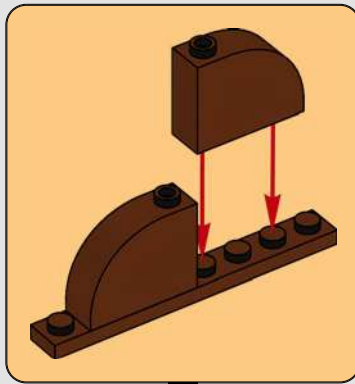

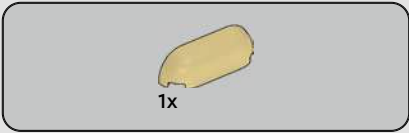

57

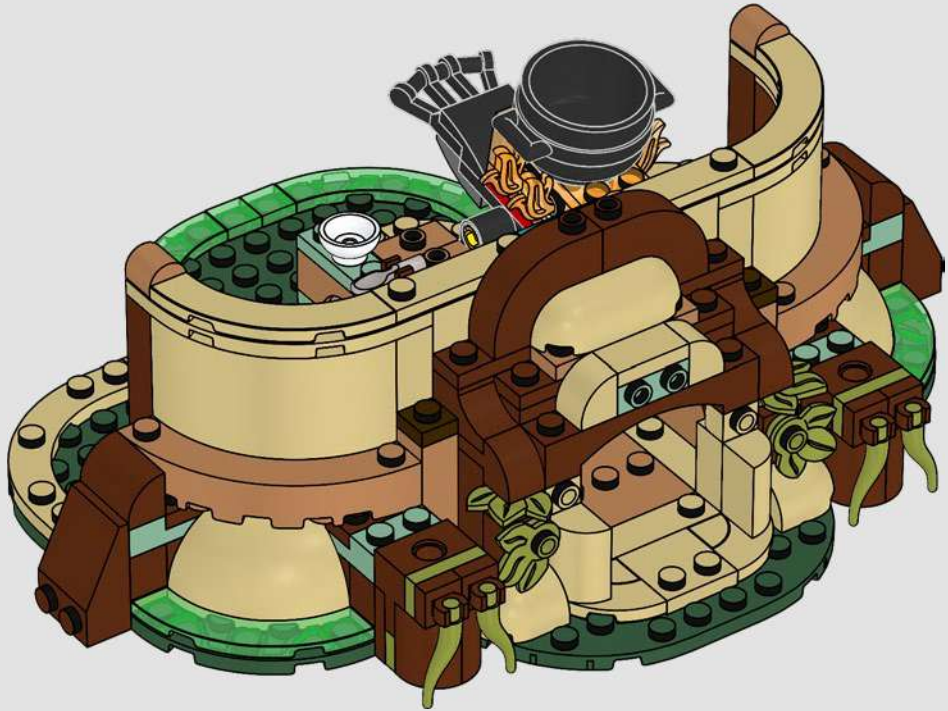



2x

58

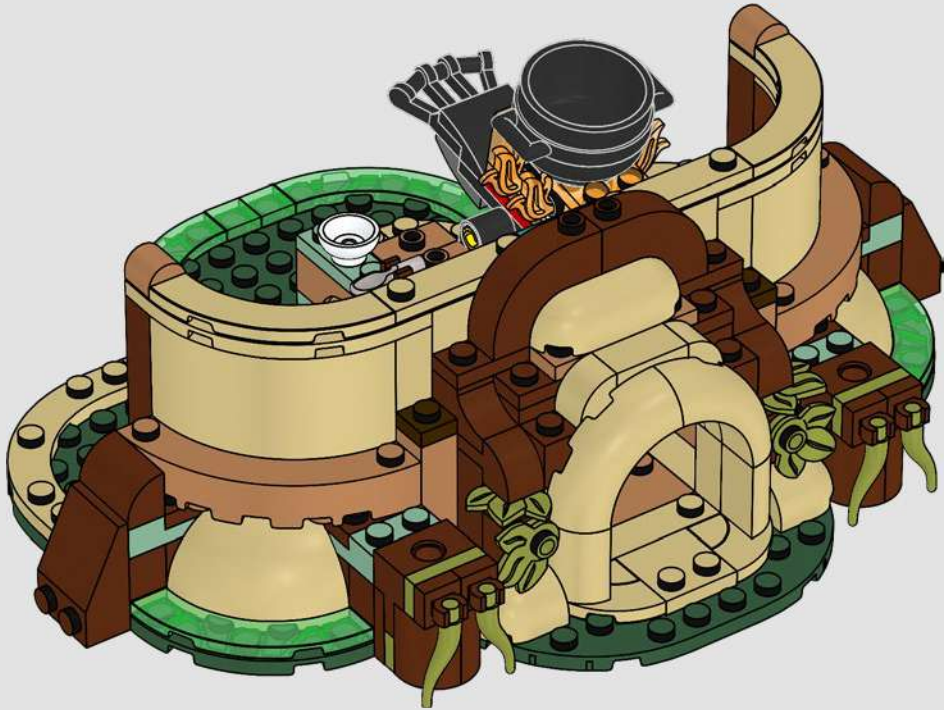

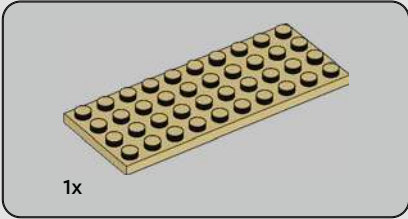
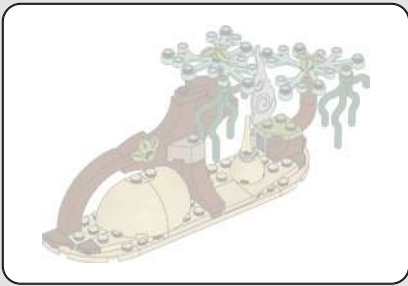

59

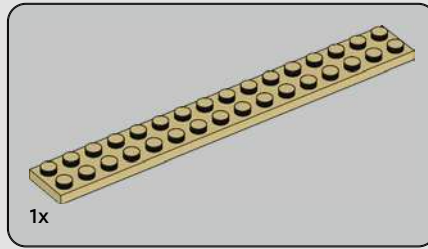
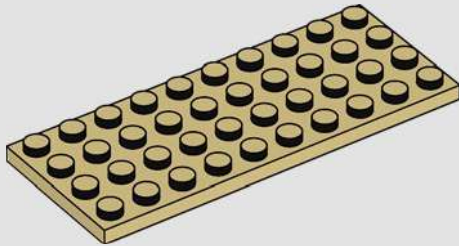

60

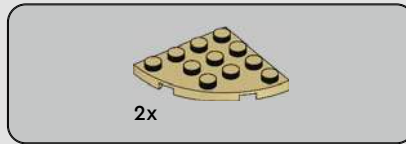
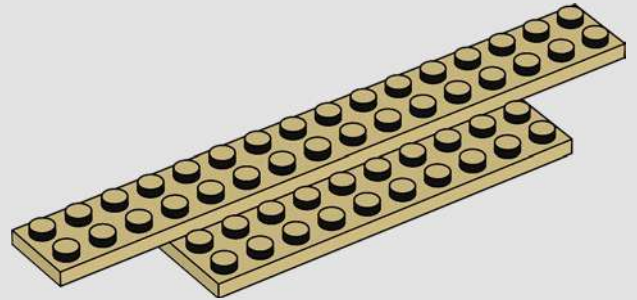

61

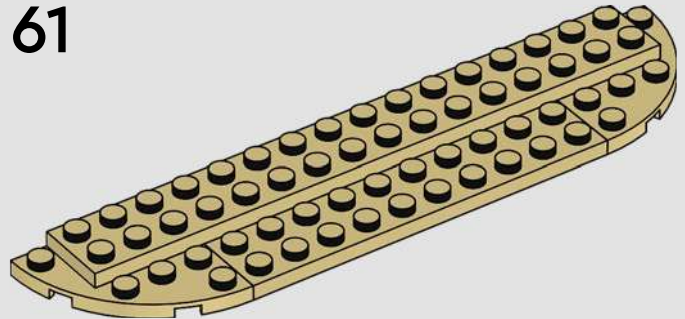



1x



1x

# 62

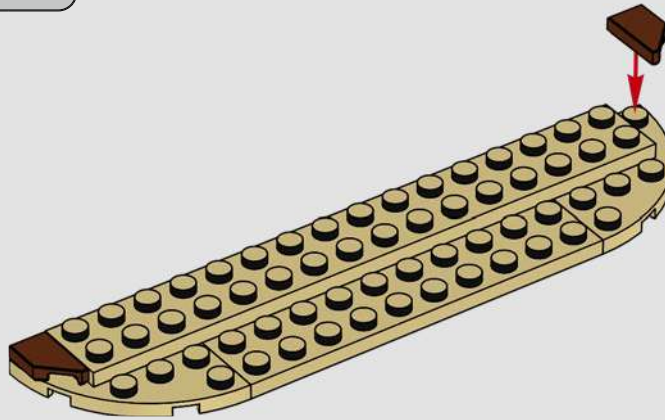

2x



1x



1x



1x



1x



1x

# 63

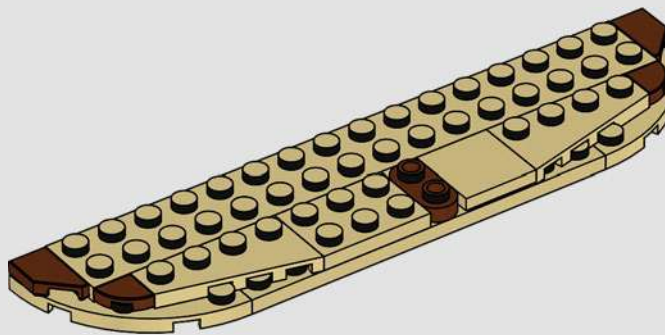

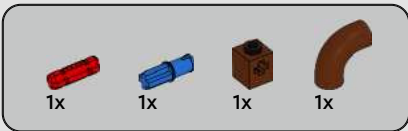

64

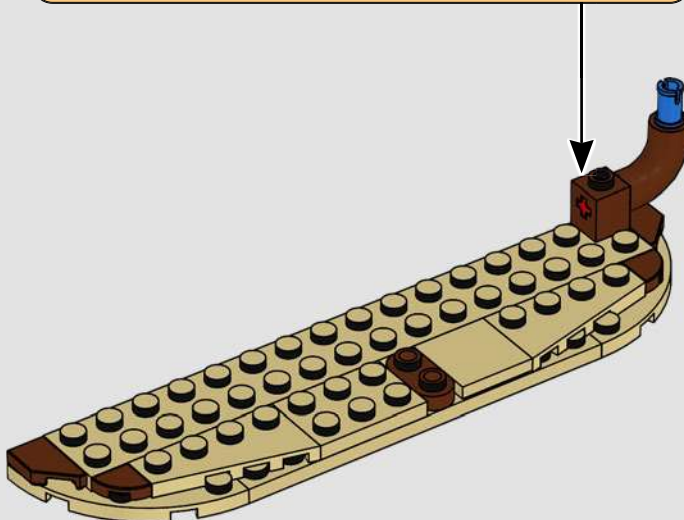
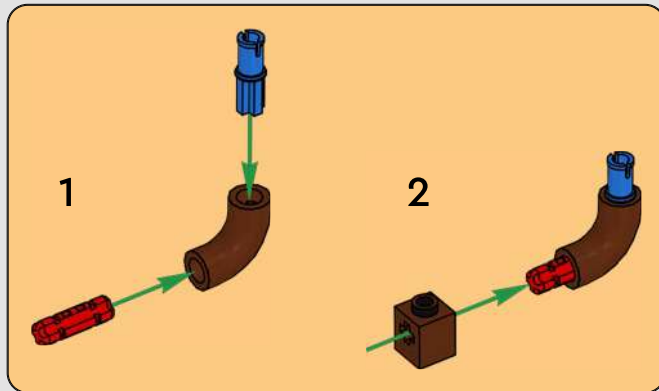



65

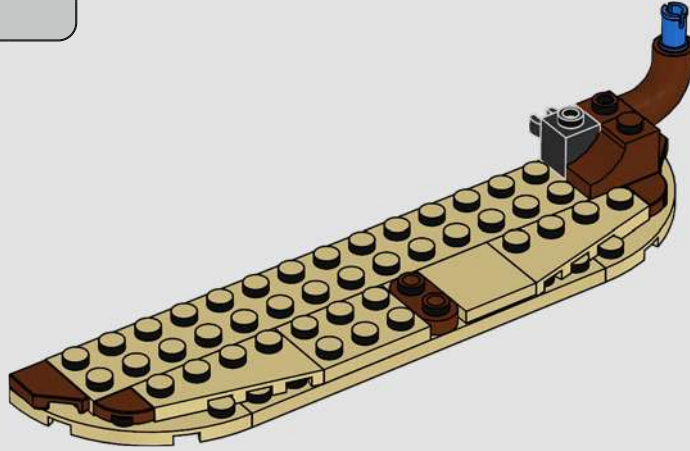

66

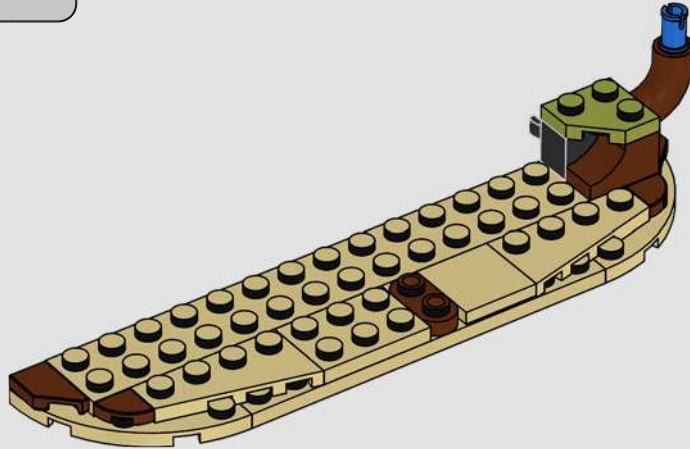



67

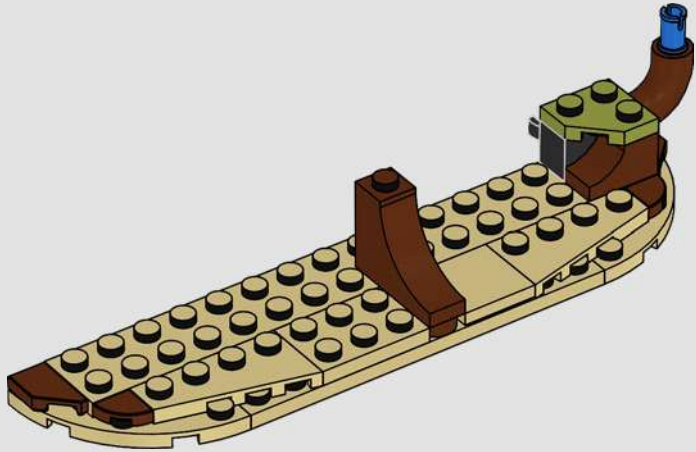

68

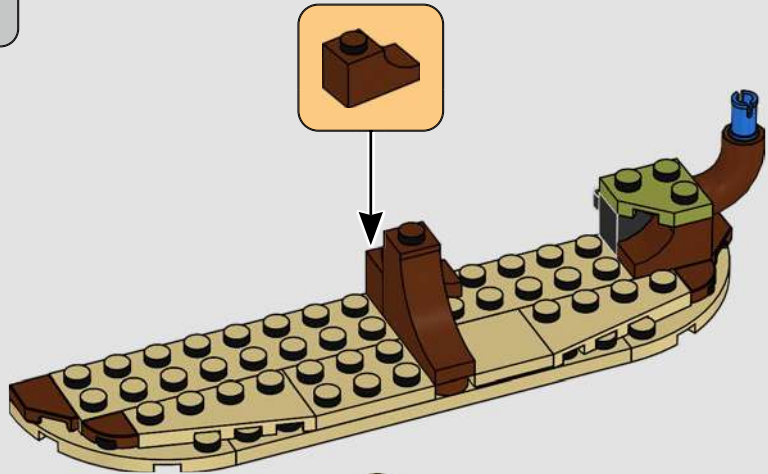

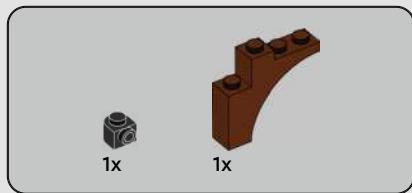

69

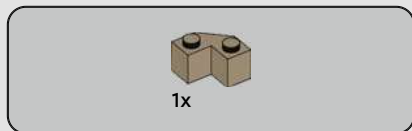
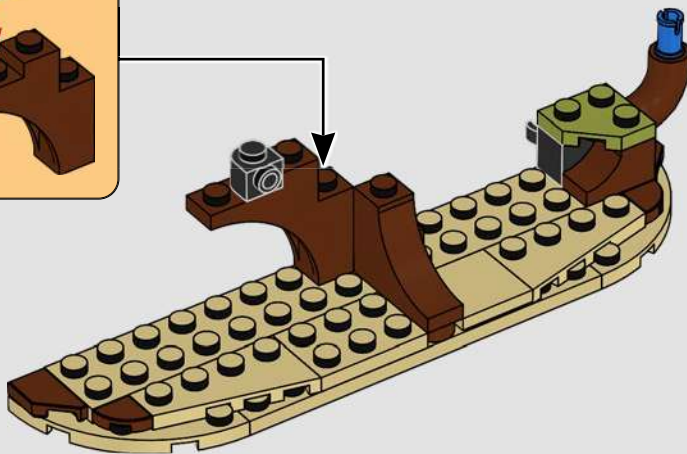
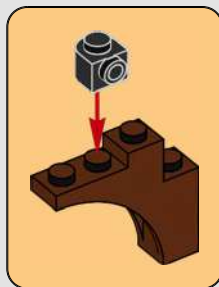

70

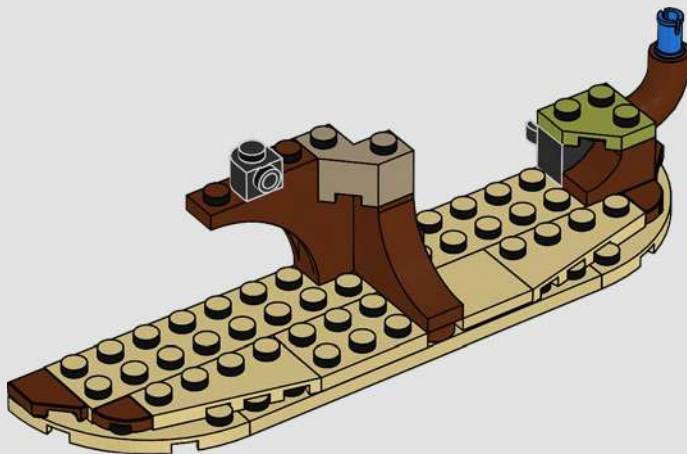

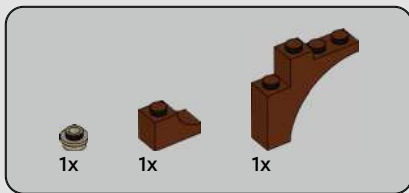

71

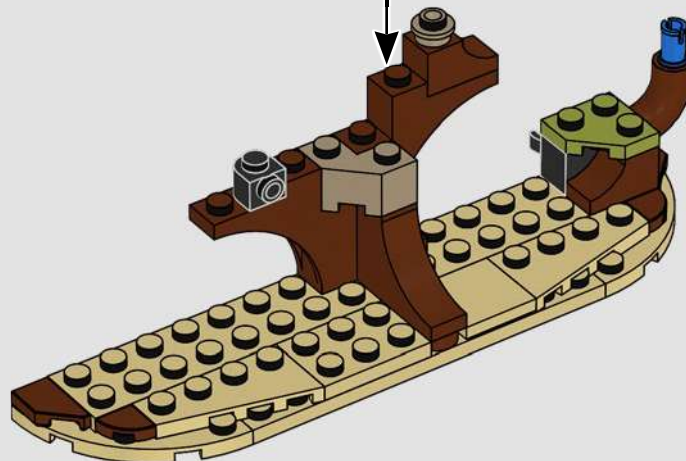
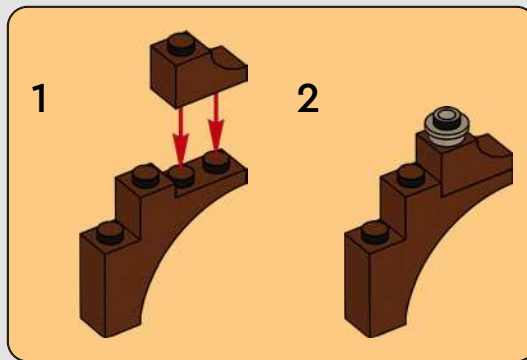

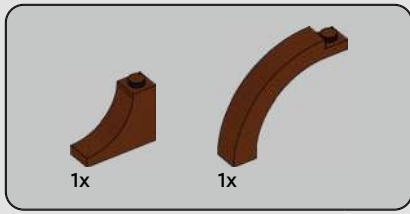

72

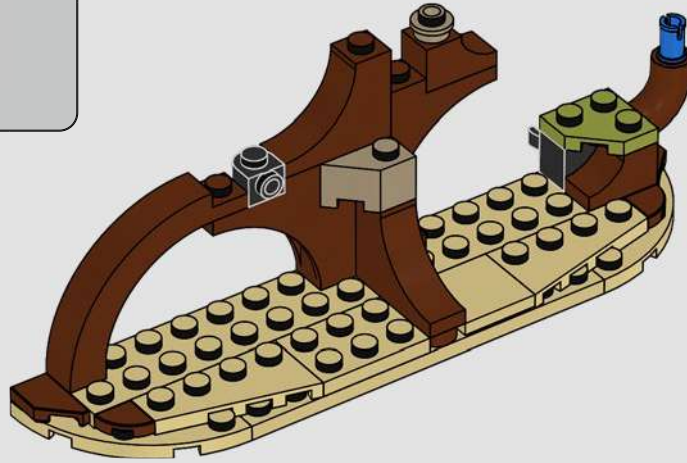

73

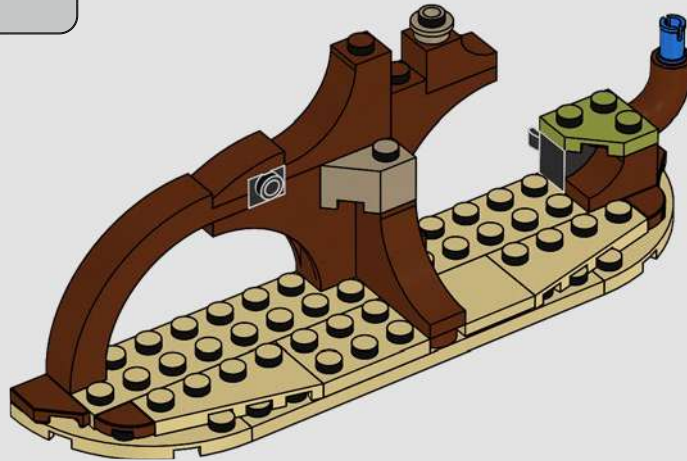

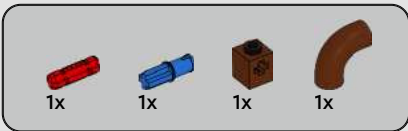

74

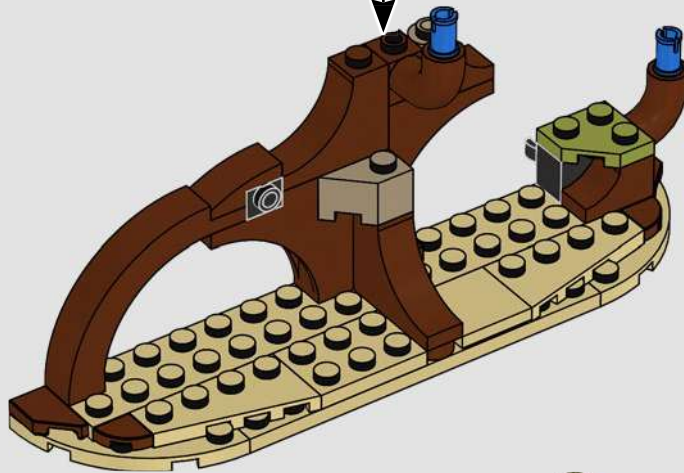
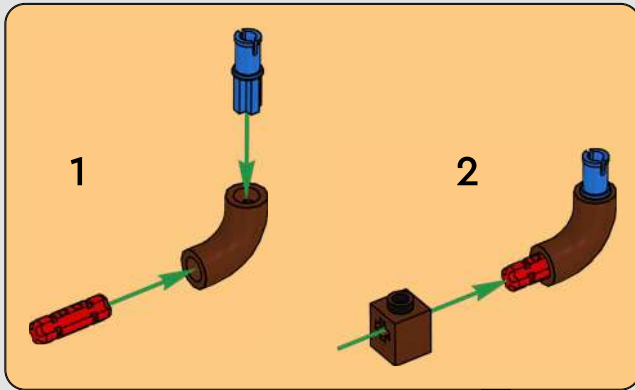



75

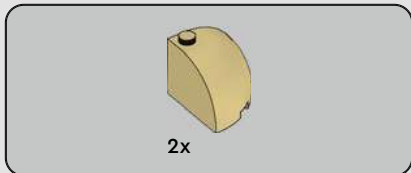
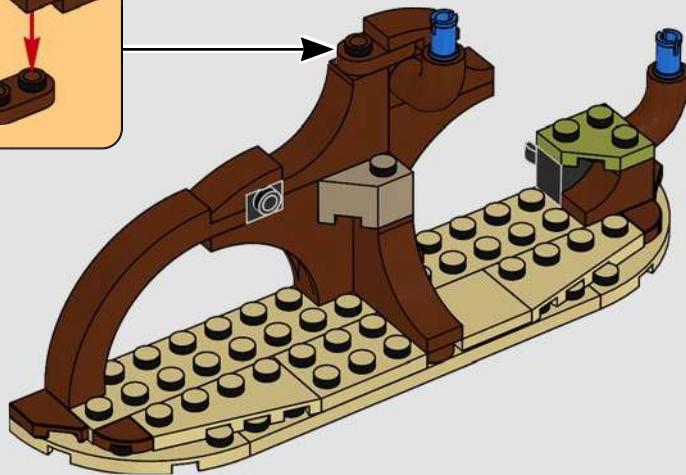

76

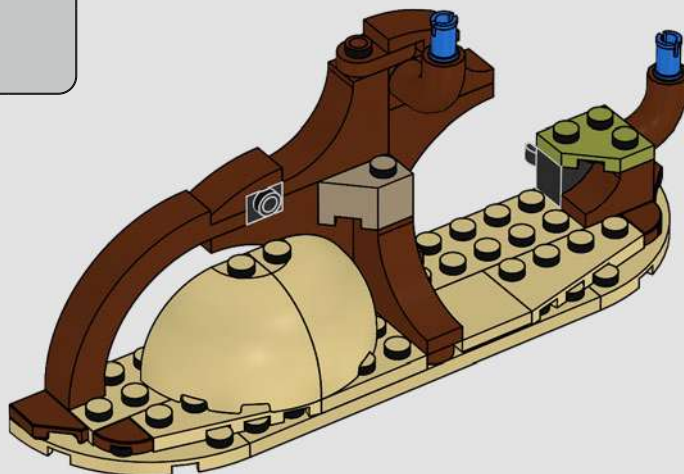

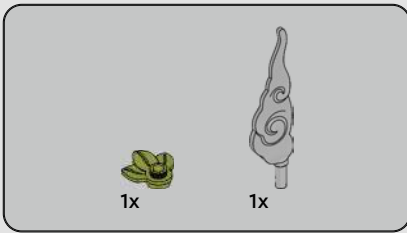

77

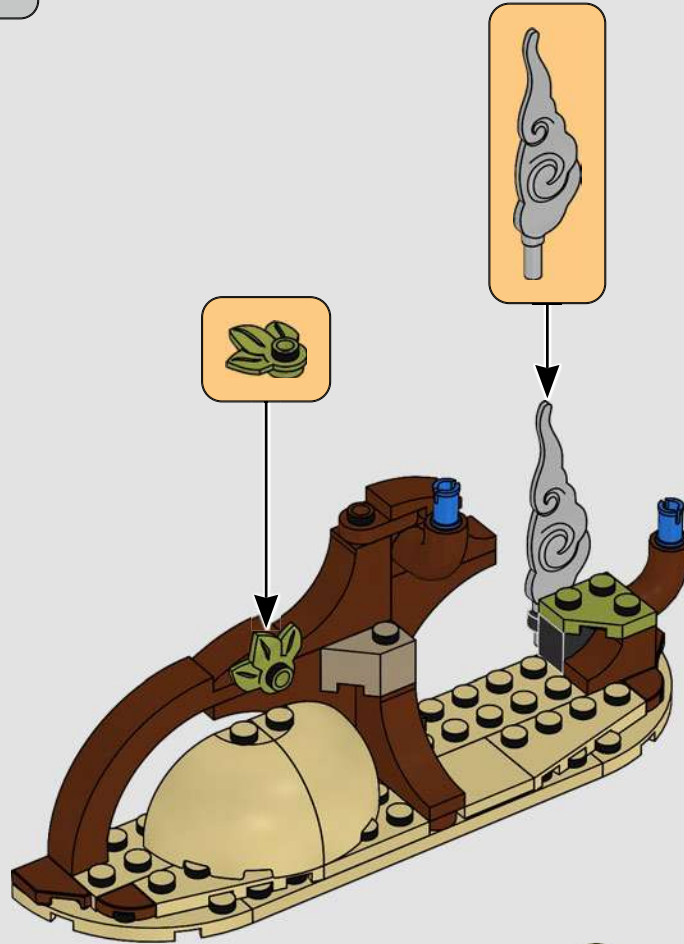

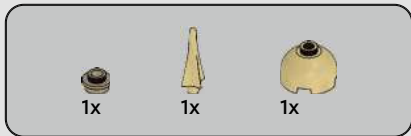

78

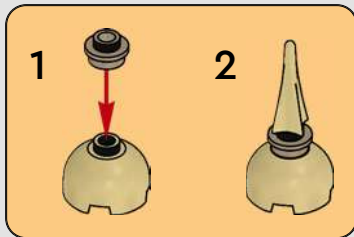

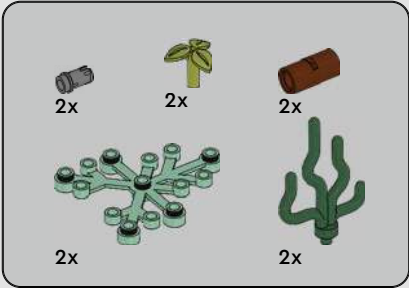

79

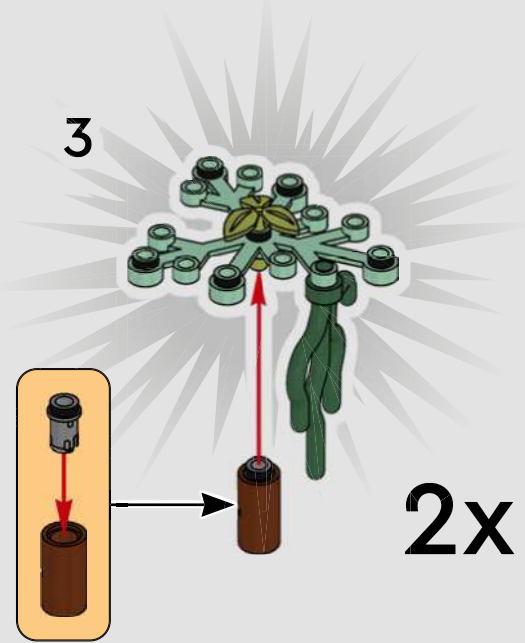
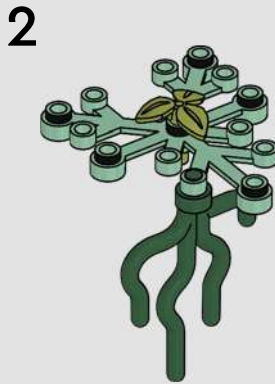
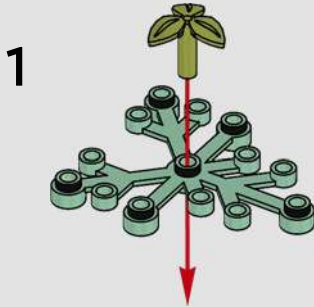

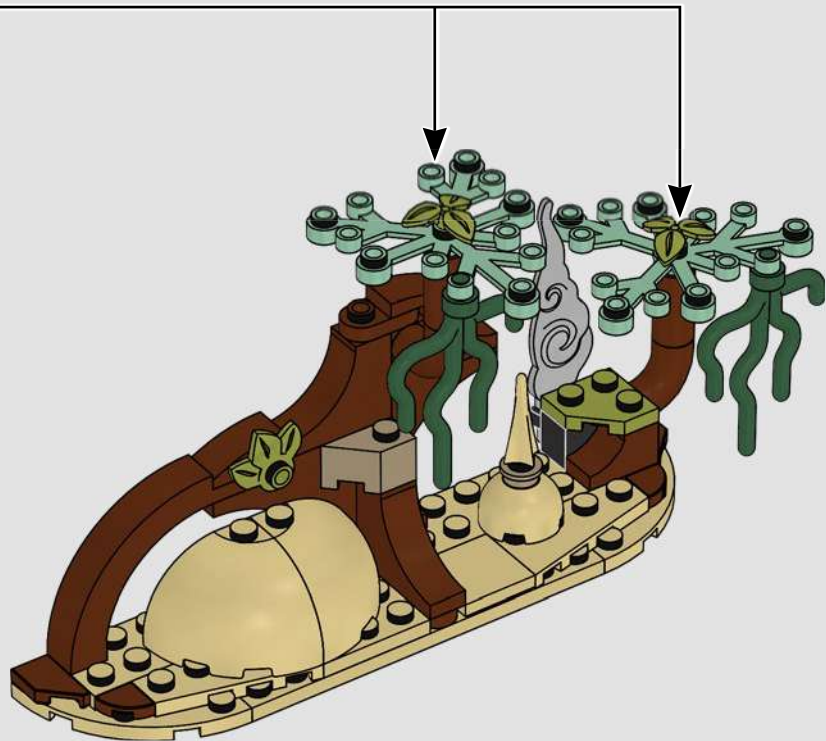

80

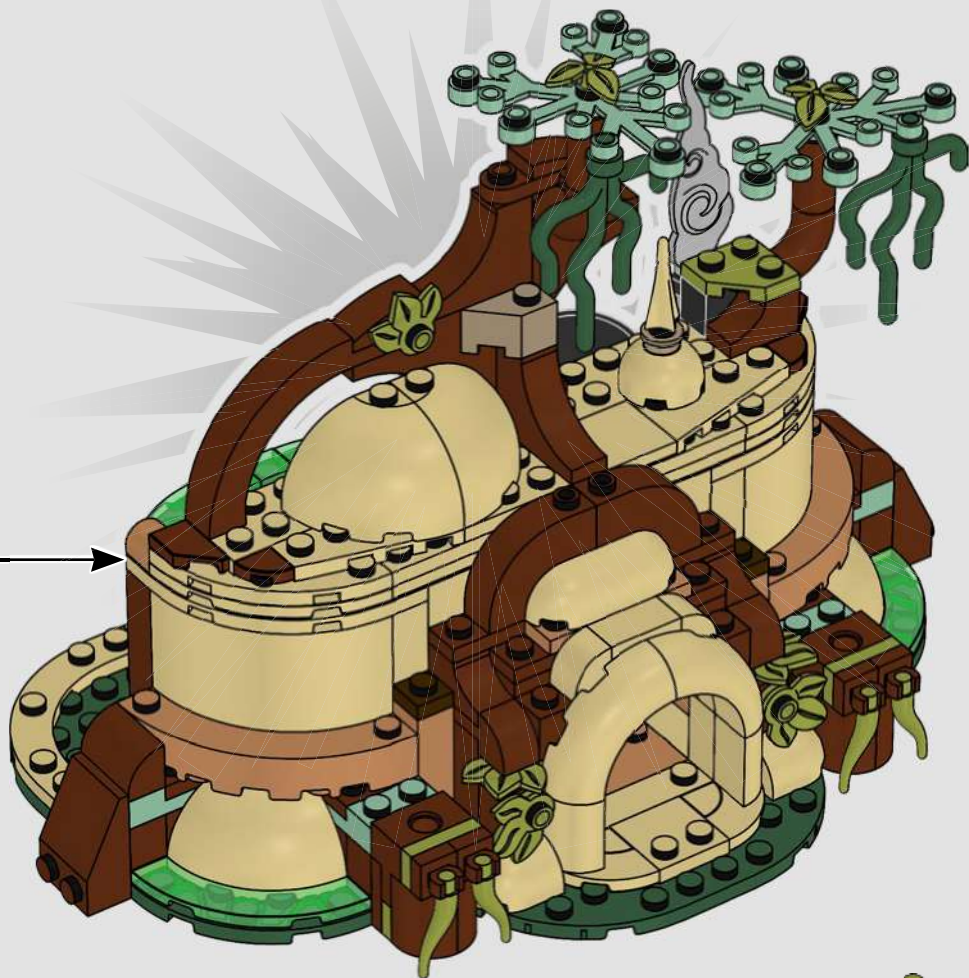

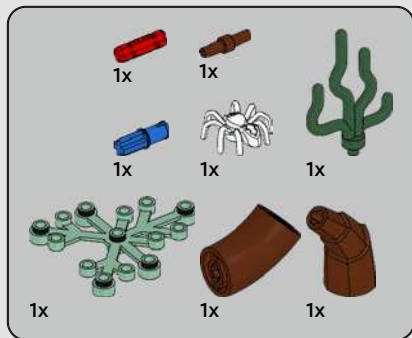

81

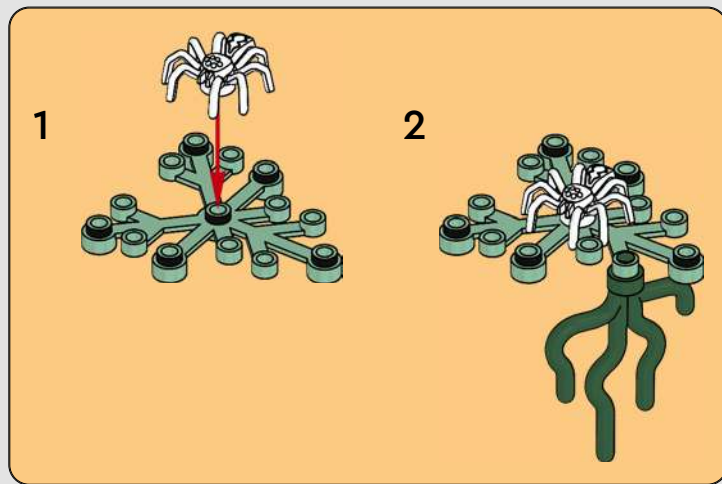

1

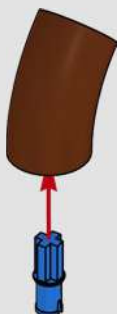

2



3



4



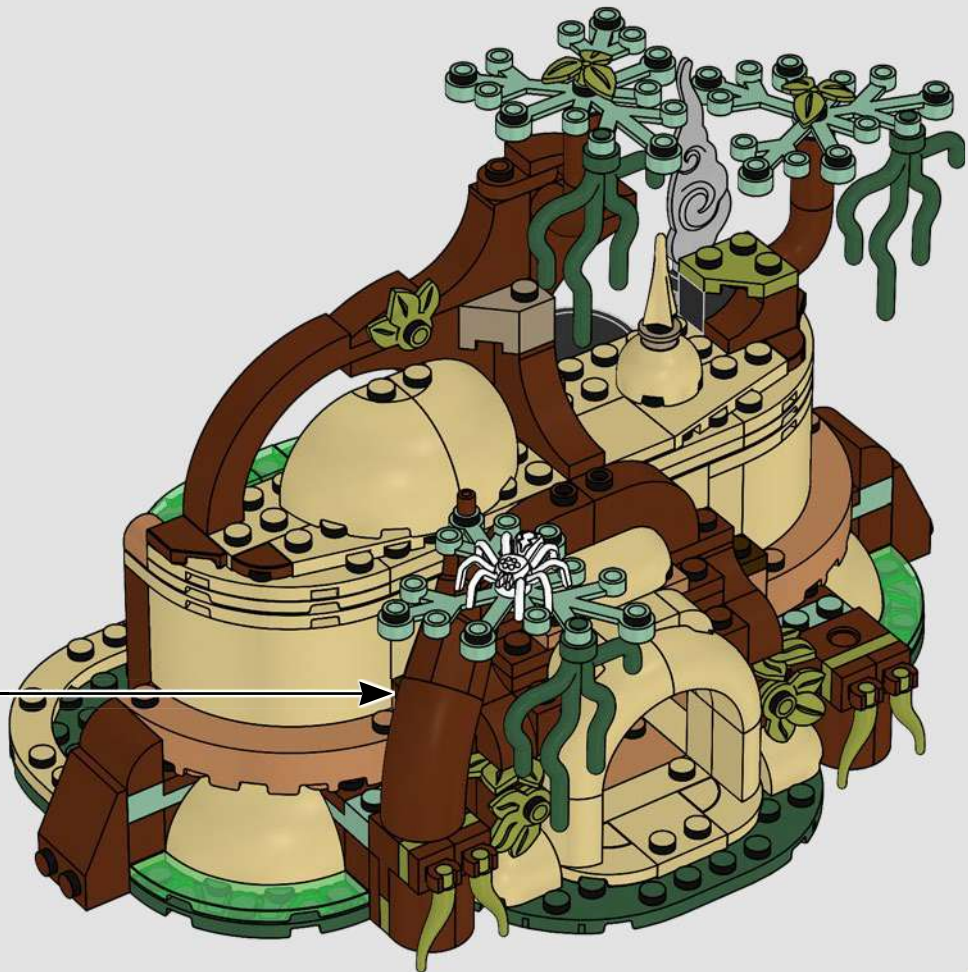



1x

82

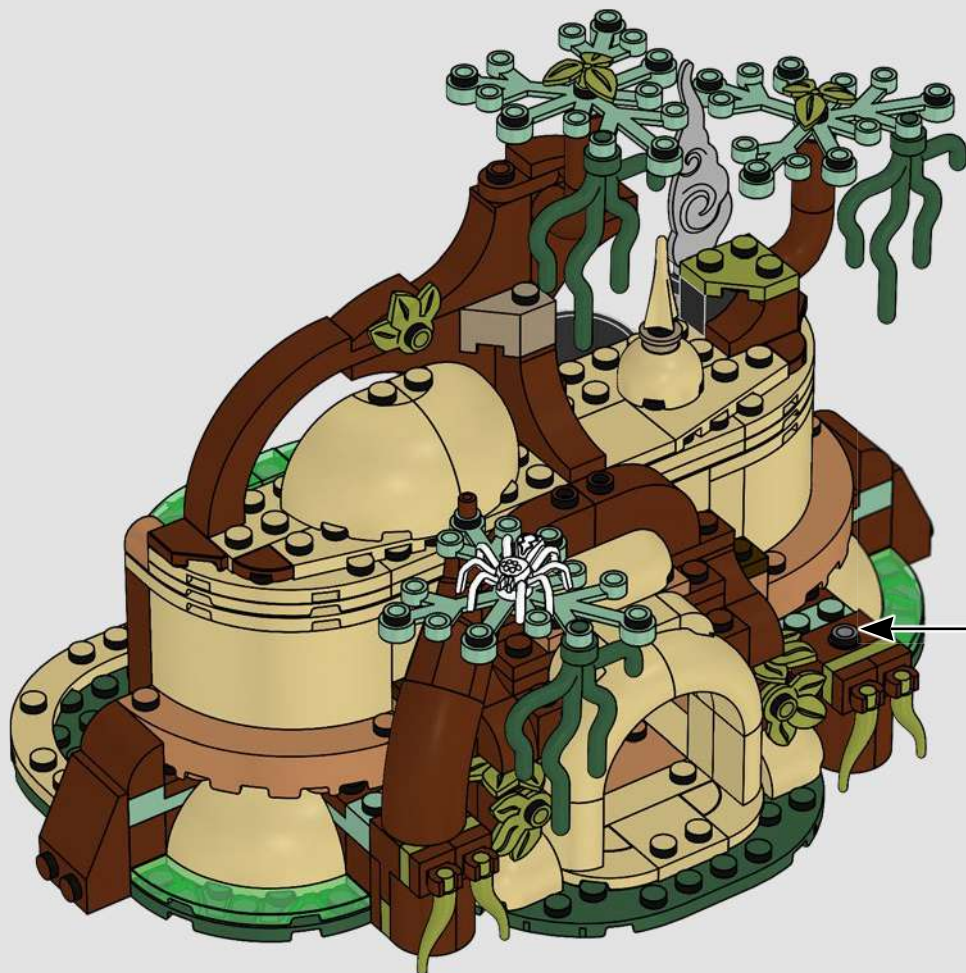



1x



1x

# 83

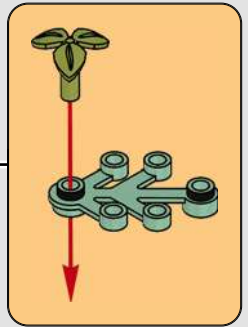
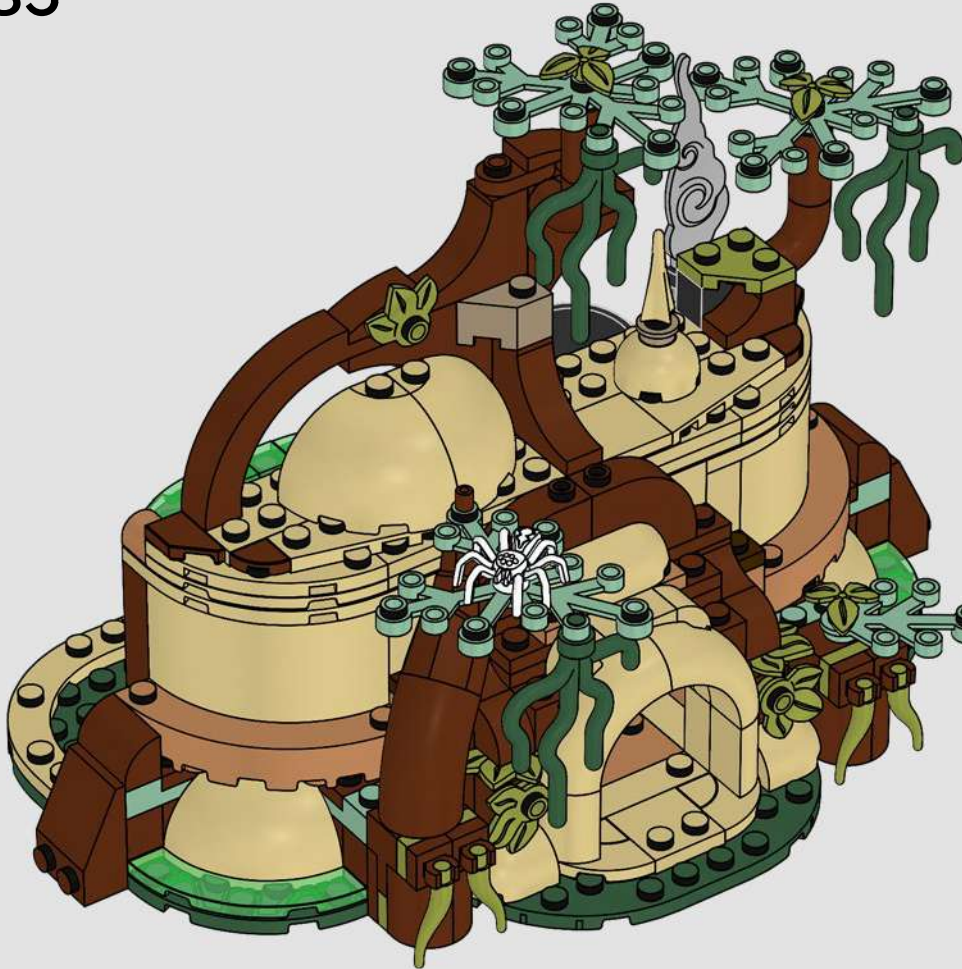



84







+



=

**SMART  
PLAY™**

1

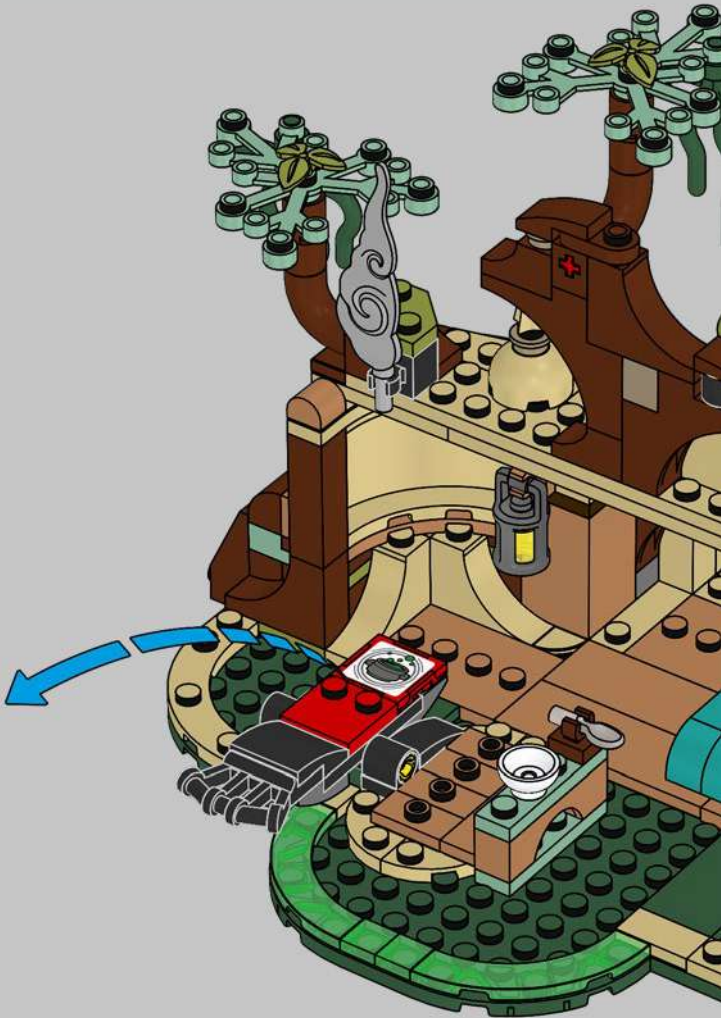
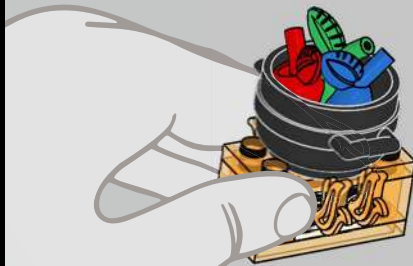

2

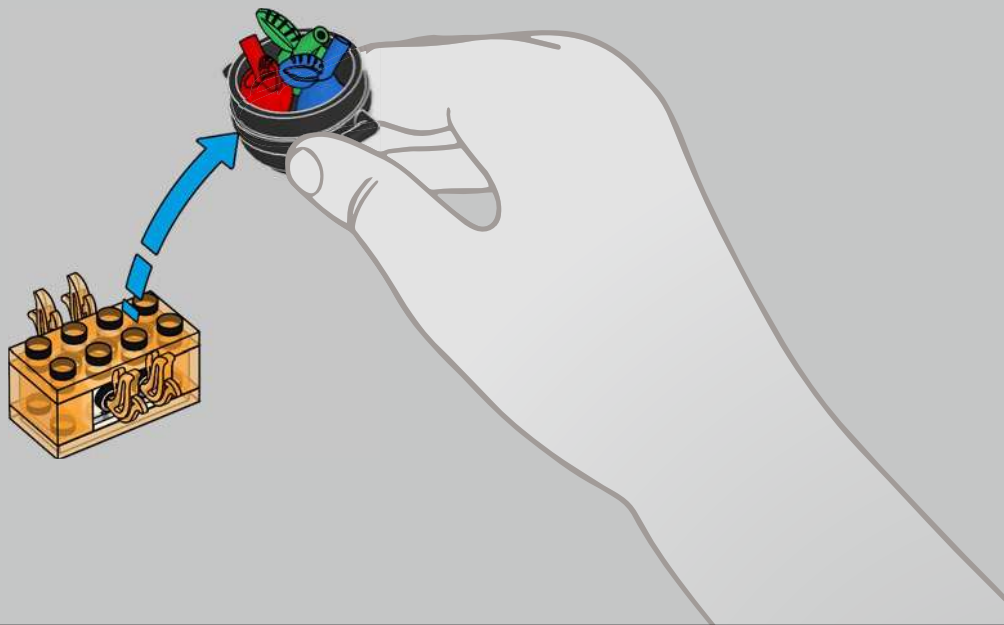

3

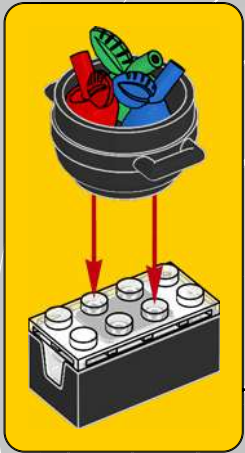

4

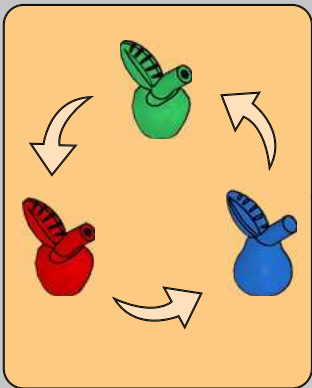
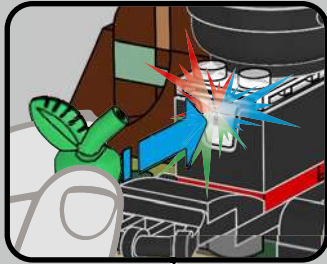

5



6

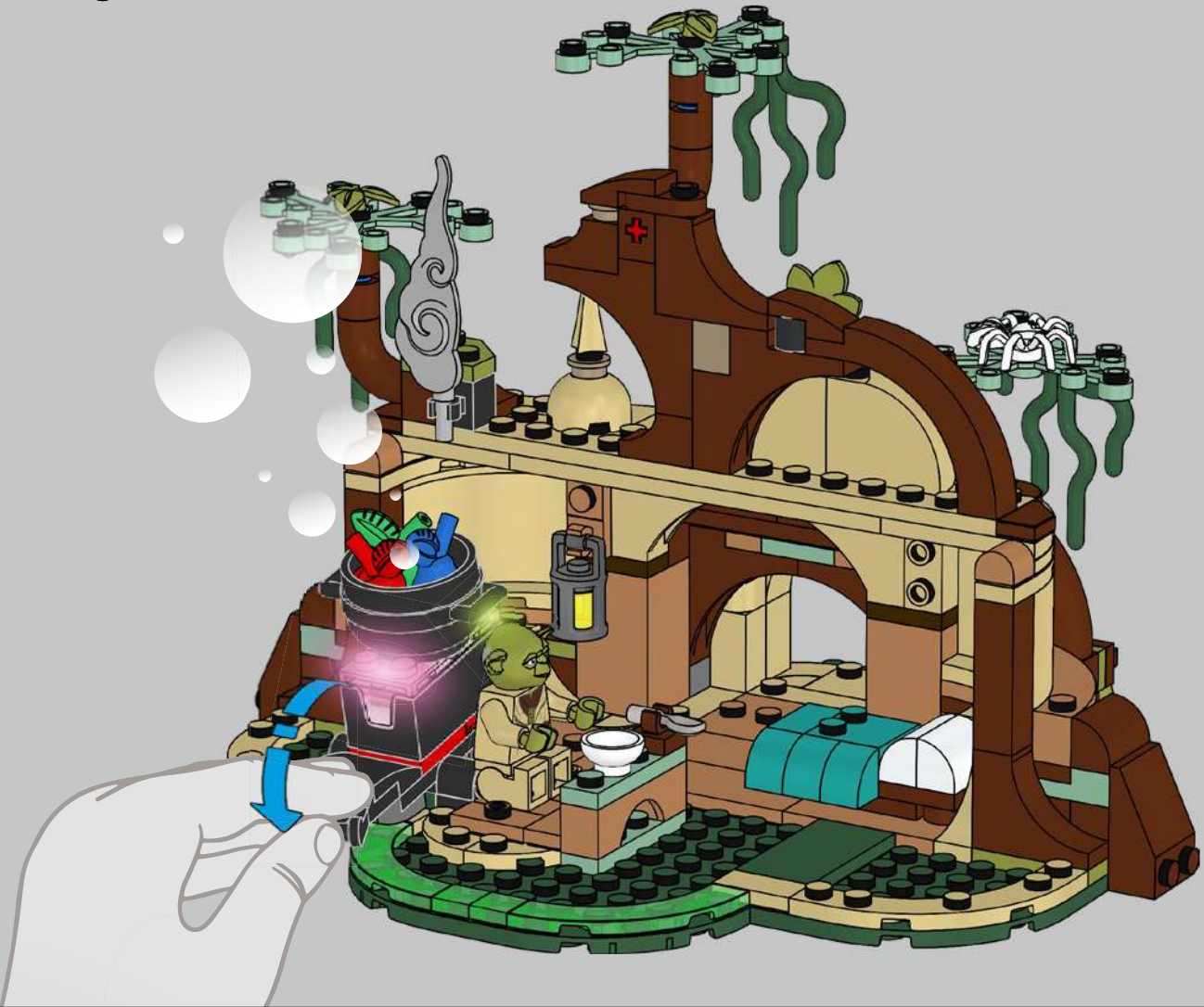



## DOWNLOAD THE APP

DOWNLOAD THE APP | DIE APP HERUNTERLADEN | TÉLÉCHARGER L'APPLI | SCARICA L'APP | DESCARGA LA APP | DESCARREGAR A APP | 下载应用程序 | POBIERZ APLIKACJĘ | STIAHNĚTE SI APLIKACIU | DESCARCA SI APLIKACIUA | TÖLTSD LE AZ APPOT! | ЗАВАНТАЖТЕ ДОДАТОК | DESCARCA APLICATIA | ИЗТЕГЛЕТЕ ПРИЛОЖЕНИЕТО | LEJUPIELĀDE LIETOTNI | LAADI ALLA RAKENDUS | ATSISIŪSTI PROGRAMĖLĘ | UYGULAMAYI İNDİRİN

Q LEGO® SMART ASSIST APP



Apple and the Apple logo are trademarks of Apple Inc., registered in the U.S. and other countries and regions. App Store is a service mark of Apple Inc. Google Play and the Google Play logo are trademarks of Google LLC.





# STAR WARS™

75422

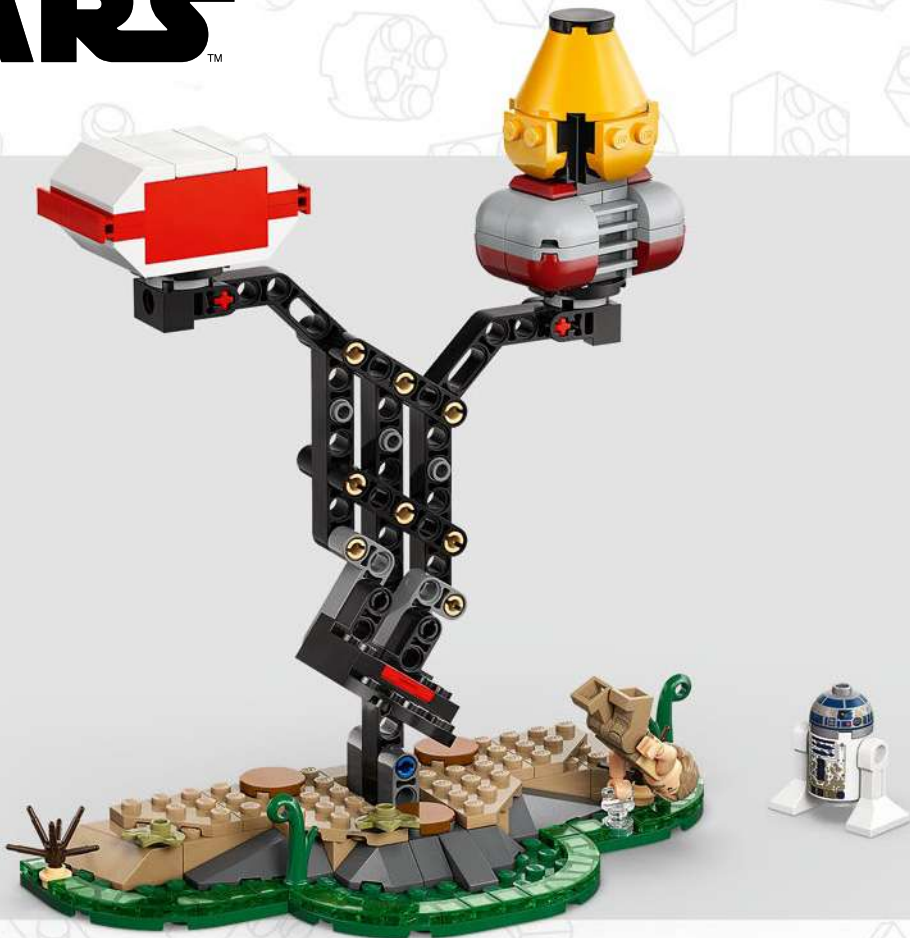

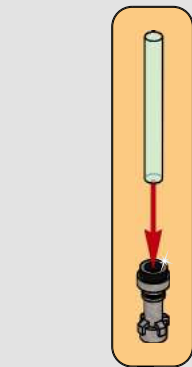
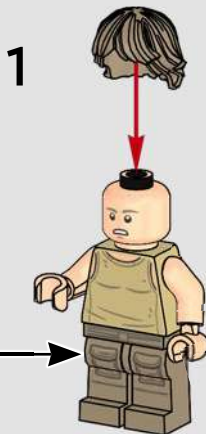
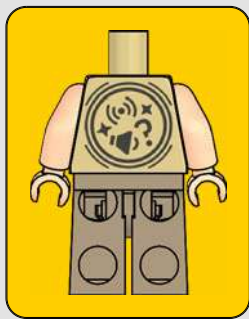
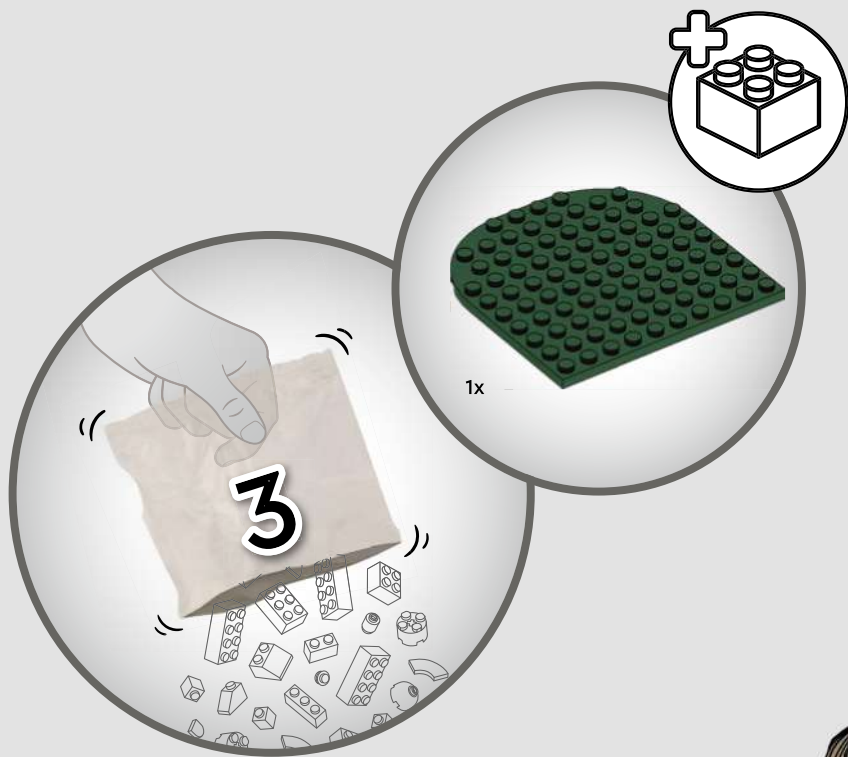

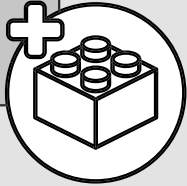
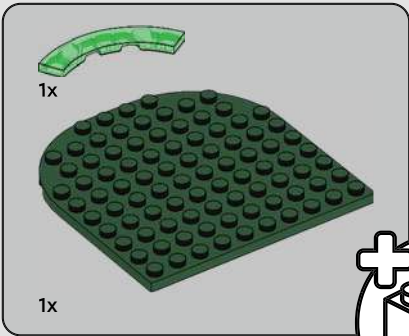

1

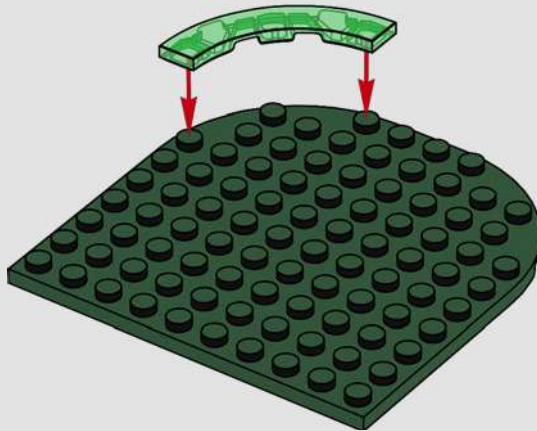

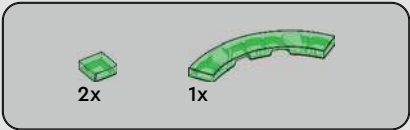

2

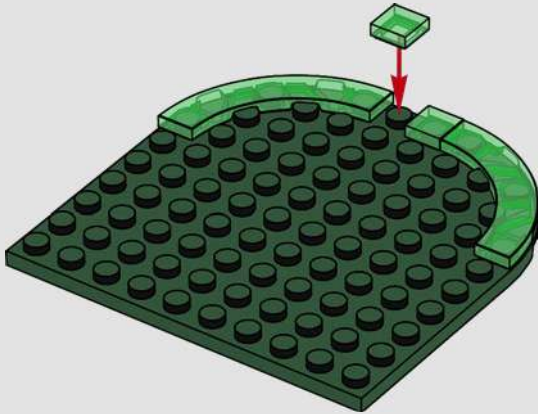

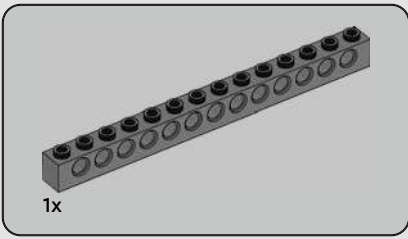

3

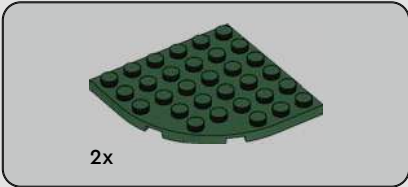
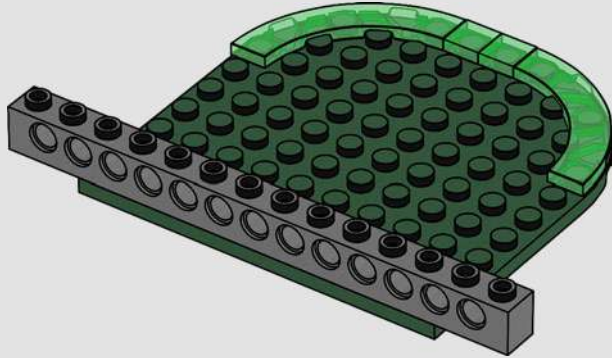

4

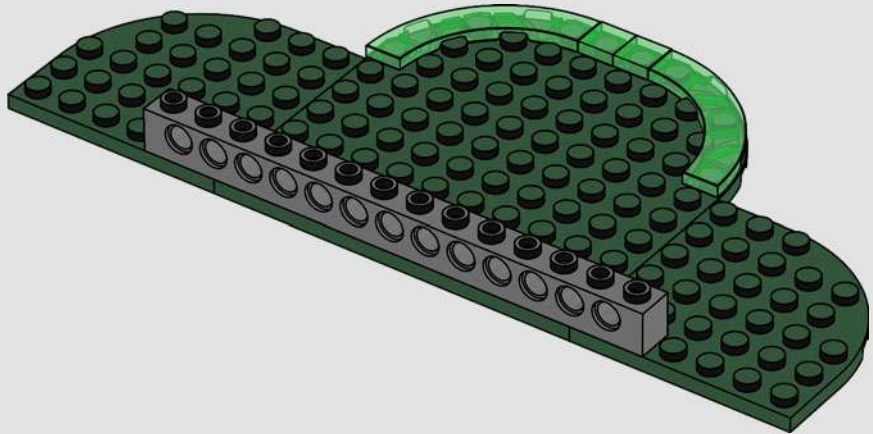



2x

5

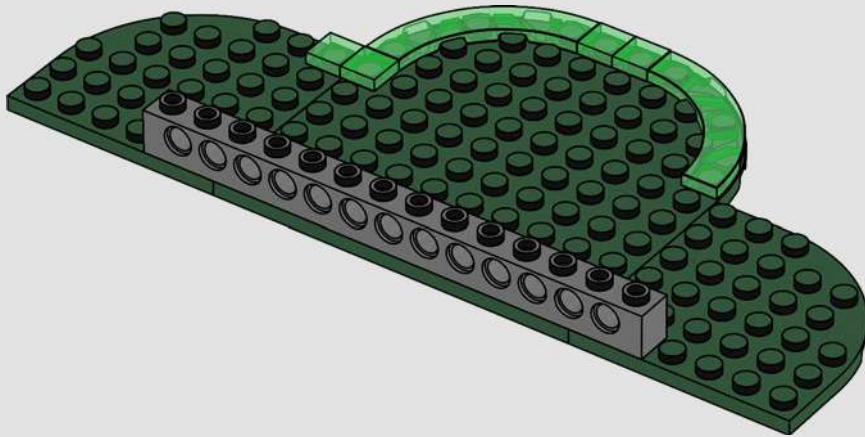



1x



1x

6

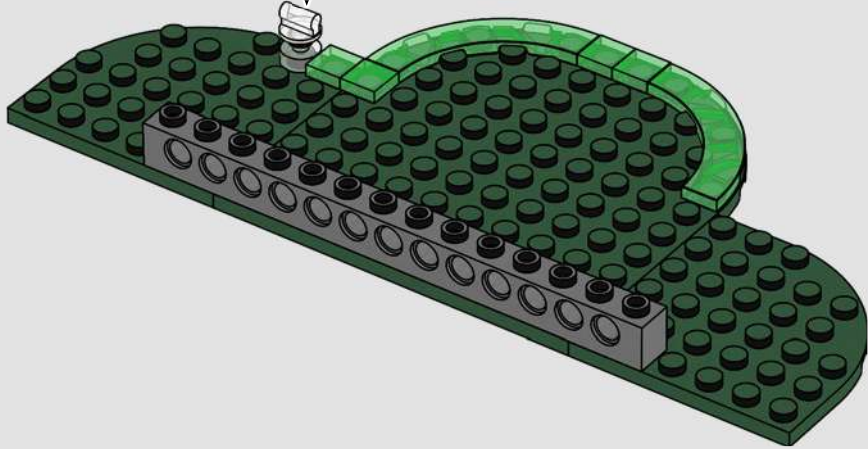
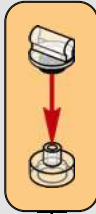

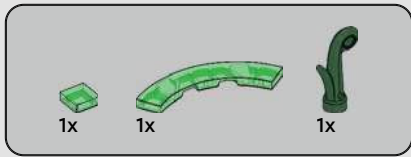

7

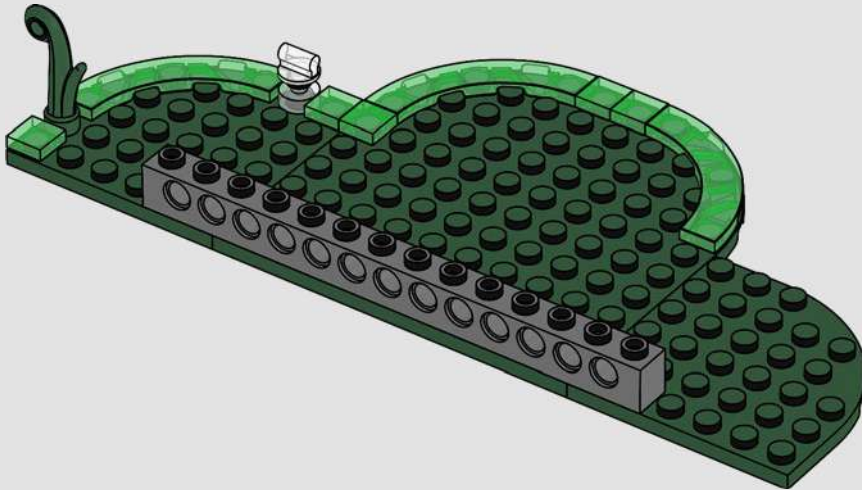

8



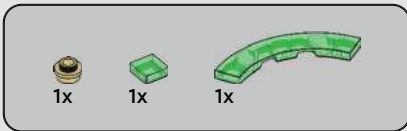

8

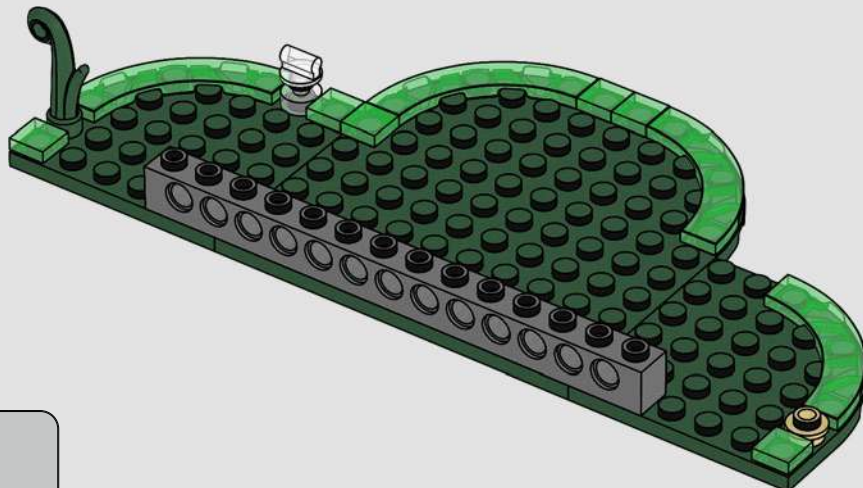

9

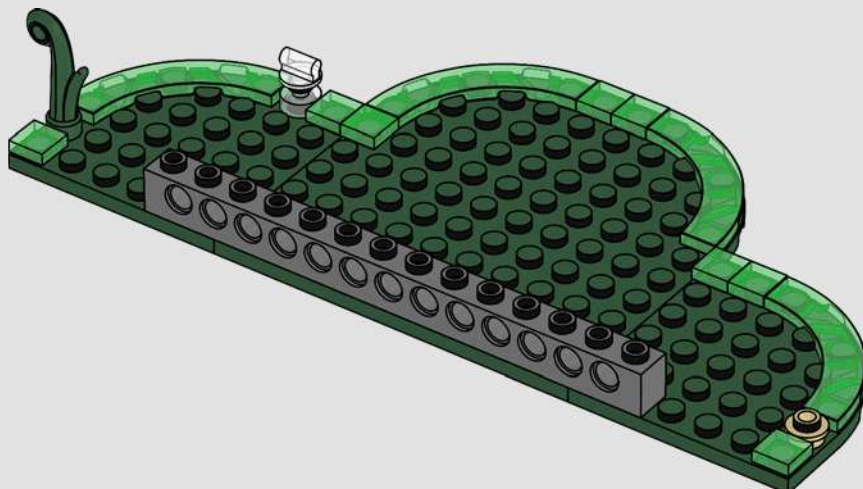

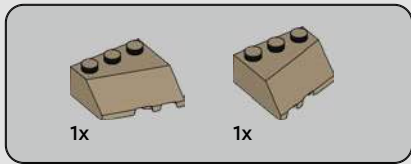

10

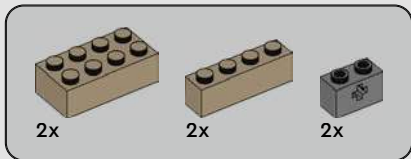
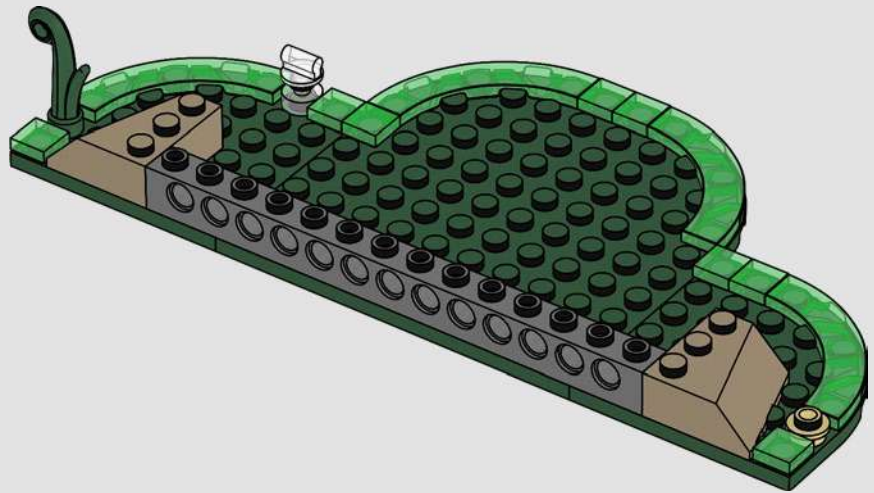

11

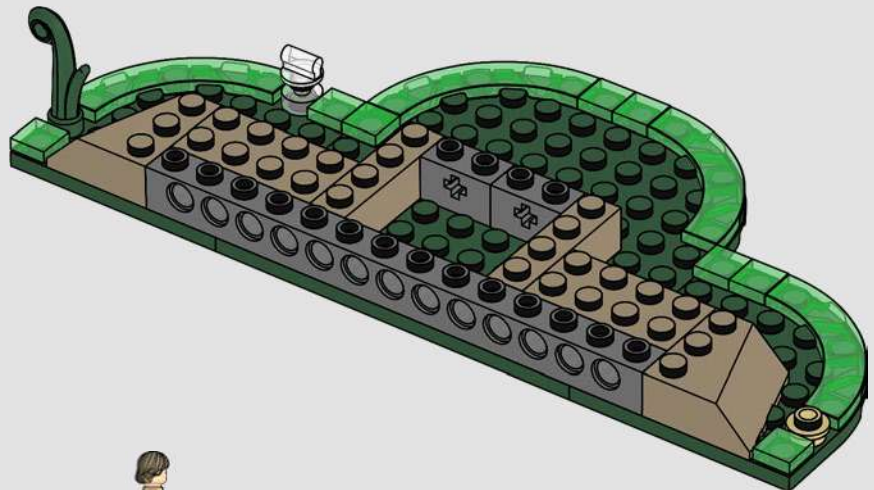

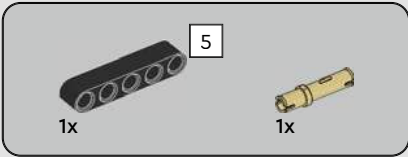
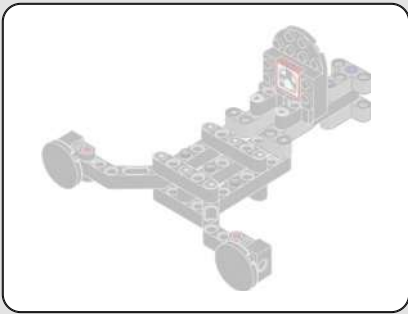

12

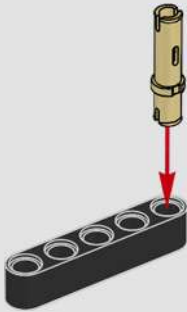

13

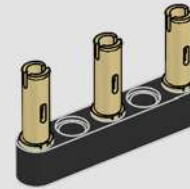

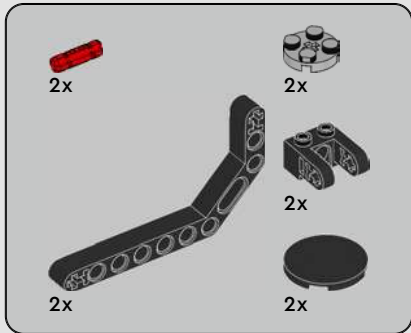
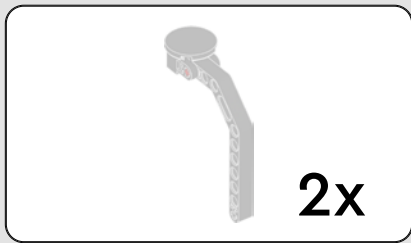

14

1



2



3

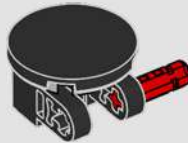

4

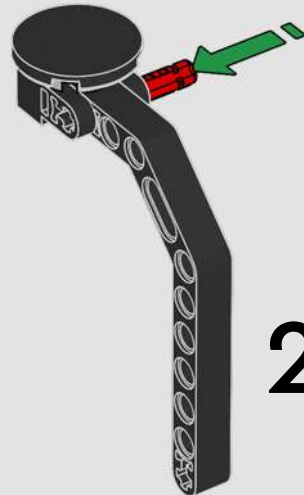

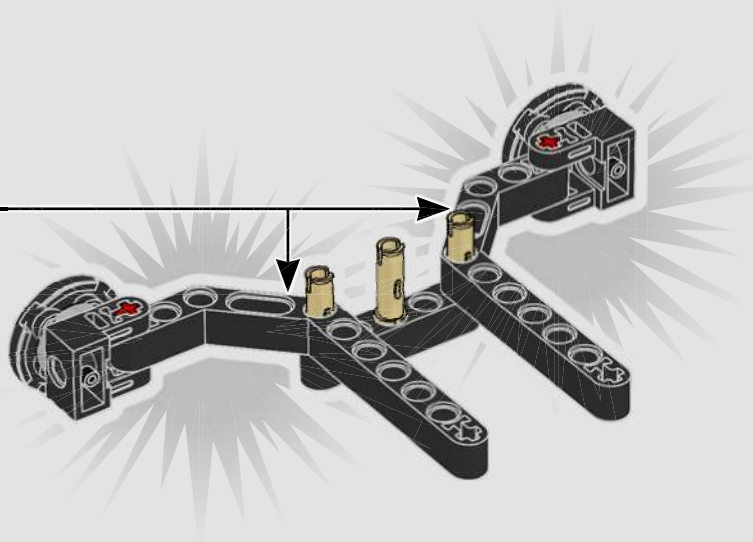



2x

15

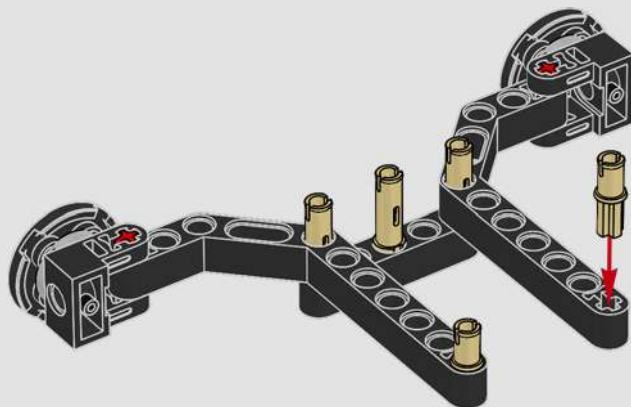

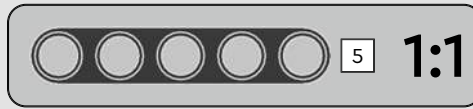
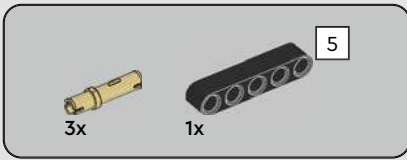

16

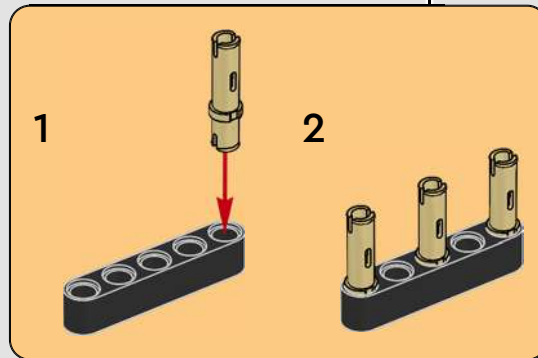
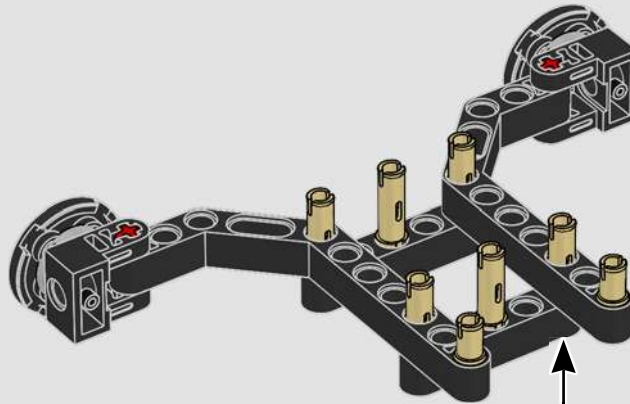



2x

17

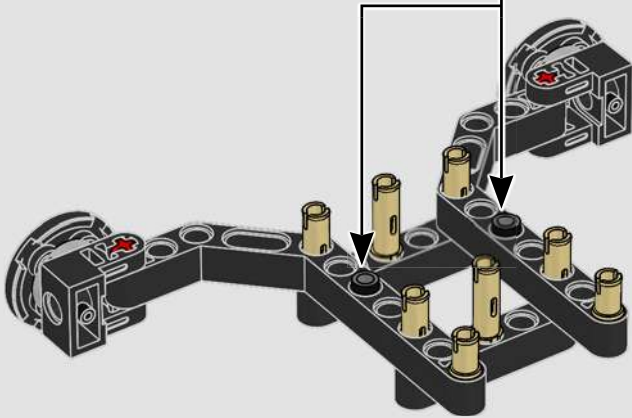
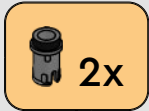

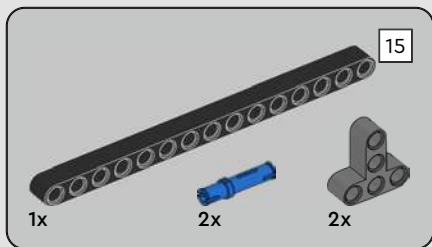

18

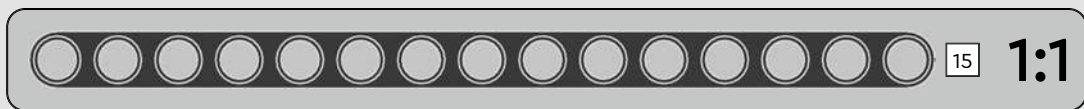
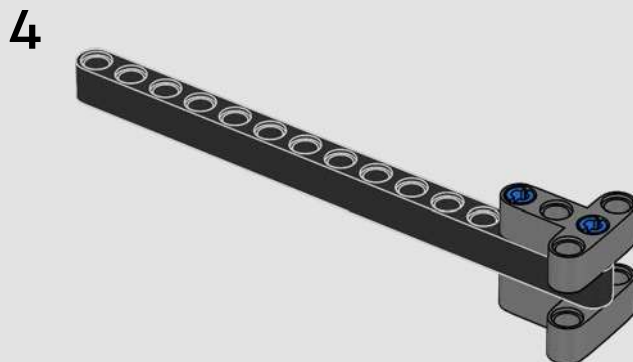
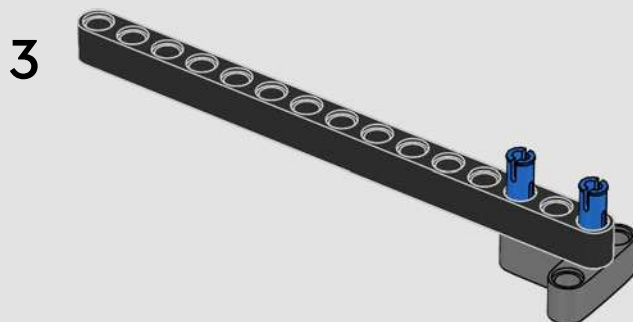
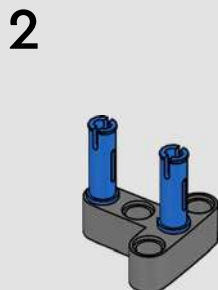
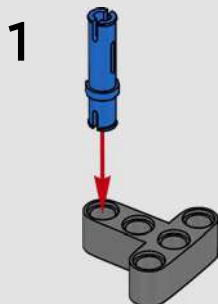

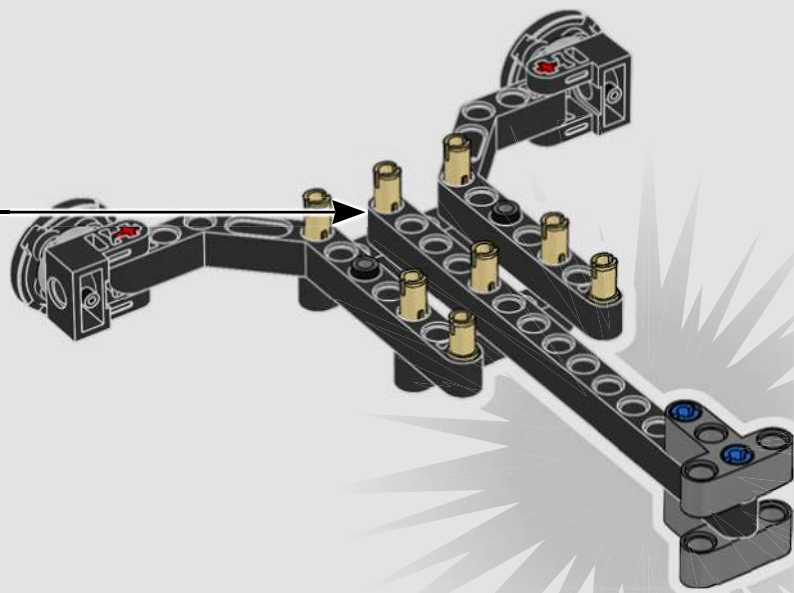



1x

19

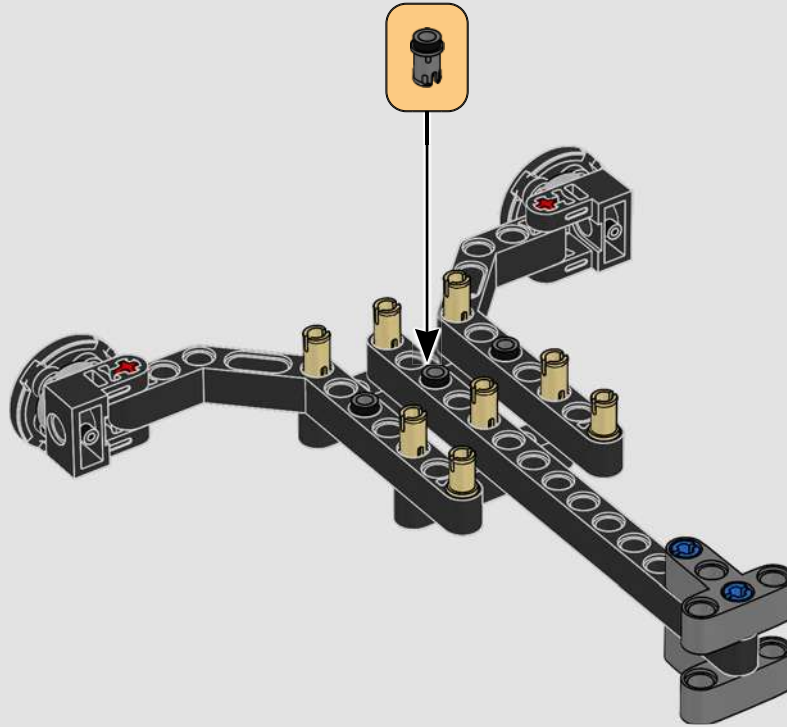

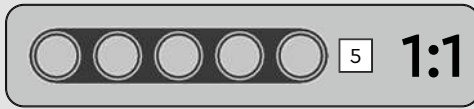
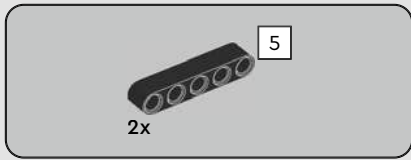

20

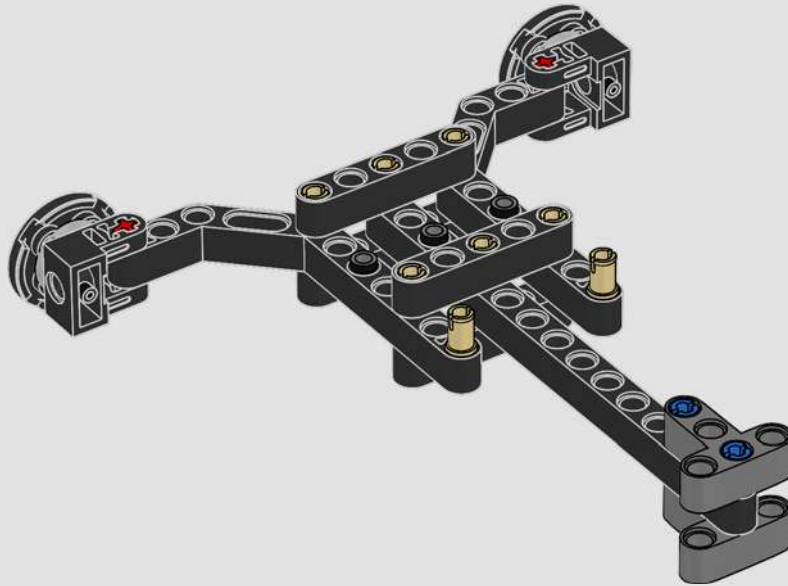

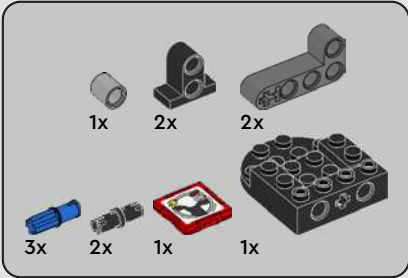

21

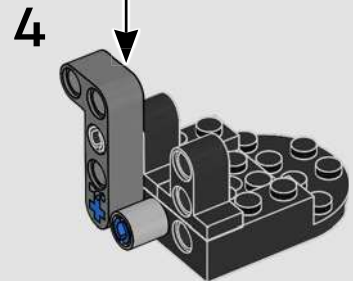
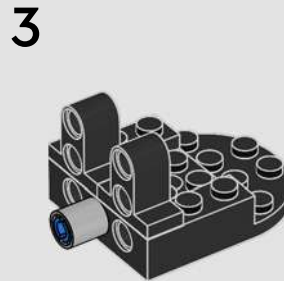
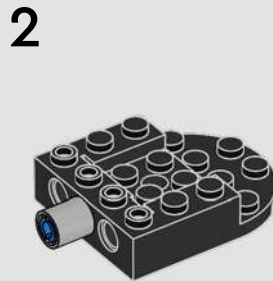
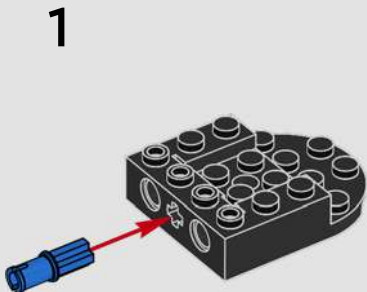
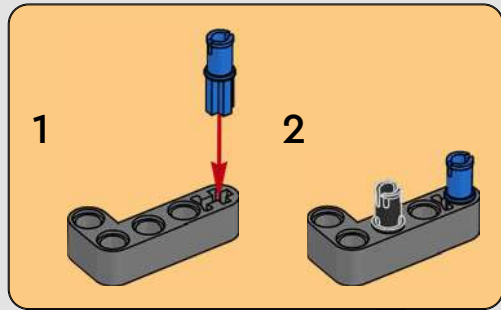

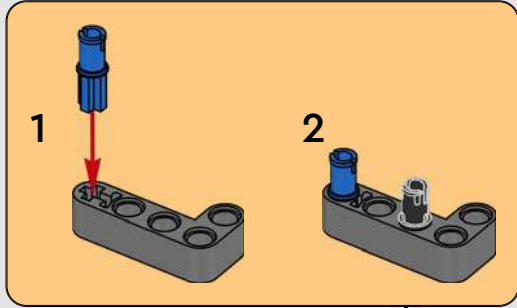

5

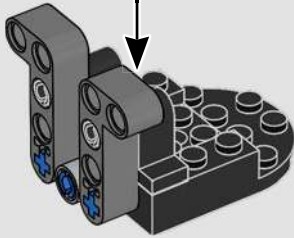

6

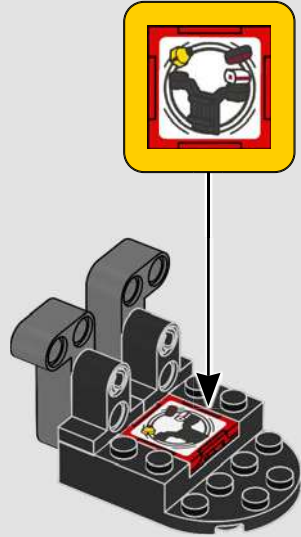

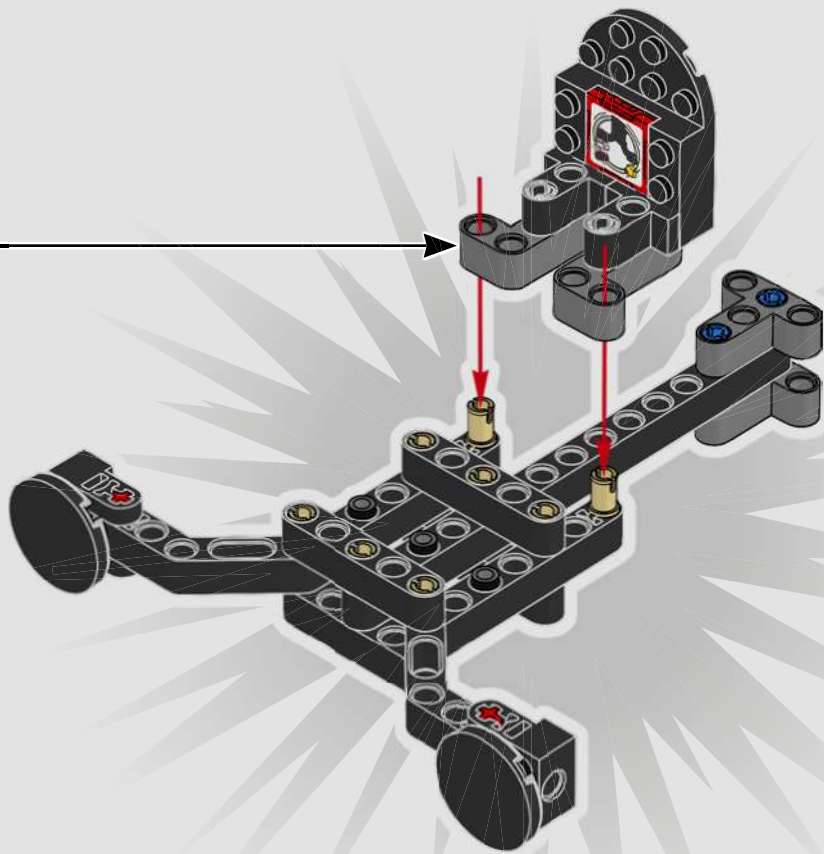

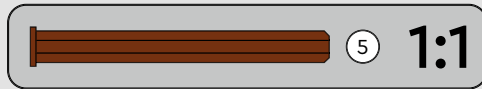
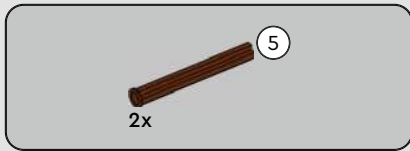

22

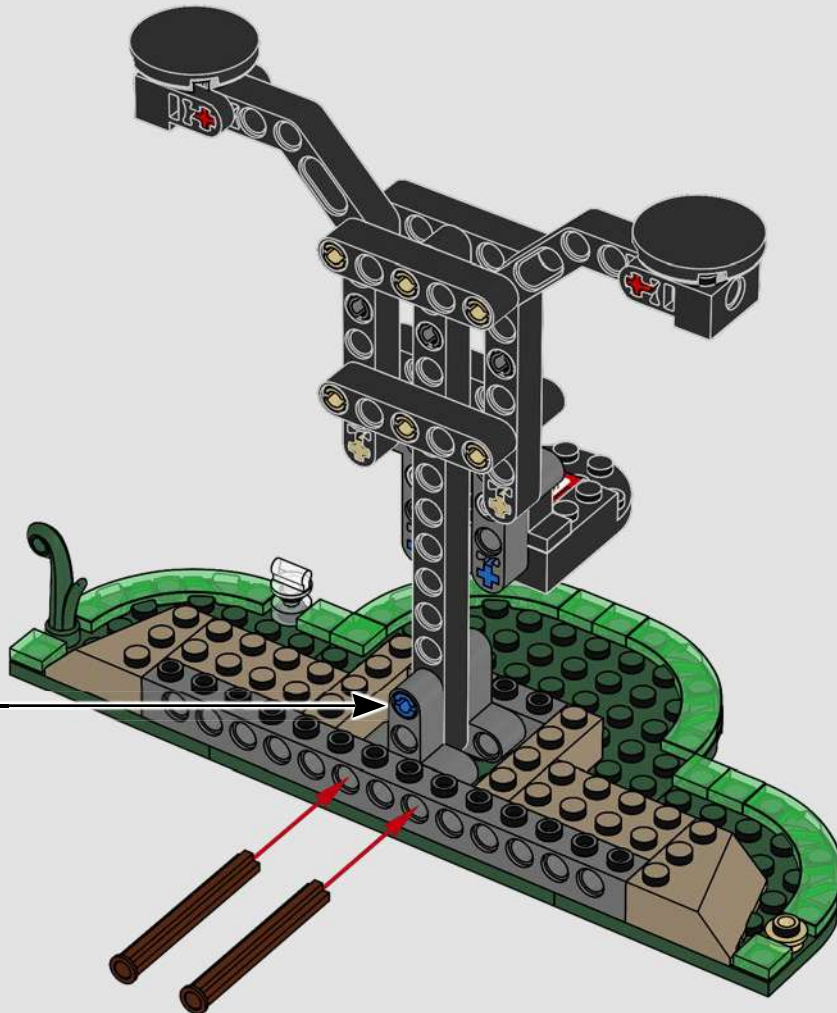

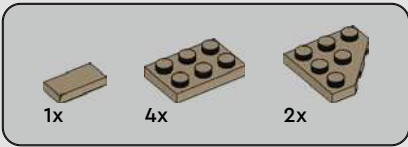

23

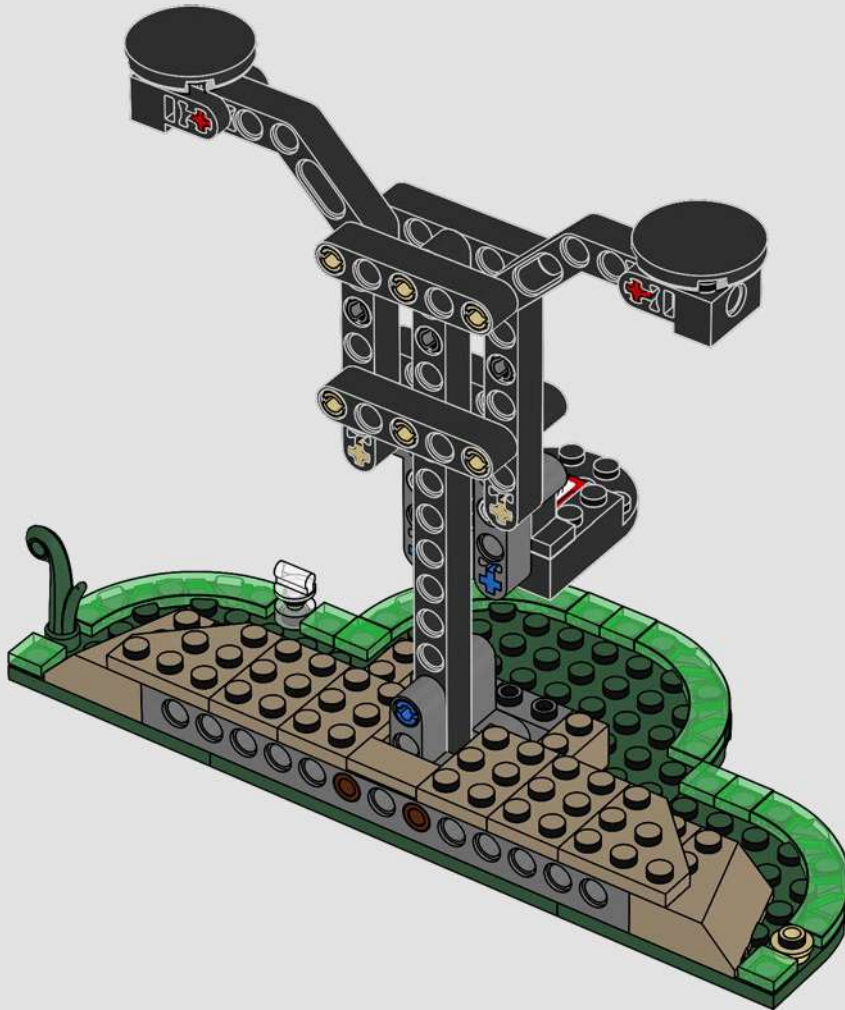

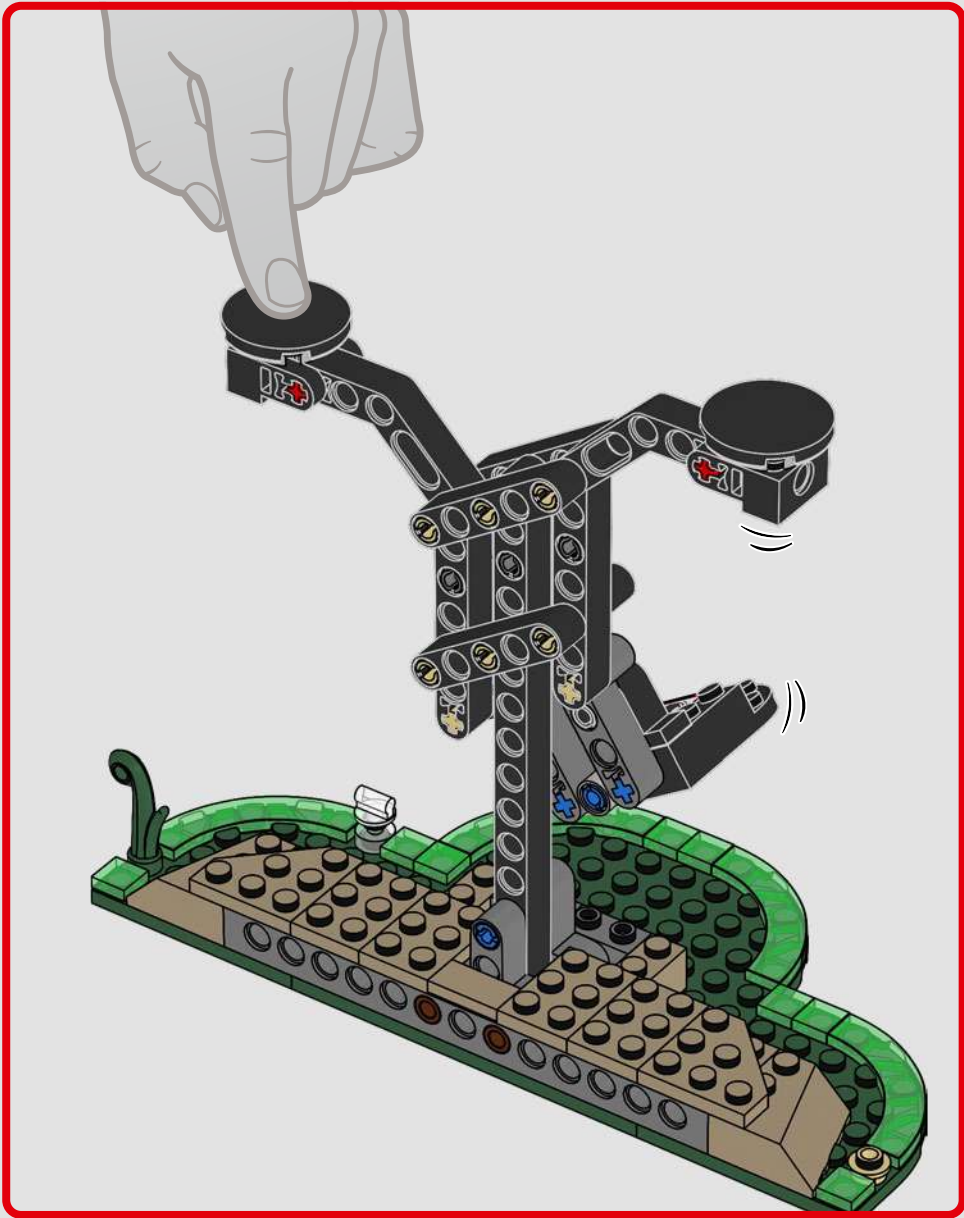



2x

24

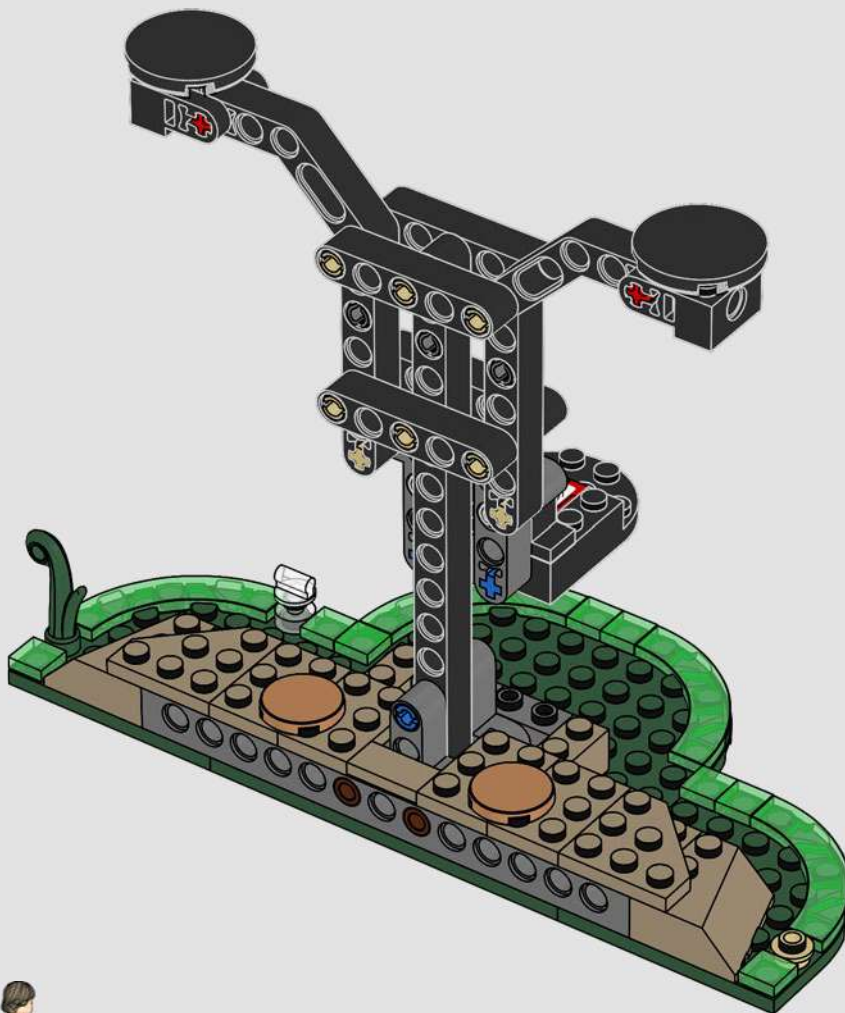

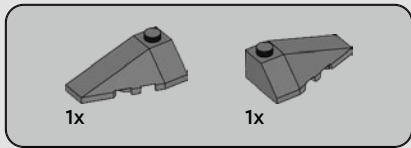

25

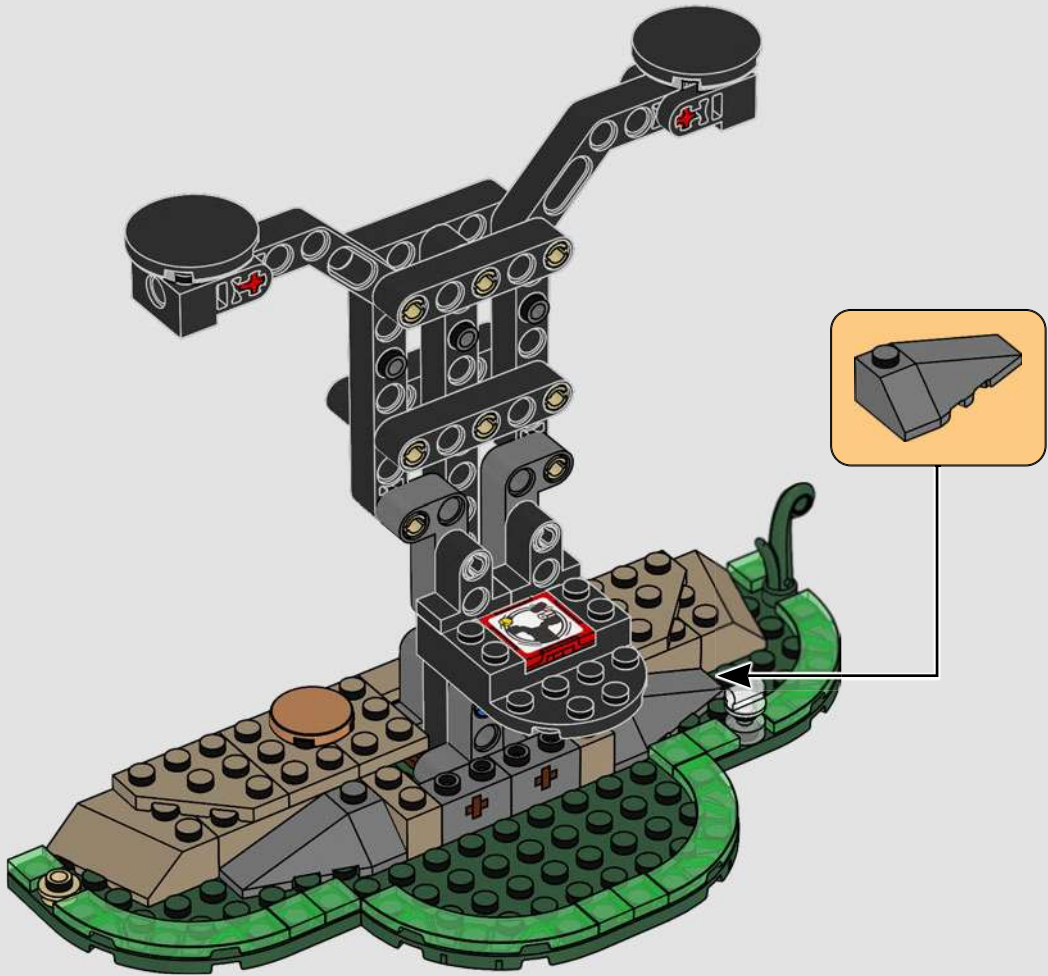

1x

26

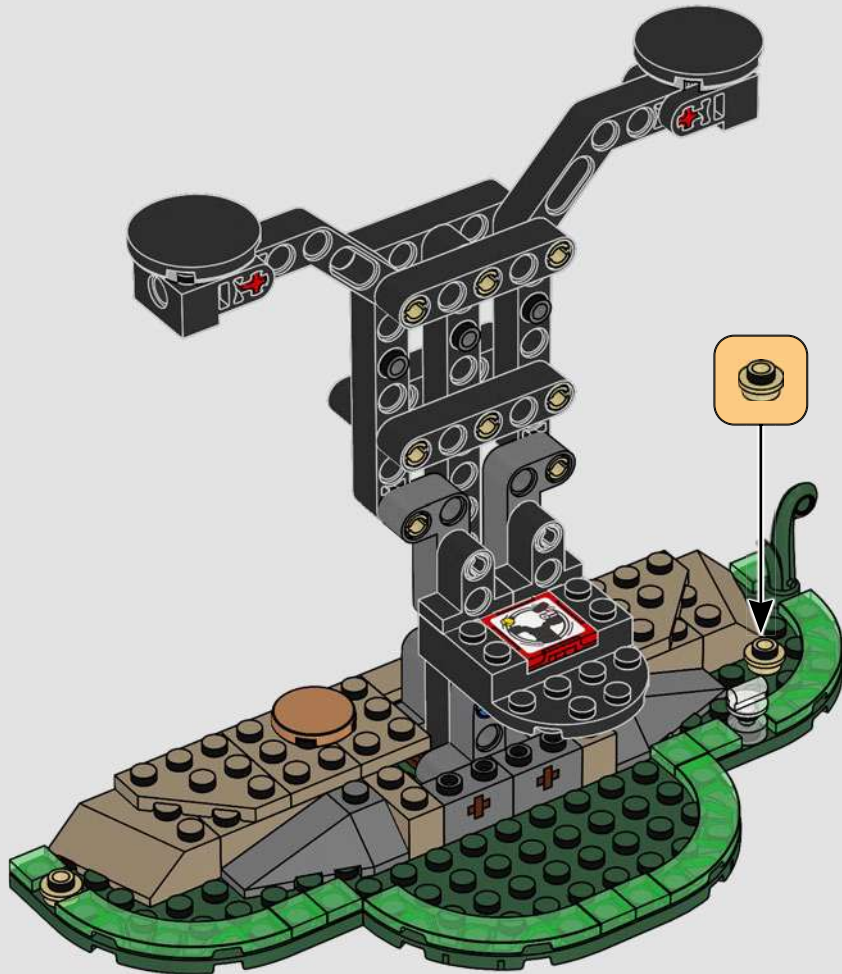

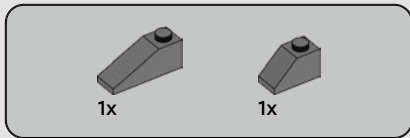

27

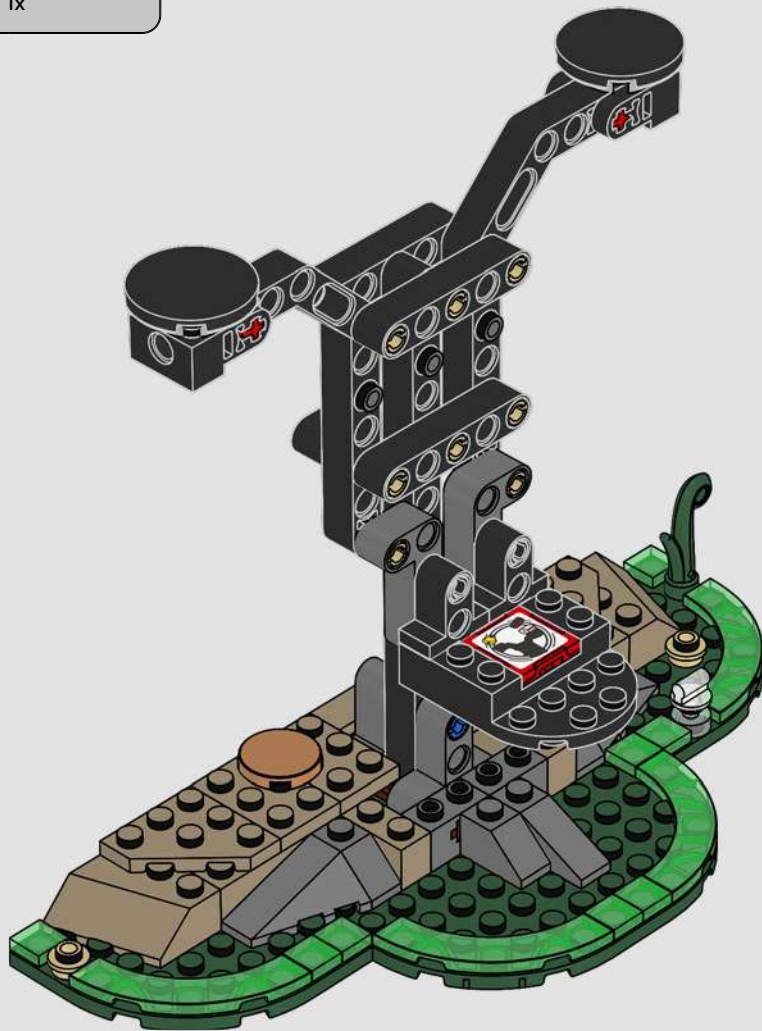



2x

28

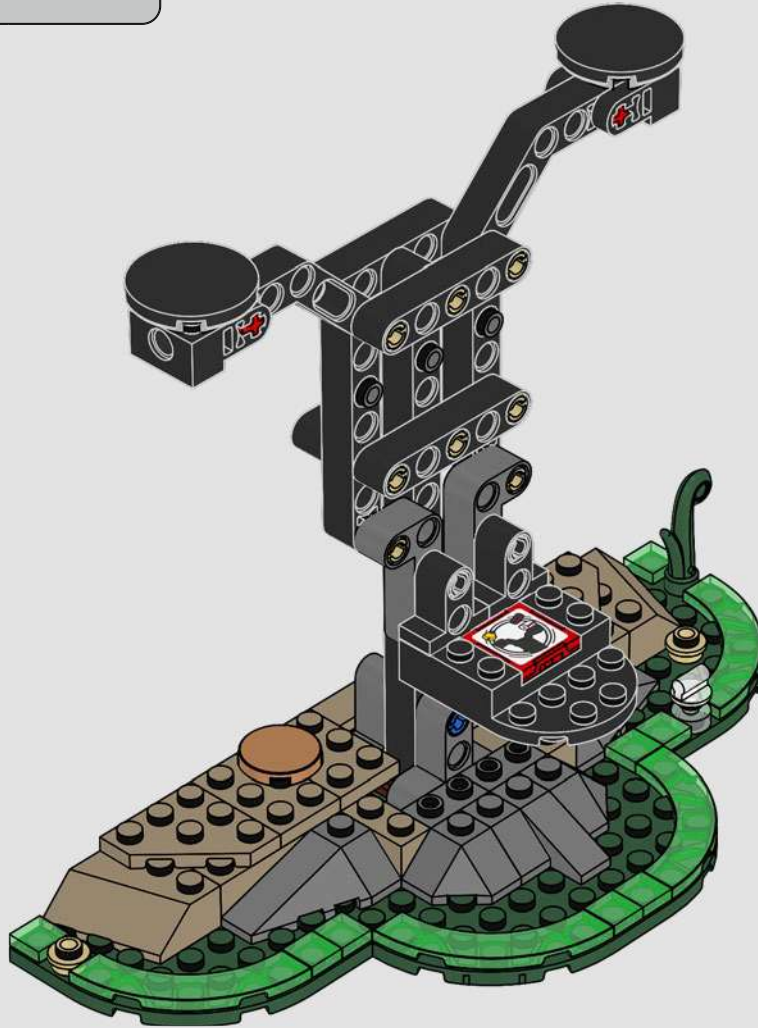



1x

29

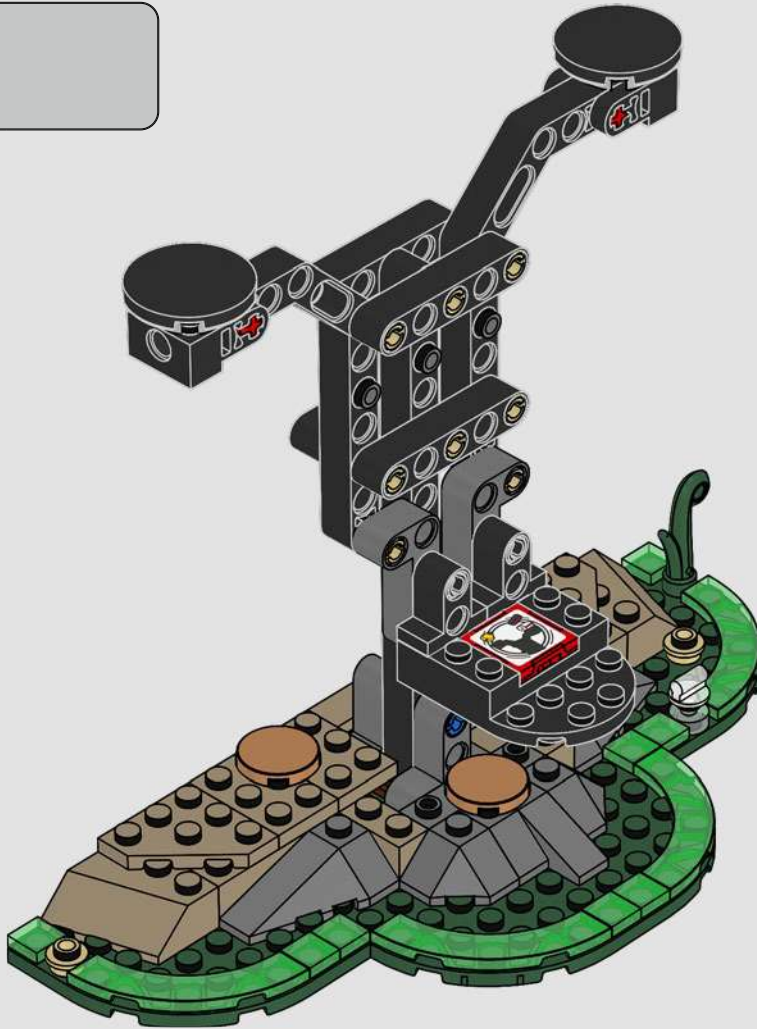



2x

30

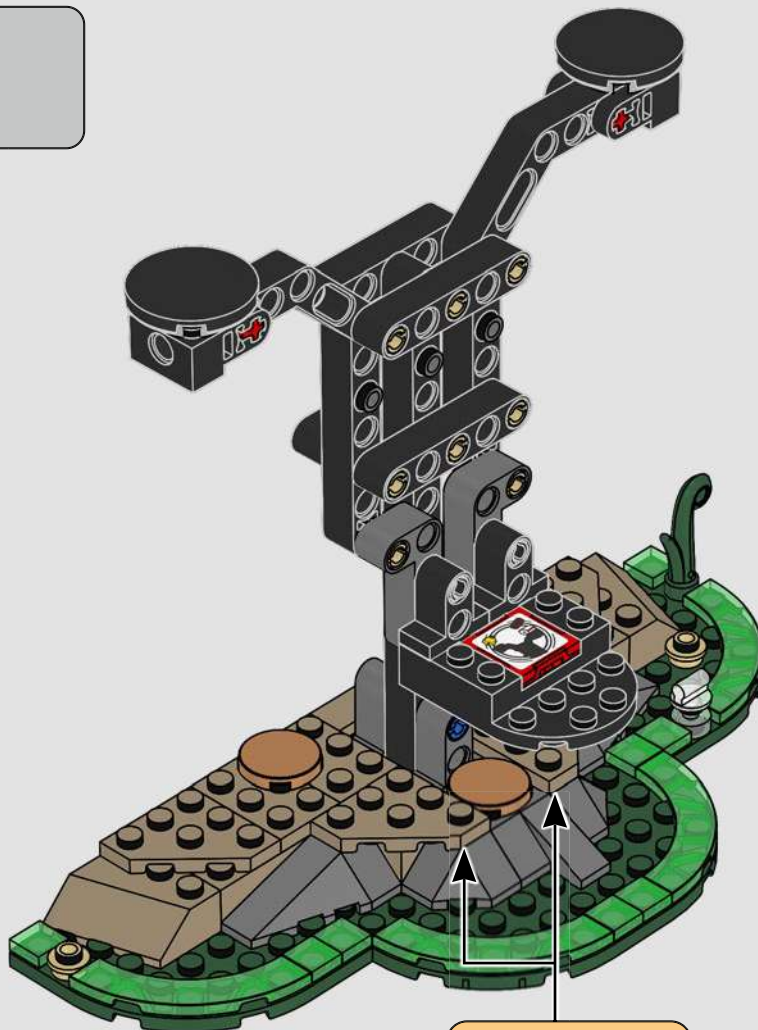

2x





2x

31

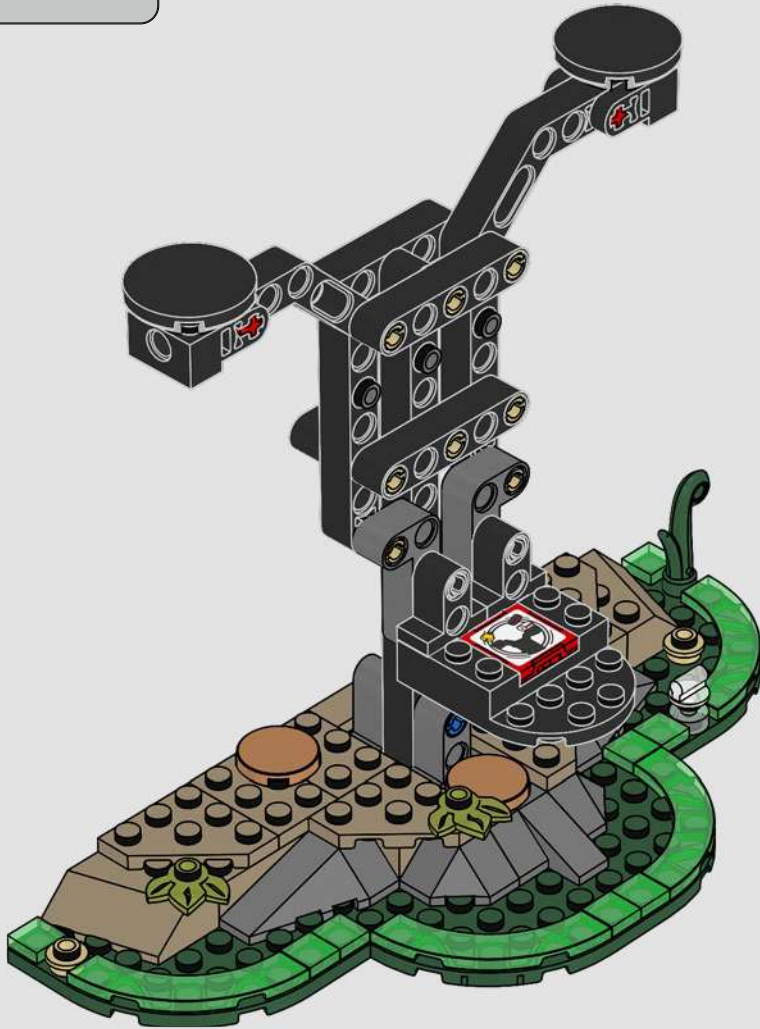



1x



2x

32

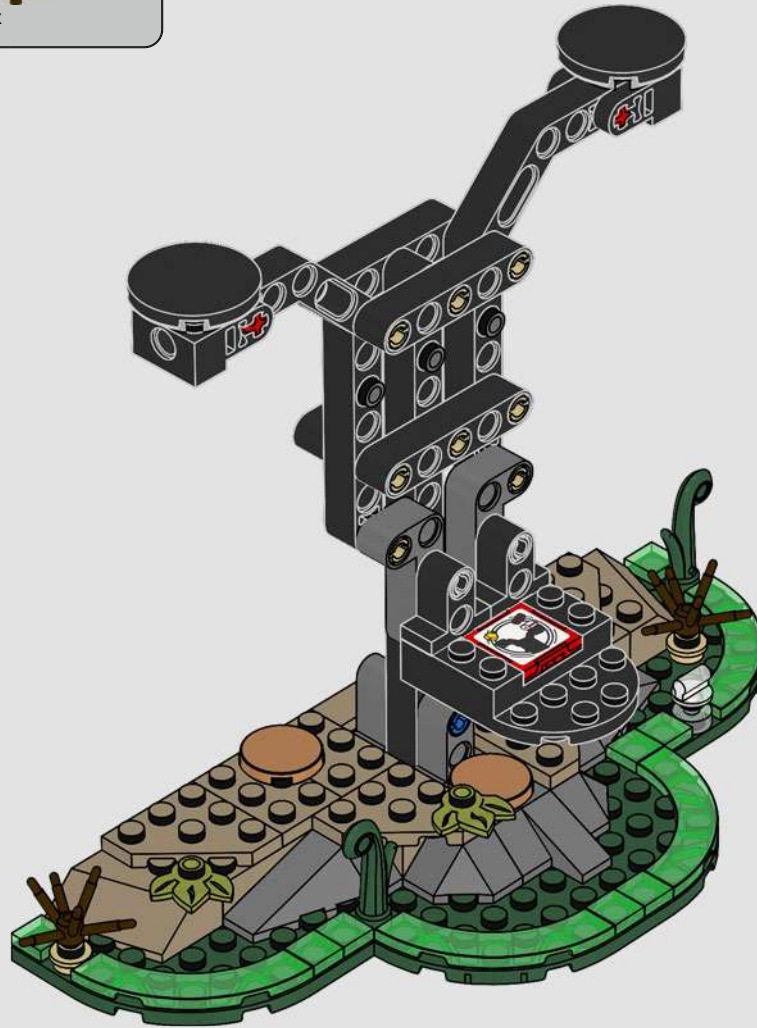

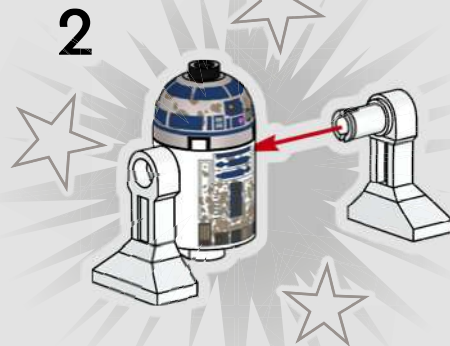
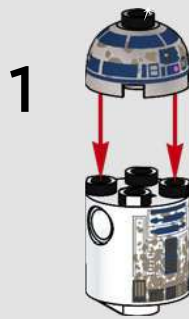

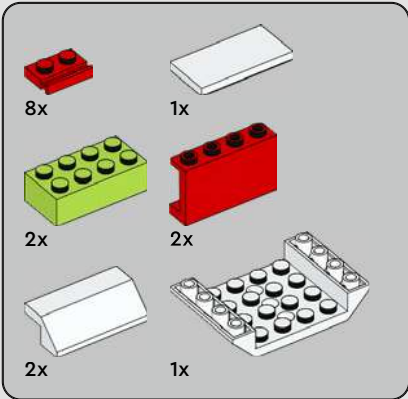
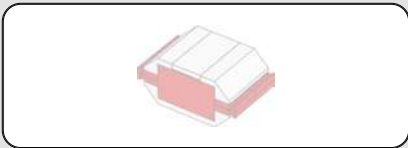

33

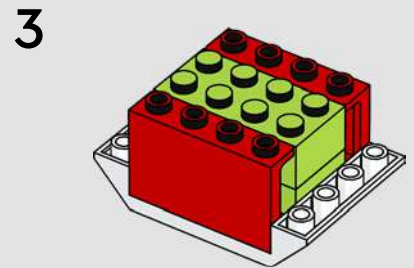
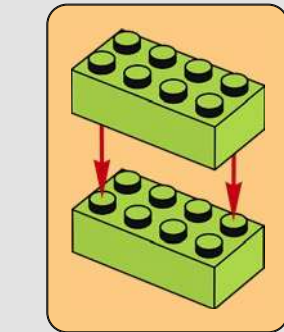
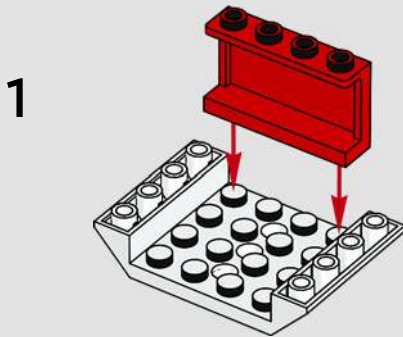

4

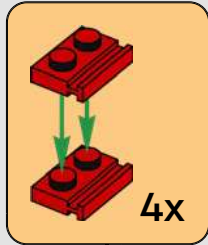
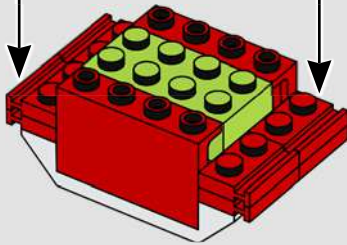

5

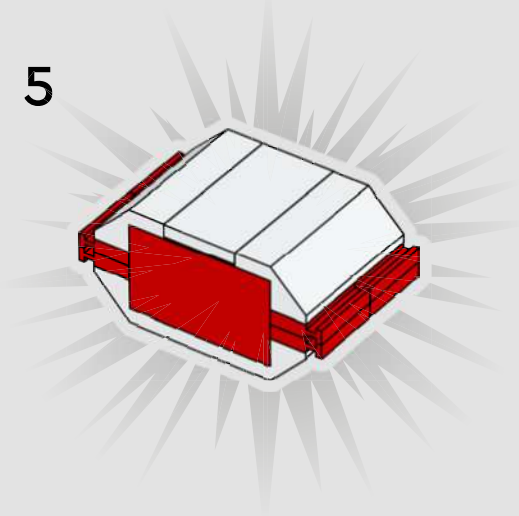

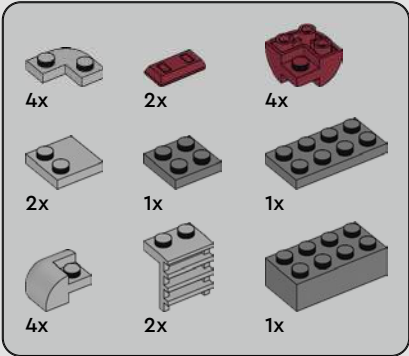

# 34

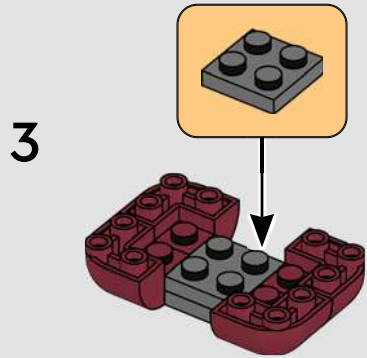
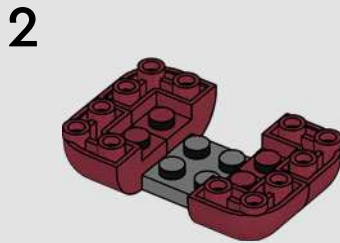
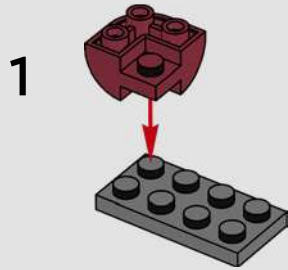

4

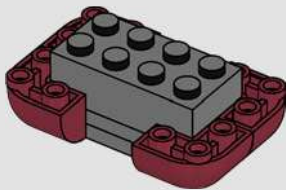

5

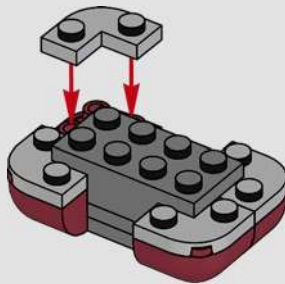

6

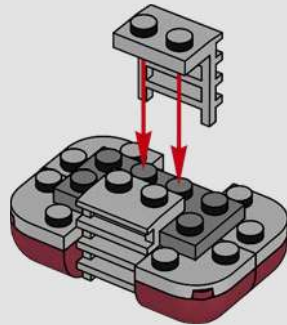

7

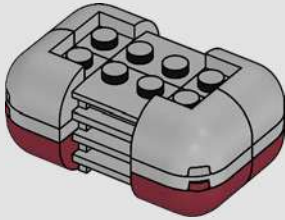

8

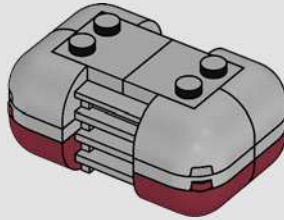

9

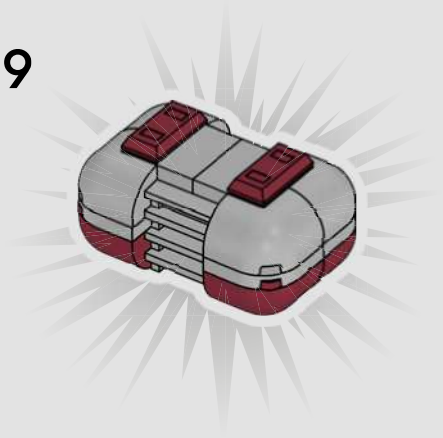

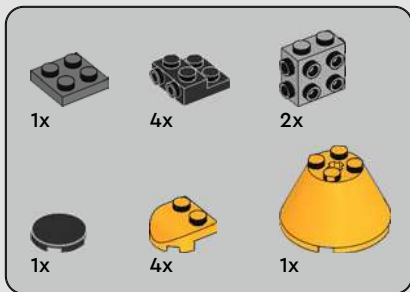

# 35

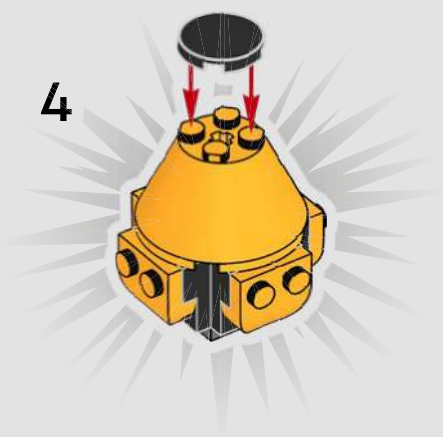
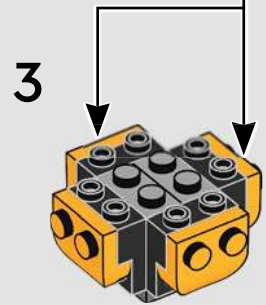
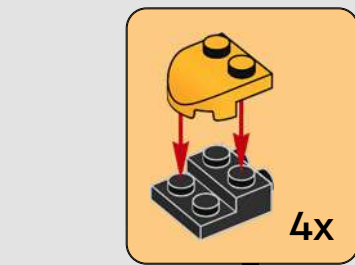
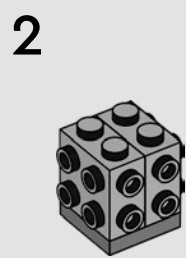
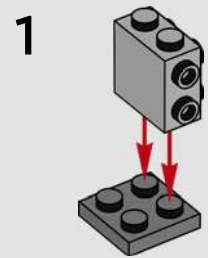

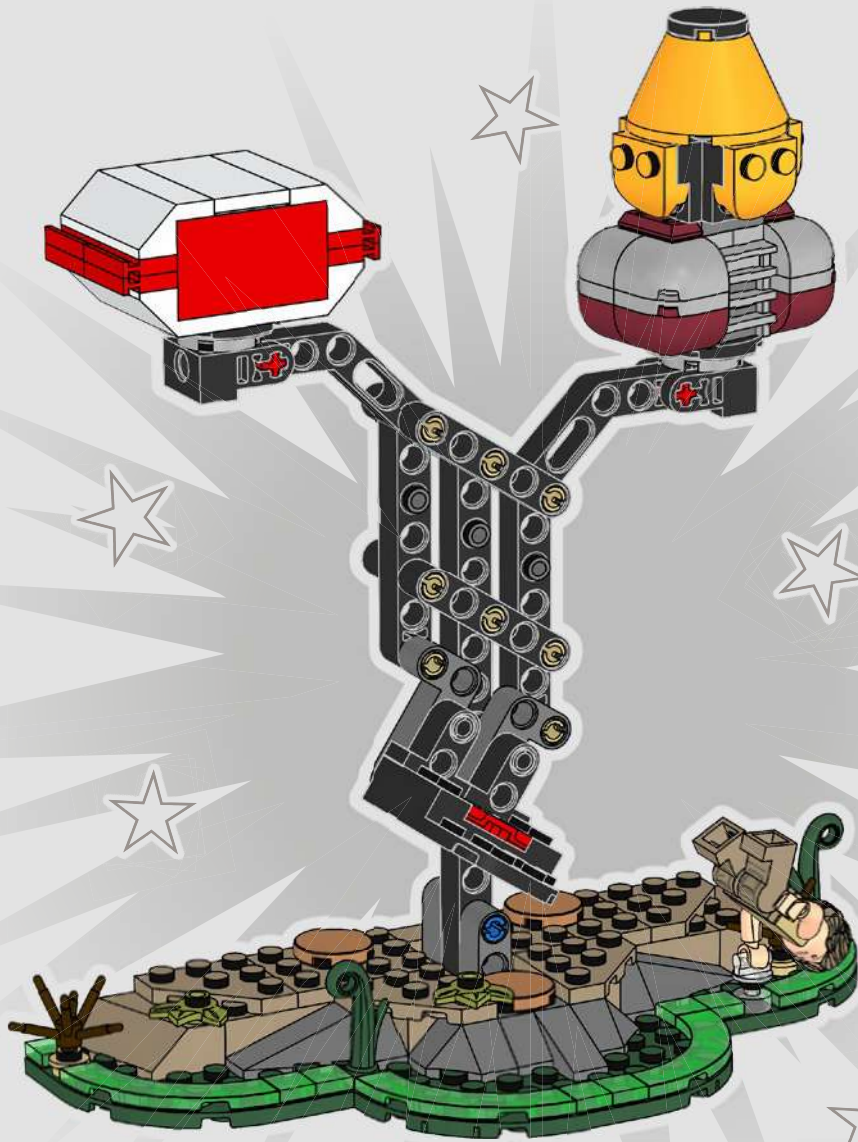



+



=

**SMART  
PLAY**<sup>TM</sup>

1

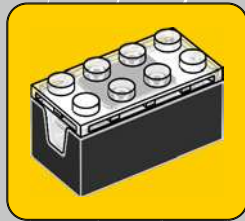

2

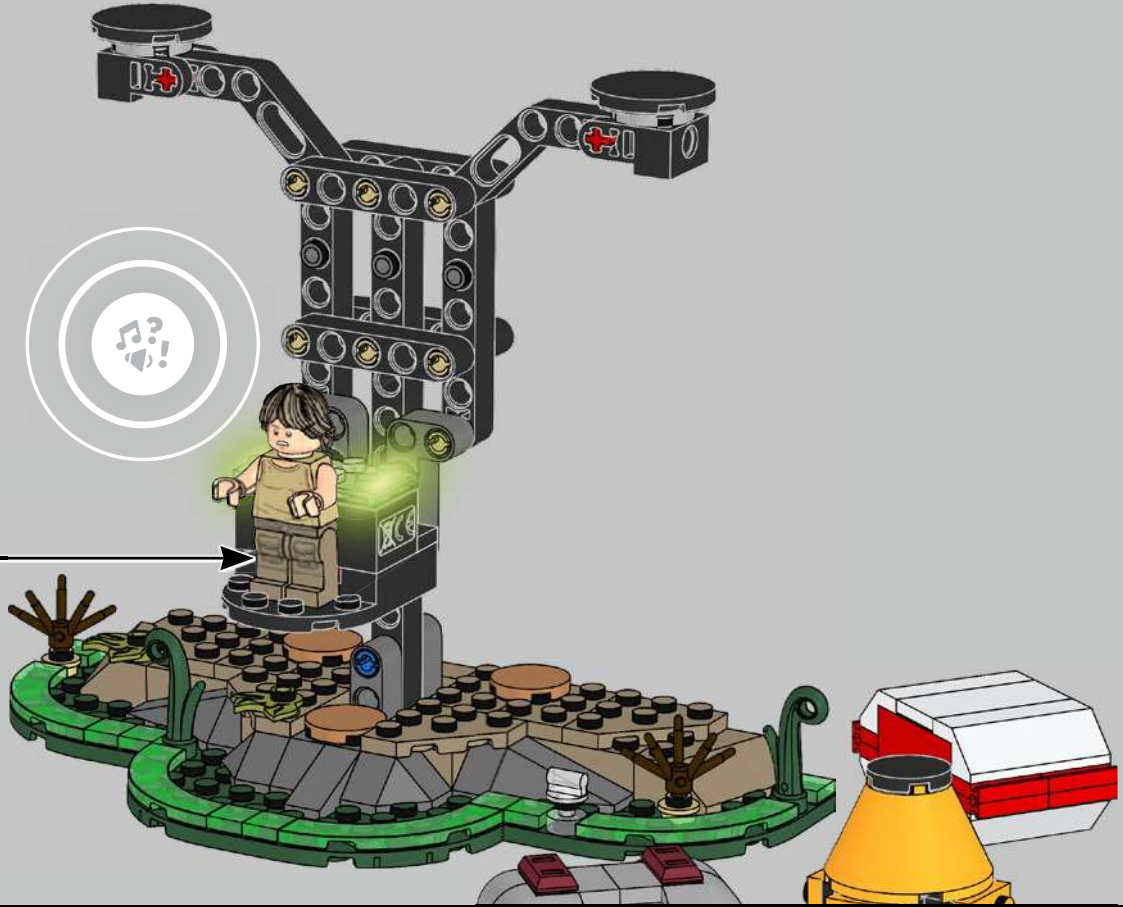

3

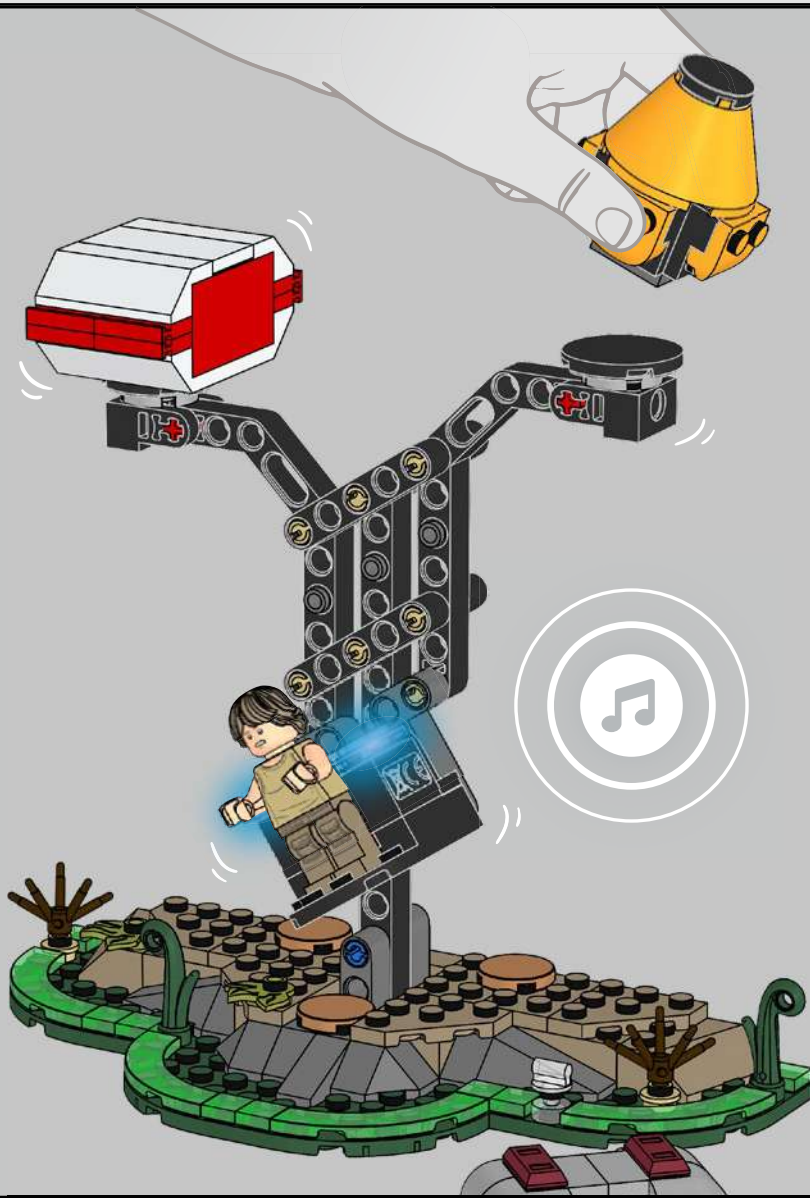



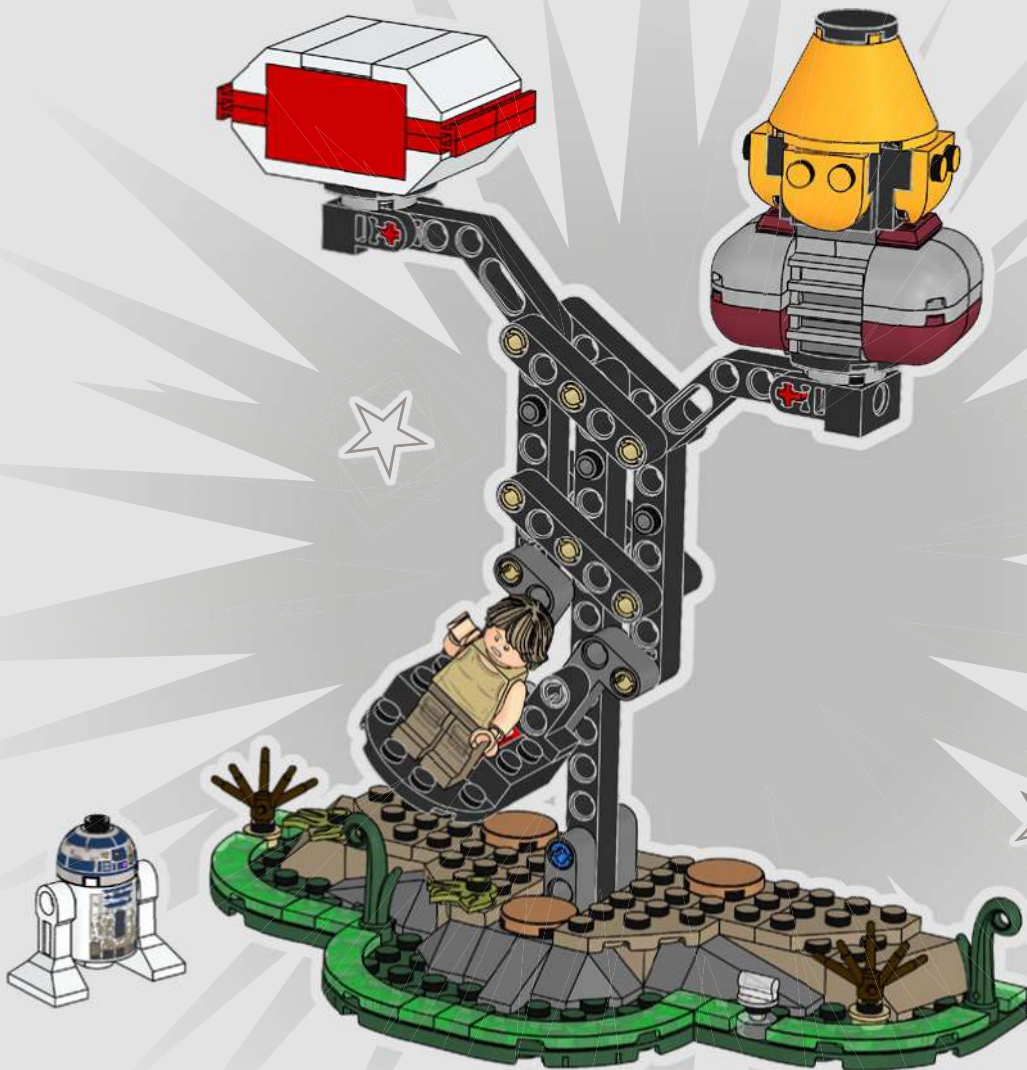



# STAR WARS



REACTS TO  
HOW YOU  
MOVE & PLAY



REACTS TO  
HOW YOU  
MOVE & PLAY



75421



75423





REACTS TO  
HOW YOU  
MOVE & PLAY

75427

Reacts to how you move & play /  
Reagiert auf deine Bewegung & dein  
Spiel / Réagit à ta façon de bouger  
et jouer / Reagisce al movimento  
e al gioco / Reacciona a cómo te  
mueves y juegas / Reage à forma  
como se mexe e brinca /  
根据你的动作和玩乐方式做出反应 /  
Reaguje na to, jak nim poruszasz i jak  
się bawisz / Reaguje na pohyb a hru /  
Reagál a mozgatásra és a játékra /  
Реагує на ваші рухи й гри /  
Reacționează la modul în care te  
miști și te joci / Реагира на начина,  
по който се движите и играете /  
Reagē uz tavām kustībām un  
rotāšanās / Reageerib sinu  
liikumisele ja mängule / Reaگوچا  
j jūsu judesius ir žaidimą / Hareket  
etme ve oynama şekline tepki verir

All-in-one / All-in-1 / Tout-en-un /  
Todo en uno / Tudo num só set /  
多合一 / Wszystko w jednym /  
Vše v jednom / Všetko v jednom /  
Minden egy készletben / Все в  
одному / Totul în 1 / Всичко в едно /  
Viss vienā / Kõik ühes / Rinkinys  
„viskas viename“ / Hepsí bir arada

© & ™ Lucasfilm Ltd.



**SMART  
PLAY™**  
ALL-IN-ONE



# STAR WARS

75424



75420



75425





75426



Add SMART Brick to play interactive /  
 Mit einem SMART Brick wird das Spiel interaktiv /  
 Ajoutez la SMART brique pour jouer de manière interactive /  
 Aggiungi il Mattoncino SMART per il gioco interattivo / Añade el ladrillo  
 SMART para jugar de forma interactiva / Adicione o SMART Brick para brincadeiras  
 interativas / 添加智能积木, 进行交互式玩乐 / Užij SMART klocka do interaktywnej  
 zabawy / Přidejte kostku SMART Brick pro interaktivní hru / Pridajte kocku SMART Brick pre  
 interaktívnu hru / Játssz interaktívan a SMART kockával! / Додайте SMART кубик для  
 інтерактивної гри / Adaugă cărămida SMART pentru joacă interactivă / Додавете SMART  
 тухличка, за да играете интерактивно / Pievieno SMART klucītī, lai rotaļātos interaktīvi /  
 Interaktiivks mänguks lisa SMART klots / Pridėkite „SMART Brick” kaladėlė ir žaiskite  
 interaktyviai / Interaktif oynamak için SMART Yapım Parçası ekleyin

75422



**SMART  
PLAY™**

**COMPATIBLE**

Compatible / Kompatibel / Compatibile /  
 Compatível / 可兼容 / Kompatybilny /  
 Kompatibilni / Kompatibilné / Kompatibilis /  
 Сумісні / Compatibil / Съвместим /  
 Saderīgs / Ühildub / Dera su / Uyumlu

**ADD SMART BRICK TO  
PLAY INTERACTIVE**



**SMART BRICK  
NOT INCLUDED**

© & ™ Lucasfilm Ltd.

SMART Brick not included / SMART Brick nicht im Lieferumfang enthalten / SMART Brique non incluse / Mattoncino SMART non incluso / SMART-steen niet inbegrepen / Ladrillo SMART  
 no incluido / SMART-kloss medfølger ikke / SMART-kubbur fylgir ekki með / SMART Brick ei sisälly toimitukseen / SMART Brick ingår inte / SMART-kloss er ikke inkludert / SMART Brick  
 não incluido / Δεν περιλαμβάνεται SMART Brick / スマートブロックは含まれていません / 不含智能积木 / SMART 브릭은 포함되어 있지 않습니다 / Nie zawiera SMART klocka /  
 Kostka SMART Brick není součástí balení / Kocka SMART Brick nie je súčasťou balenia / A SMART kocka nem tartozék / SMART кубик не включено / SMART Brick nije dio kompleta /  
 SMART Brick ne e vклучен / Kocka SMART ni vključena / Cărămida SMART nu este inclusă / SMART тухличката не е вклучена / SMART klucītis nav iekļauts / SMART klots ei kuulu  
 komplekti / „SMART Brick” kaladėlė nepridedama / SMART Yapım Parçası dahil değildir / المكعب الذكي غير مضمن





 [LEGO.com/service](https://www.LEGO.com/service)

YOU COULD **WIN**

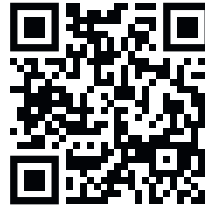

Scan this QR code or go to **LEGO.COM/PRODUCTFEEDBACK** and give us your short feedback about this LEGO® set for a chance to win a cool LEGO prize.

Terms and Conditions apply\*

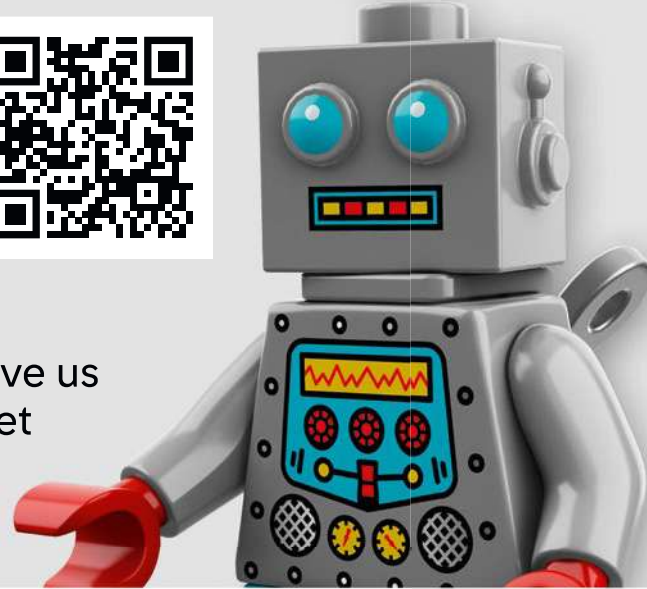

**EN: YOU COULD WIN.** Terms and Conditions apply\* **DE: Du könntest GEWINNEN.** Es gelten die Teilnahmebedingungen\* **FR: Tu pourrais GAGNER.** Des conditions s'appliquent\* **IT: Potresti VINCERE tu.** Termini e condizioni sono applicabili\* **ES: Puedes GANAR.** Aplican términos y condiciones\* **PT: PODERÁ GANHAR.** Aplicam-se Termos e Condições\* **ZH: 轻松获奖.** 条款和条件适用\* **PL: Szansa na WYGRANĄ.** Obowiązuje regulamin\* **CS: Máte šanci VYHRÁT.** Platí všeobecné smluvní podmínky\* **SK: Máte šancu VYHRAŤ.** Platia všeobecné zmluvné podmienky\* **HU: TE IS NYERHETSZ.** Felhasználási feltételek érvényesek\* **UA: ВИ МОЖЕТЕ ВИГРАТИ.** Застосовуються загальні положення та умови\* **RO: Ai putea CÂȘTIGA.** Se aplică termeni și condiții\* **BG: Можете да СПЕЧЕЛИТЕ.** Има определени правила и условия\* **LV: Tu vari LAIMĒT.** Ir spēkā noteikumi un nosacījumi.\* **ET: Sul on võimalus VÕITA.** Kehtivad tingimused\* **LT: Jūs galite LAIMĖTI.** Taikomos sąlygos\*  
\**LEGO.com/productfeedback-terms*

LEGO, the LEGO logo and the SMART PLAY logo are trademarks of the LEGO Group.  
©2026 The LEGO Group.

© & ™ Lucasfilm Ltd.

© © 1977 Warner-Tamerlane Publishing Corp. (BMI)  
All Rights Reserved ALL RIGHTS RESERVED. USED BY PERMISSION.

 6643708